

# CIRCLED: A Multi-turn CIR Dataset with Consistent Dialogues across Domains

Tomohisa Takeda<sup>1</sup>

Yu-Chieh Lin<sup>2</sup>

Yuji Nozawa<sup>2</sup>

Youyang Ng<sup>2</sup>

Osamu Torii<sup>2</sup>

Yusuke Matsui<sup>1</sup>

T\_TAKEDA@HAL.T.U-TOKYO.AC.JP

YUCHIEH.LIN@KIOXIA.COM

YUJI1.NOZAWA@KIOXIA.COM

YOUYANG.NG@KIOXIA.COM

OSAMU.TORII@KIOXIA.COM

MATSUI@HAL.T.U-TOKYO.AC.JP

<sup>1</sup>*Graduate School of Information Science and Technology, The University of Tokyo, Tokyo, Japan*

<sup>2</sup>*Kioxia Corporation, Tokyo, Japan*

## Abstract

Existing Multi-Turn Composed Image Retrieval (MTCIR) datasets lack dialogue-history consistency and are restricted to the fashion domain. To address these limitations, we construct CIRCLED by extending FashionIQ, CIRR, and CIRCO. In CIRCLED, the query at each turn progressively approaches the target image. Data are generated via a CIReVL-based retrieval pipeline and curated with multiple filters on retrieval success, turn length, consistency, and information redundancy to ensure quality. In total, we collect 22,608 multi-turn sessions across nine subsets, substantially exceeding Multi-turn FashionIQ (11,505 sessions) in both scale and generality. We further apply multiple baseline methods and quantitatively assess retrieval accuracy on CIRCLED. Our work provides a practical, high-quality benchmark to facilitate future research on multi-turn CIR. The dataset and code are publicly available at <https://huggingface.co/datasets/tk1441/CIRCLED> and <https://github.com/mti-lab/circled>.

**Keywords:** Composed Image Retrieval, Multi-turn Retrieval, Dataset, Vision-Language Models

## 1 Introduction

Image retrieval aims to find images that match a user’s intent in large corpora. Traditional text-to-image (Lu et al., 2021; Li et al., 2023) and content-based (Liu et al., 2016; Cao et al., 2010) methods search with either a text query or an image, but they struggle when intent is ambiguous or nuanced.

Multimodal retrieval addresses this by combining text and images in a shared embedding space with pretrained vision-language models such as CLIP (Radford et al., 2021) and BLIP (Li et al., 2022). Composed Image Retrieval (CIR) further refines user’s intent by conditioning on a reference image plus a text modification, preserving visual structure while flexibly steering the search (Tian et al., 2023; Zhang et al., 2024; Karthik et al., 2024; Liu et al., 2024).

Nevertheless, most CIR systems use a single-turn setting and give limited consideration to multi-turn usage, i.e., interaction that progressively clarifies the user’s intent. This single-turn setup forces users to state their intent in one shot. It performs poorly when user’s intent is vague or when users refine requirements while inspecting results.

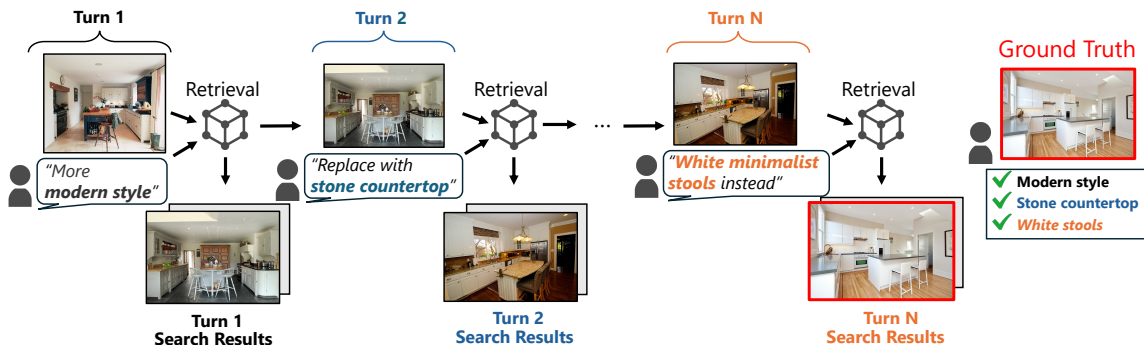

Figure 1: Example of multi-turn CIR search. When users cannot find the image they want, they can search again in the next turn based on the existing search results to find the image they want. The input for each turn is the same as the conventional CIR query, which is an image and text.

Against this background, multi-turn CIR (Yuan and Lam, 2021; Pal et al., 2023; Chen et al., 2025), which follows the flow illustrated in Fig. 1, has recently attracted attention. In multi-turn CIR, retrieval is performed based on the history of  $L$  image-text pairs  $\{(I_1, T_1), \dots, (I_L, T_L)\}$  used in previous turns, thereby more faithfully capturing the user’s evolving intent.

A key issue in existing multi-turn CIR is inconsistent dialogue history. At present, the only publicly available dataset is Multi-turn FashionIQ (Yuan and Lam, 2021). It is built by simply concatenating single-turn queries. As shown in Fig. 2b, it does not provide a structure in which each turn progressively approaches the ground truth (GT). For example, even when the GT is a black dress, the dataset may include unrelated text such as “has a strap” or “has a multi color,” and assign later-turn reference images that are colorful dresses far from the intended black dress. These intermediate-turn mismatches undermine realistic iterative search because later images and captions diverge from the target. Moreover, prior work has focused on fashion, leaving multi-turn CIR in general domains largely unexplored.

We introduce CIRCLED, a multi-turn dataset with consistent, unidirectional progress toward the GT (Fig. 2a). We design the query sequence  $\{(I_1, T_1), \dots, (I_L, T_L)\}$  so each turn steadily approaches the GT, mirroring real search behavior. Each turn  $(I_i, T_i)$  remains aligned with the GT, preserving coherence at both turn and session levels. We construct CIRCLED by extending FashionIQ (Wu et al., 2021), CIRR (Liu et al., 2021), and CIRCO (Baldrati et al., 2023), broadening coverage beyond fashion to general domains. CIRCLED contains 22,608 sessions spanning 2–6 turns and 202,845 images (Table 1), roughly twice that of Multi-turn FashionIQ, and includes 1,078 sessions with 5–6 turns, providing longer interactions.

We conduct several baseline experiments on CIRCLED to analyze its characteristics. Furthermore, we assess performance using three metrics to complement aspects that previous multi-turn CIR settings could not evaluate.

The main contributions of this work are as follows:

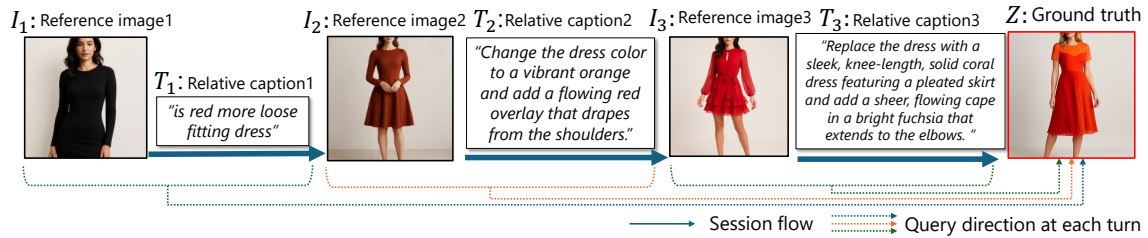

(a) An example from our multi-turn CIR dataset CIRCLED

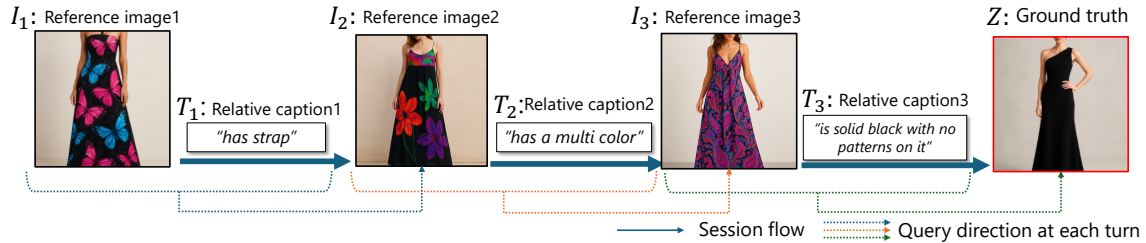

(b) An example from an existing multi-turn CIR dataset

Figure 2: Comparison of multi-turn CIR datasets. Solid arrows indicate the progression of a session; dotted arrows indicate which previous inputs a given turn refers to. (a) In our dataset, the query at each turn consistently points toward the ground truth, yielding a structure that progressively approaches it. (b) In the existing Multi-turn FashionIQ, feedback is primarily oriented toward the next turn’s image and does not necessarily yield a consistent progression toward the ground truth<sup>1</sup>.

- CIRCLED: a multi-turn CIR dataset with consistency and progressive information gain, missing in prior work.
- Broader coverage beyond fashion by extending FashionIQ, CIRR, and CIRCO.
- Three metrics (Hits@10, Final Recall@10, AUC) enabling analysis of turn-wise success and early reachability, as well as final accuracy.

## 2 Related Work

### 2.1 Composed Image Retrieval

Composed Image Retrieval (CIR) (Saito et al., 2023; Zhang et al., 2024; Gu et al., 2024; Liu et al., 2024) retrieves a ground-truth image using a reference image together with a text modification. By integrating visual and textual information, CIR enables flexible retrieval refinement in line with the user’s intent.

Traditional CIR methods train on triplets (reference image, text, GT image), which demands large-scale datasets and costly training (Baldrati et al., 2022; Zhang et al., 2024). To reduce dependence on labeled data, recent works leverage Vision-Language Models (VLMs)

1. For licensing reasons, the images shown in the figure are generated images that are visually similar to images in FashionIQ.

Dataset	#Sessions by Turn Length					Total	#Images	Categories
	2	3	4	5	6			
Multi-turn FashionIQ (Yuan and Lam, 2021)	8,649	2,216	640	–	–	11,505	16,712	Dress, Shirt, Toptee
CIRCLED (Ours)	14,216	5,424	1,890	772	306	22,608	202,845	Dress, Shirt, Toptee, General

Table 1: Comparison of the number of sessions (=queries) by dialogue length  $L$  and covered categories in CIRCLED and Multi-turn FashionIQ.  $L$  denotes the number of turns per session; larger  $L$  generally indicates higher difficulty. CIRCLED covers  $2 \leq L \leq 6$  and includes long sessions with 5–6 turns, whereas Multi-turn FashionIQ is mostly  $L \leq 3$  (maximum  $L = 4$ ) and contains no 5–6 turn sessions. *Total* is the total number of sessions, *#Images* is the number of database images, and *Categories* lists the covered categories.

and Large Language Models (LLMs) for zero-shot CIR (Saito et al., 2023; Baldrati et al., 2023; Karthik et al., 2024). Most existing CIR methods use a single turn with one reference image and one text. Iterative search is simulated by repeatedly issuing single-turn queries. However, an explicit multi-turn framework that references past retrieval history and continuously tracks user intent has received relatively little attention.

## 2.2 Multi-turn Composed Image Retrieval

Multi-turn CIR is the task of retrieving the final target (ground truth) using the history of image-text pairs  $\{(I_1, T_1), \dots, (I_L, T_L)\}$  as the query.

Yuan and Lam (2021) pioneered multi-turn CIR by extending FashionIQ (Wu et al., 2021) and releasing Multi-turn FashionIQ (11,505 sessions, 3 categories), the first dataset for this setting. It is built by concatenating single-turn pairs: each turn  $(I_i, T_i)$  is designed as a query for the next image  $I_{i+1}$ . However, there is no guarantee that intermediate images  $\{I_2, \dots, I_{L-1}\}$  progressively approach the ground truth, making intermediate turn evaluation infeasible. Consequently, existing methods only report final-turn retrieval metrics.

Pal et al. (2023) construct MT Shoes (4,097 sessions, 10 categories) by concatenating single-turn transactions from the Shoes dataset (Pal et al., 2023) and propose a cascaded memory network to retain historical information. Chen et al. (2025) build FashionMT, a significantly larger dataset with 247,911 sessions, 95 categories, and 1,067,688 images, using LLM-based modification generation. FashionMT introduces “retrospective” settings where users may refer back to attributes from previous turns (e.g., “keep the color from turn 2”) or roll back to earlier images. Despite its scale and retrospective design, FashionMT evaluates only the final turn and lacks explicit consistency constraints across turns, as intermediate images are not guaranteed to monotonically improve toward the ground truth. Moreover, both MT Shoes and FashionMT are not publicly available, and all three datasets remain limited to the fashion domain.

In contrast, our CIRCLED dataset ensures monotonic progression toward the ground truth via  $\varepsilon$ -consistency ( $r_{l+1} \leq r_l + \varepsilon$ ; defined in Sec. 3.3), enabling evaluation at any intermediate turn. This allows us to introduce turn-wise metrics (Hits@10, AUC) that measure retrieval quality throughout the entire multi-turn session, not just the final turn. Furthermore, CIRCLED is publicly available and covers both fashion and general domains (CIRR, CIRCO), offering broader applicability.

In a related but distinct setting, Zhao et al. (2024) propose ChatSearch for general conversational image retrieval with free-form multi-modal dialogues. In contrast, our work extends CIR to multi-turn while preserving the structured query format of (reference image, text modification) pairs.

### 3 Proposed Dataset: CIRCLED

We address two limitations of existing multi-turn CIR datasets: the lack of history consistency and the restriction to the fashion domain. Concretely, we extend three single-turn CIR datasets (FashionIQ (Wu et al., 2021), CIRR (Liu et al., 2021), and CIRCO (Baldrati et al., 2023)) to construct a new dataset that features consistent multi-turn dialogues across multiple domains.

Summary statistics are shown in Table 1. Compared to the existing dataset (Yuan and Lam, 2021), CIRCLED is roughly twice as large in the number of queries and about twelve times larger in the number of images, and it adds a General category beyond the three fashion categories. It also includes longer dialogues with 5–6 turns.

#### 3.1 Overview

We describe the components of the dataset. Let  $\mathcal{X} = \{X_n\}_{n=1}^N$  be a database of  $N$  images to be searched. We define a *session* as an  $L$ -turn query sequence  $\{(I_1, T_1), (I_2, T_2), \dots, (I_L, T_L)\}$ , where each  $I_l$  is a reference image and each  $T_l$  is a relative caption describing the desired change. Each session is paired with a ground truth (GT) image  $Z \in \mathcal{X}$ . Given a session, a retrieval algorithm  $S$  must find  $Z$  from  $\mathcal{X}$ . The final performance of  $S$  is computed by averaging results over many sessions. We precompute and release these sessions so that future users can evaluate their multi-turn retrieval algorithms.

We form each session as follows. We choose a GT image  $Z \in \mathcal{X}$  from an existing single-turn CIR dataset. We then construct a multi-turn query sequence  $\{(I_1, T_1), (I_2, T_2), \dots, (I_L, T_L)\}$  that progressively approaches  $Z$ . For Turn 1, we use the dataset’s reference image  $I_1$  and its relative caption  $T_1$ . For later turns, we generate  $T_2, T_3, \dots$  using an LLM and select  $I_2, I_3, \dots$  from the retrieval results; details are given in Sec. 4.

This session simulates a realistic search scenario in which the user refines the query while inspecting intermediate results. Specifically, if the first-turn search with  $(I_1, T_1)$  does not rank  $Z$  sufficiently high, the user selects a desirable image from the current top results as  $I_2$ , and provides an additional description  $T_2$  for  $I_2$ . We rerun retrieval with  $(I_1, T_1), (I_2, T_2)$ , and this process is repeated until  $Z$  appears sufficiently high in the ranking.

#### 3.2 Evaluation Protocol

Algorithm 1 outlines the evaluation pipeline for a single session. Let  $S$  be the retrieval algorithm under evaluation. We evaluate retrieval performance turn by turn. The first-turn search uses  $\{(I_1, T_1)\}$ , and the resulting rank of  $Z$  is denoted  $r_1 \in \{1, \dots, N\}$ :

$$r_1 = S(\{(I_1, T_1)\}). \quad (1)$$

---

**Algorithm 1:** Single-session evaluation protocol. Apply  $S$  to the cumulative history up to turn  $l$  to obtain  $r_l$ . The dataset fixes the query sequence.

---

**Input:** retrieval algorithm  $S$   
**Output:** rank sequence  $r_1, \dots, r_L \in \{1, \dots, N\}$   
**for**  $l \in \{1, \dots, L\}$  **do**  
   $r_l \leftarrow S(\{(I_1, T_1), (I_2, T_2), \dots, (I_l, T_l)\})$   
**return**  $r_1, \dots, r_L$

---

At the second turn, we search using the accumulated information  $\{(I_1, T_1), (I_2, T_2)\}$ , yielding rank  $r_2$ . Repeating this gives, at turn  $l$ ,

$$r_l = S(\{(I_1, T_1), (I_2, T_2), \dots, (I_l, T_l)\}). \quad (2)$$

The objective is to obtain a sufficiently small  $r_l$  with as few turns (small  $l$ ) as possible.

In this protocol, the dataset  $\mathcal{X}$ , each pair  $(I_l, T_l)$ , and the GT  $Z$  are all fixed constants. Importantly, the  $I_l$  are predetermined and independent of the algorithm  $S$ , as in existing multi-turn CIR datasets. If these intermediate choices are poor (e.g., drifting from the GT or repeating information), the reported performance reflects dataset artifacts rather than the quality of  $S$ . We guard against this with a strong baseline and the filtering procedures in Sec. 5.1.

The above describes evaluation for a single session. We then apply this protocol to all sessions, compute the metrics defined in Sec. 6.1 (Hits@10, Recall@10, AUC) from the resulting rank sequences  $\{r_l\}$ , and report the mean over sessions as the final performance.

The protocol in Algorithm 1 generalizes many retrieval problems. When  $L = 1$ , it reduces to single-turn CIR. When  $T_1 = T_2 = \dots = \emptyset$ , it becomes  $L$ -turn relevance feedback in image retrieval. When  $I_1 = I_2 = \dots = \emptyset$ , it corresponds to  $L$ -turn chat-based image retrieval (Levy et al., 2023) Thus, our protocol subsumes several existing settings as special cases, with multi-turn CIR as a particular instantiation.

### 3.3 Dataset Characteristics

To realize natural multi-turn dialogues, we define two properties each session must satisfy:  $\varepsilon$ -consistency and  $\tau$ -diversity. All sessions in CIRCLED satisfy these properties.

**Definition 1 ( $\varepsilon$ -consistency)** *A session is  $\varepsilon$ -consistent w.r.t. a retrieval algorithm  $S$  if its rank sequence  $r_1, r_2, \dots$  satisfies*

$$r_{l+1} \leq r_l + \varepsilon. \quad (3)$$

Here,  $\varepsilon$  is a small integer margin. With  $\varepsilon$ -consistency, we ensure that as turns progress, the GT (within a permitted margin) consistently moves toward higher ranks. If a session violates this property, repeating the query sequence can instead push the target image farther down the ranking.

Our dataset is constructed so that all sessions satisfy  $\varepsilon$ -consistency with respect to the baseline retrieval algorithm described in Sec. 4. By contrast, existing multi-turn CIR datasets do not satisfy this property; in some cases, the GT drifts downward as the dialogue proceeds, making it difficult to reliably evaluate retrieval algorithms.

**Definition 2 ( $\tau$ -diversity)** *A session is  $\tau$ -diverse w.r.t. a text encoder  $E$  if its relative-caption sequence  $T_1, \dots, T_L$  satisfies*

$$\max_{1 \leq j < i \leq L} \cos(E(T_i), E(T_j)) < \tau. \quad (4)$$

Here,  $E$  is a text encoder and  $\cos(\cdot, \cdot)$  denotes cosine similarity. With  $\tau$ -diversity, we ensure that each turn contributes novel information. The threshold  $\tau$  (e.g.,  $\tau = 0.8$ ) controls how much overlap is tolerated. Smaller  $\tau$  requires more novel information at each turn. Without this constraint, the same or similar relative captions may be repeated across turns, adding no new information and preventing meaningful evaluation of multi-turn retrieval.

Each CIRCLED session exhibits a natural and consistent structure with these two properties: the GT rank steadily improves (allowing small fluctuations) as the dialogue progresses, and each turn adds new information. In particular, for sessions with large  $L$ ,  $\tau$ -diversity enforces continuous information addition, while  $\varepsilon$ -consistency ensures stepwise rank improvement, enabling clear visualization of performance differences in history aggregation for long dialogues.

### 3.4 Dataset Bias Analysis

Since the relative captions in CIRCLED are generated by an LLM, we investigate whether they exhibit different linguistic characteristics compared to existing single-turn CIR datasets (FashionIQ, CIRR, CIRCO), which were created by humans. We follow prior caption analysis (Wu et al., 2021).

Table 2 compares linguistic metrics. CIRCLED’s relative captions are longer but maintain comparable vocabulary diversity. Specifically, CIRCLED’s relative captions are significantly longer (average  $|T_i| = 19.0$  words vs. 5.3–11.2 in existing datasets). This difference stems from task design: single-turn CIR describes the overall difference between images at once, whereas multi-turn CIR requires explicit step-by-step modification instructions. For example, single-turn may use concise descriptions like “is darker and longer” (5 words), while multi-turn requires specific instructions such as “Replace the blue shirt with a black shirt featuring a centered graphic design” (12 words). The Type-Token Ratio measures vocabulary diversity as the ratio of unique words to total words (Richards, 1987). This metric is comparable between CIRCLED and existing datasets, suggesting that CIRCLED’s vocabulary diversity remains competitive. The part-of-speech ratios show the proportion of each word class in the captions. FashionIQ exhibits a balanced distribution (Noun/Verb/Adj  $\approx 29/28/28\%$ ), whereas CIRCLED and CIRR/CIRCO are noun-dominant ( $\approx 45/15/20\%$ ).

Fig. 3 shows word clouds of frequent terms (using the default stopword list from the Python WordCloud library). A key difference is that FashionIQ and CIRR/CIRCO frequently use comparative expressions such as “more,” “darker,” and “longer,” while CIRCLED prominently features action verbs like “add,” “replace,” and “change.” This reflects the difference in format: single-turn describes differences between images, whereas multi-turn provides step-by-step modification instructions. Multi-turn FashionIQ exhibits a similar distribution to FashionIQ because it reuses the original FashionIQ captions without modification.



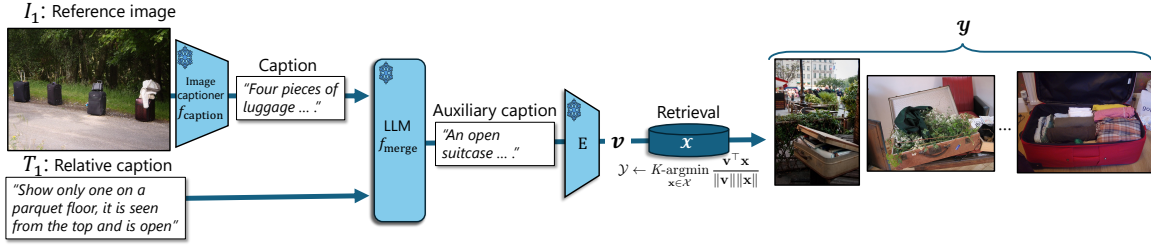

(a) Search in Turn 1

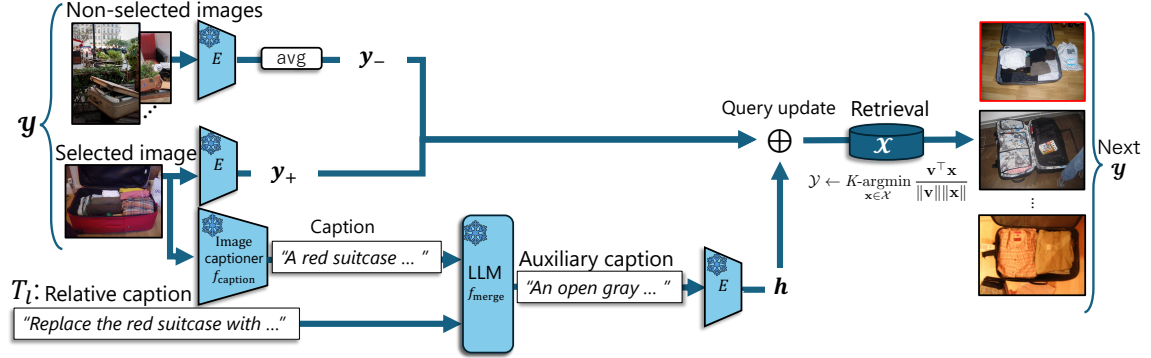

(b) Search in Turn 2 and beyond

Figure 4: Multi-turn image retrieval pipeline. (a) In Turn 1, we merge the caption generated from the reference image with the relative caption using an LLM and form a retrieval query following CIREVL (Karthik et al., 2024). (b) From Turn 2 onward, we update the query by incorporating features of selected and non-selected images as well as textual information, and then perform image retrieval.

#### 4.1 Algorithm Setup

We extend CIREVL (Karthik et al., 2024) to mimic human’s multi-turn image search and to synthesize multi-turn CIR sessions. CIREVL requires no training, is encoder-agnostic, and is independent of specific LLMs/VLMs, allowing flexible use with the latest models. Briefly, CIREVL frames CIR as text-only retrieval: it captions the reference image and uses an LLM to fuse that caption with the relative caption into a single natural-language description, which is then embedded and matched against the image index. In this paper, we implement it as follows:

- Image/text embedding encoder:  $E$  (BLIP (Li et al., 2022))
- Text merging:  $f_{\text{merge}}(\cdot, \cdot)$  (GPT-4o-mini (OpenAI et al., 2024))
- Image-to-caption generation:  $f_{\text{caption}}(\cdot)$  (GPT-4o-mini)
- Difference generator:  $f_{\text{diff}}(\cdot, \cdot, \cdot)$  (GPT-4o-mini)

We further ensure data quality with the filtering procedures described in Sec. 5.1.

## 4.2 Retrieval Pipeline

We start retrieval at Turn 1 and repeat it for up to six turns.

### 4.2.1 TURN 1 ( $l = 1$ ).

As shown in Fig. 4a, Turn 1 follows the standard single-turn CIR setup: given a reference image  $I_1$  and a relative caption  $T_1$ , we generate a query and obtain the top- $K$  candidates  $\mathcal{Y}$ . The steps are:

1. Generate a caption from  $I_1$  using  $f_{\text{caption}}$ .
2. Merge the generated caption with  $T_1$  using  $f_{\text{merge}}$ .
3. Encode the merged sentence with the text encoder  $E$  to obtain a feature vector  $\mathbf{v} \in \mathbb{R}^D$ .
4. Use  $\mathbf{v}$  to retrieve from  $\mathcal{X}$  by cosine similarity and obtain the candidate set  $\mathcal{Y} \subset \mathcal{X}$ .

If the GT  $Z$  is not included in  $\mathcal{Y}$ , we consider the turn unsuccessful and proceed to the next turn. For CIRCO, where multiple GT variants exist, we judge success if at least one of them appears in  $\mathcal{Y}$ .

### 4.2.2 TURN 2 AND BEYOND ( $2 \leq l$ ).

From Turn 2 onward, we use the candidate set  $\mathcal{Y}$  obtained in the previous turn and perform the following steps.

**Selecting an image.** We select from  $\mathcal{Y}$  the image  $y_+$  closest to the GT  $Z$ , excluding images chosen in earlier turns:

$$\text{sim}(Z, y) = \cos(E(f_{\text{caption}}(Z)), E(f_{\text{caption}}(y))) \quad (5)$$

$$y_+ = \underset{y \in \mathcal{Y} \setminus \{I_1, \dots, I_{l-1}\}}{\text{argmax}} \text{sim}(Z, y). \quad (6)$$

Record this  $y_+$  as the reference image  $I_l$  for Turn  $l$ . For CIRCO, we determine similarity using the caption of the ground-truth variant  $Z$  most similar to the current query.

This step emulates user behavior: scanning the ranked list and picking the item closest to the GT. Image-only selection often echoes the current top ranks and stalls progress, so we select with caption-based textual features.

**Generating a relative caption.** Next, we generate the relative caption  $T_l$  from the selected image  $y_+$ , the GT image  $Z$ , and the history of past captions  $H_{l-1} = (T_1, \dots, T_{l-1})$  by prompting a VLM:

$$T_l = f_{\text{diff}}(y_+, Z, H_{l-1}). \quad (7)$$

We instruct the VLM to describe how  $Z$  differs from  $y_+$ , avoid repeating  $H_{l-1}$ , and add new attributes or viewpoints. For CIRCO, when multiple GT variants exist, we pass the variant  $Z$  that is most similar to the current query. This procedure mimics a user who issues iterative, corrective instructions based on the most recently selected image.

**Updating the query.** Finally, update the query using the following three components:

- $\mathbf{y}_+$ : feature of the selected image,
- $\mathbf{y}_-$ : mean feature of the non-selected images ( $\mathcal{Y} \setminus \{y_+\}$ ),
- $\mathbf{h}$ : feature of an auxiliary caption obtained by merging the selected image’s caption with the new relative caption.

$$\mathbf{h} = E(f_{\text{merge}}(T_l, f_{\text{caption}}(y_+))) \quad (8)$$

Update  $\mathbf{v}$  as

$$\mathbf{v} \leftarrow \frac{\mathbf{v} + \alpha\mathbf{y}_+ - \beta\mathbf{y}_- + \gamma\mathbf{h}}{\|\mathbf{v} + \alpha\mathbf{y}_+ - \beta\mathbf{y}_- + \gamma\mathbf{h}\|}. \quad (9)$$

where  $\alpha, \beta, \gamma$  weight the terms. Adding the selected image and auxiliary text while suppressing non-selected images aligns the update with user intent and curbs drift.

### 4.3 Constructing Multi-turn Sessions

By repeating this process for up to six turns, we extend an original single-turn CIR query  $(I_{\text{ref}}, T_{\text{ref}}) \rightarrow Z$  into an interactive sequence  $(I_{\text{ref}}, T_{\text{ref}}) \rightarrow \dots \rightarrow (I_l, T_l) \rightarrow \dots \rightarrow Z$ . Each  $(I_l, T_l)$  is determined by the image-selection and relative-caption generation procedures described above.

## 5 Dataset Construction

Using the baseline  $S_{\text{base}}$  defined in the previous section, we extend existing single-turn CIR datasets and construct high-quality multi-turn dialogues. This section details the filtering procedures and resulting statistics.

### 5.1 Filtering Process

The multi-turn data generated with  $S_{\text{base}}$  may include failures (the target is never retrieved) or redundant relative captions that add no new information. We therefore apply four filters to remove such cases.

**1. Retrieval-success filter.** We remove any query where the GT  $Z$  never appears in the top- $K$  ( $K = 10$ ) candidates  $\mathcal{Y}$  during turns 1–6.

**2. Multi-turn filter.** We exclude queries that already succeed at Turn 1 (i.e., the original single-turn query), keeping only dialogues that require at least two turns.

**3. Rank-margin filter ( $\varepsilon$ -consistency).** We remove any session that has a turn  $l$  with  $r_{l+1} > r_l + \varepsilon$ . We set  $\varepsilon = 30$ . This enforces  $\varepsilon$ -consistency and prevents large drops in the GT rank at intermediate turns.

Subsets	Init	$\Delta$ Succ	$\Delta$ Multi	$\Delta$ Rank	$\Delta$ Text	Final
<b>fdt</b>	10883	5829	1011	86	930	3027
<b>fdv</b>	3722	1468	491	17	386	1360
<b>fst</b>	11300	4656	2067	149	910	3518
<b>fsv</b>	3881	1216	740	54	371	1500
<b>ftt</b>	11544	4705	1698	123	1208	3810
<b>ftv</b>	3732	1011	707	32	476	1506
<b>crt</b>	28225	5847	13328	95	2081	6874
<b>crv</b>	4181	225	2801	4	192	959
<b>cov</b>	220	26	124	2	14	54
<b>Total</b>	<b>77,688</b>	<b>25,183</b>	<b>22,967</b>	<b>562</b>	<b>6,568</b>	<b>22,608</b>

Table 3: Filtering pipeline: per-stage removals (stage-wise decrements) and final counts by subset. Succ: retrieval-success; Multi: multi-turn; Rank: rank-margin; Text: text-redundancy. Subsets: fdt/fdv/fst/fsv/ftt/ftv = FashionIQ Dress/Shirt/Toptee (train/val); crt/crv = CIRR (train/val); cov = CIRCO (val).

Subset	Summary			#Sessions by turn				
	#Sessions (total)	#Images	Avg. turns	2 turns	3 turns	4 turns	5 turns	6 turns
fashioniq_dress_train	3,027	10,886	2.74	1,583	920	323	144	57
fashioniq_dress_val	1,360	3,653	2.73	745	358	163	64	30
fashioniq_shirt_train	3,518	18,500	2.49	2,376	752	251	101	38
fashioniq_shirt_val	1,500	6,182	2.52	990	333	110	48	19
fashioniq_toptee_train	3,810	15,742	2.62	2,253	1,002	359	126	70
fashioniq_toptee_val	1,506	5,261	2.56	934	392	119	45	16
cirr_train	6,874	16,939	2.50	4,581	1,496	513	219	65
cirr_val	959	2,297	2.38	718	166	41	23	11
circo_val	54	123,385	2.61	36	5	11	2	0
<b>Total</b>	<b>22,608</b>	<b>202,845</b>	<b>2.56</b>	<b>14,216</b>	<b>5,424</b>	<b>1,890</b>	<b>772</b>	<b>306</b>

Table 4: Post-filtering statistics: number of sessions, number of images, average turns, and distribution of sessions by turn count for each subset. The Subsets column follows the naming {dataset}-{category (dress, shirt, toptee)}-{split (train or val)}.

**4. Text-redundancy filter ( $\tau$ -diversity).** We remove any session that has a turn  $i$  where  $\max_{1 \leq j < i \leq L} \cos(E(T_i), E(T_j)) \geq \tau$ . We set  $\tau = 0.8$  and use CLIP (Radford et al., 2021) for  $E$ . This enforces  $\tau$ -diversity and prevents caption redundancy across turns.

These four filters ensure both consistency in retrieval accuracy and the incremental addition of information in the relative captions. As summarized in Table 3, four filters (success, multi-turn, rank-margin, and text-redundancy) cut 77,688 queries to 22,608 sessions.

Examples are shown in Fig. 5. Fig. 5a is removed because the GT rank significantly worsens middle dialogue; Fig. 5b is removed because the relative caption repeats earlier content.

In contrast, Fig. 6 shows examples of sessions that passed filtering. These examples demonstrate how retrieval progressively narrows toward the ground truth by combining mul-

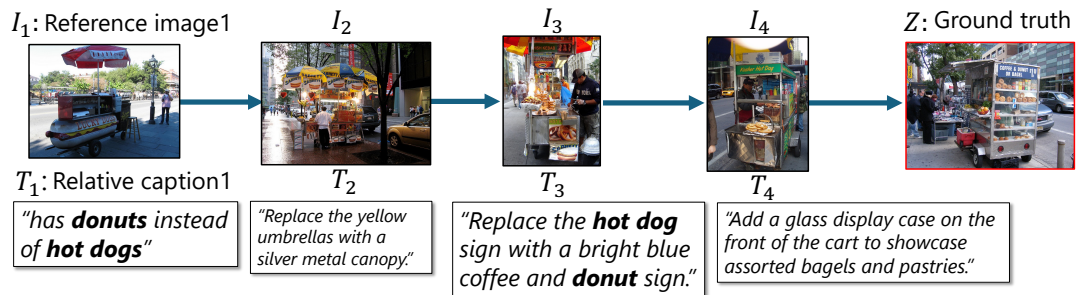
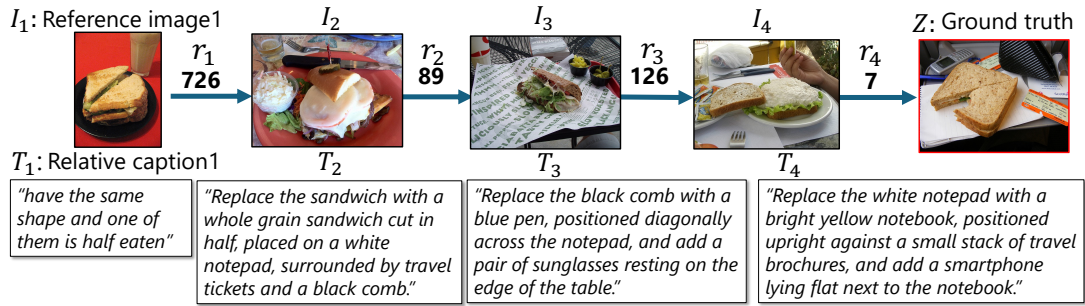

Figure 5: Examples rejected by our filtering. (a) Rank-margin filter ( $\epsilon = 30$ ). (b) Text-redundancy filter ( $\tau = 0.8$ ).

timodal information (image and text) at each turn, in both the general domain (`circo_val`) and the fashion domain (`fashioniq_dress_val`).

## 5.2 Statistics

We summarize the key statistics of the filtered dataset. As shown in Table 4, sessions average 2.56 turns and span 2–6 turns. CIRCLED adds a General category and outscals Multi-turn FashionIQ (Yuan and Lam, 2021) in queries, images, and category coverage (Table 1).

Regarding turn-length distribution (Table 4), approximately 63% of sessions (14,216) have 2 turns, 24% (5,424) have 3 turns, and only about 5% (1,078) have 5–6 turns. This distribution is consistent across domains: the proportion of 5–6 turn sessions is 5.1% for Fashion and 4.1% for General, showing no significant difference.

This short-session distribution results from our quality filters, particularly the text-redundancy filter ( $\tau$ -diversity). As shown in Table 3, the text-redundancy filter removed 6,568 sessions, approximately 12 times more than the 562 sessions removed by the rank-margin filter. That is, most sessions terminate due to  $\tau$ -diversity violations (generating relative captions similar to previous turns) rather than  $\epsilon$ -consistency violations (worsening GT rank). To confirm this, we compared CIRCLED with sessions excluded by the rank-margin and text-redundancy filters (“w/o quality filter” in Table 5; these sessions pass the retrieval-success and multi-turn conditions). As shown in Table 5, the excluded sessions av-

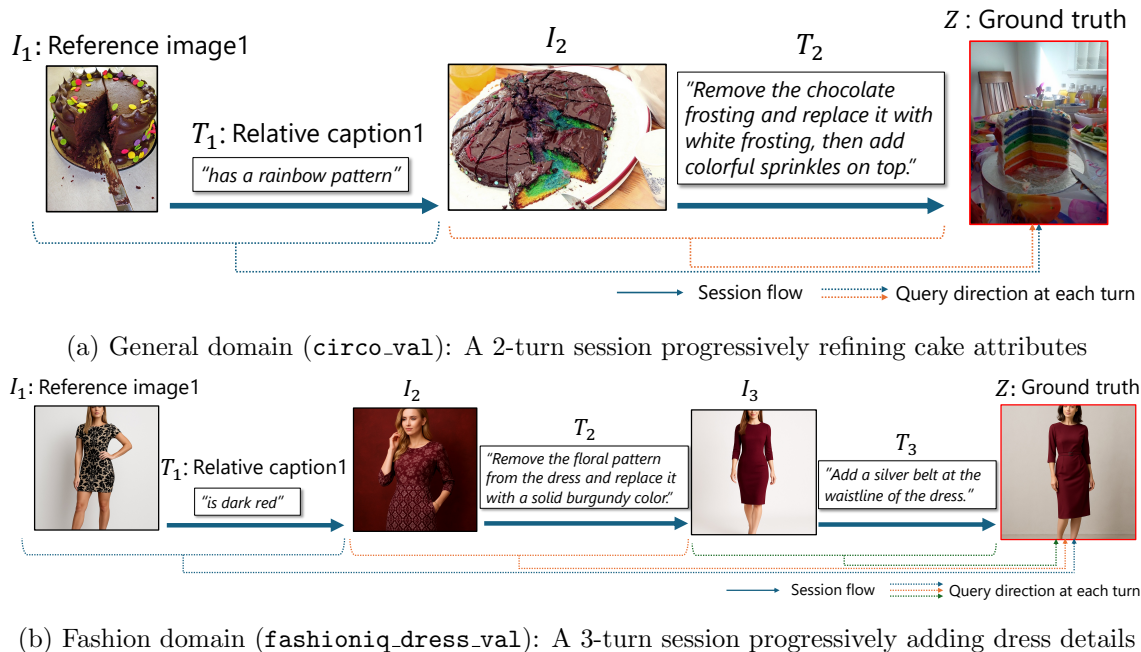

Figure 6: Examples of filtered CIRCLED sessions demonstrating gradual progression toward the ground truth. (a) A 2-turn session in the general domain (`circo_val`). (b) A 3-turn session in the fashion domain (`fashioniq_dress_val`). Each turn combines visual (reference image  $I_l$ ) and textual (relative caption  $T_l$ ) information while satisfying  $\varepsilon$ -consistency and  $\tau$ -diversity<sup>2</sup>.

erage 3.53 turns—about one turn longer than CIRCLED’s 2.54—and contain a much higher proportion of 5–6 turn sessions. As turns progress, fewer new attributes remain to describe differences between the GT and reference images, making redundant relative captions more likely. Allowing longer sessions without filtering would increase turns with little information, degrading dataset quality. Indeed, as detailed in Sec. 5.3, the excluded sessions score lower than CIRCLED on Coherence, Goal Progress, and Redundancy. However, various biases in LLM-based evaluation have been reported, including position bias (sensitivity to presentation order) (Zheng et al., 2023) and self-preference bias (favoring low-perplexity texts) (Wataoka et al., 2025).

### 5.3 Session Quality Evaluation with LLM-as-a-Judge

To evaluate the quality of generated multi-turn dialogues, we conducted session-level evaluation using LLM-as-a-judge. LLM-as-a-judge has been widely studied as an alternative to human evaluation (Gu et al., 2025), and with appropriate design, it has been reported to show high correlation with human evaluation (Zheng et al., 2023; Badshah and Sajjad, 2025; Thakur et al., 2025).

1. For licensing reasons, the images shown in the figure are generated images that are visually similar to images in FashionIQ.

Table 5: Session-level evaluation using LLM-as-a-judge (GPT-5-mini). Each metric is rated 1–5 (higher is better). The prompt is provided in Appendix D. “w/o quality filter” includes sessions excluded by filters 3–4 (rank-margin and text-redundancy) but passing filters 1–2.

Source	$N$	Avg. Turns	Natural.	Coher.	Progress	Redund.	Overall
CIRCLED (Ours)	463	2.54	$3.89 \pm 0.71$	$4.37 \pm 0.72$	$4.56 \pm 0.66$	$4.96 \pm 0.20$	$4.34 \pm 0.60$
w/o quality filter	463	3.53	$4.00 \pm 0.61$	$4.20 \pm 0.74$	$4.28 \pm 0.79$	$4.87 \pm 0.39$	$4.17 \pm 0.63$
Multi-turn FashionIQ	336	2.30	$3.51 \pm 0.72$	$4.15 \pm 0.83$	$4.08 \pm 0.86$	$4.80 \pm 0.53$	$3.98 \pm 0.74$
Simple Concat	449	2.84	$3.38 \pm 0.81$	$3.47 \pm 0.98$	$3.46 \pm 0.99$	$4.67 \pm 0.60$	$3.44 \pm 0.82$

Based on these findings, we adopted the following design: (1) each session was evaluated independently to avoid ordering bias between comparison targets; (2) we used GPT-5-mini as the evaluation model, different from GPT-4o-mini used for dataset generation, to avoid self-preference bias; (3) each session was rated on five dimensions (naturalness, coherence, goal progress, low redundancy, overall) on a 1–5 scale. We sampled approximately 60 sessions per subset from each source where available (1,711 sessions total). Note that Multi-turn FashionIQ covers only Fashion subsets, and some sessions were excluded due to the Azure OpenAI API content filters. We compared: (1) CIRCLED (proposed dataset), (2) w/o quality filter (sessions excluded by filters 3–4), (3) Multi-turn FashionIQ, and (4) Simple Concat (simple concatenation of single-turn datasets).

As shown in Table 5 (higher is better for all metrics), CIRCLED achieved the highest scores on Coherence, Goal Progress, Redundancy, and Overall. The w/o quality filter set scored highest on Naturalness, but this is attributable to differences in turn-count distribution: it has an average of 3.53 turns, and longer sessions tend to receive higher naturalness scores. When comparing sessions with the same number of turns, there was no significant difference in naturalness between CIRCLED and w/o quality filter. Simple Concat scored lowest on all metrics, confirming that simple concatenation of single-turn datasets results in unnatural multi-turn dialogues.

## 6 Experimental Results on CIRCLED

In this section, we quantitatively and qualitatively evaluate retrieval performance on the proposed multi-turn CIR dataset. We analyze how each turn affects accuracy and the relative utility of text and image information.

### 6.1 Evaluation Metrics

For evaluation, let  $\mathcal{Q}$  denote the set of evaluation sessions (queries). We extend  $r_l$  introduced in Eq. (2) to each query  $q \in \mathcal{Q}$ , and denote by  $r_l^{(q)}$  the rank of the GT at turn  $l$ . When multiple ground truth targets exist (as in CIRCO), we take  $r_l^{(q)}$  to be the best rank among them. Let  $L^{(q)}$  be the session length of query  $q$ , and let  $L_{\max} = \max_{q \in \mathcal{Q}} L^{(q)}$  be the maximum length in the dataset. We then define

$$\text{hit}_l^{(q)} = \mathbf{1}(r_l^{(q)} \leq K), \quad K = 10, \quad (10)$$

where  $\mathbf{1}(\cdot)$  denotes the indicator function: it equals 1 if the GT is in the top- $K$  at turn  $l$  and 0 otherwise. We use the following three metrics:

- **Hits@10(turn  $l$ )**

$$\text{Hits@10}(l) = \frac{1}{|\mathcal{Q}|} \sum_{q \in \mathcal{Q}} \max_{1 \leq l' \leq l} \text{hit}_{l'}^{(q)} \quad (11)$$

The fraction of queries that reach the top-10 at least once by turn  $l$ . This captures how quickly a method succeeds. This value is cumulative; for each query, if  $l > L^q$  then  $\text{Hits@10}(l) = \text{Hits@10}(L^q)$ .

- **Final Recall@10**

$$\text{Final Recall@10} = \frac{1}{|\mathcal{Q}|} \sum_{q \in \mathcal{Q}} \text{hit}_{L^q}^{(q)}. \quad (12)$$

Accuracy using all available information at the final turn; used to compare final performance with existing methods.

- **AUC over Hits@10**

$$\text{AUC} = \frac{1}{L_{\max} - 1} \sum_{l=1}^{L_{\max}-1} \frac{\text{Hits@10}(l) + \text{Hits@10}(l+1)}{2}. \quad (13)$$

The trapezoidal integral of the Hits@10 curve. Larger values indicate reaching the top-10 in fewer turns, thus evaluating both final accuracy and convergence speed.

## 6.2 Compared Methods

We aimed to include existing multi-turn CIR methods (Yuan and Lam, 2021; Pal et al., 2023; Chen et al., 2025), but most lack released code or pretrained weights, hindering reproduction. We thus adapt reproducible single-turn methods to the multi-turn setting via feature aggregation strategies, using CLIP (ViT-L/14) for all encoders.

**Baselines:** Text-only (relative caption), Image-only (reference images), Pic2Word (Saito et al., 2023), CIReVL (Karthik et al., 2024) (GPT-4o-mini (OpenAI et al., 2024)), and MagicLens (Zhang et al., 2024).

## 6.3 Feature Aggregation Strategies

Let  $\mathbf{f}_l$  (already normalized) be the feature at turn  $l$ . We aggregate them as follows (exponential decay coefficient  $\alpha = 0.8$  in experiments):

**Latest:**  $\hat{\mathbf{f}} = \mathbf{f}_l$

**Average:**  $\hat{\mathbf{f}} = \frac{1}{l} \sum_{l'=1}^l \mathbf{f}_{l'}$

**Weighted:**  $\hat{\mathbf{f}} = \frac{1}{C} \sum_{l'=1}^l \alpha^{l-l'} \mathbf{f}_{l'}$ ,  $C = \sum_{l'=1}^l \alpha^{l-l'}$

We report results using the best aggregation strategy for each subset and method. We provide a detailed analysis of aggregation strategies in Appendix B.

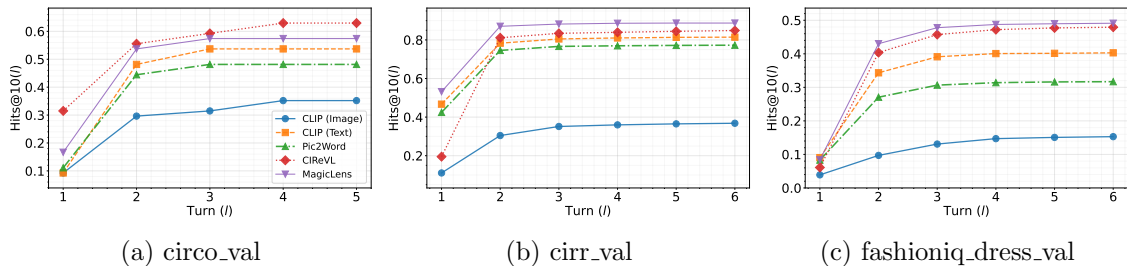

Figure 7: Comparison of Hits@10 by turn across subsets.

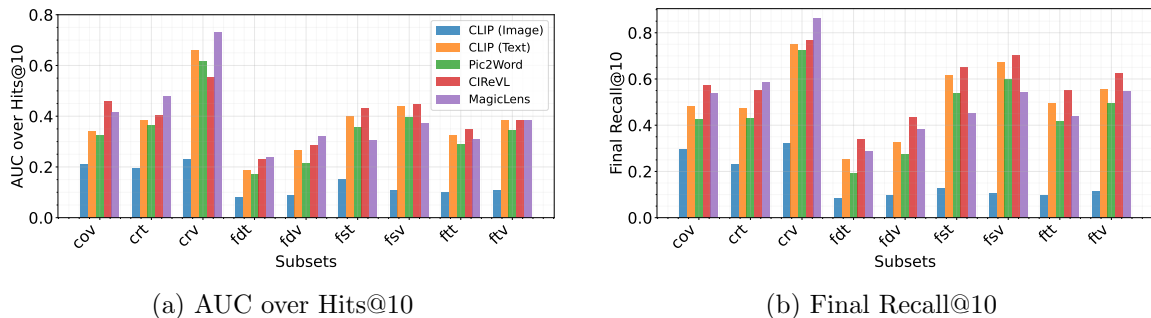

Figure 8: Final Recall@10 and AUC over Hits@10 across baselines, by subset (codes as in Table 3).

## 6.4 Quantitative Results

### TURN-WISE HITS@10 ANALYSIS

Turn-wise Hits@10 results are shown in Fig. 7. On *cirr\_val*, MagicLens exceeds 85% but gains little with more turns. On *circo\_val* and *fashioniq\_dress\_val*, accuracy climbs then plateaus near 60% and 50%. Pic2Word trails Text-only, highlighting the value of text.

### FINAL RECALL@10 AND AUC ANALYSIS

Final Recall@10 and AUC results are shown in Fig. 8. CReVL, Text-only, and MagicLens perform well overall. MagicLens leads on general-domain data, while CReVL is stronger on fashion. On *cirr\_val*, CReVL beats Text-only on Hits@10 from Turn 2 onward. Its weak first turn lowers AUC, showing that AUC reflects performance across turns. Thus, the preferred method depends on the metric and use case, so we report multiple metrics.

Image-only performs notably worse than Text-only across all subsets, confirming that relative captions carry more discriminative information than reference images alone in multi-turn CIR. The domain-specific performance gap may stem from training data: MagicLens was trained on diverse web-crawled image pairs favoring general scenes, whereas CReVL’s text-based approach better captures fine-grained fashion attributes such as color, pattern, and silhouette. Thus, the preferred method depends on the metric and use case, so we report multiple metrics.

## 7 Conclusion

We presented *CIRCLED*, a multi-turn CIR dataset built by extending FashionIQ, CIRR, and CIRCO. It addresses two gaps in prior work: inconsistent dialogue histories and a fashion-only scope. Each turn is designed to steadily approach the ground truth, ensuring coherence at both turn and session levels and enabling study beyond fashion.

We evaluated several baselines and observed clear turn-wise gains; combining visual and textual cues is effective. *CIRCLED* provides a practical dataset and an evaluation framework for future research on multi-turn CIR.<sup>3</sup>

## Broader Impact Statement

This work provides a standardized benchmark for multi-turn composed image retrieval, contributing to the development of interactive visual search systems. Potential applications include conversational product search in e-commerce and AI agents that progressively explore visual information to fulfill user requests. Our dataset uses images from existing public datasets (FashionIQ, CIRR, CIRCO), thereby avoiding privacy concerns associated with new image collection. However, since the relative captions are generated by an LLM (GPT-4o-mini), they may inherit linguistic biases present in the model. To mitigate this risk, we fully disclose the dataset construction process (prompts, filtering criteria, etc.), enabling the research community to verify and address potential biases.

## Acknowledgments and Disclosure of Funding

This work was not supported by any specific grant from funding agencies. The authors declare no competing interests.

## References

- Sher Badshah and Hassan Sajjad. Reference-guided verdict: LLMs-as-judges in automatic evaluation of free-form QA. In *Proceedings of the 9th Widening NLP Workshop*, pages 251–267, 2025.
- Alberto Baldrati, Marco Bertini, Tiberio Uricchio, and Alberto Del Bimbo. Effective conditioned and composed image retrieval combining clip-based features. In *CVPR*, pages 21466–21474, 2022.
- Alberto Baldrati, Lorenzo Agnolucci, Marco Bertini, and Alberto Del Bimbo. Zero-shot composed image retrieval with textual inversion. In *ICCV*, pages 15338–15347, 2023.
- Yang Cao, Changhu Wang, Zhiwei Li, Liqing Zhang, and Lei Zhang. Spatial-bag-of-features. In *CVPR*, pages 3352–3359, 2010.

---

3. The license information for the images used in this paper is provided in Appendix F.

- Yanzhe Chen, Zhiwen Yang, Jinglin Xu, and Yuxin Peng. Mai: A multi-turn aggregation-iteration model for composed image retrieval. <https://openreview.net/forum?id=gXyWb171n1>, 2025. ICLR 2025 submission.
- Timnit Gebru, Jamie Morgenstern, Briana Vecchione, Jennifer Wortman Vaughan, Hanna Wallach, Hal Daumé III, and Kate Crawford. Datasheets for datasets, 2021. URL <https://arxiv.org/abs/1803.09010>.
- Geonmo Gu, Sanghyuk Chun, Wonjae Kim, Yoohoon Kang, and Sangdoon Yun. Language-only training of zero-shot composed image retrieval. In *CVPR*, pages 13225–13234, 2024.
- Jiawei Gu, Xuhui Jiang, Zhichao Shi, Hexiang Tan, Xuehao Zhai, Chengjin Xu, Wei Li, Yinghan Shen, Shengjie Ma, Honghao Liu, Saizhuo Wang, Kun Zhang, Yuanzhuo Wang, Wen Gao, Lionel Ni, and Jian Guo. A survey on llm-as-a-judge, 2025. URL <https://arxiv.org/abs/2411.15594>.
- Shyamgopal Karthik, Karsten Roth, Massimiliano Mancini, and Zeynep Akata. Vision-by-language for training-free compositional image retrieval. *ICLR*, 2024.
- Matan Levy, Rami Ben-Ari, Nir Darshan, and Dani Lischinski. Chatting makes perfect: Chat-based image retrieval. In *NeurIPS*, pages 61437–61449, 2023.
- Junnan Li, Dongxu Li, Caiming Xiong, and Steven Hoi. Blip: Bootstrapping language-image pre-training for unified vision-language understanding and generation. In *ICML*, pages 12888–12900, 2022.
- Junnan Li, Dongxu Li, Silvio Savarese, and Steven Hoi. BLIP-2: bootstrapping language-image pre-training with frozen image encoders and large language models. In *ICML*, pages 19730–19742, 2023.
- Zheyuan Liu, Cristian Rodriguez-Opazo, Damien Teney, and Stephen Gould. Image retrieval on real-life images with pre-trained vision-and-language models. In *ICCV*, pages 2125–2134, 2021.
- Zheyuan Liu, Weixuan Sun, Yicong Hong, Damien Teney, and Stephen Gould. Bi-directional training for composed image retrieval via text prompt learning. In *WACV*, pages 5753–5762, 2024.
- Ziwei Liu, Ping Luo, Shi Qiu, Xiaogang Wang, and Xiaoou Tang. Deepfashion: Powering robust clothes recognition and retrieval with rich annotations. In *CVPR*, pages 1096–1104, 2016.
- Xiaopeng Lu, Tiancheng Zhao, and Kyusong Lee. VisualSparta: An embarrassingly simple approach to large-scale text-to-image search with weighted bag-of-words. In *ACL*, pages 5020–5029, 2021.
- OpenAI et al. Gpt-4 technical report, 2024. URL <https://arxiv.org/abs/2303.08774>.
- A. Pal, S. Wadhwa, A. Jaiswal, X. Zhang, Y. Wu, R. Chada, P. Natarajan, and H. I. Christensen\*. Fashionntm: Multi-turn fashion image retrieval via cascaded memory. In *ICCV*, pages 11323–11334, 2023.

- Alec Radford, Jong Wook Kim, Chris Hallacy, Aditya Ramesh, Gabriel Goh, Sandhini Agarwal, Girish Sastry, Amanda Askell, Pamela Mishkin, Jack Clark, Gretchen Krueger, and Ilya Sutskever. Learning transferable visual models from natural language supervision. In *ICML*, pages 8748–8763, 2021.
- Brian Richards. Type/token ratios: What do they really tell us? *Journal of child language*, 14(2):201–209, 1987.
- Kuniaki Saito, Kihyuk Sohn, Xiang Zhang, Chun-Liang Li, Chen-Yu Lee, Kate Saenko, and Tomas Pfister. Pic2word: Mapping pictures to words for zero-shot composed image retrieval. In *CVPR*, pages 19305–19314, 2023.
- Aman Singh Thakur, Kartik Choudhary, Venkat Srinik Ramayapally, Sankaran Vaidyanathan, and Dieuwke Hupkes. Judging the judges: Evaluating alignment and vulnerabilities in LLMs-as-judges. In *Proceedings of the Fourth Workshop on Generation, Evaluation and Metrics (GEM<sup>2</sup>)*, pages 404–430, 2025.
- Yuxin Tian, Shawn Newsam, and Kofi Boakye. Fashion image retrieval with text feedback by additive attention compositional learning. In *WACV*, pages 1011–1021, 2023.
- Koki Wataoka, Tsubasa Takahashi, and Ryokan Ri. Self-preference bias in llm-as-a-judge, 2025. URL <https://arxiv.org/abs/2410.21819>.
- Hui Wu, Yupeng Gao, Xiaoxiao Guo, Ziad Al-Halah, Steven Rennie, Kristen Grauman, and Rogerio Feris. The fashion iq dataset: Retrieving images by combining side information and relative natural language feedback. In *CVPR*, pages 11307–11317, 2021.
- Yifei Yuan and Wai Lam. Conversational fashion image retrieval via multiturn natural language feedback. In *SIGIR*, pages 839–848, 2021.
- Kai Zhang, Yi Luan, Hexiang Hu, Kenton Lee, Siyuan Qiao, Wenhui Chen, Yu Su, and Ming-Wei Chang. Magiclens: Self-supervised image retrieval with open-ended instructions. In *ICML*, 2024.
- Zhan Zhao, Likun Guo, Tian Yue, Er Hu, Shuang Shao, Zhi Yuan, Jing Liu, et al. Chat-search: a dataset and a generative retrieval model for general conversational image retrieval. <https://openreview.net/forum?id=0unbjYPmbC>, 2024. ICLR 2024 submission.
- Lianmin Zheng, Wei-Lin Chiang, Ying Sheng, Siyuan Zhuang, Zhanghao Wu, Yonghao Zhuang, Zi Lin, Zhuohan Li, Dacheng Li, Eric P. Xing, Hao Zhang, Joseph E. Gonzalez, and Ion Stoica. Judging llm-as-a-judge with mt-bench and chatbot arena. In *NeurIPS*, volume 36, pages 46595–46623, 2023.

## Appendix A. Dataset Documentation

This section provides documentation for the CIRCLED dataset following the recommendations of “Datasheets for Datasets” (Gebru et al., 2021).

### A.1 Access

The dataset and code are publicly available:

- **Dataset:** <https://huggingface.co/datasets/tk1441/CIRCLED>
- **Code:** <https://github.com/mti-lab/circled>

The dataset consists of multi-turn retrieval sessions in JSON format. Each session consists of a sequence of (reference image ID, relative caption) pairs, paired with a ground truth image ID. CIRCLED does not distribute the images themselves; it provides only image IDs and annotations (relative captions and session structures). Users must download the original images from FashionIQ (Wu et al., 2021), CIRR (Liu et al., 2021), and CIRCO (Baldrati et al., 2023) separately, following each dataset’s terms of use.

### A.2 License

The CIRCLED dataset annotations (relative captions and session structures) are released under the CC BY 4.0 license. The underlying images are subject to their original licenses:

- FashionIQ images: Subject to Amazon’s terms of use
- CIRR/CIRCO images: Subject to original Flickr licenses (CC BY, CC BY-NC, etc.)

### A.3 Hosting and Maintenance Plan

The dataset is hosted on Hugging Face Datasets, which provides long-term, reliable hosting with version control. The code repository is maintained on GitHub. We commit to maintaining the dataset for at least five years and will respond to issues and pull requests. Any updates or corrections will be versioned and documented in the repository.

### A.4 Author Responsibility Statement

The authors confirm that:

- We bear all responsibility in case of violation of rights.
- The dataset annotations do not contain personally identifiable information.
- The relative captions were generated using GPT-4o-mini and reviewed through automated filtering to ensure quality and appropriateness.

## Appendix B. Effect of History Integration Methods

We evaluate three ways of aggregating single-turn CIR features into a multi-turn method (Latest, Average, and Weighted) and report the results in terms of Final Recall@10. As shown in Fig. 9, on the dataset extended from fashioniq\_dress\_val, the Weighted mode (which places larger weights on later turns) achieves the highest performance. This aligns with the design of our dataset, where the query progressively approaches the target image in later turns, making that information particularly valuable.

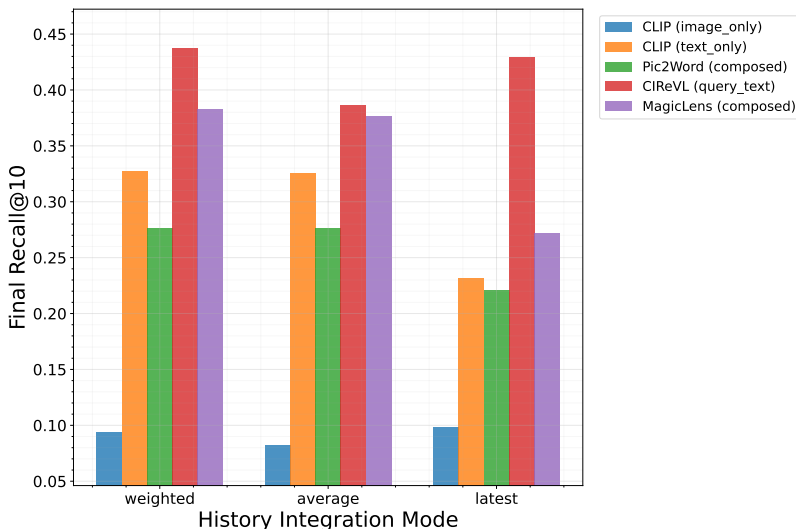

Figure 9: Example results for history-integration strategies. On the dataset extended from fashioniq\_dress\_val, we compare how different aggregation schemes affect each baseline’s performance at each turn.

Moreover, Weighted outperforms Latest (which uses only the final turn), indicating that leveraging the entire history yields more accurate retrieval than relying solely on the last turn. An exception arises for image-only features, where Latest is slightly better, suggesting that the most recently selected reference image carries the most salient visual signal in that setting.

## Appendix C. Prompts

We list the prompts used in this work. All prompts are fed into GPT-4o-mini.

### C.1 Caption Generation

The prompts for generating image captions vary by dataset domain.

#### FashionIQ Dress:

```
Describe this dress in 1-2 sentences. Focus on color, style, length,
and key design features.
```

#### FashionIQ Shirt:

```
Describe this shirt in 1-2 sentences. Focus on color, style, collar,
sleeves, and key design features.
```

#### FashionIQ Toptee:

```
Describe this top in 1-2 sentences. Focus on color, style, neckline,
sleeves, and key design features.
```

#### CIRR:

Describe this image in 1-2 sentences. Include main objects, people, setting, and notable features.

**CIRCO:**

Describe this image in 1-2 sentences. Include main objects, composition, and notable features.

**C.2 Relative Caption Generation**

The prompt for generating relative captions includes history of previous suggestions to ensure diversity. The retry mechanism is activated when the generated caption is too similar to existing ones.

```

IMPORTANT -- Previous changes have already been suggested:
- "{relative caption1}"
- "{relative caption2}"
...
Your task is to identify a COMPLETELY DIFFERENT visual change.
Focus on aspects that have NOT been mentioned before.

[Only if retrying]
RETRY #{n}: The previous suggestion was too similar to existing ones
.
Please provide a MORE DISTINCTIVE and DIFFERENT instruction.
Consider completely different visual aspects like:
- Different objects or people
- Different colors or lighting
- Different actions or poses
- Different background elements
- Different clothing or accessories

You will see two images.
**Image 1** : This is the REFERENCE image that needs to be modified.
**Image 2** : This is the TARGET image showing the desired result.

Write exactly ONE imperative instruction to transform Image 1 into
Image 2.
Requirements:
1. Start with a verb
2. Be extremely specific about colors, positions, or actions
3. Avoid relative terms like "left" or "right"
4. Do not use quotes or explanatory text
5. Focus on a single, clear change
6. Must be different from previous suggestions

```

**C.3 Auxiliary Caption Generation**

The prompt for merging the reference image caption with the relative caption to create an auxiliary caption for retrieval.

A user is performing image retrieval. The user provides a reference image caption and a modification for the retrieved image to refine the search. Generate a new query reflecting this modification. Only return the refined query.

Reference image caption: {reference\_image\_caption}  
 Modification: {relative\_text}

## Appendix D. LLM-as-a-Judge Prompt for Session Evaluation

We use GPT-5-mini as an LLM-based judge to evaluate multi-turn retrieval sessions. The system prompt is shown below.

You are an expert annotator for multi-turn image retrieval dialogs.

You will see a complete retrieval session:

- A sequence of (CURRENT image, USER UTTERANCE) pairs showing the dialog progression
- A TARGET image (the final goal Z)

Your job is to evaluate the ENTIRE SESSION as a coherent dialog for image retrieval.

Rate the session on these 5 dimensions, each from 1 (very bad) to 5 (excellent):

1. SESSION NATURALNESS: Are the utterances consistently human-like throughout the session?
2. COHERENCE / CONSISTENCY: Is there logical flow without contradictions or abrupt changes?
3. GOAL-DIRECTED PROGRESS: Does each turn move closer to the target image Z?
4. REDUNDANCY (higher = better): Is there low repetition of information?
5. OVERALL: Holistic quality of the entire session

## Appendix E. Image Generation for FashionIQ Data

For licensing reasons, in this paper we use generated images in the figures about FashionIQ dataset. The images are generated by GPT-4o image generation function, using text prompts that describe the images in FashionIQ dataset.

## Appendix F. Image Licenses

The licenses of the images used in this paper are summarized in Tables 6 and 7.

CIRCLED: MULTI-TURN CIR DATASET

Figure	Images	Image ID
Fig. 1	Turn1 reference image, search result	000000190235, 000000037054
Fig. 1	Turn2 reference image, search result	000000037054, 000000537111
Fig. 1	TurnN reference image, search result	000000537111, 000000138205
Fig. 1	Ground truth	000000138205
Fig. 2 (a)	Reference image 1, 2, 3, ground truth	B004EHON6W, B004XJI4I4, B008D5AYOG, B0093K54X6
Fig. 2 (b)	Reference image 1, 2, 3, ground truth	B007XLHLHE, B008I5Q3CS, B007IXDC7U, B007IXDESW
Fig. 4 (a)	Reference image, search results (from left)	000000112439, 000000518636, 000000324422, 000000264963
Fig. 4 (b)	Non-selected images (from top), selected image	000000518636, 000000324422, 000000264963
Fig. 4 (b)	Search results (from top)	000000460329, 000000346912, 000000247950, 000000264963
Fig. 5 (a)	Reference image 1, 2, 3, 4, ground truth	000000253571, 000000219002, 000000448025, 000000332048, 000000166818
Fig. 5 (b)	Reference image 1, 2, 3, 4, ground truth	000000447096, 000000271037, 000000230153, 000000195608, 000000478514
Fig. 6 (a)	Reference image 1, 2, ground truth	000000179795, 000000318881, 000000148864
Fig. 6 (b)	Reference image 1, 2, 3, ground truth	B008ZB39FY, B00CBBV3ZC, B0091S4Q9S, B008HQYFB4

Table 6: List of Image IDs used in Figures

Table 7: Image ID, URLs, and Licenses. If an image is noted “generated image” in its License column, it is generated by gpt-4o image generation function, using a text prompt that describes the image on the URL noted in its Image URL column.

Image ID	Image URL	License
000000190235	<a href="http://farm7.staticflickr.com/6171/6207331658_b318513022_z.jpg">http://farm7.staticflickr.com/6171/6207331658_b318513022_z.jpg</a>	CC BY 2.0
000000037054	<a href="http://farm7.staticflickr.com/6007/6198289264_029a6e88e2_z.jpg">http://farm7.staticflickr.com/6007/6198289264_029a6e88e2_z.jpg</a>	CC BY 2.0
000000537111	<a href="http://farm9.staticflickr.com/8064/8211635300_deba3583bf_z.jpg">http://farm9.staticflickr.com/8064/8211635300_deba3583bf_z.jpg</a>	CC BY 2.0
000000138205	<a href="http://farm9.staticflickr.com/8175/8071171348_de3c9af840_z.jpg">http://farm9.staticflickr.com/8175/8071171348_de3c9af840_z.jpg</a>	CC BY-NC-SA 2.0
000000112439	<a href="http://farm2.staticflickr.com/1137/962695681_0be4bcd0f8_z.jpg">http://farm2.staticflickr.com/1137/962695681_0be4bcd0f8_z.jpg</a>	CC BY-NC-SA 2.0
000000518636	<a href="http://farm4.staticflickr.com/3460/4018979209_8dc1cf8ffd_z.jpg">http://farm4.staticflickr.com/3460/4018979209_8dc1cf8ffd_z.jpg</a>	CC BY-NC-SA 2.0
000000324422	<a href="http://farm4.staticflickr.com/3244/2655366225_5b0754fb6e_z.jpg">http://farm4.staticflickr.com/3244/2655366225_5b0754fb6e_z.jpg</a>	CC BY-NC-ND 2.0
000000264963	<a href="http://farm3.staticflickr.com/2334/2383999861_75d27c265e_z.jpg">http://farm3.staticflickr.com/2334/2383999861_75d27c265e_z.jpg</a>	CC BY-NC-SA 2.0
000000460329	<a href="http://farm4.staticflickr.com/3182/3025936416_f1e5421a1b_z.jpg">http://farm4.staticflickr.com/3182/3025936416_f1e5421a1b_z.jpg</a>	CC BY-NC-SA 2.0
000000346912	<a href="http://farm4.staticflickr.com/3323/3513955326_d9801f2b83_z.jpg">http://farm4.staticflickr.com/3323/3513955326_d9801f2b83_z.jpg</a>	CC BY 2.0
000000247950	<a href="http://farm5.staticflickr.com/4136/4743534549_c7a3612428_z.jpg">http://farm5.staticflickr.com/4136/4743534549_c7a3612428_z.jpg</a>	CC BY-NC-SA 2.0
B004EHON6W	<a href="http://ecx.images-amazon.com/images/I/41DXkZHT0JL_SX342.jpg">http://ecx.images-amazon.com/images/I/41DXkZHT0JL_SX342.jpg</a>	generated image
B0093K54X6	<a href="http://ecx.images-amazon.com/images/I/31r71PVOUEL_SX342.jpg">http://ecx.images-amazon.com/images/I/31r71PVOUEL_SX342.jpg</a>	generated image
B004XJI4I4	<a href="http://ecx.images-amazon.com/images/I/31VgYvG6qbl_SX342.jpg">http://ecx.images-amazon.com/images/I/31VgYvG6qbl_SX342.jpg</a>	generated image
B008D5AYOG	<a href="http://ecx.images-amazon.com/images/I/416dhASM95L_SX342.jpg">http://ecx.images-amazon.com/images/I/416dhASM95L_SX342.jpg</a>	generated image
B007XLHLHE	<a href="http://ecx.images-amazon.com/images/I/41LqCUsGHXL_SY445.jpg">http://ecx.images-amazon.com/images/I/41LqCUsGHXL_SY445.jpg</a>	generated image
B008I5Q3CS	<a href="http://ecx.images-amazon.com/images/I/41rprim9AFL_SX342.jpg">http://ecx.images-amazon.com/images/I/41rprim9AFL_SX342.jpg</a>	generated image
B007IXDC7U	<a href="http://ecx.images-amazon.com/images/I/41UxaR--QLL_SY445.jpg">http://ecx.images-amazon.com/images/I/41UxaR--QLL_SY445.jpg</a>	generated image
B007IXDESW	<a href="http://ecx.images-amazon.com/images/I/31BrgjaaIZL_SY445.jpg">http://ecx.images-amazon.com/images/I/31BrgjaaIZL_SY445.jpg</a>	generated image
000000253571	<a href="http://farm1.staticflickr.com/228/471397100_afd0fe517a_z.jpg">http://farm1.staticflickr.com/228/471397100_afd0fe517a_z.jpg</a>	CC BY-NC 2.0
000000219002	<a href="http://farm7.staticflickr.com/6038/6215343038_6bae3b45cb_z.jpg">http://farm7.staticflickr.com/6038/6215343038_6bae3b45cb_z.jpg</a>	CC BY-NC-SA 2.0
000000448025	<a href="http://farm2.staticflickr.com/1019/1035634033_503438c7ea_z.jpg">http://farm2.staticflickr.com/1019/1035634033_503438c7ea_z.jpg</a>	CC BY-NC-ND 2.0
000000332048	<a href="http://farm3.staticflickr.com/2320/2073978153_7d320747e4_z.jpg">http://farm3.staticflickr.com/2320/2073978153_7d320747e4_z.jpg</a>	CC BY-NC 2.0
000000166818	<a href="http://farm3.staticflickr.com/2054/2247395963_7cb97cbf8d_z.jpg">http://farm3.staticflickr.com/2054/2247395963_7cb97cbf8d_z.jpg</a>	CC BY-NC-SA 2.0
000000447096	<a href="http://farm6.staticflickr.com/5001/5255997294_7df1664c69_z.jpg">http://farm6.staticflickr.com/5001/5255997294_7df1664c69_z.jpg</a>	CC BY-NC-SA 2.0
000000271037	<a href="http://farm1.staticflickr.com/62/195329469_b95cf37cc0_z.jpg">http://farm1.staticflickr.com/62/195329469_b95cf37cc0_z.jpg</a>	CC BY 2.0
000000230153	<a href="http://farm3.staticflickr.com/2405/2005336437_2e7b5da6db_z.jpg">http://farm3.staticflickr.com/2405/2005336437_2e7b5da6db_z.jpg</a>	CC BY-NC-SA 2.0
000000195608	<a href="http://farm9.staticflickr.com/8302/7782408182_25d279cd27_z.jpg">http://farm9.staticflickr.com/8302/7782408182_25d279cd27_z.jpg</a>	CC BY 2.0
000000478514	<a href="http://farm8.staticflickr.com/7252/7782273360_221f840574_z.jpg">http://farm8.staticflickr.com/7252/7782273360_221f840574_z.jpg</a>	CC BY 2.0
000000179795	<a href="http://farm3.staticflickr.com/2737/4114913419_2736255889_z.jpg">http://farm3.staticflickr.com/2737/4114913419_2736255889_z.jpg</a>	CC BY-NC-SA 2.0
000000148864	<a href="http://farm8.staticflickr.com/7080/7404128930_7b4c76a4e2_z.jpg">http://farm8.staticflickr.com/7080/7404128930_7b4c76a4e2_z.jpg</a>	CC BY-NC 2.0
000000318881	<a href="http://farm6.staticflickr.com/5528/10038641393_8f1ce796d0_z.jpg">http://farm6.staticflickr.com/5528/10038641393_8f1ce796d0_z.jpg</a>	CC BY-NC-ND 2.0
B008ZB39FY	<a href="http://ecx.images-amazon.com/images/I/41YqRey8zgL_SX342_.jpg">http://ecx.images-amazon.com/images/I/41YqRey8zgL_SX342_.jpg</a>	generated image
B008HQYFB4	<a href="http://ecx.images-amazon.com/images/I/31b%2BheNk5nL_SX342_.jpg">http://ecx.images-amazon.com/images/I/31b%2BheNk5nL_SX342_.jpg</a>	generated image
B00CBBV3ZC	<a href="http://g-ecx.images-amazon.com/images/G/01/x-locale/brands/lifestyle-assets/5370858011_CB335605943_SR150_160_.jpg">http://g-ecx.images-amazon.com/images/G/01/x-locale/brands/lifestyle-assets/5370858011_CB335605943_SR150_160_.jpg</a>	generated image
B0091S4Q9S	<a href="http://ecx.images-amazon.com/images/I/31kZNo52IkL_SX342_.jpg">http://ecx.images-amazon.com/images/I/31kZNo52IkL_SX342_.jpg</a>	generated image