

CODA: Rewriting Transformer Blocks as GEMM-Epilogue Programs

Han Guo^{1*} Jack Zhang² Arjun Menon²

Driss Guessous⁴ Vijay Thakkar⁴ Yoon Kim¹ Tri Dao^{2,3}

¹Massachusetts Institute of Technology ²Princeton University ³Together AI ⁴Meta
hanguo@mit.edu

Abstract

Transformer training systems are built around dense linear algebra, yet a nontrivial fraction of end-to-end time is spent on surrounding memory-bound operators. Normalization, activations, residual updates, reductions, and related computations repeatedly move large intermediate tensors through global memory while performing little arithmetic, making data movement an increasingly important bottleneck in otherwise highly optimized training stacks. We introduce CODA, a GPU kernel abstraction that expresses these computations as GEMM-plus-epilogue programs. CODA is based on the observation that many Transformer operators exposed as separate framework kernels can be algebraically reparameterized to execute while a GEMM output tile remains on chip, before it is written to memory. The abstraction fixes the GEMM mainloop and exposes a small set of composable epilogue primitives for scaling, reductions, pairwise transformations, and accumulation. This constrained interface preserves the performance structure of expert-written GEMMs while remaining expressive enough to cover nearly all non-attention computation in the forward and backward pass of a standard Transformer block. Across representative Transformer workloads, both human- and LLM-authored CODA kernels achieve high performance, suggesting that GEMM-plus-epilogue programming offers a practical path toward combining framework-level productivity with hardware-level efficiency.²

1 Introduction

LLM training has become just as much of a systems problem as a modeling one. FLOPs in modern Transformer-based LLMs are dominated by matrix multiplications and attention, whose kernels have been heavily optimized for Tensor Core execution. Yet Transformers, and deep learning architectures more broadly, also contain normalization, activations, residual updates, reductions, and other bandwidth-limited operations that move large tensors through memory while doing little arithmetic. Prior work has shown that data movement is a central bottleneck in Transformer training [7]; as Figure 1 shows, when training a LLaMA-3-style 1B model on a single H100 using TorchTitan [11], these non-GEMM operations account for a nontrivial fraction

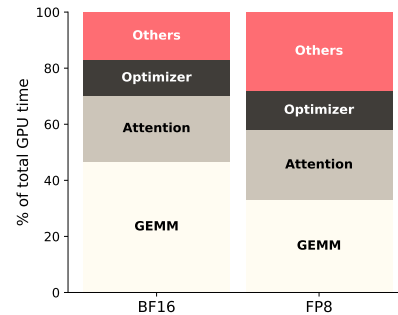

Figure 1: Runtime breakdown for LLaMA-3-style 1B model training on a single H100 using TorchTitan.

*Part of this work was done at Together AI.

²Code available at <https://github.com/HanGuo97/coda-kernels>.

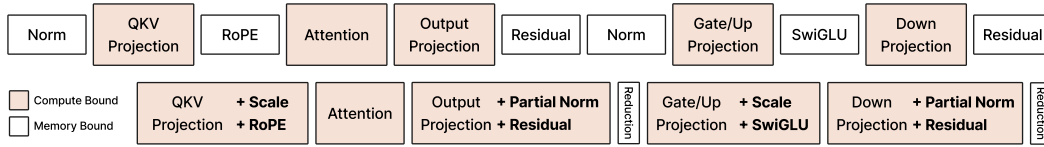

Figure 2: Forward pass of a standard Transformer layer. The top row shows the canonical formulation, which maps to a mix of compute- and memory-bound kernels. We reparameterize the computation so that most memory-bound operations are subsumed into the epilogues of compute-bound kernels.

of end-to-end runtime. As hardware increasingly accelerates low-precision matrix multiplication through formats such as FP8 and FP4, this bottleneck is becoming more important, as the cost of materializing intermediate tensors does not improve at the same rate.

Existing programming models make this issue difficult to address. High-level frameworks such as PyTorch express Transformer blocks as operator sequences, with autograd making the backward pass similarly convenient. This is productive, but operator boundaries often become materialization boundaries and obscure fusion opportunities across forward and backward computation. Production-level LLM systems therefore often bypass framework abstractions with hand-written backward passes or custom kernels, as in large-scale LLaMA training [5] and inference systems [9, 25]. This work asks whether there is a middle ground. That is, is it possible to recover much of the performance of custom kernels without giving up the structure needed for programmability and automation?

Our starting observation is that many Transformer computations that appear at the framework level as separate operators can be algebraically reparameterized as GEMM-plus-epilogue programs (Figure 2). In this form, a highly optimized GEMM mainloop produces output tiles, while a programmable epilogue performs tile-local transformations before the result is written to memory (Figure 3). This is efficient on GPUs because the epilogue operates on data that is already produced by the GEMM tile, avoiding additional global-memory round trips for intermediate tensors. With modern pipelined schedules, this epilogue work can often be placed in the shadow of other tiles’ mainloops, as in Hopper Ping-Pong GEMM and Blackwell TMEM-based pipelines. Thus, we extend the epilogue beyond a place for simple post-processing such as scaling or bias addition, elevating it into a structured interface for fusing memory-bound computation into the lifetime of a GEMM tile.

Based on the above, we introduce CODA, a kernel abstraction prototype that realizes this interface. CODA keeps the GEMM mainloop fixed and exposes a small set of composable epilogue primitives for scaling, reductions, pairwise transformations, and accumulation. This programming model is deliberately constrained and yet expressive, as after reparameterization, these primitives cover nearly the entire forward and backward pass of a standard Transformer model while preserving efficiency. CODA inserts computation into the epilogue of a known high-performance GEMM before intermediate tensors are materialized in global memory, capturing a broad class of memory-bound computations surrounding dense linear algebra. Transformers are our primary application, but the same GEMM-plus-epilogue view applies more broadly whenever high-throughput matrix multiplication is surrounded by tile-expressible, data-movement-bound computations.

Finally, this structure makes automation more practical. Epilogue fusion is already established in high-performance GEMM libraries, but applying it to Transformer workloads remains a low-level engineering task. CODA targets this gap by providing Transformer-specific epilogue primitives on top of a tuned GEMM mainloop. Human or LLM-based authors can assemble these primitives into reparameterized Transformer kernels rather than synthesizing arbitrary CUDA. Across representative workloads, both authoring modes achieve high performance, suggesting that domain-specific epilogue abstractions can make established GEMM fusion techniques more programmable for LLM kernels.

2 Background and Related Works

2.1 Programming Models for LLM Systems

Modern LLM systems are programmed at multiple abstraction levels. Frameworks such as PyTorch and JAX express models as tensor-operator graphs and integrate naturally with automatic differentiation, but operator boundaries often become materialization ones.

Compiler systems lower tensor programs to optimized kernels through graph rewriting, scheduling, code generation, and autotuning [1, 2, 19]. Algebraic reformulation is another important source of

performance, as shown by TASO [8] and Mirage [22]. However, rapidly evolving accelerators make peak performance a moving target for general-purpose compilers.

Closer to the hardware level, programmers use kernel DSLs and libraries such as Triton [19], ThunderKittens [14, 13, 17], TileLang [20], CuTeDSL [18], Gluon, and TLX, or rely on specialized LLM kernels in vLLM [9], SGLang [25], FlashInfer [23], and Liger Kernels [6]. These approaches deliver high performance, but extending them to new transformations or backward computations still requires substantial low-level engineering.

2.2 GEMM Mainloops and Epilogue Fusion

Matrix multiplication is the central compute primitive in modern LLM workloads. A high-performance GEMM kernel is typically divided into a mainloop and an epilogue. The mainloop performs the tiled matrix multiply-accumulate computation, while the epilogue transforms the computed output tile and efficiently writes it back to global memory.

The epilogue is a natural place to implement fusions because the output of the matmul is already present on chip close to compute cores. Practical epilogues commonly perform scaling, bias addition, activations, residual updates, data type conversions, tile-wise reductions and other output elementwise operations, avoiding separate kernel launches and extra global-memory round trips. Modern kernel libraries formalize this separation directly: CUTLASS [18] represents GEMM kernels as a composition of a collective mainloop and a collective epilogue, while Epilogue Visitor Trees further express epilogues as compositions of primitives [4].

This flexibility operates under a locality constraint. An epilogue sees only the local output tile, its accumulators, and consistently indexed auxiliary tensors, meaning that operations requiring global reductions or cross-tile communication must be reformulated into tile-local pieces or handled in a separate pass. CODA builds on this interface, keeping the high-performance GEMM mainloop fixed and using the epilogue as a programmable site for nearby memory-bound computation.

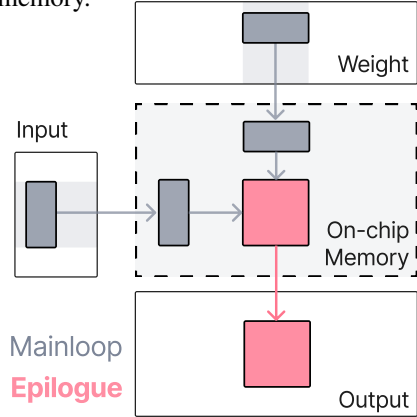

Figure 3: A GEMM mainloop computes output tiles; the epilogue transforms each tile before the final global-memory store.

3 CODA

The previous section argued that GEMM epilogues are a natural place to fuse memory-bound computation into dense linear algebra. We now describe CODA, a GPU kernel abstraction that realizes this idea. Section 3.1 identifies a small set of epilogue primitives that map efficiently to GPU execution. Section 3.2 shows how the non-attention and non-embedding portions of the Transformer forward and backward pass can be reparameterized using these primitives. Finally, Section 3.3 describes their implementation and our LLM-oriented authoring workflow.

3.1 Efficient Epilogue Primitives

CODA programs the GEMM epilogue while keeping the mainloop fixed and highly optimized. For each output tile, an epilogue may load auxiliary data, transform accumulator values, emit auxiliary results, and store the final output. This interface is deliberately restricted to tile-local computation rather than arbitrary global communication. Our epilogue template, shown in Section B.1, is inspired by Epilogue Visitor Trees [4]. CODA provides five classes of epilogue primitives:

1. *Elementwise and pairwise maps*: apply local transformations to accumulator values, including residual updates, activations, RoPE-style rotations, and SwiGLU-style gates.
2. *Vector (Rank-1 Tensor) loads and stores*: load row or column vectors, broadcast them over an output tile, and optionally write vector-valued auxiliary results.

3. *Tile (Rank-2 Tensor) loads and stores*: load or store matrix tiles, such as residual streams, saved activations, or intermediate values needed by the backward pass.
4. *Tile (Rank-2 Tensor) reductions*: compute partial reductions over rows or columns of an output tile, to be combined later by a lightweight auxiliary kernel.
5. *Stateful transforms*: maintain running tile state, such as the max and sum-exp statistics used in online log-sum-exp and cross-entropy.

These primitives are intentionally narrow, operating at a level low enough to compile to efficient epilogue code and expressive enough to capture the memory-bound operations surrounding GEMMs in our Transformer reparameterizations, as shown next.

3.2 Reparameterizing Transformers as Epilogues

We now show that the primitive set above is sufficient for much of Transformer computation. After lightweight algebraic reparameterization, many non-attention and non-embedding components of a standard Transformer forward pass can be written as

$$\text{GEMM: } \mathbf{h} = \mathbf{x}\mathbf{W}, \quad \text{Epilogue: } \mathbf{y}[i, j] = \mathbf{f}[i, j](\mathbf{h}[i, j]),$$

where $[i, j]$ indexes an output tile and $\mathbf{f}[i, j]$ is the tile function implemented in the GEMM epilogue. The epilogue is either fully tile-local, or tile-local up to partial results that are combined by a lightweight auxiliary reduction. We first apply this view to the forward pass, then show that independent tile functions preserve the same GEMM-epilogue structure in the backward pass.

3.2.1 GEMM-Residual-RMSNorm-GEMM Pattern

A recurring pattern in pre-normalized Transformers is a GEMM followed by a residual update and normalization, then another GEMM. This pattern appears across several adjacent sublayers:

1. attention output projection \rightarrow residual stream \rightarrow RMSNorm \rightarrow MLP gate/up projection;
2. MLP down projection \rightarrow residual stream \rightarrow RMSNorm \rightarrow attention QKV projection;
3. final MLP down projection \rightarrow residual stream \rightarrow final RMSNorm \rightarrow language modeling head.

Although these cases are usually written as parts of different modules, they share the same computational structure:

$$\mathbf{y} = \text{RMSNorm}(\mathbf{x}\mathbf{W}_0 + \mathbf{z}, \gamma)\mathbf{W}_1 = \left(r(\mathbf{x}\mathbf{W}_0 + \mathbf{z}) \odot \gamma \right) \mathbf{W}_1,$$

where \mathbf{z} denotes the residual stream and $r = 1/\text{rms}(\mathbf{x}\mathbf{W}_0 + \mathbf{z})$ is the row-wise inverse RMS factor. This pattern crosses the usual module boundary: it couples the output projection of one sublayer with the input projection of the next.

Residual addition and multiplication by the RMSNorm weight γ are tile-local, so they can be fused into a GEMM epilogue. The row-wise factor r , however, requires a reduction across the hidden dimension, which is larger than a single output tile. In the canonical computation, r is applied before the second GEMM, creating an apparent dependency between normalization and the next projection.

We address the reduction by splitting it into two levels. The first GEMM epilogue computes tile-local partial reductions, and a small auxiliary kernel reduces these partials across tiles to obtain r . Since the auxiliary kernel reads a few partial values per tile rather than the full activation tensor, its memory traffic is much smaller than that of a standalone RMSNorm.

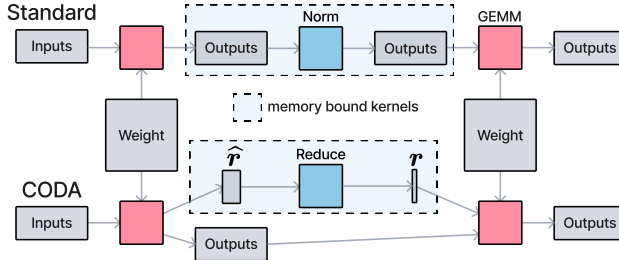

Figure 4: GEMM-RMSNorm-GEMM reparameterization.

The apparent dependency on r can be removed algebraically. Since r is shared across the row, it commutes with the second GEMM:

$$\mathbf{y} = \left(r(\mathbf{x}\mathbf{W}_0 + \mathbf{z}) \odot \gamma \right) \mathbf{W}_1 = r \left((\mathbf{x}\mathbf{W}_0 + \mathbf{z}) \odot \gamma \right) \mathbf{W}_1.$$

Thus, the row-wise scale does not need to be applied before the second GEMM. It can instead be delayed to the epilogue of the second GEMM, after the projection has been computed.

Concretely, the computation decomposes into two GEMMs and one lightweight reduction (Figure 4):

$$\begin{aligned} \text{GEMM 1: } \quad \mathbf{h}_0 &= \mathbf{x}\mathbf{W}_0, & \text{Epilogue 1: } \quad \mathbf{h}_1[i, j] &= \mathbf{h}_0[i, j] + \mathbf{z}[i, j], \\ & & \mathbf{h}_2[i, j] &= \mathbf{h}_1[i, j] \odot \gamma[j], \\ & & \widehat{\mathbf{r}}[i, j] &= \text{partialRMS}(\mathbf{h}_1[i, j]), \\ \\ \text{GEMM 2: } \quad \mathbf{h}_3 &= \mathbf{h}_2\mathbf{W}_1, & \text{Epilogue 2: } \quad \mathbf{y}[i, j] &= r[i] \mathbf{h}_3[i, j]. \end{aligned}$$

Here $r = 1/\sqrt{\text{reduce}(\widehat{\mathbf{r}}) + \epsilon}$ is computed by a small auxiliary reduction over the tile partials. This decomposition replaces a standalone RMSNorm kernel with tile-local epilogue work around the two GEMMs, plus a lightweight auxiliary reduction.

In Figure 5, we benchmark this reparameterization against existing implementations on LLaMA-style configurations with a batch of 16K tokens. We vary the hidden dimension across representative model scales, with $d \in \{2048, 4096, 8192\}$ corresponding roughly to 1B, 7B, and 70B models, respectively. Our GEMM-Epilogue kernel is generated by an LLM provided with the above abstractions (explained in more detail in Section 3.3.1).

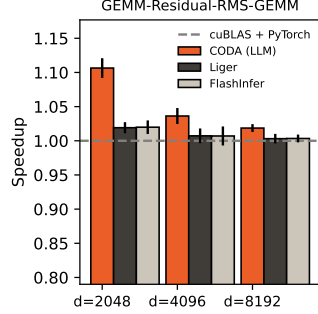

Figure 5: Benchmarks.

Numerics. The reparameterization changes where the RMSNorm scale is applied: the row-wise factor r is delayed from before the second GEMM to the second GEMM epilogue. We compare BF16 GEMM-RMSNorm-GEMM outputs against an FP32 reference on Llama-3 8B layers. We report the errors of CODA and QuACK, on which our GEMM template is based, normalized by the error of the standard PyTorch path. Figure 6 suggests that a more accurate GEMM mainloop can reduce numerical error, and that CODA’s reparameterized epilogue can reduce it further.

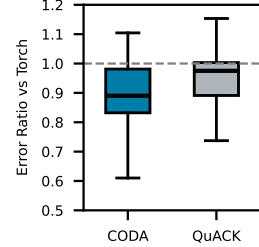

Figure 6: Relative error.

3.2.2 GEMM with Pairwise Activations

A second common pattern in Transformers is a GEMM followed by a *pairwise* activation. Unlike an elementwise activation, which transforms each feature independently, a pairwise activation consumes two adjacent feature values and produces one or two outputs.

$$\mathbf{h} = \mathbf{x}\mathbf{W}, \quad \mathbf{h}_a[i, j], \mathbf{h}_b[i, j] = \text{split}(\mathbf{h}[i, j]), \quad \mathbf{y}[i, j] = \mathbf{f}[i, j](\mathbf{h}_a[i, j], \mathbf{h}_b[i, j]).$$

This form captures several operations in Transformer blocks:

- RoPE rotates each feature pair and return two outputs;
- SwiGLU combines gate and value stream into one output;
- SwiGLU backward pass maps one incoming gradient into gradients for both paired inputs.

Pairwise activations couple neighboring feature lanes and may change the feature dimension. A naive implementation materializes the GEMM output, splits it into pairs, and applies the activation in a separate kernel. This adds memory traffic and sometimes materializes an expanded intermediate, as in SwiGLU.

Instead, we arrange paired features to be adjacent along the output-feature dimension. This matches the Hopper Tensor Core accumulator layout exposed to the epilogue, where each thread holds a small tuple of adjacent output values in registers before they are stored. The epilogue can therefore apply f directly to each pair with register-level computation.

This removes the standalone activation kernel and avoids materializing the paired intermediate in global memory. The same idea applies to dimension-preserving operations such as RoPE, dimension-reducing operations such as SwiGLU, and dimension-expanding operations in the backward pass, as long as the pairing is reflected in the GEMM output layout. See Figure 8 for performance benchmarks.

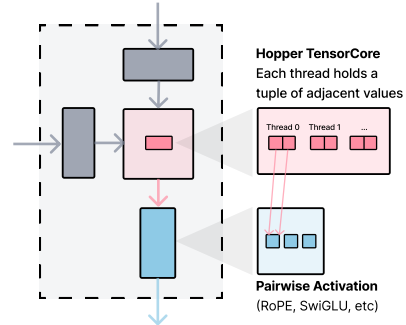

Figure 7: Pairwise activations operate on local feature pairs in the GEMM epilogue.

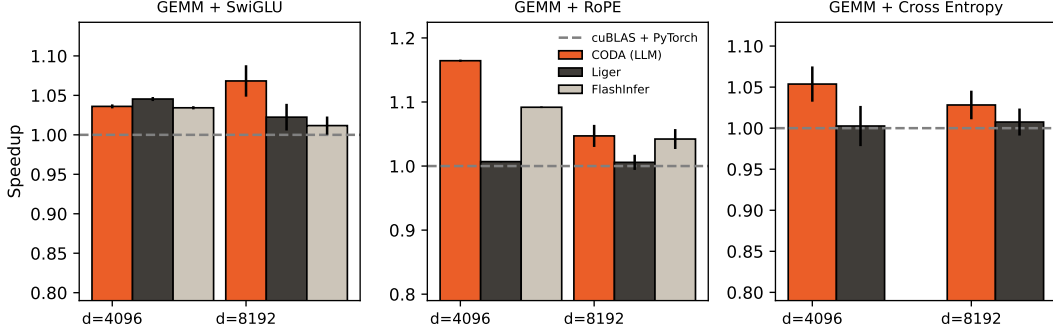

Figure 8: Kernel-level speedups for representative GEMM-plus-epilogue primitives across MNK sizes. RoPE uses an output dimension of $3N$ for QKV projections, and cross-entropy uses a 32K vocabulary. Speedups are relative to cuBLAS with `torch.compile`.

3.2.3 GEMM with Cross-Entropy Loss

Cross-entropy loss can also be expressed as a GEMM with epilogue-side reductions, as shown by Cut Cross-Entropy [21]. Let $\mathbf{h}_i = \mathbf{x}_i \mathbf{W}_{\text{lm}}$ be the logits for token i , and let \mathbf{y}_i be its target label. The per-token loss is

$$\ell_i = -\mathbf{h}_{i, \mathbf{y}_i} + \log \sum_k \exp(\mathbf{h}_{i, k}).$$

Thus, the loss decomposes into an indexed logit and a row-wise log-sum-exp over vocabulary entries.

Both terms fit the GEMM-plus-epilogue pattern. The indexed logit can be selected from the GEMM output tile using the target label, while the LSE can be accumulated as tile-local maximum and sum-exp statistics. A small auxiliary reduction then combines these statistics across tiles, avoiding a standalone memory-bound softmax over the full logits.³ See Figure 8 for performance benchmarks.

3.2.4 Backward Pass

The preceding sections show that much of the Transformer forward pass can be reparameterized as GEMMs with epilouges, plus lightweight auxiliary reductions. We now show that the backward pass preserves the same structure.

GEMM with elementwise epilogue. Consider two GEMMs separated by an elementwise epilogue:

$$\mathbf{h} = \mathbf{x} \mathbf{W}_0, \quad \mathbf{h}' = f(\mathbf{h}), \quad \mathbf{y} = \mathbf{h}' \mathbf{W}_1,$$

where f is applied elementwise. Given an upstream gradient $\nabla_{\mathbf{y}} \mathcal{L}$, reverse-mode differentiation gives

$$\nabla_{\mathbf{h}'} \mathcal{L} = \nabla_{\mathbf{y}} \mathcal{L} \mathbf{W}_1^\top, \quad \nabla_{\mathbf{h}} \mathcal{L} = \nabla_{\mathbf{h}'} \mathcal{L} \odot f'(\mathbf{h}), \quad \nabla_{\mathbf{x}} \mathcal{L} = \nabla_{\mathbf{h}} \mathcal{L} \mathbf{W}_0^\top.$$

Thus, the backward computation has the same structure as the forward computation: GEMM, local transformation, GEMM. The only difference is the direction of fusion. In the forward pass, f is fused into the epilogue of the *preceding* GEMM that produces \mathbf{h} ; in the backward pass, multiplication by $f'(\mathbf{h})$ is fused into the epilogue of the *following* GEMM that produces $\nabla_{\mathbf{h}'} \mathcal{L}$ (Figure 9).

Theorem 1. Consider a sequence of GEMM-with-epilogue blocks followed by a final GEMM:

$$\begin{aligned} \mathbf{h}_\ell &= \mathbf{x}_{\ell-1} \mathbf{W}_\ell, & \mathbf{x}_\ell[i, j] &= \mathbf{f}_\ell[i, j](\mathbf{h}_\ell[i, j]), & \ell &= 1, \dots, L-1, \\ \mathbf{h}_L &= \mathbf{x}_{L-1} \mathbf{W}_L. \end{aligned}$$

Assume each tile function $\mathbf{f}_\ell[i, j]$ acts only on its corresponding GEMM output tile. Then the activation gradients can be computed with the same GEMM-with-epilogue structure:

$$\begin{aligned} \nabla_{\mathbf{x}_{\ell-1}} \mathcal{L} &= \nabla_{\mathbf{h}_\ell} \mathcal{L} \mathbf{W}_\ell^\top, & \nabla_{\mathbf{h}_{\ell-1}} \mathcal{L}[i, j] &= \mathbf{g}_{\ell-1}[i, j](\nabla_{\mathbf{x}_{\ell-1}} \mathcal{L}[i, j], \mathbf{h}_{\ell-1}[i, j]), & \ell &= L, \dots, 2, \\ \nabla_{\mathbf{x}_0} \mathcal{L} &= \nabla_{\mathbf{h}_1} \mathcal{L} \mathbf{W}_1^\top. \end{aligned}$$

Here $\mathbf{g}_\ell[i, j]$ is the tile-local backward rule for $\mathbf{f}_\ell[i, j]$: it maps the gradient of the epilogue output tile $\mathbf{x}_\ell[i, j]$ to the gradient of the epilogue input tile $\mathbf{h}_\ell[i, j]$. The weight gradients are GEMMs:

$$\nabla_{\mathbf{W}_\ell} \mathcal{L} = \mathbf{x}_{\ell-1}^\top \nabla_{\mathbf{h}_\ell} \mathcal{L}, \quad \ell = 1, \dots, L.$$

Thus, tile-local epilouges in the forward pass induce tile-local epilouges in the backward pass, while the surrounding linear maps remain GEMMs.

³We use a separate final reduction rather than atomics, and materialize logits to simplify the backward pass.

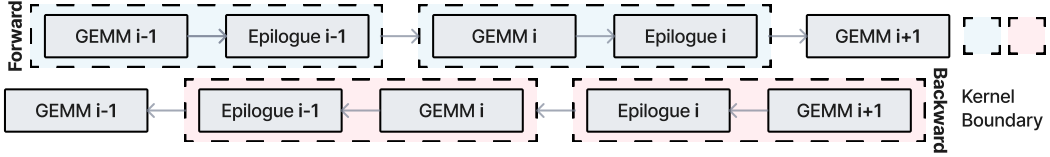

Figure 9: Forward and backward fusion for GEMM–epilogue blocks. Forward epilouges attach to the GEMM that produces their input, while backward epilouges attach to the GEMM that produces the gradient with respect to their output.

Proof sketch. For the GEMM $\mathbf{h}_\ell = \mathbf{x}_{\ell-1} \mathbf{W}_\ell$, reverse-mode differentiation gives

$$\nabla_{\mathbf{x}_{\ell-1}} \mathcal{L} = \nabla_{\mathbf{h}_\ell} \mathcal{L} \mathbf{W}_\ell^\top, \quad \nabla_{\mathbf{W}_\ell} \mathcal{L} = \mathbf{x}_{\ell-1}^\top \nabla_{\mathbf{h}_\ell} \mathcal{L},$$

which are both GEMMs. For the epilogue $\mathbf{x}_\ell[i, j] = \mathbf{f}_\ell[i, j](\mathbf{h}_\ell[i, j])$, define the local backward rule by

$$\nabla_{\mathbf{h}_\ell} \mathcal{L}[i, j] = \mathbf{g}_\ell[i, j](\nabla_{\mathbf{x}_\ell} \mathcal{L}[i, j], \mathbf{h}_\ell[i, j]).$$

Since each $\mathbf{f}_\ell[i, j]$ depends only on its own tile, the corresponding $\mathbf{g}_\ell[i, j]$ also acts only on that tile. The backward pass therefore introduces no new cross-tile communication and preserves the GEMM-with-epilogue structure. \square

RMSNorm backward. RMSNorm is the main case where the backward pass is not purely tile-local. Its backward rule introduces two reductions: a row-wise statistic needed for the input gradient, and a feature-wise reduction across rows for the RMSNorm weight gradient. A direct implementation computes both in a standalone RMSNorm backward kernel, requiring additional reads of activation-sized tensors. However, the row-wise statistic can be moved to a neighboring GEMM boundary. Consider

$$\mathbf{h}_0 = \mathbf{x} \mathbf{W}_0, \quad \mathbf{h}_1 = f(\mathbf{h}_0), \quad \mathbf{h}_2 = \text{RMSNorm}(\mathbf{h}_1, \gamma), \quad \mathbf{y} = \mathbf{h}_2 \mathbf{W}_1.$$

RMSNorm backward requires the row-wise inner product

$$\mathbf{s} = \frac{1}{d} \text{sum}_{\text{cols}} (\nabla_{\mathbf{h}_2} \mathcal{L} \odot \mathbf{h}_2).$$

Using $\nabla_{\mathbf{h}_2} \mathcal{L} = \nabla_{\mathbf{y}} \mathcal{L} \mathbf{W}_1^\top$ and $\mathbf{y} = \mathbf{h}_2 \mathbf{W}_1$, this statistic can be equivalently written as

$$\mathbf{s} = \frac{1}{d} \text{sum}_{\text{cols}} (\nabla_{\mathbf{y}} \mathcal{L} \odot \mathbf{y}).$$

This identity changes where the statistic is computed. Instead of launching a standalone RMSNorm backward kernel to read \mathbf{h}_2 and $\nabla_{\mathbf{h}_2} \mathcal{L}$, we accumulate the same row-wise quantity at a boundary where \mathbf{y} and $\nabla_{\mathbf{y}} \mathcal{L}$ are already available, thereby exposing the computation to epilogue fusion.

In consecutive Transformer patterns, each GEMM epilogue can therefore accumulate the row-wise statistic needed by the preceding RMSNorm backward. The RMSNorm weight gradient is handled similarly by emitting tile partials for the reduction across rows. Overall, RMSNorm backward becomes GEMM–epilogue kernels plus lightweight auxiliary reductions over tile partials. We give the full derivation and kernel organization in Section A.2, with benchmarks in Figure 11.

3.3 Implementation

We implement CODA on top of CuTeDSL, which provides Python-level kernel authoring while retaining low-level control over details such as layouts and memory movement.

Data movement. Vector loads handle small broadcast operands such as RMSNorm weights. These values are staged once in shared memory and reused across subtiles. Tile loads handle larger operands such as residual activations, and uses Tensor Memory Accelerator transfers between global memory and shared memory, allowing data movement to overlap with epilogue computation. Stores follow similar tile-granular path for transformed outputs, saved intermediates, and reduction partials.

Local computation. Pairwise maps act on neighboring features, covering dimension-preserving operations such as RoPE, dimension-reducing operations such as SwiGLU, and dimension-expanding operations in the backward pass. When a map changes the feature dimension, the epilogue performs

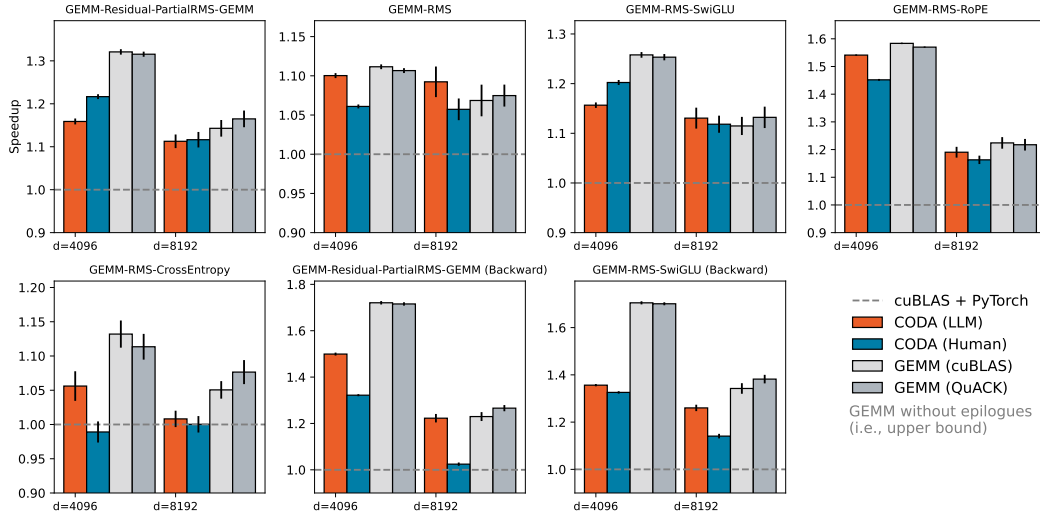

Figure 10: Kernel-level speedups on reparameterized Transformer kernels relative to cuBLAS with `torch.compile`. Raw GEMM baselines using PyTorch/cuBLAS and QuACK are included as reference ceilings, since they execute only the matrix multiplication and no epilogue work.

the corresponding local layout adjustment, such as compacting dimension-reducing outputs or packing pairs of 16-bit values for dimension-expanding outputs.

Reductions. Tile-wise reductions follow the ownership of GEMM output fragments. Row-wise reductions are accumulated by the warp that owns the row. Column-wise reductions may span multiple warps, so each warp first produces a partial result, and these partials are combined through shared memory.

3.3.1 LLM-Oriented Authoring

CODA is designed both for LLM workloads and for LLM-assisted authoring. Rather than asking a model to synthesize arbitrary CUDA or discover a hardware schedule from scratch, CODA exposes a constrained space of epilogue programs around expert-designed GEMM mainloops. Its primitives already encode efficient implementation strategies, so LLM-based authoring becomes a problem of composing vector loads, tile loads, pairwise maps, reductions, and stores for a given Transformer computation. This lightweight use of LLMs is complementary to prior work on kernel generation, which often relies on orchestration, search, execution feedback, or post-training [12, 16, 3, 10, 24].

Because CuTeDSL is relatively new, current models have limited exposure to its idioms. We therefore provide curated demonstrations for each abstraction. In practice, the repository itself acts as a growing demonstration set, with new kernels being written by adapting and composing existing examples.

Compositions. Transformer kernels often combine several epilogue operations, such as residual addition and RMSNorm scaling. Monolithic fused epilogues lead to large, repetitive implementations that are difficult to place in context. CODA instead represents each epilogue as a composition of reusable primitives: the LLM specifies the local epilogue program, while the library supplies the fixed GEMM mainloop and implementation pattern for each primitive. New fused kernels are therefore assembled from reusable building blocks instead of being rewritten from scratch.

4 Experiments

After the reparameterizations in Section 3.2, we obtain a compact benchmark suite of GEMM-plus-epilogue kernels spanning the Transformer++ forward and backward pass (Section C.1). The suite covers nearly all computation outside attention, embeddings, auxiliary reductions, and lightweight glue operations. We evaluate two implementations. CODA (LLM) uses Claude Code to generate most kernels from a written specification, curated examples, and a running log of implementation tips, with lightweight human supervision. CODA (human) is written by human programmers using the same high-level reparameterizations, but without access to the exact CODA primitive set.

We compare against cuBLAS with `torch.compile`, as well as optimized LLM kernel libraries including Liger Kernel [6] and FlashInfer [23]. Because our reparameterized kernels do not always

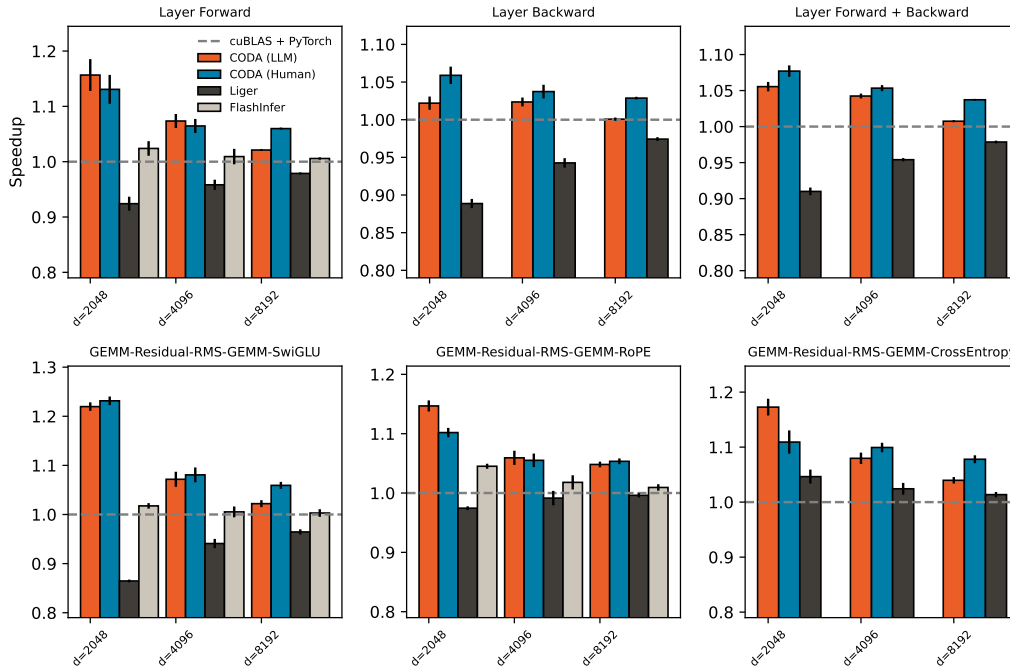

Figure 11: Block-level speedups for reparameterized Transformer kernel sequences, including auxiliary reductions and lightweight glue operations. Here, a layer denotes two consecutive GEMM-Residual-RMSNorm-GEMM blocks with the SwiGLU and RoPE activations, respectively.

have one-to-one counterparts in existing libraries, we compose the closest available optimized primitives and fall back to PyTorch operators as needed. We apply `torch.compile` to each method when compatible. Additional setup details are given in Section C.2.

Kernel Benchmarks. We first evaluate CODA at the individual-kernel level. Unless otherwise noted, we use square GEMM shapes with $M=N=K \in \{4096, 8192\}$. For cross-entropy kernels, we set the vocabulary dimension to 32768. For RoPE kernels, we use $N_{\text{rope}}=3N$ to account for QKV-style projections and use precomputed cos and sin tables.⁴ For kernels that emit partial reductions, we benchmark only the fused GEMM kernel with reduction tile size 128; auxiliary reductions are included in the block-level benchmarks below. We benchmark functions using Triton’s `do_bench` and show means and standard deviations across 30 runs.

We evaluate two groups of kernels from Section C.1. The first group consists of standard Transformer-style kernels, such as GEMM with RoPE, SwiGLU, or cross-entropy epilogues. These kernels have close counterparts in existing libraries, so we compare against cuBLAS with `torch.compile`, Liger Kernels, and FlashInfer when applicable. Results are shown in Figure 8.

The second group consists of reparameterized Transformer forward and backward kernels, which generally do not have one-to-one equivalents in existing libraries. For these kernels, we primarily compare against cuBLAS with `torch.compile`, and additionally report raw GEMM from PyTorch/cuBLAS and QuACK.⁵ These raw GEMM omit epilogue work and therefore serve as reference ceilings for the attainable throughput. Results are shown in Figure 10.

Block Benchmarks. We next benchmark kernel sequences corresponding to Transformer sublayers and full layers, which we call *blocks*. We use hidden sizes in $\{2048, 4096, 8192\}$, roughly matching 1B, 7B, and 70B model scales, with FFN expansion rate $8/3$ rounded to multiples of 256 and vocabulary size 32768. Unlike isolated kernel benchmarks, these measurements include auxiliary reductions and lightweight glue operations.

⁴For CODA, we additionally pre-broadcast and extend these tables across batch, head, and QKV dimensions to avoid in-kernel branching, at the cost of additional input traffic.

⁵<https://github.com/Dao-AI-Lab/quack>

For the forward pass, we compare each reparameterized sequence against the closest available sequence of optimized operators. For the backward pass, the reparameterization changes the dependency structure: each sublayer emits partial statistics needed by the preceding RMSNorm backward. Individual backward sublayers therefore do not have direct PyTorch counterparts, so we report backward results at the full-layer level. In CODA, a layer consists of two consecutive GEMM-Residual-RMSNorm-GEMM blocks covering the SwiGLU and RoPE paths. Results are shown in Figure 11.

5 Conclusion and Limitations

CODA reparameterizes much of Transformer computation as GEMM epilogues, reducing memory-bound overhead while preserving GEMM efficiency. Its constrained abstraction supports high-performance kernels authored by both humans and LLMs.

Limitations. Our reparameterizations target a common Transformer architecture; extending them to broader model families is future work. CODA currently focuses on single-GPU kernels and does not yet address distributed execution. Finally, while reparameterization improves efficiency, it can obscure module boundaries and algorithmic semantics, making integration with framework-level abstractions more challenging.

Acknowledgment

We thank Beshr Islam Bouli, Kaiming Cheng, Xinle Cheng, Ryan Chin, Tarushii Goel, Wentao Guo, Lucas Torroba Hennigen, Alicia Li, Mayank Mishra, Jyothishh Pari, Caiming Xiong, Nicholas Yap, Tianyuan Zhang, and Adam Zweiger for helpful discussion. We gratefully acknowledge the support of the Schmidt Sciences AI2050 fellowship, the Google ML and Systems Junior Faculty Awards, the Google Research Scholar program, and the National Science Foundation (Award #2441872).

References

- [1] J. Ansel, E. Yang, H. He, N. Gimelshein, A. Jain, M. Voznesensky, B. Bao, P. Bell, D. Berard, E. Burovski, et al. Pytorch 2: Faster machine learning through dynamic python bytecode transformation and graph compilation. In *Proceedings of the 29th ACM international conference on architectural support for programming languages and operating systems, volume 2*, pages 929–947, 2024.
- [2] T. Chen, T. Moreau, Z. Jiang, L. Zheng, E. Yan, H. Shen, M. Cowan, L. Wang, Y. Hu, L. Ceze, et al. {TVM}: An automated {End-to-End} optimizing compiler for deep learning. In *13th USENIX Symposium on Operating Systems Design and Implementation (OSDI 18)*, pages 578–594, 2018.
- [3] W. Chen, J. Zhu, Q. Fan, Y. Ma, and A. Zou. Cuda-llm: Llms can write efficient cuda kernels. *arXiv preprint arXiv:2506.09092*, 2025.
- [4] Z. Chen, A. Kerr, R. Cai, J. Kosaian, H. Wu, Y. Ding, and Y. Xie. Evt: Accelerating deep learning training with epilogue visitor tree. In *Proceedings of the 29th ACM International Conference on Architectural Support for Programming Languages and Operating Systems, Volume 3*, pages 301–316, 2024.
- [5] A. Grattafiori, A. Dubey, A. Jauhri, A. Pandey, A. Kadian, A. Al-Dahle, A. Letman, A. Mathur, A. Schelten, A. Vaughan, et al. The llama 3 herd of models. *arXiv preprint arXiv:2407.21783*, 2024.
- [6] P.-L. Hsu, Y. Dai, V. Kothapalli, Q. Song, S. Tang, S. Zhu, S. Shimizu, S. Sahni, H. Ning, and Y. Chen. Liger kernel: Efficient triton kernels for llm training. *arXiv preprint arXiv:2410.10989*, 2024.
- [7] A. Ivanov, N. Dryden, T. Ben-Nun, S. Li, and T. Hoefer. Data movement is all you need: A case study on optimizing transformers. *Proceedings of Machine Learning and Systems*, 3:711–732, 2021.

- [8] Z. Jia, O. Padon, J. Thomas, T. Warszawski, M. Zaharia, and A. Aiken. Taso: optimizing deep learning computation with automatic generation of graph substitutions. In *Proceedings of the 27th ACM Symposium on Operating Systems Principles*, pages 47–62, 2019.
- [9] W. Kwon, Z. Li, S. Zhuang, Y. Sheng, L. Zheng, C. H. Yu, J. Gonzalez, H. Zhang, and I. Stoica. Efficient memory management for large language model serving with pagedattention. In *Proceedings of the 29th symposium on operating systems principles*, pages 611–626, 2023.
- [10] R. T. Lange, Q. Sun, A. Prasad, M. Faldor, Y. Tang, and D. Ha. Towards robust agentic cuda kernel benchmarking, verification, and optimization. *arXiv preprint arXiv:2509.14279*, 2025.
- [11] W. Liang, T. Liu, L. Wright, W. Constable, A. Gu, C.-C. Huang, I. Zhang, W. Feng, H. Huang, J. Wang, et al. Torchitan: One-stop pytorch native solution for production ready llm pre-training. *arXiv preprint arXiv:2410.06511*, 2024.
- [12] A. Ouyang, S. Guo, S. Arora, A. L. Zhang, W. Hu, C. Ré, and A. Mirhoseini. Kernelbench: Can llms write efficient gpu kernels? *arXiv preprint arXiv:2502.10517*, 2025.
- [13] B. Spector, J. Juravsky, S. Sul, O. Dugan, D. Lim, D. Fu, S. Arora, and C. Ré. Look ma, no bubbles! designing a low-latency megakernel for llama-1b, 2025.
- [14] B. F. Spector, S. Arora, A. Singhal, D. Y. Fu, and C. Ré. Thunderkittens: Simple, fast, and adorable ai kernels. *arXiv preprint arXiv:2410.20399*, 2024.
- [15] J. Su, M. Ahmed, Y. Lu, S. Pan, W. Bo, and Y. Liu. Roformer: Enhanced transformer with rotary position embedding. *Neurocomputing*, 568:127063, 2024.
- [16] S. Su, X. Sun, X. Li, A. Wang, J. Li, and C. Shum. Cuda-l2: Surpassing cublas performance for matrix multiplication through reinforcement learning. *arXiv preprint arXiv:2512.02551*, 2025.
- [17] S. H. Sul, S. Arora, B. F. Spector, and C. Ré. Parallelkittens: Systematic and practical simplification of multi-gpu ai kernels. *arXiv preprint arXiv:2511.13940*, 2025.
- [18] V. Thakkar, P. Ramani, C. Cecka, A. Shivam, H. Lu, E. Yan, J. Kosaian, M. Hoemmen, H. Wu, A. Kerr, M. Nicely, D. Merrill, D. Blasig, A. Atluri, F. Qiao, P. Majcher, P. Springer, M. Hohnerbach, J. Wang, and M. Gupta. CUTLASS, Jan. 2023. URL <https://github.com/NVIDIA/cutlass>.
- [19] P. Tillet, H.-T. Kung, and D. Cox. Triton: an intermediate language and compiler for tiled neural network computations. In *Proceedings of the 3rd ACM SIGPLAN International Workshop on Machine Learning and Programming Languages*, pages 10–19, 2019.
- [20] L. Wang, Y. Cheng, Y. Shi, Z. Tang, Z. Mo, W. Xie, L. Ma, Y. Xia, J. Xue, F. Yang, et al. Tilelang: A composable tiled programming model for ai systems. *arXiv preprint arXiv:2504.17577*, 2025.
- [21] E. Wijmans, B. Huval, A. Hertzberg, V. Koltun, and P. Krähenbühl. Cut your losses in large-vocabulary language models. In *International Conference on Learning Representations*, 2025.
- [22] M. Wu, X. Cheng, S. Liu, C. Shi, J. Ji, M. K. Ao, P. Velliengiri, X. Miao, O. Padon, and Z. Jia. Mirage: A {Multi-Level} superoptimizer for tensor programs. In *19th USENIX Symposium on Operating Systems Design and Implementation (OSDI 25)*, pages 21–38, 2025.
- [23] Z. Ye, L. Chen, R. Lai, W. Lin, Y. Zhang, S. Wang, T. Chen, B. Kasikci, V. Grover, A. Krishnamurthy, et al. Flashinfer: Efficient and customizable attention engine for llm inference serving. *Proceedings of Machine Learning and Systems*, 7, 2025.
- [24] M. Yuksekogonul, D. Kocejca, X. Li, F. Bianchi, J. McCaleb, X. Wang, J. Kautz, Y. Choi, J. Zou, C. Guestrin, et al. Learning to discover at test time. *arXiv preprint arXiv:2601.16175*, 2026.
- [25] L. Zheng, L. Yin, Z. Xie, C. L. Sun, J. Huang, C. H. Yu, S. Cao, C. Kozyrakis, I. Stoica, J. E. Gonzalez, et al. Sglang: Efficient execution of structured language model programs. *Advances in neural information processing systems*, 37:62557–62583, 2024.

A Backward Pass

A.1 Tile-wise Epilogue

Partition the GEMM output \mathbf{h} into tiles $\mathbf{h}_{[i,j]}$. A tile-wise epilogue applies an independent transformation to each tile:

$$\mathbf{h} = \mathbf{x}\mathbf{W}_0, \quad \mathbf{h}' = \begin{bmatrix} \mathbf{f}[0,0](\mathbf{h}[0,0]) & \cdots & \mathbf{f}[0,N](\mathbf{h}[0,N]) \\ \vdots & \ddots & \vdots \\ \mathbf{f}[M,0](\mathbf{h}[M,0]) & \cdots & \mathbf{f}[M,N](\mathbf{h}[M,N]) \end{bmatrix}, \quad \mathbf{y} = \mathbf{h}'\mathbf{W}_1.$$

The backward pass has the same block structure.

$$\nabla_{\mathbf{h}'}\mathcal{L} = \nabla_{\mathbf{y}}\mathcal{L}\mathbf{W}_1^\top, \quad \nabla_{\mathbf{h}}\mathcal{L} = \begin{bmatrix} \mathbf{g}[0,0](\nabla_{\mathbf{h}'}\mathcal{L}[0,0]) & \cdots & \mathbf{g}[0,N](\nabla_{\mathbf{h}'}\mathcal{L}[0,N]) \\ \vdots & \ddots & \vdots \\ \mathbf{g}[M,0](\nabla_{\mathbf{h}'}\mathcal{L}[M,0]) & \cdots & \mathbf{g}[M,N](\nabla_{\mathbf{h}'}\mathcal{L}[M,N]) \end{bmatrix}, \quad \nabla_{\mathbf{x}}\mathcal{L} = \nabla_{\mathbf{h}}\mathcal{L}\mathbf{W}_0^\top.$$

Here each $\mathbf{g}[i,j]$ is the local backward rule for the corresponding tile:

$$\mathbf{g}[i,j](\Delta) = \text{unvec}\left(\mathbf{J}_{[i,j]}^\top \text{vec}(\Delta)\right), \quad \mathbf{J}_{[i,j]} = \frac{\partial \text{vec}(f[i,j](\mathbf{h}[i,j]))}{\partial \text{vec}(\mathbf{h}[i,j])}.$$

Thus, each gradient tile depends only on the corresponding forward tile and upstream gradient tile. No cross-tile communication is introduced, so the backward operation remains tile-local and can be implemented as a GEMM epilogue. As shown in Figure 9, the only structural change is the direction of fusion: forward epilogues are fused into the GEMM that produces their input, while backward epilogues are fused into the GEMM that produces the gradient with respect to their output.

A.2 GEMM-RMSNorm-GEMM Backward Pass

We now describe the backward pass for the GEMM–epilogue–RMSNorm–GEMM pattern. RMSNorm is the first case where the backward pass is not purely tile-local. The reason is simple: RMSNorm contains a row-wise normalization factor, so its backward pass needs a row-wise statistic. In addition, the RMSNorm weight γ is shared across rows, so its gradient requires a reduction across the row dimension. The goal of this section is to show that these are the only non-local pieces. Everything else can still be fused into GEMM epilogues, with the non-local pieces handled by lightweight reductions over tile partials.

Consider the forward computation

$$\mathbf{h}_0 = \mathbf{x}\mathbf{W}_0, \quad \mathbf{h}_1 = f(\mathbf{h}_0), \quad \mathbf{h}_2 = \text{RMSNorm}(\mathbf{h}_1, \gamma), \quad \mathbf{y} = \mathbf{h}_2\mathbf{W}_1.$$

Let \mathbf{r} be the row-wise inverse RMS factor. We write $\bar{\mathbf{r}} = \mathbf{r}\mathbf{1}^\top$ and $\bar{\gamma} = \mathbf{1}\gamma^\top$ for the broadcasts of \mathbf{r} and γ to the shape of \mathbf{h}_1 . Then

$$\mathbf{h}_2 = \bar{\mathbf{r}} \odot \mathbf{h}_1 \odot \bar{\gamma}.$$

Given the upstream gradient $\nabla_{\mathbf{y}}\mathcal{L}$, the first backward operation is the GEMM

$$\nabla_{\mathbf{h}_2}\mathcal{L} = \nabla_{\mathbf{y}}\mathcal{L}\mathbf{W}_1^\top.$$

The RMSNorm backward can be written as

$$\begin{aligned} \nabla_{\mathbf{h}_1}\mathcal{L} &= \bar{\mathbf{r}} \odot (\nabla_{\mathbf{h}_2}\mathcal{L} \odot \bar{\gamma} - \bar{\mathbf{r}} \odot \mathbf{h}_1 \odot \bar{\mathbf{s}}), \\ \nabla_{\gamma}\mathcal{L} &= \text{sum}_{\text{rows}}(\nabla_{\mathbf{h}_2}\mathcal{L} \odot \mathbf{h}_1 \odot \bar{\mathbf{r}}), \end{aligned}$$

where $\bar{\mathbf{s}} = \mathbf{s}\mathbf{1}^\top$ broadcasts one scalar per row. The row-wise statistic \mathbf{s} is

$$\begin{aligned} \mathbf{s} &= \frac{1}{d} \odot \mathbf{r} \odot \text{sum}_{\text{cols}}(\nabla_{\mathbf{h}_2}\mathcal{L} \odot \bar{\gamma} \odot \mathbf{h}_1), \\ &= \frac{1}{d} \text{sum}_{\text{cols}}(\nabla_{\mathbf{h}_2}\mathcal{L} \odot \bar{\mathbf{r}} \odot \bar{\gamma} \odot \mathbf{h}_1), \\ &= \frac{1}{d} \text{sum}_{\text{cols}}(\nabla_{\mathbf{h}_2}\mathcal{L} \odot \mathbf{h}_2), \end{aligned}$$

where d is the hidden dimension. This expression identifies the two non-local operations in RMSNorm backward. The statistic s is a reduction across columns, producing one scalar per row. The weight gradient $\nabla_{\gamma}\mathcal{L}$ is a reduction across rows, producing one scalar per hidden feature.

A standalone RMSNorm backward kernel would compute these reductions by reading activation-sized tensors. The key observation is that the row-wise statistic s can be moved to a different boundary. Using $\nabla_{h_2}\mathcal{L} = \nabla_{\mathbf{y}}\mathcal{L}\mathbf{W}_1^\top$ and $\mathbf{y} = \mathbf{h}_2\mathbf{W}_1$, we have

$$\begin{aligned} \mathbf{s} &= \frac{1}{d} \text{sum}_{\text{cols}} (\nabla_{h_2}\mathcal{L} \odot \mathbf{h}_2), \\ &= \frac{1}{d} \text{sum}_{\text{cols}} ((\nabla_{\mathbf{y}}\mathcal{L}\mathbf{W}_1^\top) \odot \mathbf{h}_2) \\ &= \frac{1}{d} \text{diag} ((\nabla_{\mathbf{y}}\mathcal{L}\mathbf{W}_1^\top) \mathbf{h}_2^\top) \\ &= \frac{1}{d} \text{diag} (\nabla_{\mathbf{y}}\mathcal{L} (\mathbf{h}_2\mathbf{W}_1)^\top) \\ &= \frac{1}{d} \text{sum}_{\text{cols}} (\nabla_{\mathbf{y}}\mathcal{L} \odot (\mathbf{h}_2\mathbf{W}_1)) \\ &= \frac{1}{d} \text{sum}_{\text{output}} (\nabla_{\mathbf{y}}\mathcal{L} \odot \mathbf{y}). \end{aligned}$$

Intuitively, the RMSNorm backward needs the inner product between an activation and its gradient along each row. The identity above says that this inner product can be computed either before or after the following GEMM. This lets us compute the statistic at a boundary where \mathbf{y} and $\nabla_{\mathbf{y}}\mathcal{L}$ are already available.

This is useful because Transformer layers contain consecutive GEMM–epilogue–RMSNorm–GEMM patterns. During the backward pass of one pattern, the GEMM that produces $\nabla_{\mathbf{x}}\mathcal{L}$ already has access to both \mathbf{x} and $\nabla_{\mathbf{x}}\mathcal{L}$. Since this \mathbf{x} is the output of the preceding pattern, the epilogue of the current pattern can accumulate the RMSNorm statistic needed by the preceding pattern:

$$\widehat{\mathbf{s}}_{\text{prev}} = \text{reduceTile}_{\text{cols}} (\mathbf{x} \odot \nabla_{\mathbf{x}}\mathcal{L}), \quad \mathbf{s}_{\text{prev}} = \frac{1}{d} \text{reduce} (\widehat{\mathbf{s}}_{\text{prev}}).$$

Thus, each pattern computes the row-wise RMSNorm backward statistic required by the pattern before it. The reduction is still present, but it is now a small reduction over tile partials rather than a standalone activation-sized RMSNorm backward kernel.

The RMSNorm weight gradient is handled similarly, except that its reduction is across rows rather than columns. We accumulate tile partials in the RMSNorm backward epilogue:

$$\widehat{\nabla_{\gamma}\mathcal{L}} = \text{reduceTile}_{\text{rows}} (\nabla_{h_2}\mathcal{L} \odot \mathbf{h}_1 \odot \bar{\mathbf{r}}), \quad \nabla_{\gamma}\mathcal{L} = \text{reduce}_{\text{rows}} (\widehat{\nabla_{\gamma}\mathcal{L}}).$$

Putting these pieces together, the backward pass is organized as follows:

$$\begin{aligned} \text{GEMM 1: } & \nabla_{h_2}\mathcal{L} = \nabla_{\mathbf{y}}\mathcal{L}\mathbf{W}_1^\top, \\ \text{Epilogue 1: } & \nabla_{h_1}\mathcal{L} = \bar{\mathbf{r}} \odot (\nabla_{h_2}\mathcal{L} \odot \bar{\boldsymbol{\gamma}} - \mathbf{h}_1 \odot \bar{\mathbf{r}} \odot \bar{\mathbf{s}}), \\ & \nabla_{h_0}\mathcal{L} = g(\nabla_{h_1}\mathcal{L}), \\ & \widehat{\nabla_{\gamma}\mathcal{L}} = \text{reduceTile}_{\text{rows}} (\nabla_{h_2}\mathcal{L} \odot \mathbf{h}_1 \odot \bar{\mathbf{r}}), \end{aligned}$$

$$\begin{aligned} \text{GEMM 2: } & \nabla_{\mathbf{x}}\mathcal{L} = \nabla_{h_0}\mathcal{L}\mathbf{W}_0^\top, \\ \text{Epilogue 2: } & \widehat{\mathbf{s}}_{\text{prev}} = \text{reduceTile}_{\text{cols}} (\mathbf{x} \odot \nabla_{\mathbf{x}}\mathcal{L}), \end{aligned}$$

$$\begin{aligned} \text{Auxiliary reductions: } & \mathbf{s}_{\text{prev}} = \frac{1}{d} \text{reduce}_{\text{cols}} (\widehat{\mathbf{s}}_{\text{prev}}), \\ & \nabla_{\gamma}\mathcal{L} = \text{reduce}_{\text{rows}} (\widehat{\nabla_{\gamma}\mathcal{L}}). \end{aligned}$$

Here g denotes the tile-local backward rule for the epilogue f . The statistic s used in Epilogue 1 is assumed to have already been accumulated by the following pattern in the backward order.

Finally, the output of a pattern often passes through another epilogue before the next pattern begins:

$$\mathbf{h}_0 = \mathbf{x}\mathbf{W}_0, \quad \mathbf{h}_1 = f_0(\mathbf{h}_0), \quad \mathbf{h}_2 = \text{RMSNorm}(\mathbf{h}_1, \gamma), \quad \mathbf{h}_3 = \mathbf{h}_2\mathbf{W}_1 \quad \mathbf{y} = f_1(\mathbf{h}_3).$$

In this case, the statistic should be accumulated using the pre-epilogue tensor \mathbf{h}_3 and its gradient. The backward rule for f_1 is tile-local, so it can be fused before accumulating the statistic:

$$\begin{aligned} \text{GEMM 2: } \nabla_{\mathbf{x}}\mathcal{L} &= \nabla_{\mathbf{h}_0}\mathcal{L}\mathbf{W}_0^\top, \\ \text{Epilogue 2: } \nabla_{\overleftarrow{\mathbf{h}_3}}\mathcal{L} &= \overleftarrow{f_1}(\nabla_{\mathbf{x}}\mathcal{L}), \\ \widehat{\mathbf{s}}_{\text{prev}} &= \text{reduceTile}_{\text{cols}}\left(\overleftarrow{\mathbf{h}_3} \odot \nabla_{\overleftarrow{\mathbf{h}_3}}\mathcal{L}\right) \end{aligned}$$

Here $\overleftarrow{\mathbf{h}_3}$ denotes the pre-epilogue GEMM output from the preceding pattern, and $\overleftarrow{f_1}$ denotes the local backward rule for its following epilogue. This case preserves the same structure: apply the local backward epilogue first, then accumulate the row-wise statistic from the pre-epilogue activation and its gradient.

Overall, this organization removes the activation-sized RMSNorm backward kernel. The remaining non-local work consists only of reductions over tile partials: a column reduction for the row-wise RMSNorm statistic, and a row reduction for the RMSNorm weight gradient. The GEMMs and local backward updates are fused into GEMM epilogues, preserving the same GEMM-plus-epilogue structure used in the forward pass.

B CODA

B.1 Epilogue Template

```

1 # --- Mainloop ---
2 # ...
3 # --- Pre-loop: visitor tree entry points ---
4 epilogue.consumer_begin(...)
5 epilogue.producer_begin(...)
6
7 # --- Main loop: epilogue tiles ---
8 for epi_idx in range(num_epi_tiles):
9     # Per-tile visitor entry
10    epilogue.consumer_begin_loop(...)
11    # Producer-side async load (e.g., TMA)
12    epilogue.producer_tma_load(...)
13    # Core epilogue computation
14    rD = load_accumulator_fragment(...)
15    epilogue.consumer_visit(rD, ...)
16    # Registers -> shared memory
17    store_regs_to_smem(...)
18    # Pre-store visitor hook
19    epilogue.consumer_smem_store(...)
20    tma_store_from_smem_to_gmem(...)
21    epilogue.consumer_tma_store(...)
22    # Per-tile visitor exit
23    epilogue.consumer_end_loop(gmem_coord)
24
25 # --- Post-loop: visitor tree finalization ---
26 epilogue.consumer_end(...)

```

Listing 1: Epilogue Kernel Abstraction.

B.2 Epilogue Example

```

1 def _create_mean_sq_reduction_op(element_type, inv_block_size):
2     """Create a reduction op that accumulates mean of squares: acc + val^2 *
3     inv_block_size.
4
5     The combine_fn squares each new element and scales by 1/block_size before adding
6     to the accumulator. The warp-level reduction uses standard addition since partial
7     sums are already accumulated and scaled.
8     """
9     init_value = element_type(0.)
10    inv_bs = element_type(inv_block_size)
11
12    _sq_combine = lambda x, y: x + y * y * inv_bs

```

```

12     _add_wrp = lambda tree_x, tree_y: pytree.tree_map(operator.add, tree_x, tree_y)
13
14     return BlockReductionOp(
15         combine_fn=lambda tree_x, tree_y: pytree.tree_map(_sq_combine, tree_x, tree_y),
16         reduce_ssa=None,
17         reduce_wrp=lambda xs: pytree.tree_map(
18             lambda x: cute.arch.warp_reduction(
19                 x,
20                 op=_add_wrp,
21                 threads_in_group=HOPPER_WARP_REDUCTION_WIDTH,
22             ),
23             xs,
24         ),
25         init_value=init_value,
26     )
27
28
29 class EVTRowVecMulPostAct(EpilogueVisitorTree):
30     """
31     Loads a per-N row vector W (cp.async to smem, then s2r), multiplies the
32     accumulator by W into a separate register tile, and stores that scaled
33     tile to a side output mPostAct via TMA. tRS_rD itself is left unchanged
34     so the main D output (the unscaled GEMM result) is unaffected.
35
36     This mirrors the rowvec=norm_weight side-output path of trainstation's
37     'gemm_partial_rms_fwd', kept local to this kernel rather than as a
38     general-purpose rapier EVT.
39
40     Inputs:
41     - GEMM output (in registers): [M x N], unchanged by this op
42     - mRowVec: [L, N] - RMSNorm weight, broadcast along M
43
44     Outputs:
45     - mPostAct: [M x N] = D * W (side output, written via TMA)
46     """
47
48     @struct_utils.mlir_namedtuple
49     class EpilogueArguments(NamedTuple):
50         mPostAct: cute.Tensor | None
51         mRowVec: cute.Tensor | None
52
53     @struct_utils.register_pytree_dataclass
54     @dataclass
55     class EpilogueParams(EpilogueVisitorTree.EpilogueParams):
56         mPostAct: cute.Tensor | None
57         mRowVec: cute.Tensor | None
58         epi_tma_atom: cute.CopyAtom
59         epi_gmem_layout: cutlass.utils.LayoutEnum
60         epi_smem_layout_staged: cute.Layout
61
62     @struct_utils.register_pytree_dataclass
63     @dataclass
64     class EpilogueTensorsSMem(EpilogueVisitorTree.EpilogueTensorsSMem):
65         sPostAct: cute.Tensor | None
66         sRowVec: cute.Tensor | None
67
68     @struct_utils.register_pytree_dataclass
69     @dataclass
70     class EpilogueTensors(EpilogueVisitorTree.EpilogueTensors):
71         tDsPostAct: cute.Tensor
72         tDgPostAct: cute.Tensor
73         tRS_sPostAct: cute.Tensor
74         epi_tma_atom: cute.CopyAtom
75         tiled_copy_postact_r2s: cute.TiledCopy
76         tDsRowVec: cute.Tensor | None
77
78     @struct_utils.register_pytree_dataclass
79     @dataclass
80     class EpilogueTensorsLoop(EpilogueVisitorTree.EpilogueTensorsLoop):
81         tDsPostAct: cute.Tensor
82         tDgPostAct: cute.Tensor
83         tRS_rPostAct: cute.Tensor | None
84         tRS_sPostAct: cute.Tensor
85         epi_tma_atom: cute.CopyAtom
86         tiled_copy_postact_r2s: cute.TiledCopy
87         tDrRowVec_epi: cute.Tensor | None
88
89     @struct_utils.register_pytree_dataclass
90     @dataclass
91     class EpiloguePipelines(EpilogueVisitorTree.EpiloguePipelines):
92         pass

```

```

93
94 def __init__(
95     self,
96     acc_dtype: type[cute.Numeric],
97     post_act_dtype: type[cute.Numeric],
98     tile_shape_mnk: tuple[int, int, int],
99     buffer_align_bytes: int,
100 ) -> None:
101     super().__init__()
102     self.arch = 90
103     self.acc_dtype = acc_dtype
104     self.post_act_dtype = post_act_dtype
105     self.container_dtype = post_act_dtype
106     self.tile_shape_mnk = tile_shape_mnk
107     self.buffer_align_bytes = buffer_align_bytes
108
109 @cute.jit
110 def to_underlying_arguments(
111     self,
112     epi_tile: cute.Tile,
113     epi_stage: int,
114     epi_load_stage: int,
115     epi_args: EpilogueArguments,
116 ) -> EpilogueParams:
117
118     if cutlass.const_expr(epi_args.mPostAct is not None):
119         mPostAct = misc_utils.static_assert_is_Tensor(epi_args.mPostAct)
120         misc_utils.static_assert(get_dtype(mPostAct) is self.container_dtype)
121         (
122             epi_gmem_layout,
123             epi_smem_layout_staged,
124             epi_tma_atom,
125             epi_tma_tensor,
126         ) = epilogue_utils.prepare_tma(
127             tma_op="s2g",
128             epi_tile=epi_tile,
129             epi_stage=epi_stage,
130             epi_tensor=mPostAct,
131         )
132
133     if cutlass.const_expr(epi_args.mRowVec is not None):
134         misc_utils.static_assert(epi_args.mPostAct is not None)
135         mRowVec = misc_utils.static_assert_is_Tensor(epi_args.mRowVec)
136         mRowVec = layout_utils.assumed_align_stride(
137             mRowVec,
138             assumed_align=4,
139         )
140     else:
141         mRowVec = None
142
143     return self.EpilogueParams(
144         mPostAct=epi_tma_tensor,
145         mRowVec=mRowVec,
146         epi_tma_atom=epi_tma_atom,
147         epi_gmem_layout=epi_gmem_layout,
148         epi_smem_layout_staged=epi_smem_layout_staged,
149     )
150
151 @cute.jit
152 def prefetch_tma_descriptors(
153     self,
154     epi_params: EpilogueParams,
155 ) -> None:
156     cute.nvGPU.cpasync.prefetch_descriptor(epi_params.epi_tma_atom)
157
158 @cute.jit
159 def consumer_begin(
160     self,
161     tiled_copy_r2s: cute.TiledCopy,
162     tile_coord_mnk1: cute.Coord,
163     tid_x: cute.Int32,
164     tiled_mma: cute.TiledMma,
165     tRS_rD_layout: cute.Layout,
166     epi_tile: cute.Tile,
167     epi_num_threads: int,
168     epi_num_matrices: int,
169     epi_barrier: cutlass.pipeline.NamedBarrier,
170     epi_params: EpilogueParams,
171     epi_tensors_smem: EpilogueTensorsSMem,
172 ) -> EpilogueTensors:
173

```

```

174     tile_M = self.tile_shape_mnk[0]
175     tile_N = self.tile_shape_mnk[1]
176     m_idx, n_idx, _, batch_idx = tile_coord_mnk1
177     thr_copy_r2s = tiled_copy_r2s.get_slice(tidix)
178
179     # Side output (PostAct) TMA setup
180     mPostAct = misc_utils.static_assert_is_Tensor(epi_params.mPostAct)
181     sPostAct = misc_utils.static_assert_is_Tensor(epi_tensors_smem.sPostAct)
182     tiled_copy_postact_r2s, _, tRS_sPostAct = epilogue_utils.prepare_copy_r2s_sm90(
183         tiled_copy_r2s=tiled_copy_r2s,
184         tidix=tidix,
185         dst=sPostAct,
186         epi_layout=epi_params.epi_gmem_layout,
187         epi_dtype=self.container_dtype,
188         acc_dtype=self.acc_dtype,
189     )
190     gPostAct = mPostAct[None, None, batch_idx]
191     gPostAct = cute.local_tile(gPostAct, (tile_M, tile_N), (m_idx, n_idx))
192     gPostAct = cute.zipped_divide(gPostAct, epi_tile)
193
194     tDsPostAct, tDgPostAct = cute.nvGPU.cpasync.tma_partition(
195         atom=epi_params.epi_tma_atom,
196         cta_coord=0,
197         cta_layout=cute.make_layout(1),
198         smem_tensor=cute.group_modes(sPostAct, 0, cute.rank(sPostAct) - 1),
199         gmem_tensor=cute.group_modes(gPostAct, 0, cute.rank(gPostAct) - 1),
200     )
201
202     # RowVec cp.async load (per-N broadcast across M)
203     if cutlass.const_expr(epi_params.mRowVec is not None):
204         mRowVec = misc_utils.static_assert_is_Tensor(epi_params.mRowVec)
205         sRowVec = misc_utils.static_assert_is_Tensor(epi_tensors_smem.sRowVec)
206         mRowVec = mRowVec[batch_idx, None]
207         gRowVec = cute.local_tile(mRowVec, (tile_N, ), (n_idx, ))
208         cRowVec = cute.make_identity_tensor(tile_N)
209         limit_n = min(mRowVec.shape[0] - n_idx * tile_N, tile_N)
210         memory_utils.g2s_copy_1d(
211             src=gRowVec,
212             dst=sRowVec,
213             crd=cRowVec,
214             shape=(limit_n, ),
215             num_threads=epi_num_threads,
216             thread_index=tidix,
217         )
218         sRowVec_view_layout = cute.make_layout(
219             shape=(tile_M, tile_N),
220             stride=(0, 1),
221         )
222         sRowVec_view = cute.make_tensor(
223             iterator=sRowVec.iterator,
224             layout=sRowVec_view_layout,
225         )
226         tDsRowVec = thr_copy_r2s.partition_S(
227             cute.flat_divide(sRowVec_view, epi_tile)
228         )
229         cute.arch.cp_async_commit_group()
230         cute.arch.cp_async_wait_group(0)
231         epi_barrier.arrive_and_wait()
232     else:
233         tDsRowVec = None
234
235     return self.EpilogueTensors(
236         tDsPostAct=tDsPostAct,
237         tDgPostAct=tDgPostAct,
238         tRS_sPostAct=tRS_sPostAct,
239         epi_tma_atom=epi_params.epi_tma_atom,
240         tiled_copy_postact_r2s=tiled_copy_postact_r2s,
241         tDsRowVec=tDsRowVec,
242     )
243
244 @cute.jit
245 def consumer_end(
246     self,
247     tiled_copy_r2s: cute.TiledCopy,
248     tile_coord_mnk1: cute.Coord,
249     tidix: cute.Int32,
250     shape_mnk: cute.Shape,
251     epi_tile: cute.Tile,
252     epi_num_threads: int,
253     epi_barrier: cutlass.pipeline.NamedBarrier,
254     epi_params: EpilogueParams,

```

```

255     epi_tensors: EpilogueTensors,
256     epi_tensors_smem: EpilogueTensorsSMem,
257 ) -> None:
258     pass
259
260 @cute.jit
261 def consumer_begin_loop(
262     self,
263     epi_coord: cute.Coord,
264     epi_params: EpilogueParams,
265     epi_tensors: EpilogueTensors,
266     epi_pipelines: EpiloguePipelines,
267 ) -> tuple[EpilogueTensorsLoop, EpiloguePipelines]:
268
269     if cutlass.const_expr(epi_tensors.tDsRowVec is not None):
270         tDsRowVec = misc_utils.static_assert_is_Tensor(epi_tensors.tDsRowVec)
271         tDsRowVec_cur = cute.group_modes(tDsRowVec, 3, cute.rank(tDsRowVec))
272         tDsRowVec_cur = tDsRowVec_cur[None, None, None, epi_coord]
273         tDrRowVec_cvt = memory_utils.s2r_copy_1d(tDsRowVec_cur, dtype=self.acc_dtype)
274     else:
275         tDrRowVec_cvt = None
276
277     return (
278         self.EpilogueTensorsLoop(
279             tDsPostAct=epi_tensors.tDsPostAct,
280             tDgPostAct=epi_tensors.tDgPostAct,
281             tRS_rPostAct=None,
282             tRS_sPostAct=epi_tensors.tRS_sPostAct,
283             epi_tma_atom=epi_tensors.epi_tma_atom,
284             tiled_copy_postact_r2s=epi_tensors.tiled_copy_postact_r2s,
285             tDrRowVec_epi=tDrRowVec_cvt,
286         ),
287         self.EpiloguePipelines(),
288     )
289
290 @cute.jit
291 def consumer_visit(
292     self,
293     tRS_rD: cute.Tensor,
294     shape_mnk: cute.Shape,
295     epi_params: EpilogueParams,
296     epi_tensors_loop: EpilogueTensorsLoop,
297 ) -> EpilogueTensorsLoop:
298
299     tRS_rPostAct = creation_utils.allocate_tensor_like(
300         tensor=tRS_rD,
301         memspace="rmem",
302         smem_allocator=None,
303         dtype=self.acc_dtype,
304     )
305
306     if cutlass.const_expr(self.arch < 100):
307         if cutlass.const_expr(epi_tensors_loop.tDrRowVec_epi is not None):
308             tDrRowVec_epi = misc_utils.static_assert_is_Tensor(epi_tensors_loop.
309                 tDrRowVec_epi)
310             for i in cutlass.range_constexpr(cute.size(tRS_rPostAct)):
311                 tRS_rPostAct[i] = tRS_rD[i] * tDrRowVec_epi[i]
312             else:
313                 for i in cutlass.range_constexpr(cute.size(tRS_rPostAct)):
314                     tRS_rPostAct[i] = tRS_rD[i]
315             else:
316                 raise NotImplementedError
317
318     tRS_rPostAct = dtype_utils.convert(
319         tRS_rPostAct,
320         dtype=self.post_act_dtype,
321     )
322
323     return self.EpilogueTensorsLoop(
324         tDsPostAct=epi_tensors_loop.tDsPostAct,
325         tDgPostAct=epi_tensors_loop.tDgPostAct,
326         tRS_rPostAct=tRS_rPostAct,
327         tRS_sPostAct=epi_tensors_loop.tRS_sPostAct,
328         epi_tma_atom=epi_tensors_loop.epi_tma_atom,
329         tiled_copy_postact_r2s=epi_tensors_loop.tiled_copy_postact_r2s,
330         tDrRowVec_epi=epi_tensors_loop.tDrRowVec_epi,
331     )
332
333 @cute.jit
334 def consumer_smem_store(
335     self,
336     epi_coord: cute.Coord,

```

```

335     epi_buffer: cute.Int32,
336     epi_params: EpilogueParams,
337     epi_tensors_loop: EpilogueTensorsLoop,
338 ) -> None:
339     tiled_copy = epi_tensors_loop.tiled_copy_postact_r2s
340     tRS_rPostAct = misc_utils.static_assert_is_Tensor(epi_tensors_loop.tRS_rPostAct)
341     tRS_sPostAct = misc_utils.static_assert_is_Tensor(epi_tensors_loop.tRS_sPostAct)
342     src = tiled_copy.retile(tRS_rPostAct)
343     dst = tRS_sPostAct[None, None, None, epi_buffer]
344     cute.copy(atom=tiled_copy, src=src, dst=dst)
345
346 @cute.jit
347 def consumer_tma_store(
348     self,
349     epi_coord: cute.Coord,
350     epi_buffer: cute.Int32,
351     epi_params: EpilogueParams,
352     epi_tensors_loop: EpilogueTensorsLoop,
353 ) -> None:
354     atom = epi_tensors_loop.epi_tma_atom
355     tDsPostAct = misc_utils.static_assert_is_Tensor(epi_tensors_loop.tDsPostAct)
356     tDgPostAct = misc_utils.static_assert_is_Tensor(epi_tensors_loop.tDgPostAct)
357     src = tDsPostAct[None, epi_buffer]
358     dst = tDgPostAct[None, epi_coord]
359     cute.copy(atom=atom, src=src, dst=dst)
360
361 @cute.jit
362 def get_smem_struct(
363     self,
364     epi_load_stage: int,
365     epi_num_threads: int,
366     epi_params: EpilogueParams,
367 ) -> type[EpilogueSharedStorage]:
368
369     if cutlass.const_expr(epi_params.mPostAct is not None):
370         post_act_smem_size = cute.cosize(epi_params.epi_smem_layout_staged)
371     else:
372         post_act_smem_size = 0
373
374     if cutlass.const_expr(epi_params.mRowVec is not None):
375         mRowVec = misc_utils.static_assert_is_Tensor(epi_params.mRowVec)
376         row_vec_dtype = get_dtype(mRowVec)
377         row_vec_smem_size = epilogue_utils.get_smem_size_vector(
378             mTensor=mRowVec,
379             epi_tile=self.tile_shape_mnk[1],
380             epi_num_threads=epi_num_threads,
381         )
382     else:
383         row_vec_dtype = cute.Float32
384         row_vec_smem_size = 0
385
386     @cute.struct
387     class SharedStorage(EpilogueSharedStorage):
388         sPostAct: cute.struct.Align[cute.struct.MemRange[self.container_dtype,
389             post_act_smem_size], self.buffer_align_bytes]
390         sRowVec: cute.struct.Align[cute.struct.MemRange[row_vec_dtype,
391             row_vec_smem_size], 16]
392
393     return SharedStorage
394
395 @cute.jit
396 def get_smem_tensors(
397     self,
398     storage: EpilogueSharedStorage,
399     epi_num_threads: int,
400     epi_params: EpilogueParams,
401 ) -> EpilogueTensorsSMem:
402
403     if cutlass.const_expr(epi_params.mPostAct is not None):
404         sPostAct = storage.sPostAct.get_tensor(
405             epi_params.epi_smem_layout_staged.outer,
406             swizzle=epi_params.epi_smem_layout_staged.inner,
407         )
408     else:
409         sPostAct = None
410
411     if cutlass.const_expr(epi_params.mRowVec is not None):
412         sRowVec_layout = cute.make_layout(self.tile_shape_mnk[1])
413         sRowVec = storage.sRowVec.get_tensor(sRowVec_layout)
414     else:
415         sRowVec = None

```

```

414         return self.EpilogueTensorsSMem(
415             sPostAct=sPostAct,
416             sRowVec=sRowVec,
417         )
418     )
419
420     @cute.jit
421     def get_smem_bytes_per_stage(
422         self,
423         epi_tile: cute.Tile,
424         epi_num_threads: int,
425         epi_args: EpilogueArguments,
426     ) -> tuple[int, int, int]:
427         epi_smem_bytes_fixed = 0
428         epi_smem_bytes_per_stage_cst = 0
429         epi_smem_bytes_per_stage_pld = 0
430
431         if cutlass.const_expr(epi_args.mPostAct is not None):
432             mPostAct = misc_utils.static_assert_is_Tensor(epi_args.mPostAct)
433             misc_utils.static_assert(get_dtype(mPostAct) is self.container_dtype)
434             epi_smem_bytes_per_stage_cst = epi_smem_bytes_per_stage_cst + (
435                 epilogue_utils.get_epi_smem_bytes_per_stage_matrix(
436                     mTensor=mPostAct,
437                     epi_tile=epi_tile,
438                 )
439             )
440
441         if cutlass.const_expr(epi_args.mRowVec is not None):
442             mRowVec = misc_utils.static_assert_is_Tensor(epi_args.mRowVec)
443             epi_smem_bytes_fixed = epi_smem_bytes_fixed + (
444                 epilogue_utils.get_epi_smem_bytes_per_stage_fixed_vector(
445                     mTensor=mRowVec,
446                     epi_tile=self.tile_shape_mnk[1],
447                     epi_num_threads=epi_num_threads,
448                 )
449             )
450
451         return (
452             epi_smem_bytes_fixed,
453             epi_smem_bytes_per_stage_cst,
454             epi_smem_bytes_per_stage_pld,
455         )
456
457     def prepare_epilogue(
458         shape_mnk1: tuple[int, int, int, int],
459         tile_shape_mn: tuple[int, int],
460         C: torch.Tensor,
461         S: torch.Tensor,
462         W: torch.Tensor,
463         O: torch.Tensor,
464     ) -> tuple[
465         Callable[..., EpilogueVisitorTree],
466         EpilogueVisitorTree.EpilogueArguments,
467         dict,
468         tuple,
469     ]:
470         """Prepare epilogue for GEMM with residual, partial mean-of-squares, and
471         fused per-N RMSNorm-weight scaling - mirrors trainstation's 'gemm_partial_rms_fwd'.
472
473         Composes three EVT visitors:
474         1. EVTResidual:  $D = acc + C$ 
475         2. EVTColBlockReductionStore:  $S[m, nb] = \text{mean}(D[m, nb*bs:(nb+1)*bs]^{-2})$ 
476         3. EVTRowVecMulPostAct (local):  $O[m, n] = D[m, n] * W[n]$ , side output via TMA
477
478         The partial sum-of-squares is computed on the *unscaled* D, so a downstream
479         rstd reduction sees the GEMM output before W is applied. trs_rD is preserved
480         so the main D output is also unscaled.
481
482         Args:
483             shape_mnk1: Problem shape (M, N, K, L) where L is batch dimension.
484             tile_shape_mn: CTA tile shape (tile_M, tile_N).
485             C: Residual matrix of shape (M, N).
486             S: Output for partial mean-of-squares of shape (M, num_blocks) in fp32.
487             W: RMSNorm weight of shape (N,), broadcast across M.
488             O: Output of shape (M, N) for  $D * W$ .
489
490         Returns:
491             Tuple of (epi_cls, epi_args, epi_outs, epi_keys).
492         """
493         M, N, K, L = shape_mnk1

```

```

495
496 epi_dtype = torch2cute_dtype_map[C.dtype]
497 post_act_dtype = torch2cute_dtype_map[0.dtype]
498
499 epi_cls = lambda acc_dtype, tile_shape_mnk, buffer_align_bytes: EVTList([
500     EVTResidual(
501         acc_dtype=acc_dtype,
502         epi_dtype=epi_dtype,
503         tile_shape_mnk=tile_shape_mnk,
504         buffer_align_bytes=buffer_align_bytes,
505     ),
506     EVTColBlockReductionStore(
507         reduction_op=_create_mean_sq_reduction_op(
508             element_type=acc_dtype,
509             inv_block_size=1.0 / tile_shape_mnk[1],
510         ),
511         tile_shape_mnk=tile_shape_mnk,
512     ),
513     EVTRowVecMulPostAct(
514         acc_dtype=acc_dtype,
515         post_act_dtype=post_act_dtype,
516         tile_shape_mnk=tile_shape_mnk,
517         buffer_align_bytes=buffer_align_bytes,
518     ),
519 ])
520
521 epi_args = EVTList.EpilogueArguments([
522     EVTResidual.EpilogueArguments(
523         mMatrix=C,
524     ),
525     EVTColBlockReductionStore.EpilogueArguments(
526         mColVec=S,
527     ),
528     EVTRowVecMulPostAct.EpilogueArguments(
529         mPostAct=0,
530         mRowVec=W,
531     ),
532 ])
533
534 epi_keys = (
535     C.dtype,
536     S.dtype,
537     W.dtype,
538     0.dtype,
539     EVTResidual,
540     EVTColBlockReductionStore,
541     EVTRowVecMulPostAct,
542 )
543
544 epi_outs = {}
545
546 return epi_cls, epi_args, epi_outs, epi_keys

```

Listing 2: Kernel Example.

C Experiments

C.1 List of Kernels

We summarize the kernels implemented in CODA. Each kernel is a GEMM followed by an epilogue program.

C.1.1 Basic Epilogue Kernels

We first list three basic GEMM-plus-epilogue kernels. These are useful for isolating individual epilogue primitives, although they are not always used directly in the Transformer forward pass.

Kernel 1: GEMM with RoPE. This kernel applies RoPE [15] to pairs of adjacent features in the GEMM output:

$$\begin{aligned}
 D &= AB, \\
 O &= \text{RoPE}(D).
 \end{aligned}$$

Kernel 2: GEMM with SwiGLU. This kernel applies a fused SwiGLU activation to an interleaved GEMM output:

$$\begin{aligned} D &= AB, \\ [G, U] &= \text{interleavedSplit}(D), \\ O &= \text{silu}(G) \odot U. \end{aligned}$$

Kernel 3: GEMM with partial cross-entropy. This kernel computes logits, selects the target logit, and emits block-wise log-sum-exp statistics for the cross-entropy loss:

$$\begin{aligned} Z &= AB, \\ z_{\text{tgt}} &= Z[\mathbf{y}], \\ \hat{l}_{\text{lse}} &= \text{reduceTile}_{\log \sum \exp}(Z). \end{aligned}$$

C.1.2 Forward-Pass Kernels

The following kernels implement the reparameterized Transformer forward pass. They compose the basic epilogue primitives with RMSNorm scaling, residual updates, and partial reductions.

Kernel 4: GEMM with residual, partial RMSNorm, and weight scaling. This kernel implements the first stage of the GEMM–Residual–RMSNorm–GEMM pattern. It forms the residual-updated activation, emits partial RMS statistics, and applies the RMSNorm weight:

$$\begin{aligned} D &= AB + C, \\ \hat{r} &= \text{reduceTile}_{\text{cols}}(D \odot D), \\ O &= D \odot \gamma. \end{aligned}$$

Kernel 5: GEMM with RMSNorm scaling. This kernel consumes a precomputed row-wise normalization factor and applies it in the GEMM epilogue:

$$\begin{aligned} D &= AB, \\ O &= D \odot r. \end{aligned}$$

Kernel 6: GEMM with RMSNorm and SwiGLU. This kernel composes row-wise RMSNorm scaling with SwiGLU, corresponding to the MLP gate/up projection:

$$\begin{aligned} D &= AB, \\ D' &= D \odot r, \\ [G, U] &= \text{interleavedSplit}(D'), \\ O &= \text{silu}(G) \odot U. \end{aligned}$$

Kernel 7: GEMM with RMSNorm and RoPE. This kernel composes row-wise RMSNorm scaling with RoPE, corresponding to QKV projection followed by rotary positional embedding:

$$\begin{aligned} D &= AB, \\ D' &= D \odot r, \\ O &= \text{RoPE}(D'). \end{aligned}$$

Kernel 8: GEMM with RMSNorm and partial cross-entropy. This kernel adds row-wise RMSNorm scaling before target-logit selection and partial log-sum-exp reduction, corresponding to the language-modeling head:

$$\begin{aligned} Z &= (AB) \odot r, \\ z_{\text{tgt}} &= Z[\mathbf{y}], \\ \hat{l}_{\text{lse}} &= \text{reduceTile}_{\log \sum \exp}(Z). \end{aligned}$$

C.1.3 Backward-Pass Kernels

Finally, we list the backward kernels. These kernels mirror the forward structure: each performs a GEMM, applies the local backward rule in the epilogue, and emits partial reductions needed by neighboring RMSNorm backward computations.

Kernel 9: GEMM with residual and RMSNorm backward. This kernel implements the local part of RMSNorm backward. Let \mathbf{C} denote the RMSNorm input, \mathbf{r} the row-wise inverse RMS factor, γ the RMSNorm weight, and $\mathbf{z}_{\Delta z}$ the row-wise RMSNorm backward statistic:

$$\begin{aligned} \mathbf{D} &= \mathbf{A}\mathbf{B}^\top, \\ \mathbf{C}_{\text{norm}} &= \mathbf{C} \odot \mathbf{r}, \\ \mathbf{O}_{\text{out}} &= \mathbf{O}_{\text{in}} + (\mathbf{D} \odot \gamma - \mathbf{C}_{\text{norm}} \odot \mathbf{z}_{\Delta z}) \odot \mathbf{r}, \\ \mathbf{C}_{\text{out}} &= \mathbf{C}_{\text{norm}} \odot \gamma, \\ \widehat{\nabla_{\gamma} \mathcal{L}} &= \text{reduceTile}_{\text{rows}}(\mathbf{D} \odot \mathbf{C}_{\text{norm}}). \end{aligned}$$

Kernel 10: GEMM with SwiGLU backward. This kernel computes the backward pass of a fused SwiGLU epilogue and emits the row-wise statistic needed by the preceding RMSNorm backward. Let \mathbf{Z} be the saved interleaved pre-activation tensor:

$$\begin{aligned} \mathbf{D} &= \mathbf{A}\mathbf{B}^\top, \\ [\mathbf{G}, \mathbf{U}] &= \text{interleavedSplit}(\mathbf{Z}), \\ \mathbf{O} &= \text{silu}(\mathbf{G}) \odot \mathbf{U}, \\ \nabla_{\mathbf{U}} \mathcal{L} &= \mathbf{D} \odot \text{silu}(\mathbf{G}), \\ \nabla_{\mathbf{G}} \mathcal{L} &= \mathbf{D} \odot \mathbf{U} \odot (\sigma(\mathbf{G}) + \text{silu}(\mathbf{G}) \odot (1 - \sigma(\mathbf{G}))), \\ \nabla_{\mathbf{Z}} \mathcal{L} &= \text{interleavedConcat}(\nabla_{\mathbf{G}} \mathcal{L}, \nabla_{\mathbf{U}} \mathcal{L}), \\ \widehat{\mathbf{z}_{\Delta z}} &= \text{reduceTile}_{\text{cols}}(\mathbf{G} \odot \nabla_{\mathbf{G}} \mathcal{L} + \mathbf{U} \odot \nabla_{\mathbf{U}} \mathcal{L}). \end{aligned}$$

C.2 Setup Details

Experiments are conducted using a single H100 GPU. We use the following package versions.

1. PyTorch 2.10.0
2. CuTeDSL 4.4.2
3. Liger Kernels 0.8.0
4. FlashInfer 0.6.10.post1
5. QuACK Kernels 0.4.1