

# His2Trans: A Skeleton-First Framework for Self-Evolving C-to-Rust Translation with Historical Retrieval

SHENGBO WANG, Sun Yat-sen University, China

MINGWEI LIU\*, Sun Yat-sen University, China

GUANGSHENG OU, Sun Yat-sen University, China

YUWEN CHEN, Sun Yat-sen University, China

ZIKE LI, Sun Yat-sen University, China

YANLIN WANG, Sun Yat-sen University, China

ZIBIN ZHENG, Sun Yat-sen University, China

Automated C-to-Rust migration encounters systemic obstacles when scaling from code snippets to industrial projects, mainly because build context is often unavailable (“dependency hell”) and domain-specific evolutionary knowledge is missing. As a result, current LLM-based methods frequently cannot reconstruct precise type definitions under complex build systems or infer idiomatic API correspondences, which in turn leads to hallucinated dependencies and unproductive repair loops. To tackle these issues, we introduce His2TRANS, a framework that combines a deterministic, build-aware skeleton with self-evolving knowledge extraction to support stable, incremental migration. On the structural side, His2TRANS performs build tracing to create a compilable Project-Level Skeleton Graph, providing a strictly typed environment that separates global verification from local logic generation. On the cognitive side, it derives fine-grained API and code-fragment rules from historical migration traces and uses a Retrieval-Augmented Generation (RAG) system to steer the LLM toward idiomatic interface reuse. Experiments on industrial OpenHarmony modules show that His2TRANS reaches a 97.51% incremental compilation pass rate, effectively fixing build failures where baselines struggle. On general-purpose benchmarks, it reduces the unsafe code ratio by 25.23 percentage points compared with C2Rust while also lowering warning counts, although cross-domain functional correctness remains challenging. Finally, knowledge accumulation studies demonstrate the framework’s evolutionary behavior: by continuously integrating verified patterns, His2TRANS cuts repair overhead on unseen tasks by about 60%.

CCS Concepts: • **Software and its engineering** → **Software evolution; Automatic programming.**

Additional Key Words and Phrases: C-to-Rust, LLM, RAG, incremental migration, compiler feedback

## 1 Introduction

Memory-safety issues in legacy C codebases remain a primary source of security vulnerabilities. Industry reports from major technology companies, such as Microsoft and Google, indicate that approximately 70% of security vulnerabilities stem from memory-safety errors [19, 27]. Rust has emerged as a robust solution to this persistent issue, offering memory-safety guarantees through its ownership and borrowing models without sacrificing low-level control or performance [13, 14]. Consequently, migrating legacy C systems to Rust has become a widespread industry trend [22, 28]. However, manual migration is labor-intensive, error-prone, and prohibitively expensive for large-scale systems, creating an urgent demand for automated translation tools [7, 25].

The field of automated C-to-Rust translation has evolved from rule-based systems to approaches based on Large Language Models (LLMs). Traditional rule-based transpilers, such as C2Rust [7],

\*Corresponding Author

---

Authors’ Contact Information: Shengbo Wang, puppytagge@gmail.com, Sun Yat-sen University, Guangzhou, China; Mingwei Liu, liumw26@mail.sysu.edu.cn, Sun Yat-sen University, Guangzhou, China; Guangsheng Ou, ougsh3@mail2.sysu.edu.cn, Sun Yat-sen University, Guangzhou, China; Yuwen Chen, chenyw95@mail2.sysu.edu.cn, Sun Yat-sen University, Guangzhou, China; Zike Li, lizk8@mail2.sysu.edu.cn, Sun Yat-sen University, Guangzhou, China; Yanlin Wang, wangylin36@mail.sysu.edu.cn, Sun Yat-sen University, Guangzhou, China; Zibin Zheng, zhizbin@mail.sysu.edu.cn, Sun Yat-sen University, Guangzhou, China.

prioritize compilation guarantees but generate non-idiomatic code that relies heavily on unsafe blocks, effectively carrying C’s memory risks into Rust syntax [4]. With the advent of Generative AI, mainstream solutions have shifted from rule-based methods [7, 35] to LLM-based approaches. However, current LLM-based research is constrained by context window limitations and generation instability. As input length increases, the probability of hallucinations and syntax errors rises significantly [12]. Consequently, most existing works focus on function-level translation [21, 37], typically evaluating performance only on small-scale algorithms or competitive programming datasets rather than complex software systems.

Furthermore, industrial migration is rarely a one-time total rewrite; it is typically a gradual process where C and Rust coexist. An effective translation system must maximize the reuse of migrated Rust APIs while maintaining compatibility with untranslated C code, ensuring that new code integrates seamlessly into the evolving ecosystem. However, existing frameworks treat translation as an isolated task, failing to address the systemic challenges inherent in this evolutionary context:

- **Missing Build Context and “Dependency Hell”:** Large projects rely on complex build systems (e.g., Makefiles, CMake), where macro definitions and conditional compilation options directly determine type availability. Simple isolated translation loses this context, leading LLMs to hallucinate definitions.
- **The Gap in Domain-Specific Evolutionary Knowledge:** General-purpose LLMs excel at standard library calls (libc) but fail when encountering domain-specific or private APIs (e.g., internal kernel drivers) [16, 40]. In a gradual migration, new code must reuse previously migrated Rust APIs. However, without access to the project’s **historical migration traces** or API mapping rules, LLMs cannot infer these idiomatic correspondences, leading to fabricated calls and integration failures [16].
- **Inefficient Repair Loops and Unscalable Costs:** Existing frameworks often mishandle dependencies, triggering cascading compilation errors. This causes the repair loop to diverge, rendering automated migration of large-scale projects economically infeasible [40].

To address these challenges, we propose **His2Trans**, a framework designed to facilitate evolving C-to-Rust translation by synergizing multi-level knowledge extraction with a compilable skeleton. Unlike probabilistic approaches, our method operates on two dimensions to systematically resolve the bottlenecks. First, regarding the structural dimension, we utilize build system tracing to construct a compilable Project-Level Skeleton Graph, which explicitly resolves missing build contexts by enforcing a strictly typed environment. Second, regarding the knowledge dimension, we mine historical migration projects to extract fine-grained rules; this bridges the evolutionary knowledge gap, guiding the LLM to reuse domain-specific APIs consistent with historical patterns. Ultimately, by decoupling structural verification from logic generation, this skeleton-driven approach isolates cascading errors, resolving the bottleneck of unscalable repair costs.

To situate our work within the existing landscape, Table 1 contrasts the design philosophies of His2Trans against prior paradigms. While rule-based methods often compromise safety by relying on unsafe blocks, and existing LLM-based approaches face challenges with probabilistic context inference, His2Trans introduces a deterministic, build-aware architecture. Crucially, we implement two fundamental shifts: (1) we transition the context source from speculative static analysis to concrete Build Traces, establishing a Type-Consistent Skeleton that mitigates “dependency hell”; (2) we replace static prompt engineering with accumulable multi-level knowledge, enabling a **self-evolving** workflow that progressively improves through historical data mining, which represents a capability absent in prior one-off translation methods.

Experimental results on real-world industrial projects demonstrate that His2Trans achieves a strong incremental compilation pass rate of 97.51%, substantially outperforming baselines that struggle under missing build contexts. To assess how far the mined knowledge transfers beyond the

Table 1. Comparison of Design Philosophies: His2Trans vs. Existing C-to-Rust Paradigms

Paradigm	Representative Methods	Target Scope	Context Source	Structural Guarantee	Knowledge Source
Rule-based	C2Rust [7]	Project	Local AST	None (Relies on unsafe)	Hard-coded Rules
Unit-Level LLM	RustFlow [38], SPECTRA [21], SafeTrans [6], C2RustTV [39], VERT [32]	Snippet / Function	Multimodal Spec / IR	I/O Equivalence	LLM Internal Knowledge + Few-shot
Project-Level LLM	EvoC2Rust [29], PTRMAPPER [34], RustMap [1], LLMigrate [17], Tymcrat [10]	Full Project / Module	Global Static Analysis	Global Consistency / Compilable Skeleton	Context from Static Analysis
Industrial Project-Level LLM	His2TRANS (Ours)	General & Industrial Projects	Build Trace (Concrete Dependencies)	Type-Consistent Skeleton (Type-Truth)	Accumulable Knowledge (Self-Evolving RAG)

source domain, we further evaluated the framework on general-purpose benchmarks. The results show that His2Trans can still substantially reduce the unsafe code ratio (by 25.23 percentage points compared with C2Rust) and improve code cleanliness, although its cross-domain gains are more pronounced in safety and maintainability than in end-to-end functional performance. Crucially, our knowledge accumulation experiments confirm the system’s evolutionary capability: by continuously integrating verified translation pairs, His2TRANS reduces the repair cost for unseen modules by approximately **60%**, proving that the framework becomes more efficient as it evolves.

This paper makes the following contributions:

- **A Self-Evolving Knowledge Extraction Framework:** We propose a RAG system mining API- and Fragment-Level rules from historical data. This creates an accumulable knowledge base that facilitates interface reuse and progressively enhances efficiency through verification feedback.
- **A Build-Aware Incremental Architecture:** We introduce a skeleton-based strategy utilizing build tracing to enforce a strictly typed environment. Decoupling structural verification from logic generation resolves “dependency hell” and isolates errors at the function level.
- **Extensive Evaluation:** His2TRANS achieves a 97.51% compilation pass rate in industrial settings, and on standard benchmarks it exhibits partial cross-domain transferability. Furthermore, knowledge accumulation reduces repair overhead by ~60% on unseen tasks, validating the framework’s evolutionary capability.

## 2 Methodology

This section details the overall framework of His2TRANS. As illustrated in Figure 1, His2TRANS operates in three stages: (1) **Knowledge Base Construction** mines historical mapping rules to facilitate precise retrieval; (2) **Rust Skeleton Construction** employs static analysis and build trace to establish a strictly typed project structure and dependency graph; and (3) **Incremental Rust Function Body Translation** generates function logic bottom-up based on the topological order, achieving automated project-wide migration.

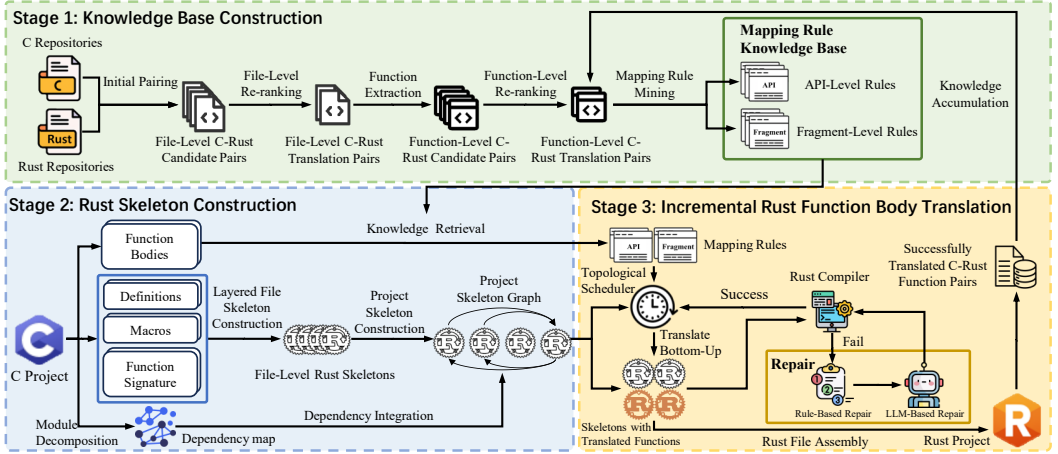

Fig. 1. Overview of the C-to-Rust translation framework.

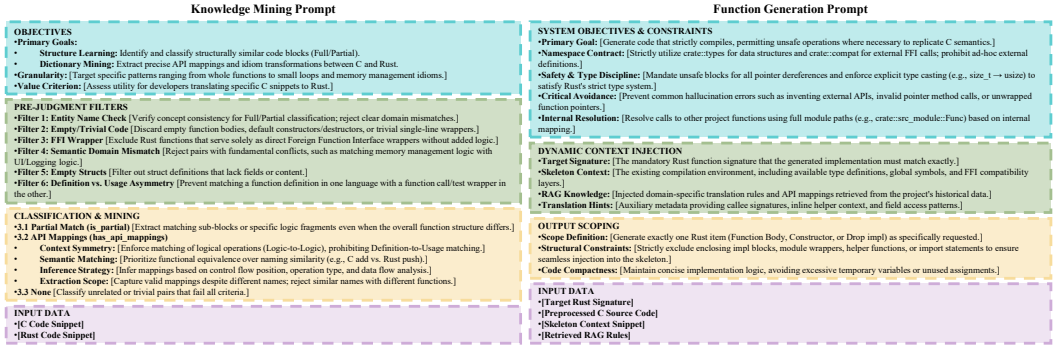

Fig. 2. Prompt templates utilized for knowledge mining (Left) and function generation (Right).

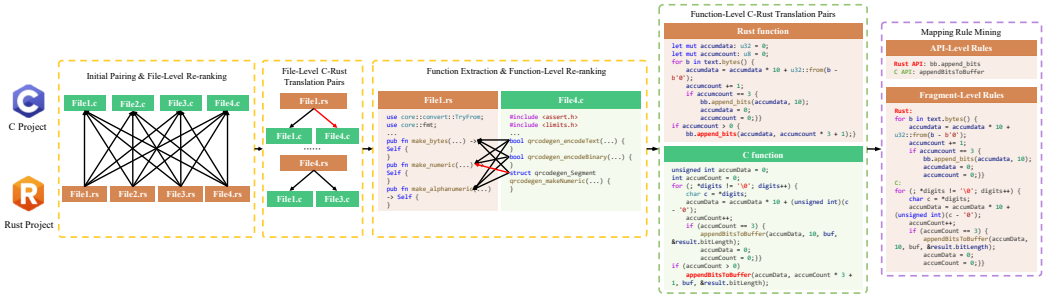

Fig. 3. Workflow of Knowledge Base Construction. The pipeline executes a coarse-to-fine mining process: File-Level Pairing → Function-Level Re-ranking → Rule Extraction (API &amp; Fragment).

## 2.1 Knowledge Base Construction

This phase aims to extract implicit translation knowledge from historical codebases into a structured Mapping Rule Knowledge Base. As illustrated in Figure 3, we adopt a coarse-to-fine mining strategy to progressively filter noise and extract precise patterns. The workflow proceeds in three stages: first, File-Level Pairing narrows down the search space by identifying high-confidence file correspondences from raw repositories; next, Function-Level Alignment performs semantic matching to

pinpoint functionally equivalent C-Rust function pairs within these files; finally, Mapping Rule Mining analyzes these aligned pairs to extract fine-grained API-Level Rules and Fragment-Level Rules, which serve as the reference context for subsequent generation.

**2.1.1 Data Collection and Initial Pairing.** This stage extracts File-Level Candidate Pairs from repositories using two strategies tailored to project evolution characteristics. For the *General Case* (where evolution history is absent), we adopt a global search strategy based on the Cartesian product of all C and Rust files, creating a complete search space to ensure full recall. Conversely, for the *Co-evolution Case*, where C and Rust co-evolve within the same codebase or possess explicit migration records, we leverage Historical Migration Traces. By applying heuristic filtering rules to Git metadata (refer to Table 2), we identify high-confidence pairs based on signals such as simultaneous modifications or explicit migration keywords. This targeted approach significantly prunes the search space, offering superior efficiency compared to the global search.

Table 2. Heuristic Rules for Mining File-level C-to-Rust Translation Pairs

Category	Dimension	Strategy & Rationale
Git History (Dynamic)	Synchronous (Same Commit)	<p><b>Commit Message Keyword Matching:</b> Detects explicit migration intent via keywords (e.g., “rewrite”, “port”) in commit messages.</p> <p><b>Build Config Switch:</b> Identifies commits that remove C files and add Rust files within the same build target definition (e.g., Makefile).</p> <p><b>Interface Migration:</b> Captures logic replacement where C function calls are substituted by Rust equivalents in caller code.</p> <p><b>Code Churn Balance:</b> Matches the magnitude of deleted C lines with added Rust lines using <code>numstat</code> to find structural correspondence.</p>
	Asynchronous (History Window)	<p><b>Sequential Re-implementation:</b> Links a C file deletion to a subsequent Rust file creation within a 365-day window (“Delete-then-Create” pattern).</p> <p><b>Evolutionary Coupling:</b> Identifies file pairs that are frequently modified together over time, implying logical dependency.</p> <p><b>Developer Identity:</b> Prioritizes pairs where the Rust author matches the original C maintainer (or recent contributor).</p>
Codebase Snapshot (Static)	Spatial	<p><b>Module Colocation:</b> Scans build systems to find C and Rust files co-existing in the same module/target, suggesting functional relevance.</p>
	Semantic	<p><b>Key Token Overlap:</b> Calculates the intersection of unique identifiers (constants, error codes). Pairs with <math>\geq 3</math> matches are retained.</p> <p><b>Shared Literals:</b> Matches long string literals (<math>&gt; 5</math> chars) such as log messages or error prompts identical in both files.</p>

**2.1.2 Multi-Stage Filtering and Re-ranking.** We implement a cascading filtering mechanism to refine coarse candidates into semantically equivalent translation pairs. At the file level, we first employ BM25 to retrieve the top-20 candidates based on lexical overlap (e.g., identifiers). We then apply the code-optimized `jina-reranker-v3` [30] to capture deep semantic alignment, isolating the top-5 high-confidence File-Level Translation Pairs. At the function level, we decompose these file pairs and generate a Cartesian product of their internal C and Rust functions. By re-applying `jina-reranker-v3` to rank these combinations, we extract the top-5 Function-Level Translation Pairs, completing the transition from coarse file matching to precise granular alignment.

**2.1.3 Mapping Rule Mining and Knowledge Base Formulation.** After acquiring high-confidence function-level translation pairs, the framework executes mapping rule mining. We employ LLMs to mine generalizable patterns from the aligned function pairs (see Figure 2). This process extracts two key categories of knowledge: (1) API-Level Rules, which map C library calls to idiomatic Rust expressions; and (2) Fragment-Level Rules, which capture syntactic transformations of algorithmic

logic. These rules populate the Knowledge Base, which additionally supports a “Human-in-the-loop” mechanism, enabling experts to verify mined rules or inject manual priors to mitigate extraction biases.

## 2.2 Rust Skeleton Construction

This stage reconstructs the C source into a structured Project-Level Skeleton Graph to serve as the static foundation for migration. The process operates in three steps: (1) mapping the physical directory hierarchy to establish the module structure; (2) employing hierarchical synthesis to populate type definitions and interface contracts; and (3) resolving cross-module references to form a statically consistent Skeleton, providing precise structural support for incremental translation.

*2.2.1 Project-Level Skeleton Synthesis.* We employ a direct mapping strategy to construct the Project-Level Skeleton, mirroring the C directory hierarchy into a Rust module tree. The framework traverses the source tree, converting subdirectories into parent modules and mapping individual C source files one-to-one to independent Rust modules. During this process, filenames are normalized to snake\_case to comply with Rust syntax, while a mapping table is maintained to ensure code traceability. This establishes a structural container for the subsequent injection of definitions and signatures.

*2.2.2 Layered File-Level Skeleton Synthesis.* Following the structural mapping, we populate the modules with static symbol contracts via a layered synthesis strategy. First, we utilize Build Tracing to preprocess sources and extract strict type definitions (structs, unions, enums), ensuring memory layout consistency without relying on probabilistic inference. Second, we resolve global states by encapsulating file-local statics as module-private storage and mapping global variables to public mutable resources. Finally, we generate Rust function signatures that preserve C calling conventions, initializing bodies with `unimplemented!`. This results in a statically complete Skeleton capable of passing compilation checks.

*2.2.3 Project-Level Skeleton Graph Generation.* Although isolated module skeletons are internally type-consistent, they do not yet constitute a complete software system. To integrate isolated modules into a cohesive system, we first establish a Global Symbol Index by analyzing header inclusions and external calls. Based on this index, we transform implicit C linking dependencies into explicit Rust reference paths (e.g., `use crate::...`) and inject necessary visibility modifiers to bridge call chains. This construction yields the Project-Level Skeleton Graph, where nodes represent typed modules and edges denote data dependencies. Crucially, this topology dictates the execution order, providing a precise scheduling basis for the subsequent bottom-up incremental translation.

## 2.3 Incremental Rust Function Body Translation

Leveraging the static foundation, this stage executes the incremental generation and verification of function bodies (Figure 4). The process operates within a strictly typed context composed of the Shared Layer (consolidating ABI-critical definitions) and the Module Skeleton (providing typed signatures initialized with `unimplemented!` and file-scope statics). Guided by these constraints, the LLM generates function implementations that strictly adhere to the global memory layout defined in the shared context.

*2.3.1 Dependency-Aware Topological Scheduling.* Based on the Project-Level Skeleton Graph constructed in the preceding stage, this framework implements a dependency-aware scheduling strategy. To ensure contextual integrity, the framework employs a Topological Scheduler that performs a topological sort on the Project-Level Skeleton Graph to resolve call dependencies. This transforms the graph into a linear, bottom-up execution sequence. The scheduler prioritizes “leaf

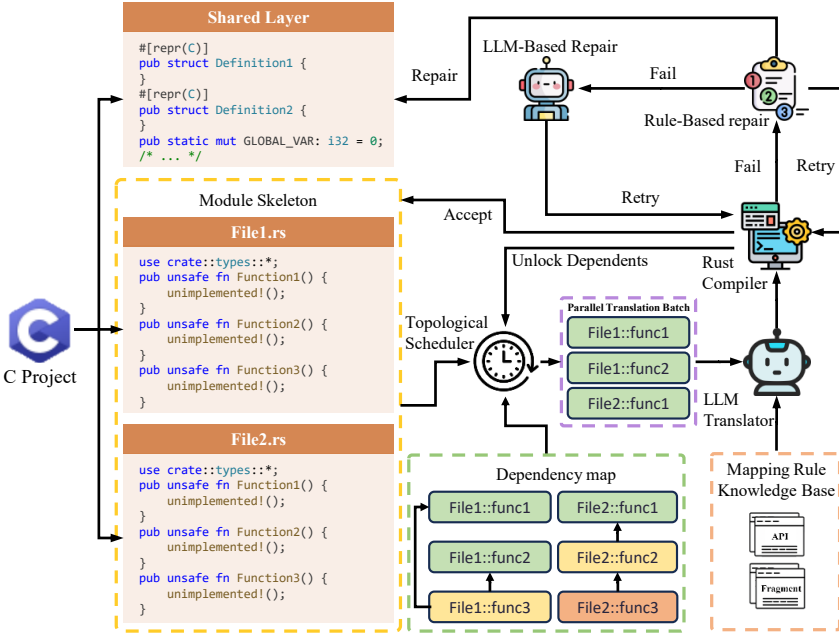

Fig. 4. Workflow of Incremental Function Translation. The Topological Scheduler dispatches parallel tasks based on the strictly typed Shared Layer and Module Skeleton, followed by a hybrid Rule/LLM-Based repair loop.

nodes”—functions whose dependencies are fully resolved—and groups independent tasks into a Parallel Translation Batch for concurrent processing. This mechanism guarantees that higher-level functions are processed only after their dependencies are verified, ensuring the LLM accesses accurate semantic context while strictly adhering to the Rust build order.

**2.3.2 Function Translation.** Upon task scheduling, we execute Context Retrieval to construct a strict “Compilation Context.” This involves loading the target C code and extracting the corresponding Rust signatures, global type definitions, and external interfaces from the Skeleton. This context enforces global type constraints, preventing errors typical of isolated translation.

To augment this structural context, we employ a RAG phase using the coarse-to-fine strategy (see Section 2.1). We retrieve the top- $k$  similar pairs from the Knowledge Base and extract their associated API-Level Rules and Fragment-Level Rules. The framework synthesizes these historical rules with the Compilation Context to construct a dual-source prompt (Figure 2). This design injects mined API-Level rules and Fragment-Level rules as specific reference examples, while simultaneously enforcing strict syntactic constraints to regulate the model’s coding behavior.

Guided by this prompt, the LLM generates function bodies that strictly adhere to project dependencies, mitigating hallucinations. The generated implementation is then populated into the Skeleton, completing the migration unit.

**2.3.3 Compiler-Feedback Iterative Repair.** To guarantee robustness, we implement a closed-loop Compiler-Feedback Iterative Repair mechanism. Immediately post-generation, the framework triggers verification to capture errors (e.g., ownership violations) early, acting as a quality gate to prevent downstream propagation. Once a compilation error is detected, the right side of Figure 4 illustrates the repair mechanism, a prioritized strategy is invoked: first, Rule-Based Repair targets deterministic patterns such as omitted type conversions; if unresolved, the system escalates to

LLM-Based Repair, injecting compiler error messages as feedback to guide deep semantic fixes. Should the repair limit be exhausted, the system executes a Fallback to C2Rust-generated unsafe code to ensure compilation integrity and functional correctness. Finally, successful verification updates the Skeleton Graph, triggering the “Unlock Dependents” action to advance the scheduler.

*2.3.4 Knowledge Accumulation.* As incremental translation progresses, the framework extracts Rust functions that have passed compilation verification, along with their source C functions, as high-quality translation pairs. Subsequently, this empirically verified data is fed back into the mapping rule mining module to expand API-Level Rules and Fragment-Level Rules within the knowledge base. This closed-loop feedback mechanism enables self-enhancement of the framework by continuously incorporating verified translation pairs into the knowledge base, thereby providing reusable priors for subsequent translation and repair.

### 3 Experimental Setup

#### 3.1 Experimental Configuration

Experiments were conducted on a server with dual Intel Xeon Gold 6430 CPUs, 503 GiB RAM, and four NVIDIA RTX 5880 Ada GPUs, running Ubuntu 22.04. We used Clang 14.0.0, Rust 1.94.0-nightly, and Python 3.13.5.

For LLMs, we employed Qwen2.5-Coder-32B for offline knowledge extraction and DeepSeek-V3.2/Claude-3.5-Sonnet for translation/repair (Temp=0.0). We configured inference with a temperature of 0.0, top- $p$  of 1.0, top- $k$  of -1, and a repetition penalty of 1.0. The maximum token limit per request was 8,192.

To ensure a rigorous assessment of the framework’s autonomous capabilities, we enforced a strict **zero-human-intervention** policy across all experiments. All translation results and repair iterations were executed entirely by the framework; no manual post-editing or cherry-picking was performed during the evaluation.

#### 3.2 Datasets

We employed two distinct datasets to evaluate the framework’s performance on both domain-specific and general-purpose C projects. Table 3 presents the detailed statistics of these projects.

**Domain-Specific Projects:** We selected **OpenHarmony** [23] as a representative domain-specific codebase. As a large-scale distributed operating system widely deployed in industrial embedded devices, OpenHarmony features intricate build systems (e.g., GN/Ninja), extensive Hardware Abstraction Layers (HAL), and complex inter-component dependencies. Unlike isolated algorithmic benchmarks, these characteristics provide a rigorous stress test for evaluating the framework’s capability to handle real-world “dependency hell” and recover strictly typed contexts in a production environment. From this codebase, we curated five production projects. The selection criteria were as follows: (i) the codebases are primarily written in C, (ii) they possess executable unit tests, and (iii) they contain at least one function. From the resulting candidate list, we randomly sampled five submodules for evaluation. Note that these five submodules were strictly excluded from the source repositories used for knowledge base construction (Section 2.1) to ensure zero data leakage during evaluation.

**General-Purpose Projects:** We selected ten open-source C benchmark projects that are frequently utilized as evaluation targets in prior studies[2, 20, 26, 34, 41], covering data structures, small-scale programs, and larger projects.

#### 3.3 Baselines

We evaluate our approach against seven representative baselines: C2Rust [7], SmartC2Rust [26], RUSTINE [2], PTRMAPPER [34], C2SaferRust [20], EvoC2Rust [29], and Tymcrat [10].

Table 3. Statistics of the datasets used in evaluation.

Category	Project	#LOC	#Files	#Funcs	#Macros	#Tests	#Definitions
<b>Domain-Specific</b>	osal	161	1	8	3	4	1
	uhdf2_shared	208	2	7	9	15	0
	core_shared	338	7	26	1	5	1
	host	1,892	14	127	16	8	2
	appverify_lite	3,544	8	160	11	8	14
<b>General-Purpose</b>	ht	15	1	2	2	3	0
	qsort	27	1	3	0	6	0
	quadtree	319	5	24	2	4	4
	buffer	353	2	23	4	14	1
	rgba	420	2	13	3	10	2
	urlparser	426	1	20	6	3	1
	genann	459	3	13	10	12	7
	avl	836	1	28	29	2	9
	bzip2	4,325	9	93	144	1	15
	zopfli	6,115	29	113	47	1	41

Regarding data sourcing, we directly adopt results from the original papers for the closed-source methods (SmartC2Rust, RUSTINE, and PTRMAPPER). For all other baselines, we conducted unified reproduction runs in our environment. Entries marked with “-” indicate metrics that were either unreported in the original literature or unobtainable in our setup (e.g., due to compilation failures).

### 3.4 Metrics

We report the following metrics: Incremental Compilation Pass Rate (ICompRate) [2, 29], Functional Correctness (FC) [2, 20, 26, 29, 34], Unsafe Ratio [2, 20, 26, 29, 34], and Warnings [2, 34].

**(1) Incremental Compilation Pass Rate:** We start with a verified “skeleton version” containing placeholder bodies. Subsequently, we incrementally restore actual function implementations one-by-one, triggering compilation checks and rolling back upon failure. The rate is defined as the ratio of successfully restored functions to the total evaluated. Additionally, for our method, functions that revert to C2Rust-generated unsafe code due to repair exhaustion are strictly counted as failures.

**(2) Functional Correctness:** We calculate FC based on the test pass rate. For each project, we utilize a pre-maintained collection of project-level unit tests, temporarily incorporating them into the translation artifact during evaluation and executing them via a standard test runner. FC is defined as the number of passed tests divided by the total number of tests.

**(3) Unsafe Ratio:** We perform static statistics on the translated Rust source code, separately counting lines of code containing the `unsafe` keyword and lines within `unsafe` syntactic scopes, taking the union of the two as the number of unsafe-related lines. The Unsafe Ratio is defined as the number of unsafe-related lines divided by the total number of lines of code (calculated based on source lines, excluding comments and string literals to prevent counting interference).

**(4) Warnings:** We run the Rust checking pipeline on the translation artifacts and count the emitted warning diagnostics to characterize code quality and potential defect proneness.

We report Warnings only for crates that compile successfully. For failed compilations, where early termination precludes accurate diagnostic collection, we denote the entry as “-”. For RQ3 and RQ4, we additionally report `AvgRepair`, which represents the average number of compilation-guided repair rounds utilized to achieve a successful build.

### 3.5 Implementation

Following the Knowledge Base Construction process described in Section 2.1, we prioritized the *Co-evolution Case* strategy to leverage the rich history of the OpenHarmony codebase. OpenHarmony serves as an ideal industrial testbed due to its active C-to-Rust migration. We targeted all 21 sub-repositories containing Rust implementations, identifying 229,127 commits where C modules were explicitly refactored into Rust. The extracted knowledge primarily comprises two categories: API-Level rules and Fragment-Level rules. Based on the current knowledge base, we extracted a total of 81,850 API-Level rules and 19,685 Fragment-Level rules, amounting to 101,535 items in total. Although extracted from a domain-specific codebase, this knowledge base captures universal C-to-Rust translation patterns (e.g., standard library mappings and algorithmic idioms), enabling us to apply it to the general-purpose benchmarks in RQ2.

To evaluate functional correctness, we prioritize the reuse of test code from the source implementation. For general-purpose benchmarks, we prioritize migrating tests from the original projects to the Rust framework to verify semantic consistency. In cases where original tests are absent, we supplement them by developing test cases based on core interfaces. Specifically, projects with existing tests that we migrated include `urlparser`, `avl`, `buffer`, `rgba`, `genann`, and `ht`. Projects for which we developed or maintained tests include `qsort`, `bzip2`, `zopfli`, and `quadtree`. For domain-specific benchmarks, we similarly opt to reuse tests from the original projects. All selected modules (including `osal`, `uhdf2_shared`, `core_shared`, `host`, and `appverify_lite`) directly reuse their original unit test suites to ensure the validity of the verification.

## 4 Experimental Evaluation

We conduct experiments to evaluate the effectiveness of His2Trans, aiming to answer the following research questions (RQs):

- **RQ1:** How effective is our approach in translating domain-specific C projects?
- **RQ2:** How effective is our approach in translating general-purpose projects?
- **RQ3:** How do mapping rules and repair loops impact the translation of function bodies?
- **RQ4:** How does knowledge accumulation affect translation performance?

### 4.1 RQ1: Domain-Specific Effectiveness

*4.1.1 Design.* RQ1 evaluates the end-to-end migration effectiveness on domain-specific projects characterized by macro-intensive build contexts, external symbol dependencies, and long dependency chains. We compared our approach against baseline methods on five OpenHarmony submodules listed in Table 3. To evaluate the sensitivity to domain knowledge density, we swept the retrieval depth  $K \in \{1, 3, 5, 10\}$  for the DeepSeek-V3.2 model.

We prioritized DeepSeek-V3.2 for this parameter sweep due to its superior cost-effectiveness, which allows for extensive experimentation without the prohibitive costs of proprietary SOTA models. Furthermore, it has been widely used in recent code translation literature [2, 29], ensuring the representativeness of our findings.

*4.1.2 Results and Analysis.* Table 4 shows that His2Trans retains a decisive advantage in **build feasibility** on domain-specific projects. Traditional baselines remain fragile in OpenHarmony-like environments: C2Rust and C2SaferRust only reach 10.28% and 52.17% ICompRate, respectively, while EvoC2Rust fails completely. In contrast, our framework reaches 97.51% ICompRate with Claude-Opus-4.5, and all DeepSeek-V3.2 variants remain above 87%, confirming that the skeleton-first design effectively reconstructs the missing build context. A more nuanced pattern emerges across retrieval depths. For DeepSeek-V3.2, increasing  $K$  does not monotonically improve performance:  $K = 5$  yields the best compilation result (90.34%), whereas  $K = 1$  gives the lowest unsafe

Table 4. Performance comparison on domain-specific projects (RQ1).

Method	ICompRate	FC	Unsafe	Warnings
C2Rust	10.28	22.50	47.75	45.00
C2SaferRust	52.17	10.00	36.33	27.50
EvoC2Rust	0.00	0.00	–	–
Tymcrat	51.53	0.00	–	–
Ours(DeepSeek-V3.2 K = 1)	87.85	75.00	32.15	464.00
Ours(DeepSeek-V3.2 K = 3)	88.47	75.00	33.02	448.80
Ours(DeepSeek-V3.2 K = 5)	90.34	75.00	35.43	463.00
Ours(DeepSeek-V3.2 K = 10)	87.23	75.00	34.06	446.40
Ours(Claude-opus-4-5 K = 5)	97.51	75.00	37.09	315.40

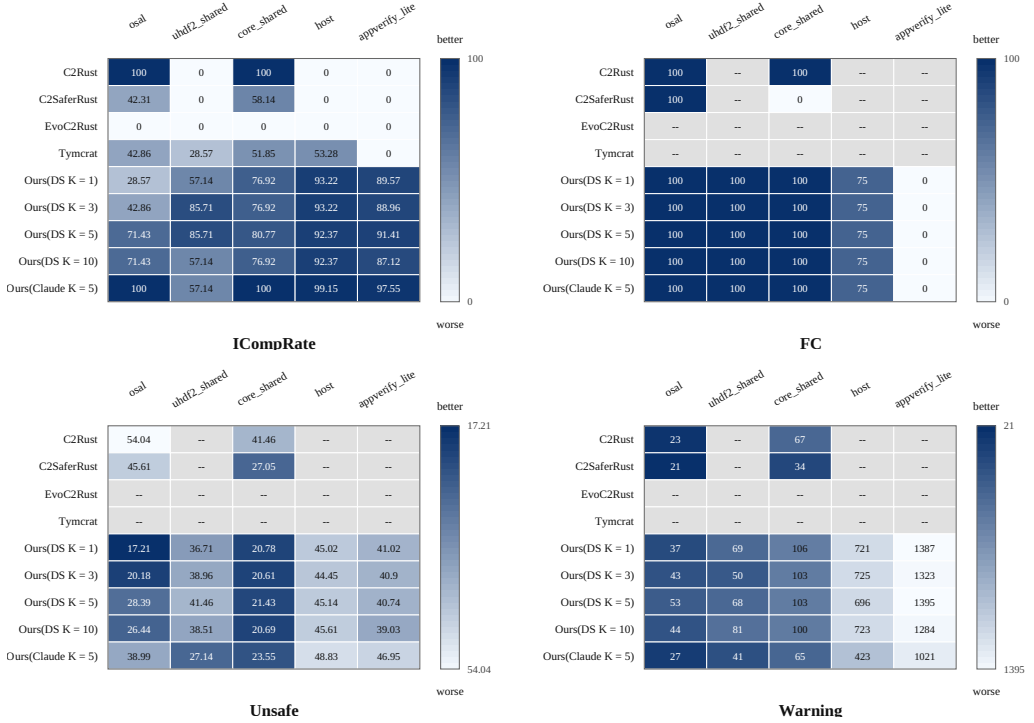

Fig. 5. Detailed performance metrics for domain-specific projects (RQ1). Darker shades denote better results; “–” indicates compilation failure.

ratio (32.15%). This indicates a trade-off between richer historical guidance and retrieval noise, rather than a simple “more context is always better” effect. At the same time, Functional Correctness remains fixed at 75.00% across all of our RQ1 settings, suggesting that once the structural barrier is removed, the remaining bottleneck lies in difficult module-level semantics rather than in build recovery itself. In other words, His2Trans reliably turns previously non-buildable migration tasks into compilable Rust artifacts, but the hardest industrial modules still require stronger semantic translation.

Figure 5 further shows that the gain is concentrated in compilation feasibility. For our method, the per-module FC pattern is almost unchanged across different retrieval settings, whereas ICompRate varies more noticeably, indicating that retrieval depth mainly affects whether a function can be compiled into the crate, not whether the hardest modules are fully semantically solved.

**Why does domain-specific migration fall into a distinct category?** OpenHarmony submodules introduce system-level challenges that are absent in general-purpose independent benchmarks. First, complex build contexts are implicit within extensive header include graphs and conditional macros; without reconstructing this environment, the system cannot even synthesize a compilable Rust crate. Second, many key definitions (such as platform enums, log constants, and opaque handles) reside outside the local translation unit, rendering function-based prompts under-defined. Third, correctness verification relies directly on the original gtest suites, which can rapidly expose minute deviations in ABI compatibility and memory layout. Therefore, in this category, the core bottleneck is no longer limited to the generation quality of individual function bodies, but rather whether the system can assemble a coherent crate, thereby making compiler feedback actionable for repair.

**Impact of Skeleton-First Design.** Our Rust Skeleton Construction module (see Section 2.2) establishes and verifies a compile-safe skeleton (containing types, global variables, and compatibility layers) prior to translating function bodies. This strategy transforms implicit C dependencies into explicit Rust declarations, thereby significantly reducing the occurrence of non-local errors. Ultimately, the repair loop receives highly localized and deterministic feedback, rather than cascading failures stemming from missing global definitions.



Tymcrat	His2Trans
<pre>fn power_state_token_release_wake_lock(token: Option&lt;&amp;mut PowerStateToken&gt;) {   const HDF_POWER_DYNAMIC_CTRL: u32 = /* appropriate constant value */;   let state_token = match token {     Some(t) =&gt; t,     None =&gt; return,   };   if state_token.mode != HDF_POWER_DYNAMIC_CTRL {     return;   }   /* ... */ }</pre> 	<pre>pub const HDF_POWER_DYNAMIC_CTRL: PowerManagementMode = 1; fn PowerStateTokenReleaseWakeLock(token: *mut crate::types::IPowerStateToken) {   let stateToken = token as *mut crate::types::PowerStateToken;   if stateToken.is_null() {     return;   }   let stateToken = unsafe { &amp;mut *stateToken };   if stateToken.mode != crate::types::HDF_POWER_DYNAMIC_CTRL {     return;   }   /* ... */ }</pre> 

Fig. 6. A representative definition-gap failure in host: the baseline inserts a placeholder constant (syntax error), while our skeleton recovers a concrete domain constant and unblocks compilation.

**Baseline Failure Mode Analysis.** Figure 6 summarizes the primary failure modes exhibited by the five OpenHarmony submodules across various baselines under a unified testing environment. For C2Rust and C2SaferRust, their effectiveness relies on reconstructing a buildable Cargo project during the conversion phase. However, in our experimental setup, this mechanism failed on three submodules (manifested as a failure to generate Cargo.toml), thereby directly blocking any downstream compilation or testing processes. For LLM-centric baselines (EvoC2Rust and Tymcrat), due to the lack of an explicit compile-safe skeleton, they failed to successfully compile any submodules (0/5). Although these methods generated a large number of function bodies, residual unresolved constants, type definitions, and placeholder tokens resulted in crate-level compilation failures.

**Case Study: Constant Recovery Prevents Cascading Failures.** Figure 6 compares the output of Tymcrat and our method on the host wakelock release routine. Tymcrat left a placeholder constant initializer within the function body, which caused a syntax-level compilation block, subsequently preventing the compiler-guided repair mechanism from initiating. Our Skeleton Construction module pre-recovered the enum-based constant definitions, thereby eliminating compilation barriers. This enabled the subsequent repair loop to focus on resolving local logical defects rather than noise produced by missing definitions.

**4.1.3 Summary.** In domain-specific projects, His2Trans delivers a clear structural advantage, reaching 97.51% Incremental Compilation Pass Rate and substantially outperforming all reproduced

Table 5. Performance comparison on general-purpose benchmarks (RQ2).

Method	ICompRate	FC	Unsafe	Warnings
C2Rust	39.51	94.64	69.48	134.70
SmartC2Rust	99.38	100.00	–	–
RUSTINE	100.00	100.00	–	–
PTRMAPPER	100.00	82.44	–	–
C2SaferRust	48.90	78.57	47.56	163.70
EvoC2Rust	93.56	87.50	5.90	430.25
Tymcrat	78.53	10.71	0.00	2.50
Ours(DeepSeek-V3.2)	62.96	46.43	37.28	136.44
Ours(Claude-opus-4-5)	71.30	57.14	44.25	101.00

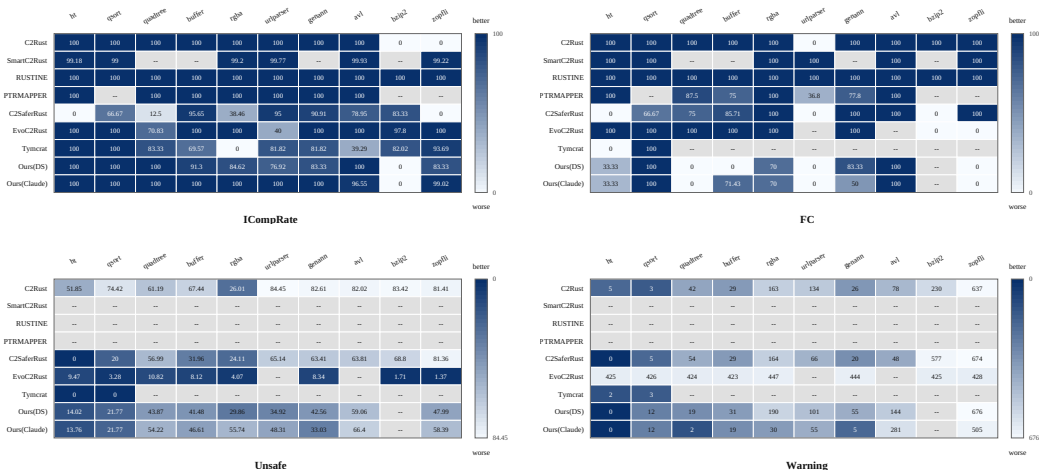

Fig. 7. Heatmap visualization of detailed performance metrics across general-purpose benchmarks (RQ2). Darker shades indicate superior performance (higher Compilation/FC, lower Unsafe/Warnings).

baselines under complex build settings. However, the remaining 75.00% Functional Correctness also indicates that compilation recovery alone does not fully solve the hardest semantic cases. Overall, the results confirm that His2Trans is particularly effective at breaking the industrial “dependency hell” barrier and turning migration into a tractable, debuggable process.

## 4.2 RQ2: General-Purpose Effectiveness

**4.2.1 Design.** RQ2 evaluates the cross-domain effectiveness of His2Trans on ten general-purpose open-source C benchmarks (Table 3). Unlike the industrial OpenHarmony modules in RQ1, these projects do not share the same domain-specific APIs or migration history as our mined knowledge base, and therefore serve as a stress test for transferability beyond the source domain. We operated the framework with two model backends under an identical pipeline configuration to assess model sensitivity, and compared our approach against both rule-based baselines and representative LLM-based methods.

**4.2.2 Results and Analysis.** Table 5 reveals a different pattern from RQ1. On general-purpose benchmarks, His2Trans no longer dominates in compilation or functional correctness: the Claude-Opus-4.5 backend reaches 71.30% ICompRate and 57.14% FC, while DeepSeek-V3.2 attains 62.96% and 46.43%, respectively. This suggests that once the build-context difficulty is reduced, the advantage of our skeleton-first framework becomes less decisive than in industrial settings.

Nevertheless, His2Trans still shows a clear strength in safety-oriented code quality. Compared with C2Rust, the Claude-Opus-4.5 configuration lowers the unsafe ratio from 69.48% to 44.25% (a 25.23-point reduction) and reduces warnings from 134.70 to 101.00. The DeepSeek-V3.2 variant further lowers the unsafe ratio to 37.28%, although at the cost of lower FC and a higher warning count (136.44). Taken together, these results indicate that our skeleton and historical retrieval still help steer generation away from mechanically preserved C-style memory usage, even when full cross-domain semantic transfer remains incomplete.

These results should also be interpreted under our strict evaluation protocol. We enforce **zero human intervention** and reuse original test suites whenever available. For projects such as `bzip2` and `zopfli`, this requires the translated implementation to satisfy bit-exact behavior rather than partial functional similarity. Under this setting, the gap between safer code generation and full semantic completion remains visible rather than being masked by relaxed verification criteria. Therefore, RQ2 should be read as a realistic assessment of fully automated cross-domain migration under strict testing constraints. With this evaluation setting in mind, the remaining differences across methods can be interpreted as distinct trade-offs in design priorities.

**Trade-offs and Implications.** The comparison across baselines highlights several distinct strategies on general-purpose benchmarks. Rule-based transpilers such as C2Rust preserve behavior more directly and therefore achieve stronger functional correctness (94.64%), but they do so with a very high unsafe ratio (69.48%). Closed-source methods such as SmartC2Rust and RUSTINE report near-perfect compilation and correctness on these datasets, suggesting that such benchmarks favor methods tuned specifically for standard-library-heavy or algorithmic tasks.

Among the reproduced LLM-based baselines, the trade-offs are also clear. C2SaferRust improves safety relative to C2Rust, but still retains 47.56% unsafe code and does not surpass it in overall robustness. EvoC2Rust achieves a very low unsafe ratio (5.90%), yet incurs the highest warning burden (430.25), indicating that reducing explicit unsafe alone does not guarantee maintainable Rust. Tymcrat further pushes the unsafe ratio to 0.00%, but its Functional Correctness drops to 10.71%, suggesting substantial under-translation on non-trivial tasks.

Against this backdrop, His2Trans occupies a different point in the design space. It does not maximize correctness on these cross-domain benchmarks, but it consistently steers generation toward cleaner and safer Rust than the mechanical baseline. In particular, the Claude-Opus-4.5 configuration reduces the unsafe footprint by 25.23 percentage points relative to C2Rust while also lowering warning counts, providing a better foundation for subsequent manual or automated refinement.

The remaining unsafe code in His2Trans is also expected. Because our framework targets evolutionary migration rather than isolated reimplementations, part of the generated Rust must preserve binary compatibility with untranslated C components. As a result, many unsafe blocks are concentrated around FFI boundaries and `#[repr(C)]` data structures to ensure layout consistency. This reflects a deliberate engineering trade-off in incremental migration, rather than arbitrary unsafe usage.

**Case Study: Struct Layout Recovery vs. Pointer-as-Integer Collapse.** Figure 8 illustrates a representative failure case regarding buffer type recovery. Tymcrat collapsed the C struct into an integer handle but subsequently treated it as a record, causing field access type errors that prevented compilation. Our skeleton recovers the struct layout before body generation, making subsequent translation and compilation-guided repair type-directed rather than guess-based. Although this structural advantage does not always translate into the highest end-to-end FC on general-purpose tasks, it still improves the quality and debuggability of the generated Rust code.

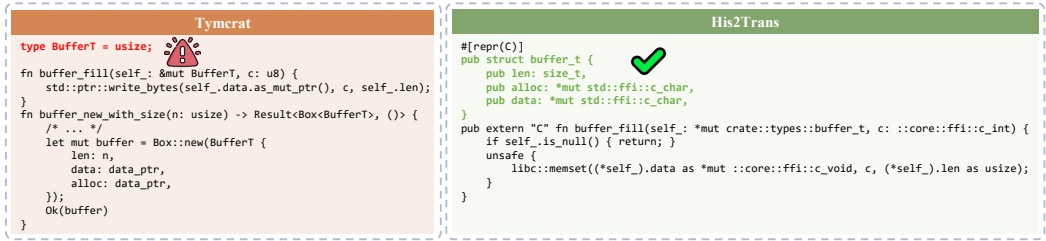

Fig. 8. On buffer, the baseline collapses a struct into an integer handle, which breaks field-level reasoning; our skeleton recovers the struct layout, enabling type-correct function bodies.

Table 6. Experimental Configurations and Results for RQ3.

Config ID	Configuration Setup			Performance Metrics		
	API Rule	Frag. Rule	Repair Limit	ICompRate	FC	AvgRepair
<i>Base-1Shot</i>	None	None	0	42.50	100.00	0.00
<i>Base-Rep</i>	None	None	5	90.00	100.00	1.52
<i>Pred-1Shot</i>	Retrieved	Retrieved	0	47.50	100.00	0.00
<i>Pred-Rep</i>	Retrieved	Retrieved	5	82.50	100.00	1.55
<i>GT-API</i>	<b>Ground Truth</b>	Retrieved	5	80.00	100.00	1.35
<i>GT-Frag</i>	Retrieved	<b>Ground Truth</b>	5	87.50	100.00	1.45
<i>GT-Full</i>	<b>Ground Truth</b>	<b>Ground Truth</b>	5	87.50	100.00	1.40

4.2.3 *Summary.* On general-purpose benchmarks, His2Trans demonstrates partial but meaningful cross-domain transfer. Although it does not achieve the strongest compilation or functional correctness among all baselines, it substantially reduces unsafe usage and improves warning profiles relative to C2Rust. These results suggest that the framework generalizes more strongly in safety and code cleanliness than in full semantic completion.

### 4.3 RQ3: Mapping Rules and Repair Loops for Function Body Translation

4.3.1 *Design.* RQ3 investigates how function body translation is affected by different **mapping rule channels** and **repair budgets** under a fixed build-aware skeleton. We keep the build context, toolchain, and model backend unchanged (Claude-Opus-4.5) and vary only the knowledge source and repair limit.

Due to the prohibitive token cost of larger modules, we conduct this ablation on three representative OpenHarmony submodules (*osal*, *uhdf2\_shared*, and *core\_shared*). These modules provide a controlled setting in which the skeleton is already stable and unit-test outcomes remain fully passable once the translated functions compile.

We evaluate seven configurations along three dimensions: (1) **API Rule**, referring to the source of API-Level rules (None, Retrieved, or Ground Truth); (2) **Fragment Rule**, referring to the source of Fragment-Level rules; and (3) **Repair Limit**, representing the maximum number of compilation-guided repair iterations allowed (0 for one-shot generation, 5 for iterative repair).

The left side of Table 6 summarizes the specific settings. Here, “Retrieved” denotes rules returned by similarity search from our constructed knowledge base, while “Ground Truth” denotes oracle rules mined from the manual translations of the evaluated modules. This setup allows us to distinguish whether knowledge mainly improves first-shot generation, raises the final compilation ceiling, or primarily shortens the repair path. The Ground Truth settings are used only as oracle controls for analysis and are not part of the practical deployment configuration of His2Trans.

**4.3.2 Results and Analysis.** A first observation is that Functional Correctness remains fixed at 100.00% across all RQ3 settings. Therefore, for these smaller modules, the ablation mainly differentiates **whether** function bodies can be compiled into the skeleton and **how much repair effort** is required to get there.

**Iterative repair is the primary driver of success.** Table 6 shows that one-shot generation alone is insufficient even under a compile-safe skeleton. The baseline one-shot setting (*Base-1Shot*) reaches only 42.50% ICompRate, whereas enabling compilation-guided repair (*Base-Rep*) raises the result sharply to 90.00%. This confirms that compiler feedback is not a marginal optimization, but the main mechanism that turns initially invalid generations into compilable Rust code.

**Knowledge helps only when it is precise enough.** Retrieved rules provide only a modest gain in the one-shot setting (*Pred-1Shot*: 47.50% vs. 42.50%), but under the repair budget they actually underperform the no-knowledge baseline (*Pred-Rep*: 82.50% vs. 90.00%). This suggests that imperfect retrieval can inject misleading priors, forcing the repair loop to spend iterations correcting retrieval-induced mistakes rather than genuine translation errors.

**High-quality knowledge mainly improves efficiency, not the final ceiling.** Among the oracle settings, *GT-API* achieves the lowest AvgRepair (1.35), while *GT-Frag* and *GT-Full* remain at 1.45 and 1.40, respectively. This indicates that accurate API-level guidance is particularly effective at shortening the repair path by resolving interface choices earlier. At the same time, none of the oracle settings surpasses *Base-Rep* in final ICompRate, suggesting that under a stable skeleton the repair loop remains the dominant factor for ultimate success, while knowledge primarily reshapes the search efficiency.

**Case Study: Precise Knowledge as a Repair Accelerator.** Figure 9 presents two representative OpenHarmony cases. Each case contrasts *Base-1Shot* (no knowledge, no repair), *Base-Rep* (no knowledge with repair), and *GT-Full* (oracle knowledge with repair), showing that precise prior knowledge does not replace the repair loop but can substantially shorten the path toward a correct implementation.



C code	Base-1Shot output	Base-Rep output	GT-Full output
<pre>void IoServiceStatusListenerFree(struct IoServiceStatusListener *listener){ // The macro implies a layout offset calculation struct IoServiceStatusListener *IoServiceListener = CONTAINER_OF(listener, struct IoServiceStatusListener, svcstatlistener); OsaMemFree(IoServiceListener); }  /* ... */ // Fail: Dereferencing null to get offset is UB in Rust let offset = unsafe {     &amp;*(IoServiceListener::create():IoServiceStatusListener()).svcstatlistener as *const_us as usize }; let IoServiceListener = unsafe {     (listener as *mut_us).sub(offset) as *mut crate::types::IoServiceStatusListener }; /* ... */  /* ... */ // Repair: Clunky workaround to avoid null-deref let offset = {     let dummy = std::mem::MaybeUninit::create():types::IoServiceStatusListener::uninit();     let base_ptr = dummy.as_ptr();     unsafe {         let field_ptr = std::ptr::addr_of!((*base_ptr).svcstatlistener);         (field_ptr as *const_us).offset_from(base_ptr as *const_us) as usize     } }; /* ... */</pre>	<p><b>Case 1</b></p> 	<pre>void HfIoServiceRemove(struct HfIoService *service){ if (HfIoServiceAdapterRemove != NULL) {     HfIoServiceAdapterRemove(service); }  pub extern "C" fn HfIoServiceRemove(service: *mut crate::types::HfIoService) {     extern "C" {         fn HfIoServiceAdapterRemove(...);     }     // Error: Mallocated static causing duplicate symbol     static HfIoServiceAdapterRemove: Option&lt;unsafe extern "C" fn(...)&gt;; } /* ... */  pub extern "C" fn HfIoServiceRemove(service: *mut crate::types::HfIoService) {     extern "C" {         fn HfIoServiceAdapterRemove(...);     }     // Repair: Check function address for weak linking     unsafe {         let func_ptr: *const () = HfIoServiceAdapterRemove as *const ();         if func_ptr.is_null() {             HfIoServiceAdapterRemove(service);         }     } }</pre>	<p><b>Case 2</b></p> 
	Repair 1 times	Repair 3 times	Repair 3 times
<pre>API-Level rules: - OsaMemFree -&gt; OsaMemFree (Free memory via OSA allocator) Fragment-Level rules: - C: CONTAINER_OF(p, T, Field) - Rust: (p as *mut_us).offset(-(offset_of!(T, field) as isize)) as *mut T  /* ... */ // Success: Direct usage of Rust native macro let offset = std::mem::offset_of!(crate::types::IoServiceStatusListener, svcstatlistener); let IoServiceListener = unsafe {     (listener as *mut_us).offset(-(offset as isize)) as *mut crate::types::IoServiceStatusListener }; /* ... */</pre>	Repair 0 time	<pre>API-Level rules: - HfIoServiceAdapterRemove -&gt; HfIoServiceAdapterRemove (Remove io service via adapter)  pub extern "C" fn HfIoServiceRemove(service: *mut crate::types::HfIoService) {     extern "C" {         fn HfIoServiceAdapterRemove(...);     }     // Success: Generated correct check immediately     unsafe {         let func_ptr: *const () = HfIoServiceAdapterRemove as *const ();         if func_ptr.is_null() {             HfIoServiceAdapterRemove(service);         }     } }</pre>	Repair 1 time

Fig. 9. Comparison of baseline vs. knowledge-guided translation (*GT-Full*). Case studies include Memory Layout Recovery (Left) and Weak Symbol Linking (Right).

In the memory-layout case on the left of Figure 9, *Base-1Shot* directly imitates the C-style offset computation and fails to compile, while *Base-Rep* eventually repairs it through a more

Table 7. Impact of knowledge accumulation on unseen modules (RQ4).

Setting	ICompRate	FC	AvgRepair
Base KB only	41.28	37.50	1.55
Base KB + Accumulated KB	41.64	37.50	0.61
Relative Improvement	+0.87%	-	-60.69%

cumbersome pointer-based workaround. By contrast, *GT-Full* benefits from the injected fragment rule and directly adopts the idiomatic `offset_of!` pattern, reaching a correct solution with no repair. This case shows that precise knowledge does not replace the skeleton or the repair loop, but can substantially shorten the path to a compilable and idiomatic implementation.

In the weak-symbol case on the right of Figure 9, *Base-1Shot* misinterprets the null-check logic and introduces a duplicate symbol, causing compilation failure. Although *Base-Rep* finally recovers the correct address-check pattern, it requires multiple rounds of trial-and-error. With API-level guidance, *GT-Full* generates the correct weak-linking check in the first round and reduces the repair cost from three iterations to one. This further confirms that high-quality knowledge mainly acts as a repair accelerator by avoiding erroneous initial reasoning.

**4.3.3 Summary.** RQ3 shows that compilation-guided repair, rather than knowledge injection alone, is the main enabler of successful incremental translation. Mapping rules are beneficial primarily when they are sufficiently precise: noisy retrieved rules can even hurt, whereas oracle-quality rules mainly reduce repair cost rather than raising the final compilation ceiling.

This observation directly motivates RQ4, where we further examine whether verified knowledge accumulated from earlier successful migrations can serve as a reusable efficiency prior on unseen modules.

## 4.4 RQ4: Knowledge Accumulation

**4.4.1 Design.** To evaluate whether the self-evolving mechanism of His2Trans yields transferable benefits, we partitioned the OpenHarmony modules into two mutually exclusive groups. Group A consists of `osal`, `uhdf2_shared`, and `core_shared`, and Group B consists of `host` and `appverify_lite`, which serve as unseen targets for evaluation.

We first run His2Trans on Group A under its standard workflow. As successful translations are completed, the framework naturally accumulates compilation-validated C-to-Rust pairs and derives corresponding API-/Fragment-level rules, which are fed back into the knowledge base as part of the built-in knowledge accumulation stage. No additional manual extraction procedure is introduced for this experiment.

We then translate Group B under two settings: (1) **Base KB only**, using only the initial knowledge base constructed before evaluation; and (2) **Base KB + Accumulated KB**, using the same base knowledge augmented with the rules accumulated during the prior translation of Group A. This setup evaluates whether knowledge acquired from earlier successful migrations can benefit subsequent unseen modules.

**4.4.2 Results and Analysis.** The updated accumulation experiment indicates that the immediate benefit of knowledge accumulation lies primarily in **repair efficiency**, rather than in the final performance ceiling. As shown in Table 7, augmenting the base knowledge with accumulated knowledge changes ICompRate only marginally, from 41.28% to 41.64% (+0.87%), while Functional Correctness remains unchanged at 37.50%. This suggests that simply adding verified historical rules is not yet sufficient to unlock many additional successful translations on these hard unseen modules.

The efficiency gain, however, is substantial. The AvgRepair metric drops from 1.55 to 0.61, a reduction of 60.69%. In other words, accumulated knowledge mainly acts as a *repair accelerator*: it helps the framework reach already-attainable solutions with far fewer compilation-feedback rounds. This still supports the self-evolving claim of His2Trans, but in a more precise sense: at the current stage, evolution improves migration efficiency much more clearly than ultimate accuracy.

**4.4.3 Summary.** RQ4 shows that knowledge accumulation already yields a substantial practical benefit by cutting repair rounds by about 60% on unseen modules, even though its effect on final compilation and functional correctness is currently limited. Therefore, the self-evolving mechanism should be understood primarily as lowering migration cost and stabilizing repair, rather than as immediately expanding the final success ceiling.

## 5 Threats to Validity

**External Validity: Domain Bias.** Our knowledge base is primarily mined from the OpenHarmony ecosystem, potentially biasing rules toward embedded systems. While the general-purpose benchmarks in RQ2 suggest partial cross-domain transferability, performance on more distant domains (e.g., high-level web services) with different API patterns remains to be fully verified.

**Internal Validity: Test Suite Adequacy.** We rely primarily on legacy test suites for verification, although for some general-purpose benchmarks we migrated, maintained, or supplemented tests when original coverage was incomplete. These test adaptations may still introduce evaluation bias despite our effort to preserve project semantics.

## 6 Related Work

Rust offers low-level control with performance comparable to C/C++ while providing strong compile-time memory-safety guarantees through ownership and borrowing. These properties have motivated substantial interest in migrating legacy systems code from C/C++ to Rust. Existing work on C-to-Rust can be broadly categorized into rule-based, LLM-based, and hybrid approaches.

**Rule-based methods.** Rule-based approaches translate C to Rust via compiler front-ends and handcrafted rules, typically using syntax-level rewrites to preserve structural correspondence. A representative tool is C2Rust [7], built on Clang, which translates largely via C-Rust FFI and often relies on `unsafe`, resulting in `unsafe-heavy` and non-idiomatic code. Subsequent work improves safety and idiomatity with stronger analyses and specialization: Emre et al. [3] use compiler-feedback repair, Ling et al. [15] introduce syntactic heuristics, and Crown [36] applies static ownership tracking for pointer conversion. Hong & Ryu [8, 9, 11] further target recurring C idioms and API patterns. However, rule-based pipelines remain engineering-intensive and brittle to project-specific APIs and build configurations, limiting scalability to large systems.

**LLM-based methods.** LLM-based approaches prompt an LLM to synthesize Rust from C, sometimes augmented with tests or specifications. While more flexible than transpilers and often better at capturing Rust idioms, LLM outputs can be incorrect and hard to trace, and high-quality parallel C-Rust data remains limited [24]. Prior work therefore emphasizes verification/feedback and structured context. FLOURINE combines fuzzing with error-message feedback for iterative repair, though type serialization remains challenging [5]; UniTrans leverages test generation for iterative refinement [33]. Others inject richer context: IRENE integrates rule-augmented retrieval and structured summarization for function-level translation [18], and additional systems incorporate static specifications and I/O tests [21] or data-flow graphs to improve type migration [31].

**Hybrid methods.** Hybrid approaches combine rule-based skeleton with LLM refinement: rules provide a deterministic, type-checked structure, while LLMs improve idiomatity and reduce `unsafe` usage. C2SaferRust [20] refactors C2Rust output [7] in test-verified chunks, SACTOR [41]

applies a two-stage LLM translation-and-refinement workflow with static/FFI-based validation, and EvoC2Rust [29] migrates projects via a compilable skeleton and iterative stub replacement with build-error repair.

## 7 Conclusion

In this paper, we introduced His2TRANS, an automated framework designed to overcome structural and knowledge barriers in industrial C-to-Rust migration. By synergizing a strictly typed Project-Level Skeleton with a Self-Evolving Knowledge Base, our approach addresses missing build context and supports stable incremental translation under complex industrial settings. Evaluations on OpenHarmony show that His2Trans achieves a 97.51% incremental compilation pass rate, substantially outperforming reproduced baselines in build feasibility. On general-purpose benchmarks, the framework still provides meaningful benefits in reducing unsafe usage and improving code cleanliness, although full cross-domain functional generalization remains challenging. Finally, knowledge accumulation reduces repair cost by approximately 60%, indicating that the framework becomes more efficient as verified migration experience grows. These results suggest that future migration tools should prioritize deterministic build contexts and reusable verified knowledge, for which His2TRANS provides a practical foundation.

## Data Availability

The raw data, test code, and framework source code used in this study are available at: <https://anonymous.4open.science/r/His2Trans-F1F0/>.

## References

- [1] Xuemeng Cai, Jiakun Liu, Xiping Huang, Yijun Yu, Haitao Wu, Chunmiao Li, Bo Wang, Imam Nur Bani Yusuf, and Lingxiao Jiang. 2025. RustMap: Towards Project-Scale C-to-Rust Migration via Program Analysis and LLM. In *Engineering of Complex Computer Systems: 29th International Conference, ICECCS 2025, Hangzhou, China, July 2–4, 2025, Proceedings* (Hangzhou, China). Springer-Verlag, Berlin, Heidelberg, 283–302. doi:10.1007/978-3-032-00828-2\_16
- [2] Saman Dehghan, Tianran Sun, Tianxiang Wu, Zihan Li, and Reyhaneh Jabbarvand. 2025. Translating Large-Scale C Repositories to Idiomatic Rust. arXiv:2511.20617 [cs.SE] <https://arxiv.org/abs/2511.20617>
- [3] Mehmet Emre, Peter Boyland, Aesha Parekh, Ryan Schroeder, Kyle Dewey, and Ben Hardekopf. 2023. Aliasing limits on translating C to safe Rust. *Proceedings of the ACM on Programming Languages* 7, OOPSLA1 (2023), 551–579.
- [4] Mehmet Emre, Ryan Schroeder, Kyle Dewey, and Ben Hardekopf. 2021. Translating C to safer Rust. *Proc. ACM Program. Lang.* 5, OOPSLA, Article 121 (Oct. 2021), 29 pages. doi:10.1145/3485498
- [5] Hasan Ferit Eniser, Hanliang Zhang, Cristina David, Meng Wang, Maria Christakis, Brandon Paulsen, Joey Dodds, and Daniel Kroening. 2025. Towards Translating Real-World Code with LLMs: A Study of Translating to Rust. arXiv:2405.11514 [cs.SE] <https://arxiv.org/abs/2405.11514>
- [6] Muhammad Farrukh, Smeeta Shah, Baris Coskun, and Michalis Polychronakis. 2025. SafeTrans: LLM-assisted Transpilation from C to Rust. arXiv:2505.10708 [cs.CR] <https://arxiv.org/abs/2505.10708>
- [7] Galois, Inc. 2018. C2Rust. <https://galois.com/blog/2018/08/c2rust/>. Accessed: 2026-01-27.
- [8] Jaemin Hong and Sukyoung Ryu. 2024. Don’t write, but return: Replacing output parameters with algebraic data types in c-to-rust translation. *Proceedings of the ACM on Programming Languages* 8, PLDI (2024), 716–740.
- [9] Jaemin Hong and Sukyoung Ryu. 2024. To Tag, or Not to Tag: Translating C’s Unions to Rust’s Tagged Unions. In *Proceedings of the 39th IEEE/ACM International Conference on Automated Software Engineering*. 40–52.
- [10] Jaemin Hong and Sukyoung Ryu. 2024. Type-migrating C-to-Rust translation using a large language model. *Empirical Software Engineering* 30 (10 2024). doi:10.1007/s10664-024-10573-2
- [11] Jaemin Hong and Sukyoung Ryu. 2025. Forcrat: Automatic I/O API Translation from C to Rust via Origin and Capability Analysis. arXiv preprint arXiv:2506.01427 (2025).
- [12] Xinyi Hou, Yanjie Zhao, Yue Liu, Zhou Yang, Kailong Wang, Li Li, Xiapu Luo, David Lo, John Grundy, and Haoyu Wang. 2024. Large Language Models for Software Engineering: A Systematic Literature Review. *ACM Trans. Softw. Eng. Methodol.* 33, 8, Article 220 (Dec. 2024), 79 pages. doi:10.1145/3695988
- [13] Ralf Jung, Jacques-Henri Jourdan, Robbert Krebbers, and Derek Dreyer. 2017. RustBelt: securing the foundations of the Rust programming language. *Proc. ACM Program. Lang.* 2, POPL, Article 66 (Dec. 2017), 34 pages. doi:10.1145/3158154

- [14] Ralf Jung, Jacques-Henri Jourdan, Robbert Krebbers, and Derek Dreyer. 2021. Safe systems programming in Rust. *Commun. ACM* 64, 4 (March 2021), 144–152. doi:10.1145/3418295
- [15] Michael Ling, Yijun Yu, Haitao Wu, Yuan Wang, James R Cordy, and Ahmed E Hassan. 2022. In Rust we trust: a transpiler from unsafe C to safer Rust. In *Proceedings of the ACM/IEEE 44th international conference on software engineering: companion proceedings*. 354–355.
- [16] Tianyang Liu, Canwen Xu, and Julian McAuley. 2024. RepoBench: Benchmarking Repository-Level Code Auto-Completion Systems. In *International Conference on Learning Representations*, B. Kim, Y. Yue, S. Chaudhuri, K. Fragkiadaki, M. Khan, and Y. Sun (Eds.), Vol. 2024. 47832–47850. [https://proceedings.iclr.cc/paper\\_files/paper/2024/file/d191ba4c8923ed8fd8935b7c98658b5f-Paper-Conference.pdf](https://proceedings.iclr.cc/paper_files/paper/2024/file/d191ba4c8923ed8fd8935b7c98658b5f-Paper-Conference.pdf)
- [17] Yuchen Liu, Junhao Hu, Yingdi Shan, Ge Li, Yanzhen Zou, Yihong Dong, and Tao Xie. 2025. LLMigrate: Transforming "Lazy" Large Language Models into Efficient Source Code Migrators. arXiv:2503.23791 [cs.PL] <https://arxiv.org/abs/2503.23791>
- [18] Feng Luo, Kexing Ji, Cuiyun Gao, Shuzheng Gao, Jia Feng, Kui Liu, Xin Xia, and Michael R. Lyu. 2025. Integrating Rules and Semantics for LLM-Based C-to-Rust Translation. arXiv:2508.06926 [cs.SE] <https://arxiv.org/abs/2508.06926>
- [19] Matt Miller. 2019. Trends, Challenges, and Strategic Shifts in the Software Vulnerability Mitigation Landscape. Presentation at BlueHat IL Conference. [https://github.com/microsoft/MSRC-Security-Research/blob/master/presentations/2019\\_02\\_BlueHatIL/2019\\_01%20-%20BlueHatIL%20-%20Trends%2C%20challenge%2C%20and%20shifts%20in%20software%20vulnerability%20mitigation.pdf](https://github.com/microsoft/MSRC-Security-Research/blob/master/presentations/2019_02_BlueHatIL/2019_01%20-%20BlueHatIL%20-%20Trends%2C%20challenge%2C%20and%20shifts%20in%20software%20vulnerability%20mitigation.pdf) Microsoft Security Response Center (MSRC).
- [20] Vikram Nitin, Rahul Krishna, Luiz Lemos do Valle, and Baishakhi Ray. 2025. C2SaferRust: Transforming C Projects into Safer Rust with NeuroSymbolic Techniques. arXiv:2501.14257 [cs.SE] <https://arxiv.org/abs/2501.14257>
- [21] Vikram Nitin, Rahul Krishna, and Baishakhi Ray. 2025. SpecTra: Enhancing the Code Translation Ability of Language Models by Generating Multi-Modal Specifications. arXiv:2405.18574 [cs.SE] <https://arxiv.org/abs/2405.18574>
- [22] Miguel Ojeda et al. 2022. Rust for Linux. *Linux Kernel Mailing List* (2022). <https://rust-for-linux.com/> Rust support merged in Linux 6.1.
- [23] OpenAtom Foundation. [n.d.]. OpenHarmony: A distributed operating system for all scenarios. <https://gitee.com/openharmony>.
- [24] Guangsheng Ou, Mingwei Liu, Yuxuan Chen, Xin Peng, and Zibin Zheng. 2024. Repository-level code translation benchmark targeting rust. *arXiv preprint arXiv:2411.13990* (2024).
- [25] Baptiste Roziere, Marie-Anne Lachaux, Lowik Chanussot, and Guillaume Lample. 2020. Unsupervised Translation of Programming Languages. In *Advances in Neural Information Processing Systems*, H. Larochelle, M. Ranzato, R. Hadsell, M.F. Balcan, and H. Lin (Eds.), Vol. 33. Curran Associates, Inc., 20601–20611. [https://proceedings.neurips.cc/paper\\_files/paper/2020/file/ed23fbf18c2cd35f8c7f8de44f85c08d-Paper.pdf](https://proceedings.neurips.cc/paper_files/paper/2020/file/ed23fbf18c2cd35f8c7f8de44f85c08d-Paper.pdf)
- [26] Momoko Shiraishi, Yinzhi Cao, and Takahiro Shinagawa. 2024. SmartC2Rust: Iterative, Feedback-Driven C-to-Rust Translation via Large Language Models for Safety and Equivalence. <https://api.semanticscholar.org/CorpusID:272689595>
- [27] The Chromium Project. 2020. Memory Safety. <https://www.chromium.org/Home/chromium-security/memory-safety/> Accessed: 2026-01-27.
- [28] The White House. 2024. *Back to the Building Blocks: A Path Toward Secure and Measurable Software*. Technical Report. The White House. <https://bidenwhitehouse.archives.gov/wp-content/uploads/2024/02/Final-ONCD-Technical-Report.pdf>
- [29] Chaofan Wang, Tingrui Yu, Beijun Shen, Jie Wang, Dong Chen, Wenrui Zhang, Yuling Shi, Chen Xie, and Xiaodong Gu. 2026. EvoC2Rust: A Skeleton-guided Framework for Project-Level C-to-Rust Translation. arXiv:2508.04295 [cs.SE] <https://arxiv.org/abs/2508.04295>
- [30] Feng Wang, Yuqing Li, and Han Xiao. 2025. jina-reranker-v3: Last but Not Late Interaction for Listwise Document Reranking. arXiv:2509.25085 [cs.CL] <https://arxiv.org/abs/2509.25085>
- [31] Qingxiao Xu and Jeff Huang. 2025. Optimizing Type Migration for LLM-Based C-to-Rust Translation: A Data Flow Graph Approach. In *Proceedings of the 14th ACM SIGPLAN International Workshop on the State Of the Art in Program Analysis*. 8–14.
- [32] Aidan Z. H. Yang, Yoshiki Takashima, Brandon Paulsen, Josiah Dodds, and Daniel Kroening. 2024. VERT: Verified Equivalent Rust Transpilation with Large Language Models as Few-Shot Learners. arXiv:2404.18852 [cs.PL] <https://arxiv.org/abs/2404.18852>
- [33] Zhen Yang, Fang Liu, Zhongxing Yu, Jacky Wai Keung, Jia Li, Shuo Liu, Yifan Hong, Xiaoxue Ma, Zhi Jin, and Ge Li. 2024. Exploring and unleashing the power of large language models in automated code translation. *Proceedings of the ACM on Software Engineering* 1, FSE (2024), 1585–1608.
- [34] Zhiqiang Yuan, Wenjun Mao, Zhuo Chen, Xiyue Shang, Chong Wang, Yiling Lou, and Xin Peng. 2025. Project-Level C-to-Rust Translation via Synergistic Integration of Knowledge Graphs and Large Language Models. arXiv:2510.10956 [cs.SE]

<https://arxiv.org/abs/2510.10956>

- [35] Hanliang Zhang, Cristina David, Yijun Yu, and Meng Wang. 2023. Ownership Guided C to Rust Translation. In *Computer Aided Verification: 35th International Conference, CAV 2023, Paris, France, July 17–22, 2023, Proceedings, Part III* (Paris, France). Springer-Verlag, Berlin, Heidelberg, 459–482. doi:10.1007/978-3-031-37709-9\_22
- [36] Hanliang Zhang, Cristina David, Yijun Yu, and Meng Wang. 2023. Ownership guided C to Rust translation. In *International Conference on Computer Aided Verification*. Springer, 459–482.
- [37] Ruxin Zhang, Shanxin Zhang, and Linbo Xie. 2025. A systematic exploration of C-to-rust code translation based on large language models: prompt strategies and automated repair. *Automated Software Engineering* 33 (10 2025). doi:10.1007/s10515-025-00570-0
- [38] Ruxin Zhang, Shanxin Zhang, and Linbo Xie. 2025. A systematic exploration of C-to-rust code translation based on large language models: prompt strategies and automated repair. *Automated Software Engineering* 33, 1 (2025), 21. doi:10.1007/s10515-025-00570-0
- [39] Han Zhou, Yu Luo, Mengtao Zhang, and Dianxiang Xu. 2025. C2RustTV: An LLM-based Framework for C to Rust Translation and Validation. In *2025 IEEE 49th Annual Computers, Software, and Applications Conference (COMPSAC)*. 1254–1259. doi:10.1109/COMPSAC65507.2025.00158
- [40] Shuyan Zhou, Uri Alon, Frank F. Xu, Zhengbao Jiang, and Graham Neubig. 2023. DocPrompting: Generating Code by Retrieving the Docs. In *The Eleventh International Conference on Learning Representations*. <https://openreview.net/forum?id=ZTCxT2t2Ru>
- [41] Tianyang Zhou, Ziyi Zhang, Haowen Lin, Somesh Jha, Mihai Christodorescu, Kirill Levchenko, and Varun Chandrasekaran. 2025. SACTOR: LLM-Driven Correct and Idiomatic C to Rust Translation with Static Analysis and FFI-Based Verification. arXiv:2503.12511 [cs.SE] <https://arxiv.org/abs/2503.12511>

Received 20 February 2007; revised 12 March 2009; accepted 5 June 2009