

BLITZRANK: Principled Zero-shot Ranking Agents with Tournament Graphs

Sheshansh Agrawal^{*1} Thien Hang Nguyen^{*1} Douwe Kiela¹

Abstract

Selecting the top m from n items via expensive k -wise comparisons is central to settings ranging from LLM-based document reranking to crowdsourced evaluation and tournament design. Existing methods either rely on heuristics that fail to fully exploit the information each comparison reveals, or are inefficient when they do. We introduce a *tournament graph* framework that provides a principled foundation for k -wise ranking. Our key observation is that each k -item comparison reveals an induced tournament of $\binom{k}{2}$ pairwise preferences; aggregating these into a global preference graph and computing its transitive closure yields many additional orderings without further oracle calls. We formalize when the current top- m output is *certifiably determined* and design a greedy query schedule that maximizes information gain towards identifying the top- m items. The framework also gracefully handles non-transitive preferences – cycles induced by real-world oracles – by collapsing them into equivalence classes that yield principled *tiered rankings*. Applied to LLM reranking across 14 benchmarks and 5 models, BLITZRANK achieves Pareto dominance over existing approaches: matching or exceeding accuracy while requiring 25–40% fewer tokens than comparable methods, and $7\times$ fewer than pairwise reranking at near-identical quality.

1. Introduction

Consider the classic *25 horses’ race puzzle*: given 25 horses where 5 can race at a time, what is the minimum number of races needed to identify the 3 fastest?

The answer – 7 races – is well known (Zhou & Jiu, 2008), but the reasoning reveals a deeper principle. A naive tournament bracket uses each race only to identify a winner.

^{*}Equal contribution ¹Contextual AI. Correspondence to: Sheshansh Agrawal <sheshansh@contextual.ai>, Thien Hang Nguyen <thien.nguyen@contextual.ai>.

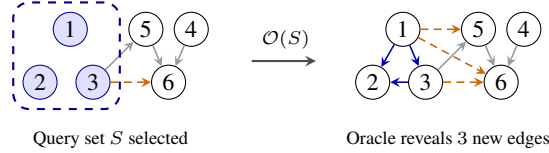

Figure 1. A k -wise oracle query on $n=6$ candidates. **Left:** A query set S of $k=3$ candidates (shaded) is selected. **Right:** The oracle returns a tournament on S , revealing $\binom{3}{2}=3$ new edges (blue). Combined with prior edges (gray), additional preferences are inferred transitively (orange dashed).

The optimal strategy extracts *all* the information each race provides: a race among 5 horses reveals not just the winner, but a complete ordering – 10 pairwise comparisons from a single query. By accumulating these comparisons and reasoning about their transitive implications, one can certify the top 3 with far fewer races than a bracket requires.

This paper develops a principled framework for this class of problems: *top- m selection from n items via k -wise comparison queries*. Each query to an oracle reveals the induced tournament on up to k items – $\binom{k}{2}$ pairwise preferences – and the goal is to identify the top- m items using as few queries as possible. The problem arises naturally whenever comparisons are expensive: LLM-based document reranking, crowdsourced preference judgments, human-in-the-loop evaluation, and tournament design. In all these settings, each query incurs cost in time, money, or human attention, making query efficiency paramount.

Existing methods leave information on the table. Classical sorting algorithms adapted for k -wise comparisons – heapsort (Zhuang et al., 2024b; Qin et al., 2024), tournament brackets (Chen et al., 2025), sliding windows (Sun et al., 2023) – use each query primarily to identify a *winner*, often discarding the $\binom{k}{2} - (k-1)$ additional pairwise relationships revealed. Pointwise methods that score items independently ignore relative information entirely. To our knowledge, existing approaches do not provide a *principled* framework for accumulating comparison outcomes and certifying when the top- m are determined.

We propose a *tournament graph* framework and an algorithm BLITZRANK¹ that addresses these limitations.

¹The name BLITZRANK evokes blitz chess, where rapid tournament play efficiently determines complete rankings.

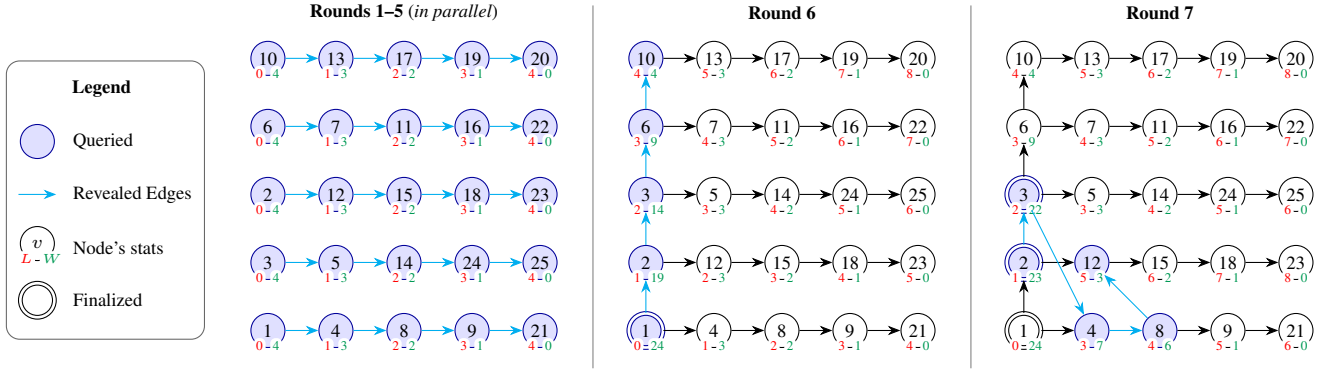

Figure 2. Illustration of BLITZRANK (Algorithm 1) achieving the optimal 7 queries on the classic 25 horses puzzle, where $(n, k, m) = (25, 5, 3)$. Each node shows the horse ID with $L(u) := |R_G^-(u)|$ at bottom left and $W(u) := |R_G^+(u)|$ at bottom right (cf. (1) and (2)). Blue nodes indicate horses queried in that round. In this transitive instance, $\kappa_G(u) = L(u) + W(u)$, and double circles indicate resolved horses (where $\kappa_G(u) = 24$).

Note: For reproducibility, the initial ordering was generated with Python’s `random.shuffle` on $[1, 2, \dots, 25]$ with `seed=42`. The first five rounds are grouped as shown.

The key observation is that each k -wise comparison reveals an induced tournament on the queried items, and these local tournaments can be aggregated into a global preference graph. Crucially, the graph’s *transitive closure* yields additional orderings without further queries: observing $a \succ b$ and $b \succ c$ implies $a \succ c$. We formalize when a node is *resolved* – its relationship to all $n - 1$ others determined – and design an algorithm that terminates once the current top- m are certified. Applied to the 25 horses puzzle, the algorithm discovers the optimal 7-race strategy without being given any problem-specific knowledge (Figure 2).

The framework also addresses a phenomenon that prior work largely overlooks: *non-transitive preferences*. Real-world oracles – LLMs, crowdworkers, domain experts – sometimes produce cyclic judgments: $A \succ B \succ C \succ A$. Rather than treating cycles as noise to be averaged away, we treat them as structure: cycles indicate that the oracle does not admit a consistent global order among those items. Our framework captures this via *strongly connected components* (SCCs): items in cycles form equivalence classes, and condensing the graph into SCCs yields a DAG of “relevance tiers.” A key theoretical insight is that the condensation of any tournament is itself a transitive tournament, allowing all machinery from the transitive case to be lifted to the general case. The *same algorithm* handles both settings – returning a total ordering when preferences are consistent, and a principled tiered ranking otherwise.

Contributions.

1. **A unifying theoretical framework.** We formalize top- m selection via k -wise comparison oracles using tournament graphs (§2). The framework captures how transitive closure amplifies each query’s information

yield, defines when items are *resolved*, and unifies transitive and non-transitive preferences.

2. **A provably correct algorithm.** We present BLITZRANK, a greedy algorithm that schedules queries among minimally-resolved SCCs to guarantee progress (§2.4). We prove correctness and termination in both transitive and non-transitive settings.
3. **Empirical validation.** Across 14 benchmarks and 5 LLM oracles, our approach achieves Pareto dominance: matching or exceeding baseline accuracy while requiring 25–40% fewer tokens than methods with comparable structure, and $7\times$ fewer than pairwise reranking at near-identical quality (§4). Convergence is predictable (coefficient of variation $\approx 2\%$ in query count), and our analysis confirms that cycles capture genuinely ambiguous documents rather than noise.

Overview. Section 2 presents the tournament graph framework, including the revealed-graph formalism, the SCC-based extension to non-transitive preferences, and the BLITZRANK algorithm with its main guarantees. Section 3 situates our approach within prior work on LLM reranking, tournament methods, and multi-wise comparison. Section 4 evaluates BLITZRANK empirically on document reranking benchmarks, and the conclusion discusses limitations and directions for future work. The appendices develop the full theory and additional experimental details, including complete proofs, and the query complexity discussion.

2. Tournament Graph Framework

2.1. Problem Setup

Let V be a set of n items and $G^* = (V, E^*)$ be a fixed but unknown tournament, representing the oracle’s latent preferences: for every pair $u \neq v$, exactly one of (u, v)

Code available at <https://github.com/ContextualAI/BlitzRank>.

or (v, u) belongs to E^* . We access G^* through a k -wise comparison oracle O_{G^*} : given any queried set $S \subseteq V$ with $|S| \leq k$, returns all directed edges of G^* induced by S .

Our ranking target is reachability-based. For a directed graph G , write $u \rightsquigarrow_G v$ if there is a directed path from u to v , and define the *in-reach* of v by

$$R_G^-(v) := \{u \in V \setminus \{v\} : u \rightsquigarrow_G v\}.$$

The task is to identify m vertices with smallest in-reach using as few oracle queries as possible. When G^* is transitive, in-reach coincides with in-degree, so this reduces to the usual loss-count ordering; in general, the reachability view extends naturally to cyclic preferences. Formal definitions and discussion appear in Appendix E.

2.2. Revealed Graph and Transitive Inference

We maintain a *revealed graph* $G = (V, E)$ that accumulates edges returned by the oracle. Initially $E = \emptyset$; after querying a set S , we add the revealed edges $O_{G^*}(S)$ to E . By construction, G is always a subgraph of G^* .

The key point is that G contains more information than its explicit edges. If $u \rightsquigarrow_G v$, then the transitive preference $u \succ v$ is already certified in the unknown tournament, even if the edge (u, v) was never queried directly. In this sense, each query is amplified by reachability: a newly revealed edge can combine with existing paths to certify many additional pairwise relations.

For a vertex v , we also consider its out-reach

$$R_G^+(v) := \{u \in V \setminus \{v\} : v \rightsquigarrow_G u\}.$$

The vertices whose relation to v is already determined form the known-relationship set

$$K_G(v) := R_G^-(v) \cup R_G^+(v), \quad \kappa_G(v) := |K_G(v)|.$$

When $\kappa_G(v) = n - 1$, the comparison between v and every other vertex is already implied by the revealed graph; we call such a vertex *resolved*. At that point, its discovered in-reach is already its true in-reach in G^* , so further queries cannot change its rank. We use this as a practical stopping rule for algorithm design: we terminate once the current top- m vertices by discovered in-reach are resolved. The full finalization framework is presented in Section F.

2.3. Non-Transitive Preferences

When the oracle produces cycles $(a \succ b \succ c \succ a)$, a global total order may not exist. We treat this not as noise, but as signal: cycles indicate groups of items that the oracle does not consistently separate. *Strongly connected components* (SCCs) are the primary object of analysis in this setting. Vertices in the same SCC reach one another

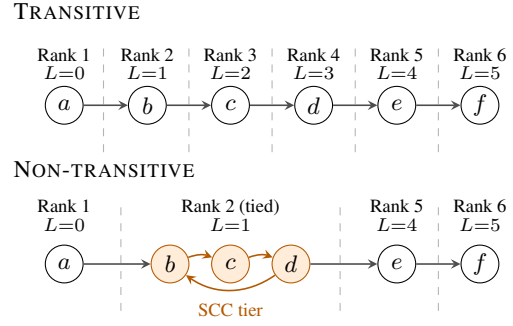

Figure 3. Tournament graphs with $n=6$ candidates. **Top (transitive)**: Consistent preferences yield a total ordering; each node has a unique rank determined by $L(u) := |R_G^-(u)|$, the number of vertices that reach it. **Bottom (non-transitive)**: A cycle $b \succ c \succ d \succ b$ forms a strongly connected component (orange). Nodes in the SCC share the same tier since no consistent ordering exists among them, but the partial order $a \succ \{b, c, d\} \succ e \succ f$ is still recovered.

in both directions, so they behave as a tied tier under reachability-based ranking. Collapsing each SCC to a supernode gives the *condensation* $[G]$, which is always a DAG; for tournaments, the condensation is in fact a transitive tournament. This induces a total order on SCC tiers even when the original graph contains cycles.

Accordingly, our output in the non-transitive case is a *tiered ranking*: SCCs are ordered from best to worst, while vertices inside the same SCC are tied (see Figure 3). When all SCCs are singletons, this reduces to the transitive case and yields a total ordering. For top- m selection, if the boundary tier is larger than the remaining quota, any subset of the required size from that tier is a valid output.²

At a high level, the algorithm operates on the discovered SCC structure while maintaining the same vertex-level resolution criterion from the previous subsection. Part II of the appendix develops the full theory, including why discovered SCCs refine the true ones and why reasoning on the condensation is enough to certify correctness.

2.4. Algorithm: BLITZRANK

BLITZRANK (Algorithm 1) realizes the tournament graph framework. At each iteration, the algorithm recomputes the discovered in-reach $|R_G^-(v)|$ and known-relationship count $\kappa_G(v)$ for every vertex, forms the current top- m set T by smallest discovered in-reach, and stops once every vertex in T is resolved. If not, it computes the condensation $[G]$ and greedily queries representatives from the unresolved SCCs with the smallest in-reaches in the condensation graph.

Why greedy scheduling works. The greedy step operates

²If a total order is required, ties inside a tier can be broken by a secondary signal such as the original retrieval score.

Algorithm 1 BLITZRANK

```

1: Input: vertex set  $V$  with  $|V| = n$ , oracle  $O_{G^*}$ ,
   maximum query size  $k$ , target count  $m$ 
2: Output: a valid top- $m$  output for the underlying
   tournament  $G^*$ 
3: Initialize  $E \leftarrow \emptyset, G \leftarrow (V, E)$ 
4: loop
5:   // Compute vertex metrics
6:   for each  $u \in V$  do
7:     Compute  $|R_G^-(u)|$  and  $\kappa_G(u)$ 
8:   end for
9:   // Identify resolved vertices and current top- $m$ 
   candidates
10:   $F \leftarrow \{u \in V : \kappa_G(u) = n - 1\}$  {resolved vertices}
11:   $T \leftarrow$  the  $m$  vertices with smallest  $|R_G^-(\cdot)|$ 
12:  // Termination condition: current top candidates are
   resolved
13:  if  $T \subseteq F$  then
14:    return  $T$  sorted by ascending  $|R_G^-(\cdot)|$ 
15:  end if
16:  // Greedy Schedule
17:  Compute condensation  $[G]$  of the revealed graph  $G$ 
18:   $\mathcal{C} \leftarrow$  SCCs containing  $\geq 1$  vertex with  $\kappa_G(u) <$ 
    $n - 1$ , ordered by ascending in-reach in  $[G]$ 
19:   $Q \leftarrow \{\text{rep}(C) : C \in \mathcal{C}[1 : k']\}$  where  $k' =$ 
    $\min(k, |\mathcal{C}|)$  {one representative per SCC}
20:  // Query and update
21:   $E \leftarrow E \cup O_{G^*}(Q), G \leftarrow (V, E)$ 
22: end loop

```

on SCCs ordered by ascending in-reach in the condensation. The progress argument has two parts. First, at any non-terminal iteration, the earliest unresolved SCCs are tied in condensation in-reach; this follows from the general structural lemma on tied candidates after the finalization threshold (Lemma 22), applied to $[G]$, with the fact that these tied SCCs indeed contain unresolved vertices (Lemma 59). Second, once two SCCs are tied, the forced-tie property (Lemma 46) implies that there is no edge between them in the condensation and thus no revealed edge between any of their members in G . Querying representatives from such SCCs therefore uncovers at least one new edge and progress is guaranteed at every round. This is the key behind the termination proof for BLITZRANK; see Theorem 60 in Appendix I.

Parallelization. When k is small relative to n , multiple disjoint groups can be queried in parallel. The algorithm naturally supports this because unresolved SCCs are handled independently until they become connected by newly revealed edges.

2.5. Guarantees

Correctness and termination. BLITZRANK stops when the current top- m vertices by discovered in-reach are all resolved. As discussed in the greedy-scheduling paragraph above, every non-terminal iteration reveals at least one new edge, so the algorithm cannot stall before this stopping condition is met. The formal termination argument appears in Theorem 60, with the condensation-based proof strategy situated in the appendix overview (§E.4).

Why does this stopping rule certify correctness? At termination, every vertex in the returned top- m set has its relation to every other vertex already determined by the revealed graph. This means its discovered in-reach is strong enough to compare it against any outside candidate, so the current top- m set is already a valid top- m output in the true tournament. The appendix makes this precise through the resolved-vertex comparison lemma and its corollary (Lemma 54 and Corollary 56), culminating in Theorem 57.

Query Complexity. The worst-case query count is $\binom{n}{2}$, but in practice BLITZRANK terminates much sooner. For example, Figure 2 shows BLITZRANK achieves the optimal 7 queries. For top-1 selection ($m = 1$), we prove that the algorithm terminates in at most $\lceil (n - 1)/(k - 1) \rceil$ queries – each query eliminates at least $k - 1$ candidates from contention (Proposition 62). For general m , once tie-breaking in Algorithm 1 is canonicalized, we conjecture a bound of $O((n - 1)/(k - 1) + (m - 1)/(k - 1) \cdot \log_k m)$, decomposing into a *candidate reduction* term and a *frontier refinement* term (Conjecture 63). Empirically, across configurations with n from 100 to 800 and k from 5 to 50, the observed query counts remain within a factor of 1.25 of this conjectured form (Figure 10), suggesting the bound is tight up to lower-order terms. A formal proof for $m > 1$ remains open; see Appendix J for details.

3. Related Work

LLM-based document reranking. LLM reranking methods fall into three paradigms. *Pointwise* methods score documents independently, enabling parallelism but discarding relative information; while trained cross-encoder models (Contextual AI, 2025) dominate in efficiency, zero-shot LLM approaches include query likelihood (Sachan et al., 2022), which scores passages by $P(\text{query}|\text{document})$, and relevance classification with fine-grained labels (Zhuang et al., 2024a). *Pairwise* methods recover relative preferences: Qin et al. (2024) introduced Pairwise Ranking Prompting with heapsort aggregation at $O(n \log n)$ comparisons, noting that “pairwise comparisons are not guaranteed to be transitive.” *Listwise* methods compare multiple documents per call: RankGPT (Sun et al., 2023) and LRL (Ma et al., 2023) concurrently established the sliding-window

paradigm, processing windows of 20 documents with stride 10, while subsequent work distilled this into open-source models (Pradeep et al., 2023a;b). AcuRank (Yoon et al., 2025) maintains Gaussian distributions over document relevance and performs Bayesian updates via TrueSkill, selectively reranking uncertain documents until confidence criteria are met. These methods use fixed window sizes, which is problematic when document lengths vary or when long-context limitations – positional attention degradation (Liu et al., 2024) and effective context far below claimed capacity (Hsieh et al., 2024) – hurt performance; our framework accommodates variable k per round, adapting to both content and model constraints.

The *setwise* approach (Zhuang et al., 2024b) bridges pairwise and listwise by prompting the LLM to select the most relevant from k candidates, using this primitive within heapsort. While more efficient than pairwise, setwise extracts only the *winner*, discarding the remaining $\binom{k}{2} - (k - 1)$ pairwise relationships. Our framework differs by extracting the *complete tournament* from each k -wise comparison and accumulating edges where transitive closure amplifies each query’s information yield.

Handling inconsistency in LLM rankings. LLM judgments frequently violate transitivity. Zeng et al. (2024) address this via LLM-RankFusion, measuring inconsistency patterns and resolving them through rank aggregation. Tang et al. (2024) show that shuffling and Kemeny-optimal aggregation mitigate positional biases; similarly, TourRank (Chen et al., 2025) runs multiple parallel tournaments with different random seeds and aggregates scores. Most related to our approach, ELSPR (Yu et al., 2025) uses SCC analysis to quantify non-transitivity via structural entropy, but applies it to filter training examples for evaluator LLMs rather than for query-efficient selection. REALM (Wang et al., 2025) takes a probabilistic approach, modeling relevance as Gaussian distributions updated via Bayesian inference. Our framework offers a deterministic alternative that interprets cycles as meaningful structure – tiered rankings – rather than noise to be resolved.

Tournament theory and multi-wise comparisons. Our framework builds on tournament graph theory (Brandt et al., 2016; Laslier, 1997; Landau, 1953). The query complexity of tournament solutions under a pairwise oracle was studied by Dey (2017), who proved that finding the Copeland set, Slater set, and most other solutions requires $\Omega(n^2)$ queries in the worst case. When the top cycle has bounded size c , all solutions can be found in $O(nc + n \log n / \log(1 - 1/c))$ queries; however, this identifies only the first SCC (the top cycle) and does not recover the full condensation ordering over all components.

On the multi-wise comparison side, Ren et al. (2021) establish that full-ranking feedback from k -wise

comparisons improves sample complexity by a factor of $k \log k$ over winner feedback, and Saha & Gopalan (2019) show similar gains under the Plackett–Luce model. These results, along with near-optimal top- m algorithms under parametric models (Jang et al., 2017; Chen et al., 2018), assume stochastic comparison models and target total rankings rather than structural objectives like SCC recovery.

Our setting differs from all of the above in three respects: (i) we assume a deterministic tournament rather than a stochastic comparison model, (ii) we use a k -wise oracle ($k \geq 2$) that reveals complete induced tournaments rather than restricting to pairwise queries or winner-only feedback, and (iii) we target the SCC decomposition ordering – a tiered ranking that declares cyclic items tied – rather than a total ranking or a single tournament solution set. To our knowledge, no existing algorithm addresses this combination. A more detailed discussion of theoretical foundations appears in Appendix E.3.

4. Experiments

We evaluate BLITZRANK (Algorithm 1) on standard document reranking benchmarks. Although the framework applies to any ranking problem with a k -wise comparison oracle (§2.1), we focus on the established retrieve-then-rerank pipeline where an LLM serves as the zero-shot reranking oracle.

Our experiments address two questions: (1) Does principled exploitation of k -wise comparisons – extracting full tournaments and propagating information via transitive closure (§2.2) – translate to practical efficiency gains over methods that discard this structure? (2) Do these efficiency gains come at the cost of ranking quality, or can our framework match existing approaches while using fewer oracle calls? We evaluate across 14 datasets spanning diverse domains, 5 LLM oracles, and compare against baselines representing the spectrum of reranking strategies.

4.1. Setup

Datasets. We evaluate on 14 datasets: six TREC Deep Learning tracks (DL19–DL23, DL-Hard) (Craswell et al., 2020; 2021; 2025a;b;c; Mackie et al., 2021) and eight BEIR datasets (TREC-COVID, NFCorpus, Signal-1M, News, Robust04, Touché, DBPedia, SciFact) (Thakur et al., 2021). For each dataset, BM25 (Robertson et al., 2009) retrieves the top-100 candidates per query.

Metrics. We measure ranking quality via nDCG@10 (Järvelin & Kekäläinen, 2002) and efficiency via input tokens per query – isolating algorithmic efficiency from implementation details.

Baselines. We compare against five LLM-based reranking

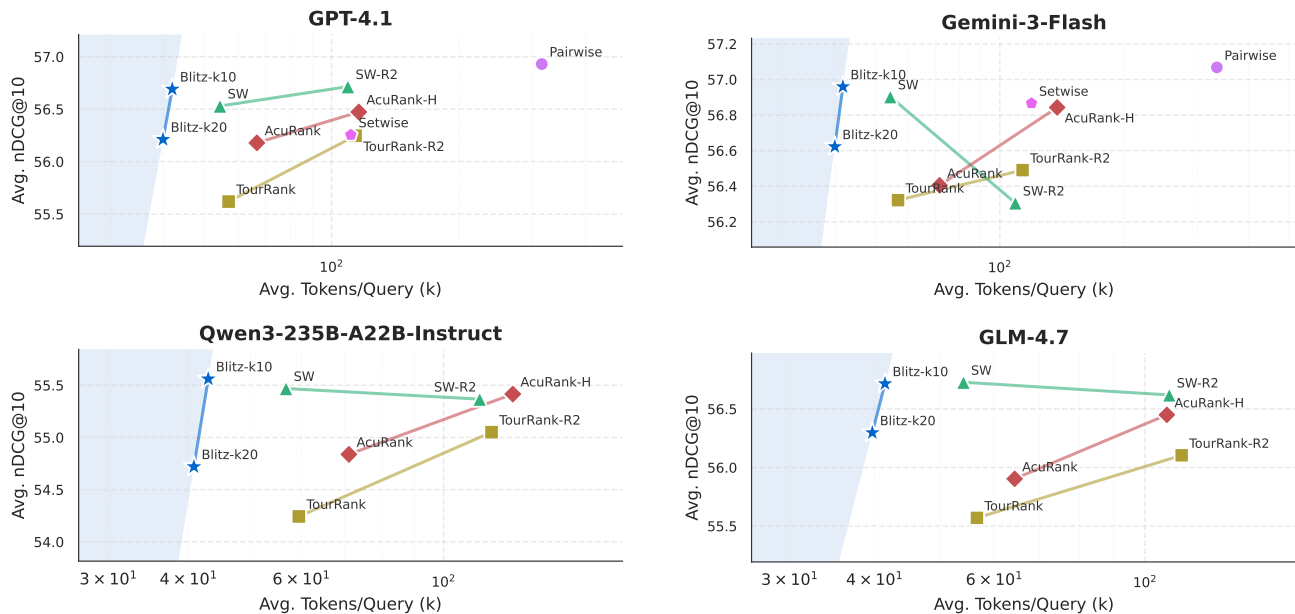

Figure 4. Pareto frontiers showing the accuracy-efficiency trade-off across LLM oracles. BLITZRANK (Algorithm 1) consistently occupies the upper-left region, achieving competitive accuracy with 25–40% fewer tokens than methods with comparable structure (§B).

methods: Sliding Windows (Sun et al., 2023) (single-pass and two-pass), TourRank (Chen et al., 2025) (single and two-round), AcuRank (Yoon et al., 2025) (standard and high-precision), Setwise (Zhuang et al., 2024b), and Pairwise (Qin et al., 2024). See Appendix A for detailed comparison rationale.

Oracles. All methods use the same underlying LLM with the RankGPT prompt format (Sun et al., 2023), differing only in their ranking strategy. We evaluate five LLMs (2 closed-source and 3 open-source models): GPT-4.1, Gemini-3-Flash, GLM-4.7 (Team et al., 2025), DeepSeek-V3.2 (DeepSeek-AI et al., 2025), and Qwen3-235B-A22B-Instruct (Team, 2025). Using diverse LLMs enables examination of generalization of efficiency gains across oracles of varying capability.

Our method. We evaluate BLITZRANK, or simply BLITZ, with two window sizes: $k = 10$ and $k = 20$. We set target $m = 10$, so BLITZRANK terminates once the current top-10 documents are resolved.

4.2. Main Results: Accuracy-Efficiency Frontier

Table 3 summarizes ranking accuracy (nDCG@10) and efficiency (input tokens per query) across 14 datasets and 5 LLM oracles. Figure 4 visualizes the resulting Pareto frontiers. The central finding is that our tournament graph framework achieves comparable or superior ranking quality while consuming substantially fewer tokens – validating the hypothesis that accumulating pairwise information via transitive closure yields practical efficiency gains.

Efficiency gains. BLITZRANK requires significantly fewer tokens than all baselines across every oracle. With GPT-4.1, BLITZ-k10 and BLITZ-k20 consume 42k and 40k tokens per query, respectively – a 22–26% reduction compared to SW (54k) and TourRank (57k), and 37–40% fewer than AcuRank (67k). The gap widens dramatically against comparison-based methods: Pairwise requires 315k tokens ($7.5\times$ more than BLITZ-k10) and Setwise requires 111k tokens ($2.6\times$ more). Higher-computation variants exacerbate these differences: SW-R2 (109k), TourRank-R2 (114k), and AcuRank-H (116k) all consume $2.6\text{--}2.9\times$ more tokens than BLITZ-k10.

Ranking quality. Despite using fewer oracle calls, BLITZRANK matches or exceeds baseline accuracy across most configurations. With GPT-4.1, BLITZ-k10 achieves 56.7 average nDCG@10 – matching the best sliding-window variant (SW-R2: 56.7) at less than 40% of its token cost, and outperforming SW (56.5), TourRank (55.6), TourRank-R2 (56.2), AcuRank (56.2), AcuRank-H (56.5), and Setwise (56.3). Only Pairwise achieves marginally higher accuracy (56.9), but at $7.5\times$ the cost. The pattern holds across oracles: with Gemini-3-Flash, BLITZ-k10 achieves 57.0 nDCG@10, within 0.1 points of Pairwise (57.1) while using $8\times$ fewer tokens; with GLM-4.7, BLITZ-k10 (56.7) matches SW (56.7) and exceeds TourRank (55.6) and AcuRank (55.9).

Pareto dominance. The Pareto frontiers in Figure 4 crystallize these trade-offs. Across all oracles, BLITZRANK consistently occupies the upper-left region of the accuracy-efficiency space – achieving quality comparable to the

most accurate methods at a fraction of their cost. Methods that match BLITZ-k10’s accuracy (e.g., SW-R2, AcuRank-H) require 2–3× more tokens; methods that match its efficiency (none among baselines) achieve lower accuracy. This Pareto dominance validates our core hypothesis: principled exploitation of tournament structure – extracting full orderings and reasoning about transitive implications – translates to practical efficiency gains without sacrificing ranking quality. Appendix B provides further details and analysis on efficiency.

Model generalization. The efficiency-accuracy trade-off generalizes robustly across all five LLM oracles. With Gemini-3-Flash, BLITZ-k10 achieves 57.0 nDCG@10 – within 0.1 points of Pairwise (57.1) – while consuming 8× fewer tokens (42k vs. 334k). With GLM-4.7, BLITZ-k10 matches the best single-pass baseline (SW: 56.7) at 24% lower token cost (41k vs. 54k), while substantially outperforming TourRank (55.6) and AcuRank (55.9). With DeepSeek-V3.2, SW achieves the highest accuracy (57.3), but BLITZ-k10 (56.6) still outperforms TourRank (55.5) and AcuRank (56.0) at lower cost. With Qwen3-235B – the weakest oracle in absolute terms – BLITZ-k10 (55.6) exceeds all baselines except SW (55.5, within noise), again at reduced token consumption (43k vs. 57k).

4.3. Effect of Window Size

BLITZRANK has a single hyperparameter: the window size k . Across all 5 oracles (Table 3), BLITZ-k10 consistently outperforms BLITZ-k20 in ranking quality: by 0.5 with GPT-4.1 (56.7 vs. 56.2), 0.4 with Gemini-3-Flash (57.0 vs. 56.6), and 0.9 with Qwen3-235B (55.6 vs. 54.7). The token cost difference between configurations is modest (40–43k), suggesting that smaller windows, with more queries but finer-grained comparisons, provide better accuracy.

Counterintuitively, $k=10$ outperforms $k=20$ despite comparing fewer documents per query. Our SCC analysis (§4.4) reveals that larger windows cause LLMs to produce more cyclic judgments among similar documents – likely due to the “lost in the middle” phenomenon (Liu et al., 2024). With $k=20$, the average SCC size at convergence is 1.18 compared to 1.07 for $k=10$, indicating that larger windows create more ties that cannot be resolved.

Additionally, convergence is highly predictable: for $k=10$, BLITZRANK terminates in 12–15 rounds (mean 13.6, std 0.58); for $k=20$, only 6–7 rounds (mean 6.7, std 0.45). This reflects the progress guarantee of the greedy SCC schedule and the resulting finite termination of the practical algorithm (Theorem 60), enabling reliable cost estimation. See Appendix C for detailed convergence analysis.

Table 1. SCC statistics at convergence on DL19 (43 queries) using GPT-4.1. Larger k requires fewer rounds but produces more cycles. This reflects a pattern of increased cycle occurrences when comparing many documents simultaneously.

Config	Queries	#Rounds	Final #SCCs	Avg SCC Size
$k = 10$	43	13.4	93.7	1.069
$k = 20$	43	6.6	85.3	1.180

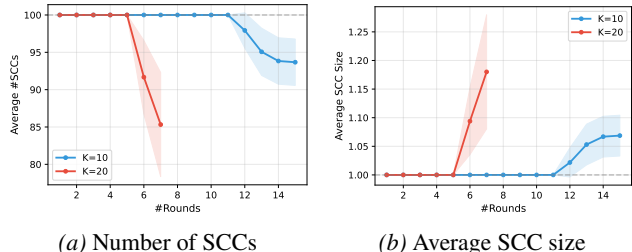

Figure 5. Evolution of SCCs on DL19 with GPT-4.1. Solid lines and shaded regions show means and variance across queries, respectively. (a) Both k ’s begin with 100 singleton SCCs. $k=20$ forms cycles earlier (rounds 5–7), ending with ~ 85 SCCs. $k=10$ forms fewer cycles and also later. (b) Average SCC size follows a similar pattern: $k=20$ reaches 1.18 average size by round 7, while $k=10$ reaches only 1.07 by round 15.

4.4. Analysis of Strongly Connected Components

Strongly connected components (SCCs) emerge when the oracle produces cyclic preferences. Rather than treating such cycles as noise, our framework interprets them as genuine ambiguity (§2.3): documents within an SCC form a “tie tier” that the oracle cannot distinguish. We analyze SCCs formed by BLITZRANK on DL19 (43 queries) using GPT-4.1 to understand when and why cycles arise, and what they reveal about ranking difficulty.

Evolution of Strongly Connected Components. Table 1 summarizes SCC statistics at convergence, and Figure 5 traces their evolution across rounds. Both configurations begin with 100 singleton SCCs (one per document). With $k=20$, merging begins earlier – around rounds 5–7 – as BLITZRANK compares larger document sets where cyclic judgments are more likely. By convergence, $k=20$ produces 85.3 SCCs with average size 1.18, while $k=10$ produces 93.7 SCCs with average size 1.07.

The shaded regions in Figure 5 indicate variance across queries. The $k=20$ configuration exhibits higher variance in both SCC count and size, reflecting greater sensitivity to query-specific document similarity. This explains the accuracy gap between configurations (Table 3): larger windows induce more ties, and ties at the top- m boundary directly impact nDCG@10.

Larger windows produce larger SCCs. At every rank position, $k=20$ produces larger SCCs than $k=10$. The effect is most pronounced in mid-ranks: at rank 15, $k=20$ averages

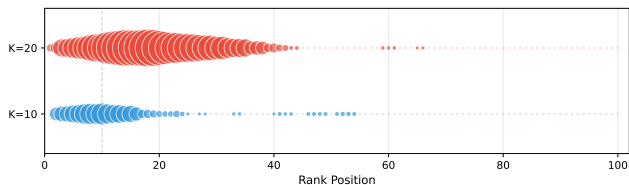
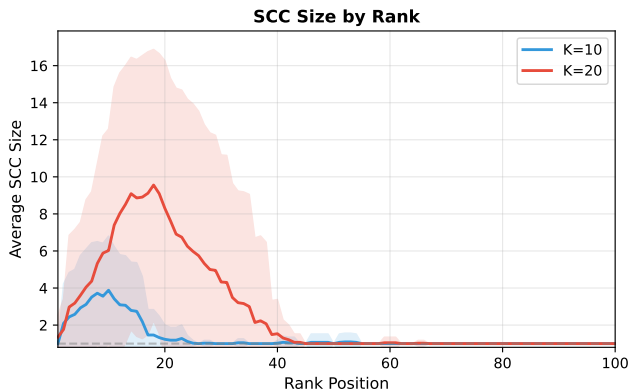
(a) SCC locations by rank position (bubble size \propto SCC size)

(b) Average SCC size by rank position

Figure 6. Spatial distribution of strongly connected components after convergence on DL19 using GPT-4.1.

(a) Each bubble represents an SCC; size indicates number of documents. The dashed vertical line marks rank 10 (top- m boundary). $k=20$ produces larger SCCs concentrated in ranks 10–40, while $k=10$ produces smaller SCCs focused in ranks 1–20.

(b) Average SCC size exhibits a wave pattern: both configurations show peaks in mid-ranks rather than at the tail.

Table 2. BM25 score variance within SCCs vs. neighboring documents on DL19 using GPT-4.1. Documents within SCCs exhibit $\sim 40\%$ lower BM25 variance than equal-sized neighbor groups (ratio ~ 0.6), confirming that cycles capture genuinely similar documents rather than arbitrary ties.

Config	SCCs (≥ 2)	Avg Size	Within-SCC Std	Neighbor Std	Ratio
$K = 10$	100	3.72	0.605	1.032	0.59
$K = 20$	126	6.01	0.695	1.125	0.62

8.86 documents per SCC compared to 2.74 for $k=10$. This likely reflects the “lost in the middle” phenomenon (Liu et al., 2024): when comparing 20 documents simultaneously, LLMs struggle to attend to items in the middle of the list, producing inconsistent judgments that manifest as cycles. Smaller windows ($k=10$) reduce this burden, yielding more consistent orderings.

SCCs Capture Genuinely Similar Documents. We use BM25 score variance as a proxy for document similarity: documents with similar lexical relevance to the query should have similar BM25 scores. For each SCC of size ≥ 2 , we compute the standard deviation of BM25 scores within the SCC and among equal-sized groups of neighboring (non-tied) documents. Table 2 shows that documents within SCCs have substantially lower BM25 variance than their

neighbors. For $k=10$, within-SCC standard deviation is 0.605 compared to 1.032 for neighbors – a ratio of 0.59. For $k=20$, the ratio is 0.62 (0.695 vs. 1.125). This $\sim 40\%$ reduction in variance confirms that cycles capture documents that are genuinely similar in lexical relevance, not arbitrary ties. Notably, SCCs in the $k=10$ configuration contain documents that are *harder* to distinguish than those in $k=20$ SCCs: within-SCC variance is lower (0.605 vs. 0.695) despite smaller average SCC size (3.72 vs. 6.01). This suggests that $k=10$ successfully resolves easier ambiguities through finer-grained comparisons, leaving only the most difficult cases as unresolved cycles. The combination of cleaner orderings and fewer boundary ties explains the consistent accuracy advantage of $k=10$ over $k=20$ across all oracles.

5. Conclusion

We introduced a tournament graph framework for top- m selection via k -wise comparison oracles. The core insight is that a k -wise comparison reveals a complete tournament – all $\binom{k}{2}$ pairwise relationships – not just a winner, and transitive closure amplifies each query’s information yield without additional oracle calls. The framework handles non-transitive preferences naturally: cycles indicate items that the oracle cannot distinguish, and SCC condensation produces principled tiered rankings rather than forcing a total order where none exists. Empirically, BLITZRANK achieves Pareto dominance across 14 benchmarks and 5 LLM oracles: matching or exceeding accuracy while requiring 25–40% fewer tokens than comparable methods, and $7\times$ fewer than pairwise approaches at near-identical quality. Convergence is remarkably predictable (coefficient of variation ~ 4 –7% in round count across 70 configurations), enabling reliable cost estimation – a property that uncertainty-based adaptive methods lack. The framework also accommodates variable k per round (any $k \geq 2$ suffices for progress), enabling adaptation to heterogeneous document lengths and LLM context capacities without algorithmic modification. Our analysis of strongly connected components confirms that cycles capture genuinely similar documents (40% lower within-SCC retrieval score variance), validating the theoretical interpretation of cycles as structure rather than noise.

Limitations. Our framework assumes a deterministic oracle: each pairwise comparison has a fixed ground-truth outcome. Real oracles – LLMs, crowdworkers, human experts – are noisy, and this noise interacts asymmetrically with transitive inference. In principle, a single erroneous edge can collapse a long chain into an SCC. Our empirical analysis suggests such strong collapse is rare with capable models on standard benchmarks, but a principled treatment remains desirable,

especially for weaker oracles or more challenging domains. Additionally, our approach uses priors only implicitly: first-stage retrieval scores inform tie-breaking within SCCs (preserving original order among indistinguishable items) but do not guide query selection or edge confidence. A more principled incorporation of priors is desirable.

5.1. Future Work

Our framework opens additional research directions.

(Query complexity.) We showed $\lceil (n-1)/(k-1) \rceil$ complexity for top-1 selection and conjectured a bound for general m over all tournaments (Conjecture 63), supported by empirical observations. A formal proof – or matching lower bound – remains open. Structural intuition (Remark 67) suggests transitive tournaments are worst-case: cycles collapse vertices into SCCs that finalize together, providing “free” progress that the transitive case lacks.

(Noisy and probabilistic oracles.) Extending the framework to handle oracle noise is a significant open problem. One approach models each edge as a random variable whose confidence accumulates across repeated or corroborating observations. A key challenge is that edges differ in *structural importance*: an edge along a long chain discriminates many pairs transitively, so its corruption is catastrophic, while a leaf edge affects only one comparison. Models that account for this asymmetry – weighting edges by transitive reach, or using soft SCCs that resist collapse from isolated errors – could yield algorithms that degrade gracefully under noise.

(Incorporating priors.) First-stage retrieval scores provide a natural prior over the ranking. Algorithms that initialize edge beliefs with priors, or prioritize queries where the prior is uncertain, could improve both efficiency and robustness. This connects to active learning formulations where queries maximize information gain relative to prior belief.

Impact Statement

This paper develops algorithmic methods for query-efficient ranking using expensive comparison oracles. By reducing the number of oracle calls required to identify top candidates, our framework lowers computational costs when LLMs serve as oracles – contributing to more sustainable use of large-scale models. The techniques are domain-agnostic and apply broadly to ranking problems with costly comparisons (crowdsourcing, human evaluation, tournament design). We do not foresee specific negative societal consequences beyond those common to advances in information retrieval and ranking systems.

References

- Alon, N. Ranking tournaments. *SIAM Journal on Discrete Mathematics*, 20(1):137–142, 2006.
- Bang-Jensen, J. and Gutin, G. Z. *Digraphs: theory, algorithms and applications*. Springer Science & Business Media, 2008.
- Bartholdi III, J., Tovey, C. A., and Trick, M. A. Voting schemes for which it can be difficult to tell who won the election. *Social Choice and welfare*, 6(2):157–165, 1989.
- Brandt, F., Conitzer, V., Endriss, U., Lang, J., and Procaccia, A. D. *Handbook of computational social choice*. Cambridge University Press, 2016.
- Chen, X., Li, Y., and Mao, J. A nearly instance optimal algorithm for top-k ranking under the multinomial logit model. In *Proceedings of the Twenty-Ninth Annual ACM-SIAM Symposium on Discrete Algorithms*, pp. 2504–2522. SIAM, 2018.
- Chen, Y., Liu, Q., Zhang, Y., Sun, W., Ma, X., Yang, W., Shi, D., Mao, J., and Yin, D. Tourrank: Utilizing large language models for documents ranking with a tournament-inspired strategy. In *Proceedings of the ACM on Web Conference 2025*, pp. 1638–1652, 2025.
- Contextual AI. Open-sourcing reranker v2. <https://contextual.ai/blog/rerank-v2>, 2025. Accessed: 2025-01-13.
- Craswell, N., Mitra, B., Yilmaz, E., Campos, D., and Voorhees, E. M. Overview of the trec 2019 deep learning track, 2020. URL <https://arxiv.org/abs/2003.07820>.
- Craswell, N., Mitra, B., Yilmaz, E., and Campos, D. Overview of the trec 2020 deep learning track, 2021. URL <https://arxiv.org/abs/2102.07662>.
- Craswell, N., Mitra, B., Yilmaz, E., Campos, D., and Lin, J. Overview of the trec 2021 deep learning track, 2025a. URL <https://arxiv.org/abs/2507.08191>.
- Craswell, N., Mitra, B., Yilmaz, E., Campos, D., Lin, J., Voorhees, E. M., and Soboroff, I. Overview of the trec 2022 deep learning track. *arXiv preprint arXiv:2507.10865*, 2025b.
- Craswell, N., Mitra, B., Yilmaz, E., Rahmani, H. A., Campos, D., Lin, J., Voorhees, E. M., and Soboroff, I. Overview of the trec 2023 deep learning track, 2025c. URL <https://arxiv.org/abs/2507.08890>.
- DeepSeek-AI, Liu, A., Mei, A., Lin, B., Xue, B., Wang, B., Xu, B., Wu, B., Zhang, B., Lin, C., Dong, C., Lu, C., Zhao, C., Deng, C., Xu, C., Ruan, C., Dai, D., Guo, D.,

- Yang, D., Chen, D., Li, E., Zhou, F., Lin, F., Dai, F., Hao, G., Chen, G., Li, G., Zhang, H., Xu, H., Li, H., Liang, H., Wei, H., Zhang, H., Luo, H., Ji, H., Ding, H., Tang, H., Cao, H., Gao, H., Qu, H., Zeng, H., Huang, J., Li, J., Xu, J., Hu, J., Chen, J., Xiang, J., Yuan, J., Cheng, J., Zhu, J., Ran, J., Jiang, J., Qiu, J., Li, J., Song, J., Dong, K., Gao, K., Guan, K., Huang, K., Zhou, K., Huang, K., Yu, K., Wang, L., Zhang, L., Wang, L., Zhao, L., Yin, L., Guo, L., Luo, L., Ma, L., Wang, L., Zhang, L., Di, M. S., Xu, M. Y., Zhang, M., Zhang, M., Tang, M., Zhou, M., Huang, P., Cong, P., Wang, P., Wang, Q., Zhu, Q., Li, Q., Chen, Q., Du, Q., Xu, R., Ge, R., Zhang, R., Pan, R., Wang, R., Yin, R., Xu, R., Shen, R., Zhang, R., Liu, S. H., Lu, S., Zhou, S., Chen, S., Cai, S., Chen, S., Hu, S., Liu, S., Hu, S., Ma, S., Wang, S., Yu, S., Zhou, S., Pan, S., Zhou, S., Ni, T., Yun, T., Pei, T., Ye, T., Yue, T., Zeng, W., Liu, W., Liang, W., Pang, W., Luo, W., Gao, W., Zhang, W., Gao, X., Wang, X., Bi, X., Liu, X., Wang, X., Chen, X., Zhang, X., Nie, X., Cheng, X., Liu, X., Xie, X., Liu, X., Yu, X., Li, X., Yang, X., Li, X., Chen, X., Su, X., Pan, X., Lin, X., Fu, X., Wang, Y. Q., Zhang, Y., Xu, Y., Ma, Y., Li, Y., Li, Y., Zhao, Y., Sun, Y., Wang, Y., Qian, Y., Yu, Y., Zhang, Y., Ding, Y., Shi, Y., Xiong, Y., He, Y., Zhou, Y., Zhong, Y., Piao, Y., Wang, Y., Chen, Y., Tan, Y., Wei, Y., Ma, Y., Liu, Y., Yang, Y., Guo, Y., Wu, Y., Wu, Y., Cheng, Y., Ou, Y., Xu, Y., Wang, Y., Gong, Y., Wu, Y., Zou, Y., Li, Y., Xiong, Y., Luo, Y., You, Y., Liu, Y., Zhou, Y., Wu, Z. F., Ren, Z. Z., Zhao, Z., Ren, Z., Sha, Z., Fu, Z., Xu, Z., Xie, Z., Zhang, Z., Hao, Z., Gou, Z., Ma, Z., Yan, Z., Shao, Z., Huang, Z., Wu, Z., Li, Z., Zhang, Z., Xu, Z., Wang, Z., Gu, Z., Zhu, Z., Li, Z., Zhang, Z., Xie, Z., Gao, Z., Pan, Z., Yao, Z., Feng, B., Li, H., Cai, J. L., Ni, J., Xu, L., Li, M., Tian, N., Chen, R. J., Jin, R. L., Li, S. S., Zhou, S., Sun, T., Li, X. Q., Jin, X., Shen, X., Chen, X., Song, X., Zhou, X., Zhu, Y. X., Huang, Y., Li, Y., Zheng, Y., Zhu, Y., Ma, Y., Huang, Z., Xu, Z., Zhang, Z., Ji, D., Liang, J., Guo, J., Chen, J., Xia, L., Wang, M., Li, M., Zhang, P., Chen, R., Sun, S., Wu, S., Ye, S., Wang, T., Xiao, W. L., An, W., Wang, X., Sun, X., Wang, X., Tang, Y., Zha, Y., Zhang, Z., Ju, Z., Zhang, Z., and Qu, Z. Deepseek-v3.2: Pushing the frontier of open large language models, 2025. URL <https://arxiv.org/abs/2512.02556>.
- Dey, P. Query complexity of tournament solutions. In *Proceedings of the AAAI Conference on Artificial Intelligence*, volume 31, 2017.
- Feige, U., Raghavan, P., Peleg, D., and Upfal, E. Computing with noisy information. *SIAM Journal on Computing*, 23(5):1001–1018, 1994.
- Gu, Y. and Xu, Y. Optimal bounds for noisy sorting. In *Proceedings of the 55th Annual ACM Symposium on Theory of Computing*, pp. 1502–1515, 2023.
- Hsieh, C.-P., Sun, S., Krizan, S., Acharya, S., Rekish, D., Jia, F., Zhang, Y., and Ginsburg, B. Ruler: What’s the real context size of your long-context language models? *arXiv preprint arXiv:2404.06654*, 2024.
- Jang, M., Kim, S., Suh, C., and Oh, S. Optimal sample complexity of m-wise data for top-k ranking. *Advances in Neural Information Processing Systems*, 30, 2017.
- Järvelin, K. and Kekäläinen, J. Cumulated gain-based evaluation of ir techniques. *ACM Transactions on Information Systems (TOIS)*, 20(4):422–446, 2002.
- Landau, H. G. On dominance relations and the structure of animal societies. iii. the condition for a score structure. *Bull. Math. Biophys.*, 15(2):143–148, 1953.
- Laslier, J.-F. *Tournament solutions and majority voting*, volume 7. Springer, 1997.
- Liu, N. F., Lin, K., Hewitt, J., Paranjape, A., Bevilacqua, M., Petroni, F., and Liang, P. Lost in the middle: How language models use long contexts. *Transactions of the Association for Computational Linguistics*, 12:157–173, 2024. doi: 10.1162/tacl.a.00638. URL <https://aclanthology.org/2024.tacl-1.9/>.
- Ma, X., Zhang, X., Pradeep, R., and Lin, J. Zero-shot listwise document reranking with a large language model. *arXiv preprint arXiv:2305.02156*, 2023.
- Mackie, I., Dalton, J., and Yates, A. How deep is your learning: the dl-hard annotated deep learning dataset. In *Proceedings of the 44th International ACM SIGIR Conference on Research and Development in Information Retrieval*, 2021.
- Moon, J. W. *Topics on tournaments in graph theory*. Courier Dover Publications, 2015.
- Pradeep, R., Sharifmoghaddam, S., and Lin, J. Rankvicuna: Zero-shot listwise document reranking with open-source large language models. *arXiv preprint arXiv:2309.15088*, 2023a.
- Pradeep, R., Sharifmoghaddam, S., and Lin, J. Rankzephyr: Effective and robust zero-shot listwise reranking is a breeze! *arXiv preprint arXiv:2312.02724*, 2023b.
- Qin, Z., Jagerman, R., Hui, K., Zhuang, H., Wu, J., Yan, L., Shen, J., Liu, T., Liu, J., Metzler, D., et al. Large language models are effective text rankers with pairwise ranking prompting. In *Findings of the Association for Computational Linguistics: NAACL 2024*, pp. 1504–1518, 2024.

- Ren, W., Liu, J., and Shroff, N. Sample complexity bounds for active ranking from multi-wise comparisons. *Advances in Neural Information Processing Systems*, 34: 4290–4300, 2021.
- Robertson, S., Zaragoza, H., et al. The probabilistic relevance framework: Bm25 and beyond. *Foundations and trends® in information retrieval*, 3(4):333–389, 2009.
- Sachan, D., Lewis, M., Joshi, M., Aghajanyan, A., Yih, W.-t., Pineau, J., and Zettlemoyer, L. Improving passage retrieval with zero-shot question generation. In *Proceedings of the 2022 Conference on Empirical Methods in Natural Language Processing*, pp. 3781–3797, 2022.
- Saha, A. and Gopalan, A. Pac battling bandits in the plackett-luce model. In *Algorithmic Learning Theory*, pp. 700–737. PMLR, 2019.
- Sun, W., Yan, L., Ma, X., Wang, S., Ren, P., Chen, Z., Yin, D., and Ren, Z. Is ChatGPT good at search? investigating large language models as re-ranking agents. In *Proceedings of the 2023 Conference on Empirical Methods in Natural Language Processing*, pp. 14918–14937, Singapore, 2023. Association for Computational Linguistics. doi: 10.18653/v1/2023.emnlp-main.923. URL <https://aclanthology.org/2023.emnlp-main.923/>.
- Tang, R., Zhang, C., Ma, X., Lin, J., and Türe, F. Found in the middle: Permutation self-consistency improves listwise ranking in large language models. In *Proceedings of the 2024 conference of the North American chapter of the Association for Computational Linguistics: human language technologies (volume 1: long papers)*, pp. 2327–2340, 2024.
- Team, G., Zeng, A., Lv, X., Zheng, Q., Hou, Z., Chen, B., Xie, C., Wang, C., Yin, D., Zeng, H., Zhang, J., Wang, K., Zhong, L., Liu, M., Lu, R., Cao, S., Zhang, X., Huang, X., Wei, Y., Cheng, Y., An, Y., Niu, Y., Wen, Y., Bai, Y., Du, Z., Wang, Z., Zhu, Z., Zhang, B., Wen, B., Wu, B., Xu, B., Huang, C., Zhao, C., Cai, C., Yu, C., Li, C., Ge, C., Huang, C., Zhang, C., Xu, C., Zhu, C., Li, C., Yin, C., Lin, D., Yang, D., Jiang, D., Ai, D., Zhu, E., Wang, F., Pan, G., Wang, G., Sun, H., Li, H., Li, H., Hu, H., Zhang, H., Peng, H., Tai, H., Zhang, H., Wang, H., Yang, H., Liu, H., Zhao, H., Liu, H., Yan, H., Liu, H., Chen, H., Li, J., Zhao, J., Ren, J., Jiao, J., Zhao, J., Yan, J., Wang, J., Gui, J., Zhao, J., Liu, J., Li, J., Li, J., Lu, J., Wang, J., Yuan, J., Li, J., Du, J., Du, J., Liu, J., Zhi, J., Gao, J., Wang, K., Yang, L., Xu, L., Fan, L., Wu, L., Ding, L., Wang, L., Zhang, M., Li, M., Xu, M., Zhao, M., Zhai, M., Du, P., Dong, Q., Lei, S., Tu, S., Yang, S., Lu, S., Li, S., Li, S., Shuang-Li, Yang, S., Yi, S., Yu, T., Tian, W., Wang, W., Yu, W., Tam, W. L., Liang, W., Liu, W., Wang, X., Jia, X., Gu, X., Ling, X., Wang, X., Fan, X., Pan, X., Zhang, X., Zhang, X., Fu, X., Zhang, X., Xu, Y., Wu, Y., Lu, Y., Wang, Y., Zhou, Y., Pan, Y., Zhang, Y., Wang, Y., Li, Y., Su, Y., Geng, Y., Zhu, Y., Yang, Y., Li, Y., Wu, Y., Li, Y., Liu, Y., Wang, Y., Li, Y., Zhang, Y., Liu, Z., Yang, Z., Zhou, Z., Qiao, Z., Feng, Z., Liu, Z., Zhang, Z., Wang, Z., Yao, Z., Wang, Z., Liu, Z., Chai, Z., Li, Z., Zhao, Z., Chen, W., Zhai, J., Xu, B., Huang, M., Wang, H., Li, J., Dong, Y., and Tang, J. Glm-4.5: Agentic, reasoning, and coding (arc) foundation models, 2025. URL <https://arxiv.org/abs/2508.06471>.
- Team, Q. Qwen3 technical report, 2025. URL <https://arxiv.org/abs/2505.09388>.
- Thakur, N., Reimers, N., Rücklé, A., Srivastava, A., and Gurevych, I. BEIR: A heterogeneous benchmark for zero-shot evaluation of information retrieval models. In *Thirty-fifth Conference on Neural Information Processing Systems Datasets and Benchmarks Track (Round 2)*, 2021. URL <https://openreview.net/forum?id=wCu6T5xFjeJ>.
- Wang, P., Xia, Z., Liao, C., Wang, F., and Liu, H. Realm: Recursive relevance modeling for llm-based document re-ranking. In *Proceedings of the 2025 Conference on Empirical Methods in Natural Language Processing*, pp. 23875–23889, 2025.
- Yoon, S., Kim, G., CHO, G.-H., and seung-won hwang. Acurank: Uncertainty-aware adaptive computation for listwise reranking. In *The Thirty-ninth Annual Conference on Neural Information Processing Systems*, 2025. URL <https://openreview.net/forum?id=H918WyPf0s>.
- Yu, Y., Liu, Y., He, M., Tao, S., Meng, W., Yang, X., Zhang, L., Ma, H., Li, D., Wei, D., et al. Elspr: Evaluator llm training data self-purification on non-transitive preferences via tournament graph reconstruction. *arXiv preprint arXiv:2505.17691*, 2025.
- Zeng, Y., Tendolkar, O., Baartmans, R., Wu, Q., Chen, L., and Wang, H. Llm-rankfusion: Mitigating intrinsic inconsistency in llm-based ranking. *arXiv preprint arXiv:2406.00231*, 2024.
- Zhou, X. and Jiu, B. *A Practical Guide to Quantitative Finance Interviews*. Lulu.com, 2008. ISBN 9781435715752. URL <https://books.google.com/books?id=RosxmAYFFosC>.
- Zhuang, H., Qin, Z., Hui, K., Wu, J., Yan, L., Wang, X., and Bendersky, M. Beyond yes and no: Improving zero-shot llm rankers via scoring fine-grained relevance

labels. In *Proceedings of the 2024 conference of the North American chapter of the Association for Computational Linguistics: Human language technologies (volume 2: short papers)*, pp. 358–370, 2024a.

Zhuang, S., Zhuang, H., Koopman, B., and Zuccon, G. A setwise approach for effective and highly efficient zero-shot ranking with large language models. In *Proceedings of the 47th International ACM SIGIR Conference on Research and Development in Information Retrieval, SIGIR '24*, pp. 1974–1983, Washington, DC, USA, 2024b. ACM. doi: 10.1145/3626772.3657813. URL <https://doi.org/10.1145/3626772.3657813>.

Part I

Additional Experimental Details

Table 3. Reranking quality (nDCG@10) and efficiency (input tokens per query in thousands).

Method	TREC-DL						BEIR									Avg.	
	DL19	DL20	DL21	DL22	DL23	DLHard	COVID	NFC	Signal	News	R04	Touche	DBP	Scif	nDCG	Tok	
<i>No Reranking</i>																	
BM25	50.6	48.0	44.6	26.9	26.2	28.5	59.5	33.7	33.0	39.5	40.7	44.2	31.8	67.9	41.1	0	
<i>GPT-4.1</i>																	
Pairwise	74.8	72.3	73.0	52.6	49.3	40.0	83.1	39.8	33.3	51.4	67.1	35.4	45.0	80.0	56.9	315k	
Setwise	73.5	70.4	72.0	51.9	48.2	39.6	83.3	39.9	34.0	49.6	66.6	35.6	44.4	78.4	56.3	111k	
TourRank	72.6	69.4	71.2	51.8	49.3	37.6	84.3	40.1	31.5	50.3	66.3	32.2	44.5	77.6	55.6	57k	
TourRank-R2	74.5	70.9	70.3	51.8	50.3	38.6	84.5	40.4	33.2	50.0	66.3	32.4	45.5	78.7	56.2	114k	
SW	74.0	70.8	70.5	51.4	49.5	37.4	82.7	40.9	34.3	51.5	66.7	36.9	45.9	79.0	56.5	54k	
SW-R2	73.4	72.0	70.5	52.0	49.6	39.4	82.6	40.5	34.0	51.9	66.0	36.4	46.4	79.1	56.7	109k	
AcuRank	74.2	70.5	70.5	52.1	49.9	38.2	83.5	40.4	32.3	50.0	66.8	33.0	45.6	79.4	56.2	67k	
AcuRank-H	73.7	70.8	71.1	51.5	51.0	37.9	83.5	40.5	32.6	51.6	67.0	32.9	45.9	80.5	56.5	116k	
BLITZ-k20	74.6	70.7	70.4	51.4	48.9	37.3	82.4	39.9	33.7	50.1	66.4	36.5	45.3	79.2	56.2	40k	
BLITZ-k10	73.6	72.4	71.3	52.0	50.2	37.7	83.8	40.3	33.0	50.3	66.8	37.4	45.6	79.4	56.7	42k	
<i>Gemini-3-Flash</i>																	
Pairwise	74.9	72.4	72.7	53.3	50.2	38.9	82.7	40.8	34.2	48.8	67.9	36.3	45.5	80.4	57.1	334k	
Setwise	73.9	73.1	72.6	52.8	49.5	38.9	82.5	40.7	33.0	47.6	67.4	37.9	44.7	81.6	56.9	119k	
TourRank	74.9	72.4	71.9	51.0	49.8	36.6	82.7	40.6	33.8	49.7	66.4	35.1	45.6	77.9	56.3	57k	
TourRank-R2	73.0	72.1	72.5	51.4	50.5	38.5	82.7	40.5	33.5	49.6	66.7	35.5	46.0	78.3	56.5	113k	
SW	74.0	73.1	73.0	52.1	51.1	38.9	82.6	40.8	32.6	49.4	66.5	36.1	45.7	80.6	56.9	54k	
SW-R2	73.3	71.6	72.7	50.6	51.5	38.1	81.0	40.1	32.3	47.0	65.9	37.7	46.3	80.1	56.3	109k	
AcuRank	73.8	71.6	72.6	51.3	51.0	37.5	81.9	40.8	32.3	48.3	67.2	35.0	45.6	80.9	56.4	71k	
AcuRank-H	73.9	71.7	71.9	51.9	51.6	38.6	82.5	41.3	34.1	49.0	66.9	35.1	46.0	81.3	56.8	138k	
BLITZ-k20	74.9	72.1	72.4	51.4	49.7	38.1	82.3	41.1	33.0	48.2	65.8	37.9	45.3	80.4	56.6	40k	
BLITZ-k10	74.8	72.0	73.0	50.8	50.9	39.4	82.3	41.0	33.9	47.4	66.6	39.6	45.9	79.9	57.0	42k	
<i>GLM-4.7</i>																	
TourRank	74.1	71.2	69.8	51.0	49.4	38.4	83.4	40.0	30.4	49.1	66.0	31.8	45.9	77.5	55.6	57k	
TourRank-R2	74.8	71.0	71.4	52.3	49.2	38.7	83.3	40.4	31.9	49.0	66.4	32.6	46.1	78.2	56.1	113k	
SW	74.2	71.6	71.5	51.7	48.3	38.5	82.9	39.8	34.1	50.4	66.2	37.6	47.6	80.0	56.7	54k	
SW-R2	74.5	71.9	71.5	52.3	49.4	37.1	82.9	40.0	33.6	50.4	65.9	34.9	47.2	81.0	56.6	109k	
AcuRank	74.0	70.2	70.8	51.8	48.3	37.5	82.5	40.1	31.7	49.8	66.0	33.0	46.5	80.4	55.9	64k	
AcuRank-H	75.1	71.4	71.6	52.4	48.4	39.3	83.4	40.5	32.1	50.3	66.7	31.7	46.5	80.9	56.4	108k	
BLITZ-k20	75.7	71.2	70.4	51.0	47.7	38.5	83.3	39.9	33.3	49.9	65.1	35.8	46.5	79.9	56.3	40k	
BLITZ-k10	72.8	72.4	71.3	52.4	49.2	38.6	81.8	39.9	33.9	50.0	66.5	38.4	46.5	80.3	56.7	41k	
<i>Qwen3-235B-A22B-Instruct</i>																	
TourRank	71.3	69.0	69.0	49.7	47.3	36.6	84.8	38.7	28.3	50.3	64.0	34.5	42.1	73.8	54.2	59k	
TourRank-R2	72.8	71.2	69.0	51.5	48.3	37.4	83.6	39.8	30.7	49.5	65.6	33.0	43.0	75.3	55.1	119k	
SW	73.5	69.7	70.6	49.9	47.8	39.2	83.8	39.6	32.5	50.5	64.5	32.5	45.0	77.3	55.5	57k	
SW-R2	73.5	71.1	70.2	51.5	48.4	37.8	83.6	39.9	31.6	47.9	65.3	33.0	45.1	76.3	55.4	114k	
AcuRank	73.9	69.4	69.8	50.7	48.9	37.3	82.1	39.2	29.0	50.3	65.4	32.2	43.2	76.3	54.8	71k	
AcuRank-H	74.2	69.6	70.2	51.3	49.5	39.0	82.7	39.6	30.5	50.3	65.9	32.1	44.2	76.5	55.4	128k	
BLITZ-k20	71.9	70.6	69.2	50.5	48.6	39.1	83.2	38.9	30.4	49.2	63.8	32.7	43.3	74.5	54.7	41k	
BLITZ-k10	74.1	71.1	70.3	49.0	47.3	39.7	83.1	39.8	31.9	50.9	65.3	35.9	43.5	75.9	55.6	43k	
<i>DeepSeek-V3.2</i>																	
TourRank	72.7	71.2	69.5	49.6	47.8	38.8	83.3	40.0	31.4	50.0	65.2	33.5	45.0	79.6	55.5	56k	
TourRank-R2	74.5	70.9	71.0	51.5	48.6	38.2	83.9	40.9	32.8	52.7	66.1	32.7	46.1	79.6	56.4	112k	
SW	74.6	71.4	71.2	52.5	47.5	40.8	84.3	40.7	34.1	51.4	65.6	40.0	47.2	80.7	57.3	54k	
SW-R2	74.9	72.0	70.5	52.2	48.1	38.5	84.5	40.3	33.7	52.4	65.4	36.0	47.2	80.5	56.9	108k	
AcuRank	73.6	71.2	70.9	52.1	48.5	37.2	83.5	40.5	31.0	53.1	66.3	31.3	45.6	79.3	56.0	69k	
AcuRank-H	74.5	71.4	71.3	52.4	48.8	39.4	84.5	41.2	32.2	52.2	66.8	32.6	46.4	80.9	56.8	131k	
BLITZ-k20	74.2	71.6	69.6	52.2	47.4	39.1	82.4	40.2	32.9	52.4	64.3	35.1	45.4	80.0	56.2	39k	
BLITZ-k10	74.0	71.6	70.9	52.3	47.1	40.6	84.6	40.6	32.1	50.3	65.4	37.0	46.2	80.1	56.6	41k	

A. Baseline Comparison Rationale

Each baseline tests a specific aspect of our tournament graph framework.

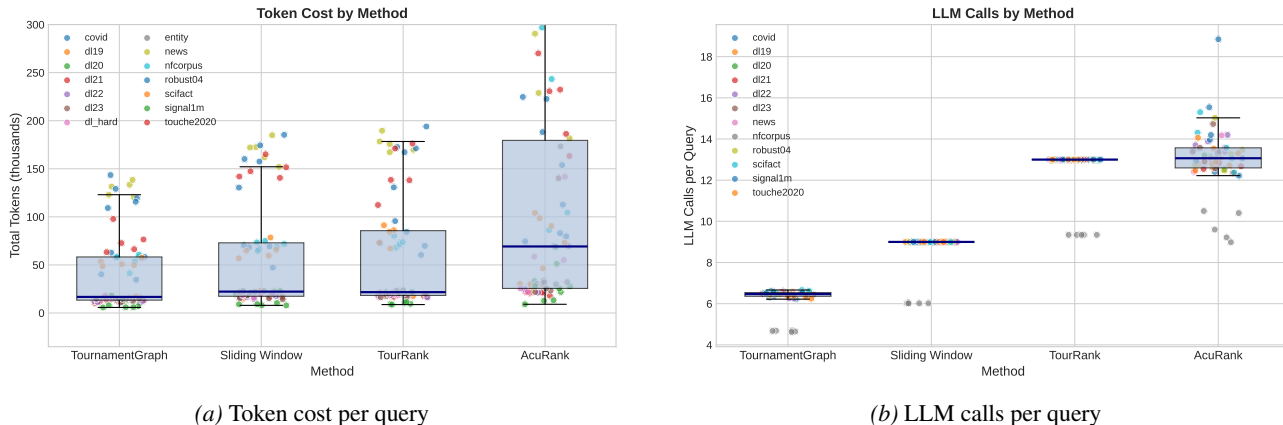

Figure 7. Efficiency comparison across listwise reranking methods on 14 datasets (GPT-4.1). Each point represents one dataset; box plots show the distribution. (a) Token consumption varies across datasets due to differing document lengths, but BLITZRANK consistently achieves the lowest median cost. AcuRank exhibits the highest variance due to its adaptive computation. (b) LLM call counts isolate algorithmic efficiency from document length effects. BLITZRANK requires ~ 6.5 calls on average – fewer than Sliding Window (9), TourRank (13), and AcuRank (13). Outliers at lower call counts correspond to NFCorpus, where many queries have fewer than 100 retrieved documents (see Figure 8).

Table 4. LLM calls per query across reranking methods. Statistics shown for all 14 datasets and separately excluding NFCorpus (13 datasets). BLITZRANK makes the fewest calls (~ 6.5) while Sliding Window and TourRank are deterministic (9 and 13 calls respectively). AcuRank averages ~ 13 calls with slight variation due to adaptive refinement.

Method	All Datasets						Excl. NFCorpus					
	Mean	Std	Min	Max	Std%	Rng%	Mean	Std	Min	Max	Std%	Rng%
BLITZRANK	6.3	0.6	5	7	9.0	32.0	6.5	0.1	6	7	2.0	7.0
Sliding Window	8.8	0.8	6	9	9.0	34.0	9.0	0.0	9	9	0.0	0.0
TourRank	12.7	1.0	9	13	8.0	29.0	13.0	0.0	13	13	0.0	0.0
AcuRank	13.1	1.4	9	19	11.0	75.0	13.4	1.1	12	19	8.0	49.0

Sliding Windows (Sun et al., 2023) This baseline directly tests our central hypothesis: sliding windows process overlapping document sets, yet discard comparison information from previous windows rather than accumulating it. Our framework captures these relationships via transitive closure, potentially achieving equivalent quality with fewer queries.

TourRank (Chen et al., 2025) While TourRank uses a static tournament structure to schedule matches, it does not employ tournament graphs to model comparison outcomes or exploit graph-theoretic properties such as transitivity. This comparison isolates the value of maintaining a tournament graph and propagating information via transitive closure versus using tournaments purely as a scheduling mechanism.

AcuRank (Yoon et al., 2025). Both AcuRank and BLITZRANK are adaptive – terminating when sufficiently confident about the top- m – but employ different certification criteria: AcuRank uses Bayesian score distributions, while our framework certifies via graph-theoretic finalization through transitive closure.

Setwise (Zhuang et al., 2024b). This baseline provides the most direct contrast to our approach: both methods issue k -wise comparison queries, but Setwise extracts only the winner – a single comparison – while our framework captures the complete tournament of $\binom{k}{2}$ pairwise relationships.

Pairwise (Qin et al., 2024). Pairwise reranking serves as an upper bound on comparison granularity: each query yields exactly one pairwise relationship. This makes it highly accurate – reducing the cognitive load on LLMs to simple binary judgments – but computationally expensive, requiring $7-8\times$ more tokens than our approach.

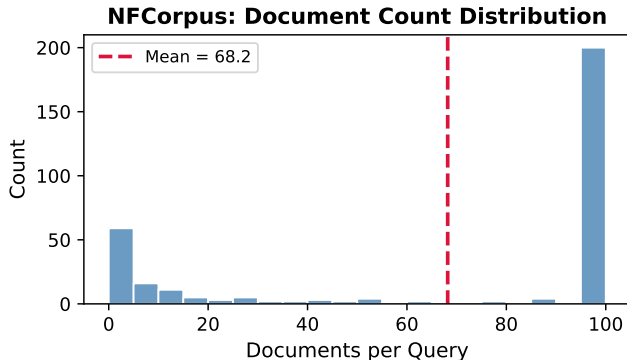

Figure 8. Distribution of retrieved documents per query in NFCorpus. Unlike other datasets where BM25 retrieves 100 documents per query, NFCorpus exhibits a bimodal distribution with many queries having fewer than 20 candidates (mean: 68.2). This explains the lower LLM call counts for NFCorpus in Table 4.

Table 5. Number of rounds as a function of window size k , aggregated over 70 configurations (14 datasets \times 5 LLMs). The algorithm exhibits deterministic convergence: for fixed k , round count remains nearly constant across datasets and oracles, enabling reliable cost estimation.

k	Min	Max	Mean	Std	Avg. Tokens
10	12	15	13.59	0.58	44,814
20	6	7	6.73	0.45	42,139

B. Efficiency Comparison Details

Setwise and Pairwise consume substantially more tokens than BLITZRANK due to their small comparison windows ($k=3$ and $k=2$, respectively), requiring many more queries to establish order. More interesting is the comparison against methods that share our oracle structure – AcuRank, TourRank, and Sliding Window all prompt the LLM to rank $k=20$ documents per call. Despite this structural similarity, BLITZRANK achieves lower cost through principled information extraction.

Figure 7 visualizes token consumption and LLM call counts across the 14 datasets. Token costs vary across datasets due to differing document lengths, but BLITZRANK consistently achieves the lowest median (Figure 7a). To isolate algorithmic efficiency from document length effects, we also compare LLM call counts (Figure 7b). BLITZRANK requires only ~ 6.5 calls per query on average, compared to 9 for Sliding Window, 13 for TourRank, and 13 for AcuRank (Table 4).

The outliers at lower call counts in Figure 7b correspond to NFCorpus, where many queries have fewer than 100 retrieved documents. Figure 8 shows that NFCorpus exhibits a bimodal distribution with many queries having fewer than 20 candidates (mean: 68.2), explaining why all methods require fewer calls on this dataset. We report statistics both with and without NFCorpus in Table 4 to isolate this effect.

Comparison with AcuRank. AcuRank exhibits both higher cost and less predictable cost than BLITZRANK. While BLITZRANK has a standard deviation of just 2% in call counts (excluding NFCorpus), AcuRank’s standard deviation reaches 8%, with a range spanning 49% of its mean (Table 4). This variance stems from AcuRank’s design: it models each document with an independent score distribution and adaptively allocates comparisons based on uncertainty. In contrast, our framework maximizes information extraction by capturing complete tournaments from each query and propagating relationships via transitive closure, yielding deterministic convergence behavior.

AcuRank’s adaptivity does offer a potential advantage: spending more computation on genuinely difficult queries. However, modern LLMs produce largely consistent judgments, limiting the practical benefit of this flexibility. Whether combining adaptive allocation with tournament graph structure can yield further gains remains an open question.

C. Convergence Analysis

Table 5 and Figure 9 characterize the algorithm’s convergence behavior across window sizes. For $k=10$, convergence requires 12–15 rounds (mean 13.6, std 0.58); for $k=20$, only 6–7 rounds (mean 6.7, std 0.45).

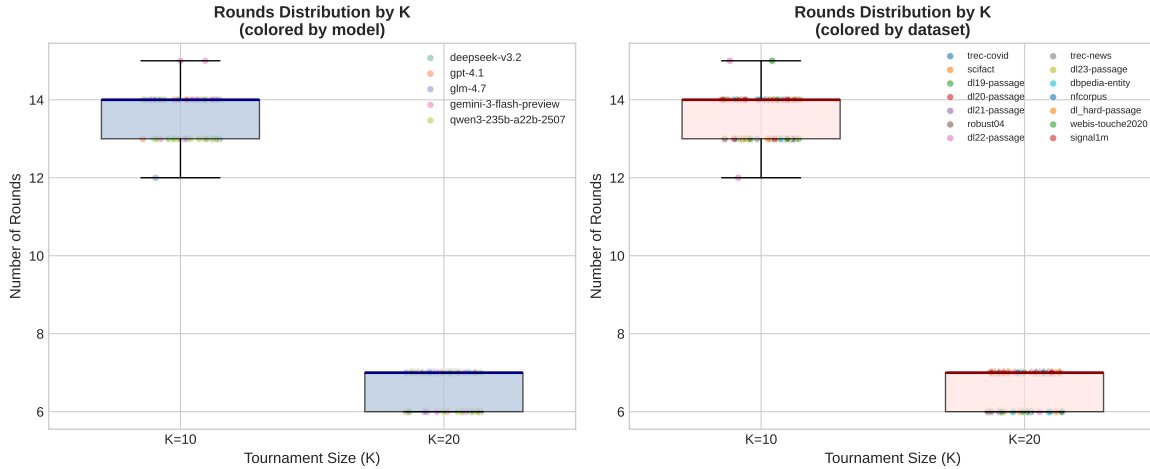

Figure 9. Distribution of rounds until convergence for $k=10$ and $k=20$, aggregated across 70 configurations (14 datasets \times 5 LLMs). Left panel colors by model, right panel by dataset. The algorithm exhibits highly predictable convergence: $k=10$ requires 12–15 rounds (mean 13.6), while $k=20$ requires only 6–7 rounds (mean 6.7). Variance across models and datasets is minimal, indicating that convergence depends primarily on problem structure rather than oracle-specific factors.

This predictability is notable: despite variation in dataset characteristics, query difficulty, and oracle capabilities, round count remains nearly constant for fixed k . The deterministic convergence stems from the progress guarantee (Lemma 46): each round reveals at least one new edge, and the algorithm terminates once the top- m candidates are finalized.

Token consumption also remains stable across oracles despite differences in their ranking capabilities, indicating that the algorithm’s query complexity depends primarily on the problem structure (n, m, k) rather than oracle-specific factors. This contrasts sharply with adaptive methods like AcuRank, which exhibit 8% variance in call counts – the deterministic nature of our framework enables reliable cost estimation before execution.

D. SCC Analysis

Table 6. Average SCC size by rank position on DL19 using GPT-4.1. SCCs concentrate in mid-ranks where the algorithm focuses queries, peaking around rank 15 for $k=20$ (avg 8.86) and rank 5–10 for $k=10$ (avg ~ 4). Beyond rank 50, SCC size drops to 1.0 as lower-ranked documents are excluded via transitive closure.

Rank	1	2	3	5	10	15	20	25	50
$K = 10$	1.00	2.09	2.44	2.93	3.88	2.74	1.23	1.02	1.00
$K = 20$	1.35	1.77	2.98	3.60	6.02	8.86	8.30	5.98	1.00

SCCs concentrate in mid-ranks, not at the tail. One might expect SCCs to cluster among low-ranked documents, where items are uniformly irrelevant and difficult to distinguish. Instead, Figure 6b shows a wave pattern: SCC size peaks around ranks 10–20 for $k=20$ and ranks 5–10 for $k=10$, then drops to 1.0 beyond rank 50. This pattern reflects the algorithm’s greedy scheduling (§2.4): queries target non-finalized SCCs with smallest in-reach, concentrating comparisons near the decision boundary. Lower-ranked documents are often excluded via transitive closure after a single comparison – losing to a document that loses to a top- m candidate finalizes their position without further queries.

Part II

Theory

E. Problem Statement

We consider the problem of identifying top-ranked vertices in an unknown tournament graph through queries to an oracle.

E.1. Unknown Tournaments and Oracle Model

Tournament Graphs. A *tournament* is a directed graph $G^* = (V, E^*)$ in which every pair of vertices is connected by exactly one directed edge: for all $u \neq v \in V$, either $(u, v) \in E^*$ or $(v, u) \in E^*$, but not both. The edge (u, v) is interpreted as u defeating v in a comparison. Throughout, G^* denotes a fixed but unknown tournament that we seek to discover through oracle queries. We use the subscript and superscript $*$ to indicate quantities associated with the tournament G^* .

Neighborhoods and Degrees. For a vertex u in a directed graph $G = (V, E)$, the *out-neighbors* of u is $N_G^+(u) = \{v \in V : (u, v) \in E\}$ with *out-degree* $\deg_G^+(u) = |N_G^+(u)|$, and the *in-neighbors* of u is $N_G^-(u) = \{v \in V : (v, u) \in E\}$ with *in-degree* $\deg_G^-(u) = |N_G^-(u)|$.

Oracle Model. For a set U with $|U| = n$ and a positive integer k , let $\binom{U}{k} := \{S \subseteq U : |S| = k\}$ denote the collection of all k -subsets of U , and let $U^k := \{(u_1, \dots, u_k) \in U^k : u_i \neq u_j \text{ for all } i \neq j\}$ denote the set of all ordered k -tuples of distinct elements from U . We assume access to an oracle $O_{G^*} : \binom{V}{k} \rightarrow 2^{E^*}$ that, given any k -subset $S \in \binom{V}{k}$, returns all directed edges of G^* induced by S :

$$O_{G^*}(S) := E^* \cap S^2.$$

Intuitively, given k items, the oracle “organizes” a subtournament between them and reveals the result.

Reachability. We write $u \rightsquigarrow_G v$ to denote the existence of a directed path from u to v in G , i.e. $u \rightsquigarrow_G v$ if there exist vertices $v_0, v_1, \dots, v_k \in V$ with $k \geq 0$, $v_0 = u$, $v_k = v$, and $(v_i, v_{i+1}) \in E$ for all $i = 0, 1, \dots, k - 1$. The *in-reach* and *out-reach* of a vertex v are defined as

$$R_G^-(v) := \{u \in V \setminus \{v\} : u \rightsquigarrow_G v\}, \quad (1)$$

$$R_G^+(v) := \{u \in V \setminus \{v\} : v \rightsquigarrow_G u\}. \quad (2)$$

In a tournament, $|R_{G^*}^-(v)|$ measures how many items transitively dominate v – a reachability-based loss count. When G^* is *transitive* (i.e., (u, v) and (v, p) in E^* implies (u, p) in E^*), in-reach coincides with in-neighborhood (Corollary 27), so $|R_{G^*}^-(v)| = \deg_{G^*}^-(v)$.

E.2. Problem Statement: Ranking in Tournaments with k -wise Oracle

We formalize the primary ranking problem of interest as follows.

Problem 1. Given an unlabeled vertex set V of size n , an oracle O_{G^*} with query size $k \geq 2$, and a target count $m \leq n$, identify a set of top- m ranked vertices $S = \{v^{(1)}, \dots, v^{(m)}\}$ such that

$$|R_{G^*}^-(v^{(1)})| \leq |R_{G^*}^-(v^{(2)})| \leq \dots \leq |R_{G^*}^-(v^{(m)})| \quad (3)$$

$$\text{and } \max_{i \leq m} |R_{G^*}^-(v^{(i)})| \leq \min_{u \notin S} |R_{G^*}^-(u)|, \quad (4)$$

using as few oracle queries as possible.

Remark 2 (In-reach ranking and the decomposition ordering). Every tournament decomposes uniquely into strongly connected components (SCCs), and the condensation – the DAG obtained by collapsing each SCC to a single node – is itself a transitive tournament (Bang-Jensen & Gutin, 2008). Vertices in the same SCC have identical in-reach, so the in-reach ranking coincides with the *decomposition ordering* (also called the *Smith set stratification*) (Laslier, 1997): it ranks vertices by the position of their SCC in the condensation, declaring vertices within the same SCC tied. When G^* is transitive, every

SCC is a singleton, in-reach reduces to in-degree, and the ranking is a total order identical to the Copeland ranking. In the non-transitive case, ties may cause the top- m set (and its internal ordering) to be non-unique. Refining the within-SCC ordering to match the full Copeland ranking requires additionally discovering the induced subtournament on each output SCC, at a cost of at most $\binom{|C|}{2}$ further queries per component C .

E.3. Theoretical Foundations and Related Work

Tournament solutions and query complexity. Tournaments are well-studied in computational social choice (Brandt et al., 2016; Laslier, 1997). Beyond the Copeland and decomposition orderings used here, classical solutions include the Slater ranking (minimum feedback arc set) and Kemeny ranking (minimum Kendall-tau distance); both are NP-hard (Alon, 2006; Bartholdi III et al., 1989). Dey (2017) established query complexity bounds for tournament solutions under a pairwise oracle, proving that most require $\Omega(n^2)$ queries. When the top cycle has bounded size c , they show all solutions can be found in $O(nc + n \log n / \log(1 - 1/c))$ queries; however, this identifies only the first SCC (the top cycle) and does not recover the full condensation ordering over all components. No existing work, to our knowledge, studies the query complexity of recovering the complete SCC stratification.

The decomposition ordering is a natural target for our framework for two reasons. First, the finalization engine (introduced in §E.4 and detailed in §F) determines SCC positions without resolving internal structure, so the algorithm terminates as soon as tier membership is established. Second, it gives the honest answer when preferences are cyclic. In our primary application – LLM-as-a-judge reranking – cycles arise not from noise but from genuine ambiguity: the oracle cannot consistently order those items, and reporting them as tied is more faithful than imposing an artificial distinction. When a total ordering is needed, ties may be broken by a secondary signal (e.g., the original retrieval score) or additional fine-grained queries.

Multi-wise comparisons. The information-theoretic advantage of k -wise comparisons is established in Ren et al. (2021), who prove that full-ranking feedback improves sample complexity by a factor of $k \log k$ over winner feedback for ranking recovery. Saha & Gopalan (2019) show similar gains under the Plackett–Luce model. Jang et al. (2017) and Chen et al. (2018) provide near-optimal algorithms for top- m selection under parametric models. For noisy comparisons, Feige et al. (1994) established $O(n \log n)$ bounds for sorting, tightened by Gu & Xu (2023). Our framework operates non-parametrically, using graph structure rather than score estimation, and addresses the query-efficient top- m selection problem that arises when each comparison is expensive. More specifically, our setting differs from prior work in three respects: (i) we assume a deterministic tournament rather than a stochastic comparison model, (ii) we use a k -wise oracle ($k \geq 2$) rather than restricting to pairwise queries, and (iii) we target the SCC decomposition ordering rather than a total ranking or a single tournament solution set. To our knowledge, no existing algorithm addresses this combination.

E.4. Technical Overview and Roadmap

The appendix provides full proofs of correctness and termination for the algorithms introduced in the main text. The central question throughout is: *given only the edges revealed so far, when can we certify that the current top- m vertices are correct with respect to the unknown tournament G^* ?* We answer this first for transitive tournaments, then lift the answer to arbitrary tournaments.

Two-layer architecture. The proofs separate cleanly into two layers, and keeping this separation in mind is a useful guide for reading the appendix.

The first layer is a *finalization engine* that works on any directed graph and is completely agnostic to the existence of an underlying tournament. It takes a partially revealed graph, sorts vertices by in-reach into a rank spectrum, and identifies a prefix of vertices whose relative positions are already forced by reachability alone. Informally, this layer answers: *given what we have seen so far, which vertices can we already certify as top-ranked?* The most interesting pieces apply to DAGs (subgraphs of transitive tournaments). In the general case, we will utilize condensation machinery (c.f. §F.2) to reduce subgraphs of non-transitive tournaments to DAGs to lift the finalization engine to general directed graphs.

The second layer is a *tournament bridge* that connects the finalization engine back to the ground truth. It uses properties specific to the underlying tournament to show that whenever the engine certifies a prefix in the revealed graph, the same prefix is correct in the full tournament. Informally: *why does certification in the subgraph imply correctness in G^* ?*

Transitive versus non-transitive case. In the transitive case, the revealed graph G_t at a round t is always a DAG (every subgraph of a transitive tournament is acyclic), so the finalization engine is applied directly to G_t and the bridge bounds discovered in-reach by true in-degree.

In the general case, G_t may contain cycles, so the engine cannot be applied to G_t directly. Instead, we move to the condensation $[G_t]$, which collapses cycles into tied tiers and is always a DAG. The finalization engine is reused without modification on $[G_t]$, but the bridge must be rebuilt: a projection map induced by SCC refinement relates $[G_t]$ to $[G^*]$ and transfers rank certificates from the discovered graph to the true tournament.

Roadmap. The appendix proceeds as follows.

- **Section F** develops the reusable graph-theoretic machinery: the rank spectrum, known relationships, condensation, and the finalization engine. Nothing here assumes a tournament.
- **Section G** builds the tournament bridge for transitive tournaments, derives the greedy query schedule, and proves correctness and termination of the transitive algorithm.
- **Section H** lifts the same engine to condensation graphs, rebuilds the bridge via SCC refinement and projection, and proves correctness and termination for arbitrary tournaments.
- **Section I** introduces the resolution-based stopping rule used by the practical algorithm (BLITZRANK – Algorithm 1) and proves its correctness and termination.
- **Section J** discusses query complexity bounds.

Readers interested primarily in the algorithm may begin with Section G and return to the non-transitive extension afterward; Section F serves as a reference for both.

F. Finalization Framework

This section builds the graph-theoretic objects that constitute the finalization engine described in the roadmap (§E.4). Nearly everything here is defined for arbitrary directed graphs; the few results that specialize to tournaments are marked. The section is organized in four parts:

- **Reachability framework** (§F.1.1): transitive closure, in-reach, and the rank spectrum.
- **Condensation** (§F.2): strongly connected components, the condensation graph, and their interaction with in-reach.
- **Known relationships** (§F.3): the resolved-vertex notion used by the practical algorithm’s stopping rule.
- **Finalization engine** (§F.4.2): the finalization threshold, finalized set, and their structural properties.

F.1. Reachability Framework

Transitive closure. Given a graph $G = (V, E)$, its transitive closure $G^+ = (V, E^+)$ is constructed by adding an edge (u, v) to E^+ if $u \rightsquigarrow_G v$ i.e.,

$$E^+ := \{(u, v) \in V \times V \mid u \neq v \text{ and } u \rightsquigarrow_G v\}.$$

Some observations:

1. Under transitive closure, in-reach and out-reach reduce to in-neighborhood and out-neighborhood, respectively.
2. If G is a DAG, then $R_G^-(v) \cap R_G^+(v) = \emptyset$. Otherwise, the intersection is not necessarily empty if G is not a DAG.

Lemma 3 (Downward Closure of In-Reach). *Let $G = (V, E)$ be a directed graph. If $x \in R_G^-(y)$, then $R_G^-(x) \cup \{x\} \subseteq R_G^-(y)$.*

Proof. Let $z \in R_G^-(x)$. By definition, $z \rightsquigarrow_G x$. Since $x \in R_G^-(y)$, we have $x \rightsquigarrow_G y$. Concatenating these paths gives $z \rightsquigarrow_G y$, so $z \in R_G^-(y)$. \square

The in-reach has useful properties when the graph G under consideration is a directed acyclic graph (DAG).

Lemma 4 (Strict Decrease of In-Reach Along Edges). *Let $G = (V, E)$ be a DAG. If $x \in R_G^-(y)$, then $|R_G^-(x)| < |R_G^-(y)|$.*

Proof. By Lemma 3, $R_G^-(x) \subseteq R_G^-(y)$. Since $x \in R_G^-(y)$ but $x \notin R_G^-(x)$ and $y \notin R_G^-(x)$ (due to otherwise being cyclic), the inclusion is strict. \square

F.1.1. RANK SPECTRUM

We now define the central objects of our framework. By analogy with the singular value decomposition, where the singular values $\sigma_1(A) \geq \sigma_2(A) \geq \dots$ are uniquely determined while their associated singular vectors may admit rotational freedom within tied singular subspaces, we pair in-reach values with their corresponding vertices. The rank spectrum $R(G)$ is uniquely determined regardless of tie-breaking, while the rank basis $V(G)$ is unique only up to permutation of vertices sharing the same in-reach.

Definition 5 (Rank Spectrum). Let $G = (V, E)$ be a directed graph on n vertices. An *in-reach ordering* of G is a sequence $v^{(1)}(G), v^{(2)}(G), \dots, v^{(n)}(G)$ of all vertices in V satisfying

$$r^{(1)}(G) \leq r^{(2)}(G) \leq \dots \leq r^{(n)}(G), \quad \text{where } r^{(i)}(G) := |R_G^-(v^{(i)}(G))|.$$

We call the sequence $R(G) := (r^{(1)}(G), \dots, r^{(n)}(G))$ the *rank spectrum* of G . Similarly, we call the sequence $V(G) = (v^{(1)}(G), \dots, v^{(n)}(G))$ the *rank basis* of G . When ties exist, the ordering among tied vertices may be broken arbitrarily; the rank spectrum $R(G)$ is uniquely determined regardless of tie-breaking.

The rank spectrum forms crucial connections from subgraphs of tournaments to the true underlying tournament.

Lemma 6 (Rank Spectrum Upper Bound for DAGs). Let $G = (V, E)$ be a DAG on n vertices. Then

$$r^{(i)}(G) \leq i - 1, \quad \text{for all } i \in [n].$$

Proof. Let $v = v^{(i)}(G)$ with in-reach $r := r^{(i)}(G) = |R_G^-(v)|$. By Lemma 4, every vertex in $R_G^-(v)$ has in-reach strictly less than r . Since $|R_G^-(v)| = r$, at least r vertices have in-reach less than r , so v occupies position $i \geq r + 1$ in the non-decreasing in-reach ordering. Hence $r^{(i)}(G) = r \leq i - 1$. \square

F.2. Condensation Graphs

For non-transitive tournaments, condensation plays a crucial role as in Section H, where it allows reduction from the general directed graph case to the DAG/transitive case by collapsing cycles into equivalence classes.

Strongly Connected Components (SCC). Let $G = (V, E)$ be a directed graph. A *strongly connected component* (SCC) of G is a maximal subset $C \subseteq V$ such that for all $u, v \in C$, there exist directed paths $u \rightsquigarrow_G v$ and $v \rightsquigarrow_G u$. We define the equivalence relation³ \sim_G on V by

$$u \sim_G v \iff u \text{ and } v \text{ are in the same SCC of } G.$$

For $u \in V$, we denote by $[u]_G$ the equivalence class of u under \sim_G .

This equivalence is important in the context of Problem 1 where equivalence implies equal in-reach.

Lemma 7 (Equal In-Reach Within SCCs). Let $G = (V, E)$ be a directed graph. If $u \sim_G v$, then $|R_G^-(u)| = |R_G^-(v)|$.

Proof. Since $u \sim_G v$, we have $u \rightsquigarrow_G v$ and $v \rightsquigarrow_G u$. For any $w \in V \setminus \{u, v\}$:

$$w \in R_G^-(u) \iff w \rightsquigarrow_G u \iff w \rightsquigarrow_G v \iff w \in R_G^-(v),$$

where the middle equivalence follows by concatenating with the path $u \rightsquigarrow_G v$ or $v \rightsquigarrow_G u$, respectively. Hence $R_G^-(u) \setminus \{v\} = R_G^-(v) \setminus \{u\}$, which gives $|R_G^-(u)| = |R_G^-(v)|$. \square

Definition 8 (Condensation Graph). The *condensation graph* of a directed graph G , denoted $[G]$, is the directed graph with vertex set $[V]_G := V/\sim_G$ and edge set

$$[E]_G := \{([u]_G, [v]_G) \mid \exists x \in [u]_G, y \in [v]_G \text{ such that } (x, y) \in E \text{ and } [u]_G \neq [v]_G\}.$$

We will also omit the subscript G and use $[V]$, $[E]$, and $[u] \in [V]$ when it is clear from the context.

³It is well-known that SCC form an equivalence relation. See for example [Wikipedia's SCC page](#).

Lemma 9 (Reachability Respects Condensation). *Let $G = (V, E)$ be a directed graph. Let $C, D \in [V]_G$ be distinct vertices in $[G]$. Then*

$$C \rightsquigarrow_{[G]} D \iff u \rightsquigarrow_G v, \quad \text{for all } u \in C \text{ and } v \in D.$$

Proof. (\Leftarrow) Fix any $u \in C$ and $v \in D$ with $u \rightsquigarrow_G v$. The path from u to v passes through a sequence of SCCs, inducing a path from C to D in $[G]$ by definition of the condensation edges.

(\Rightarrow) Let $C = C_0 \rightarrow C_1 \rightarrow \dots \rightarrow C_\ell = D$ be a path in $[G]$. For each edge $(C_i, C_{i+1}) \in [E]_G$, there exist $x_i \in C_i$ and $y_i \in C_{i+1}$ with $(x_i, y_i) \in E$. Since C_{i+1} is a strongly connected component, y_i and x_{i+1} are mutually reachable within C_{i+1} , so $y_i \rightsquigarrow_G x_{i+1}$. Now let $u \in C$ and $v \in D$ be arbitrary. Since $u, x_0 \in C_0$ and $x_\ell, v \in C_\ell$, mutual reachability within these SCCs gives $u \rightsquigarrow_G x_0$ and $x_\ell \rightsquigarrow_G v$. Concatenating:

$$u \rightsquigarrow_G x_0 \rightarrow y_0 \rightsquigarrow_G x_1 \rightarrow y_1 \rightsquigarrow_G \dots \rightsquigarrow_G x_\ell \rightarrow y_\ell \rightsquigarrow_G v. \quad \square$$

The condensation of a directed graph is always a DAG (Lemma 10). When the graph is a tournament, the condensation is moreover a transitive tournament (Proposition 11), which pins down the in-reach of every vertex (Lemma 12). These two tournament-specific results are included here because they complete the condensation picture and are referenced by multiple later sections.

Lemma 10 (Condensation is a DAG). *For any directed graph G , the condensation $[G]$ is a DAG.*

Proof. Suppose $[G]$ contains a cycle of distinct nodes $[u_1] \rightarrow [u_2] \rightarrow \dots \rightarrow [u_\ell] \rightarrow [u_1]$ with $\ell \geq 2$. Then for any $x \in [u_1]$ and $y \in [u_2]$, we have paths $x \rightsquigarrow y$ and $y \rightsquigarrow x$ (via the cycle), implying $x \sim_G y$. This contradicts $[u_1] \neq [u_2]$. \square

Proposition 11 (Condensation of Tournament is Transitive Tournament). *If G^* is a tournament, then $[G^*]$ is a transitive tournament.*

Proof. Let C_1, C_2 be distinct SCCs of G^* . Since G^* is a tournament, for any $u \in C_1$ and $v \in C_2$, either $(u, v) \in E^*$ or $(v, u) \in E^*$. We claim all edges between C_1 and C_2 go in the same direction. Suppose not: let $(u_1, v_1), (v_2, u_2) \in E^*$ with $u_1, u_2 \in C_1$ and $v_1, v_2 \in C_2$. Since $u_1 \sim_{G^*} u_2$ and $v_1 \sim_{G^*} v_2$, we have paths $u_2 \rightsquigarrow_{G^*} u_1$ and $v_1 \rightsquigarrow_{G^*} v_2$. Then

$$u_1 \rightarrow v_1 \rightsquigarrow_{G^*} v_2 \rightarrow u_2 \rightsquigarrow_{G^*} u_1$$

forms a cycle containing both u_1 and v_1 , contradicting $C_1 \neq C_2$. Thus $[G^*]$ is a tournament. Furthermore, since every acyclic tournament is transitive, $[G^*]$ is a transitive tournament. \square

Lemma 12 (In-Reach Within an SCC). *Let $G^* = (V, E^*)$ be a tournament with condensation SCCs C_1, \dots, C_L in condensation order. Then for any $v \in C_j$,*

$$|R_{G^*}^-(v)| = \sum_{i=1}^j |C_i| - 1.$$

In particular, all vertices in the same SCC share the same in-reach, and the common in-reach is strictly increasing in j .

Proof. Since C_j is strongly connected, every vertex in $C_j \setminus \{v\}$ reaches v , contributing $|C_j| - 1$. For $i < j$, the condensation path $C_i \rightsquigarrow_{[G^*]} C_j$ and Lemma 9 imply every vertex in C_i reaches v , contributing $|C_i|$. For $i > j$, the acyclicity of $[G^*]$ implies no vertex in C_i reaches v . Summing gives the result. Strict monotonicity in j follows from $|C_j| \geq 1$. \square

F.3. Known Relationships

Here, we introduce the *known relationship* set, which provides a simpler finalization criterion used in Algorithm 1.

Definition 13 (Known relationships). *The known relationship set of v in G is*

$$K_G(v) := R_G^-(v) \cup R_G^+(v), \quad (5)$$

and we write

$$\kappa_G(v) := |K_G(v)|$$

for its cardinality.

A vertex v is *resolved* in G if $\kappa_G(v) = n - 1$, i.e., every other vertex is reachable from or to v .

The known relationship has an interesting connection to the condensation graph.

Lemma 14 (Known Relationships Lift Between Graph and Condensation). *Let $G = (V, E)$ be a directed graph with n vertices. Let $[G]$ be its condensation with $n' := |[V]_G|$ vertices. For any SCC $C \in [V]_G$, the following are equivalent:*

1. $\kappa_{[G]}(C) = n' - 1$,
2. $\kappa_G(u) = n - 1$ for all $u \in C$,
3. $\kappa_G(u) = n - 1$ for some $u \in C$.

Proof. **(i) \Rightarrow (ii).** Let $u \in C$ and $v \in V \setminus \{u\}$. If $v \in C$, then $u \sim_G v$, so $v \in R_G^-(u) \cap R_G^+(u)$. If $v \in D$ for some SCC $D \neq C$, then $\kappa_{[G]}(C) = n' - 1$ implies $D \in R_{[G]}^-(C) \cup R_{[G]}^+(C)$. Lemma 9 gives $v \rightsquigarrow_G u$ or $u \rightsquigarrow_G v$, so $v \in R_G^-(u) \cup R_G^+(u)$. Since v was arbitrary, $\kappa_G(u) = n - 1$.

(ii) \Rightarrow (iii). Immediate (since $C \neq \emptyset$).

(iii) \Rightarrow (i). Let $u \in C$ satisfy $\kappa_G(u) = n - 1$. Take any SCC $D \neq C$ and pick any $v \in D$. Since $v \in R_G^-(u) \cup R_G^+(u)$, either $v \rightsquigarrow_G u$ or $u \rightsquigarrow_G v$. By Lemma 9, either $D \rightsquigarrow_{[G]} C$ or $C \rightsquigarrow_{[G]} D$, so $D \in R_{[G]}^-(C) \cup R_{[G]}^+(C)$. Since D was arbitrary, $\kappa_{[G]}(C) = n' - 1$. \square

Remark 15. The equivalence (ii) \Leftrightarrow (iii) says that resolution is an *all-or-nothing* property within an SCC: if any single vertex in C has all its relationships determined, then every vertex in C does. This is immediate from the proof, but can also be seen directly: for $u, w \in C$, mutual reachability gives $R_G^-(u) \cup R_G^+(u) \supseteq (R_G^-(w) \cup R_G^+(w)) \setminus \{u\}$, since any vertex reaching w also reaches u (via $w \rightsquigarrow u$), and any vertex reachable from w is reachable from u (via $u \rightsquigarrow w$).

F.4. Finalization Engine

We now introduce machinery for measuring how much of the ranking has been determined in a directed graph. The definitions below apply to any directed graph; they will later be instantiated with the revealed subgraphs arising from oracle queries.

Definition 16 (Finalization Threshold and Finalized Set). Let $G = (V, E)$ be a directed graph on n vertices with rank spectrum $R(G) = (r^{(1)}(G), \dots, r^{(n)}(G))$ and corresponding rank basis $(v^{(1)}(G), \dots, v^{(n)}(G))$.

1. The *finalization threshold* $m(G)$ is the largest $j \geq 0$ such that:

$$\begin{aligned} \text{(i)} \quad & r^{(i)}(G) = i - 1 \text{ for all } i = 1, \dots, j, \\ \text{(ii)} \quad & j \in \{0, n\} \text{ or } r^{(j)}(G) < r^{(j+1)}(G). \end{aligned} \tag{6}$$

2. The *finalized set* contains the finalized vertices:

$$\text{TOP}(G) := \{v^{(1)}(G), \dots, v^{(m(G))}(G)\}. \tag{7}$$

3. The *candidate set* is the complement of the finalized set:

$$\text{CAND}(G) := V \setminus \text{TOP}(G) = \{v^{(m(G)+1)}(G), \dots, v^{(n)}(G)\}. \tag{8}$$

Informally, $m(G)$ measures how much of the rank spectrum has “crystallized” into the pattern $0, 1, 2, \dots$ that characterizes a fully discovered transitive tournament. The finalized set $\text{TOP}(G)$ contains the vertices whose positions in this prefix are fully determined.

F.4.1. GENERAL PROPERTIES OF $\text{TOP}(G)$

Note that $v^{(j)}(G) \in \text{TOP}(G)$ if and only if $j \leq m(G)$. We establish some properties about nodes in $\text{TOP}(G)$ for general directed graphs.

Lemma 17 (Exact In-Reach of Top Vertices). *Let $G = (V, E)$ be a directed graph. If $m(G) \geq 1$, we have $R_G^-(v^{(1)}(G)) = \emptyset$ and for $1 < j \leq m(G)$, we have*

$$R_G^-(v^{(j)}(G)) = \{v^{(1)}(G), \dots, v^{(j-1)}(G)\}.$$

Proof. Let $j \leq m(G)$ and write $v^{(j)} = v^{(j)}(G)$ for brevity. The $j = 1$ case is trivial. Consider $j \geq 2$. By the finalization threshold, $|R_G^-(v^{(j)})| = r^{(j)}(G) = j - 1$.

Let $u \in R_G^-(v^{(j)})$. By Lemma 3, $R_G^-(u) \subseteq R_G^-(v^{(j)})$, so $|R_G^-(u)| \leq j - 1$. Since the finalization threshold requires the top j vertices to have distinct in-reach sizes and $v^{(j)}$ already has in-reach $j - 1$, we must have strict inequality. Hence, $|R_G^-(u)| \leq j - 2$, which places $u \in \{v^{(1)}, \dots, v^{(j-1)}\}$. This means that $R_G^-(v^{(j)}) \subseteq \{v^{(1)}, \dots, v^{(j-1)}\}$. Both sets have cardinality $j - 1$, so they are equal. \square

Corollary 18 (Reachability of Top Vertices). *Let $G = (V, E)$ be a directed graph. If $1 \leq i < j \leq m(G)$, then we have*

$$v^{(i)}(G) \rightsquigarrow_G v^{(j)}(G).$$

Proof. Write $v^{(j)} = v^{(j)}(G)$ for brevity. By Lemma 17, $R_G^-(v^{(j)}) = \{v^{(1)}, \dots, v^{(j-1)}\}$. Since $i < j$, we have $v^{(i)} \in \{v^{(1)}, \dots, v^{(j-1)}\} = R_G^-(v^{(j)})$, which by definition means $v^{(i)} \rightsquigarrow_G v^{(j)}$. \square

Lemma 19 (Vertices Outside of TOP Have Large In-Reach). *Let $G = (V, E)$ be a directed graph. If $u \notin \text{TOP}(G)$, then $|R_G^-(u)| \geq m(G)$.*

Proof. Note that this trivially holds if $m(G) = 0$. Consider $m(G) > 0$. Let $m := m(G)$ for short and let $u := v^{(k)}(G)$ for some $k > m$, so that $u \notin \text{TOP}(G)$. From the finalization criterion (Definition 16), we have $r^{(m)}(G) = m - 1$ and $r^{(m)}(G) < r^{(m+1)}(G)$. Since the rank spectrum is non-decreasing and $k > m$:

$$|R_G^-(u)| = r^{(k)}(G) \geq r^{(m+1)}(G) > r^{(m)}(G) = m - 1.$$

Since in-reach sizes are integers, $|R_G^-(u)| \geq m = m(G)$. \square

The next Lemma requires G to be a DAG.

Lemma 20 (Top Vertices Reach All Non-Top Vertices). *Let $G = (V, E)$ be a DAG. For any $w \in \text{TOP}(G)$ and any $u \in \text{CAND}(G)$, we have $w \rightsquigarrow_G u$.*

Proof. Let $u \in \text{CAND}(G) \implies u \notin \text{TOP}(G)$. We construct a sequence $(x_i)_{i \geq 0}$ iteratively from u to a node to $\text{TOP}(G)$:

- Set $x_0 = u$.
- While $R_G^-(x_i) \cap \text{CAND}(G) \neq \emptyset$, set $x_{i+1} \in R_G^-(x_i) \cap \text{CAND}(G)$. Note that $x_{i+1} \rightsquigarrow x_i \rightsquigarrow x_{i-1} \rightsquigarrow \dots \rightsquigarrow x_0 = u$.
- We terminate the sequence when $R_G^-(x_i) \cap \text{CAND}(G) = \emptyset$.

Each x_i lies in $\text{CAND}(G) = V \setminus \text{TOP}(G)$, so by Lemma 19:

$$|R_G^-(x_i)| \geq m(G), \quad \text{for all } i.$$

By Lemma 4, since G is a DAG by assumption, whenever x_{i+1} exists:

$$|R_G^-(x_{i+1})| < |R_G^-(x_i)|.$$

The in-reach sizes form a strictly decreasing sequence of non-negative integers bounded below by $m(G)$. Therefore, the sequence must terminate at some finite index k and each element x_i for $i = 0, \dots, k$ is unique. We show that at termination, the in-reach of the termination node x_k equals $\text{TOP}(G)$ i.e., $R_G^-(x_k) = \text{TOP}(G)$.

At termination time k , we have $R_G^-(x_k) \cap \text{CAND}(G) = \emptyset$. That implies

$$R_G^-(x_k) \subseteq \text{TOP}(G).$$

Since $x_k \in \text{CAND}(G) \implies x_k \notin \text{TOP}(G)$, Lemma 19 gives $|R_G^-(x_k)| \geq m(G)$. Combined with $|\text{TOP}(G)| = m(G)$ and the inclusion above implies:

$$R_G^-(x_k) = \text{TOP}(G).$$

Since $x_{i+1} \in R_G^-(x_i)$ for all $i = 0, 1, \dots, k - 1$, by Lemma 3, we have $R_G^-(x_{i+1}) \subseteq R_G^-(x_i)$. Applying this repeatedly:

$$\text{TOP}(G) = R_G^-(x_k) \subseteq R_G^-(x_{k-1}) \subseteq \dots \subseteq R_G^-(x_0) = R_G^-(u).$$

Hence, for any $w \in \text{TOP}(G)$, we have $w \in R_G^-(u)$, which by definition means $w \rightsquigarrow_G u$. \square

Remark 21. Unlike most results in this section, the DAG assumption in Lemma 20 is essential. Cycles can inflate the in-reach of vertices outside $\text{TOP}(G)$ without any connection to the finalized vertices. For instance, consider $V = \{a, b, c\}$ with only edges $b \rightarrow c$ and $c \rightarrow b$. Then $\text{TOP}(G) = \{a\}$, yet a reaches neither b nor c : the cycle between b and c alone is responsible for their in-reach meeting the threshold $m(G) = 1$.

F.4.2. STRUCTURAL PROPERTIES OF THE FINALIZATION THRESHOLD

The following lemmas establish structural properties of the finalization threshold.

Lemma 22 (Tied Candidates After Finalization Threshold). *Let $G = (V, E)$ be a DAG on n vertices. Let $m' := m(G)$ be the finalization threshold of G . If $0 < m' \leq n - 2$, then*

$$r^{(m'+1)}(G) = r^{(m'+2)}(G).$$

Proof. Suppose for contradiction that $r^{(m'+1)}(G) < r^{(m'+2)}(G)$. Since $0 < m' \leq n - 2$, the finalization conditions give $r^{(m')}(G) = m' - 1$ and $r^{(m')}(G) < r^{(m'+1)}(G)$. By Lemma 6, $r^{(m'+1)}(G) \leq m'$. Hence

$$m' - 1 = r^{(m')}(G) < r^{(m'+1)}(G) \leq m',$$

forcing $r^{(m'+1)}(G) = m'$. Thus $r^{(i)}(G) = i - 1$ holds for all $i \leq m' + 1$, and the strict inequality $r^{(m'+1)}(G) < r^{(m'+2)}(G)$ satisfies condition (6)(ii) for $j = m' + 1$, contradicting the maximality of m' . \square

Tied candidates have a useful structural property: no edge can exist between two vertices with the same in-reach in a DAG.

Lemma 23 (Tied Candidates Have Unknown Edge). *Let $G = (V, E)$ be a DAG. If $u, v \in V$ are distinct nodes satisfying $|R_G^-(u)| = |R_G^-(v)|$, then neither (u, v) nor (v, u) belong to E .*

Proof. WLOG, suppose for contradiction that $(u, v) \in E$. Thus, $u \in R_G^-(v)$ which implies $|R_G^-(u)| < |R_G^-(v)|$ by Lemma 4. This is a contradiction to $|R_G^-(u)| = |R_G^-(v)|$. \square

Lemma 24 (No Penultimate Finalization). *Let $G = (V, E)$ be a directed graph on $n \geq 2$ vertices. Let $m' := m(G)$ be the finalization threshold of G . Then*

$$m' \neq n - 1.$$

Consequently, $m' \in \{0, 1, \dots, n - 2, n\}$.

Proof. Suppose for contradiction that $m' = n - 1$. Since $n \geq 2$, we have $n - 1 \notin \{0, n\}$, so Definition 16 requires:

1. $r^{(i)}(G) = i - 1$ for all $i \in [n - 1]$, and
2. $r^{(n-1)}(G) < r^{(n)}(G)$.

From (i), $r^{(n-1)}(G) = n - 2$, so (ii) gives $r^{(n)}(G) \geq n - 1$. Since $r^{(n)}(G) = |R_G^-(v^{(n)}(G))| \leq |V \setminus \{v^{(n)}(G)\}| = n - 1$, we obtain $r^{(n)}(G) = n - 1$. Hence $r^{(i)}(G) = i - 1$ for all $i \in [n]$, and $j = n$ satisfies the finalization conditions in (6) (since $n \in \{0, n\}$), contradicting the maximality of $m' = n - 1$. \square

G. Transitive Tournaments

We analyze Problem 1 for the special case of *transitive tournaments*: A graph $G^* = (V, E^*)$ is a transitive tournament if it is a tournament and it is transitive i.e., if $(u, v) \in E^*$ and $(v, w) \in E^*$, then $(u, w) \in E^*$. We provide an algorithm for this special case with correctness guarantees.

G.1. Algorithm Framework

We adopt an iterative approach: at each round, we query a carefully chosen subset of vertices, update our knowledge of the graph, and terminate once we have sufficient information to identify the top- m vertices.

Notation. At each round $t = 1, 2, \dots, T$:

- $Q_t \in \binom{V}{k}$ denotes the queried k -subset.

- $\hat{E}_t := O_{G^*}(Q_t)$ denotes the edges revealed by the oracle.
- $E_t := E_{t-1} \cup \hat{E}_t$ denotes the cumulative set of revealed edges, with $E_0 := \emptyset$.
- $G_t := (V, E_t)$ denotes the *revealed graph* at round t .

By construction, $\emptyset = E_0 \subseteq E_1 \subseteq \dots \subseteq E_T \subseteq E^*$. A good algorithm should ideally produce a strictly increasing chain.

The rank spectrum (Definition 5) of the revealed graph at round t is the main object of interest.

Discovered Rankings. At round t , we order the vertices by non-decreasing in-reach in G_t , breaking ties arbitrarily:

$$v_t^{(1)}, v_t^{(2)}, \dots, v_t^{(n)} \quad \text{with} \quad r_t^{(1)} \leq r_t^{(2)} \leq \dots \leq r_t^{(n)},$$

where $r_t^{(i)} := |R_{G_t}^-(v_t^{(i)})|$. The sequence $R_t := (r_t^{(1)}, \dots, r_t^{(n)})$ is the *discovered rank sequence* at round t . We use these as notational shorthands for Definition 16, where

$$v_t^{(i)} := v^{(i)}(G_t) \quad \text{and} \quad r_t^{(i)} := r^{(i)}(G_t).$$

Initially, $R_0 = (0, 0, \dots, 0)$ since no edges have been revealed.

G.2. Basic Facts about Transitive Tournaments

We review basic facts about transitive tournaments here.

Remark 25 (Transitive Tournaments are Acyclic). A transitive tournament contains no directed cycles. Indeed, if $v_1 \rightarrow v_2 \rightarrow \dots \rightarrow v_\ell \rightarrow v_1$ were a cycle with $\ell \geq 2$, transitivity would give $(v_1, v_\ell) \in E^*$, while the cycle requires $(v_\ell, v_1) \in E^*$, contradicting the tournament property. In particular, every transitive tournament is a DAG.

Lemma 26 (Transitive Tournaments are their own Transitive Closure). *Let G^* be a transitive tournament. Then $(G^*)^+ = G^*$; that is, $u \rightsquigarrow_{G^*} v$ if and only if $(u, v) \in E^*$.*

Proof. The backward direction is immediate. For the forward direction, suppose $u \rightsquigarrow_{G^*} v$ via a path $u = w_0 \rightarrow w_1 \rightarrow \dots \rightarrow w_\ell = v$. Repeated application of transitivity ($(w_0, w_1) \in E^*$ and $(w_1, w_2) \in E^*$ give $(w_0, w_2) \in E^*$; then (w_0, w_2) and (w_2, w_3) give (w_0, w_3) ; and so on) yields $(u, v) \in E^*$. \square

Corollary 27 (In-Reach Equals In-Nighborhood). *In a transitive tournament G^* ,*

$$R_{G^*}^-(v) = N_{G^*}^-(v) := \{u \in V \setminus \{v\} : (u, v) \in E^*\}$$

for every vertex v . In particular, $|R_{G^}^-(v)| = \deg_{G^*}^-(v)$.*

Proof. Immediate from Lemma 26: $u \in R_{G^*}^-(v)$ iff $u \rightsquigarrow_{G^*} v$ iff $(u, v) \in E^*$ iff $u \in N_{G^*}^-(v)$. \square

Lemma 28 (Strict In-Degree Separation in Transitive Tournaments). *Let G^* be a transitive tournament. If $(u, v) \in E^*$, then $\deg_{G^*}^-(v) \geq \deg_{G^*}^-(u) + 1$. In particular, no two vertices share the same in-degree.*

Proof. Suppose $(u, v) \in E^*$. For any in-neighbor w of u , we have $(w, u) \in E^*$ and $(u, v) \in E^*$, so transitivity gives $(w, v) \in E^*$. Hence $N_{G^*}^-(u) \subseteq N_{G^*}^-(v)$. Since $u \in N_{G^*}^-(v) \setminus N_{G^*}^-(u)$, the inclusion is strict, giving $\deg_{G^*}^-(v) \geq \deg_{G^*}^-(u) + 1$.

For uniqueness: given any two distinct vertices $u \neq v$, the tournament property forces $(u, v) \in E^*$ or $(v, u) \in E^*$, so the above gives $\deg_{G^*}^-(u) \neq \deg_{G^*}^-(v)$. \square

The following is a classical result; see, e.g., Chapter 1 of (Moon, 2015).

Corollary 29 (In-Degree Sequence of Transitive Tournaments). *A transitive tournament on n vertices has in-degree multiset $\{0, 1, \dots, n-1\}$.*

Proof. By Lemma 28, the n in-degrees are pairwise distinct. Since each in-degree lies in $\{0, 1, \dots, n-1\}$ by the tournament property, the in-degrees must be exactly $\{0, 1, \dots, n-1\}$. \square

G.3. Rank Spectrum of Transitive Tournaments

The rank spectrum (Definition 5) of a transitive tournament admits some special properties.

Proposition 30 (Rank Spectrum of Transitive Tournaments). *Let G^* be a transitive tournament of n nodes. We have:*

$$r^{(i)}(G^*) = i - 1, \quad \text{for } i = 1, 2, \dots, n.$$

Proof. By Corollary 27, $|R_{G^*}^-(v)| = \deg_{G^*}^-(v)$ for every v . By Corollary 29, the in-degrees are exactly $\{0, 1, \dots, n - 1\}$. Sorting vertices by non-decreasing in-reach (Definition 5) therefore gives $r^{(i)}(G^*) = i - 1$. \square

Notation. Since the transitive tournament G^* is fixed throughout this section, we write

$$r_*^{(i)} := r^{(i)}(G^*) = i - 1 \quad \text{and} \quad v_*^{(i)} := v^{(i)}(G^*) \quad (9)$$

for the rank spectrum and rank basis of G^* , respectively.

The rank spectrum (Definition 5) allows us to make important connections between subgraphs (e.g. our discovered graph) of tournament graphs to the potential underlying unknown tournament graph.

Lemma 31. *Let $G^* = (V, E^*)$ be a transitive tournament. Let $G' = (V, E')$ be a subgraph of G^* where $E' \subseteq E^*$. Then for all $v \in V$:*

$$|R_{G'}^-(v)| \leq \deg_{G^*}^-(v).$$

Proof. Since $E' \subseteq E^*$, we have $R_{G'}^-(v) \subseteq R_{G^*}^-(v)$ for all $v \in V$. Since G^* is a transitive tournament, in-reach coincides with in-neighborhood by Corollary 27, hence $|R_{G^*}^-(v)| = \deg_{G^*}^-(v)$. Combining these inequalities yields the result:

$$|R_{G'}^-(v)| \leq |R_{G^*}^-(v)| = \deg_{G^*}^-(v). \quad \square$$

Another connection we can make is by applying Lemma 6 to the rank spectrum of subgraphs of the transitive tournament.

Corollary 32 (Rank Upper Bound for Subgraphs of Transitive Tournaments). *Let $G^* = (V, E^*)$ be a transitive tournament on n vertices. Let $G' = (V, E')$ be a subgraph of G^* where $E' \subseteq E^*$. Then*

$$r^{(i)}(G') \leq r_*^{(i)} = i - 1, \quad \text{for all } i \in [n].$$

Proof. By Remark 25, G^* is acyclic. Since $E' \subseteq E^*$, the subgraph G' is also acyclic. The bound $r^{(i)}(G') \leq i - 1$ then follows from Lemma 6, and $r_*^{(i)} = i - 1$ is Proposition 30. \square

G.4. Eliminations and Finalization

Remark 33 (A Filtering Criterion). *Let $G^* = (V, E^*)$ be a transitive tournament. Let $G' = (V, E')$ be a subgraph of G^* where $E' \subseteq E^*$. If a vertex $v \in V$ satisfies $|R_{G'}^-(v)| \geq m$, then v is *not* in the final top m vertices of G^* i.e., $v \notin \{v_*^{(1)}, \dots, v_*^{(m)}\}$.*

Proof. In a transitive tournament on n vertices, the true in-degrees are exactly $\{0, 1, \dots, n - 1\}$, so $r_*^{(m)} = m - 1$ (Proposition 30). By Corollary 32, $|R_{G'}^-(v)| \leq \deg_{G^*}^-(v)$. Thus $|R_{G'}^-(v)| \geq m$ implies $\deg_{G^*}^-(v) \geq m > r_*^{(m)}$, so v cannot be among the top m vertices. \square

We say that a vertex v in a subgraph G' of an underlying tournament G^* is *finalized* when we have sufficient information to confirm v 's membership in the top- m set of G^* . The following proposition characterizes when this occurs.

Proposition 34 (Top- j Finalization Criterion in Transitive Tournaments). *Let $G^* = (V, E^*)$ be a transitive tournament. Let $G' = (V, E')$ be a subgraph of G^* where $E' \subseteq E^*$. Suppose there exists $j \in [n - 1]$ such that $r^{(1)}(G') < r^{(2)}(G') < \dots < r^{(j)}(G') < r^{(j+1)}(G')$. Then the top j rank spectrum of G' aligns with G^* i.e.,*

1. $r^{(i)}(G') = i - 1$ for all $i \leq j$, and
2. $(v^{(1)}(G'), v^{(2)}(G'), \dots, v^{(j)}(G')) = (v_*^{(1)}, v_*^{(2)}, \dots, v_*^{(j)})$.

Algorithm 2 Greedy Tournament Sort (Transitive Case)

Require: Vertex set V with $|V| = n$, oracle O_{G^*} with query size k , target count $m \leq n$

Ensure: Top- m vertices $(v_*^{(1)}, \dots, v_*^{(m)})$ in ascending in-reach order

```

1:  $E_0 \leftarrow \emptyset$ ,  $G_0 \leftarrow (V, E_0)$ ,  $t \leftarrow 0$ 
2: while true do
3:   Compute rank spectrum  $R_t = (r_t^{(1)}, \dots, r_t^{(n)})$  of  $G_t$  per Definition 5
4:   Compute rank basis  $(v_t^{(1)}, \dots, v_t^{(n)})$  of  $G_t$  per Definition 5
5:   Compute finalization threshold  $m_t := m(G_t)$  per Definition 16
6:   if  $m_t \geq m$  then
7:     {termination condition}
8:     break
9:   end if
10:   $k' \leftarrow \min(k, n - m_t)$  { $n - m_t \geq 2$  by Lemma 24}
11:   $S_t \leftarrow \{v_t^{(m_t+1)}, \dots, v_t^{(m_t+k')}\}$  { $k'$  candidates with smallest in-reach}
12:  if  $k' < k$  then
13:    Pad:  $Q_t \leftarrow S_t \cup P_t$ , where  $P_t \subseteq \text{TOP}(G_t)$  with  $|P_t| = k - k'$ 
14:  else
15:     $Q_t \leftarrow S_t$ 
16:  end if
17:  Query oracle:  $\hat{E}_t \leftarrow O_{G^*}(Q_t)$ 
18:  Update:  $E_{t+1} \leftarrow E_t \cup \hat{E}_t$ ,  $G_{t+1} \leftarrow (V, E_{t+1})$ 
19:   $t \leftarrow t + 1$ 
20: end while
21: return  $(v_t^{(1)}, \dots, v_t^{(m)})$ 
    
```

Proof. We prove (a) by induction. For the base case, by Corollary 32, $r^{(1)}(G') \leq r_*^{(1)} = 0$. Furthermore, $r^{(1)}(G') = |R_{G'}^-(v^{(1)}(G'))| \geq 0$ implies that $r^{(1)}(G') = 0$. For the inductive step, assuming $r^{(i-1)}(G') = i - 2$, the strict inequality $r^{(i)}(G') > r^{(i-1)}(G') = i - 2$ combined with $r^{(i)}(G') \leq r_*^{(i)} = i - 1$ from Corollary 32 forces $r^{(i)}(G') = i - 1$.

For (b), since $r^{(j+1)}(G') > r^{(j)}(G') = j - 1$ from (a), we have $r^{(j+1)}(G') \geq j$. All vertices $v^{(j+1)}(G'), \dots, v^{(n)}(G')$ have discovered in-reach at least $r^{(j+1)}(G') \geq j$. Hence, vertices $v^{(j+1)}(G'), \dots, v^{(n)}(G')$ cannot be among the top j in G^* following Proposition 30. This establishes the set equality. The ordering within the set follows by matching ranks. \square

Proposition 34 provides the key bridge for transitive tournaments: whenever a strictly increasing prefix appears in the discovered rank spectrum, that prefix is correct with respect to the true tournament. Combined with the finalization threshold (Definition 16), which captures the maximal extent of this crystallization, this drives both the algorithm design and its termination analysis.

G.5. A Greedy Algorithm for Ranking Transitive Tournaments

Remark 35. When $|\text{CAND}(G_t)| < k$, the padding vertices in $P_t \subseteq \text{TOP}(G_t)$ are already finalized; edges revealed involving P_t are redundant by Corollary 18 and Lemma 20, so padding preserves correctness while satisfying the oracle's requirement that $|Q_t| = k$.

We now present Algorithm 2 that iteratively queries carefully and adaptively chosen sets of k vertices until the top- m vertices are finalized. The key insight is to always query candidates with the smallest discovered in-reach to guarantee that we always add an edge to make progress, where we terminate when there is enough information to finalize all top candidates. The correctness proof is presented in Theorem 37.

To establish correctness, we show that Algorithm 2 adds at least one new edge every round (for at most $\binom{n}{2}$ rounds), guaranteeing that we do not get stuck and that we terminate eventually when we have enough information.

Theorem 36 (Termination of Algorithm 2). *Algorithm 2 terminates in at most $\binom{n}{2}$ rounds.*

Proof. At a non-terminal round t , we have $m_t < m \leq n$. By Lemma 24, $m_t \neq n - 1$, so $m_t \leq n - 2$ and thus

$|\text{CAND}(G_t)| = n - m_t \geq 2$. We claim $r_t^{(m_t+1)} = r_t^{(m_t+2)}$. If $m_t > 0$, Lemma 22 implies that $r_t^{(m_t+1)} = r_t^{(m_t+2)}$. If $m_t = 0$, then the finalization condition $r_t^{(1)} < r_t^{(2)}$ fails, so $r_t^{(1)} = r_t^{(2)}$ (since ranks are non-decreasing). In any case, $r_t^{(m_t+1)} = r_t^{(m_t+2)}$ implies that $v_t^{(m_t+1)}$ and $v_t^{(m_t+2)}$ are tied candidates i.e., $|R_{G_t}^-(v_t^{(m_t+1)})| = |R_{G_t}^-(v_t^{(m_t+2)})|$. By Lemma 23, the edge between $v_t^{(m_t+1)}$ and $v_t^{(m_t+2)}$ is not in E_t . Since both vertices are in Q_t , querying the oracle reveals this edge, ensuring $|E_{t+1}| > |E_t|$. \square

The algorithm terminates and outputs something. We now prove that its output correctly solves Problem 1.

Theorem 37 (Correctness of Algorithm 2). *Algorithm 2 correctly identifies the top- m vertices of a transitive tournament graph G^* .*

Proof. At termination round T , $m_T \geq m$. We verify that the output $(v_T^{(1)}, \dots, v_T^{(m)})$ satisfies the two conditions of Problem 1. Since $m_T \geq m \geq 1$, the finalization threshold (Definition 16) provides: (i) $r_T^{(i)} = i - 1$ for all $i \leq m_T$, and (ii) $m_T = n$ or $r_T^{(m_T)} < r_T^{(m_T+1)}$. Applying Proposition 34 with $j = m_T$ (using (i), (ii), and the fact that G_T is a subgraph of the transitive tournament G^*) yields:

$$v_T^{(i)} = v_*^{(i)} \quad \text{for all } i \leq m_T. \quad (10)$$

In particular, the first $m \leq m_T$ output vertices satisfy $v_T^{(i)} = v_*^{(i)}$ for $i = 1, \dots, m$. By Corollary 27, in-reach coincides with in-degree in a transitive tournament, and by Proposition 30, $|R_{G^*}^-(v_*^{(i)})| = i - 1$. Therefore:

Internal ordering (3). For $i = 1, \dots, m$:

$$|R_{G^*}^-(v_T^{(i)})| = |R_{G^*}^-(v_*^{(i)})| = i - 1,$$

which is strictly increasing in i .

Rank dominance (4). Let $S = \{v_T^{(1)}, \dots, v_T^{(m)}\}$. The maximum in-reach within S is $|R_{G^*}^-(v_T^{(m)})| = m - 1$. For any $u \notin S$, we have $u = v_*^{(j)}$ for some $j > m$ (by (10) and the uniqueness of rank basis in transitive tournaments), so $|R_{G^*}^-(u)| = j - 1 \geq m > m - 1$. Hence

$$\max_{i \leq m} |R_{G^*}^-(v_T^{(i)})| = m - 1 < m \leq \min_{u \notin S} |R_{G^*}^-(u)|. \quad \square$$

H. Non-Transitive Tournaments

We now generalize Algorithm 2 to arbitrary tournaments. When G^* is not transitive, two difficulties arise.

1. **Finalization breaks down.** The finalization threshold (Definition 16) requires the rank spectrum to form a strictly increasing prefix $0, 1, 2, \dots$ – the signature of a transitive tournament (Proposition 30). In a non-transitive tournament, vertices sharing an SCC have equal in-reach (Lemma 7 and 12), so ties are intrinsic and this prefix pattern need not appear in G_t itself.
2. **Scheduling breaks down.** Algorithm 2 guarantees progress by querying tied candidates, which must have an unknown edge between them (Lemma 23). In the general case, tied vertices may already share a known edge via a cycle, so the same scheduling rule can stall.

Both difficulties are resolved by a single observation: the condensation $[G]$ of any directed graph is a DAG (Lemma 10), and the condensation of any tournament is a transitive tournament (Proposition 11). This lets us reuse the finalization engine from Section F without modification by applying it to $[G_t]$ rather than to G_t directly.

The tournament bridge, however, must be rebuilt. In-reach in a subgraph G_t no longer directly bounds in-degree in G^* , so we instead relate the two condensations $[G_t]$ and $[G^*]$ through the natural projection map induced by SCC refinement (Lemma 39). This projection preserves reachability (Lemma 41) and yields a new bridge lemma (Lemma 42) that transfers rank information from the revealed subgraph to the true tournament via the condensation. Adding edges can only merge SCCs and never split them, so the projection is monotone and the algorithm makes steady progress.

Algorithm 3 implements this strategy. The remainder of the section develops the necessary machinery: Section H.1 establishes SCC refinement and the projection map, Section H.2 connects the rank spectra of G_t and $[G_t]$ to that of G^* , and Section H.3 proves termination and correctness.

Algorithm 3 Tournament Sort General

Require: Vertex set V with $|V| = n$, oracle O_{G^*} with query size k , target count $m \leq n$

Ensure: A sequence of top- m vertices $(v_*^{(1)}, \dots, v_*^{(m)})$ in non-decreasing in-reach order.

```

1:  $E_0 \leftarrow \emptyset$ ,  $G_0 \leftarrow (V, E_0)$ ,  $t \leftarrow 0$ 
2: while true do
3:   Compute the condensation graph  $[G_t] = ([V_t], [E_t])$  with  $n_t := |[V_t]|$  per Definition 8.
4:   Compute rank spectrum  $\widetilde{R}_t := (r^{(1)}([G_t]), \dots, r^{(n_t)}([G_t]))$  of  $[G_t]$  per Definition 5
5:   Compute the corresponding rank basis  $(C_t^{(1)}, \dots, C_t^{(n_t)})$  of  $[G_t]$  given  $\widetilde{R}_t$  per Definition 5 where  $r^{(i)}([G_t]) := R_{[G_t]}^-(C_t^{(i)})$  for  $C_t^{(i)} \in [V_t]$ .
6:   Compute finalization threshold  $\widetilde{m}_t := m([G_t])$  per (6).
7:   Compute finalized SCCs  $\widetilde{\text{TOP}}_t \leftarrow \{C_t^{(1)}, \dots, C_t^{(\widetilde{m}_t)}\} = \text{TOP}([G_t])$  per (7).
8:    $\text{TOP}_t \leftarrow \bigcup_{i=1}^{\widetilde{m}_t} C_t^{(i)}$  {lift finalized nodes to graph}
9:   if  $|\text{TOP}_t| \geq m$  then
10:    break {we found enough top nodes}
11:   end if
12:    $k' \leftarrow \min(k, n_t - \widetilde{m}_t)$ 
13:    $\widetilde{\text{CAND}}_t \leftarrow \{C_t^{(\widetilde{m}_t+1)}, \dots, C_t^{(\widetilde{m}_t+k')}\}$  { $k'$  candidates with smallest in-reach}
14:   if  $k' < k$  then
15:     Pad:  $\widetilde{Q}_t \leftarrow \widetilde{\text{CAND}}_t \cup P_t$ , where  $P_t \subseteq \text{TOP}([G_t])$  with  $|P_t| = k - k'$ 
16:   else
17:      $\widetilde{Q}_t \leftarrow \widetilde{\text{CAND}}_t$ 
18:   end if
19:   Pick representative:  $Q_t \leftarrow \{\text{rep}(C) : C \in \widetilde{Q}_t\}$  where rep picks an element from a set.
20:   Query oracle:  $\hat{E}_t \leftarrow O_{G^*}(Q_t)$ 
21:   Update:  $E_{t+1} \leftarrow E_t \cup \hat{E}_t$ ,  $G_{t+1} \leftarrow (V, E_{t+1})$ 
22:    $t \leftarrow t + 1$ 
23: end while
24: Let  $j^* \leftarrow \min\{j \leq \widetilde{m}_t : \sum_{i=1}^j |C_t^{(i)}| \geq m\}$ 
25: Let  $S_{j^*}$  be any subset of  $C_t^{(j^*)}$  with  $|S_{j^*}| = m - \sum_{i=1}^{j^*-1} |C_t^{(i)}|$ 
26: return the solution sequence  $S := (v^{(1)}, \dots, v^{(m)})$  obtained by concatenating  $C_t^{(1)}, C_t^{(2)}, \dots, C_t^{(j^*-1)}, S_{j^*}$  in this order.

```

Remark 38 (Equivalence for Transitive Case). When the underlying tournament G^* is transitive, Algorithm 3 reduces to Algorithm 2. Specifically:

1. All SCCs are singletons: $[u]_{G_t} = \{u\}$ for all $u \in V$ and round t .
2. $[G_t] \cong G_t$ canonically.
3. In-reach in $[G_t]$ equals in-reach in G_t .

Proof. In a transitive tournament, there are no cycles, so each SCC is a singleton. The condensation is isomorphic to the original graph, and all operations coincide. \square

H.1. SCC Refinement and Projection

Lemma 39 (SCC Refinement). *Let $G = (V, E)$ be a directed graph. Let $G' = (V, E')$ be a subgraph of G where $E' \subseteq E$. Then, we have*

$$u \sim_{G'} v \implies u \sim_G v.$$

Equivalently, each SCC of subgraphs of G is contained in some SCC of G i.e.,

$$G' \subseteq G \implies [u]_{G'} \subseteq [u]_G, \text{ for all } u \in V.$$

Proof. If $u \sim_{G'} v$, then there exist paths $u \rightsquigarrow_{G'} v$ and $v \rightsquigarrow_{G'} u$. Since $E' \subseteq E$, these paths exist in G , so $u \sim_G v$. \square

Definition 40 (Projection Map). Let $G = (V, E)$ be a directed graph. Let $G' = (V, E')$ be a subgraph of G where $E' \subseteq E$. The refinement induces a natural projection $\phi_G : [V]_{G'} \rightarrow [V]_G$ defined by

$$\phi_G([u]_{G'}) = [u]_G.$$

This is well-defined by Lemma 39. We will often omit the subscript G and domain definition when the domain and codomain are clear from the context.

Lemma 41 (Path Preservation Under Projection). *Let $G = (V, E)$ be a directed graph. Let $G' = (V, E')$ be a subgraph of G where $E' \subseteq E$. If $D \rightsquigarrow_{[G']} C$ in $[G']$, then either $\phi_G(D) = \phi_G(C)$ or $\phi_G(D) \rightsquigarrow_{[G]} \phi_G(C)$.*

Proof. Consider a path $D = D_0 \rightarrow D_1 \rightarrow \dots \rightarrow D_\ell = C$ in $[G']$. For each edge $(D_i, D_{i+1}) \in [E']$, there exist $x_i \in D_i$, $y_i \in D_{i+1}$ with $(x_i, y_i) \in E' \subseteq E$.

If $\phi_G(D_i) = \phi_G(D_{i+1})$, the edge collapses to a single vertex.

If $\phi_G(D_i) \neq \phi_G(D_{i+1})$, then $[x_i]_G \neq [y_i]_G$, so $(\phi_G(D_i), \phi_G(D_{i+1})) \in [E]$.

Concatenating the non-collapsed edges yields either $\phi_G(D) = \phi_G(C)$ (if every edge along the path collapses) or a walk from $\phi_G(D)$ to $\phi_G(C)$ in $[G]$. Since $[G]$ is a DAG by Lemma 10, every walk between distinct vertices contains a path, so $\phi_G(D) \rightsquigarrow_{[G]} \phi_G(C)$. \square

H.2. Rank Spectrum Under Condensation

Lemma 42 (Discovered Reachability Respects True Rank). *Let $G = (V, E)$ be a directed graph. Let $G' = (V, E')$ be a subgraph of G where $E' \subseteq E$. Let $C, D \in [V]_{G'}$ be distinct SCCs of G' . Then*

$$C \rightsquigarrow_{[G']} D \implies |R_G^-(u)| \leq |R_G^-(v)|, \quad \text{for all } u \in C \text{ and } v \in D,$$

with equality if and only if $\phi_G(C) = \phi_G(D)$ (i.e. u and v belong to the same SCC of G).

Proof. Let $C, D \in [V]_{G'}$ be distinct SCCs of G' with $C \rightsquigarrow_{[G']} D$. Let $u \in C$ and $v \in D$. Lemma 41 implies that either $\phi_G(C) = \phi_G(D)$ or $\phi_G(C) \rightsquigarrow_{[G]} \phi_G(D)$.

In the first case, $[u]_G = [v]_G$. This means that they are in the same SCC i.e., $u \sim_G v$. Hence, Lemma (7) implies that $|R_G^-(u)| = |R_G^-(v)|$.

In the second case, we have $\phi_G(C) \neq \phi_G(D)$ and $\phi_G(C) \rightsquigarrow_{[G]} \phi_G(D)$. Since $[G]$ is a DAG (Lemma 10), there is no path from $[v]_G$ back to $[u]_G$, so $v \not\rightsquigarrow_G u$ and hence $v \notin R_G^-(u)$. Since $C \rightsquigarrow_{[G']} D$, there exists a path $u \rightsquigarrow_{G'} v$ via Lemma 9 when applied to G' . Since $u \rightsquigarrow_{G'} v$ and $E' \subseteq E$, we have $u \rightsquigarrow_G v$. Then by Lemma 3, we have $R_G^-(u) \subseteq R_G^-(v)$. Finally, $u \in R_G^-(v)$ but $v \notin R_G^-(u)$ as shown and $u \notin R_G^-(u)$ by definition implies $|R_G^-(u)| < |R_G^-(v)|$. The equality if and only if follows from this case. \square

Remark 43. Lemma 42 is the key ‘‘bridge’’ between the discovered subgraphs ($G' = G_t$) in the algorithm and the true tournament ($G = G^*$).

Lemma 44 provides an analogous result to Lemma 20 for the condensation graph.

Lemma 44 (Top Vertices Reach All Non-Top Vertices in Condensation Graphs). *Let $G = (V, E)$ be a directed graph. Let $G' = (V, E')$ be a subgraph of G where $E' \subseteq E$. Then, for any $C \in \text{TOP}([G'])$ and $D \notin \text{TOP}([G'])$, we have*

$$|R_G^-(u)| \leq |R_G^-(v)|, \quad \text{for all } u \in C \text{ and } v \in D. \quad (11)$$

Proof. Since $[G']$ is a DAG, $C \rightsquigarrow_{[G']} D$ follows from 20. Equation (11) follows immediately from Lemma 42. \square

Lemma 45 (Finalized Order is Correct). *Let $G = (V, E)$ be a directed graph. Let $G' = (V, E')$ be a subgraph of G where $E' \subseteq E$. If $1 \leq i < j \leq m([G'])$, then*

$$|R_G^-(u)| \leq |R_G^-(v)|, \quad \text{for all } u \in v^{(i)}([G']) \text{ and } v \in v^{(j)}([G']). \quad (12)$$

Proof. Since $[G']$ is a DAG, $v^{(i)}([G']) \rightsquigarrow_{[G']} v^{(j)}([G'])$ follows from Corollary 18. Then equation (12) follows immediately from Lemma 42. \square

H.3. Termination and Correctness of Algorithm 3

Now we provide a generalization of Lemma 23 to the non-transitive case with a minor adaptation to handle SCCs rather than individual vertices.

Lemma 46 (Equal In-Reach Implies Unknown Edge). *Let $G = (V, E)$ be a directed graph. If $C, D \in [V]$ are distinct SCCs with $|R_{[G]}^-(C)| = |R_{[G]}^-(D)|$, then the edge between C and D is not in $[G]$. Consequently, for any $u \in C, v \in D$, the edge between u and v is not in E .*

Proof. Since $[G]$ is a DAG, Lemma 23 implies that there is no edge between C and D in $[G]$. This in turn implies that there cannot be any edge between any $u \in C$ and $v \in D$, because otherwise there would be an edge between C and D by definition. \square

Theorem 47 (Termination of Algorithm 3). *Suppose that the underlying tournament $G^* = (V, E^*)$ has at least 2 SCCs i.e., $|[V]_{G^*}| \geq 2$. Then Algorithm 3 terminates in at most $\binom{n}{2}$ rounds.*

Proof. We use the notation from Algorithm 3 throughout: $n_t, \widetilde{m}_t, \text{TOP}_t, \widetilde{\text{CAND}}_t$, and $C_t^{(i)}$ refer to the condensation quantities defined there.

If the algorithm has not terminated, $|\text{TOP}_t| < m$. Note that $n_t \geq |[V]_{G^*}| \geq 2$ for all t . We claim $\widetilde{m}_t < n_t$. If $\widetilde{m}_t = n_t$, then $|\text{TOP}_t| = n \geq m$, which is a contradiction. By Lemma 24 on $[G_t]$ and \widetilde{m}_t , we must have $\widetilde{m}_t \neq n_t - 1$. Hence, $\widetilde{m}_t \leq n_t - 2$ and thus $|\widetilde{\text{CAND}}_t| \geq 2$. We now show that there are at least 2 tied SCCs in $\widetilde{\text{CAND}}_t$, specifically $|R_{[G_t]}^-(C_t^{(\widetilde{m}_t+1)})| = |R_{[G_t]}^-(C_t^{(\widetilde{m}_t+2)})|$, which would allow us to make progress with Lemma 46 by querying representatives to discover at least 1 new edge. Indeed, since $[G_t]$ is a DAG with n_t vertices and $\widetilde{m}_t := m([G_t])$ satisfies $\widetilde{m}_t \leq n_t - 2$ as shown, Lemma 22 implies that $r^{(\widetilde{m}_t+1)}([G_t]) = r^{(\widetilde{m}_t+2)}([G_t])$ which means $|R_{[G_t]}^-(C_t^{(\widetilde{m}_t+1)})| = |R_{[G_t]}^-(C_t^{(\widetilde{m}_t+2)})|$. Lemma 46 implies that there is no edge between any node in $C_t^{(\widetilde{m}_t+1)}$ and $C_t^{(\widetilde{m}_t+2)}$. Hence, since Algorithm 3 queries representatives from $C_t^{(\widetilde{m}_t+1)}$ and $C_t^{(\widetilde{m}_t+2)}$, the oracle reveals at least one new edge at round t i.e., $|E_{t+1}| > |E_t|$. Since $|E_t| \leq \binom{n}{2}$, the algorithm terminates in at most $\binom{n}{2}$ rounds. \square

Theorem 48 (Correctness of Algorithm 3). *If Algorithm 3 terminates, then it outputs a valid top- m solution to Problem 1.*

Remark 49 (Why the termination theorem assumes at least two SCCs). The assumption $|[V]_{G^*}| \geq 2$ in Theorem 47 excludes the degenerate case where the underlying tournament G^* consists of a single SCC. In that case every vertex reaches every other vertex, so $|R_{G^*}^-(v)| = n - 1$ for all $v \in V$ by Lemma 12. Hence every subset of m vertices, in any order, is a valid solution to Problem 1. The interesting case is therefore when the condensation has multiple components, so that the SCC decomposition induces a nontrivial tiered ranking.

Proof. We want to show that once Algorithm 3 terminates at some time T , the sequence $(v^{(1)}, \dots, v^{(m)})$ obtained by concatenating $C_T^{(1)}, C_T^{(2)}, \dots, C_T^{(j^*-1)}, S_{j^*}$ where S_{j^*} be any subset of $C_T^{(j^*)}$ with $|S_{j^*}| = m - \sum_{i=1}^{j^*-1} |C_T^{(i)}|$ with $j^* \leftarrow \min\{j \leq \widetilde{m}_T : \sum_{i=1}^j |C_T^{(i)}| \geq m\}$ satisfies a solution of Problem 1. We verify the two conditions of Problem 1 separately. Internal ordering follows from the SCC structure of finalized components. Rank dominance requires splitting into vertices inside vs. outside the boundary SCC $C_T^{(j^*)}$.

Let us first show internal ordering $|R_{G^*}^-(v^{(i)})| \leq |R_{G^*}^-(v^{(j)})|$ for all $1 \leq i \leq j \leq m$ as in (3). Let $v^{(i)} \in C_T^{(i')}$ and $v^{(j)} \in C_T^{(j')}$ for some $i', j' \in [j^*]$. Note that $i' \leq j' \leq j^* \leq \widetilde{m}_T$ by the concatenation construction and definition of j^* .

If $i' = j'$ then $v^{(i)} \sim_{G_T} v^{(j)}$ and thus $v^{(i)} \sim_{G^*} v^{(j)}$ by Lemma 39, which implies $|R_{G^*}^-(v^{(i)})| = |R_{G^*}^-(v^{(j)})|$ by Lemma 7.

Otherwise if $i' < j'$, then since G_T is a subgraph of G^* and $i' < j' \leq m([G_T])$, Lemma 45 implies that $|R_{G^*}^-(u)| \leq |R_{G^*}^-(v)|$ for all $u \in C_T^{(i')}$ and $v \in C_T^{(j')}$. This means that $|R_{G^*}^-(v^{(i)})| \leq |R_{G^*}^-(v^{(j)})|$. In either case, we have $|R_{G^*}^-(v^{(i)})| \leq |R_{G^*}^-(v^{(j)})|$.

We will now show that the solution set $S := \{v^{(1)}, \dots, v^{(m)}\}$ contains all the top ranks i.e., $\max\{|R_{G^*}^-(v^{(i)})| \mid i = 1, 2, \dots, m\} \leq \min_{v \notin S} R_{G^*}^-(v)$ as in (4). We want to show that $R_{G^*}^-(u) \leq R_{G^*}^-(v)$ for all $u \in S$ and $v \notin S$. Note that u is in one of $C_T^{(1)}, C_T^{(2)}, \dots, C_T^{(j^*-1)}, S_{j^*}$. We will split the proof into 2 cases: (1) v is in $C_T^{(j^*)} \setminus S_{j^*}$, or (2) v is in $C_T^{(j)}$ for some $j > j^*$.

Case 1: Suppose $v \in C_T^{(j^*)} \setminus S_{j^*}$.

If $u \in S_{j^*} \subseteq C_T^{(j^*)}$, then u and v are in the same SCC i.e., $u \sim_{G_T} v$. Lemma 39 then implies that $u \sim_{G^*} v$ since G_T is a subgraph of G^* . Thus, Lemma 7 implies that $|R_{G^*}^-(u)| = |R_{G^*}^-(v)|$.

Otherwise if $u \notin S_{j^*}$, then $u \in C_T^{(i)}$ for some $i < j^*$. Then Lemma 45 implies that $|R_{G^*}^-(u)| \leq |R_{G^*}^-(v)|$ since $v \in C_T^{(j^*)}$. Either cases, we have $|R_{G^*}^-(u)| \leq |R_{G^*}^-(v)|$ as desired.

Case 2: Suppose $v \in C_T^{(j)}$ for some $j > j^*$. Note that $u \in C_T^{(i)}$ for some $i \leq j^* \leq \widetilde{m}_T$. Since $j^* < j$, we have $i < j$.

If $j \leq \widetilde{m}_T = m([G_T])$, then since $i < j \leq m([G_T])$ and G_T is a subgraph of G^* , Lemma 45 implies that $|R_{G^*}^-(u)| \leq |R_{G^*}^-(v)|$.

For the other subcase, if $j > m([G_T])$, we have $C_T^{(j)} \notin \text{TOP}([G_T])$. Since $C_T^{(i)} \in \text{TOP}([G_T])$ and G_T is a subgraph of G^* , Lemma 44 implies that $|R_{G^*}^-(u)| \leq |R_{G^*}^-(v)|$. Either cases, we have $|R_{G^*}^-(u)| \leq |R_{G^*}^-(v)|$ as desired.

Combining case 1 and 2, we have $|R_{G^*}^-(u)| \leq |R_{G^*}^-(v)|$ for all $u \in S$ and $v \notin S$. Thus (4) is satisfied.

Thus, since the sequence $(v^{(1)}, \dots, v^{(m)})$ output by Algorithm 3 satisfies both (3) and (4) of Problem 1, the algorithm is correct. \square

I. Resolution-Based Finalization and BLITZRANK

Algorithms 2 and 3 terminate when the finalization threshold of the condensation reaches m , requiring the rank spectrum to crystallize into the pattern $0, 1, 2, \dots$ up to position m . While this criterion is theoretically clean, it is more elaborate than what is needed for a practical implementation. In this section, we develop the vertex-level criterion used by Algorithm 1, based on the *known-relationship count*

$$\kappa_G(v) := |K_G(v)|, \quad K_G(v) := R_G^-(v) \cup R_G^+(v).$$

A vertex is *resolved* when $\kappa_G(v) = n - 1$, meaning that its relationship to every other vertex is already determined by the revealed graph.

The key point is that resolution is sufficient for the practical stopping rule: BLITZRANK terminates once the current top- m vertices by discovered in-reach are all resolved. This criterion is simpler to check than crystallization of the full rank spectrum, while still yielding a correct output. We first relate resolution to the earlier finalization framework, then prove output correctness from a basic ordering property of resolved vertices, and finally use the condensation only in the progress and termination argument.

I.1. Properties of Known Relationship

Proposition 50 (Known Relationships As a Necessary Condition for Finalization). *Let $G = (V, E)$ be a DAG with $m(G) \geq 1$. Then we have*

$$v \in \text{TOP}(G) \implies |R_G^-(v) \cup R_G^+(v)| = n - 1.$$

Proof. We write $v^{(j)} := v^{(j)}(G)$ for brevity. Let $v = v^{(j)}$ for some $j \leq m(G)$ i.e., $v \in \text{TOP}(G)$. We show that every

vertex in $V \setminus \{v\}$ belongs to either $R_G^-(v)$ or $R_G^+(v)$. First, by Lemma 17, we know exactly the in-reaches of v :

$$R_G^-(v) = \begin{cases} \emptyset, & \text{if } j = 1, \\ \{v^{(1)}, \dots, v^{(j-1)}\}, & \text{if } j > 1. \end{cases}$$

Now, for any $v^{(i)} \in \text{TOP}(G)$ with $i > j$, Corollary 18 gives $v^{(j)} \rightsquigarrow_G v^{(i)}$, so:

$$\{v^{(j+1)}, \dots, v^{(m(G))}\} \subseteq R_G^+(v).$$

Finally, by Lemma 20, for any $u \in \text{CAND}(G) = V \setminus \text{TOP}(G)$, we have $v \rightsquigarrow_G u$, so:

$$\text{CAND}(G) \subseteq R_G^+(v).$$

The sets $R_G^-(v)$ and $R_G^+(v)$ are disjoint (since G is a DAG and any vertex in their intersection would create a cycle through v). Combining the results above:

$$\begin{aligned} R_G^-(v) &= \{v^{(1)}, \dots, v^{(j-1)}\}, \\ R_G^+(v) &\supseteq \{v^{(j+1)}, \dots, v^{(m(G))}\} \cup \text{CAND}(G). \end{aligned}$$

These sets partition $V \setminus \{v\}$:

$$V \setminus \{v\} = \{v^{(1)}, \dots, v^{(j-1)}\} \cup \{v^{(j+1)}, \dots, v^{(m(G))}\} \cup \text{CAND}(G).$$

Therefore:

$$R_G^-(v) \cup R_G^+(v) \supseteq V \setminus \{v\}.$$

Trivially, we have $R_G^-(v) \cup R_G^+(v) \subseteq V \setminus \{v\}$. We conclude:

$$|R_G^-(v) \cup R_G^+(v)| = n - 1. \quad \square$$

Remark 51. The converse of Proposition 50 does not hold; see the remark following Proposition 52 for a counterexample and the additional condition that yields a full characterization.

We can obtain a characterization of the known relationships by strengthening the assumption a bit. This helps with understanding the finalization criterion and will be useful for implementing a practical version of the algorithm.

Proposition 52 (Characterization of Finalized Vertices). *Let $G = (V, E)$ be a DAG with $m(G) \geq 1$. Then*

$$v \in \text{TOP}(G) \iff \kappa_G(v) = n - 1 \text{ and } |R_G^-(v)| < m(G).$$

Proof. (\Rightarrow) Let $v = v^{(j)}(G)$ for some $j \leq m(G)$. By Proposition 50, $\kappa_G(v) = n - 1$. By the finalization threshold (Definition 16), $|R_G^-(v)| = r^{(j)}(G) = j - 1 < m(G)$.

(\Leftarrow) Suppose $|R_G^-(v)| < m(G)$. By the contrapositive of Lemma 19, $v \notin \text{CAND}(G)$, so $v \in \text{TOP}(G)$. \square

Remark 53. The in-reach condition $|R_G^-(v)| < m(G)$ alone suffices for the backward direction; the known-relationship condition $\kappa_G(v) = n - 1$ is redundant for that implication. We retain it in the biconditional because it is the computationally natural quantity to track: the algorithm accumulates known relationships incrementally, and the in-reach condition provides a cheap secondary check once resolution is established.

Note also that the converse of Proposition 50 fails in general: $\kappa_G(v) = n - 1$ does not imply $v \in \text{TOP}(G)$. Consider $V = \{a, b, c\}$ with $E = \{(a, c), (b, c)\}$. Here $m(G) = 1$ with $\text{TOP}(G) = \{a\}$, yet $\kappa_G(c) = 2 = n - 1$. Proposition 52 correctly excludes c because $|R_G^-(c)| = 2 \geq m(G) = 1$, violating the in-reach condition.

I.2. Correctness of Algorithm 1

We now establish correctness and termination of Algorithm 1. The key observation is that the output validity depends on a single elementary property of *resolved* vertices, while the condensation machinery is needed only for proving termination.

I.2.1. OUTPUT CORRECTNESS

Recall that the algorithm computes, for each vertex $u \in V$ in the revealed graph $G = (V, E)$ with $E \subseteq E^*$, the loss count $|R_G^-(u)|$ and the known relationship $\kappa_G(u)$. The algorithm terminates when the set T of m vertices with smallest discovered in-reach is contained in $F := \{u \in V : \kappa_G(u) = n - 1\}$.

Lemma 54 (Resolved Vertex Ordering). *Let $G^* = (V, E^*)$ be a tournament and $G = (V, E)$ a subgraph with $E \subseteq E^*$. Let $u, v \in V$ be distinct. If u is resolved (i.e., $\kappa_G(u) = n - 1$) and $v \notin R_G^-(u)$, then*

$$|R_{G^*}^-(u)| \leq |R_{G^*}^-(v)|.$$

Proof. Since $R_G^-(u) \cup R_G^+(u) = V \setminus \{u\}$ and $v \notin R_G^-(u)$, we have $v \in R_G^+(u)$, so $u \rightsquigarrow_G v$ and hence $u \rightsquigarrow_{G^*} v$ (as $E \subseteq E^*$). In G^* , exactly one of the following holds:

1. $v \rightsquigarrow_{G^*} u$ as well. Then $u \sim_{G^*} v$, so u and v belong to the same SCC of G^* , giving $|R_{G^*}^-(u)| = |R_{G^*}^-(v)|$ by Lemma 7.
2. $v \not\rightsquigarrow_{G^*} u$. Then $[u]_{G^*}$ and $[v]_{G^*}$ are distinct SCCs with $[u]_{G^*} \rightsquigarrow_{[G^*]} [v]_{G^*}$. Since the condensation of a tournament is a transitive tournament (Proposition 11), $[u]_{G^*}$ strictly precedes $[v]_{G^*}$ in condensation order. Lemma 12 then gives $|R_{G^*}^-(u)| < |R_{G^*}^-(v)|$.

In both cases, $|R_{G^*}^-(u)| \leq |R_{G^*}^-(v)|$. □

The following observation connects the algorithm's vertex-level quantities to the hypothesis of Lemma 54.

Lemma 55 (Smaller Discovered Loss Excludes In-Reach Membership). *Let $G = (V, E)$ be a directed graph. Let $u, v \in V$ be distinct. If u is resolved (i.e., $\kappa_G(u) = n - 1$) and $|R_G^-(u)| \leq |R_G^-(v)|$, then $v \notin R_G^-(u)$.*

Proof. Suppose for contradiction that $v \in R_G^-(u)$. Lemma 3 gives $R_G^-(v) \cup \{v\} \subseteq R_G^-(u)$, so $|R_G^-(v)| + 1 \leq |R_G^-(u)|$, i.e., $|R_G^-(v)| < |R_G^-(u)|$, contradicting $|R_G^-(u)| \leq |R_G^-(v)|$. □

Combining these 2 lemmas provide an important bridge from the resolved vertices' in-reaches of the discovered graph to the in-reaches of the underlying tournament.

Corollary 56 (Resolved In-Reaches are True In-Reaches). *Let $G^* = (V, E^*)$ be a tournament and $G = (V, E)$ a subgraph with $E \subseteq E^*$. Let $u, v \in V$ be distinct. We have,*

$$\kappa_G(u) = n - 1 \text{ and } |R_G^-(u)| \leq |R_G^-(v)| \implies |R_{G^*}^-(u)| \leq |R_{G^*}^-(v)|.$$

Proof. The proof immediately follows from combining Lemma 54 and Lemma 55. □

Theorem 57 (Output Correctness of Algorithm 1). *If Algorithm 1 terminates, its output is a valid solution to Problem 1.*

Proof. At termination with discovered graph $G \subseteq G^*$, $T \subseteq F$, meaning every $u \in T$ satisfies $\kappa_G(u) = n - 1$, and T consists of the m vertices with smallest in-reach.

Internal ordering (3). Let $v^{(1)}, \dots, v^{(m)}$ be the vertices of T sorted by ascending in-reach. For any $1 \leq i < j \leq m$, we have $|R_G^-(v^{(i)})| \leq |R_G^-(v^{(j)})|$ with $\kappa_G(v^{(i)}) = n - 1$. Then Corollary 56 implies that $|R_{G^*}^-(v^{(i)})| \leq |R_{G^*}^-(v^{(j)})|$.

Rank dominance (4). Let $u \in T$ and $v \notin T$. Since T contains the m vertices with smallest in-reaches, we have $|R_G^-(u)| \leq |R_G^-(v)|$. Since $\kappa_G(u) = n - 1$, Corollary 56 implies that $|R_{G^*}^-(u)| \leq |R_{G^*}^-(v)|$. Taking the maximum over $u \in T$ and minimum over $v \notin T$:

$$\max_{u \in T} |R_{G^*}^-(u)| \leq \min_{v \notin T} |R_{G^*}^-(v)|. \quad \square$$

Remark 58. Lemma 54 is one-sided: only u needs to be fully resolved ($\kappa_G(u) = n - 1$); no assumption is made on v . This is why the proof requires only $T \subseteq F$ and places no constraint on vertices outside T .

I.2.2. TERMINATION

Output correctness requires no condensation machinery. Termination, however, uses the condensation to guarantee that every non-terminal round discovers at least one new edge.

Lemma 59 (Tied SCCs Contain Unresolved Vertices). *Let $G = (V, E)$ be a directed graph. If $C, D \in [V]$ are distinct SCCs with $|R_{[G]}^-(C)| = |R_{[G]}^-(D)|$, then for any $u \in C$ and $v \in D$, we have $\kappa_G(u) < n - 1$ and $\kappa_G(v) < n - 1$.*

Proof. By Lemma 46, there is no edge between any vertex in C and any vertex in D in E . In particular, for any $u \in C$ and $v \in D$: $v \notin R_G^-(u) \cup R_G^+(u)$, so $\kappa_G(u) \leq n - 2 < n - 1$. The same argument gives $\kappa_G(v) < n - 1$. \square

Theorem 60 (Termination of Algorithm 1). *Algorithm 1 terminates in at most $\binom{n}{2}$ rounds.*

Proof. At any non-terminal round, $T \not\subseteq F$: some vertex $u \in T$ has $\kappa_G(u) < n - 1$. We show the scheduled query Q discovers at least one new edge.

Let $\tilde{m} := m([G])$ denote the finalization threshold of $[G]$, and let $n' := |[V]|$. We first establish $\tilde{m} \leq n' - 2$. If $\tilde{m} = n'$, then every SCC is finalized, and Proposition 50 applied to the DAG $[G]$ gives $\kappa_{[G]}(C) = n' - 1$ for every $C \in \text{TOP}([G]) = [V]$. This implies $\kappa_G(u) = n - 1$ for all $u \in V$ by Lemma 14, contradicting the existence of an unresolved vertex. Hence $\tilde{m} < n'$. Lemma 24 then gives $\tilde{m} \neq n' - 1$, so $\tilde{m} \leq n' - 2$.

By Lemma 22 applied to the DAG $[G]$, the SCCs at positions $\tilde{m} + 1$ and $\tilde{m} + 2$ in the condensation rank spectrum are tied:

$$|R_{[G]}^-(C^{(\tilde{m}+1)})| = |R_{[G]}^-(C^{(\tilde{m}+2)})|.$$

By Lemma 59, both SCCs contain vertices with $\kappa_G(\cdot) < n - 1$, so both appear in the candidate set \mathcal{C} of the algorithm. Since they share the same in-reach value in $[G]$, they are among the earliest elements of \mathcal{C} (sorted by ascending in-reach). The algorithm selects representatives from each, and by Lemma 46, no edge exists between these representatives in E . The oracle query therefore reveals at least one new edge: $|E_{t+1}| > |E_t|$.

Since $|E_t| \leq \binom{n}{2}$ for all t , the algorithm terminates in at most $\binom{n}{2}$ rounds. \square

Remark 61 (Comparison with Algorithms 2 and 3). The theoretical algorithms terminate when the finalization threshold of the condensation reaches m , requiring the rank spectrum to crystallize into the pattern $0, 1, 2, \dots$ up to position m . Algorithm 1 terminates when the m lowest-loss vertices are individually resolved ($\kappa_G(\cdot) = n - 1$), a vertex-level condition that can be satisfied strictly earlier than full crystallization. The condensation enters Algorithm 1 only in the scheduling step (for ordering candidate SCCs) and in the termination proof (for guaranteeing progress). The output correctness proof is independent of the condensation and relies solely on Lemma 54.

J. Query Complexity Discussion

J.1. Setup and Notation

We measure *query complexity* as the number of calls made to the k -wise oracle. Formally, an algorithm \mathcal{A} adaptively selects query sets Q_1, Q_2, \dots with $Q_t \subseteq V$ and $|Q_t| \leq k$, observes $\mathcal{O}(Q_t)$, and terminates once it can certify the desired output (top- m selection).

Instance-wise and worst-case complexity. For a fixed underlying tournament G^* , let $T_{\mathcal{A}}(G^*)$ denote the (random) number of oracle calls made by \mathcal{A} until termination.⁴ We define the worst-case query complexity over a class \mathcal{G} as

$$Q_{\mathcal{A}}(\mathcal{G}; n, k, m) := \sup_{G^* \in \mathcal{G}} T_{\mathcal{A}}(G^*).$$

In particular, we will distinguish the transitive class $\mathcal{T}_n^{\text{tr}}$ (total orders) from the general class \mathcal{T}_n (all tournaments).

Sequential vs. parallel depth. The complexity above counts total oracle calls. If multiple disjoint query sets are evaluated in parallel, a second measure is the number of *rounds* (parallel depth). We defer a formal treatment of parallel depth to future work.

⁴In this paper the oracle is deterministic; randomness, if any, comes from tie-breaking or implementation choices.

J.2. Transitive Case

The $\binom{n}{2}$ bound from Theorem 36 is a worst-case upper bound that does not exploit the structure of greedy selection. We now derive tighter bounds.

Proposition 62 (Top-1 Query Complexity). *When $m = 1$, Algorithm 2 identifies the top vertex in at most $\left\lceil \frac{n-1}{k-1} \right\rceil$ queries.*

Proof. In the transitive setting, the restriction of G^* to any queried set Q is a total order, hence it has a unique best element (the one with zero losses within Q). By transitivity, any other element of Q loses to this best element and therefore cannot be the global best. Thus each query can eliminate at least $|Q| - 1 \geq k - 1$ candidates from being the top vertex. Starting from n candidates, after q queries at most $n - q(k - 1)$ candidates remain; requiring $n - q(k - 1) \leq 1$ yields the bound. \square

J.3. A Conjecture for Top- m Query Complexity

Beyond $m = 1$, a tight query complexity analysis remains open. The proved termination bound is $O(n^2)$ (Theorem 60), obtained by showing that each non-terminal round reveals at least one new edge. This existential progress argument does not exploit the greedy structure of the scheduler, which empirically produces query counts far below $O(n^2)$. For $m = 1$, Proposition 62 gives a tight $O(n/k)$ bound via a clean elimination argument: each query eliminates $k - 1$ candidates. For $m > 1$, the algorithm must simultaneously refine multiple rank positions, and the interaction between candidate elimination and frontier advancement resists a simple recurrence. We state a conjectural bound motivated by the structure of the algorithm and validated empirically in Section J.6.

Conjecture 63 (Top- m Query Complexity). Let BLITZRANK^\dagger denote Algorithm 1 with candidate SCCs ordered lexicographically by ascending condensation in-reach, then ascending condensation out-reach, then fixed ID; and with each $\text{rep}(C)$ chosen by minimum κ_G , then fixed ID. Then

$$Q_{\text{BLITZRANK}^\dagger}(\mathcal{T}_n; n, k, m) = O\left(\frac{n-1}{k-1} + \frac{m-1}{k-1} \log_k m\right).$$

Remark 64 (Decomposition). The conjectured form decomposes into two terms:

- A *candidate reduction* term $(n-1)/(k-1)$: the cost to winnow n candidates down to a single maximum, matching Proposition 62.
- A *frontier refinement* term $(m-1)/(k-1) \cdot \log_k m$: the additional cost to extract elements $2, \dots, m$ from the remaining candidates, reflecting the logarithmic depth of repeated selection.

The $O(\cdot)$ notation hides a constant factor. Empirically (Section J.6), we observe that this constant is at most 1.25 across all tested configurations, suggesting the functional form is tight up to lower-order terms. The specific tie-breaking rules in BLITZRANK^\dagger pin down a single deterministic algorithm, avoiding ambiguity from arbitrary implementation choices.

Remark 65 (Lower bounds). Standard arguments show the conjectured form is tight up to constants. Elimination gives $\Omega((n-1)/(k-1))$ for finding the maximum (Proposition 62); a decision-tree bound gives $\Omega(\log(m!)/\log(k!)) = \Omega(m \log m / (k \log k))$ for ordering m items with $k!$ -outcome queries. When $m = n$ the latter recovers the classical $\Omega(n \log n / (k \log k))$ sorting lower bound. Since $\max(a, b) = \Theta(a + b)$ for non-negative a, b , the maximum of the two bounds already matches the conjectured $(n-1)/(k-1) + (m-1)/(k-1) \cdot \log_k m$ up to constant factors; the open challenge is the upper bound.

Remark 66 (Difficulty of a formal proof). The gap between the proved $O(n^2)$ termination bound and Conjecture 63 reflects a fundamental limitation of the existing analysis, which is built around *correctness and eventual progress* rather than a sharp accounting of how quickly the greedy scheduler resolves the top- m frontier. In Algorithm 1, the condensation is used only to order candidate SCCs and to guarantee that every non-terminal iteration reveals at least one new edge (Theorem 60) – far weaker than the conjectured scaling. Proving the stronger bound would require a new structural invariant showing that repeated k -wise queries not only make progress, but concentrate information efficiently on the unresolved top- m boundary.

Two structural mismatches compound the difficulty. First, the algorithm schedules queries at the SCC level of the condensation, while termination is a vertex-level condition ($\kappa_G(v) = n - 1$); bridging these levels requires tracking how SCC-level queries translate into vertex-level resolution. Second, transitive-closure effects make the dynamics nonlocal: a single new edge can trigger cascading updates to in-reach sets and SCC structure, resolving vertices far from the query set. The 25-horses example (Figure 2) illustrates a third difficulty: the per-query information gain is inherently non-uniform. The execution exhibits three distinct phases: (i) a *skeleton-building* phase (Rounds 1–5) where disjoint groups are sorted

independently and each query reveals exactly $k - 1$ new edges; (ii) a *connection* phase (Round 6) where group winners are compared, transitive closure propagates across previously isolated components, and vertices resolve en masse; (iii) a *saturation* phase (Round 7) where the remaining top candidates require targeted comparisons with diminishing transitive-closure leverage. Any tight analysis must likely account for these phase transitions, as no single amortization rate can capture the varying progress. Establishing the conjecture would likely require a phase-aware potential function that tracks the rate at which the top- m frontier crystallizes – a substantial extension of the present framework.

J.4. Why the Bound Should Extend to All Tournaments

Conjecture 63 states the bound over the full class \mathcal{T}_n . The following remark provides structural intuition for why non-transitive tournaments should not be harder than transitive ones.

Remark 67 (Why Cycles Help). The intuition is that cycles can only make top- m selection *easier*. When vertices form a cycle in G^* , they belong to the same SCC and thus share a common rank in the condensation DAG. Once the algorithm discovers such a cycle, all vertices in the SCC finalize simultaneously – they need not be distinguished from one another. In contrast, the transitive case requires establishing pairwise orderings among all vertices: no shortcuts exist.

More precisely, for any tournament G^* , one can construct a “shadow” transitive tournament \tilde{G} that respects the SCC tier structure of G^* : vertices in better-ranked tiers beat vertices in worse-ranked tiers, with intra-tier orderings assigned arbitrarily. Inter-tier edges in \tilde{G} are determined by the same tier structure as in G^* , so any query sequence reveals the same inter-tier relationships in both. The difference lies within tiers: in \tilde{G} , all vertices are singletons requiring full resolution; in G^* , cycles merge vertices into SCCs that finalize together. Thus the query count on G^* should never exceed that on \tilde{G} . A formal proof of this reduction remains open.

J.5. Empirical Methodology

We empirically validate Conjecture 63 by measuring the query complexity of BLITZRANK[†] on synthetic transitive instances – the conjectured worst case (Remark 67).

Instance generation. A transitive tournament on n vertices corresponds to a total order, uniquely determined by a permutation $\pi : [n] \rightarrow [n]$. We generate instances by sampling π uniformly at random; the underlying tournament G_π^* has edge $u \rightarrow v$ iff $\pi^{-1}(u) < \pi^{-1}(v)$. The oracle \mathcal{O} applied to any query set $Q \subseteq V$ returns the restriction of G_π^* to Q – equivalently, the total order on Q induced by π .

Measurement protocol. For each parameter triple (n, k, m) , we execute BLITZRANK[†] with target count m and record $T_A(G_\pi^*)$, the number of oracle calls until termination. Rather than running separate experiments for each $m \in \{1, \dots, n\}$, we exploit a key observation: a single execution with $m = n$ (full sort) reveals $Q(n, k, m')$ for all $m' \leq n$ as a byproduct. Specifically, when the m' -th vertex is finalized at round t , we record $T_{m'} := t$ as the query count for top- m' selection. This yields the full curve $m \mapsto Q(n, k, m)$ from one run.

Experimental grid. We test $n \in \{100, 200, 400, 800\}$ and $k \in \{5, 10, 20, 50\}$, extracting $m = 1, \dots, n$ from each full-sort run, with 20 independent random seeds per (n, k) pair. For each (n, k, m) , we report the median, 10th–90th percentile range, and maximum of T_m across seeds.

J.6. Empirical Results

Figure 10 presents the empirical query counts alongside the concrete reference curve

$$B(n, k, m) = \left\lceil \frac{n-1}{k-1} \right\rceil + \frac{m-1}{k-1} \cdot (1 + \log_k(m)), \quad (13)$$

a non-asymptotic instantiation of the $O(\cdot)$ form in Conjecture 63 (the additive 1 inside the parenthesis is absorbed by the big- O).

Main observations.

1. *The conjectured form captures the scaling.* Across all tested (n, k) pairs, the empirical curves follow the shape predicted by $B(n, k, m)$: sublinear in k , with a candidate-reduction plateau for small m transitioning to logarithmic growth.

2. *The constant is small.* The maximum observed query count satisfies $\max_{\pi} T_{\mathcal{A}}(G_{\pi}^*) \leq 1.25 \cdot B(n, k, m)$ for all tested configurations. The median typically lies below $B(n, k, m)$ itself.
3. *Variance is low.* The 10th–90th percentile bands are narrow, indicating that query complexity is stable across random permutations and not dominated by rare worst-case instances within our sample.

Limitations. These experiments provide evidence for, but do not prove, Conjecture 63. Key caveats:

- We test only random transitive instances; adversarially constructed permutations could yield higher query counts. Transitive tournaments are the conjectured worst case (Remark 67), but this reduction itself remains unproved.
- The parameter range is bounded ($n \leq 800, k \leq 50$); extrapolation to larger scales is uncertain.
- The 1.25 multiplicative gap may reflect lower-order terms not captured by the asymptotic form, or slack in our analysis.

See Remark 66 for a discussion of the obstacles to a formal proof.

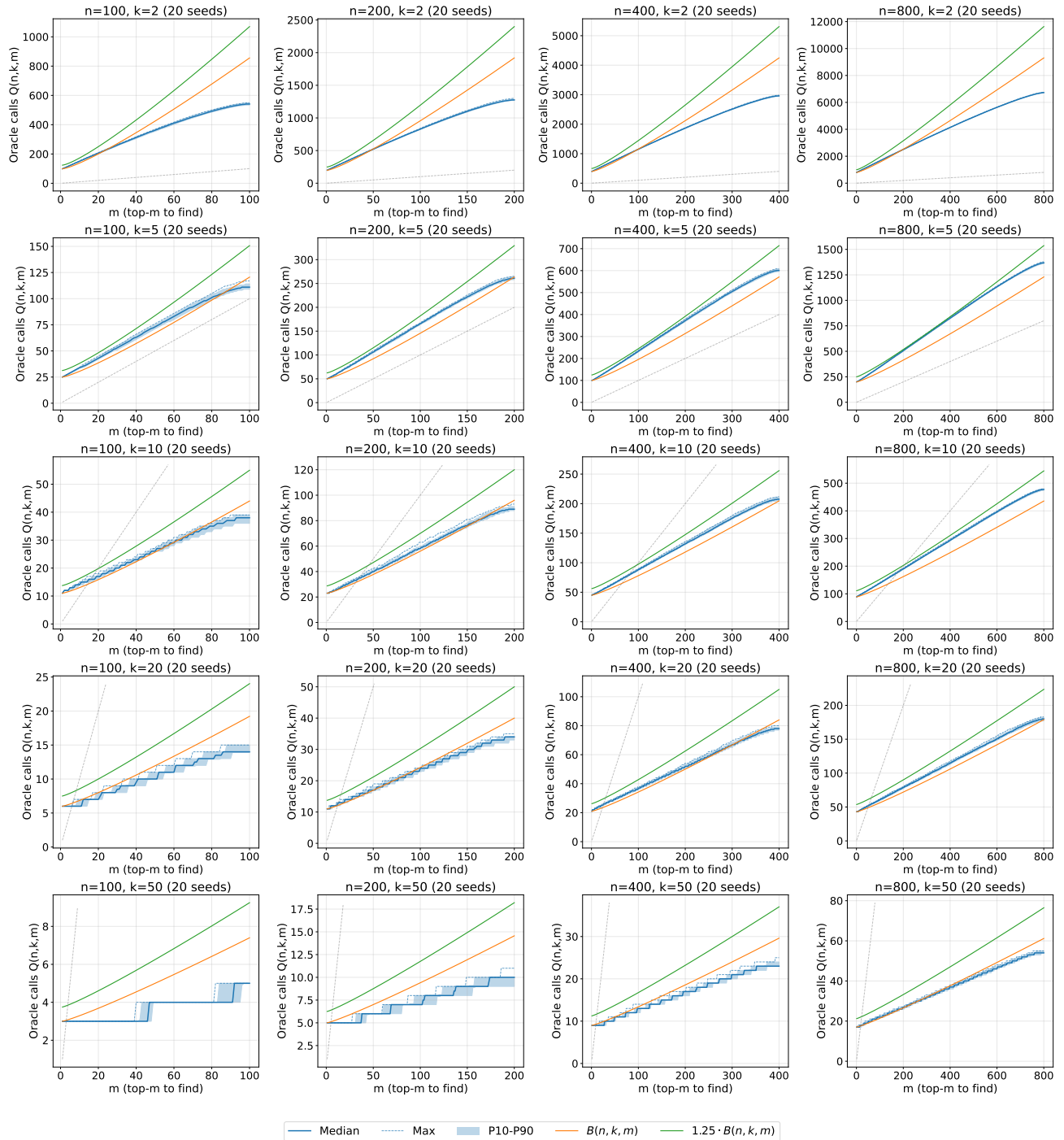

Figure 10. Empirical query counts $Q(n, k, m)$ versus target count m for various (n, k) configurations. Each panel shows the median (solid blue), maximum (dashed blue), and 10th–90th percentile band (shaded) across 20 random permutations. The conjectured bound $B(n, k, m)$ (orange) closely tracks the empirical complexity; $1.25 \cdot B(n, k, m)$ (green) upper-bounds all observed counts.