

Design, construction, and testing of the PandaX-xT cryogenics system

Xu Wang,^a Li Zhao,^{a,b,*} Xiang Xiao,^{d,*} Xiangyi,Cui^{a,b} Shuaijie Li,^{a,e} Jianglai Liu,^{a,b,c}

^a*Tsung-Dao Lee institute, New Cornerstone Science Laboratory, Shanghai Jiao Tong University, Shanghai, 200240, China*

^b*Shanghai Jiao Tong University Sichuan Research Institute, Chengdu 610213, China*

^c*INPAC, School of Physics and Astronomy, Shanghai Jiao Tong University, Key Laboratory for Particle Astrophysics and Cosmology, Ministry of Education (MoE), Shanghai Key Laboratory for Particle Physics and Cosmology, Shanghai 200240, China*

^d*School of Physics, Sun Yat-Sen University, Guangzhou 510275, China*

^e*Yalong River Hydropower Development Company, Ltd., Chengdu, 610051, China*

E-mail: zhaoli78@sjtu.edu.cn, xiaox93@mail.sysu.edu.cn

ABSTRACT: The PandaX-xT is a next-generation experiment with broad scientific goals, including the search for dark matter, Neutrinoless Double Beta Decay, and astrophysical neutrinos, using a dual-phase time projection chamber with about 43 tons of liquid xenon. A new cryogenics system of the PandaX-xT is described in this paper. It is developed to handle large mass of liquid xenon efficiently and safely, including two cooling towers for normal operation and one liquid-nitrogen coil for emergency case. Each cooling tower equipped with an AL600 Gifford-McMahon cryocooler features a 1300 W heater, specifically designed to maintain the cold finger's temperature at the desired setpoint. The performance of the cooling tower and the coil has been tested. The cryogenics system with two cooling towers has achieved about 1900 W cooling power at 178 K. The liquid nitrogen coil provides emergency cooling power of more than 1500 W at liquid xenon temperature. For the prototype of a 1-tonne liquid xenon detector, the fluctuation of xenon saturated vapor pressure remains below 1 kPa over one month, while the pressure is around 210 kPa.

KEYWORDS: Dark matter; Liquid xenon; Gifford-McMahon cryocooler; Liquid-nitrogen.

Contents

1	Introduction	1
2	Design and construction of the cryogenics system prototype	2
2.1	Overview of the cryogenics system prototype	2
2.2	The cooling tower with coldhead	4
2.3	The emergency LN_2 cooler	6
2.4	Test tower and 1-tonne liquid xenon vessel	7
3	Experimental results and discussion	7
3.1	Cooling power of the coldhead AL600	8
3.2	Performance of the cooling tower	9
3.3	Performance of the emergency LN_2 cooler	10
4	Conclusion	11

1 Introduction

The PandaX experiment, situated at the China Jinping Underground Laboratory (CJPL) [1], employs a dual-phase xenon time projection chamber to search for dark matter particles [2–7], specifically weakly interacting massive particles [8, 9], and to investigate neutrinoless double beta decay [10–12]. The use of a larger liquid xenon (LXe) target significantly improves the experimental sensitivity by further suppressing backgrounds. Currently, the PandaX-4T experiment is running with 6 tons of xenon, and the result from the commissioning run and the first science run has been published [13]. Meanwhile, the XENONnT experiment, utilizing 8 tons of xenon, has also reported new results, and the LZ experiment, with 10 tons of xenon, has delivered the most precise results to date in this field [14–17]. The final phase of the PandaX-xT project will feature a detector utilizing 43 tons of xenon [18]. This development will be carried out in two stages: the first, a 20-tonne detector, followed by the 43-tonne one. However, the implementation of this advanced detector will require a new powerful cryogenics system.

In the past few years, several different types of cryogenics systems have been used to support the operation of large LXe detectors. XENONnT has 2 pulse tube refrigerators (PTRs), the cooling power of each PTR is ~ 250 W at 177 K [19]. Unlike PTRs of XENONnT, the thermosyphon based cryogenics system with liquid-nitrogen (LN_2) for LZ experiment, has demonstrated more than 1000 W cooling power at 178 K [20]. The xenon pressure fluctuations during experimental live time are 2 kPa for XENONnT and 0.0558 kPa for LZ [15, 17]. PandaX-4T can run with three cooperating coldheads, the total cooling power is ~ 580 W at 178 K and the xenon pressure fluctuations is 0.25 kPa [21]. Because of

the successful operation of PandaX-4T cryogenics system [21], the basic design of PandaX-xT cryogenics system is inherited, with improvement on cooling power, heater of coldhead and control system.

In this paper, we present the results of research and development (R&D) on a new high-performance cryogenics system designed for the future PandaX detector. The system integrates two powerful AL600 [22] Gifford-McMahon (GM) cryocoolers for long term operation and a specially engineered LN_2 coil for emergency scenarios. A prototype of the system, featuring a test tower and a 1-tonne liquid xenon detector vessel, demonstrates stable and powerful cooling capabilities.

2 Design and construction of the cryogenics system prototype

2.1 Overview of the cryogenics system prototype

Based on operational experience from the PandaX-4T [21] experiments, the total heat load on the cryogenics system for the PandaX-xT experiment has been preliminarily estimated at approximately 1518 W, including a 10% contingency. This overall heat load breakdown is presented in Table 1. A specially designed cryogenics system prototype, represented schematically in Figure 1 and shown in Figure 2, mainly includes two cooling towers with AL600 coldhead (Cryomech, USA) with cooling power of 600 W at 80 K and 1000 W at 178 K [22], an emergency LN_2 cooler, a test tower, and a 1-tonne liquid xenon detector vessel. The cooling tower is designed to enable reliable and sustained liquefaction of xenon gas over long operational periods. Detailed parameters of the cooling tower are described in section 2.2. In the event of unexpected power failure or an emergency, LN_2 is used to maintain the pressure of liquid xenon detector within a safe operational range. The emergency LN_2 cooler is detailed in section 2.3. The test tower, which is equipped with a 2.2 kW heater, is used for simulating high heat load with about 15 kg of liquid xenon. The 1-tonne liquid xenon detector vessel is designed for studying the performance of the liquid xenon detector. Both are described in detail in section 2.4.

Table 1. Heat load rollup for PandaX-xT experiment, total 1518 W

Component	Parameter	Heat(W)	Note
Inner vessel	ID 2.5 m, H 3.0 m	~ 600	10-layer MLI, 1.0E-3 Pa
Heat exchanger	500 slpm	~ 500	Assumed at 90% efficiency
Gas flow	5 slpm	~ 50	Estimated gas circulation
Cryogenic pipes	ID100 mm, ID35 mm	~ 180	~ 20 m, ~ 80 m respectively
PMT	2000 pieces	~ 50	~ 25 mW/piece
Contingency	10%	138	

The outer vacuum chamber port-1 is connected to a turbopump (KYKY CXF-250/2301, China) via a 250 mm diameter gate electric valve. The turbopump is backed by a dry screw vacuum pump (Leybold VD65, Germany). This set of pumps is for the insulation and cryostat vacuum. Another turbopump (Leybold 850i, Germany) is mounted for inner chamber

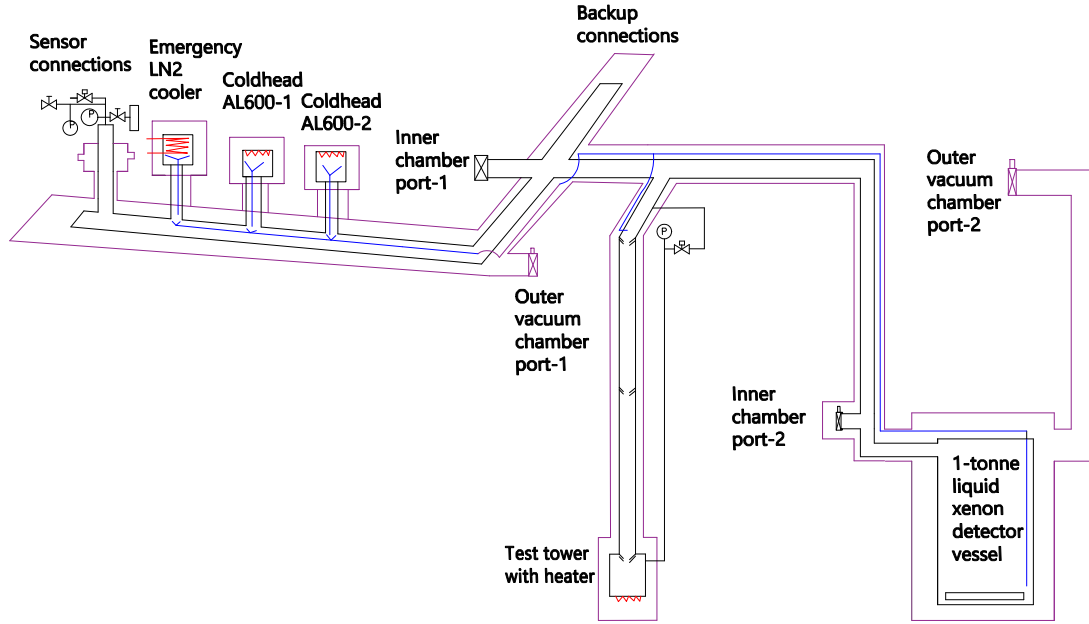

Figure 1. Schematic view of the PandaX-xT cryogenics system prototype. The diagram shows the installation locations of the main components: an emergency LN_2 cooler, two coldheads, test tower with its heater, 1-tonne liquid detector vessel, sensor connections, and backup connections for future equipment. The inner chamber ports and outer vacuum chamber ports are intended for connecting pump systems. The blue lines represents the liquid xenon pipes, the black denotes the inner chambers (gas xenon pipes), and the purple indicates the outer vacuum chambers. Liquid xenon pipes are partially routed outside the inner chambers for easy installations.

port-1 via a metal manual angle valve while inner chamber port-2 is for leak check of the detector vessel. The angle valve would be closed before filling xenon. Its forepump is a dry multi-stage Roots pump (Leybold ECODRY 40 plus, Germany). In addition, the inner pressure sensors, safety valves, rupture discs, and outer gauges are set up at the sensor connections. At the inner pressures exceeding 2.5 barg, the safety valves will open to release xenon to reduce pressure. When the inner pressure exceeds 3 barg, the rupture discs will activate.

Considering the multi-layer insulation (MLI) wrapped onto the inner chamber, the second pumping station with two LN_2 adsorption pumps is connected to the outer vacuum chamber port-2 directly with a 250 mm diameter empty pipe for maintaining good outer vacuum. The pumping station is also equipped with the pumps, a gate valve, and gauges, which are the same to that of the outer vacuum chamber port-1. The LN_2 adsorption pump is for emergency cases, such as power-off or malfunctioning of pumps.



Figure 2. A photograph of the PandaX-xT cryogenics system prototype. The cooling bus, mounted on the upper yellow platform, liquefies xenon gas, which then flows downward by gravity into the 1-tonne liquid xenon detector vessel housed on the lower yellow platform.

Finally, industrial programmable logic system controllers (PLCs) (SIEMENS, SIMATIC S7-1500) are designed and constructed to handle the read-out and the control strategies. For safety, 1 KVA*24 h uninterruptible power supply (UPS) is set up for PLCs. Figure 2 is a photograph of the cryogenics system prototype on the 2nd floor with 1-tonne liquid xenon detector vessel (the test tower behind the vessel is hidden due to the viewing angle) on the 1st floor and two connecting pipes. The facility covers an area of about 100 m^2 .

2.2 The cooling tower with coldhead

The cooling tower (Figure 3) mainly consists of a AL600 coldhead, a heater, a cold finger, and an isolated vacuum chamber. A 165 mm diameter Oxygen-Free High-Conductivity copper disc with the thickness of 16 mm is chosen to be a adapter between the heat exchanger of the coldhead and the cold finger, and they are sealed by flanges with a 0.3 mm thick indium sheet to ensure vacuum integrity between flange connections. The fin of the cold finger is in xenon gas for larger heat exchange area, the drops of liquid xenon condensed on the fin fall into a funnel, which guides them into the central liquid xenon pipe. The liquid xenon flows into the detector through the liquid xenon pipes, transferring cooling power to the detector. The cold finger is sealed with 2 mm diameter indium wire to a 200 mm diameter cylinder vessel, and the inner chamber of this vessel is connected to

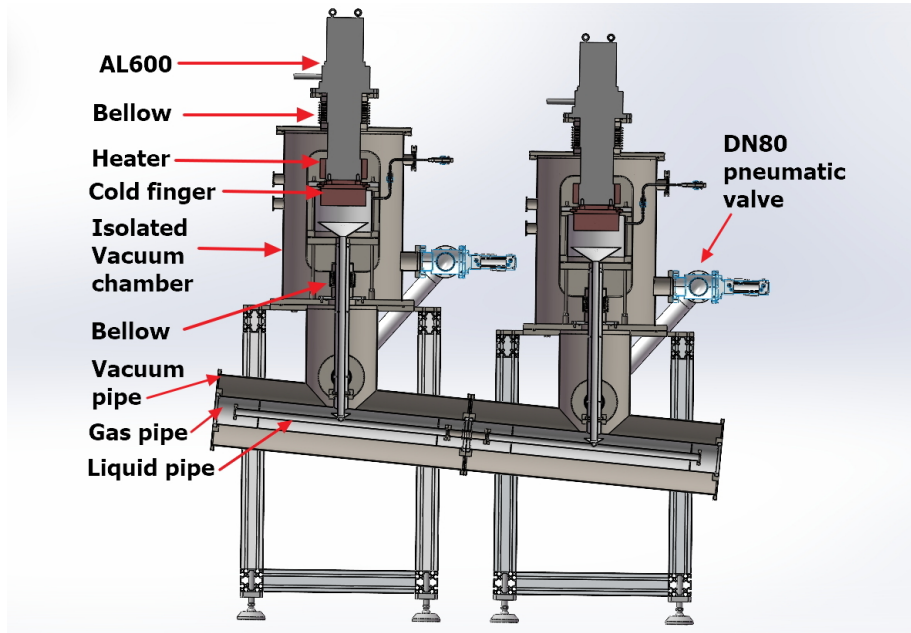

Figure 3. The section view of the cooling tower with AL600 coldhead. The two cooling towers have identical structures. Gas xenon is liquefied on the cold finger and then directed through a funnel into the liquid pipe. The isolated vacuum chamber which control by DN80 pneumatic valve allowing independent maintenance of each cooling tower without disrupting the operation of the other.

the gas xenon pipe with a 50 mm diameter pipe.

Using cryogenic thermal grease, cartridge heaters (10×130 W) are inserted into suitable holes of the copper ring (Figure 4.a) composed of two halves, the cooper ring is fixed on the cylinder of the cold head's heat exchanger by screws. Two Pt100 sensors are positioned on the cold finger with screws and another Pt100 sensor is fixed on the copper adapter (Figure 4.b). In order to service or replace the coldhead without opening the xenon pipe and breaking the outer vacuum chamber of the detector, the vacuum chamber of the cooling tower is separated from that of the detector with a DB80 pneumatic valve. When the cold head requires replacement, the DN80 valve can be closed to isolate the outer vacuum chamber of cooling tower. This allows the outer vacuum chamber of cooling tower to be vented without breaking the vacuum of the detector. Furthermore, the cold head transfers cooling power to the xenon gas via the copper adapter and cold finger, without direct contact with the xenon. As a result, the integrity of the inner chamber remains preserved during maintenance. The 200 mm diameter inner chamber is supported by four glass fiber reinforced plastics feet, which stand on the bottom plate of the vacuum chamber.

Finally, all the low temperature parts of the cooling tower are enclosed in the 400 mm diameter outer vacuum chamber with 20-layer MLI paper to minimize heat leakage from the outside walls. The vacuum chamber will be connected to the outer vacuum chamber of the detector during the experiment by a DN80 pneumatic valve. The temperature of the cold finger will be regulated by the PLCs and the heater.

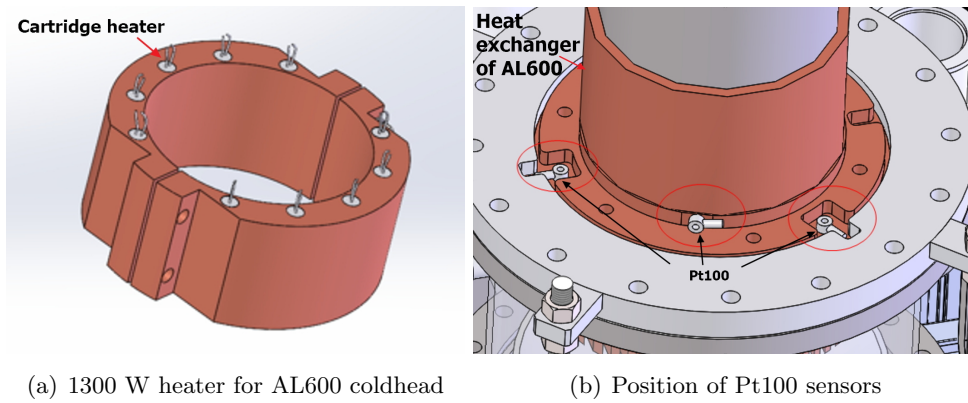

Figure 4. Design of heater and position of temperature sensors. Cartridge heaters are evenly distributed across the heater to ensure uniform heating, while PT100 sensors are arranged within the same quadrant for ease of installation and replacement.

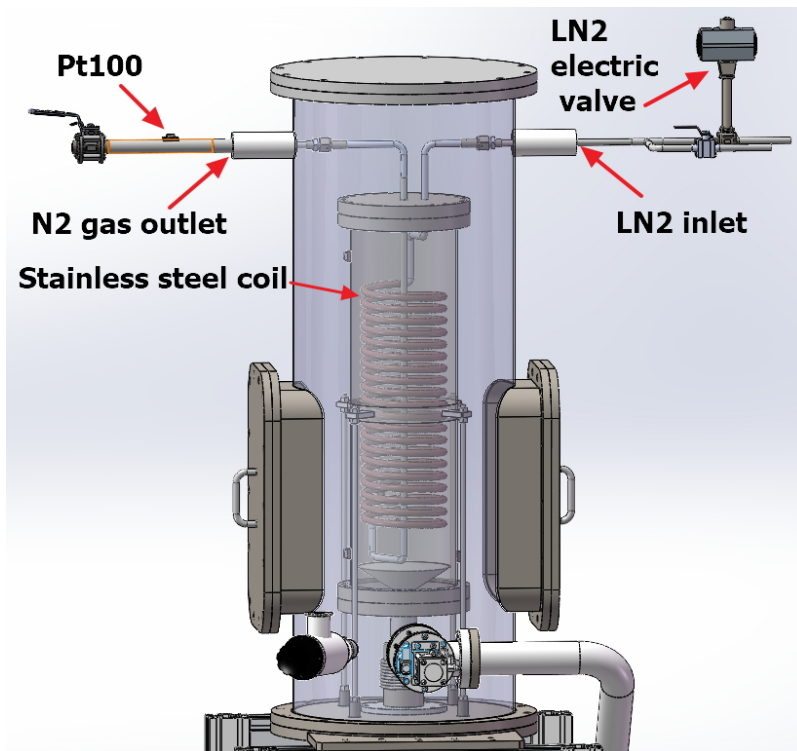

Figure 5. The section view of emergency LN_2 cooling tower. When the pressure exceeds a preset threshold, the electronic valve opens, allowing LN_2 to flow into the stainless steel coil. The LN_2 absorbs heat from the gas xenon and exits through the outlet. A PT100 temperature sensor monitors the cooling process in real time.

2.3 The emergency LN_2 cooler

The emergency LN_2 cooler is integrated with a dedicated LN_2 cooling circuit, an electrically controlled LN_2 valve, and a Pt100 temperature sensor, as shown in Figure 5. The cooling

medium is provided by one 175 L cryogenic LN_2 tank with a weight sensor. The LN_2 cooling circuit is made of a single 9.6 m stainless tube with an inner diameter of 10.22 mm and a wall thickness of 1.24 mm, wound in a circular helix shape. The pitch and the diameter of the circular helix are 23 mm and 152.7 mm, respectively.

During failure of the primary AL600 cryocooler due to power loss or system faults, the LN_2 coil provides intermittent backup cooling via PLC control. In case of PLC control failure, emergency cooling can be activated by manually opening the valve. The LN_2 inlet valve is turned on when the inner pressure (normal, 210 kPa) of the detector is greater than the upper trigger point (230 kPa), and it is turned off when the pressure is less than the lower trigger point (200 kPa). Therefore, the pressure of the liquid xenon detector can be maintained within a safe range. The trigger points also can be set as needed. In addition, a Pt100 temperature sensor at the N_2 gas outlet is used to monitor the operational status of the emergency LN_2 cooler. When the emergency cooler is activated, the outlet temperature drops by approximately 100 K, due to the introduction of cold LN_2 gas.

2.4 Test tower and 1-tonne liquid xenon vessel

The test tower (Figure 6.a) is designed to test the cooling bus with a small quantity of liquid xenon (about 15 kg) before detector installation. Its main function is to simulate heat leakage from detector, and it features a 2.2 kW heater which exceeds the expected heat load of 1518 W from the future PandaX-xT detector. The bottom of the test tower rests on the ground, its top is connected to the cooling bus on the 2nd floor, and the total height is 4.8 m. The test tower includes a liquid xenon chamber (Figure 6.b) with a diameter of 200 mm and a height of 800 mm. Two Pt100 sensors are installed on the underside of the chamber, and cartridge heaters (20×110 W) are precisely fitted into steel pipes welded inside the inner xenon chamber to ensure efficient heat transfer. The inner xenon chamber is supported by four glass fiber-reinforced plastic feet, which rest on the bottom plate of the outer vacuum chamber. Additionally, a 1-tonne liquid xenon detector vessel (Figure 6.c) was constructed for studying the liquid xenon detector. This vessel has an inner diameter of 1355 mm, a height of 1297 mm, and a flat bottom flange with a diameter of 1373 mm and a thickness of 60 mm. Eight PT100 sensors are installed inside the vessel, with four additional PT100s positioned externally for temperature monitoring.

3 Experimental results and discussion

After the system was constructed, at the start of the experiment, the outer and inner chamber were pumped at room temperature. The effective cooling power of the cooling tower was measured once the chamber reached a high vacuum level ($< 1 \times 10^{-3}$ Pa). The PLCs read the Pt100 sensors in the cold finger and regulate the electrical power supplied to the heaters, keeping the temperature of the cold finger stable at the set value. Subsequently, the effective cooling power will be measured at various temperature setpoints. To assess the system's stability and reliability, each experiment was conducted in cycles (cooling down and warming up) at least three times.

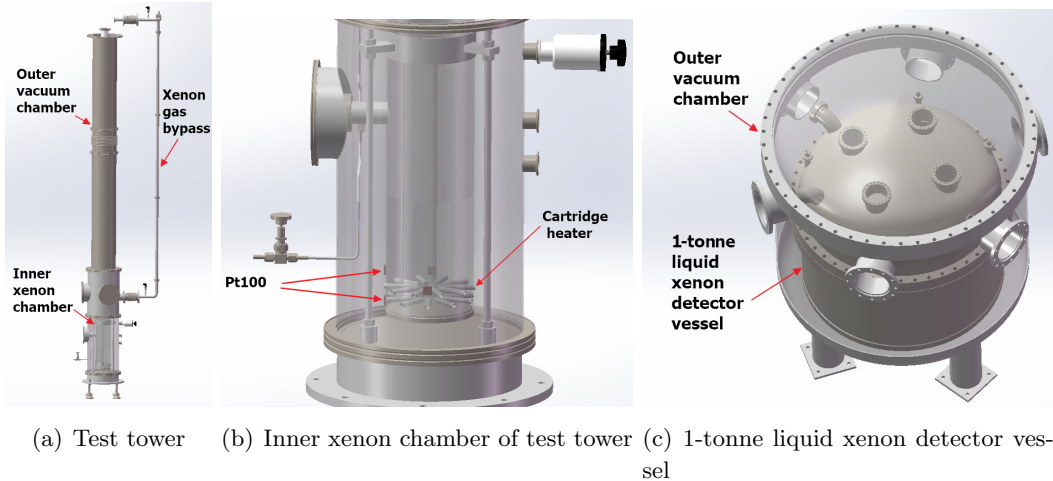

Figure 6. Test tower and 1-tonne liquid xenon detector vessel. The bottom of the cooling tower is equipped with an inner xenon chamber (15 kg capacity) for testing. Cartridge heaters assembly, with a total power of 2200 W and mounted at the bottom of the chamber, simulates thermal load to evaluate system stability. The 1-tonne liquid xenon detector vessel is enclosed in an outer vacuum chamber to minimize heat leakage.

Following the no-load tests, experiments with liquid xenon were conducted to evaluate the performance of the cooling tower and the emergency LN_2 cooler.

3.1 Cooling power of the coldhead AL600

The coldheads AL600-1 and AL600-2 were tested under similar conditions, and their lowest temperatures were measured over multiple runs. After 1.5 hours of cooling, the average minimum temperature reached was 28.60 ± 0.13 K for AL600-1 and 30.12 ± 0.13 K for AL600-2. This corresponds to a temperature difference of 1.52 ± 0.18 K between the two units. Assuming identical intrinsic performance of the two cryocoolers, this difference is attributed to variations in operating environment and installation conditions, a result that is considered reasonable and acceptable in practical applications. Nine temperature setpoints, all below 180 K, were tested for each cryocooler to evaluate cooling capacity by heating the cold finger gradually. The temperature of the cold finger stabilizes within 30 minutes after reaching the setpoint, and its fluctuation at steady state is less than 0.05 K. The heating power at steady state is taken as the effective cooling power of the coldhead. The temperature evolution at two typical setpoints (171 K and 173 K) and the temperature distribution at 173 K are shown in Figure 7. When the temperature setpoint was increased from 171 K to 173 K, both coldheads achieved steady-state within 30 minutes, and the temperature fluctuation at 173 K remained below 0.02 K.

The test results of cooling capability are shown in Figure 8. The data points from Cryomech company are also plotted, a quadratic polynomial function is used to fit the data. This fitting is performed to extrapolate AL600's cooling power within the 170-180 K temperature range, as the Cryomech company only provides cooling power values at 50 K, 60 K, 70 K, and 80 K. Their cooling power between 50 K and 80 K is almost the same.

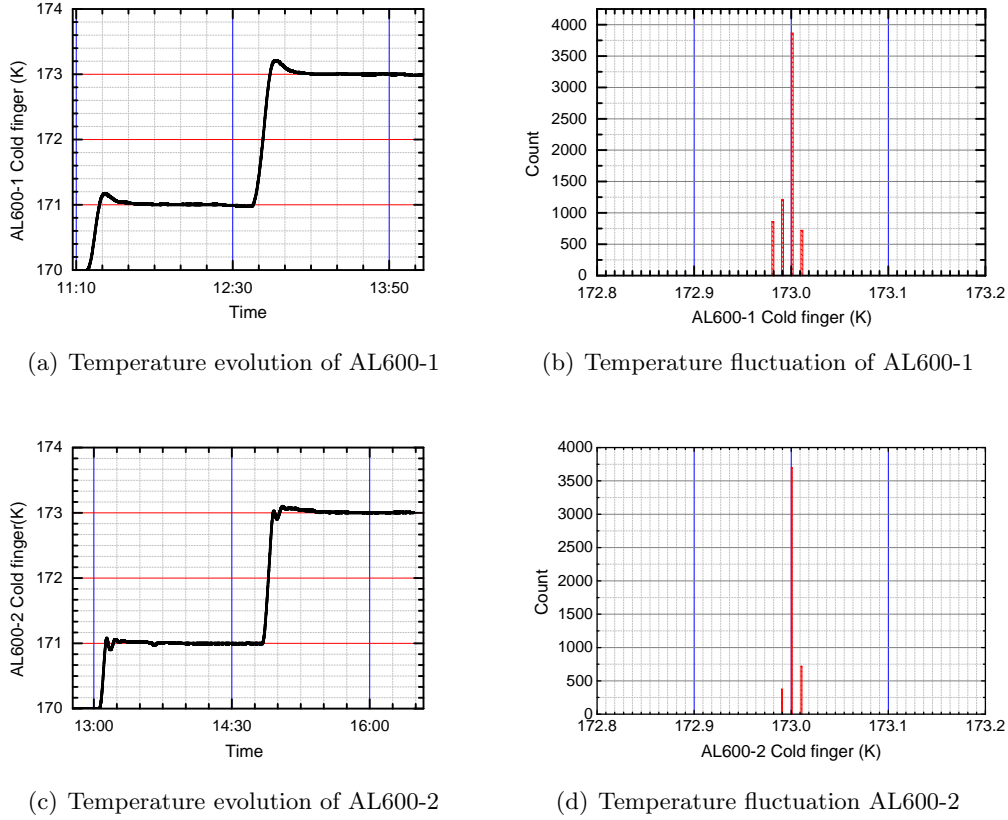

Figure 7. Temperature of the cold finger and its distribution under vacuum test. Selected temperature evolution from 171 K to 173 K during test, with fluctuation analysis performed on the data collected at the 173 K steady state.

The actual cooling power of AL600 installed in the cooling tower is a little lower than the fitted data as the temperature is below 50 K and above 100 K. Finally, it can reach about 950 W at 178 K for each coldhead of the AL600. The total cooling power of 1900 W from the two coldheads still satisfies our requirement of 1518 W.

3.2 Performance of the cooling tower

The cooling tower was then used to stabilize the temperature and pressure of the 1-tonne liquid xenon detector prototype which contained approximately 800 kg of liquid xenon. At the same time, the online purification loops were in operation. As shown in Figure 9, the xenon pressure remained stable for half a month using the AL600-1 coldhead (cold finger setpoint: 178 K) at a purification flow rate of approximately 140 slpm. Similarly, with the AL600-2 coldhead (cold finger setpoint: 178.5 K) and a flow rate of about 80 slpm, due to the replacement of circulation pump, stable pressure was maintained for one month. The pressure data of two cold heads were fitted with a Gaussian function and their standard deviation of the pressure is 0.31 kPa and 0.35 kPa respectively. During independent operation, each cryocooler required a heater power exceeding 700 W to stabilize the system

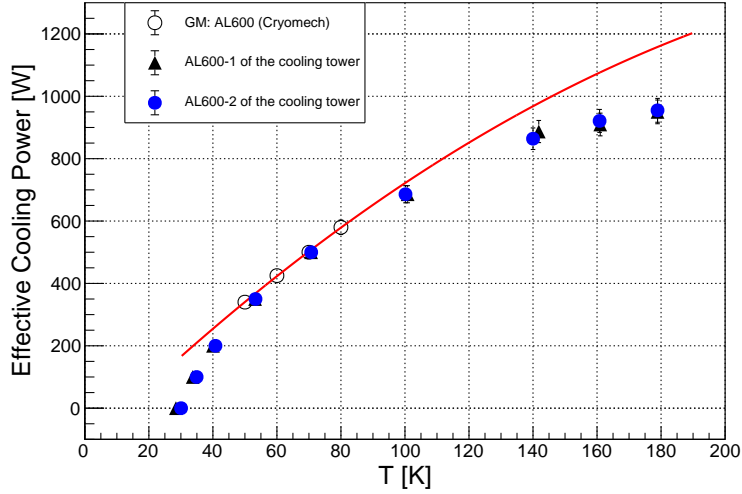

Figure 8. The effective cooling power of the two AL600 cryocoolers is compared with data from Cryomech company. The solid black triangles and solid blue circles represent the actual cooling powers of AL600-1 and AL600-2, respectively. The hollow circles represent four published cooling power points provided by Cryomech, and the solid red line is a quadratic polynomial fit to these data.

pressure at 212.95 ± 0.31 kPa and 210.61 ± 0.35 kPa, respectively, demonstrating that both units retained an available cooling capacity greater than 700 W at the operating temperature. Furthermore, these two cryocoolers can operate simultaneously to support higher thermal loads.

Therefore, the new cryogenics system with two AL600 coldheads performs well during long-term operation and is capable of handling a large liquid xenon detector with a heat load of approximately 1500 W.

3.3 Performance of the emergency LN_2 cooler

Before the 1-tonne liquid xenon detector was commissioned, a test was conducted using the test tower equipped with a heater to evaluate the emergency LN_2 cooler. Approximately 15 kg of xenon was first liquefied using the AL600 coldhead and then transferred into the inner liquid chamber of the test tower. The system was subsequently operated overnight to establish a stable thermal condition for the test. For safety during testing, the inner pressure was maintained at approximately 161 kPa using a 30 W heater. The upper and lower pressure thresholds for the LN_2 inlet valve were set to 190 kPa and 150 kPa, respectively. Subsequently, the AL600 cryocooler was turned off, and a series of tests were conducted at different heating powers (500 W and 1500 W) by heating the liquid xenon in the inner chamber of the test tower. The results are shown in Figure 10. As the heating power increased, the pressure rose more rapidly. At a heating power of 1500 W, the emergency LN_2 cooling system was still able to maintain stable operation, indicating a cooling capacity exceeding 1500 W at the liquid xenon temperature.

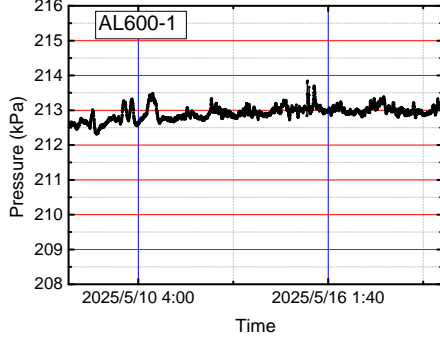

(a) Xenon pressure over 12 days at 140 slpm (Run AL600-1)

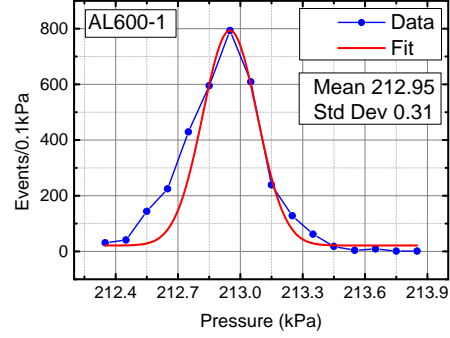

(b) Gaussian fit of pressure fluctuations during Run AL600-1.

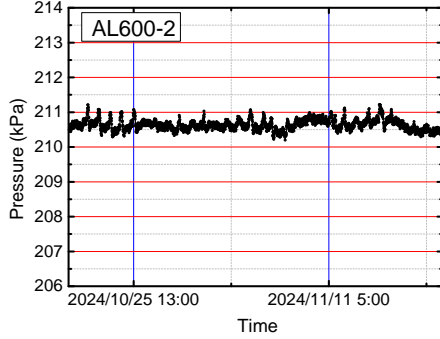

(c) Xenon pressure over 30 days at 80 slpm (Run AL600-2)

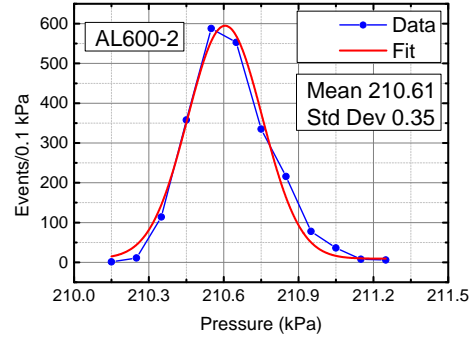

(d) Gaussian fit of pressure fluctuations during Run AL600-2

Figure 9. Performance of the cooling towers under different circulation rates. Shown are the long-term pressure behavior and fluctuation statistics from Runs AL600-1 (140 slpm) and AL600-2 (80 slpm) in the 1-tonne liquid xenon detector.

Therefore, this new designed LN_2 cooler shows high cooling power, and it can handle emergency cases of unexpected power-off and malfunction of cryocoolers for future PandaX-xT experiment.

4 Conclusion

In this paper, the new cryogenics system prototype based on AL600 GM cryocoolers and LN_2 coil cooler has been constructed and experimentally investigated. The test results show that the prototype can provide a cooling capacity of approximately 1900 W at 178 K using two AL600 coldheads, along with an emergency LN_2 cooling capacity exceeding 1500 W. The coldheads operate stably at pressures of 212.95 ± 0.31 kPa and 210.61 ± 0.35 kPa, respectively, with each retaining an available cooling capacity greater than 700 W. Furthermore, the system exhibits high reliability and repeatability. In summary, it can be utilized for the next-generation large liquid xenon detector, PandaX-xT, in the future.

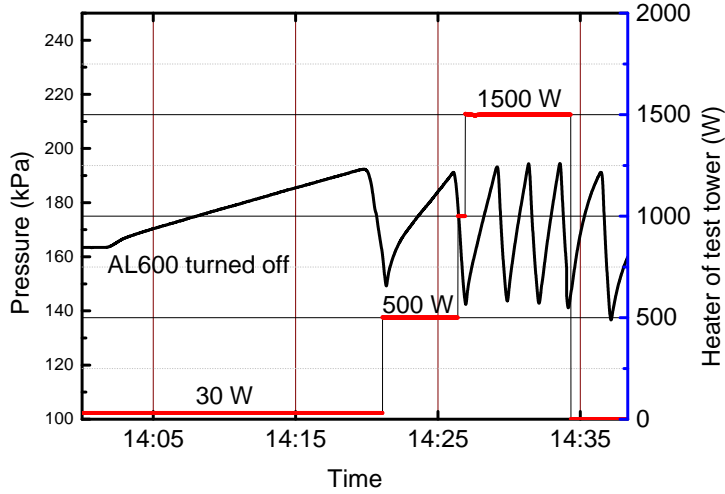

Figure 10. The test of LN_2 cooler using the test tower with about 15 kg liquid xenon. Red line indicates heater power, black line represents xenon pressure during the test. The pressure remains within the preset threshold under 1500 W heating power.

Acknowledgments

This project is supported in part by grants from National Key R&D Program of China (Nos. 2023YFA1606200, 2023YFA1606201, 2023YFA1606202), National Science Foundation of China (Nos. 12090060, 12090061, 12090062, 12305121, U23B2070), and by Office of Science and Technology, Shanghai Municipal Government (grant Nos. 21TQ1400218, 22JC1410100, 23JC1410200, ZJ2023-ZD-003). We thank for the support by the Fundamental Research Funds for the Central Universities. We also thank the sponsorship from the Chinese Academy of Sciences Center for Excellence in Particle Physics (CCEPP), Thomas and Linda Lau Family Foundation, New Cornerstone Science Foundation, Tencent Foundation in China, and Yangyang Development Fund. Finally, we thank the CJPL administration and the Yalong River Hydropower Development Company Ltd. for indispensable logistical support and other help.

References

- [1] K. J. Kang et al., *Status and prospects of a deep underground laboratory in China*, *J. Phys. Conf. Ser.* **203** (2010) 012028.
- [2] Mengjiao Xiao et al., *First dark matter search results from the PandaX-I experiment*, *Sci. China Phys. Mech. Astron.* **57** (2014) 2024.
- [3] Xiang Xiao et al., *Low-mass dark matter search results from full exposure of the PandaX-I experiment*, *Phys. Rev. D* **92** (2015) 052004.
- [4] Andi Tan et al., *Dark Matter Results from First 98.7 Days of Data from the PandaX-II Experiment*, *Phys. Rev. Lett.* **117** (2016) 121303.

- [5] Xiangyi Cui et al., *Dark Matter Results From 54-Ton-Day Exposure of PandaX-II Experiment*, *Phys.Rev.Lett.* **119** (2017) 181302.
- [6] Li Zhao et al., *Experimental search for dark matter in China*, *Frontiers of Physics* **15** (2020) 44301.
- [7] Xuyang Ning et al., *Limits on the luminance of dark matter from xenon recoil data*, *Nature* **618** (2023) 7963.
- [8] Changbo Fu et al., *Spin-Dependent Weakly-Interacting-Massive-Particle–Nucleon Cross Section Limits from First Data of PandaX-II Experiment*, *Phys. Rev. Lett.* **118** (2017) 071301.
- [9] Yue Meng et al., *Dark Matter Search Results from the PandaX-4T Commissioning Run*, *Phys. Rev. Lett.* **127** (2021) 261802.
- [10] Kaixiang Ni et al., *Searching for neutrino-less double beta decay of ^{136}Xe with PandaX-II liquid xenon detector*, *Chin. Phys. C* **43** (2019) 113001.
- [11] Xiyu Yan, et al., *Searching for Two-Neutrino and Neutrinoless Double Beta Decay of Xe^{134} with the PandaX-4T Experiment*, *Phys. Rev. Lett.* **132** (2024) 152502.
- [12] Shu Zhang, et al., *Searching for neutrinoless double-beta decay of ^{136}Xe with PandaX-4T*, *Science Bulletin* **70** (2025) 1779.
- [13] Zihao Bo et al., *Dark Matter Search Results from 1.54 Tonne-Year Exposure of PandaX-4T*, *Phys. Rev. Lett.* **134** (2025) 011805.
- [14] E. Aprile et al., *First Dark Matter Search with Nuclear Recoils from the XENONnT Experiment*, *Phys. Rev. Lett.* **131** (2023) 041003.
- [15] E. Aprile et al., *WIMP Dark Matter Search using a 3.1 tonne year Exposure of the XENONnT Experiment*, *arXiv:2502.18005*.
- [16] J.Aalbers et al., *First Dark Matter Search Results from the LUX-ZEPLIN (LZ) Experiment*, *Phys. Rev. Lett.* **131** (2023) 041002.
- [17] J.Aalbers et al., *Dark Matter Search Results from 4.2 Tonne-Years of Exposure of the LUX-ZEPLIN (LZ) Experiment*, *arXiv:2410.17036*.
- [18] Abdukerim et al., *PandaX-xT-A deep underground multi-ten-tonne liquid xenon observatory*, *Sci. China Phys. Mech. Astron.* **68** (2025) 221011.
- [19] E. Aprile et al., *Performance of a cryogenic system prototype for the XENON1T Detector*, *JINST* **7** (2012) P10001.
- [20] B.J. Mount et al., *LUX-ZEPLIN (LZ) Technical Design Report*, *arXiv:1703.09144* (2017).
- [21] Li Zhao et al., *The cryogenics and xenon handling system for the PandaX-4T experiment*, *JINST* **16** (2021) T06007.
- [22] *AL600 cryocoolers*, <https://www.cryomech.com/products/al600/>.