

Mitigating the barren plateau problem in linear optics

Matthew D. Horner

Aegiq Ltd., Cooper Buildings, Arundel Street, Sheffield, S1 2NS, United Kingdom

We prove the existence of barren plateaus in variational quantum algorithms using linear optics with either bosonic or fermionic particles and demonstrate that fermionic linear optics is less susceptible to the barren plateau problem. We use this to motivate a new photonic device, the dual-valued phase shifter, that is a non-linear phase shifter with two distinct eigenvalues. This component results in variational cost landscapes with fewer local minima regardless of the problem, ansatz or circuit layout. We propose three ways to achieve this by using either non-linear optics, measurement-induced non-linearities, or entangled resource states simulating fermionic statistics. The latter two require linear optics only, allowing for implementation with widely-available technology today. We show this outperforms the best-known linear optical variational algorithm for all tests we conducted.

CONTENTS

I. Introduction	1	D. Proof of Theorem 1	31
II. The barren plateau problem in linear optics	2	1. Haar measure moments	31
A. Variational quantum algorithms using linear optics	2	2. Calculating the variance	33
B. Barren plateaus	3	3. Application to linear optics	34
C. Bosonic cost landscapes	4	a. Representations of linear optics	34
D. Fermionic cost landscapes and Rotosolve	5	b. Young Tableaux	36
III. The dual-valued phase shifter	6	c. Derivation of examples	36
A. Motivation	6	I. INTRODUCTION	
B. Deterministic design with non-linear optics	7	Variational quantum algorithms [1, 2] have emerged as a common application of quantum computing as they do not require fault tolerant systems and are widely applicable to many real-world problems that are NP-hard. Example problems include the travelling salesman problem [3–7], SAT solvers [3, 8–12], job shop scheduling [13–15], maximum cut [12], and graph colouring problems [12], among others [3, 12]. At the core of these algorithms lies an optimisation, where the task is to find the minimum of a cost function encoding the problem, typically done using gradient descent.	
C. Non-deterministic design with linear optics	8	A barrier to the success of these algorithms is the barren plateau problem [16–18] which states that the gradient of the cost function becomes exponentially small as the problem size scales up, reducing the chance of finding the minimum. This reduces the practical utility of these algorithms for solving large real-world problems. Various tricks to mitigate the barren plateau problem exist including a careful choice of ansatz [19–22], reducing the expressibility of the circuit and shallow circuits [19, 23–25], initial parameter optimisation [26, 27], modifying the cost function [28, 29], identifying symmetries in the problem [30–34], or by off-loading work to the classical optimiser [35, 36]. However, these heavily rely upon classical pre-processing instead of anything inherently quantum, further increasing the reliance on classical methods and relegating the role of the quantum computer.	
D. Photonic fermion sampling	8	Here we focus on variational quantum algorithms implemented with discrete variable linear optics and demonstrate how to exploit quantum effects to improve their performance without reliance on any additional classical pre-processing in an application-agnostic manner. These	
E. Resources of the three designs	10		
IV. Results	10		
A. Cost landscapes	10		
B. Application to constrained and unconstrained QUBO problems	11		
C. Rotosolve for boson sampling	13		
V. Conclusion and discussion	13		
Acknowledgments	14		
References	14		
A. Bosonic and fermionic linear optics	18		
1. Linear interferometers	18		
2. Sampling amplitudes	19		
3. Simulating fermions with single photons and linear optics	20		
B. Cost landscapes of linear optics	21		
1. Derivation of the cost landscape	21		
2. Solving for the minima	23		
C. Derivations for the dual-valued phase shifter	25		
1. Deterministic design with non-linear optics	25		
2. Non-deterministic design with linear optics	26		

algorithms work by sampling bit strings from the output of a linear optical interferometer and optimising over the parametrised phase shifters [37]. We investigate both numerically and analytically the regimes for which we expect to see barren plateaus in linear optics and find that it depends not only on the size of the system but the statistics.

We then build upon this algorithm by replacing each parametrised phase shifter with a non-linear phase shifter that has two distinct eigenvalues, similar to Pauli-generated unitaries in qubit-based systems or parity operators, resulting in a simpler cost landscape with fewer local minima and barren plateaus irrespective of the problem we are solving. Moreover, this allows one to circumvent gradient descent entirely by using the gradient-free Rotosolve algorithm [38–42] to gain a considerable improvement over the best known gradient-based algorithm for discrete photonics.

We provide three ways to realise this non-linear phase shifter. First by direct implementation using non-linear optical components, second by measurement-induced non-linearities with linear optics; and third by performing fermion sampling with an entangled resource state. The second and third ways require single photon sources, linear optics and single photon detectors, which is widely available technology today. As these three methods result in cost landscapes of the same form, for numerical convenience we focus on the performance of the fermionic resource state, thereby comparing the performance of fermionic linear optics to bosonic linear optics for solving quantum variational problems.

The paper is structured as follows. First we review the variational quantum algorithm for solving QUBO problems with linear optics. We then we present a theorem for the barren plateau scaling of linear optics. Then we study the difference between the cost landscapes of fermionic and bosonic linear optics, which then motivates us to introduce a non-linear phase shifter, the dual-valued phase shifter (DVPS), and study its resulting cost function. Then we present three different realisations of the DVPS and compare them. Then the remainder of the paper presents numerical results comparing the performance of fermion and bosonic linear optics for solving random QUBO problems, and testing the application of the gradient-free Rotosolve algorithm. We conclude the paper with open problems that arose during this work.

II. THE BARREN PLATEAU PROBLEM IN LINEAR OPTICS

A. Variational quantum algorithms using linear optics

An N -mode linear optical interferometer is a network of N waveguides, parametrised phase shifters, 50:50 beamsplitters and single-particle detection, as shown in Fig. 1. The particles inserted into these devices are in-

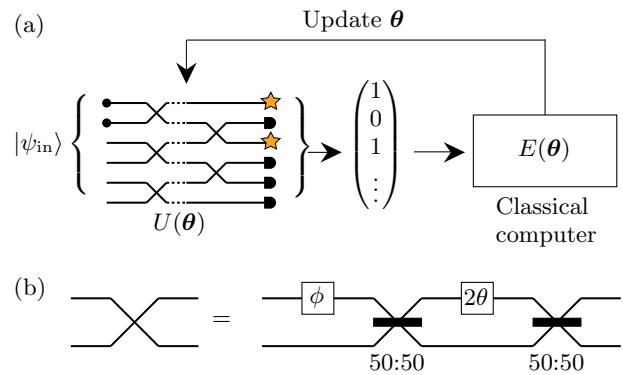

FIG. 1. (a) The bosonic linear optics variational quantum algorithm of Ref. [37] consists of a linear optical interferometer encoding a parametrised unitary $U(\theta)$ and photo-detectors. Here we show an example with a photon inserted into the top two modes on the left, represented by the solid circles, where the stars represent detector clicks which maps to a bit string. The classical computer calculates the cost function $E(\theta)$ from multiple shots of this and then updates the parameters in order to optimise this. (b) Each cross-over point corresponds to a Mach-Zehnder interferometer consisting of two phase shifters $\theta, \phi \in [0, 2\pi)$ and two fixed 50:50 beamsplitters.

distinguishable and can be either fermionic or bosonic, so the only degree of freedom available is the waveguide degree of freedom which we refer to as the modes.

The states of this system are described by a Fock space \mathcal{F} spanned by the number basis states $|\mathbf{n}\rangle = |n_1, n_2, \dots, n_N\rangle$, where n_i is the number of particles in the i th mode. For bosons $n_i \in \mathbb{N}$, whereas for fermions $n_i \in \{0, 1\}$ due to the Pauli exclusion principle. Acting on the Fock space is a set of ladder operators, a_i^\dagger and a_i , that create and annihilate particles in the i th mode and obey the commutation relations $[a_i, a_j^\dagger]_{\pm} = \delta_{ij}$ and $[a_i, a_j]_{\pm} = [a_i^\dagger, a_j^\dagger]_{\pm} = 0$, where \pm corresponds to the anti-commutator for fermions or the commutator for bosons, respectively.

A linear optical interferometer applies a non-interacting and particle conserving unitary transformation $U : \mathcal{F} \rightarrow \mathcal{F}$ whose action in the Heisenberg picture is a linear transformation on the space of ladder operators as

$$U a_i^\dagger U^\dagger = \sum_{j=1}^N u_{ji} a_j^\dagger, \quad (1)$$

where u_{ji} are the components of a matrix $u \in U(N)$. The unitaries u which are programmed into the interferometer are parametrised by a vector of phases $\theta = (\theta_1, \theta_2, \dots)$, where $\theta_a \in [0, 2\pi)$ is the phase shift of the a th phase shifter in the interferometer. There exists universal interferometers that can encode any $u \in U(N)$ [43–45], however this does not mean that the interferometer is a universal quantum computer as only unitaries U which transform ladder operators linearly as in Eq. (1) can be encoded on the Fock space. In other words, this can

only encode unitaries generated by *quadratic* particle-conserving Hamiltonians. For universal quantum computing with linear optics then the KLM protocol is required [46, 47].

Inserting a number state $|\mathbf{n}\rangle$ into a linear optical interferometer and sampling from the output is called boson sampling or fermion sampling depending upon the statistics of the particles [48–53]. The transition amplitudes between n -particle input and output states of one of these interferometers is given by

$$\langle \mathbf{m}|U|\mathbf{n}\rangle = \frac{1}{\sqrt{\mathbf{m}!\mathbf{n}!}} \begin{cases} \text{per } u[\mathbf{m}|\mathbf{n}] & \text{bosons} \\ \det u[\mathbf{m}|\mathbf{n}] & \text{fermions} \end{cases}, \quad (2)$$

where per is the permanent, det is the determinant, $\mathbf{n}! = n_1!n_2!\dots n_N!$ and $u[\mathbf{m}|\mathbf{n}]$ is an n -dimensional matrix constructed from the elements of u from Eq. (1) by repeating the i th row index m_i times and the j th column index n_j times. Calculating the permanent is a #P problem which gives boson sampling its quantum advantage [54–58], whilst calculating the determinant is a P problem meaning fermion sampling is efficiently classically simulable [50–53]. See Appendix A for an overview.

Many variational quantum algorithms encode a problem we wish to solve into an observable H such that the ground state corresponds to the solution to the problem. To find this ground state, the quantum computer is prepared in the state ρ and is evolved by the parametrised unitary $U(\boldsymbol{\theta})$. The expectation value, or cost function, of the observable at the output is

$$E(\boldsymbol{\theta}) = \text{Tr} [U(\boldsymbol{\theta})\rho U^\dagger(\boldsymbol{\theta})H], \quad (3)$$

which is calculated by a classical computer using measurement data from multiple shots. The classical computer then attempts to find the minimum of the cost function by optimising over the parameters $\boldsymbol{\theta}$. With the optimal parameters, $\boldsymbol{\theta}_0$, the output state $\rho(\boldsymbol{\theta}_0) = U(\boldsymbol{\theta}_0)\rho U^\dagger(\boldsymbol{\theta}_0)$ is returned as the solution to the problem. In Fig. 1 we show how a variational quantum algorithm can be performed with a linear optical interferometer and particle detectors, where the variational parameters are the phases of the phase shifters.

One application of this is to solve quadratic unconstrained binary optimisation (QUBO) problems. Given an N -bit QUBO problem, the goal is to find the N -bit string $\mathbf{x} = (x_1, x_2, \dots, x_N)$ that minimises the quadratic cost function

$$C(\mathbf{x}) = \sum_{i,j=1}^N Q_{ij}x_ix_j, \quad (4)$$

where Q is an $N \times N$ real symmetric matrix [3]. This can be encoded into a linear optical variational quantum algorithm by introducing the Hamiltonian

$$H = \sum_{i,j=1}^N Q_{ij}\Theta(\hat{n}_i)\Theta(\hat{n}_j), \quad (5)$$

where $\hat{n}_i = a_i^\dagger a_i$ is the number operator for the i th mode and Θ is the Heaviside step function (using the convention that $\Theta(0) = 0$) which acts on the number operator as $\Theta(\hat{n}_i)|\mathbf{n}\rangle = \Theta(n_i)|\mathbf{n}\rangle$. This step function models the effect of a threshold photo-detector that can count only whether there was at least one particle or not and naturally maps the outputs to bit strings. As multiple bosons can occupy the same mode, multiple outputs from a boson sampler will be indistinguishable after mapping to bit strings which introduces redundancy, however fermions do not suffer from this as all fermionic states are fixed Hamming weight bit strings due to the Pauli exclusion principle, i.e., $\Theta(\hat{n}_i) = \hat{n}_i$.

Inserting the observable of Eq. (5) into the general expression for the cost function of Eq. (3) yields

$$E(\boldsymbol{\theta}) = \sum_{\mathbf{x}} p(\mathbf{x}|\boldsymbol{\theta})C(\mathbf{x}), \quad (6)$$

which is the expectation value of the classical cost function from Eq. (4), where $p(\mathbf{x}|\boldsymbol{\theta})$ is the probability for the output state to yield the bit string $\mathbf{x} = \Theta(\mathbf{n})$ given the parameters $\boldsymbol{\theta}$ of the interferometer. This quantity is then minimised.

This is the best known method for solving QUBO problems with a boson sampler which was first presented in Ref. [37] and can be easily used for any binary cost function $C(\mathbf{x})$ beyond QUBO. Building upon this algorithm is the focus of this study.

B. Barren plateaus

A huge barrier to the success of gradient-based optimisers is the barren plateau problem. For qubit-based systems, this means the variance of the cost function decays exponentially as

$$\text{Var}_{\boldsymbol{\theta}}[E(\boldsymbol{\theta})] = O(1/b^M) \quad (7)$$

where $b > 1$ and M is the number of qubits [17, 59]. An alternative definition in terms of the variance of the gradient is also used [16, 60] but we use the former. In this section we derive the scaling behaviour of the variance of the cost function for linear optics, where now we expect a dependence on the number of modes N , the number of particles n , and the statistics of the particles.

From the definition of the linear Fock space unitaries U in Eq. (1), we see that they form a faithful representation of $U(N)$ on the Fock space: by interpreting the Fock space unitary as a function of u_{ij} as $U = U(u)$, we find that $U(u_1)U(u_2) = U(u_1u_2)$. As linear unitaries conserve particle number, each n -particle subspace is an invariant subspace under the action of U and these subspaces additionally form irreducible representations (irreps) (see Appendix D for proof). The Fock space decomposes as

$$\mathcal{F} = \bigoplus_n \mathcal{H}_n, \quad (8)$$

where \mathcal{H}_n is the n -particle subspace forming the irrep. If we let $V = \mathbb{C}^N$ be the vector space of a single particle in an N -mode interferometer, then these subspaces depend upon the statistics of the particles and are given by

$$\mathcal{H}_n = \begin{cases} \text{Sym}^n(V) & \text{bosons} \\ \wedge^n(V) & \text{fermions} \end{cases}, \quad (9)$$

where $(\wedge^n) \text{Sym}^n$ is the (anti-)symmetric n -fold tensor product space. Therefore, a linear optical interferometer with a fixed number of particles hosts an irreducible representation of $U(N)$.

To calculate the variance we typically assume that circuit unitaries form a 2-design, meaning that moments of the cost function with respect to the distribution of circuit parameters is equal to moments with respect to the uniform Haar measure distribution on the Lie group of the circuit [16, 17, 59]. For linear optics, we assume that we have a 2-design with respect to *linear* unitaries of the form of Eq. (1) only, and not all possible Fock space unitaries. This is a realistic assumption to make as universal interferometers are widely available and can encode any $U = U(u)$, so we can sample $u \in U(N)$ with respect to the Haar measure. The result is the following theorem which is proven in appendix D:

Theorem 1. *Consider an N mode linear optical interferometer containing n particles of either bosonic or fermionic statistics forming the $U(N)$ irrep \mathcal{H}_n , c.f. Eq. (9), whose tensor product space decomposes into irreps as $\mathcal{H}_n \otimes \mathcal{H}_n = \bigoplus_{\alpha} \mathcal{H}_{\alpha}$ indexed by α , where each irrep has unit multiplicity with orthogonal projectors P^{α} . Then given an input state ρ and an observable H , the variance of the cost function with respect to the Haar measure is given by*

$$\text{Var}_{\theta}[E(\theta)] = \sum_{\alpha} \frac{1}{d_{\alpha}} \text{Tr}(P^{\alpha} \rho^{\otimes 2}) \text{Tr}(P^{\alpha} H^{\otimes 2}) - \frac{\text{Tr}(H)^2}{d_n^2}, \quad (10)$$

where $d_n = \dim(\mathcal{H}_n)$ and $d_{\alpha} = \dim(\mathcal{H}_{\alpha})$.

An alternative expression for the variance can be calculated by using the adjoint representation of operators instead, as done in Ref. [61].

We now study this result for an N -mode interferometer with n particles of either bosonic or fermionic statistics by considering three scenarios: we vary n whilst keeping N fixed; we vary N whilst keeping n fixed; or we vary N and n simultaneously (as this is typically what we mean when we scale up linear optics) by taking $N = 2n$. In practice, the input states to a linear optical interferometer are pure number states prepared by a single photon source with a demultiplexer to route the photons into the same time bin, so we take $\rho = |\mathbf{n}\rangle\langle\mathbf{n}|$ where $|\mathbf{n}\rangle$ is a number state. The measurement observables H accessible to an experiment are projective measurements onto number states, which in the following examples we take to be the same as the input state.

With this information we can now evaluate the variances. Evaluating the traces $\text{Tr}(P^{\alpha} \rho^{\otimes 2})$ and $\text{Tr}(P^{\alpha} H^{\otimes 2})$ of Eq. (10) is challenging in practice, however as a first step we can construct a loose upper bound by noting that the operators ρ and H are both projectors so the traces are upper bounded by unity, so we get

$$\text{Var}_{\theta}[E(\theta)] \leq \sum_{\alpha} \frac{1}{d_{\alpha}} - \frac{1}{d_n^2}. \quad (11)$$

which provides enough information to establish the existence of barren plateaus alone.

Under certain circumstances we can improve upon this. One experimentally-relevant input state is the n -particle collision-free state consisting of one particle in each of the first n modes. If the particles are bosonic, the variance is given by

$$\text{Var}_{\theta}[E(\theta)] = \sum_{\text{even } \alpha} \frac{4^{n-\alpha}}{d_{\alpha}} \left(\frac{2n - 2\alpha + 1}{2n - \alpha + 1} \frac{\binom{n}{\alpha/2}}{\binom{2n-\alpha}{n-\alpha/2}} \right)^2 - \frac{1}{d_n^2}, \quad (12)$$

whereas if the particles are fermionic the expression is much simpler and is given by

$$\text{Var}_{\theta}[E(\theta)] = \frac{1}{d_n^2} \frac{n(N-n)}{N+1}. \quad (13)$$

Another example of interest is the n -boson input state consisting of n particles on the first mode. In this case, the variance is given by

$$\text{Var}_{\theta}[E(\theta)] = \frac{1}{d_{2n}} - \frac{1}{d_n^2}. \quad (14)$$

There is no fermionic analogue of this due to the Pauli exclusion principle. The proof of these three results are found in Appendix D 3c.

In Fig. 2 we test these cases numerically using the Lightworks python package [62] using exact wavefunction simulation and see a good agreement with the analytics. If we scale N only, then the variance decays polynomially regardless of the statistics implying there is no barren plateau here, however if n scales then the decay is faster. If we scale both N and n with the relationship $N = 2n$ then the decay is exponential for both statistics implying the existence of a barren plateau. Despite this, bosonic statistics decays orders of magnitude faster than fermionic statistics, especially for the collision-free input state which is the input state in real experiments. This implies that fermionic linear optics is less susceptible to the barren plateau problem for experimentally-relevant cases.

C. Bosonic cost landscapes

The previous section has demonstrated that if our particles have fermionic statistics, they are less susceptible

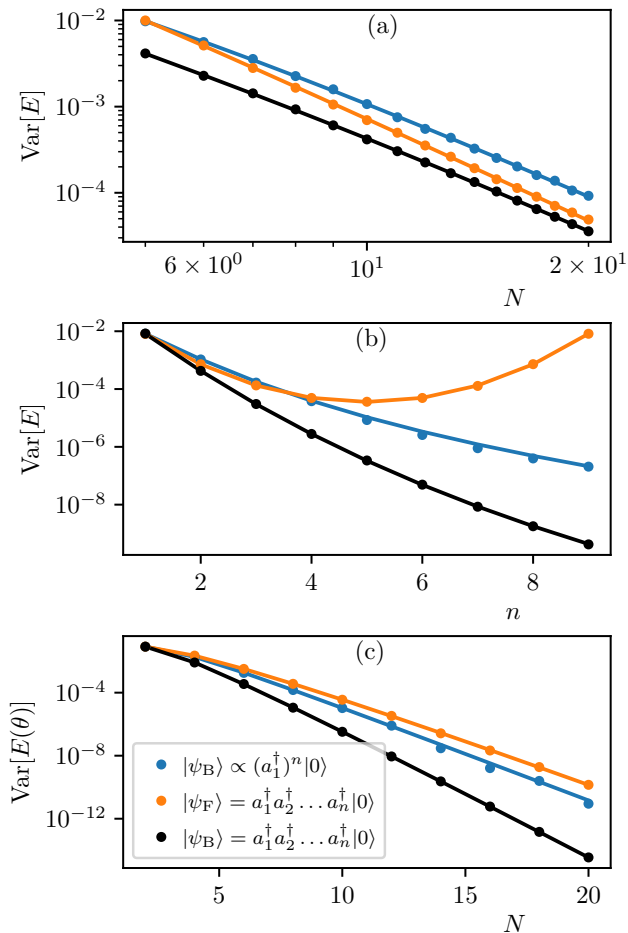

FIG. 2. The variance of the cost function for an N -mode interferometer containing n particles of either bosonic or fermionic statistics, denoted by $|\psi_B\rangle$ or $|\psi_F\rangle$ respectively, where linear unitaries are sampled with respect to the Haar measure for 6×10^4 repeats. In each subplot, markers correspond to numeric data, whilst solid lines correspond to analytic formulae of Eqs. (12)-(14). (a) We fix $n = 2$ and vary N . We see a polynomial decay in N as this is a log-log plot, hence scaling N alone does not result in a barren plateau. (b) We fix $N = 10$ as we vary n . We see a decay slower than, but approaching, exponential decay. In particular, when $n > N/2$ the fermionic variance increases as the Hilbert space dimension begins to decrease beyond this point. (c) We let $N = 2n$ and vary N . We see exponential decay, implying that we have a barren plateau here. Despite this we see that the collision-free input state for bosons, which is the most relevant to a real experiment, decays orders of magnitudes faster than the same state with fermionic statistics.

to the barren plateau problem. In order to further investigate the difference between bosonic and fermionic linear optics, let us now study the functional form of the cost function of Eq. (3) for an arbitrary observable H . If we insert n bosons into an N -mode interferometer and vary a single phase shifter, say the μ th one, whilst keeping

the rest fixed, then the cost function is given by the real trigonometric polynomial

$$f(x) := E(\theta_\mu = x) = \sum_{k=-n}^n c_k e^{ikx}, \quad (15)$$

where c_k are coefficients that depend upon details of the rest of the interferometer and H . See Appendix B or Ref. [63] for the proof. We refer to this as the *bosonic cost landscape*.

Using trigonometric interpolation, the gradient of an unknown cost function with respect to a given parameter can be evaluated exactly given a set of $2n$ samples of the cost function as

$$f'(x) = \sum_{k=1}^{2n} f(x + x_k) \frac{(-1)^{k+1}}{4n \sin^2(x_k/2)}, \quad (16)$$

where $x_k = \frac{(2k-1)\pi}{2n}$ are the equally-spaced sample parameters [40, 64, 65]. This is a generalised parameter shift rule for cost functions with n harmonics that can be used for gradient descent. As n is the number of particles in the interferometer, this scales poorly in general which will impact the speed of the optimiser. Moreover, due to how expressive Fourier series is, with larger n the cost function of Eq. (15) can result in extremely complicated functions, including functions with approximate discontinuities and barren plateaus, and it contains up to n local minima per parameter. All of these issues will impede a gradient-based optimiser and in this paper we ask how one can mitigate them.

To obtain a cost landscape of the form of Eq. (15) we require the parametrised unitaries to be phase shifters. In other variational algorithms, such as QAOA [66] or the variational quantum eigensolver [67], the parametrised unitaries may not be phase shifters in general. However, if the parametrised unitaries are generated by quadratic Hamiltonians then one can decompose them exactly into a product of parametrised phase shifters and fixed 50:50 beamsplitters using known algorithms [43–45] which we can then vary independently.

D. Fermionic cost landscapes and Rotosolve

The large number of harmonics in the bosonic cost landscape of Eq. (15) can be traced back to the unitary implementing the parametrised phase shifter, given by $U_{PS}(x) = \exp(i\hat{n}x)$, where \hat{n} is the number operator for the mode it acts upon and $x \in [0, 2\pi)$ is the phase. Given an n -particle state $|n\rangle$, this acts as

$$U_{PS}(x)|n\rangle = e^{inx}|n\rangle, \quad (17)$$

where $n \in \mathbb{N}$ are the eigenvalues of \hat{n} . These complex phases give rise to the harmonics of the cost function of Eq. (15) with the set frequencies equal to the set of differences of eigenvalues of \hat{n} , see appendix B.

Algorithm 1 Rotosolve [38–41]

Require: Cost function $E(\boldsymbol{\theta}) = \langle \psi_{\text{out}}(\boldsymbol{\theta}) | H | \psi_{\text{out}}(\boldsymbol{\theta}) \rangle$
while termination criteria not met **do**
 for $i = 1, 2, \dots, N_p$ **do**
 Let $f(x) = E(\theta_i = x)$
 Estimate $f(0)$, $f(\pi/2)$ and $f(-\pi/2)$
 $X = f(\pi/2) - f(-\pi/2)$
 $Y = 2f(0) - f(\pi/2) - f(-\pi/2)$
 $\theta_i \rightarrow -\pi/2 - \text{atan2}(Y, X)$
 end for
end while

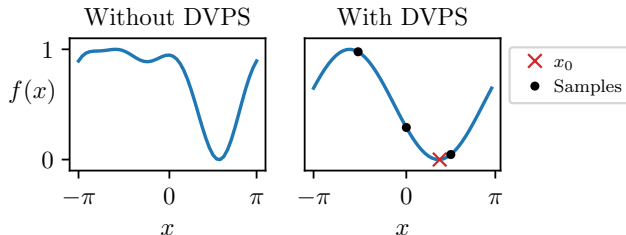

FIG. 3. The cost function for $n = 7$ particles and $N = 10$ modes with a random H . Fermionic statistics simplifies the cost landscape for this example. The minimum x_0 can be found by sampling the cost function at $x = 0, \pm\pi/2$ alone. Rotosolve exploits this by applying this to each variable iteratively.

Suppose that we performed the same experiment with fermions instead, then the number operator has only two eigenvalues of $n \in \{0, 1\}$ due to the Pauli exclusion principle and the cost landscape of Eq. (15) reduces to the simple form

$$f(x) = A \sin(x - \phi) + B, \quad (18)$$

where A, B, ϕ are constants depending upon details of the rest of the interferometer and the observable, see Appendix B. This holds regardless of the observable H , the input state, the number of particles or the size and layout of the interferometer. We refer to this as a *fermionic cost landscape*. See Fig. 3 for an example produced using an exact wavefunction simulation.

We can immediately apply the parameter shift rule of Eq. (16) to this simpler cost landscape to get

$$f'(x) = \frac{1}{2} \left[f\left(x + \frac{\pi}{2}\right) - f\left(x - \frac{\pi}{2}\right) \right], \quad (19)$$

which is the original parameter shift rule of Ref. [68] first applied to qubit-based systems. This means only two evaluations of the cost function are required for each component of the gradient as it no longer scales with the number of particles inserted, n , which is a considerable improvement over the requirements for the gradient of Eq. (16).

On the other hand, the fact the fermionic cost landscape contains only one harmonic means we can avoid

using gradient-based optimisation entirely. Due to the fact that there is a single minimum as one parameter is varied, we can solve for it using trigonometric interpolation. The minimum of $f(x)$ is given by x_0 , where

$$\begin{aligned} x_0 &= -\pi/2 - \text{atan2}(Y, X), \\ X &= f(\pi/2) - f(-\pi/2), \\ Y &= 2f(0) - f(\pi/2) - f(-\pi/2), \end{aligned} \quad (20)$$

as shown in Fig. (3), where $\text{atan2} \in [-\pi, \pi]$ is the two-argument arctangent. This forms the basis of the Rotosolve algorithm of Refs. [38–42], whereby each phase shifter is iteratively optimised whilst holding the rest fixed, as shown in Algorithm 1. This significantly reduces the number of cost function samples, and hence shots, required to optimise. If the interferometer has N_{PS} phase shifters and n photons, then the number of cost evaluations per iteration of gradient descent for bosonic and fermionic cost landscapes using the parameter shift rule is $2nN_{\text{PS}}$ and $2N_{\text{PS}}$ respectively, and for Rotosolve it is 3.

In Fig. 2 of the previous section, we demonstrated that linear optics suffers from the barren plateau problem. This means that gradient-based optimisers will suffer as the problem scales up. Whilst Fig. demonstrates that the barren plateau scaling of fermionic linear optics is better than its bosonic counterpart, the improvement is modest and it still exhibits the exponential decay. However, fermionic linear optics allows us to bypass gradient-based optimisers entirely and gives us a considerable speedup. In Sec. IV we present results comparing the performance of the various methods and it is seen that Rotosolve significantly outperforms gradient descent for all tests we performed. Before presenting the results, in the next section we discuss three possible ways we can generate fermionic cost landscapes using bosons.

III. THE DUAL-VALUED PHASE SHIFTER

A. Motivation

Fermionic linear optics is not as experimentally accessible as bosonic linear optics. For this reason, we now ask whether it is possible to achieve a fermionic cost landscape of Eq. (18) with photonics. The key feature of a fermionic cost landscape is that it contains a single harmonic at most per parameter, which is due to the fact the number operator generating the parametrised phase shifters has only two distinct eigenvalues. For this reason, we replace the number operator with an operator \hat{q} diagonal in the number basis with only two distinct eigenvalues $a, b \in \mathbb{R}$. This defines a *dual-valued phase shifter* (DVPS) as $U_{\text{DVPS}}(x) := \exp(i\hat{q}x)$ whose action is given by

$$U_{\text{DVPS}}(x)|n\rangle = e^{iq(n)x}|n\rangle, \quad (21)$$

where $q : \mathbb{N} \rightarrow \{a, b\}$. Unlike a standard phase shifter, the DVPS is a non-linear device and cannot be constructed deterministically with linear optics. For this reason, the boson sampler using these is a non-linear boson sampler [69]. It is simple to show that this will result in a fermionic cost landscape with a frequency of $\omega = |a - b|$. We now discuss three potential ways to realise this with experiments.

B. Deterministic design with non-linear optics

One choice for the generator of the DVPS in Eq. (21) is given by $\hat{q} = \frac{1}{2}(1 - \hat{\pi})$, where $\hat{\pi} = \exp(i\pi\hat{n})$ is the number parity operator which is equivalent to a π -phase shifter. This operator has two distinct eigenvalues of $q(n) \in \{0, 1\}$, where

$$q(n) = \frac{1}{2}(1 - (-1)^n). \quad (22)$$

This will yield the fermionic cost landscape of Eq. (18) with a unit frequency.

Implementing this directly with optical elements would be impossible in practice as this unitary requires tuneable non-linear interactions. This is because the generator \hat{q} , which plays the role of the Hamiltonian of this device, is expanded out explicitly as

$$\hat{q} = \frac{1}{2} \sum_{m=1}^{\infty} \frac{(-1)^{m+1} (\pi\hat{n})^{2m}}{(2m)!}, \quad (23)$$

which contains high-order interaction terms.

To circumvent this we off-load the tuneable parts of the device to linear components that we can control. We construct the circuit as shown in Fig. 4(a), consisting of three modes: one logical mode carrying the input and output state, and two ancillary modes. We have a single phase shifter of phase $x/2$, one tuneable beamsplitter with parameter x described by the unitary

$$u(x) = \begin{pmatrix} \cos \frac{x}{2} & -i \sin \frac{x}{2} \\ -i \sin \frac{x}{2} & \cos \frac{x}{2} \end{pmatrix}, \quad (24)$$

and one 50:50 beamsplitter using the Hadamard convention. We also have a cross Kerr non-linearity between the second and third modes as $U_K = \exp(i\pi\hat{n}_2\hat{n}_3)$ with a magnitude of π . If we take the input states of the logical mode and ancillary modes to be $|\psi_{\text{in}}\rangle = |n\rangle$ and $|1, 0\rangle$ respectively, and perform a projective measurement on the ancillary modes, then the output of the logical mode is given by

$$|\psi_{\text{out}}\rangle = \begin{cases} e^{iq(n)x}|n\rangle & \text{Ancillary} = |1, 0\rangle \\ e^{-iq(n)x}|n\rangle & \text{Ancillary} = |0, 1\rangle \end{cases}, \quad (25)$$

where each output has a probability of 1/2 (see appendix C 1). If we measure $|1, 0\rangle$ then the gate is a success as it implements the desired phase, therefore this gate is

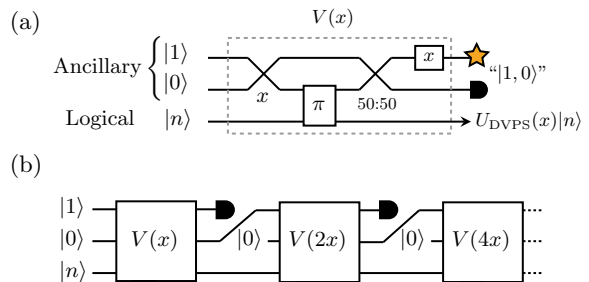

FIG. 4. (a) A non-deterministic DVPS consists of one logical mode and two ancillary modes. The logical mode interacts with the lower ancillary mode via a cross-Kerr non-linearity of π , shown by the square. The ancillary modes interact amongst themselves with a phase shifter of phase $x/2$, a tuneable beamsplitter of angle $x \in [0, 2\pi)$, and a second 50:50 beamsplitter. The success of the gate is heralded by the ancillary output state of $|1, 0\rangle$. This gate has a success rate of 1/2. (b) If the non-deterministic gate fails, as heralded by no photon in the upper ancillary mode, then the ancillary photon exits the lower ancillary mode and is rerouted into the input of a second iteration of the non-deterministic gate with double the parameter. We repeat until success.

currently non-deterministic with a probability of success of 1/2.

This non-deterministic gate can be upgraded to an asymptotically deterministic gate by repeating until success. From Eq. (25), we see that if the ancillary photon is measured in the state $|0, 1\rangle$ then the gate has failed and the phase applied to the logical mode is the complex conjugate of what we want. We correct this by using the martingale strategy¹ by feeding the failed output into the input of a second DVPS whose phase is $2x$ instead. If the second attempt succeeds then it will correct the incorrect phase of the previous failed attempt to give us the correct output. In general, if we repeat this process m times the phase of the m th DVPS is $x_m = 2^{m-1}x \text{ mod } 2\pi$. The probability of success after m attempts is given by $1 - 1/2^m$ which is asymptotically deterministic. For example, $m = 7$ repeats gives a success probability of 99.2%. In Fig. 4(b) we provide a photonic circuit that performs this feedforward process automatically without need of a classical computer: if the gate is a success the ancillary photon is consumed and the remaining gates reduce to the identity as the Kerr interaction does not activate; whereas if the gate fails the ancillary photon is automatically routed into the next attempt.

¹ The martingale strategy is a gambling strategy for betting on a game with two outcomes, where the player doubles their bet after each loss until an eventual win recovers all previous losses. For example when betting on red or black in roulette. Overall profit is guaranteed only if the player has infinite wealth and there is no upper limit to the allowed bets (and if the casino doesn't ask you to leave!)

C. Non-deterministic design with linear optics

The design introduced in the previous section requires strong non-linearities rendering it infeasible with today's technology which motivates us to search for a realisation with linear optics alone. By using measurement-induced non-linearities [70–74] we can achieve such at the expense of it becoming non-deterministic.

To implement a DVPS acting on the subspace of at most N photons, we introduce $N + 1$ modes where the first mode is the logical mode and the remaining N modes are ancillary modes. We interfere these modes with an $(N + 1)$ -mode linear optical interferometer encoding a unitary $u \in U(N + 1)$. Let us prepare the logical mode in the most general state

$$|\psi_{\text{in}}\rangle = \sum_{n=0}^N c_n |n\rangle, \quad (26)$$

where $|n\rangle$ is the state of n photons, and let us prepare the N ancillary modes in the number state $|\mathbf{a}\rangle = |a_1, a_2, \dots, a_N\rangle$, where $a_i \in \{0, 1\}$. If we insert the total state $|\psi_{\text{in}}\rangle|\mathbf{a}\rangle$ into the interferometer and project the output ancillary modes onto the state $|\mathbf{a}\rangle$, as shown in Fig. 5(a), then the (unnormalised) state of the logical mode is

$$|\psi_{\text{out}}\rangle = \sum_{n=0}^N \frac{c_n}{n!} \text{per}(u[\mathbf{v}_n|\mathbf{v}_n])|n\rangle, \quad (27)$$

where we used the transition amplitude of Eq. (2) and $\mathbf{v}_n = (n, a_1, \dots, a_N)$. This output state will in general be equal to a non-linear transformation applied to the input state, see appendix C 2. The success probability of this transformation is $p = |\langle\psi_{\text{out}}|\psi_{\text{out}}\rangle|^2$.

For this operation to give us the action of a DVPS, comparing Eqs. (21) and (27) implies that for each $x \in [0, 2\pi)$ we must solve for the matrix $u_x \in U(N + 1)$ that obeys

$$\frac{1}{n!} \text{per}(u_x[\mathbf{v}_n|\mathbf{v}_n]) = \sqrt{p_x} e^{i\alpha_x} e^{iq(n)x}, \quad (28)$$

for all $n = 0, 1, \dots, N$, where $p_x \in [0, 1]$ is the success probability of this non-deterministic gate, α_x is a global phase, and $q(n)$ is chosen to be Eq. (22). Solving this is a formidable task, so numerical methods can be employed such as given in Refs. [71, 75–77] and appendix C 2.

As an example let us encode a non-deterministic DVPS on the subspace of at most $N = 2$ photons. Following the recipe above, for each x this requires us to introduce a three-mode linear interferometer encoding a unitary $u_x \in U(3)$ that solves Eq. (28) and postselect on the outputs of the ancillary modes. In Ref. [70] it was shown that there are infinitely many unitary solutions to this and the goal is to find the one maximising p_x . For this particular subspace, this is bounded from above as $p_x \leq 1/4$ [71, 73]. Note that on this subspace this gate is

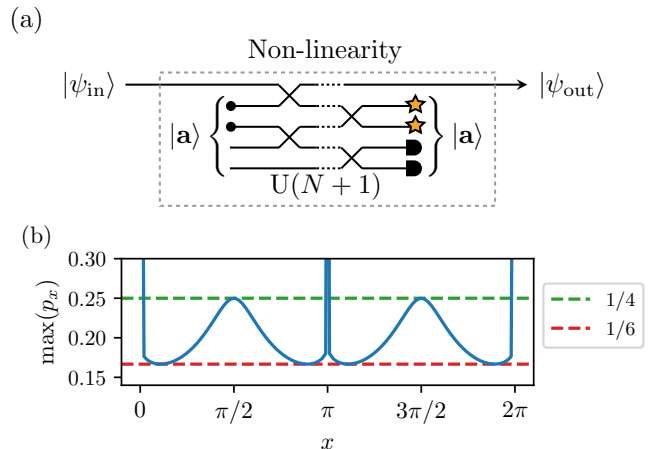

FIG. 5. (a) A measurement-induced non-linear mapping $|\psi_{\text{in}}\rangle \mapsto |\psi_{\text{out}}\rangle$ is obtained by interfering the input state with an ancillary state $|\mathbf{a}\rangle$ in an $(N + 1)$ -mode linear interferometer and postselecting on the ancillary output. (b) The maximum probability of the non-deterministic dual-valued phase shifter obtained by solving Eq. (28) for the subspace of at most two photons. This uses the circuit of (a) with $N = 2$ ancillary modes and $|\mathbf{a}\rangle = |1, 0\rangle$. For $x = 0, \pi$ and 2π , $\max(p_x) = 1$.

closely related to the non-linear sign (NS) gate [46, 79] that is a well-known non-linear phase shifter, used for constructing CNOT gates, defined via

$$U_{\text{NS}} : \alpha|0\rangle + \beta|1\rangle + \gamma|2\rangle \mapsto \alpha|0\rangle + \beta|1\rangle - \gamma|2\rangle. \quad (29)$$

The relationship between the NS gate and the DVPS is given by $U_{\text{NS}} = U_{\text{PS}}(\pi/2)U_{\text{DVPS}}(3\pi/2)$, where U_{PS} is a standard phase shifter. Just like the NS gate, we can find a realisation of the DVPS with a single ancillary photon, so we take the ancillary state $|\mathbf{a}\rangle = |1, 0\rangle$.

In Fig. 5(b) we present the maximum value of p_x by solving Eq. (28) numerically for $x \in [0, 2\pi)$. For $x \equiv 0, \pi \pmod{2\pi}$ the probability is unity because for these values the DVPS is the identity and a π -phase shifter respectively, which are both deterministic gates with linear optics. For all other values of x we see that the probability depends upon x and is bounded as $1/6 \leq p_x \leq 1/4$. See appendix C 2 for details on numerics, a set of solution unitaries, and the effect of different ancillary states.

D. Photonic fermion sampling

The use of measurement-induced DVPSs of the previous section will be impractical for large interferometers, as each phase shifter is non-deterministic and requires the same number of ancillary modes as input photons. Instead, let us try to directly simulate fermion sampling.

As a linear fermion sampler is equivalent to time evolution under a non-interacting and particle-conserving fermionic Hamiltonian, this can be simulated with qubits

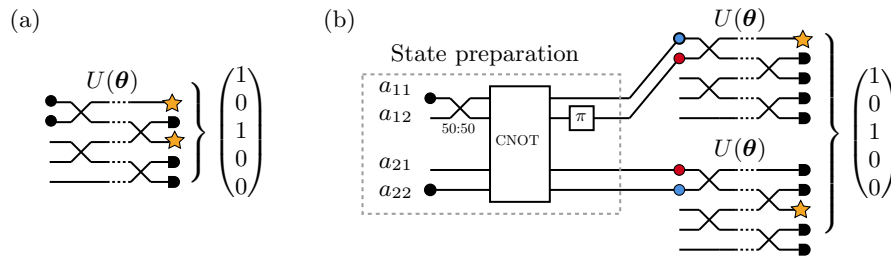

FIG. 6. (a) A fermion sampling experiment with two input fermions in the state $|\psi_F\rangle = a_1^\dagger a_2^\dagger |0\rangle$, represented by the solid circles, passed into a linear interferometer encoding some unitary. The clicks of the detectors map to a bit string. (b) The photonic simulation of this consists of a state preparation that transforms the state $a_1^\dagger a_2^\dagger |0\rangle$, shown by the solid circles, into the entangled state $|\psi_B\rangle = \frac{1}{\sqrt{2}}(a_{11}^\dagger a_{22}^\dagger - a_{12}^\dagger a_{21}^\dagger)|0\rangle$, where each pair of like-coloured circles represents a term in the superposition. The CNOT gate is constructed from linear optics using the unheralded design of Ref. [78] which has a success probability of $1/9$. This is then inserted into a pair of identical interferometers encoding the same unitary. The superimposed detector click distribution of both interferometers gives rise to the output bit string.

via a Jordan-Wigner transformation. The particle-conserving unitaries are equivalent to Givens rotations on the subspace of fixed Hamming weight and circuits exist for this [34, 80–82], allowing simulation of fermion sampling. Additionally, one could simulate fermion sampling with cold atoms in optical lattices [83, 84] by interpreting each column of an interferometer as one time step of nearest-neighbour hoppings.

To provide a concrete realisation of fermion sampling with photonic linear optics, we use the method from Ref. [85]. We simulate n fermions in an N -mode interferometer encoding a given unitary by first introducing n identical copies of this interferometer. This system is described by a set of bosonic ladder operators $a_{\mu i}$ with two indices, where the ordered pair (μ, i) indexes the i th mode of the μ th interferometer. These obey the bosonic algebra $[a_{\mu i}, a_{\nu j}^\dagger] = \delta_{\mu\nu} \delta_{ij}$ and $[a_{\mu i}, a_{\nu j}] = [a_{\mu i}^\dagger, a_{\nu j}^\dagger] = 0$. Then we construct the resource state

$$|\psi_{\text{in}}\rangle = \frac{1}{\sqrt{n!}} \sum_{\sigma \in S_n} (-1)^\sigma \prod_{\mu=1}^n a_{\mu\sigma(\mu)}^\dagger |0\rangle, \quad (30)$$

where S_n is the permutation group of n elements. This is an entangled n -photon state, where each photon is inserted into its own interferometer, and is anti-symmetric upon exchange of any two photons' mode degree of freedom, hence the set of states of this form is isomorphic to the space $\wedge^n(\mathbb{C}^N)$. This state is a representation of the state of the first n modes of a *single* interferometer occupied with a fermion. Note that the complexity of this state scales with the number of particles, n , and not the number of modes, N . With linear optics alone, the success probability of producing this ansatz is upper bounded by $1/9$ as will be shown momentarily.

The way we sample bit strings from this system is slightly different. As each interferometer contains a single photon, upon measurement each one returns an N -bit string with a unit Hamming weight. Due to the anti-symmetric property of the state, no two interferometers will return the same bit string. We construct a new bit

string from these by summing them into a single N -bit string of Hamming weight n .

The probability to measure the output superimposed bit string \mathbf{m} given the input state had the superimposed bit string \mathbf{n} is given by

$$p(\mathbf{m}|\mathbf{n}) = |\det u[\mathbf{m}|\mathbf{n}]|^2, \quad (31)$$

where $u \in U(N)$ is the unitary programmed into the interferometers. This probability displays fermionic statistics as it agrees precisely with the determinant of Eq. (2). When we simulate fermions using photons we refer to this as *photonic fermion sampling* to contrast with fermion sampling with actual fermions. As the exchange anti-symmetry of the resource state of Eq. (30) is what simulates fermionic behaviour, the set of interferometers must always encode identical unitaries otherwise this breaks down. In Appendix A 3 we provide a proof of the transition amplitude.

As an example let us consider the case of simulating two fermions. From Eq. (30) the required photonic resource state is given by

$$|\psi\rangle = \frac{1}{\sqrt{2}} (a_{11}^\dagger a_{22}^\dagger - a_{12}^\dagger a_{21}^\dagger) |0\rangle. \quad (32)$$

This represents state of a fermion sampler with the first two modes occupied, as shown in Fig. 6(a), and is equivalent to the Bell state $|\Psi^-\rangle$ if we use the dual-rail encoding of photonic qubits. In Fig. 6(b) we show how to prepare this state non-deterministically using linear optics alone which uses a circuit consisting of a 50:50 beamsplitter using the Hadamard convention, a CNOT gate, and a π phase shifter. The CNOT gate is either the heralded [46] or the unheralded [78] version, working with a probability of $1/16$ and $1/9$ respectively. We opt for the latter as it has the benefit of both a higher success rate and no requirement for ancillary photons. As it is unheralded, we simply need to postselect on there being a single photon per interferometer to see the fermionic statistics. For this reason, the success probability of preparing Eq. (30) for $n > 1$ with linear optics alone is upper

Method	Modes	Particles	p_{ansatz}	p_{gate}
NL	$N(1 + (1 + m)N)$	$N^2 + n$	1	$1 - 1/2^m$
L	$N(1 + nN)$	$N^2n + n$	1	$\leq 1/n^2$
FS	N	n	1	1
PFS	$Nn + O(n^4)$	$n + O(n^4)$	$\leq 1/9$	1

TABLE I. The resources for simulating a sampling experiment of n particles in an N -mode universal interferometer consisting of N^2 phase shifters when we use the non-linear DVPS with m repeats (NL), measurement-induced linear DVPS (L), fermion sampling (FS) and photonic fermion sampling (PFS) For each case, we list how many modes the interferometer requires, the number of particles (both logical and ancillary) required, the success probability to generate the ansatz, and the success probability for each parametrised phase shifter.

bounded by $1/9$ as at least one CNOT is required. Note that this two-fermion example can also be done by entangling the polarisation degree of freedom instead [86].

In addition to resulting in a simpler cost landscape, fermion sampling has two useful features. The first is that no many-to-one mapping is required to map the outputs to bit strings as multi-occupation states are forbidden. This removes the redundancy that bosonic linear optics suffers from as every output state is distinguishable even after threshold detection. The second is that the output states have a fixed Hamming weight and this will aid in solving Hamming-constrained QUBO problems to be seen in Sec. IV B. Additionally, it has been argued that Hamming-constrained systems can help to minimise the barren plateau problem [87–89].

Note that one could obtain fixed Hamming weight bit strings from a standard boson sampler by postselecting these outputs and discarding the rest, however the cost function will still take the general bosonic form and will not yield the simplified fermion cost landscape. This is because the Fourier modes of the cost landscape are determined by how many photons pass through each phase shifter of the interferometer, which can be greater than one for standard bosonic linear optics, and postselection on Hamming weight will not change this.

E. Resources of the three designs

We conclude this section with a comparison of the resources of the three methods of presented in Secs. III B, III C and III D for conducting a sampling experiment, which are shown in Table I. For each method, we consider sampling from an N -mode universal interferometer, which contains N^2 phase shifters [43, 44], with n input particles. The phase shifters are either standard or DVPS depending upon the method of choice. We additionally make two key assumptions. First, we assume that single-occupation number state inputs can be created deterministically for both fermionic and bosonic statis-

tics; and second we assume that the physical hardware of each circuit, such as beamsplitters, standard phase shifters (not DVPS) and Kerr non-linearities, operate deterministically—the non-determinism of any method arises from preparing the input ansatz or the measurement and postselection. In

First, the non-linear DVPS of Sec. III B. The input states are simple number states so are deterministically prepared. Each gate requires two ancillary modes and one ancillary photon, however if the gate is repeated m times in the repeat-until-success protocol we require $1 + m$ ancillary modes, so the entire interferometer requires $(1 + m)N^2$ ancillary modes, N logical modes, N^2 ancillary photons, and n logical photons. Each phase shifter operates with a success probability of $1 - 1/2^m$. However, this relies upon a strong cross Kerr non-linearity which makes this infeasible with photonics today.

Second, the linear DVPS of Sec. III C. The input states for this system are also simple number states so are deterministically prepared. Each gate requires n ancillary modes with n ancillary photons in general (see Appendix C 2) where each gate must be a universal interferometer itself in order to encode any unitary required. This gives a total of N^2n ancillary modes, N logical modes, N^2n ancillary photons and n logical photons. The DVPS fall into the class of generalised NS gates and these have a success probability of at most $1/n^2$ [73].

Finally, if we perform fermion sampling of Sec. III D with, say cold atoms in an optical lattice, then this system has no ancillary modes, and each gate is deterministic as only standard phase shifters are required. On the other hand, if we were to perform photonic fermion sampling we require n copies of the interferometer giving us Nn modes in total. Simulating n fermions also requires a state preparation stage with $O(n^4)$ controlled swap gates [85]. With linear optics alone, this is non-deterministic and requires $O(n^4)$ ancillary photons and $O(n^4)$ ancillary modes. The probability of success of state preparation is at most $1/9$ (see Sec III D) however each phase shifter in the interferometer works deterministically as they are linear

We see that both realisations of fermion sampling scale the best out of the methods presented. Whilst the non-linear DVPS is promising, it requires infeasible non-linearities. As we are interested in photonic linear optics, one would opt for photonic fermion sampling as it scales better than the DVPS for large problems because each gate is deterministic and the total number of photons required is independent of N , allowing for very large N systems to be constructed at relatively low cost.

IV. RESULTS

A. Cost landscapes

In this section we numerically test the cost landscapes that can be achieved using the three methods of bo-

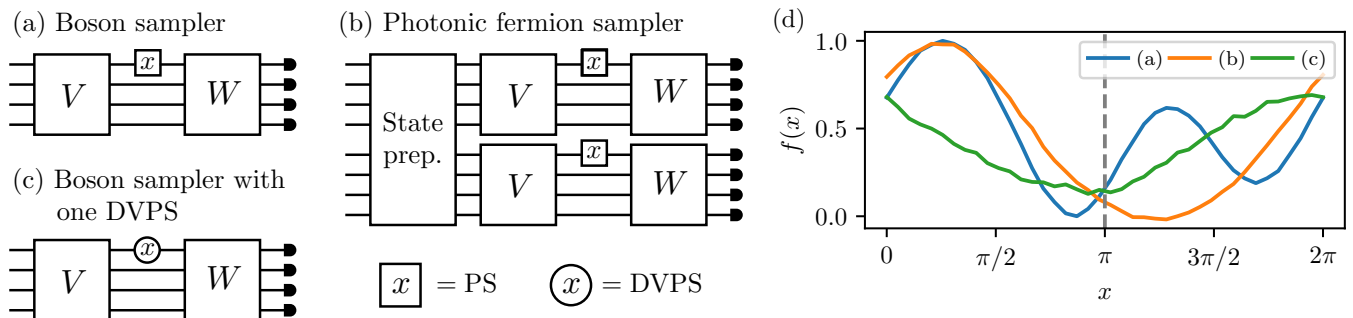

FIG. 7. (a) The boson sampler is an N -mode interferometer constructed from a single phase shifter (PS) of phase x sandwiched between two fixed linear unitaries. (b) The photonic fermion sampler simulating n fermions is an nN -mode interferometer consisting of an entangling state preparation state (shown in Fig. 6) followed by n identical copies of the boson sampler. For this particular example, $n = 2$. (c) The bosonic DVPS sampling experiment has the same hardware as the boson sampler, except the parametrised phase shifter has been replaced with a DVPS. (d) The numerical simulation of the cost landscapes for the three cases in (a)-(c) as we vary x with the input states $|\psi_{\text{in}}\rangle = |1100\rangle$ for the bosonic cases, and the two-photon entangled state from Eq. (30) for the fermionic case, which represents the fermionic state $|\psi_{\text{in}}\rangle = |1100\rangle$. The same observable H and fixed linear unitaries V and W were chosen for each case. The boson sampler produces two harmonics as expected, as it contains two photons. This reduces to a single harmonic if a photonic fermion sampler or DVPS is used instead which removes the local minimum. Numerical simulation parameters were taken to be 10^6 shots per x , purity of 0.9, indistinguishability of 0.95, brightness of 0.5 (equivalently loss of 0.5), dark counts rate of 5×10^{-6} and threshold detection with efficiency of 0.9.

son sampling of Sec. II A, the non-deterministic DVPS of Sec. III C, and photonic fermion sampling of Sec. III D. All three methods can be implemented today with linear optics, single photon sources and threshold detectors.

For each method, we insert two photons into an N -mode linear interferometer encoding the parametrised unitary $WU(x)V$, where V and W are two randomly-chosen linear unitaries that are held fixed and $U(x)$ is either a parametrised phase shifter or DVPS depending on which of the three methods we choose. The circuits of these three methods are shown in Figs. 7(a)-(c). If the DVPS is used, then for each x the DVPS equation of Eq. (28) must be solved numerically beforehand to find the required unitaries to encode. See table II of appendix C 2 for some example solutions. Without loss of generality, we choose an observable H for the cost function that is diagonal in the number basis with eigenvalues chosen randomly, which is equivalent to assigning a randomly-chosen cost to each possible output bit string.

We numerically simulate these three methods using the Python package Lightworks [62] which takes into account realistic effects of finite sampling, photon purity, photon indistinguishability, photon source brightness, photon losses, threshold detection, detector dark counts and detector efficiency. In Fig. 7(d) we compare the cost landscape as we sweep over the phase x for the three methods. The cost function for boson sampling has two harmonics due to the presence of two photons, as predicted by Eq. (15), giving rise to a local minimum. If a DVPS or photonic fermion sampling is used instead, the cost function has a single harmonic as predicted by Eq. (18) which removes this local minimum. Note that the cost function of the DVPS and phase shifter agree at integer

multiples of π as they are equivalent unitaries for these values. In Sec. III D we show how to prepare the two-fermion resource state and in appendix C 2 we show how to construct the non-deterministic DVPS.

B. Application to constrained and unconstrained QUBO problems

Using dual-valued phase shifters as our parametrised unitaries instead of phase shifters simplifies the cost landscape considerably. In this section we assess the consequences of this for variational quantum algorithms using gradient descent and Rotosolve as their optimisers.

In order to simulate a DVPS, we opt for fermion sampling of Sec. III D as it displays the desired features whilst being numerically efficient to simulate. Any discrete variable linear optics simulator can be modified to simulate fermion sampling by replacing the permanent with the determinant when calculating transition amplitudes in Eq. (2) allowing us to simulate large systems. From this point onwards we will be comparing the performance of boson sampling and fermion sampling and all simulations were conducted using the fermion sampler of Lightworks [62].

We first test this for solving Hamming constrained QUBO problems. This constraint can be imposed by modifying the cost function of Eq. (4) with a penalty term as

$$C_w(\mathbf{x}) = C(\mathbf{x}) + \lambda \left(w - \sum_{i=1}^N x_i \right)^2, \quad (33)$$

where λ is a Lagrange multiplier and w is the Hamming

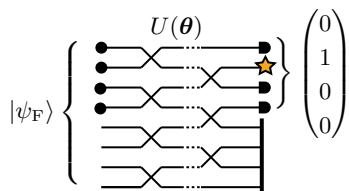

FIG. 8. All possible N -bit strings are generated by inserting N fermions into a $2N$ -mode linear optical interferometer in the state $|\psi_F\rangle$, represented by the black circles, and measuring only the top N modes. In order to perform this with photonic fermion sampling, we must introduce N copies of the interferometer as discussed in Sec. III D and shown in Fig. 6

constraint. As the outputs of a fermion sampler have a fixed Hamming weight, this will aid the optimiser as all outputs obey the constraint. One could argue that for an N -mode interferometer with n bosons, where $N \gg n^2$, the bosonic birthday paradox will come to our aid as the chance of multiply-occupied modes at the outputs is low, so most outputs of a boson sampler will have a fixed Hamming weight anyway [48, 55]. However, for some problems w , and hence n , may be on the order of N so this will not apply. Examples problems include the portfolio optimisation problem [82] and the travelling salesman problem [4]. In these cases, removing redundancy with a fermion sampler is desirable.

In Fig. 9(a) we present the cost function over time for a random constrained QUBO problem with these three methods, where gradient descent uses the update rule $\theta \rightarrow \theta - h\nabla E(\theta)$ with $h = 0.05$. This value of the learning rate h was chosen as the algorithm diverged for larger values. Gradients were evaluated using the parameter shift rules of Eqs. (16) and (19). We see how effective Rotosolve is compared to gradient descent, as for this particular example with a solution space of 56 solutions (8-bit strings with Hamming weight 3), it finds the minimum in just two steps, where we define a step as a parameter update for either Rotosolve or gradient descent.

In Fig. 9(c) we compared the average number of cost function evaluations for solving problems of various sizes N with the Hamming constraint of $w = \lfloor N/2 \rfloor$ for the three methods. Each time, the QUBO matrix was generated by randomly sampling integer elements and we took $\lambda = 2 \max\{Q_{ij}\}$. Fermion sampling is seen to outperform boson sampling when using gradient descent and gains a further speed-up when using Rotosolve.

We can also use a fermion sampler to solve unconstrained problems for which $\lambda = 0$ in Eq. (33). To generate all possible N -bit strings with a fermion sampler, we introduce an interferometer with $2N$ modes but measure only the top half, as shown in Fig. 8. In order to compare boson and fermion sampling, we use a $2N$ -mode interferometer for boson sampling of the form in Fig. 8 as well. This means that both the fermion and boson sampler have precisely the same hardware, allowing for a

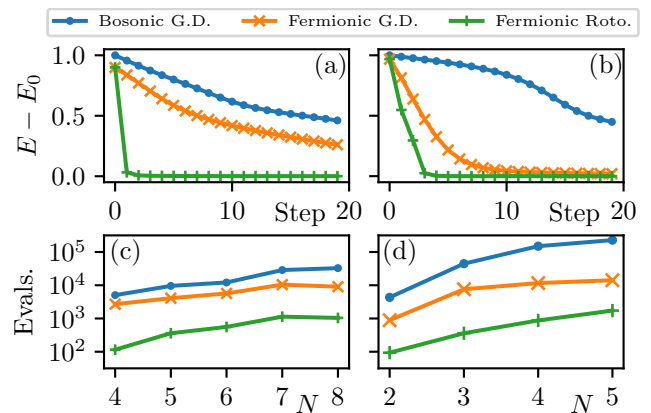

FIG. 9. (a) The cost function over time for a random QUBO problem of size $N = 8$ with Hamming constraint $w = 3$. The choice of algorithm was either boson sampling with gradient descent, fermion sampling with gradient descent, or fermion sampling with Rotosolve. Each method had the same initial variational parameters and was simulated using exact wavefunctions. All data was normalised to the initial value of the bosonic case. (b) The same test for a random unconstrained problem of size $N = 4$. (c) The average number of cost function evaluations before termination for five random Hamming constrained QUBO problems with Hamming constraint $w = \lfloor N/2 \rfloor$ vs. the problem size N . For each N the number of input particles was w . (d) The same test but for unconstrained problems. For each N the number of input particles was $n = N$. For both fermions and bosons we used a $2N$ mode interferometer and measured only the top N modes as shown in Fig. 8.

direct comparison that reveals the effects of the particles' statistics alone.

In Fig. 9(b) we present the cost function over time for a random unconstrained QUBO problem with the same three methods as before, and in Fig. 9(d) we compare the number of cost function evaluations as the problem scales. We see that fermion sampling outperforms boson sampling for solving unconstrained QUBO problems as it is able to exploit the simple cost landscape to gain an advantage, with Rotosolve giving the further speedup over gradient descent.

In both tests, we see a decent improvement when using fermion sampling with gradient descent, which is to be expected as the barren plateau scaling of fermion sampling is better, but only modestly. However, the significant speedup is obtained when we use Rotosolve, exploiting the simple cost landscape.

Benchmarking the performance of variational quantum algorithms is difficult due to their heuristic nature and the inability to gauge the time scaling analytically. Additionally, direct comparison with classical algorithms for solving the same problems could be difficult as they may perform in completely different ways. However, here we have indirectly proposed a classical variational algorithm which can be directly compared with the original boson sampling variational quantum algorithm. This is because

fermion and boson samplers operate in precisely the same way, with the same hardware, ansatzes, and classical optimisers, except that fermion sampling is classically efficient to simulate. This implies the existence a classical algorithm that outperforms the best-known boson sampling quantum variational algorithm, and for this reason the quantum advantage of boson sampling does not result in a *practical* quantum advantage for these algorithms.

C. Rotosolve for boson sampling

Rotosolve is an effective algorithm for minimising sinusoidal cost functions because there is an analytical expression for the unique minimum given just three samples of the cost function. This algorithm can be generalised to handle bosonic cost functions with multiple harmonics like Eq. (15) and is based upon trigonometric interpolation, see Refs. [40, 90] and Appendix B 2. This follows a similar route to Rotosolve in Algorithm 1, except that the update rule requires solving for the set of stationary points of the cost function and choosing the one with the lowest cost. As with evaluating the gradient, however, this does not scale well because for each iteration of the algorithm we need to sample the cost function $2n + 1$ times for an n -photon bosonic cost landscape, solve for the roots of a polynomial and sort through these to find the one corresponding to the minimum. We ask whether we can avoid this.

Consider an observable of the form

$$H = \prod_{i=1}^N \hat{n}_i^{p_i}, \quad (34)$$

where $p_i \in \mathbb{N}$ and $\hat{n}_i = a_i^\dagger a_i$ is the number operator for the i th mode. It was shown that the maximum number of harmonics in the bosonic cost function generated by this observable is given by $R = \min\{p, n\}$, where $p = \sum_i p_i$ and n is the number of bosons inserted into the interferometer [64]. This result implies certain observables will have a simpler cost function, allowing for a more efficient evaluation of the gradient as only the first $2R$ terms of the generalised parameter shift rule in Eq. (16) are required. For some observables $R = 1$ and we can apply Rotosolve even if the system is bosonic. Unfortunately, the QUBO Hamiltonian of Eq. (5) has $R = n$ giving rise to the maximum number of harmonics in general for a given number of photons. This can be seen because on the subspace of at most n photons, we can use polynomial interpolation to represent the threshold operator $\Theta(\hat{n})$ as a polynomial of degree n in the number operator (see appendix C 2) as

$$\Theta(\hat{n}) \equiv \sum_{k=0}^n c_k \hat{n}^k. \quad (35)$$

For example, if $n = 3$ then we can write $\Theta(\hat{n}) \equiv \frac{1}{6}\hat{n}(\hat{n}^2 - 6\hat{n} + 11)$. Therefore, if we have n photons in our interferometer then each quadratic term of the QUBO

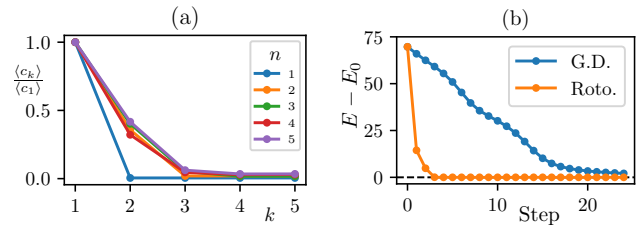

FIG. 10. (a) The ratio of the average Fourier coefficients $\langle c_k \rangle / \langle c_1 \rangle$ of the bosonic cost landscape of Eq. (15) for 20 randomly-chosen QUBO problems of size $N = 6$ for different boson numbers n . (b) An example of the cost function of a boson sampler over time using gradient descent (G.D.) or Rotosolve for a randomly-chosen QUBO problem of size $N = 6$ and $n = 4$ bosons.

Hamiltonian will contribute a term of the form of Eq. (34) with $p = 2n$, so $R = n$.

Despite this, it is seen numerically that the Fourier spectrum of the bosonic cost landscape for QUBO problems remains peaked around low frequencies, even as we scale up n . In Fig. 10(a) we show the average magnitude of the Fourier coefficients of the cost function for 20 randomly chosen QUBO Hamiltonians versus the number of bosons in the system. We sample random symmetric QUBO matrices with integer matrix elements in the range $[-10, 10]$ to insert into the cost function of Eq. (4). The first harmonic is the dominant term, whilst the magnitude of the higher-order harmonics dies off quickly, even as we increase the number of bosons n in the system. This suggests that Rotosolve, despite being designed for sinusoidal cost functions only, may work approximately for solving QUBO problems with boson sampling as the error will be small.

In Fig. 10(b) we give an example of optimising the cost function for a QUBO problem size $N = 6$ with $n = 4$ photons inserted into a boson sampler. Despite having up to four harmonics, Rotosolve finds the minimum in a few steps compared to gradient descent which takes far longer. The improvement in performance over gradient descent is significant and could give boson sampling a faster and gradient-free way to get an approximate solution.

V. CONCLUSION AND DISCUSSION

A key result of this paper was to investigate under what conditions we expect to see barren plateaus in linear optics, by providing both exact analytic results and numerics to confirm this. As we are free to vary the size of the interferometer and the number of particles independently, we do not always expect to see barren plateaus when scaling these variables. However, when both the number of modes and particles scales together, which is what one would typically define scaling up a lin-

ear optical quantum computer to mean, we do indeed see barren plateau scaling for both bosonic and fermionic linear optics, however the barren plateau decay for bosonic statistics is orders of magnitude faster than for fermionic statistics, implying that fermionic statistics is less susceptible.

Despite this, fermionic linear optics has some desirable features. Namely, a cost landscape which contains only a single harmonic in each parameter direction regardless of the size of the problem. This comes from the fact that fermionic phase shifters have only two distinct eigenvalues. Motivated by this, we have shown that one can gain a significant improvement in the performance of photonic variational quantum algorithms by replacing each parametrised phase shifter of a linear optical interferometer with a non-linear phase shifter, the dual-valued phase shifter (DVPS), which has two distinct eigenvalues. We provided three ways to construct this phase shifter, either by using non-linearities directly, measurement-induced non-linearities, or simulating fermion sampling with an entangled photonic resource state. The latter two designs require linear optics alone, allowing them to be constructed today. This allows one to exploit the benefits of fermionic cost landscapes using widely-available photonic linear optics.

We showed that this results in a simpler cost landscape with fewer local minima in a way that is independent of the choice of input state ansatzes, circuit layout, and the observable to minimise. Additionally, we showed that this allows us to bypass gradient descent entirely by using the gradient-free Rotosolve algorithm which has not been applied to interferometric systems until now. This results in a significant speed-up over the best known interferometer-based photonic variational quantum algorithms and gains this advantage by exploiting quantum effects alone with no classical preprocessing. As a by-product of this, it implies that the quantum advantage of boson sampling does not result in a practical quantum advantage for solving problems with variational quantum algorithms, as it is outperformed by fermion sampling which is classically efficient to simulate.

We conclude with three interesting directions of further investigation. First, the advantage of our method is the ability to mould the cost landscape into something less barren in a way that is independent of the problem, ansatz or circuit design. This work applies to interferometric systems whose parametrised unitaries are phase shifters, but whether this can be generalised to systems whose parametrised unitaries are more gen-

eral, such as those found in other variational algorithms such as QAOA [66, 91], the variational quantum eigensolver [18, 67] or quantum machine learning [92], remains an open question.

Secondly, in section II B we derived the barren plateau scaling of linear optics, but omitted an analytic derivation for linear optics with dual-valued phase shifters. If we extend linear optics to include these non-linear phase shifters, then the set of generators of the system is extended. In this work we derived the barren plateau scaling using the representation theory of $U(N)$ by focussing on the Lie group only, as this was sufficient to get exact results. However, tackling the non-linear DVPS may require us to use Lie algebraic methods by looking at the dynamical Lie algebra instead, which is an alternative way to study the barren plateau problem [59, 60]. This may be more fruitful for this endeavour as we are looking at non-Gaussian unitaries.

Third, whilst we have shown that sampling bit strings from a boson sampler for the purpose of variational quantum algorithms does not have a practical advantage, it still has its $\#P$ quantum advantage for sampling alone. Whether a boson sampler with all its phase shifters replaced by DVPSs retains this quantum advantage is unknown. This non-linear boson sampler reduces the number of barren plateaus and it is strongly believed that there is a link between a lack of barren plateaus and classical simulability [93]. If the quantum advantage of this non-linear boson sampler remains, then this could be a counter example to this. On the other hand, it has been shown that introducing non-linear elements into a boson sampler can increase its complexity [69]. We leave these open problems to future work.

ACKNOWLEDGMENTS

I thank Harry Bromley for helping me use Aegiq’s Lightworks Python SDK [62] for the numerical simulations of this work. I thank Callum W. Duncan for pointing out the two-eigenvalue generalisation beyond fermion sampling. I thank Pieter Kok for pointing out the martingale strategy to improve the non-linear DVPS and its link with the NS gate. Finally, I thank Scott Dufferwiel, Jiannis K. Pachos, Emma Heley, Alex Little, Maksym Sich and everyone mentioned above for valuable discussions.

[1] Marco Cerezo, Andrew Arrasmith, Ryan Babbush, Simon C Benjamin, Suguru Endo, Keisuke Fujii, Jarrod R McClean, Kosuke Mitarai, Xiao Yuan, Lukasz Cincio, et al. “Variational quantum algorithms”. *Nature Reviews Physics* **3**, 625–644 (2021).

[2] Amira Abbas, Andris Ambainis, Brandon Augustino, Andreas Bärtzsch, Harry Buhman, Carleton Coffrin, Giorgio Cortiana, Vedran Dunjko, Daniel J Egger, Bruce G Elmegreen, et al. “Challenges and opportunities in quantum optimization”. *Nature Reviews Physics* **Pages 1–18** (2024).

- [3] Andrew Lucas. “Ising formulations of many np problems”. *Frontiers in Physics* **2** (2014).
- [4] Siddharth Jain. “Solving the traveling salesman problem on the d-wave quantum computer”. *Frontiers in Physics* **9** (2021).
- [5] Sebastian Feld, Christoph Roch, Thomas Gabor, Christian Seidel, Florian Neukart, Isabella Galter, Wolfgang Mauere, and Claudia Linnhoff-Popien. “A Hybrid Solution Method for the Capacitated Vehicle Routing Problem Using a Quantum Annealer”. *Frontiers in ICT* **6**, 13 (2019).
- [6] Özlem Salehi, Adam Glos, and Jarosław Adam Miszczak. “Unconstrained binary models of the travelling salesman problem variants for quantum optimization”. *Quantum Information Processing* **21**, 67 (2022).
- [7] Arnab Das and Bikas K. Chakrabarti. “Colloquium: Quantum annealing and analog quantum computation”. *Rev. Mod. Phys.* **80**, 1061–1081 (2008).
- [8] Gary Kochenberger, Fred Glover, Bahram Alidaee, and Karen Lewis. “Using the unconstrained quadratic program to model and solve max 2-sat problems”. *International Journal of Operational Research* **1**, 89–100 (2005).
- [9] Vicky Choi. “Adiabatic quantum algorithms for the np-complete maximum-weight independent set, exact cover and 3sat problems” (2010). [arXiv:1004.2226](https://arxiv.org/abs/1004.2226).
- [10] Sebastian Zielinski, Jonas Nüßlein, Jonas Stein, Thomas Gabor, Claudia Linnhoff-Popien, and Sebastian Feld. “Pattern qubos: Algorithmic construction of 3sat-to-qubo transformations” (2023). [arXiv:2305.02659](https://arxiv.org/abs/2305.02659).
- [11] Zhengbing Bian, Fabian Chudak, William Macready, Aidan Roy, Roberto Sebastiani, and Stefano Varotti. “Solving sat (and maxsat) with a quantum annealer: Foundations, encodings, and preliminary results”. *Information and Computation* **275**, 104609 (2020).
- [12] Fred Glover, Gary Kochenberger, and Yu Du. “A tutorial on formulating and using qubo models” (2019). [arXiv:1811.11538](https://arxiv.org/abs/1811.11538).
- [13] Davide Venturelli, Dominic J. J. Marchand, and Galo Rojo. “Quantum annealing implementation of job-shop scheduling” (2016). [arXiv:1506.08479](https://arxiv.org/abs/1506.08479).
- [14] Marc Geitz, Cristian Grozea, Wolfgang Steigerwald, Robin Stöhr, and Armin Wolf. “Solving the extended job shop scheduling problem with agvs – classical and quantum approaches”. In Pierre Schaus, editor, *Integration of Constraint Programming, Artificial Intelligence, and Operations Research*. Pages 120–137. Cham (2022). Springer International Publishing.
- [15] Berend Denkena, Fritz Schinkel, Jonathan Pirnay, and Sören Wilmsmeier. “Quantum algorithms for process parallel flexible job shop scheduling”. *CIRP Journal of Manufacturing Science and Technology* **33**, 100–114 (2021).
- [16] Jarrod R McClean, Sergio Boixo, Vadim N Smelyanskiy, Ryan Babbush, and Hartmut Neven. “Barren plateaus in quantum neural network training landscapes”. *Nature communications* **9**, 4812 (2018).
- [17] Martin Larocca, Supanut Thanasilp, Samson Wang, Kunal Sharma, Jacob Biamonte, Patrick J Coles, Lukasz Cincio, Jarrod R McClean, Zoë Holmes, and Marco Cerezo. “Barren plateaus in variational quantum computing”. *Nature Reviews Physics* **7**, 174–189 (2025).
- [18] Jules Tilly, Hongxiang Chen, Shuxiang Cao, Dario Piccozzi, Kanav Setia, Ying Li, Edward Grant, Leonard Wossnig, Ivan Rungger, George H. Booth, and Jonathan Tennyson. “The variational quantum eigensolver: A review of methods and best practices”. *Physics Reports* **986**, 1–128 (2022).
- [19] Zoë Holmes, Kunal Sharma, M. Cerezo, and Patrick J. Coles. “Connecting ansatz expressibility to gradient magnitudes and barren plateaus”. *PRX Quantum* **3** (2022).
- [20] Harper R Grimsley, George S Barron, Edwin Barnes, Sophia E Economou, and Nicholas J Mayhall. “Adaptive, problem-tailored variational quantum eigensolver mitigates rough parameter landscapes and barren plateaus”. *npj Quantum Information* **9**, 19 (2023).
- [21] Kaito Wada, Rudy Raymond, Yuki Sato, and Hiroshi C Watanabe. “Sequential optimal selections of single-qubit gates in parameterized quantum circuits”. *Quantum Science and Technology* **9**, 035030 (2024).
- [22] Ho Lun Tang, V.O. Shkolnikov, George S. Barron, Harper R. Grimsley, Nicholas J. Mayhall, Edwin Barnes, and Sophia E. Economou. “Qubit-adapt-vqe: An adaptive algorithm for constructing hardware-efficient ansätze on a quantum processor”. *PRX Quantum* **2**, 020310 (2021).
- [23] Marco Cerezo, Akira Sone, Tyler Volkoff, Lukasz Cincio, and Patrick J Coles. “Cost function dependent barren plateaus in shallow parametrized quantum circuits”. *Nature communications* **12**, 1791 (2021).
- [24] Hao-Kai Zhang, Shuo Liu, and Shi-Xin Zhang. “Absence of barren plateaus in finite local-depth circuits with long-range entanglement”. *Phys. Rev. Lett.* **132**, 150603 (2024).
- [25] Lorenzo Leone, Salvatore F. E. Oliviero, Lukasz Cincio, and M. Cerezo. “On the practical usefulness of the hardware efficient ansatz” (2022). [arXiv:2211.01477](https://arxiv.org/abs/2211.01477).
- [26] Frederic Sauvage, Sukin Sim, Alexander A. Kunitsa, William A. Simon, Marta Mauri, and Alejandro Perdomo-Ortiz. “Flip: A flexible initializer for arbitrarily-sized parametrized quantum circuits” (2021). [arXiv:2103.08572](https://arxiv.org/abs/2103.08572).
- [27] A. Kulshrestha and I. Safro. “Beinit: Avoiding barren plateaus in variational quantum algorithms”. In 2022 IEEE International Conference on Quantum Computing and Engineering (QCE). Pages 197–203. Los Alamitos, CA, USA (2022). IEEE Computer Society.
- [28] Anbang Wu, Gushu Li, Yufei Ding, and Yuan Xie. “Mitigating noise-induced gradient vanishing in variational quantum algorithm training” (2021). url: <https://api.semanticscholar.org/CorpusID:244709032>.
- [29] Taylor L. Patti, Khadijeh Najafi, Xun Gao, and Susanne F. Yelin. “Entanglement devised barren plateau mitigation”. *Phys. Rev. Res.* **3**, 033090 (2021).
- [30] Chufan Lyu, Xusheng Xu, Man-Hong Yung, and Abolfazl Bayat. “Symmetry enhanced variational quantum spin eigensolver”. *Quantum* **7**, 899 (2023).
- [31] Sergey Bravyi, Alexander Kliesch, Robert Koenig, and Eugene Tang. “Obstacles to variational quantum optimization from symmetry protection”. *Phys. Rev. Lett.* **125**, 260505 (2020).
- [32] Hefeng Wang, S. Ashhab, and Franco Nori. “Efficient quantum algorithm for preparing molecular-system-like states on a quantum computer”. *Phys. Rev. A* **79**, 042335 (2009).
- [33] Kazuhiro Seki, Tomonori Shirakawa, and Seiji Yunoki. “Symmetry-adapted variational quantum eigensolver”. *Phys. Rev. A* **101**, 052340 (2020).

- [34] Panagiotis Kl. Barkoutsos, Jerome F. Gonthier, Igor Sokolov, Nikolaj Moll, Gian Salis, Andreas Fuhrer, Marc Ganzhorn, Daniel J. Egger, Matthias Troyer, Antonio Mezzacapo, Stefan Filipp, and Ivano Tavernelli. “Quantum algorithms for electronic structure calculations: Particle-hole hamiltonian and optimized wavefunction expansions”. *Phys. Rev. A* **98**, 022322 (2018).
- [35] Sacha Lerch, Ricard Puig, Manuel S. Rudolph, Armando Angrisani, Tyson Jones, M. Cerezo, Supanut Thanasilp, and Zoë Holmes. “Efficient quantum-enhanced classical simulation for patches of quantum landscapes” (2024). [arXiv:2411.19896](https://arxiv.org/abs/2411.19896).
- [36] Jonathan Wurtz, Stefan H. Sack, and Sheng-Tao Wang. “Solving nonnative combinatorial optimization problems using hybrid quantum–classical algorithms”. *IEEE Transactions on Quantum Engineering* **5**, 1–14 (2024).
- [37] Kamil Bradler and Hugo Wallner. “Certain properties and applications of shallow bosonic circuits” (2021). [arXiv:2112.09766](https://arxiv.org/abs/2112.09766).
- [38] Mateusz Ostaszewski, Edward Grant, and Marcello Benedetti. “Structure optimization for parameterized quantum circuits”. *Quantum* **5**, 391 (2021).
- [39] Robert M. Parrish, Joseph T. Iosue, Asier Ozaeta, and Peter L. McMahon. “A jacobi diagonalization and anderson acceleration algorithm for variational quantum algorithm parameter optimization” (2019). [arXiv:1904.03206](https://arxiv.org/abs/1904.03206).
- [40] David Wierichs, Josh Izaac, Cody Wang, and Cedric Yen-Yu Lin. “General parameter-shift rules for quantum gradients”. *Quantum* **6**, 677 (2022).
- [41] Javier Gil Vidal and Dirk Oliver Theis. “Calculus on parameterized quantum circuits” (2018). [arXiv:1812.06323](https://arxiv.org/abs/1812.06323).
- [42] Ken M. Nakanishi, Keisuke Fujii, and Syngae Todo. “Sequential minimal optimization for quantum-classical hybrid algorithms”. *Phys. Rev. Res.* **2**, 043158 (2020).
- [43] Michael Reck, Anton Zeilinger, Herbert J. Bernstein, and Philip Bertani. “Experimental realization of any discrete unitary operator”. *Phys. Rev. Lett.* **73**, 58–61 (1994).
- [44] William R. Clements, Peter C. Humphreys, Benjamin J. Metcalf, W. Steven Kolthammer, and Ian A. Walmsley. “Optimal design for universal multiport interferometers”. *Optica* **3**, 1460–1465 (2016).
- [45] S. A. Fldzhyan, M. Yu. Saygin, and S. P. Kulik. “Optimal design of error-tolerant reprogrammable multiport interferometers”. *Opt. Lett.* **45**, 2632–2635 (2020).
- [46] E Knill, R. Laflamme, and G. J. Milburn. “A scheme for efficient quantum computation with linear optics”. *Nature* **409**, 46 (2001).
- [47] Pieter Kok and Brendon W. Lovett. “Introduction to optical quantum information processing”. *Cambridge University Press*. (2010).
- [48] Alex Arkhipov and Greg Kuperberg. “The bosonic birthday paradox”. *Geometry & Topology Monographs* **18**, 10–2140 (2012).
- [49] Stefan Scheel. “Permanents in linear optical networks” (2004). [arXiv:quant-ph/0406127](https://arxiv.org/abs/quant-ph/0406127).
- [50] Leslie G Valiant. “Quantum computers that can be simulated classically in polynomial time”. In Proceedings of the thirty-third annual ACM symposium on Theory of computing. *Pages* 114–123. (2001).
- [51] Barbara M. Terhal and David P. DiVincenzo. “Classical simulation of noninteracting-fermion quantum circuits”. *Phys. Rev. A* **65**, 032325 (2002).
- [52] E. Knill. “Fermionic linear optics and matchgates” (2001). [arXiv:quant-ph/0108033](https://arxiv.org/abs/quant-ph/0108033).
- [53] Michał Oszmaniec, Ninnat Dangniam, Mauro E.S. Morales, and Zoltán Zimborás. “Fermion sampling: A robust quantum computational advantage scheme using fermionic linear optics and magic input states”. *PRX Quantum* **3**, 020328 (2022).
- [54] Han-Sen Zhong, Hui Wang, Yu-Hao Deng, Ming-Cheng Chen, Li-Chao Peng, Yi-Han Luo, Jian Qin, Dian Wu, Xing Ding, Yi Hu, Peng Hu, Xiao-Yan Yang, Wei-Jun Zhang, Hao Li, Yuxuan Li, Xiao Jiang, Lin Gan, Guangwen Yang, Lixing You, Zhen Wang, Li Li, Nai-Le Liu, Chao-Yang Lu, and Jian-Wei Pan. “Quantum computational advantage using photons”. *Science* **370**, 1460–1463 (2020).
- [55] Scott Aaronson and Alex Arkhipov. “The computational complexity of linear optics”. In Proceedings of the Forty-Third Annual ACM Symposium on Theory of Computing. *Page* 333–342. STOC ’11 New York, NY, USA (2011). Association for Computing Machinery.
- [56] Hui Wang, Jian Qin, Xing Ding, Ming-Cheng Chen, Si Chen, Xiang You, Yu-Ming He, Xiao Jiang, L. You, Z. Wang, C. Schneider, Jelmer J. Renema, Sven Höfling, Chao-Yang Lu, and Jian-Wei Pan. “Boson sampling with 20 input photons and a 60-mode interferometer in a 10^{14} -dimensional hilbert space”. *Phys. Rev. Lett.* **123**, 250503 (2019).
- [57] L.G. Valiant. “The complexity of computing the permanent”. *Theoretical Computer Science* **8**, 189–201 (1979).
- [58] Lars S Madsen, Fabian Laudenbach, Mohsen Falamarzi Askarani, Fabien Rortais, Trevor Vincent, Jacob FF Bulmer, Filippo M Miatto, Leonhard Neuhaus, Lukas G Helt, Matthew J Collins, et al. “Quantum computational advantage with a programmable photonic processor”. *Nature* **606**, 75–81 (2022).
- [59] Michael Ragone, Bojko N Bakalov, Frédéric Sauvage, Alexander F Kemper, Carlos Ortiz Marrero, Martín Larocca, and Marco Cerezo. “A lie algebraic theory of barren plateaus for deep parameterized quantum circuits”. *Nature Communications* **15**, 7172 (2024).
- [60] E Fontana, D Herman, S Chakrabarti, N Kumar, R Yalovetzky, J Heredge, SH Sureshbabu, and M Pistoia. “Characterizing barren plateaus in quantum ansätze with the adjoint representation.”. *Nat Commun* **15**, 7171 (2024).
- [61] Hela Mhiri, Hugo Thomas, Léo Monbroussou, Ulysse Chabaud, Zoë Holmes, and Elham Kashefi. “Boson sampling beyond the dilute regime: second moments and anti-concentration” (2026). [arXiv:2604.14323](https://arxiv.org/abs/2604.14323).
- [62] Harry Bromley. “Lightworks” (2025).
- [63] Beng Yee Gan, Daniel Leykam, and Dimitris G Angelakis. “Fock state-enhanced expressivity of quantum machine learning models”. *EPJ Quantum Technology* **9**, 16 (2022).
- [64] Giorgio Facelli, David D. Roberts, Hugo Wallner, Alexander Makarovskiy, Zoë Holmes, and William R. Clements. “Exact gradients for linear optics with single photons” (2024). [arXiv:2409.16369](https://arxiv.org/abs/2409.16369).
- [65] Kendall Atkinson. “An introduction to numerical analysis”. John Wiley & sons. (1991).
- [66] Edward Farhi, Jeffrey Goldstone, and Sam Gutmann. “A quantum approximate optimization algorithm” (2014). [arXiv:1411.4028](https://arxiv.org/abs/1411.4028).

- [67] Alberto Peruzzo, Jarrod McClean, Peter Shadbolt, Man-Hong Yung, Xiao-Qi Zhou, Peter J Love, Alán Aspuru-Guzik, and Jeremy L O'Brien. "A variational eigenvalue solver on a photonic quantum processor". *Nature communications* **5**, 4213 (2014).
- [68] K. Mitarai, M. Negoro, M. Kitagawa, and K. Fujii. "Quantum circuit learning". *Phys. Rev. A* **98**, 032309 (2018).
- [69] Nicolò Spagnolo, Daniel J Brod, Ernesto F Galvão, and Fabio Sciarrino. "Non-linear boson sampling". *npj Quantum Information* **9**, 3 (2023).
- [70] Stefan Scheel, Kae Nemoto, William J. Munro, and Peter L. Knight. "Measurement-induced nonlinearity in linear optics". *Phys. Rev. A* **68**, 032310 (2003).
- [71] J. Eisert. "Optimizing linear optics quantum gates". *Phys. Rev. Lett.* **95**, 040502 (2005).
- [72] Stefan Scheel and Norbert Lütkenhaus. "Upper bounds on success probabilities in linear optics". *New Journal of Physics* **6**, 51 (2004).
- [73] Stefan Scheel and Koenraad M R Audenaert. "Scaling of success probabilities for linear optics gates". *New Journal of Physics* **7**, 149 (2005).
- [74] S. Scheel, J.K. Pachos, E.A. Hinds, and P.L. Knight. "Quantum gates and decoherence". *Pages 47–81*. Springer Berlin Heidelberg. Berlin, Heidelberg (2006).
- [75] Zhanghan Wu, Sean D. Huver, Dmitry Uskov, Hwang Lee, and Jonathan P. Dowling. "Optimizing optical quantum logic gates using genetic algorithms" (2007). [arXiv:0708.1498](https://arxiv.org/abs/0708.1498).
- [76] Chris Sparrow, Enrique Martín-López, Nicola Maraviglia, Alex Neville, Christopher Harrold, Jacques Carolan, Yogesh N Joglekar, Toshikazu Hashimoto, Nobuyuki Matsuda, Jeremy L O'Brien, et al. "Simulating the vibrational quantum dynamics of molecules using photonics". *Nature* **557**, 660–667 (2018).
- [77] Dmitry B. Uskov, Lev Kaplan, A. Matthew Smith, Sean D. Huver, and Jonathan P. Dowling. "Maximal success probabilities of linear-optical quantum gates". *Phys. Rev. A* **79**, 042326 (2009).
- [78] T. C. Ralph, N. K. Langford, T. B. Bell, and A. G. White. "Linear optical controlled-not gate in the coincidence basis". *Phys. Rev. A* **65**, 062324 (2002).
- [79] T. C. Ralph, A. G. White, W. J. Munro, and G. J. Milburn. "Simple scheme for efficient linear optics quantum gates". *Phys. Rev. A* **65**, 012314 (2001).
- [80] Juan Miguel Arrazola, Olivia Di Matteo, Nicolás Quesada, Soran Jahangiri, Alain Delgado, and Nathan Kiloran. "Universal quantum circuits for quantum chemistry". *Quantum* **6**, 742 (2022).
- [81] Gian-Luca R Anselmetti, David Wierichs, Christian Gogolin, and Robert M Parrish. "Local, expressive, quantum-number-preserving vqe ansätze for fermionic systems". *New Journal of Physics* **23**, 113010 (2021).
- [82] Takuya Yoshioka, Keita Sasada, Yuichiro Nakano, and Keisuke Fujii. "Fermionic quantum approximate optimization algorithm". *Phys. Rev. Res.* **5**, 023071 (2023).
- [83] Christian Gross and Immanuel Bloch. "Quantum simulations with ultracold atoms in optical lattices". *Science* **357**, 995–1001 (2017).
- [84] Florian Schäfer, Takeshi Fukuhara, Seiji Sugawa, Yosuke Takasu, and Yoshiro Takahashi. "Tools for quantum simulation with ultracold atoms in optical lattices". *Nature Reviews Physics* **2**, 411–425 (2020).
- [85] Jonathan C. F. Matthews, Konstantinos Poullos, Jamin D. A. Meinecke, Alberto Politi, Alberto Peruzzo, Nur Ismail, Kerstin Wörhoff, Mark G. Thompson, and Jeremy L. O'Brien. "Observing fermionic statistics with photons in arbitrary processes". *Scientific Reports* **3** (2013).
- [86] Linda Sansoni, Fabio Sciarrino, Giuseppe Vallone, Paolo Mataloni, Andrea Crespi, Roberta Ramponi, and Roberto Osellame. "Two-particle bosonic-fermionic quantum walk via integrated photonics". *Phys. Rev. Lett.* **108**, 010502 (2012).
- [87] Martin Larocca, Piotr Czarnik, Kunal Sharma, Gopikrishnan Muraleedharan, Patrick J. Coles, and M. Cerezo. "Diagnosing Barren Plateaus with Tools from Quantum Optimal Control". *Quantum* **6**, 824 (2022).
- [88] Léo Monbroussou, Jonas Landman, Alex B. Grilo, Romain Kukla, and Elham Kashefi. "Trainability and expressivity of hamming-weight preserving quantum circuits for machine learning" (2023). [arXiv:2309.15547](https://arxiv.org/abs/2309.15547).
- [89] El Amine Cherrat, Snehal Raj, Iordanis Kerenidis, Abhishek Shekhar, Ben Wood, Jon Dee, Shouvanik Chakrabarti, Richard Chen, Dylan Herman, Shaohan Hu, Pierre Minssen, Ruslan Shayduln, Yue Sun, Romina Yalovetzky, and Marco Pistoia. "Quantum Deep Hedging". *Quantum* **7**, 1191 (2023).
- [90] Zhijian Lai, Jiang Hu, Taehee Ko, Jiayuan Wu, and Dong An. "Optimal interpolation-based coordinate descent method for parameterized quantum circuits" (2025). [arXiv:2503.04620](https://arxiv.org/abs/2503.04620).
- [91] Kostas Blekos, Dean Brand, Andrea Ceschini, Chiao-Hui Chou, Rui-Hao Li, Komal Pandya, and Alessandro Summer. "A review on quantum approximate optimization algorithm and its variants". *Physics Reports* **1068**, 1–66 (2024).
- [92] David Peral-García, Juan Cruz-Benito, and Francisco José García-Peñalvo. "Systematic literature review: Quantum machine learning and its applications". *Computer Science Review* **51**, 100619 (2024).
- [93] M. Cerezo, Martin Larocca, Diego García-Martín, N. L. Diaz, Paolo Braccia, Enrico Fontana, Manuel S. Rudolph, Pablo Bermejo, Aroosa Ijaz, Supanut Thanasilp, Eric R. Anschuetz, and Zoë Holmes. "Does provable absence of barren plateaus imply classical simulability? or, why we need to rethink variational quantum computing" (2024). [arXiv:2312.09121](https://arxiv.org/abs/2312.09121).
- [94] John P Boyd. "Computing the zeros, maxima and inflection points of chebyshev, legendre and fourier series: solving transcendental equations by spectral interpolation and polynomial rootfinding". *Journal of Engineering Mathematics* **56**, 203–219 (2006).
- [95] H. Georgi. "Lie algebras in particle physics". *CRC Press*. (2019). 2nd edition.
- [96] Zoltán Kolarovszki, Ágoston Kaposi, Zoltán Zimborás, and Michał Oszmaniec. "General framework for anticoncentration and linear cross-entropy benchmarking in photonic quantum advantage experiments" (2026). [arXiv:2604.15258](https://arxiv.org/abs/2604.15258).

Appendix A: Bosonic and fermionic linear optics

1. Linear interferometers

Let us consider a set fermionic or bosonic creation and annihilation operators, a_i^\dagger and a_i respectively, acting on a Fock space \mathcal{F} , where i labels the mode degree of freedom. These operators obey the algebra

$$[a_i, a_j]_{\pm} = [a_i^\dagger, a_j^\dagger]_{\pm} = 0, \quad [a_i, a_j^\dagger]_{\pm} = \delta_{ij}, \quad (\text{A1})$$

where $[A, B]_{\pm} = AB \pm BA$ is the anti-commutator for fermions (+) and the commutator for bosons (-). Given an N -mode system, multi-particle states are given by

$$|\mathbf{n}\rangle \equiv |n_1, n_2, \dots, n_N\rangle = \prod_{i=1}^N \frac{(a_i^\dagger)^{n_i}}{\sqrt{n_i!}} |0\rangle, \quad (\text{A2})$$

where n_i is the number of particles in the i th mode and $|0\rangle$ is the vacuum state. For bosons, the creation operators can be applied as many times as you like, so $n_i \in \mathbb{N}$. However, for fermions, the fermionic algebra implies that $(a_i^\dagger)^2 = 0$ hence $n_i \in \{0, 1\}$, which is the Pauli exclusion principle. The set of states of this form are called number states or Fock states and form a canonical basis of the Fock space. The dimension of the subspaces \mathcal{H}_B and \mathcal{H}_F containing n bosons or fermions and N modes is respectively given by

$$\dim \mathcal{H}_B = \frac{(N+n-1)!}{(N-1)!n!}, \quad \dim \mathcal{H}_F = \frac{N!}{(N-n)!n!}. \quad (\text{A3})$$

In this study, we are interested in N -mode linear optical interferometers. These are devices constructed from a network of N connected waveguides whose action on any input state is described by a unitary operator $U : \mathcal{F} \rightarrow \mathcal{F}$ acting linearly on the ladder operators in the Heisenberg picture as

$$U a_i^\dagger U^\dagger = \sum_{j=1}^N u_{ji} a_j^\dagger, \quad (\text{A4})$$

where $u \in U(N)$ is an $N \times N$ unitary matrix which is in 1:1 correspondence with U . In fact, the unitary U forms a reducible representation of the unitary matrix u on the Fock space, where each irrep is an n -photon subspace. It is u that is chosen, not U , when programming unitaries into an interferometers. We assume that the particles have identical internal state, such as frequency, polarisation and time bin, so the only degree of freedom available is the spatial degree of freedom of which waveguide the photons are on. From the Baker-Campbell-Hausdorff formula, this linear transformation implies that the unitaries are generated by quadratic Hamiltonians as $U = \exp(iHt)$, where

$$H = \sum_{i,j=1}^N h_{ij} a_i^\dagger a_j. \quad (\text{A5})$$

where the unitary matrix in Eq. (A4) is given by exponentiating the single-particle Hamiltonian as $u = \exp(iht)$. Hence, a linear optical interferometer can be viewed as simulating time evolution under a non-interacting and particle conserving Hamiltonian.

For example, given a two-mode system with modes a_0 and a_1 , a phase shifter that acts on the first mode is given by

$$U = \exp(-i\theta a_0^\dagger a_0) \quad \Leftrightarrow \quad u = \begin{pmatrix} e^{-i\theta} & 0 \\ 0 & 1 \end{pmatrix}, \quad (\text{A6})$$

where $\theta \in [0, 2\pi)$ is the phase shift, whilst a beamsplitter is given by

$$U = \exp[\theta(a_0^\dagger a_1 - a_1^\dagger a_0)] \quad \Leftrightarrow \quad u = \begin{pmatrix} \sqrt{T} & \sqrt{1-T} \\ -\sqrt{1-T} & \sqrt{T} \end{pmatrix}, \quad (\text{A7})$$

where $T = \cos^2 \theta$ for $\theta \in [0, 2\pi)$ is the transmission of the beamsplitter. In both cases we have provided the Fock space unitary U and the corresponding linear transformation u .

In practice, these interferometers are constructed from a network of phase shifters and 50:50 beamsplitters only. There exist multiple universal interferometer layouts that can encode any $u \in U(N)$, e.g. [43–45], however this does not mean that the interferometer is a universal quantum computer, as only U of the form in Eq. (A4) can be generated and ones describing interactions between photons or particle non-conservation are not possible. For universal quantum computing with linear optics, a non-deterministic approach must be used [46, 47, 79].

2. Sampling amplitudes

Let us calculate the transition amplitude between the n -particle number states $|\mathbf{n}\rangle = |n_1, n_2, \dots, n_N\rangle$ and $|\mathbf{m}\rangle = |m_1, m_2, \dots, m_N\rangle$ after inserting $|\mathbf{n}\rangle$ into an N -mode linear interferometer, where $\sum_{i=1}^N n_i = \sum_{i=1}^N m_i = n$. We first rewrite these states in a slightly different way to how they are defined in Eq. (A2) which makes calculation of the transition amplitudes easier. Let us define ν_i as the mode that the i th particle is on in the state $|\mathbf{n}\rangle$, for $i = 1, 2, \dots, n$, and similarly μ_i for $|\mathbf{m}\rangle$. Some of these indices may be identical if more than one particle is found on any of the modes. Then we can rewrite the number states as

$$|\mathbf{n}\rangle = \frac{1}{\sqrt{\mathbf{n}!}} \prod_{i=1}^n a_{\nu_i}^\dagger |0\rangle, \quad |\mathbf{m}\rangle = \frac{1}{\sqrt{\mathbf{m}!}} \prod_{i=1}^n a_{\mu_i}^\dagger |0\rangle. \quad (\text{A8})$$

where $\mathbf{n}! = \prod_{i=1}^N n_i!$. We make sure the ladder operators are applied in the same order as in Eq. (A2), i.e., indices from largest to smallest from left to right, to avoid picking up any relative phases between the two ways of writing down the states. Let us apply the unitary U , whose action is defined in Eq. (A4), to $|\mathbf{n}\rangle$ which gives

$$\begin{aligned} U|\mathbf{n}\rangle &= \frac{1}{\sqrt{\mathbf{n}!}} \prod_{i=1}^n (U a_{\nu_i}^\dagger U^\dagger) |0\rangle \\ &= \frac{1}{\sqrt{\mathbf{n}!}} \prod_{i=1}^n \left(\sum_{j=1}^N u_{j\nu_i} a_j^\dagger \right) |0\rangle \\ &= \frac{1}{\sqrt{\mathbf{n}!}} \sum_{j_1=1}^N \sum_{j_2=1}^N \dots \sum_{j_n=1}^N u_{j_1\nu_1} u_{j_2\nu_2} \dots u_{j_n\nu_n} a_{j_1}^\dagger a_{j_2}^\dagger \dots a_{j_n}^\dagger |0\rangle \end{aligned} \quad (\text{A9})$$

Now if we take the inner product with $|\mathbf{m}\rangle$ we get

$$\langle \mathbf{m} | U | \mathbf{n} \rangle = \frac{1}{\sqrt{\mathbf{n}!}} \sum_{j_1=1}^N \sum_{j_2=1}^N \dots \sum_{j_n=1}^N u_{j_1\nu_1} u_{j_2\nu_2} \dots u_{j_n\nu_n} \langle \mathbf{m} | a_{j_1}^\dagger a_{j_2}^\dagger \dots a_{j_n}^\dagger | 0 \rangle \quad (\text{A10})$$

If we substitute in Eq. (A8) and apply Wick's theorem we have

$$\begin{aligned} \langle \mathbf{m} | a_{j_1}^\dagger a_{j_2}^\dagger \dots a_{j_n}^\dagger | 0 \rangle &= \frac{1}{\sqrt{\mathbf{m}!}} \langle 0 | a_{\mu_1} a_{\mu_2} \dots a_{\mu_n} a_{j_1}^\dagger a_{j_2}^\dagger \dots a_{j_n}^\dagger | 0 \rangle \\ &= \frac{1}{\sqrt{\mathbf{m}!}} \sum_{\sigma \in S_n} (\pm 1)^\sigma \prod_{i=1}^n \delta_{\mu_{\sigma(i)}, j_i} \end{aligned} \quad (\text{A11})$$

where Wick's theorem amounts to repeated use of the commutation relations and gives us a sum over all possible permutations, where S_n is the permutation group of n elements, and we additionally have a factor of $(\pm 1)^\sigma$ which arises from commuting operators past each and picking up a sign if they have fermionic anti-commutation relations. Substituting this back into the inner product yields

$$\begin{aligned} \langle \mathbf{m} | U | \mathbf{n} \rangle &= \frac{1}{\sqrt{\mathbf{m}! \mathbf{n}!}} \sum_{j_1=1}^N \sum_{j_2=1}^N \dots \sum_{j_n=1}^N u_{j_1\nu_1} u_{j_2\nu_2} \dots u_{j_n\nu_n} \sum_{\sigma \in S_n} (\pm 1)^\sigma \prod_{i=1}^n \delta_{\mu_{\sigma(i)}, j_i} \\ &= \frac{1}{\sqrt{\mathbf{m}! \mathbf{n}!}} \sum_{\sigma \in S_n} (\pm 1)^\sigma \prod_{i=1}^n \sum_{j_i=1}^N u_{j_i\nu_i} \delta_{\mu_{\sigma(i)}, j_i} \\ &= \frac{1}{\sqrt{\mathbf{m}! \mathbf{n}!}} \sum_{\sigma \in S_n} (\pm 1)^\sigma \prod_{i=1}^n u_{\mu_{\sigma(i)} \nu_i} \\ &= \frac{1}{\sqrt{\mathbf{m}! \mathbf{n}!}} \begin{cases} \text{per } u[\mathbf{m}|\mathbf{n}] & \text{bosons (+)} \\ \det u[\mathbf{m}|\mathbf{n}] & \text{fermions (-)} \end{cases}, \end{aligned} \quad (\text{A12})$$

where per is the permanent, det is the determinant, and $u[\mathbf{m}|\mathbf{n}]$ is the matrix u with the i th row index repeated m_i times and the j th column index repeated n_j times [49, 55]. For example,

$$u = \begin{pmatrix} u_{11} & u_{12} & u_{13} \\ u_{21} & u_{22} & u_{23} \\ u_{31} & u_{32} & u_{33} \end{pmatrix} \Rightarrow u[(3, 1, 0)|(1, 1, 2)] = \begin{pmatrix} u_{11} & u_{12} & u_{13} & u_{13} \\ u_{11} & u_{12} & u_{13} & u_{13} \\ u_{11} & u_{12} & u_{13} & u_{13} \\ u_{21} & u_{22} & u_{23} & u_{23} \end{pmatrix}. \quad (\text{A13})$$

The process of inserting bosons/photons into a linear optical interferometer and sampling from the output states is known as boson sampling. As calculating the permanent is a #P-hard problem classically, then simulating the output distribution of boson sampling affords a quantum advantage [55]. On the other hand, the determinant can be calculated efficiently using an algorithm such as LU decomposition which has a complexity of $O(n^3)$ for an $n \times n$ matrix, hence simulation of fermions is classically efficient. This determinant is sometimes called the Slater determinant.

3. Simulating fermions with single photons and linear optics

The following reviews the results of Ref. [85]. We wish to simulate fermionic statistics with photons. As photons are bosons, we must use entangled states to simulate this. Suppose we have n photons that we insert into n separate interferometers, each with N modes. Define the state

$$|\psi\rangle = \frac{1}{\sqrt{n!}} \sum_{\sigma \in S_n} (-1)^\sigma \prod_{\mu=1}^n a_{\mu\sigma(\mu)}^\dagger |0\rangle, \quad (\text{A14})$$

where $a_{\mu i}$ is the mode operator for the i th mode of the μ th interferometer. These modes obey the commutation relations

$$[a_{\mu i}, a_{\nu j}] = [a_{\mu i}^\dagger, a_{\nu j}^\dagger] = 0, \quad [a_{\mu i}, a_{\nu j}^\dagger] = \delta_{\mu\nu} \delta_{ij}, \quad (\text{A15})$$

so operators from different interferometers will always commute. The state defined in Eq. (A14) consists of a single photon in one of the first n modes of each interferometer. This generates an entangled state. Now we pass this state through the system. Each photon enters a separate interferometer, so there will be no interference between photons and the only effects are due to the entanglement and interference of photons with themselves.

We now define the unitary U which acts on these modes as

$$U a_{\mu i}^\dagger U^\dagger = \sum_{j=1}^N u_{ji} a_{\mu j}^\dagger, \quad \forall \mu. \quad (\text{A16})$$

This applies a linear transformation to the mode degree of freedom i and not the interferometer degree of freedom μ which remains unchanged. Therefore, this unitary U describes describes the process of applying the same unitary operation to each photon within its respective interferometer. If we apply this to our input state we have

$$\begin{aligned} U|\psi\rangle &= \frac{1}{\sqrt{n!}} \sum_{\sigma \in S_n} (-1)^\sigma \prod_{\mu=1}^n U a_{\mu\sigma(\mu)}^\dagger U^\dagger |0\rangle \\ &= \frac{1}{\sqrt{n!}} \sum_{\sigma \in S_n} (-1)^\sigma \prod_{\mu=1}^n \sum_{i=1}^N u_{i\sigma(\mu)} a_{\mu i}^\dagger |0\rangle \\ &= \frac{1}{\sqrt{n!}} \sum_{\sigma \in S_n} (-1)^\sigma \sum_{i_1=1}^N \sum_{i_2=1}^N \dots \sum_{i_n=1}^N u_{i_1\sigma(1)} u_{i_2\sigma(2)} \dots u_{i_n\sigma(n)} a_{1i_1}^\dagger a_{2i_2}^\dagger \dots a_{ni_n}^\dagger |0\rangle. \end{aligned} \quad (\text{A17})$$

Now introduce an n -photon state, where each interferometer has a single photon in it, given by

$$|\phi_{\mathbf{k}}\rangle = \prod_{\mu=1}^n a_{\mu k_\mu}^\dagger |0\rangle, \quad (\text{A18})$$

which is the state for which the μ th interferometer has a single photon in the k_μ th mode. The amplitude for the input state to be found in the state $|\phi_{\mathbf{k}}\rangle$ is given by

$$\begin{aligned}
\langle \phi_{\mathbf{k}} | U | \psi \rangle &= \frac{1}{\sqrt{n!}} \sum_{\sigma \in S_n} (-1)^\sigma \sum_{i_1=1}^N \sum_{i_2=1}^N \cdots \sum_{i_n=1}^N u_{i_1 \sigma(1)} u_{i_2 \sigma(2)} \cdots u_{i_n \sigma(n)} \langle \phi_{\mathbf{k}} | a_{i_1}^\dagger a_{i_2}^\dagger \cdots a_{i_n}^\dagger | 0 \rangle \\
&= \frac{1}{\sqrt{n!}} \sum_{\sigma \in S_n} (-1)^\sigma \sum_{i_1=1}^N \sum_{i_2=1}^N \cdots \sum_{i_n=1}^N u_{i_1 \sigma(1)} u_{i_2 \sigma(2)} \cdots u_{i_n \sigma(n)} \delta_{k_1 i_1} \delta_{k_2 i_2} \cdots \delta_{k_n i_n} \\
&= \frac{1}{\sqrt{n!}} \sum_{\sigma \in S_n} (-1)^\sigma u_{k_1 \sigma(1)} u_{k_2 \sigma(2)} \cdots u_{k_n \sigma(n)} \\
&= \frac{1}{\sqrt{n!}} \det u_{\mathbf{k}},
\end{aligned} \tag{A19}$$

where $u_{\mathbf{k}}$ is an $n \times n$ matrix with components

$$[u_{\mathbf{k}}]_{ij} = u_{k_{ij}}, \tag{A20}$$

where u is the original unitary matrix. Suppose we ask for the probability that two interferometers have a photon on the same mode, say interferometers μ and ν , in which case $k_\mu = k_\nu$. We see that this amplitude vanishes because the matrix $u_{\mathbf{k}}$ would have two identical rows and hence its determinant is zero.

Suppose instead we ask: what is the probability to get the distribution of photons $\mathbf{m} = (m_1, m_2, \dots, m_N)$, where $m_i = 1$ if there is a photon in the i th mode *somewhere* across the N chips, in other words what is the probability that the superimposed output of all n interferometers is \mathbf{m} ? This means we now ignore the interferometer degree of freedom μ so multiple output distributions will be equivalent. In this case we sum up the probabilities for all permutations of \mathbf{k} that yield this particular \mathbf{m} . We have

$$P(\mathbf{m}) = \frac{1}{n!} \sum_{\sigma \in S_n} |\det u_{\sigma(\mathbf{k})}|^2 = \frac{1}{n!} \sum_{\sigma \in S_n} |(-1)^\sigma \det u_{\mathbf{k}}|^2 = |\det u_{\mathbf{k}}|^2, \tag{A21}$$

however we have

$$|\det u_{\mathbf{k}}| = |\det u[\mathbf{m}|\mathbf{n}]| \tag{A22}$$

which is because k_μ are simply the indices for which $m_{k_\mu} = 1$, which therefore allows us to rewrite this in terms of the matrix $u[\mathbf{m}|\mathbf{n}]$ as defined in Eq. (A12) in the fermionic case. Therefore, the entangled photonic state gives rise to fermionic statistics.

The success probability of producing the fermionic resource state of Eq. (A14) with linear optics alone is upper bounded by $1/9$. This is because for the smallest non-trivial example of $n = 2$ fermions a single CNOT gate is required to produce the state which has a probability of $1/9$ with linear optics and postselection, see Sec. III D for this example. For larger n , more CNOTs are required, reducing the probability. In the supplementary material of Ref. [85] a three-fermion example is shown.

Appendix B: Cost landscapes of linear optics

1. Derivation of the cost landscape

As discussed above in Sec. II A the interferometer is constructed from an array of parametrised phase shifters and fixed 50:50 beamsplitters. In this work, we introduce a *non-linear* phase shifter which acts slightly differently to how standard phase shifters act, which we refer to a dual-valued phase shifter (DVPS), and we compare the performance of variational quantum algorithms which use interferometers constructed from these types. The two types of phase shifters are described by the unitaries

$$U(x) = \begin{cases} \exp(i\hat{n}x) & \text{standard} \\ \exp(i\hat{q}x) & \text{DVPS} \end{cases} \tag{B1}$$

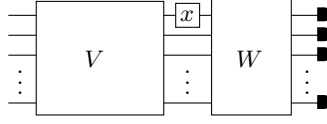

FIG. 11. When we vary a single phase shifter in the interferometer, we effectively have an interferometer consisting of a single phase shifter with phase x sandwiched between two (non-universal in general) interferometers encoding the fixed unitaries V and W .

where $\hat{n} = a^\dagger a$ is the number operator for the mode that the phase shifter acts upon, whilst the DVPS is generated by a new Hermitian operator \hat{q} which is diagonal in the number basis, just like the number operator is, but instead has only two distinct eigenvalues. In other words, it acts as

$$\hat{q}|n\rangle = q(n)|n\rangle, \quad (\text{B2})$$

where $q : \mathbb{N} \rightarrow \{a, b\}$.

We now investigate how the choice of \hat{n} or \hat{q} modifies the cost landscape. This closely follows the calculations of Ref. [63]. Suppose we introduce the Hamiltonian H whose (possibly degenerate) ground state corresponds to the solution to a given problem. We introduce the cost function

$$E(\boldsymbol{\theta}) = \langle \psi(\boldsymbol{\theta}) | H | \psi(\boldsymbol{\theta}) \rangle, \quad (\text{B3})$$

where $|\psi(\boldsymbol{\theta})\rangle = U(\boldsymbol{\theta})|\psi_{\text{in}}\rangle$ is the output of the interferometer described by the parametrised unitary $U(\boldsymbol{\theta})$. Now suppose we vary one of the parameters of the interferometer, say the j th one, whilst keeping the others fixed, then the cost function can be viewed as the function

$$f(x) := E(\theta_j = x) = \langle \psi_{\text{in}} | U^\dagger(x) H U(x) | \psi_{\text{in}} \rangle. \quad (\text{B4})$$

Each variable of the unitary controls a single phase shifter in the interferometer, so here the unitary U takes the form $U(x) = WS(x)V$, where $S(x)$ is the phase shifter from Eq. (B1); whilst V and W are the unitaries describing the remainder of the interferometer before and after this phase shifter respectively as shown in Fig. 11.

As the unitaries conserve particle number, we can restrict ourselves to the n -particle subspace. Let us consider two n -particle states $|\mathbf{n}\rangle$ and $|\mathbf{m}\rangle$. The matrix elements on this subspace are given by

$$\begin{aligned} U_{\mathbf{m}\mathbf{n}} &\equiv \langle \mathbf{m} | U | \mathbf{n} \rangle = \sum_{\mathbf{p}, \mathbf{q}} W_{\mathbf{m}\mathbf{p}} S_{\mathbf{p}\mathbf{q}}(x) V_{\mathbf{q}\mathbf{n}} \\ &= \sum_{\mathbf{p}, \mathbf{q}} W_{\mathbf{m}\mathbf{p}} V_{\mathbf{q}\mathbf{n}} e^{ip_j x} \delta_{\mathbf{p}\mathbf{q}} \\ &= \sum_{\mathbf{p}} W_{\mathbf{m}\mathbf{p}} V_{\mathbf{p}\mathbf{n}} e^{ip_j x}, \end{aligned} \quad (\text{B5})$$

where the sums are over the n -particle Fock number basis.

Suppose we took our initial state as $|\psi_{\text{in}}\rangle = |\mathbf{n}\rangle$ and pass it through the interferometer, the expectation value of the cost function gives

$$f(x) = \langle \mathbf{n} | U^\dagger H U | \mathbf{n} \rangle = \sum_{\mathbf{p}, \mathbf{q}} U_{\mathbf{n}\mathbf{p}}^\dagger H_{\mathbf{p}\mathbf{q}} U_{\mathbf{q}\mathbf{n}}. \quad (\text{B6})$$

We can safely assume that the Hamiltonian is diagonal in the Fock basis as $H_{\mathbf{p}\mathbf{q}} = E_{\mathbf{p}} \delta_{\mathbf{p}\mathbf{q}}$. Alternatively, we could diagonalise H to this form with a unitary which we absorb into the definition of U . We can also encode the use of threshold detectors, which are unable to count the number of photons in each mode, by taking the eigenvalues of the Hamiltonian to be identical for all states that map to the same bit string under threshold detection, i.e., $E_{\mathbf{p}} = E_{\mathbf{q}}$ if $\mathbf{p} = \Theta(\mathbf{q})$ where Θ is the Heaviside step function that acts on each element of the vector. We could also map to bit strings by using parity photo-detectors that can detect whether there was an even or odd number of photons too [37] and an alternative parity encoding on the Hamiltonian is used be used for this case.

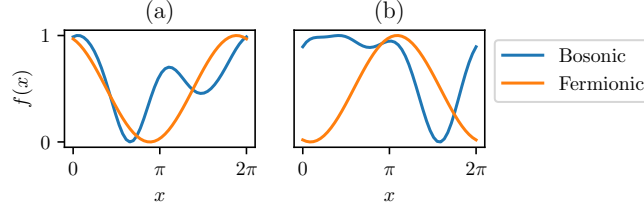

FIG. 12. The normalised cost function for a random Hamiltonian H if we use bosonic or fermionic statistics as we vary a single phase shifter x in the interferometer. We see that fermionic statistics can remove or reduce (a) local minima and (b) barren plateaus .

Using this and substituting in the matrix elements of U we have the cost function

$$\begin{aligned}
 f(x) &= \sum_{\mathbf{p}, \mathbf{q}} \left(\sum_{\mathbf{k}} W_{\mathbf{pk}}^* V_{\mathbf{kn}}^* e^{-ik_j x} \right) E_{\mathbf{p}} \delta_{\mathbf{pq}} \left(\sum_{\mathbf{l}} W_{\mathbf{ql}} V_{\mathbf{ln}} e^{il_j x} \right) \\
 &= \sum_{\mathbf{k}, \mathbf{l}} \left(\sum_{\mathbf{p}} E_{\mathbf{p}} W_{\mathbf{pk}}^* V_{\mathbf{kn}}^* W_{\mathbf{pl}} V_{\mathbf{ln}} \right) e^{i(l_j - k_j)x} \\
 &\equiv \sum_{\mathbf{k}, \mathbf{l}} a_{\mathbf{k}\mathbf{l}} e^{i(l_j - k_j)x},
 \end{aligned} \tag{B7}$$

This is beginning to look like a Fourier series. Let us define the frequency $p = l_j - k_j$. If we work with standard phase shifters then on the n -particle subspace the set of frequencies is given by $p \in \{-n, \dots, n\}$. This is because l_j and k_j , which are both the possible eigenvalues of the number operator, can take all integer values from 0 to a maximum of n as we sum over the number states, hence $p = l_j - k_j$ takes all values from $-n$ to n .

Now let us reorder the sum by combining all the coefficients of each exponential with the same frequency p to give us

$$f(x) = \sum_{p=-n}^n c_p e^{ipx}, \quad c_p = \sum_{\substack{\mathbf{k}, \mathbf{l} \\ l_j - k_j = p}} a_{\mathbf{k}\mathbf{l}}, \tag{B8}$$

which is our final result. This result was originally from Ref. [63]. This means that if we vary a single parameter of the cost function, the resultant function takes the general form of a Fourier series with a maximum frequency of n , where n is the number of bosons inserted into the interferometer.

If instead we work with dual-valued phase shifters, then the only possible frequencies are given by $p \in \{0, a-b, b-a\}$. This is because the eigenvalues l_j and k_j can only take values a or b . The actual values of the eigenvalues we assign each Fock state is not important, only that the Fock states are eigenstates with two possible eigenvalues. This means that we only have a single frequency in our resultant Fourier series, so Eq. (B8) is truncated down further to

$$f(x) = A \sin(\omega x - \phi) + B, \tag{B9}$$

where $\omega = |a - b|$, and A , B and ϕ are constants determined by the rest of the parameters in the interferometer that control V and W and the observable H . Similarly, if we worked with standard phase shifters and *fermionic* states, for which $\hat{n} = 0, 1$ automatically, we would obtain the same cost landscape for $\omega = 1$ without the need to use \hat{q} explicitly. In Fig. 12 we show how transforming from bosonic to fermionic statistics removes local minima and barren plateaus for the same cost function Hamiltonian and unitaries V and W .

2. Solving for the minima

In this appendix we solve for the stationary points of the bosonic cost landscape of Eq. (B8) which forms the basis of the Optimal Interpolation-based Coordinate Descent (OICD) [90] algorithm that generalises Rotosolve to trigonometric cost functions with multiple harmonics. This closely follows the original works of Refs. [90, 94].

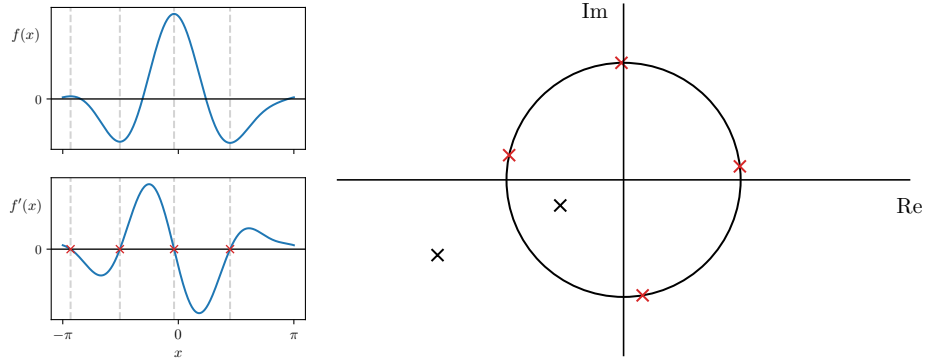

FIG. 13. The stationary points of a trigonometric polynomial $f(x)$ of order n can be found by solving for the roots of a polynomial whose coefficients are equal to the Fourier coefficients of the derivative $f'(x)$. Roots z of the polynomial that lie on the unit circle in the complex plane, shown by the red crosses, correspond to roots of the derivative and hence stationary points via $x = \arg(z)$. Other roots, shown by black crosses, do not correspond to stationary points.

Firstly, we can obtain the Fourier coefficients of an unknown trigonometric cost function of the form of Eq. (B8) given a finite set of samples. Let us take $2n + 1$ samples of the cost function at the set of equally-spaced points $x_j = 2j\pi/(2n + 1)$ as

$$f(x_j) = \sum_{k=-n}^n c_k e^{ikx_j}, \tag{B10}$$

for $j = 1, 2, \dots, 2n + 1$. This takes the form of a discrete Fourier transform. By performing an inverse discrete Fourier transform we arrive at

$$c_k = \frac{1}{2n + 1} \sum_{j=-n}^n f(x_j) e^{-ikx_j} \tag{B11}$$

which gives us the coefficients.

After solving for the Fourier coefficients $\{c_k\}$ the exact form of the Fourier series is known and the the minima can be solved for. We have the gradient

$$f'(x) = \sum_{k=-n}^n d_k e^{ikx}, \tag{B12}$$

where $d_k = ikc_k$, so the stationary points of the cost function $f(x)$ are given by the roots of a trigonometric polynomial as $f'(x) = 0$ which we solve for. Let us extend the domain of $f'(x)$ by defining the Laurent polynomial

$$p(z) = \sum_{k=-n}^n d_k z^k. \tag{B13}$$

The restriction of $p(z)$ to the unit circle returns the original trigonometric polynomial as $f'(x) = p(e^{ix})$. The roots of $p(z)$ such that $|z| = 1$ correspond to the roots of $f'(x)$, where the relationship is given by $x = \arg(z)$. In order to solve for the roots, define a $2n$ -degree polynomial $q(z) = z^n p(z)$. This polynomial has the same roots as $p(z)$ and can be solved for using simple root finding numerical methods. By the fundamental theorem of algebra, the polynomial $q(z)$ will have $2n$ roots that lie in the complex plane and a subset of these may lie on the unit circle corresponding to the roots of the original problem. In Fig. 13 we show an example of this in action. To find the global minima we sort through the list of stationary points on the unit circle to find the stationary point of $f(x)$ with the smallest cost.

This also upper bounds the number of minima of $f(x)$. Not all of the roots of $q(z)$ will lie on the unit circle in general, as seen in Fig. 13 for example, so all we can say is that there are at most $2n$ roots that lie on the unit circle and therefore at most $2n$ stationary points of $f(x)$. As the number of minima and maxima are equal, so the number of minima is half of this giving us the upper bound on the number of local minima of n .

Appendix C: Derivations for the dual-valued phase shifter

1. Deterministic design with non-linear optics

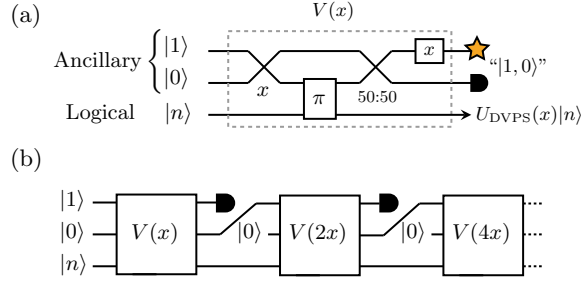

FIG. 14. (a) A non-deterministic DVPS. (b) A repeat-until-success variant.

A possible realisation of the dual-valued phase shifter (DVPS) is to take

$$U_{\text{DVPS}}(x) = e^{i\hat{q}x}, \quad \hat{q} = \frac{1}{2}(1 - \hat{\pi}), \quad (\text{C1})$$

where $\hat{\pi} = \exp(i\pi\hat{n})$ is the parity operator, equivalent to a π -phase shifter, and $\hat{n} = a^\dagger a$ is the number operator. This operator acts as

$$e^{i\hat{q}x}|n\rangle = e^{iq(n)x}|n\rangle, \quad q(n) = \frac{1}{2}(1 - (-1)^n), \quad (\text{C2})$$

where $|n\rangle$ is a single-mode number state of n photons. The goal is to construct this unitary.

Consider the circuit layout as given in Fig. 14 which consists of three modes a_0 , a_1 and a_2 labelled from top to bottom, where a_0 and a_1 are ancillary modes and a_2 is the logical mode. The beamsplitters and phase shifters act on the space of modes linearly according to Eq. (A4) as

$$u_{\text{BS}}(x) = \begin{pmatrix} \cos \frac{x}{2} & -i \sin \frac{x}{2} & 0 \\ -i \sin \frac{x}{2} & \cos \frac{x}{2} & 0 \\ 0 & 0 & 1 \end{pmatrix}, \quad u_{50:50} = \begin{pmatrix} \frac{1}{\sqrt{2}} & \frac{1}{\sqrt{2}} & 0 \\ \frac{1}{\sqrt{2}} & -\frac{1}{\sqrt{2}} & 0 \\ 0 & 0 & 1 \end{pmatrix}, \quad u_{\text{PS}}(\theta) = \begin{pmatrix} e^{i\theta} & 0 & 0 \\ 0 & 1 & 0 \\ 0 & 0 & 1 \end{pmatrix}, \quad (\text{C3})$$

whilst the cross Kerr non-linearity acts as $U_{\text{K}} = e^{i\phi\hat{n}_1\hat{n}_2}$ and has no matrix representation on the space of modes due to it being non-linear.

If we take the input state as $|\psi_{\text{in}}\rangle = |1, 0, n\rangle = a_0^\dagger(a_2^\dagger)^n|0\rangle/\sqrt{n!}$ then using the linear transformation rule from Eq. (A4) for the ladder operators we see the first phase shifter acts on the top mode to give us

$$|\psi_1\rangle = e^{i\theta}|1, 0, n\rangle. \quad (\text{C4})$$

The tuneable beamsplitter mixes ancillary modes only to give us

$$|\psi_2\rangle = e^{i\theta} \left(\cos \frac{x}{2}|1, 0\rangle - i \sin \frac{x}{2}|0, 1\rangle \right) |n\rangle \quad (\text{C5})$$

The cross Kerr non-linearity acts between 1 and 2 and applies a phase of $e^{in\phi}$ only if mode 1 has a photon in it, so we get

$$|\psi_3\rangle = e^{i\theta} \left(\cos \frac{x}{2}|1, 0\rangle - ie^{in\phi} \sin \frac{x}{2}|0, 1\rangle \right) |n\rangle. \quad (\text{C6})$$

The second beamsplitter mixes modes 0 and 1 only to give

$$\begin{aligned} |\psi_4\rangle &= \frac{e^{i\theta}}{\sqrt{2}} \left[\cos \frac{x}{2} (|1, 0\rangle + |0, 1\rangle) - ie^{in\phi} \sin \frac{x}{2} (|1, 0\rangle - |0, 1\rangle) \right] |n\rangle \\ &= \frac{e^{i\theta}}{\sqrt{2}} \left[\left(\cos \frac{x}{2} - ie^{in\phi} \sin \frac{x}{2} \right) |1, 0\rangle + \left(\cos \frac{x}{2} + ie^{in\phi} \sin \frac{x}{2} \right) |0, 1\rangle \right] |n\rangle. \end{aligned} \quad (\text{C7})$$

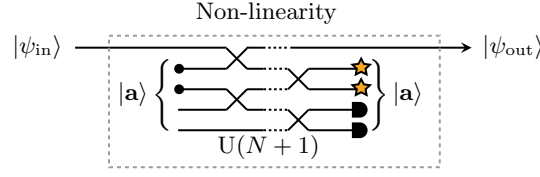

FIG. 15. The measurement-induced non-linearity

If we postselect on the states for which the top two modes are in the state $|1, 0\rangle$, then we have the total output state $P_{10}|\psi_4\rangle/\sqrt{\langle\psi_4|P_{10}|\psi_4\rangle}$, where $P_{10} = |1, 0\rangle\langle 1, 0| \otimes \mathbb{I}$ is the projector. We have

$$\begin{aligned} \langle\psi_4|P_{10}|\psi_4\rangle &= \frac{1}{2} \left| \cos \frac{x}{2} - ie^{in\phi} \sin \frac{x}{2} \right|^2 \\ &= \frac{1}{2} [1 + \sin(x) \sin(n\phi)]. \end{aligned} \quad (\text{C8})$$

which is also the success probability of this non-deterministic gate.

Now we are interested in the case where the Kerr non-linearity parameter is $\phi = \pi$ and $\theta = x/2$, in which case we get $\langle\psi_4|P_{10}|\psi_4\rangle = 1/2$ so the success probability is $1/2$ and the output state of the logical mode is given by

$$\begin{aligned} |\psi_{\text{out}}\rangle &= e^{i\frac{x}{2}} \left(\cos \frac{x}{2} - i(-1)^n \sin \frac{x}{2} \right) |n\rangle \\ &= e^{i\frac{x}{2}} e^{-i\frac{x}{2}(-1)^n} |n\rangle \\ &= e^{iq(n)x} |n\rangle \end{aligned} \quad (\text{C9})$$

which is the desired phase of a DVPS. This concludes the proof of the heralded non-deterministic DVPS with a success probability of $1/2$.

Note that for a DVPS applied to a single mode the phase shift θ is a global phase and is unphysical, however if we were to embed this within a larger interferometric network then this phase would result in physical relative phases which will distort the cost landscapes. Regardless of the choice of θ , as we vary x we would still yield a sinusoidal fermionic cost landscape with unit frequency as the two phases here are $\theta \pm x/2$ and their difference is x , resulting in the desired unit frequency sine wave, see Sec. B 1. To generalise, we could upgrade θ to an additional variational parameter if we wish which may assist when optimising

If the gate fails, as signalled by the ancillary output state $|0, 1\rangle$, we can apply a second DVPS to the output of the failed gate, except with a phase of $2x$ now. If this second attempt is successful it will correct the incorrect phase of the first attempt. We repeat this procedure until success by taking the phase of the n th iteration as $x_n = 2^{n-1}x$ which gives a success probability after n iterations of $1 - 1/2^n$. This is known as the martingale strategy. To do this, we only need to measure the top ancillary mode to tell whether the gate was a success or not, so if no photon is present we know it exited on the lower mode and this photon can be reused for the next iteration. This process is automatic, as the moment the gate fails the ancillary photon is routed into the next gate, whereas if the gate succeeds the ancillary photon is consumed and the remaining gates reduce to the identity as the Kerr interaction is no longer activated.

2. Non-deterministic design with linear optics

In this appendix we give a detailed overview of how to realise the non-deterministic dual-valued phase shifter with linear optics.

On the subspace of at most N photons, sometimes called the N th Fock layer, the dual-valued phase shifter (DVPS) can be represented as an N th degree polynomial in the number operator \hat{n} by using polynomial interpolation: given a function $f(x)$ and a set of $N + 1$ points $\{x_i\}_{i=0}^N$ then there exists a unique K th degree polynomial $P_K(x)$ that intersects the function at these points, i.e., $P_K(x_i) = f(x_i)$ for all $i = 0, 1, \dots, N$, where $K \leq N$. We shall apply this in order to find the polynomial representation of the DVPS. This operator acts as

$$e^{iqx} |n\rangle = e^{iq(n)x} |n\rangle, \quad q(n) = \frac{1}{2}(1 - (-1)^n), \quad (\text{C10})$$

where $|n\rangle$ is a single-mode number state of n photons. Let us first represent the eigenvalues on the N th Fock layer as an N th degree polynomial in n as

$$e^{iq(n)x} \equiv \sum_{m=0}^N a_m(x)n^m, \quad (\text{C11})$$

where $n = 0, 1, \dots, N$. This can be written as a linear equation by interpreting $T_{nm} \equiv n^m$ as the elements of a matrix T , known as a Vandermonde matrix, and the coefficients $a_n(x)$ and values $\exp[ixq(n)]$ as the elements of two vectors. In matrix notation we have

$$\begin{pmatrix} 1 \\ e^{ix} \\ 1 \\ \vdots \end{pmatrix} = \begin{pmatrix} 1 & 0 & 0 & \cdots \\ 1 & 1 & 1 & \cdots \\ 1 & 2 & 4 & \cdots \\ \vdots & \vdots & \vdots & \ddots \end{pmatrix} \begin{pmatrix} a_0(x) \\ a_1(x) \\ a_2(x) \\ \vdots \end{pmatrix}. \quad (\text{C12})$$

Inverting the matrix T allows us to solve for the vector of coefficients $a_m(x)$ giving us the sought after polynomial. Then by replacing the integer n in the polynomial with the number operator \hat{n} we arrive at the alternative expression for the DVPS when restricted to the N th Fock layer.

As an example consider $N = 2$. The DVPS can be written as

$$e^{i\hat{q}x} \equiv 1 - (e^{ix} - 1)\hat{n}(\hat{n} - 2). \quad (\text{C13})$$

We stress that this equivalence is true on the subspace with at most $N = 2$ photons only. On the N th Fock layer we need a polynomial of degree N .

In order to encode this operation on the N th Fock layer, we use the following theorem from Ref. [70].

Theorem 2 (Measurement-induced non-linearities [70]). *Consider an $(N + 1)$ -mode linear optical interferometer encoding a unitary $u \in \text{U}(N + 1)$ consisting of a single logical mode and N ancillary modes, where the logical mode is prepared in the state $|\psi\rangle$ on the n th Fock layer and the ancillary modes are prepared in the single-occupation state $|1, 1, \dots, 1\rangle$. If the output of the ancillary modes is projected onto its input state, then the unnormalised output of the logical mode is $u_{00}^{\hat{n}} P_K(\hat{n})|\psi\rangle$, where $P_K(\hat{n})$ is a polynomial of degree $K = \min\{N, n\}$.*

Proof. We use the index convention that the logical mode is indexed as 0 and the ancillary modes are indexed with $\{1, 2, \dots, N\}$. Consider the input state $|\psi_{\text{in}}\rangle|\mathbf{a}\rangle$, where the logical mode is in an arbitrary state $|\psi_{\text{in}}\rangle$ and the ancillary modes contain a single photon each as $|\mathbf{a}\rangle = |1, 1, \dots, 1\rangle$. Inserting this into an interferometer encoding a unitary $U : \mathcal{F} \rightarrow \mathcal{F}$ and projecting the ancillary modes onto their input state induces an operator $M : \mathcal{F}_0 \rightarrow \mathcal{F}_0$, where \mathcal{F}_0 is the Fock space of the logical mode. This mapping is given by

$$|\psi_{\text{in}}\rangle \mapsto \frac{M|\psi_{\text{in}}\rangle}{\sqrt{\|M|\psi_{\text{in}}\rangle\|}}, \quad M = \langle \mathbf{a} | U | \mathbf{a} \rangle, \quad (\text{C14})$$

where the inner product is a partial inner product on the ancillary mode indices only. The magnitude of $M|\psi_{\text{in}}\rangle$ is the success probability.

The induced operation M conserves particle number. This is because the unitary U encoded by the interferometer is particle-conserving, so if the number of photons in the ancillary modes is conserved, which is the case when projecting onto $|\mathbf{a}\rangle$, then the number of logical photons must not change either. Therefore M is diagonal in the number basis as

$$M = \sum_n \alpha(n) |n\rangle \langle n| = \alpha(\hat{n}), \quad (\text{C15})$$

where α is some function. From Eqs. (C14) and (C15) the function $\alpha(n)$ is given by

$$\alpha(n) = \langle n | M | n \rangle = \langle n | \langle \mathbf{a} | U | n \rangle | \mathbf{a} \rangle. \quad (\text{C16})$$

The n th eigenvalue of M is then the amplitude for the interferometer to leave the state $|n\rangle|\mathbf{a}\rangle$ invariant which of course is given by the permanent from Eq. (A12). We would like to find the functional dependence of this on n so we must expand this out explicitly. We have

$$\begin{aligned} U|n\rangle|\mathbf{a}\rangle &= \frac{1}{\sqrt{n!}} U(a_0^\dagger)^n \prod_{i=1}^N a_i^\dagger |0\rangle \\ &= \frac{1}{\sqrt{n!}} \left(\sum_{i=0}^N u_{i0} a_i^\dagger \right)^n \prod_{i=1}^N \left(\sum_{j=0}^N u_{ji} a_j^\dagger \right) |0\rangle, \end{aligned} \quad (\text{C17})$$

where we have inserted in the linear transformation of the ladder operators of Eq. (A4). We now apply the multinomial theorem to the sum raised to the power of n , to give us

$$U|n\rangle|\mathbf{a}\rangle = \frac{1}{\sqrt{n!}} \sum_{\substack{k_0+\dots+k_N=n \\ k_i \geq 0}} \frac{n!}{k_0!k_1!\dots k_N!} (u_{00}a_0^\dagger)^{k_0} (u_{10}a_1^\dagger)^{k_1} \dots (u_{N0}a_N^\dagger)^{k_N} \prod_{i=1}^N \left(\sum_{j=0}^N u_{ji}a_j^\dagger \right) |0\rangle, \quad (\text{C18})$$

This is a complicated mess of terms, however from Eq. (C16) we are interested in the amplitude for $|n\rangle|\mathbf{a}\rangle$ at the output only, so we look for the coefficient of this term in the expansion. To proceed note that we have two sets of modes: a single logical mode that must be occupied by n photons and N ancillary modes that must each be occupied by a single photon. We can divide up the amplitude into cases where m photons swap between these two subsets, where the number of swaps is upper bounded as $m \leq \min\{N, n\}$.

Consider the amplitude for m swaps. In Eq. (C18) the index k_0 in the sum corresponds to the number of logical photons that remain in the logical mode after the transformation, so we can change variables as $k_0 = n - m$. The indices k_1, \dots, k_N correspond to the logical photons that *did* swap and tell us what ancillary modes they ended up in. As we can have at most one logical photon swapping with an ancillary photon, we have $k_i! = 1$ for $i = 1, \dots, N$. Therefore, we can write

$$\begin{aligned} U|n\rangle|\mathbf{a}\rangle &= \frac{1}{\sqrt{n!}} \sum_{m=0}^{\min\{N, n\}} \frac{n!}{(n-m)!} u_{00}^{n-m} A_m (a_0^\dagger)^n a_1^\dagger a_2^\dagger \dots a_N^\dagger |0\rangle + \dots \\ &= \sum_{m=0}^{\min\{N, n\}} \frac{n!}{(n-m)!} u_{00}^{n-m} A_m |n\rangle|\mathbf{a}\rangle + \dots, \end{aligned} \quad (\text{C19})$$

where A_m is the remainder of the amplitude that corresponds to the transitions made by the remaining photons. If m logical photons and m ancillary photons are swapped, then we have many choices of ancillary photons to swap with. This amplitude is then a sum over all possible subsets of ancillary photons of size m as

$$A_m = \sum_{\substack{T \subseteq \{1, \dots, N\} \\ |T|=m}} \left(\prod_{i \in T} u_{0i} u_{i0} \right) \left(\sum_{\sigma \in S_{N-m}} \prod_{j \notin T} u_{j\sigma(j)} \right). \quad (\text{C20})$$

The first term in parentheses is the amplitude for m logical photons to swap with m ancillary photons from the subset T , where u_{0i} is the amplitude for the logical photon to move to the i th ancillary mode, and u_{i0} is the amplitude for the i th ancillary photon to move to the logical mode. The second term in parentheses corresponds to the amplitude for the ancillary photons that did not swap. These photons transition between the modes $T^C = \{1, \dots, N\} \setminus T$, with only one per mode at the output, and includes all possible permutations of this. This term can be rewritten as a permanent of the submatrix of u with only rows and columns selected from T^C .

Pulling everything together, we have the eigenvalues

$$\alpha(n) = u_{00}^n \sum_{m=0}^{\min\{N, n\}} \frac{n!}{(n-m)!} \frac{1}{u_{00}^m} A_m. \quad (\text{C21})$$

This summation is a polynomial in n of degree $\min\{N, n\}$ as the last term in the sum has the combinatorial factor $n(n-1)\dots(n-\min\{N, n\}+1)$ which is the highest-order term. By replacing all n with the number operator \hat{n} , we arrive at the result that on the n th Fock layer M is given by $u_{00}^{\hat{n}} P_K(\hat{n})$ for $K = \min\{N, n\}$, where P_K is an K th order polynomial. See Fig. 15 for an example of this in action. \square

In general it will not be possible to solve for the generated polynomial analytically, so we resort to numerical methods to find the unitary u that results in the polynomial we seek. In order to do this we reframe the problem into something easier to encode and solve numerically. Suppose we prepare the logical mode in the most general photonic state for a single mode on the N th Fock layer as

$$|\psi_{\text{in}}\rangle = \sum_{n=0}^N c_n |n\rangle, \quad (\text{C22})$$

where $|n\rangle$ is the state consisting of n photons and $\sum_{n=0}^N |c_n|^2 = 1$. We then prepare an N -mode ancillary state $|\mathbf{a}\rangle = |a_1, a_2, \dots, a_N\rangle$. The total state of the logical mode and the ancillary modes is

$$|\psi_{\text{in}}\rangle|\mathbf{a}\rangle = \sum_{n=0}^N c_n |n\rangle|\mathbf{a}\rangle \equiv \sum_{n=0}^N c_n |\mathbf{v}_n\rangle, \quad (\text{C23})$$

where $\mathbf{v}_n = (n, a_1, a_2, \dots, a_N)$. We take the ancillary modes have occupation numbers $a_i \in \{0, 1\}$ only. We now insert this state into an $(N + 1)$ -mode linear interferometer described by a unitary U which acts as Eq. (A4). We have

$$\begin{aligned} U|\psi_{\text{in}}\rangle|\mathbf{a}\rangle &= \sum_{n=0}^N c_n U|\mathbf{v}_n\rangle \\ &= \sum_{n=0}^N \sum_{\mathbf{m} \in \mathbb{N}^{N+1}} c_n \langle \mathbf{m} | U | \mathbf{v}_n \rangle | \mathbf{m} \rangle \\ &= \sum_{n=0}^N \sum_{\mathbf{m} \in \mathbb{N}^{N+1}} \frac{c_n}{\sqrt{\mathbf{m}! n!}} \text{per}(u[\mathbf{m} | \mathbf{v}_n]) | \mathbf{m} \rangle \\ &= \sum_{n=0}^N \frac{c_n}{n!} \text{per}(u[\mathbf{v}_n | \mathbf{v}_n]) | n \rangle | \mathbf{a} \rangle + \dots, \end{aligned} \quad (\text{C24})$$

where in the second line we multiplied by the resolution of the identity in the Fock basis, in the third line we used the permanent formula for the transition amplitudes from Eq. (A12) and used the fact that $\mathbf{v}_n! = n!$ if $a_i \in \{0, 1\}$, and in the final line we pulled out a common factor of $|\mathbf{a}\rangle$. We now measure the ancillary modes and keep the logical state if the ancillary modes are measured in the state $|\mathbf{a}\rangle$. This gives us the unnormalised output state of the logical mode

$$|\psi_{\text{out}}\rangle = \sum_{n=0}^N \frac{c_n}{n!} \text{per}(u[\mathbf{v}_n | \mathbf{v}_n]) | n \rangle, \quad (\text{C25})$$

where the success probability is given by $p = |\langle \psi_{\text{out}} | \psi_{\text{out}} \rangle|^2$. On the other hand, the desired action of the dual-valued phase shifter on the logical mode is given by

$$U_{\text{DVPS}}(x) |\psi_{\text{in}}\rangle = \sum_{n=0}^N c_n e^{iq(n)x} |n\rangle, \quad q(n) = \frac{1}{2}(1 - (-1)^n), \quad (\text{C26})$$

where we have chosen $q(n)$ to take this particular form, however any two-valued real function $q : \mathbb{N} \rightarrow \{a, b\}$ could be used.

Let us assume that we can achieve this operation up to a global phase with measurement-induced non-linearities with a probability of $p_x \in [0, 1]$, so we can write

$$|\psi_{\text{out}}\rangle = \sqrt{p_x} e^{i\alpha_x} U_{\text{DVPS}}(x) |\psi_{\text{in}}\rangle, \quad (\text{C27})$$

where $\alpha_x \in [0, 2\pi)$ is the global phase that in general depends upon x . We see that $|\langle \psi_{\text{out}} | \psi_{\text{out}} \rangle|^2 = p_x$ confirming that p_x is indeed the success probability. If we combine Eqs. (C25), (C26) and (C27) then we must solve for the matrix $u_x \in \text{U}(N + 1)$ that solves the equation

$$\frac{1}{n!} \text{per}(u_x[\mathbf{v}_n | \mathbf{v}_n]) = \sqrt{p_x} e^{i\alpha_x} e^{ixq(n)}, \quad (\text{C28})$$

for all $n = 0, 1, \dots, N$ and $x \in [0, 2\pi)$. Eq. (C28) provides us with N constraints in the form of polynomial equations in the elements of the unitary matrix u_x . Within the space of solutions that satisfy the constraints, we additionally need to find the particular unitary that maximises the success probability $p_x \in [0, 1]$. By setting $n = 0$ in Eq. (C28), the success probability is given by

$$\sqrt{p_x} e^{i\alpha_x} = \text{per}(u_x[\mathbf{v}_0 | \mathbf{v}_0]) \Rightarrow p_x = |\text{per}(u_x[\mathbf{v}_0 | \mathbf{v}_0])|^2. \quad (\text{C29})$$

The problem can then be recast as an optimisation problem for each $x \in [0, 2\pi)$ as

$$\begin{aligned} &\underset{u_x \in \text{U}(N+1)}{\text{maximise}} && p_x = |\text{per}(u_x[\mathbf{v}_0 | \mathbf{v}_0])|^2, \\ &\text{subject to} && \left| \frac{1}{n!} \text{per}(u_x[\mathbf{v}_n | \mathbf{v}_n]) - \text{per}(u_x[\mathbf{v}_0 | \mathbf{v}_0]) e^{ixq(n)} \right|^2 = 0, \quad \forall n = 1, \dots, N. \end{aligned} \quad (\text{C30})$$

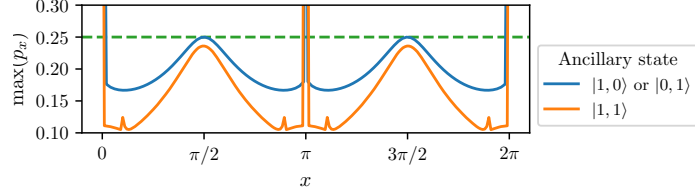

FIG. 16. The maximum success probability p_x for the non-deterministic DVPS versus the phase x for various ancillary input states on the $N = 2$ subspace. We see that the ancillary state $|1,0\rangle$ or $|0,1\rangle$ obtains the upper bound of $1/4$. For $x = 0, \pi$ the gate is deterministic with $p_x = 1$, as here the DVPS is simply the identity or π phase shifter, respectively. Note that the discontinuity in $|1,1\rangle$ happens at $x \approx \pi/10$.

This is a complicated optimisation problem and many methods have been presented in the literature, e.g., Refs. [71, 75–77]. However, for small N this can be solved in a simple manner as we now show.

In the main text we looked at an example for $N = 2$ for the ancillary state $|\mathbf{a}\rangle = |1,0\rangle$. In order to solve the optimisation problem of Eq. (C30) we parametrised our $U(3)$ unitaries by writing them in the exponential form as

$$u(\boldsymbol{\theta}) = \exp\left(i \sum_{\mu=1}^9 \theta_{\mu} T^{\mu}\right), \quad (\text{C31})$$

where $\{T^{\mu}\}_{\mu=1}^9$ is a basis of nine three-dimensional Hermitian matrices that spans the Lie algebra $\mathfrak{u}(3)$ and $\theta_{\mu} \in \mathbb{R}$ parametrise the unitaries. We chose the basis

$$\begin{aligned} T^1 &= \begin{pmatrix} 1 & 0 & 0 \\ 0 & 0 & 0 \\ 0 & 0 & 0 \end{pmatrix}, & T^2 &= \begin{pmatrix} 0 & 0 & 0 \\ 0 & 1 & 0 \\ 0 & 0 & 0 \end{pmatrix}, & T^3 &= \begin{pmatrix} 0 & 0 & 0 \\ 0 & 0 & 0 \\ 0 & 0 & 1 \end{pmatrix} \\ T^4 &= \begin{pmatrix} 0 & 1 & 0 \\ 1 & 0 & 0 \\ 0 & 0 & 0 \end{pmatrix}, & T^5 &= \begin{pmatrix} 0 & 0 & 1 \\ 0 & 0 & 0 \\ 1 & 0 & 0 \end{pmatrix}, & T^6 &= \begin{pmatrix} 0 & 0 & 0 \\ 0 & 0 & 1 \\ 0 & 1 & 0 \end{pmatrix}, \\ T^7 &= \begin{pmatrix} 0 & -i & 0 \\ i & 0 & 0 \\ 0 & 0 & 0 \end{pmatrix}, & T^8 &= \begin{pmatrix} 0 & 0 & -i \\ 0 & 0 & 0 \\ i & 0 & 0 \end{pmatrix}, & T^9 &= \begin{pmatrix} 0 & 0 & 0 \\ 0 & 0 & -i \\ 0 & i & 0 \end{pmatrix}. \end{aligned} \quad (\text{C32})$$

We then solved the constrained optimisation problem of Eq. (C30) by optimising over the parameters θ_{μ} using the Sequential Least Squares Programming (SLSQP) of SciPy’s optimize package on Python. Due to local minima, the optimiser would often return a suboptimal solution, i.e., one which solved the permanent equation constraints but did not maximise p_x , so we repeated the optimisation 500 times per x and returned the solution with the largest value of p_x .

In Fig. 16 we show the maximum probability vs. x for three possible ancillary states $|1,1\rangle$, $|1,0\rangle$ and $|0,1\rangle$. Note that the performance of $|1,0\rangle$ and $|0,1\rangle$ is identical as they can be transformed between with a deterministic linear transformation which does not change the success probability. We see that $|1,0\rangle$ actually outperforms $|1,1\rangle$ and is able to obtain the upper bound of $1/4$ as predicted analytically. In Table II we give a few example unitaries which encode the desired DVPS with phase x on the subspace of at most $N = 2$ photons using the ancillary state $|\mathbf{a}\rangle = |1,0\rangle$, together with the success probability p_x .

We may wonder why the ancillary state $|\mathbf{a}\rangle = |1,0\rangle$ is able to induce the action of the second order polynomial of Eq. (C13) when theorem 2 states that it should induce a polynomial $P_1(\hat{n})$ of degree 1 in the number operator. The reason is that the additional factor of $u_{00}^{\hat{n}}$ boosts the degree of the polynomial by one, giving rise to a polynomial of degree 2 on this Fock layer. More precisely, with a single ancillary photon we generate an operator of the form

$$M = u_{00}^{\hat{n}}(a\hat{n} + b) \quad (\text{C33})$$

which, via polynomial interpolation, is equivalent to a polynomial of degree two on the second Fock layer. If $u_{00} = 1$ then M is just a first order polynomial.

x	u_x	p_x
0	$\begin{pmatrix} 1 & 0 & 0 \\ 0 & 1 & 0 \\ 0 & 0 & 1 \end{pmatrix}$	1
$\pi/8$	$\begin{pmatrix} 0.4376 - 0.3446i & -0.4479 + 0.3954i & 0.0255 + 0.5763i \\ -0.4538 - 0.39i & 0.2225 - 0.3428i & -0.43 + 0.5385i \\ 0.0155 - 0.5757i & -0.4392 - 0.5321i & 0.2717 - 0.3442i \end{pmatrix}$	1/6
$\pi/4$	$\begin{pmatrix} 0.2517 - 0.3920i & -0.6332 + 0.3146i & 0.5144 - 0.1359i \\ -0.7080 + 0.1018i & -0.0896 - 0.4160i & 0.5120 - 0.2123i \\ -0.3028 - 0.4238i & -0.5023 - 0.2584i & -0.6398 - 0.0181i \end{pmatrix}$	2/11
$3\pi/8$	$\begin{pmatrix} 0.1171 - 0.4097i & -0.7931 - 0.0695i & -0.1944 + 0.3832i \\ -0.0499 - 0.7917i & 0.4535 + 0.1013i & -0.3871 - 0.0706i \\ -0.3224 - 0.2919i & -0.3174 - 0.2225i & 0.3428 - 0.7369i \end{pmatrix}$	8/37
$\pi/2$	$\begin{pmatrix} 0.0001 - 0.4146i & 0.7130 + 0.339i & 0.3426 - 0.0321i \\ 0.8046 - 0.2382i & 0.0631 - 0.4962i & 0.0792 + 0.1985i \\ 0.0680 + 0.3455i & -0.1952 - 0.044i & 0.8769 - 0.2588i \end{pmatrix}$	1/4
π	$\begin{pmatrix} -1 & 0 & 0 \\ 0 & 1 & 0 \\ 0 & 0 & 1 \end{pmatrix}$	1

TABLE II. Example unitaries u_x and success probabilities p_x for encoding the dual-valued phase shifter for various x on the Fock layer of $N = 2$, given the ancillary state $|\mathbf{a}\rangle = |1, 0\rangle$. Note that these unitaries have been rounded to four decimal places for presentational purposes.

Now whether the polynomial we generate is what we would like is another matter, which is where the additional empty ancillary mode aids us. This empty ancillary mode allows the submatrix of the encoded unitary u corresponding to the occupied input and output modes to have more freedom. If we have one ancillary photon, then Eq. (C21) gives us the amplitudes

$$\alpha_0 = u_{00}, \quad (\text{C34})$$

$$\alpha_1 = u_{00}u_{11} + u_{01}u_{10}, \quad (\text{C35})$$

$$\alpha_2 = u_{00}^2u_{11} + 2u_{00}u_{01}u_{10}, \quad (\text{C36})$$

and there is enough degrees of freedom in the unitary $u \in \text{U}(3)$ to find one such that $\alpha_n \propto \exp[iq(n)x]$. On the other hand if $u \in \text{U}(2)$, which would be the case if we did not have this additional empty ancillary mode, then we would have the constraint that the columns are orthonormal, so $|u_{00}|^2 + |u_{10}|^2 = |u_{01}|^2 + |u_{11}|^2 = 1$ and $u_{00}u_{11} + u_{10}u_{01} = 0$, and similarly for the rows, which heavily constrains the matrix elements. However, if $u \in \text{U}(N)$ for $N > 2$ then submatrices of the unitaries are not always unitary themselves, so the constraints on the matrix elements are relaxed and we therefore have more freedom to choose the matrix elements to solve these equations. This also makes it clear that once the optimal solution has been found, then additional ancillary modes will not increase the probability as it is only the 2D submatrix that appears in these equations.

Appendix D: Proof of Theorem 1

1. Haar measure moments

In this section we derive some useful identities to be used later.

Lemma 1. *Let $U : \text{U}(N) \rightarrow \text{U}(d)$ be a reducible unitary representation of $\text{U}(N)$ on the vector space V with dimension $\dim(V) = d$ and orthonormal basis $\{|i\rangle\}_{i=1}^d$, where each irreducible representation has a multiplicity of one, then*

$$\int_{\text{U}(N)} du U_{ij}(u) U_{kl}^*(u) = \sum_{\alpha} \frac{1}{d_{\alpha}} P_{ik}^{\alpha} P_{lj}^{\alpha}, \quad (\text{D1})$$

where P^α is the projector onto the irrep α , $U_{ij}(u) = \langle i|U(u)|j \rangle$ and $P_{ij}^\alpha = \langle i|P^\alpha|j \rangle$ are the matrix elements with respect to the orthonormal basis, d_α is the dimension of the irrep α and du is the Haar measure.

Proof. If the representation is reducible there exists a basis that block-diagonalises all $U(u)$ for all $u \in U(N)$. Let this basis be denoted by $\{|\alpha, x, n\rangle\}$, where α labels the irrep, x labels the any multiplicity of the irreps, and n labels the states within this basis are given by

$$\langle \alpha, x, m|U(u)|\beta, y, n \rangle = \delta_{\alpha\beta}\delta_{xy}U_{mn}^\alpha(u), \quad (\text{D2})$$

where U_{mn}^α are the matrix elements of the irrep α . If this irrep has non-trivial multiplicity, we assume that the matrix elements for each one are equal.

Next we introduce a unitary change of basis $C_{i(\alpha,x,m)} = \langle i|\alpha, x, m \rangle$ where the triplet (α, x, m) is viewed as a multi-index. These components are sometimes called Clebsch-Gordon coefficients. We can then rewrite the matrix elements with respect to the original basis as

$$U_{ij}(u) = \langle i|U(u)|j \rangle = \sum_{\alpha} \sum_x \sum_{m,n} C_{i(\alpha,x,m)} C_{j(\alpha,x,n)}^* U_{mn}^\alpha(u). \quad (\text{D3})$$

If we insert this into the integral, we get

$$\begin{aligned} \int_{U(N)} du U_{ij}(u) U_{kl}^*(u) &= \int du \left(\sum_{\alpha} \sum_x \sum_{m,n} C_{i(\alpha,x,m)} C_{j(\alpha,x,n)}^* U_{mn}^\alpha(u) \right) \left(\sum_{\beta} \sum_y \sum_{p,q} C_{k(\beta,y,p)}^* C_{l(\beta,y,q)} U_{pq}^{\beta*}(u) \right) \\ &= \sum_{\alpha,\beta} \sum_{x,y} \sum_{m,n,p,q} C_{i(\alpha,x,m)} C_{j(\alpha,x,n)}^* C_{k(\beta,y,p)}^* C_{l(\beta,y,q)} \underbrace{\int_{U(N)} du U_{mn}^\alpha(u) U_{pq}^{\beta*}(u)}_{\frac{1}{d_\alpha} \delta^{\alpha\beta} \delta_{mp} \delta_{nq}} \\ &= \sum_{\alpha} \frac{1}{d_\alpha} \sum_{x,y} \sum_{m,n} C_{i(\alpha,x,m)} C_{j(\alpha,x,n)}^* C_{k(\alpha,y,m)}^* C_{l(\alpha,y,n)}, \end{aligned} \quad (\text{D4})$$

where we use the orthogonality relationship of matrix elements of irreps [95] to evaluate the integral in the second line and d_α is the dimension of the irrep α . Define the operator

$$P_{xy}^\alpha = \sum_m |\alpha, x, m\rangle \langle \alpha, y, m|, \quad (\text{D5})$$

so we can rewrite the integral as

$$\int_{U(N)} du U_{ij}(u) U_{kl}^*(u) = \sum_{\alpha} \sum_{x,y} \frac{1}{d_\alpha} (P_{xy}^\alpha)_{ik} (P_{yx}^\alpha)_{lj}. \quad (\text{D6})$$

Additionally, if we assume that the multiplicity of each irrep is unity then we can drop the indices x and y , we then get

$$\int_{U(N)} du U_{ij}(u) U_{kl}^*(u) = \sum_{\alpha} \frac{1}{d_\alpha} P_{ik}^\alpha P_{lj}^\alpha, \quad (\text{D7})$$

where P_{ij}^α are the matrix elements of the projector onto irrep α . □

Lemma 2. Let $U : U(N) \rightarrow U(d)$ be a reducible representation of $U(N)$ on the vector space V with dimension $\dim(V) = d$ and orthonormal basis $\{|i\rangle\}_{i=1}^d$, where each irreducible representation has a multiplicity of one, and let A be a linear operator on V then

$$I = \int_{U(N)} du U(u) A U^\dagger(u) = \sum_{\alpha} \frac{1}{d_\alpha} \text{Tr}(P^\alpha A) P^\alpha. \quad (\text{D8})$$

Proof. Let us calculate the matrix elements of I . We have

$$\begin{aligned}
I_{ij} &= \int_{\mathbf{U}(N)} du \sum_{k,l} U_{ik}(u) A_{kl} U_{lj}^\dagger(u) \\
&= \sum_{k,l} A_{kl} \int_{\mathbf{U}(N)} du U_{ik}(u) U_{jl}^*(u) \\
&= \sum_{k,l} A_{kl} \sum_{\alpha} \frac{1}{d_{\alpha}} P_{lk}^{\alpha} P_{ij}^{\alpha} \\
&= \sum_{\alpha} \frac{1}{d_{\alpha}} \text{Tr}(P^{\alpha} A) P_{ij}^{\alpha}.
\end{aligned} \tag{D9}$$

where in the third equality we used Lemma 1. □

2. Calculating the variance

Given a state ρ and an observable H , the cost function is defined as

$$E(\boldsymbol{\theta}) = \text{Tr} [U(\boldsymbol{\theta}) \rho U^\dagger(\boldsymbol{\theta}) H]. \tag{D10}$$

We calculate the variance of this quantity by assuming that our parametrised unitaries $U(\boldsymbol{\theta})$ form a 2-design, so averaging over the parameters is equivalent to averaging the unitaries with respect to the Haar measure [16]. In other words, given some operator A on a t -fold tensor product space and an ensemble of parametrised unitaries $\{p(\boldsymbol{\theta}), U(\boldsymbol{\theta})\}$ then

$$\int d\boldsymbol{\theta} p(\boldsymbol{\theta}) U^{\otimes t}(\boldsymbol{\theta}) A U^{\dagger \otimes t}(\boldsymbol{\theta}) = \int_{\mathbf{U}(N)} du U^{\otimes t}(u) A U^{\dagger \otimes t}(u). \tag{D11}$$

where du is the Haar measure. This assumption is perfectly valid to make in linear optics, because we can use a universal linear interferometer which can encode any linear unitary, so we can sample with respect to the Haar measure. Let us assume that our unitaries form a representation of $\mathbf{U}(N)$ as $U = U(u)$, where $u \in \mathbf{U}(N)$. Then the first moment of the cost function is given by

$$\begin{aligned}
\mathbb{E}_{\boldsymbol{\theta}}[E(\boldsymbol{\theta})] &= \int d\boldsymbol{\theta} p(\boldsymbol{\theta}) \text{Tr}(U(\boldsymbol{\theta}) \rho U^\dagger(\boldsymbol{\theta}) H) \\
&= \int_{\mathbf{U}(N)} du \text{Tr}(U(u) \rho U^\dagger(u) H) \\
&= \text{Tr} \left[\left(\int_{\mathbf{U}(N)} du U(u) \rho U^\dagger(u) \right) H \right] \\
&= \text{Tr} \left[\frac{1}{d} \text{Tr}(\rho) H \right] \\
&= \frac{1}{d} \text{Tr}(H)
\end{aligned} \tag{D12}$$

where going from the third to the fourth line we used Lemma 2 and the fact that the projectors are the identity as $U(u)$ forms an irrep and d is the dimension of the Hilbert space, and going to the final line we used the fact that $\text{Tr}(\rho) = 1$.

The second moment gives us

$$\begin{aligned}
\mathbb{E}_{\boldsymbol{\theta}}[E^2(\boldsymbol{\theta})] &= \int d\boldsymbol{\theta} p(\boldsymbol{\theta}) \text{Tr} [U(\boldsymbol{\theta})\rho U^\dagger(\boldsymbol{\theta})H]^2 \\
&= \int_{\text{U}(N)} du \text{Tr} [U(u)\rho U^\dagger(u)H]^2 \\
&= \int_{\text{U}(N)} du \text{Tr} [U(u)\rho U^\dagger(u)H \otimes U(u)\rho U^\dagger(u)H] \\
&= \int_{\text{U}(N)} du \text{Tr} [U^{\otimes 2}(u)\rho^{\otimes 2}U^{\dagger \otimes 2}(u)H^{\otimes 2}] \\
&= \text{Tr} \left[\left(\int_{\text{U}(N)} du U^{\otimes 2}(u)\rho^{\otimes 2}U^{\dagger \otimes 2}(u) \right) H^{\otimes 2} \right] \\
&= \text{Tr} \left[\sum_{\alpha} \frac{1}{d_{\alpha}} \text{Tr} (P^{\alpha} \rho^{\otimes 2}) P^{\alpha} H^{\otimes 2} \right] \\
&= \sum_{\alpha} \frac{1}{d_{\alpha}} \text{Tr} (P^{\alpha} \rho^{\otimes 2}) \text{Tr} (P^{\alpha} H^{\otimes 2})
\end{aligned} \tag{D13}$$

where going from the second to the third line we used the fact that $\text{Tr}(A)^2 = \text{Tr}(A \otimes A)$, going from the fifth to the sixth line we used Lemma 2 and noted that $U^{\otimes 2}(u) \equiv U(u) \otimes U(u)$ forms a reducible tensor product representation and we made the assumption that each irrep has unit multiplicity in anticipation of applying this to linear optics. The second moment result was derived independently in the work of Ref. [96].

Pulling everything together, the variance is given by

$$\text{Var}_{\boldsymbol{\theta}}[E(\boldsymbol{\theta})] = \sum_{\alpha} \frac{1}{d_{\alpha}} \text{Tr} (P^{\alpha} \rho^{\otimes 2}) \text{Tr} (P^{\alpha} H^{\otimes 2}) - \frac{\text{Tr}^2(H)}{d^2}. \tag{D14}$$

which concludes the proof of Theorem 1.

3. Application to linear optics

a. Representations of linear optics

In linear optics, if we have an N -mode interferometer and n particles, then we have a representation is defined of $\text{U}(N)$ on the Fock space \mathcal{F} . This representation acts on the ladder operators in the Heisenberg picture as

$$U(u)a_i^\dagger U^\dagger(u) = \sum_{j=1}^N u_{ji} a_j^\dagger \tag{D15}$$

To see this is a representation, we have explicitly

$$\begin{aligned}
U(v)U(u)a_i^\dagger U^\dagger(u)U^\dagger(v) &= \sum_{j=1}^N u_{ji} U(v)a_j^\dagger U^\dagger(v) \\
&= \sum_{j=1}^N \sum_{k=1}^N u_{ji} v_{kj} a_k^\dagger \\
&= \sum_{k=1}^N (vu)_{ki} a_k^\dagger \\
&= U(vu)a_i^\dagger U^\dagger(vu)
\end{aligned} \tag{D16}$$

therefore, $U(v)U(u) = U(vu)$ and $U(\mathbb{I}_N) = \mathbb{I}_d$, where d is the dimension of the representation. Moreover, this representation commutes with the total number operator as

$$\begin{aligned} U \left(\sum_{i=1}^N a_i^\dagger a_i \right) U^\dagger &= \sum_{i=1}^N \sum_{k=1}^N \sum_{l=1}^N u_{ji} u_{ki}^* a_j^\dagger a_k \\ &= \sum_{j=1}^N \sum_{k=1}^N (uu^\dagger)_{jk} a_j^\dagger a_k \\ &= \sum_{k=1}^N a_k^\dagger a_k \end{aligned} \quad (\text{D17})$$

Therefore, the subspace of fixed particle number is an invariant subspace under the action of U .

Let $V = \mathbb{C}^N$ be the Hilbert space of a single particle in an interferometer of N modes, the Fock space \mathcal{F} , and the representation of $U(N)$, decomposes as

$$\mathcal{F} = \bigoplus_n \mathcal{H}_n, \quad \mathcal{H}_n = \begin{cases} \text{Sym}^n(V) & \text{bosons} \\ \wedge^n(V) & \text{fermions} \end{cases}, \quad \dim(\mathcal{H}_n) = \begin{cases} \binom{N+n-1}{n} & \text{bosons} \\ \binom{N}{n} & \text{fermions} \end{cases}, \quad (\text{D18})$$

where \mathcal{H}_n is the n -particle subspace and $(\wedge^n) \text{Sym}^n$ is the (anti-)symmetrisation n -fold tensor product operation. Importantly, these subspaces forms *irreducible* representations. This can be seen quite simply: the general form of the linear optical transformation is given by the exponential of a quadratic Hamiltonian that can be rewritten as

$$\begin{aligned} U &= \exp \left(i \sum_{i,j} h_{ij} a_i^\dagger a_j \right) \\ &= \exp \left(i \sum_i h_{ii} a_i^\dagger a_i + i \sum_{i>j} R_{ij} (a_i^\dagger a_j + a_j^\dagger a_i) + i I_{ij} (a_i^\dagger a_j - a_j^\dagger a_i) \right) \\ &= \exp \left(i \sum_i h_{ii} \hat{n}_i + i \sum_{i>j} (R_{ij} X_{ij} + I_{ij} Y_{ij}) \right) \end{aligned} \quad (\text{D19})$$

where $h_{ij} = R_{ij} + iI_{ij}$ for $i \neq j$ and $h_{ii} \in \mathbb{R}$. The corresponding Lie algebra representation \mathfrak{g} is given by the tangent vectors to the identity which is $\mathfrak{g} = \text{span}_{\mathbb{R}}\{\hat{n}_i, X_{ij}, Y_{ij}\}$. There are N^2 generators in total and these obey the $U(N)$ algebra.

We now complexify the Lie algebra by taking complex linear combinations of the generators. We can divide the generators into the Cartan subalgebra of mutually commuting generators $\mathfrak{h} = \text{span}_{\mathbb{C}}\{\hat{n}_i\}_{i=1}^N$, and the remaining generators we take linear combinations of to form ladder operators as

$$E_{ij}^\dagger = \frac{1}{2}(X_{ij} + iY_{ij}) = a_i^\dagger a_j, \quad (i < j), \quad (\text{D20})$$

of which there are $N(N-1)/2$. The lowering ladder operators are given by the Hermitian conjugate, E_{ij} . These obey

$$[H_i, E_{jk}^\dagger] = \begin{cases} 0 & \text{if } i \neq j \text{ and } i \neq k, \\ E_{jk}^\dagger & \text{if } i = j, \\ -E_{jk}^\dagger & \text{if } i = k \end{cases}, \quad [H_i, E_{jk}] = \begin{cases} 0 & \text{if } i \neq j \text{ and } i \neq k, \\ -E_{jk} & \text{if } i = j \\ E_{jk} & \text{if } i = k, \end{cases} \quad (\text{D21})$$

The highest-weight state is defined as the state $|\lambda\rangle$ that is annihilated by all raising operators. For n particles in N modes this is given by

$$|\lambda\rangle = \begin{cases} |n, 0, \dots, 0, 0, \dots, 0\rangle & \text{bosons} \\ |\underbrace{1, 1, \dots, 1}_n, 0, \dots, 0\rangle & \text{fermions} \end{cases} \quad (\text{D22})$$

as $E_{ij}^\dagger |\lambda\rangle = 0$ for all $i > j$. This representation is irreducible, as every state in \mathcal{H}_n can be reached by applying lowering operators E_{ij} to $|\lambda\rangle$. This is because the lowering operators allow us to shuffle the particles around the modes as they

take the form of hopping operators. In conclusion, there is no basis that block diagonalises the generators, hence it is an irrep.

Without loss of generality we can study the barren plateau problem by restricting ourselves to the n -particle subspace \mathcal{H}_n as in a linear optics experiment the number of particles will be fixed anyway. Referring back to Theorem , we see that calculation of the variance requires us to perform a *fourth* moment integral in the matrix elements of the representation, which is equivalent to a *second* moment calculation in the tensor product representation instead and is given in terms of a sum over irreps of this tensor product. Therefore, we must understand how $\mathcal{H}_n \otimes \mathcal{H}_n$ decomposes into irreps under $U(N)$.

b. Young Tableaux

This section follows Ref. [95]. The n -particle subspace \mathcal{H}_n is irreducible and the irreps of its tensor products can be found quite easily using Young's tableaux. We introduce the notation (n_1, n_2, \dots, n_N) to denote a Young tableau with n_1 boxes in its first row, n_2 in its second row, and so on, where $n_1 \geq n_2 \geq \dots \geq n_N$ and $n_1 + n_2 + \dots + n_N = n$ always, in which case each tableau corresponds to a partition of the integer n . If we have k consecutive rows containing n elements we can use the notation n^k . For example

$$(2) = \begin{array}{|c|c|} \hline \square & \square \\ \hline \end{array} \quad (3, 2) = \begin{array}{|c|c|c|} \hline \square & \square & \square \\ \hline \square & \square & \\ \hline \end{array} \quad (4, 2^2, 1) = \begin{array}{|c|c|c|c|} \hline \square & \square & \square & \square \\ \hline \square & \square & & \\ \hline \square & \square & & \\ \hline \square & & & \\ \hline \end{array} \quad (2^2, 1^2) = \begin{array}{|c|c|} \hline \square & \square \\ \hline \square & \square \\ \hline \square & \\ \hline \square & \\ \hline \end{array} \quad (D23)$$

Given a Young tableau, its dimension is given by $d = F/H$, where

$$F = \prod_{i,j} F_{ij}, \quad H = \prod_{i,j} H_{ij}, \quad (D24)$$

where F_{ij} is a value assigned to each box (i, j) in the diagram by first inserting an N in the top left box and then increase the value by one as we move one step to the right or decreasing by one as we move one step down, and H_{ij} is the hook factor of the box (i, j) defined by first drawing a hook-shaped line that starts directly below it at the bottom of the column, turning right turn on the box at (i, j) , and moving out to the right and then counting number of boxes this line passes through. For example for (m, n) we have

$$\begin{array}{|c|c|c|c|c|c|c|} \hline N & N+1 & \dots & N+n-1 & N+n & \dots & N+m-1 \\ \hline N-1 & N & \dots & N+n-2 & & & \\ \hline \end{array} \quad F = \frac{(N+m-1)!}{(N-1)!} \cdot \frac{(N+n-2)!}{(N-2)!} \quad (D25)$$

$$\begin{array}{|c|c|c|c|c|c|c|} \hline m+1 & m & \dots & m-n+2 & m-n & \dots & 1 \\ \hline n & n-1 & \dots & 1 & & & \\ \hline \end{array} \quad H = \frac{n!(m+1)!}{(m-n+1)!} \quad (D26)$$

so the dimension is given by

$$d(m, n) = \binom{N+m-1}{m} \binom{N+n-2}{n} \frac{m-n+1}{m+1}. \quad (D27)$$

If we repeat this calculation for Tableau with two columns instead, the dimension is given by

$$d(2^m, 1^n) = \binom{N}{m+n} \binom{N+1}{m} \frac{(m+n)!m!}{(m+1)!n!}. \quad (D28)$$

c. Derivation of examples

The Young tableaux corresponding to the bosonic and fermionic representation spaces \mathcal{H}_n have the tableaux $\text{Sym}^n(V) = (n)$ and $\wedge^n(V) = (1^n)$ respectively. Diagrammatically, these are a single row or column of n boxes

respectively. As required for evaluating the variance of the cost function in Eq. (D14), we need to understand how the tensor product representations $\mathcal{H}_n \otimes \mathcal{H}_n$ decompose into irreps. This can be calculated straightforwardly using the rules for tensoring Young tableaux, see Ref. [95], which give

$$\text{Sym}^n(V) \otimes \text{Sym}^n(V) = \bigoplus_{\alpha=0}^n (2n - \alpha, \alpha), \quad (\text{D29})$$

so the irreps are given by $\mathcal{H}_\alpha = (2n - \alpha, \alpha)$. For fermions we have

$$\wedge^n(V) \otimes \wedge^n(V) = \bigoplus_{\alpha=0}^n (2^\alpha, 1^{2n-2\alpha}), \quad (\text{D30})$$

so the irreps are given by $\mathcal{H}_\alpha = (2^\alpha, 1^{2n-2\alpha})$, where the upper limit on the direct sum assumes that $n \leq N$ because a tableau with more than N boxes is not allowed in a column as they are anti-symmetrised over. Each term in the direct sum is an irrep and has multiplicity one.

We evaluate the variance of Eq. (D14) for three examples used in Fig. 2. For all examples we take our measurement observable H to be a projector onto the input state.

1. Let us consider fermionic statistics and prepare the system in the n -fermion pure state where we place a single particle in the first n modes as

$$|\psi_{\text{in}}\rangle = a_1^\dagger a_2^\dagger \dots a_n^\dagger |0\rangle \in \wedge^n(V) \quad (\text{D31})$$

This state has the weight $\lambda = (1, 1, \dots, 1, 0, \dots, 0)$ containing n ones which is also the highest-weight state of $\wedge^n(V)$. The tensor product state $|\psi_{\text{in}}\rangle \otimes |\psi_{\text{in}}\rangle$ is the highest weight state of the tensor product representation $\wedge^n(V) \otimes \wedge^n(V)$ with weight 2λ . Therefore, this state has support on only one irrep, namely the irrep corresponding to the Young Tableau (2^n) which contains two columns of length n . A rigorous proof of this statement can be found in Supplementary Lemma 3 of Ref. [60]. This means that the sum over the irreps in Eq. (D14) reduces to a single term and the projector acts on the state as the identity, leaving us with the trace of a projector which is unity. This gives us

$$\begin{aligned} \text{Var}_\theta[E(\theta)] &= \frac{1}{d_{(2^n)}} - \frac{1}{d_n^2} \\ &= \frac{(N - n + 1)(n + 1)}{N + 1} \frac{1}{\binom{N}{n}^2} - \frac{1}{d_n^2} \\ &= \frac{1}{d_n^2} \frac{n(N - n)}{N + 1} \end{aligned} \quad (\text{D32})$$

where we used the fact that $\binom{N}{n} = d_n$ which is the dimension of the Hilbert space of n fermions and N modes and used the dimension of the irreps from Eq. (D28).

2. Now let us consider bosonic statistics and prepare the system in the n -boson state where we place all n bosons into the first mode as

$$|\psi_{\text{in}}\rangle = \frac{1}{\sqrt{n!}} (a_1^\dagger)^n |0\rangle \in \text{Sym}^n(V). \quad (\text{D33})$$

Just like the in example 1, this state is the highest weight state of $\text{Sym}^n(V)$ so following a similar argument to above and generalising Supplementary Lemma 3 of Ref. [60], we find that the only irrep contributing anything non-trivial is the one with the Young Tableau $(2n)$ which contains $2n$ boxes in a single row. An intuitive reason why this is the only irrep that the state has support on is because the state $|\psi_{\text{in}}\rangle \otimes |\psi_{\text{in}}\rangle$ is completely symmetric on permutation of all $2n$ bosons, so it must be an element of $\text{Sym}^{2n}(V)$ which has the tableau $(2n)$ and any anti-symmetrisation will annihilate the state. In this case, the variance is

$$\begin{aligned} \text{Var}_\theta[E(\theta)] &= \frac{1}{d_{(2n)}} - \frac{1}{d_n^2} \\ &= \frac{1}{\binom{N+2n-1}{2n}} - \frac{1}{d_n^2} \\ &= \frac{1}{d_{2n}} - \frac{1}{d_n^2} \end{aligned} \quad (\text{D34})$$

where we used the dimension formula from Eq. (D27) fact that $d_{2n} = \binom{N+2n-1}{2n}$.

3. The third example is where we take the same state as in example 1, but with bosonic statistics as

$$|\psi_{\text{in}}\rangle = a_1^\dagger a_2^\dagger \dots a_n^\dagger |0\rangle \in \text{Sym}^n(V). \quad (\text{D35})$$

This is the most relevant bosonic input state for linear optics in a real experiment, as this state is produced by a single-photon source together with a demultiplexer. The difference now is that because of the bosonic statistics and the way the tensor product decomposes into irreps, the state $|\psi_{\text{in}}\rangle \otimes |\psi_{\text{in}}\rangle$ has overlap with multiple irreps, so here we simply provide an upper bound to the variance. The state $|\psi_{\text{in}}\rangle \otimes |\psi_{\text{in}}\rangle$ is an element of the tensor product representation that decomposes as

$$\text{Sym}^n(V) \otimes \text{Sym}^n(V) = \text{Sym}^2(\text{Sym}^n(V)) \oplus \wedge^2(\text{Sym}^n(V)). \quad (\text{D36})$$

As $|\psi_{\text{in}}\rangle \otimes |\psi_{\text{in}}\rangle$ is symmetric under swaps across the tensor product, it must be an element of $\text{Sym}^2(\text{Sym}^n(V))$ which decomposes into irreps as

$$\text{Sym}^2(\text{Sym}^n(V)) = \bigoplus_{\text{even } \alpha} (2n - \alpha, \alpha). \quad (\text{D37})$$

In other words, it is the irreps of Eq. (D29) with even α . Therefore, the variance is given by

$$\text{Var}_{\boldsymbol{\theta}}[E(\boldsymbol{\theta})] = \sum_{\text{even } \alpha} \frac{1}{d_\alpha} \text{Tr}(P^\alpha \rho^{\otimes 2}) \text{Tr}(P^\alpha H^{\otimes 2}) - \frac{\text{Tr}^2(H)}{d_n^2}, \quad (\text{D38})$$

where $\rho = H = |\psi_{\text{in}}\rangle\langle\psi_{\text{in}}|$. As shown in Ref. [96] this projection can be evaluated to give us

$$\text{Tr}(P^\alpha \rho^{\otimes 2}) = 2^{n-\alpha} \frac{2n - 2\alpha + 1}{2n - \alpha + 1} \frac{\binom{n}{\alpha/2}}{\binom{2n-\alpha}{n-\alpha/2}}. \quad (\text{D39})$$

Therefore, inserting this into the expression for the variance gives us

$$\text{Var}_{\boldsymbol{\theta}}[E(\boldsymbol{\theta})] = \sum_{\text{even } \alpha} \frac{4^{n-\alpha}}{d_\alpha} \left(\frac{2n - 2\alpha + 1}{2n - \alpha + 1} \frac{\binom{n}{\alpha/2}}{\binom{2n-\alpha}{n-\alpha/2}} \right)^2 - \frac{1}{d_n^2}. \quad (\text{D40})$$