

Automatic layout of railroad diagrams

SHARDUL CHIPLUNKAR and CLÉMENT PIT-CLAUDEL, EPFL, Switzerland

Railroad diagrams (also called “syntax diagrams”) are a common, intuitive visualization of grammars, but limited tooling and a lack of formal attention to their layout mostly confines them to hand-drawn documentation. We present the first formal treatment of railroad diagram layout along with a principled, practical implementation. We characterize the problem as compiling a *diagram language* (specifying conceptual components and how they connect and compose) to a *layout language* (specifying basic graphical shapes and their sizes and positions). We then implement a compiler that performs *line wrapping* to meet a target width, as well as vertical *alignment* and horizontal *justification* per user-specified policies. We frame line wrapping as an optimization problem, where we describe principled dimensions of optimality and implement corresponding heuristics. For front-end evaluation, we show that our diagram language is well-suited for common applications by describing how regular expressions and Backus-Naur form can be compiled to it. For back-end evaluation, we argue that our compiler is practical by comparing its output to diagrams laid out by hand and by other tools.

CCS Concepts: • **Human-centered computing** → **Visualization**; • **Software and its engineering** → *Software notations and tools*; • **Theory of computation** → *Formal languages and automata theory*.

Additional Key Words and Phrases: syntax diagram, graph layout, line wrapping, pretty-printing

ACM Reference Format:

Shardul Chiplunkar and Clément Pit-Claudel. 2025. Automatic layout of railroad diagrams. In *Proceedings of To Be Determined (TBD '25)*. ACM, New York, NY, USA, 29 pages. <https://doi.org/XXXXXXX.XXXXXXX>

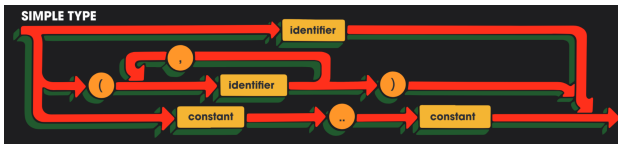

(a) [Kamifuji and Raskin 1979]

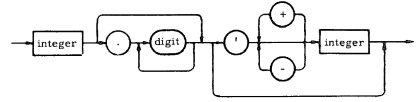

(b) [Wirth 1970]

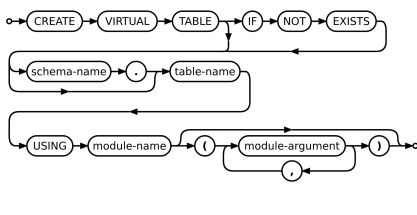

(c) [SQLite contributors 2024]

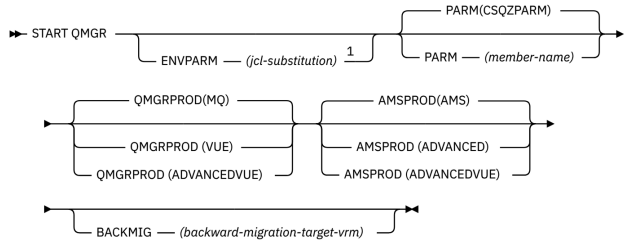

(d) [IBM Corporation 2025]

Fig. 1. Examples of railroad diagrams in published works. Others pictured later include [Ecma 2017] in Fig. 2, [Crockford 2001] in Fig. 5b, and [Krishnamurthy 2025] in Fig. 26. All were laid out by hand.

Authors’ Contact Information: [Shardul Chiplunkar](mailto:shardul.chiplunkar@epfl.ch), shardul.chiplunkar@epfl.ch; [Clément Pit-Claudel](mailto:clement.pit-claudel@epfl.ch), clement.pit-claudel@epfl.ch, School of Computer and Communication Sciences, EPFL, Lausanne, Switzerland.

TBD '25, Lausanne, Switzerland

2025. ACM ISBN 978-x-xxxx-xxxx-x/YYYY/MM

<https://doi.org/XXXXXXX.XXXXXXX>

1 Introduction

Railroad diagrams, also called *syntax diagrams*, are a class of schematic visualizations of formal grammars. Common uses include documenting general-purpose and domain-specific languages (Fig. 1) and teaching and illustrating regular languages [Avallone 2020; Hinze 2019]. While some sources like [Burroughs Corporation 1972] explain how to read the diagrams, many do not—including [Wirth 1970], despite being the first (to our knowledge) published instance.¹ This suggests that railroad diagrams have been considered intuitive or common enough to need no explanation since at least 1970.

There has been some recent interest in the formal semantics of railroad diagrams and similar diagrammatic calculi [Alur et al. 2023; Hinze 2019; Piedeleu and Zanasi 2023], but the problem of actually drawing them has not received much formal attention. To make that problem more precise, we will use the terms *diagram*, *layout*, and *rendering* as follows:

- A *diagram* is a conceptual specification in terms of components and how they connect and compose. A diagram has no height, width, or other visual properties, but it has structure.
- A *layout* is a graphical specification in terms of basic shapes and their sizes and positions. It has visual properties like height and width, but also retains structure from which the original diagram can be recovered. It is the result of *laying out* a diagram, possibly under constraints like width. The same diagram can have many different layouts, as illustrated in Fig. 2.
- A *rendering* is the concrete realization of a layout, in a format that can be directly displayed (like a bitmap) or executed for display (like canvas drawing instructions).

A diagram cannot be directly rendered, but must first be laid out. Yet, to have a visual reference when discussing diagrams or partially laid-out diagrams, we will use simple layouts rendered with dashed red lines to distinguish them from layouts *qua* layouts rendered in solid black. Except where noted, all solid black layouts are generated by the tool we describe in this paper, while dashed red layouts may be partly built by hand (e.g. to illustrate ill-formed intermediate states).

1.1 Contributions

We formalize and develop an algorithm for *railroad layout*, i.e. laying out railroad diagrams:

1. We define a diagram language and a layout language (§2.1, §2.2) that lets us precisely specify railroad layout as compilation from the former to the latter (§2.4).
2. We show that our formalism is realistic despite being simple: it captures most of the variation in hand-drawn railroad diagrams and guides the design of a practical algorithm.
3. We design a three-step compilation algorithm, illustrated in Fig. 3, consisting of vertical *alignment*, then *wrapping* to meet a target width, and finally horizontal *justification*.
4. We frame wrapping as parametric optimization and develop practical heuristics (§3.2).
5. We implement the compiler that we describe.

First, we present our formalism (§2) and then our algorithm (§3), although the two evolved together in reality. Then, we argue that our formalism is realistic by showing that common grammar

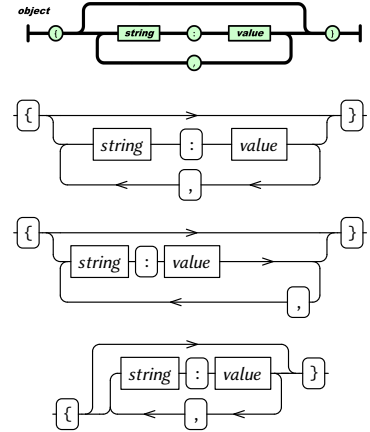

Fig. 2. A railroad diagram has many possible layouts. The topmost is from [Ecma 2017]; the rest from our tool.

¹See [Steele 2017] for further evidence for this being the first usage.

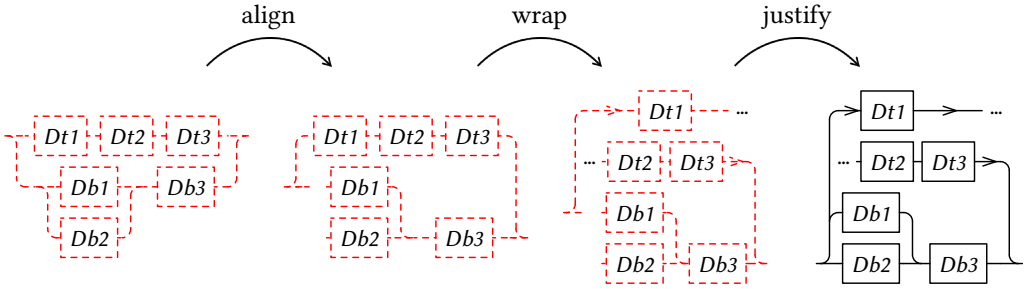

Fig. 3. Our three-step algorithm for compiling a diagram to a layout. §3 describes the process in detail.

notations are easy to translate to our diagram language (§4.1) and that most manual layouts can be expressed in our layout language (§4.2). We further argue that our algorithm compares favorably to manual layout, going beyond existing tools (§4.3) while being performant enough for interactive use (§4.4). Lastly, we discuss how prior work in layout and diagramming relates to ours (§5).

1.2 Background

Railroad layout is a *1.5-dimensional* layout problem: intermediate between 1- and 2-dimensional ones. Yet, compared to the extensive prior work on those problems, railroad layout is underexplored.

On one hand, railroad layout is similar to 1-dimensional text layout in that components generally follow the reading order of text (for English, first left-to-right, then top-to-bottom), and that their linear flow must be wrapped across rows to fit a target width [Bird 1986; de Moor and Gibbons 1999; Kenninga 2003; Knuth and Plass 1981; Peels et al. 1985]. Another related 1-dimensional problem is code pretty-printing, where in addition to obeying reading order and width constraints, the layout must systematically reflect the structure of the source term [Bernardy 2017; Hughes 1995; Oppen 1980; Porncharoenwase et al. 2023; Pugh and Sinofsky 1987; Swierstra and Chitil 2009; Wadler 2003]. Railroad layout also resembles box layout for the wrapped 1-dimensional layout of flexible 2-dimensional boxes (possibly box layouts themselves) [Ciancarini et al. 2011; Hurst and Marriott 2008; Jacobs et al. 2003; Johari et al. 1997; W3C 2018], discussed in more detail in §5. All these problems have secondary objectives besides width, like minimizing wasted space or visual imbalance. However, railroad layout goes beyond what they can achieve, because a row can split into two rows that independently follow the reading order until they merge, or turn backwards.

On the other hand, railroad diagrams can be seen as labeled directed graphs or finite-state automata with stylized 2-dimensional layouts, but with many restrictions: for instance, all published railroad layouts we found have exactly one start and end point and no crossing edges. Conventional presentations of graphs and automata are much less rigid than railroad layouts, whether done by hand or by standard graph layout algorithms [Graphviz contributors 2022; Tamassia 2013; yWorks 2025]. Series-parallel graphs and layouts come closest; we discuss them in §5.

The novelty of our solution lies in its practical, principled approach to automatic railroad layout, notably for wrapping. When used as static documentation, railroad diagrams are often laid out and updated by hand (e.g. Figs. 1 and 5 except 5d). Manual layout is tedious, slow, and hard to update, especially when reflowing a wrapped layout or maintaining differently-wrapped layouts for different media. Worse, it is prone to semantic errors and stylistic inconsistencies (e.g. Figs. 22 and 23). Beyond addressing these problems with automation, our tool can also reproduce many existing manual layouts and produce comparable alternatives for the rest, making it a practical replacement. Similarly, any automated tool could bring railroad diagrams to exploratory or interactive settings; ours is unique in its principled approach with interactive proof assistants in mind, aiming for

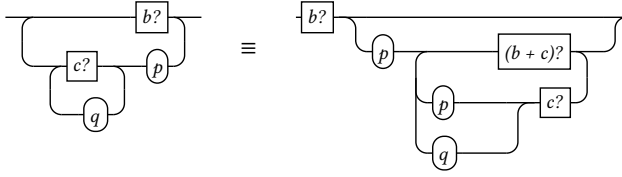

Fig. 4. Railroad-style layout is versatile. Above, we illustrate a theorem that [Kozen 1997, §3.4] states as algebra: $(bp(cq)^*\bar{c})^*\bar{b} \equiv bp((b+c)(cq+\bar{c}p))^*\bar{b}+\bar{c}+\bar{b}$. Here, b, c are Boolean tests and p, q are arbitrary KAT terms. In our diagrammatic notation, a boxed $b?$ selects the lower path after it iff b is true.

convenient layout “idioms” and “cost-benefit balance” [Chiplunkar and Pit-Claudel 2023]. For instance, few other tools perform automatic wrapping, and none let the user control it.

Formalism has long served as a tool for clarity of thought and computational expression in layout research, and we follow suit. Almost all pretty-printers have had formalism at their core, from the seminal [Open 1980] to the modern [Porncharoenwase et al. 2023]. Text wrapping, building on the success of [Knuth and Plass 1981], has been cast as a model problem for formalism-driven programming [Bird 1986; de Moor and Gibbons 1999]. Formal techniques have recently also been applied to web layout [Panchekha et al. 2019; Panchekha and Torlak 2016]. Following in this tradition, our formal approach enables our own work as well as any future study of railroad layout.

Finally, railroad-style layout can apply to more than just syntax. An extension of regular algebra gives Kleene Algebra with Tests (KAT), a powerful formalism for equational reasoning about programs [Kozen 1997]; a corresponding slight extension to railroad diagrams can illustrate KAT terms (e.g. Fig. 4). More broadly, structured, systematic layout remains an open problem for ubiquitous diagrammatic notations—program state visualizations, circuit diagrams, control flow graphs, etc.—and we hope railroad-style layout will lead to a unifying solution.

2 A formal account of railroad diagrams and their layout

There is a lot of variation in what are called “railroad diagrams” by their creators, because the term has never been formally defined before, and because they are often hand-drawn. Much of it can be ascribed to stylistic choices that will naturally vary from author to author, like whether line wrapping is continuous (Fig. 5b vs. Fig. 1d) or whether boxes are centered; yet, we can still abstract a unifying schema or visual grammar. However, we choose to exclude some of it from our scope, for three principled reasons explained below and illustrated in Fig. 5. Our definitions nonetheless capture a large portion of the variation seen in the wild, which we quantify in §4.2 and §4.3.

First, we only consider *well-nested* diagrams: diagrams composed of n -ary sequences of subdiagrams in the same direction, binary stacks of subdiagrams (potentially in opposite directions), and atomic tokens. This almost describes *two-terminal series-parallel graphs*, except that they are usually defined to be either undirected or directed but acyclic [Alur et al. 2023; Brandstädt et al. 1999], whereas we explicitly allow cycles. (We further discuss series-parallel graphs in §5 and justify why stacks are binary in §2.1.) This criterion naturally extends to layouts: the well-nesting of a diagram must be reflected in the visual nesting of its layout. Specifically, we only consider layouts where the *bounding box* of each sublayout (corresponding to the decomposition described above) does not overlap with those of other, unrelated sublayouts. The bounding boxes then have the same nesting structure as the diagram. Figs. 5a and 5b are examples of ill-nested diagrams and layouts.

Next, we require layouts to have a *single semantic axis*: all sublayouts (corresponding to the diagram decomposition) must be laid out along the same axis (without loss of generality, the horizontal axis; vertical layouts are only a rotation away). Fig. 5c is an example violation.

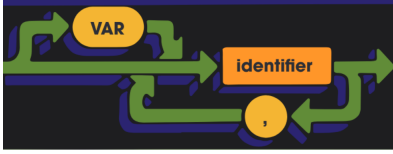

(a) Excerpt from Apple Pascal syntax chart [Kamifuji and Raskin 1979]. This structure is ill-nested, and hence unrepresentable as a diagram, because the optional "VAR" ends before the repeating "[identifier]" starts. (It would still be ill-nested if the ", "-adjoint edges were reversed.)

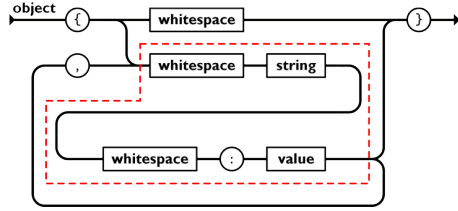

(b) Syntax of a JSON object [Crockford 2001], with dashed red annotation. The visual nesting of the indicated sublayout does not reflect the nesting of the corresponding subdiagram, as no rectangle can bound the layout of the five-token sequence ("whitespace" "[string]" ... "[value]") without including the "{", " or the vertex after it. Note that this *diagram* is well-nested, but this particular *layout* isn't.

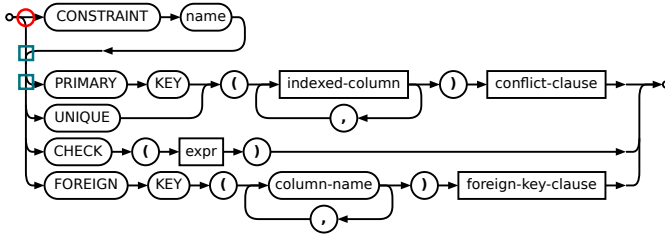

(c) Syntax of a SQLite table-constraint term [SQLite contributors 2024], with red and blue annotations. The first subdiagram of this sequence is an optional ("CONSTRAINT" "name") sequence, i.e. a stack of those two tokens and the empty sequence ϵ . Hence, the vertical line between the red circle and the first blue square is a layout of the ϵ , violating the single semantic axis property. (In contrast, the vertical line between the two blue squares is just "visual syntax" for the sequence and not a sublayout.)

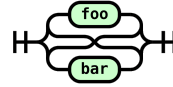

(d) An AlternatingSequence construct from [Atkins 2024], signifying the language of one or more instances of "foo" or "bar", starting with either and alternating between them.

Fig. 5. Railroad diagrams outside our scope. We show our closest approximations in Fig. 21.

Lastly, we exclude constructs never seen in actual use (to our knowledge), even if some railroad diagram generators can produce them. Fig. 5d is an example from a popular library.

(One additional condition is not essential but simplifies our presentation: the backward component of a loop must not be above the forward component, as in Fig. 1a. Including such layouts would be technically straightforward but would make our formalism longer and more confusing.)

2.1 The diagram language

We define our diagram language inductively in Fig. 6. The first two cases are terminal and nonterminal *tokens* parameterized by a string *label*. The next case is a *sequence* with zero or more subterms. The last case is a *stack* with exactly two subterms, parameterized by a *polarity*, + or -. An empty sequence $()$ is also denoted ϵ . For the rest of this paper, a "diagram" is a term in this language. The constructors are illustrated in Fig. 7a.

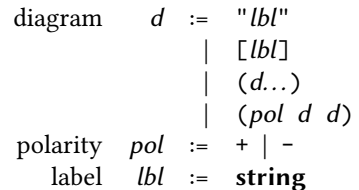

Fig. 6. The diagram language.

Although laid-out stacks often appear to have more than two subdiagrams (e.g. the three-way stack in Fig. 1a), we find that having stacks be only binary is the simplest model that accounts

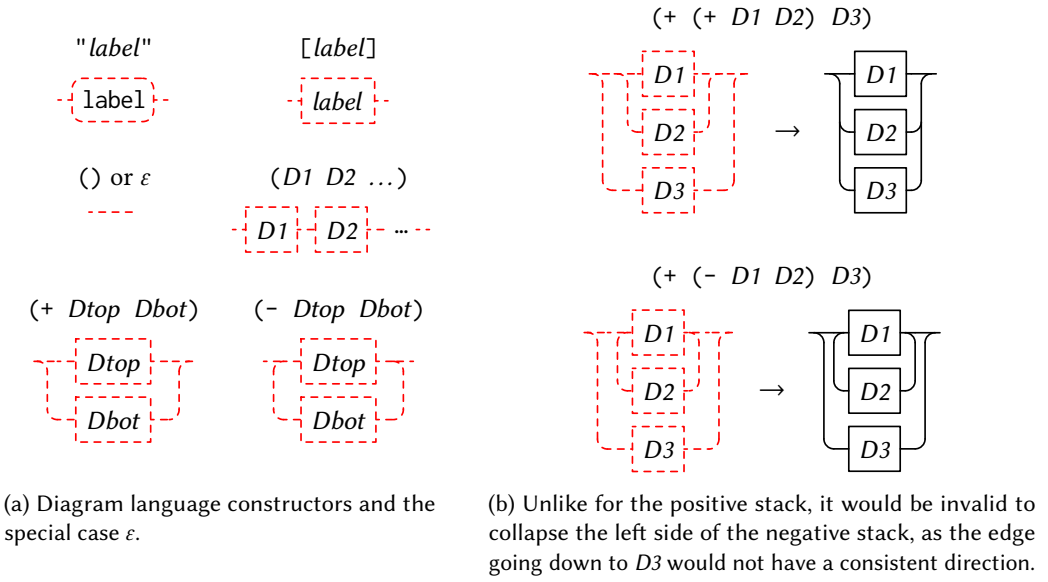

Fig. 7. The design of our diagram language.

exactly for all possible layouts. We use the same constructor for positive and negative stacks because both result in a layout with (i) vertically stacked sublayouts with brackets on the sides, (ii) no wrapping opportunities beyond what the sublayouts present, and (iii) possible *collapsing* with a containing stack. However, they differ in when such collapsing is possible, such as in Fig. 7b. We thus need layout well-formedness rules to capture such differences, and in §2.3, we state a clean set of such rules while treating all stack layouts as binary. Consequently, to simplify the relation between diagrams and layouts, we treat (diagram-level) stacks as binary, too. (The association order of nested binary positive stacks does not affect the rendering, unlike negative stacks (§4.1).)

In contrast to stacks, the association order of subdiagrams in a sequence has no bearing on the layout, so sequences are n -ary without ado. Formally, the *canonical form* of a diagram is the result of repeatedly splicing nested sequences, a trivially confluent rewriting: any sequence $(D_1 \dots)$ with a subdiagram D_i which is itself a sequence $(D_{i_1} \dots)$ is rewritten to $(D_1 \dots D_{i_1} \dots \dots)$, replacing D_i with its subdiagrams. We call two diagrams *equivalent* if they have the same canonical form.

2.2 The layout language

We define our layout language inductively in Fig. 8 and illustrate it in Fig. 9. The constructors, and their parameters beyond the common *direction* (left-to-right or right-to-left), are:

- (atomic constructors) rails, with a nonnegative real *width*; spaces; and stations, with a string *label* and a *terminal flag* indicating whether it is a terminal;
- a horizontal concatenation of one or more subterms;
- an inline vertical concatenation (“inline VC”) of two or more subterms, with a string *marker* and left and right *tip specifications*; and
- a block vertical concatenation (“block VC”) of exactly two subterms, with a *polarity* (positive or negative) and left and right *tip specifications*.

A *tip* is where a layout starts or ends, and where a containing layout can connect to enter or exit it. Naturally, each layout has a tip on either side. Either tip of a VC can be specified as:

layout ℓ

```

:= (rail dir w)
| (space dir)
| (station dir lbl tm?)
| (hconcat dir  $\ell$   $\ell$ ...)
| (vconcat-inline dir ts ts mk  $\ell$   $\ell$   $\ell$ ...)
| (vconcat-block dir ts ts pol  $\ell$   $\ell$ )
    
```

```

direction dir := ltr | rtl
width w := real ≥ 0
label lbl := string
terminal flag tm? := boolean
marker mk := string
polarity pol := + | -
row number r := integer > 0
proportion p := 0 ≤ real ≤ 1
    
```

tip specification ts

```

:= vertical
| (logical r)
| (physical p)
    
```

Fig. 8. The layout language.

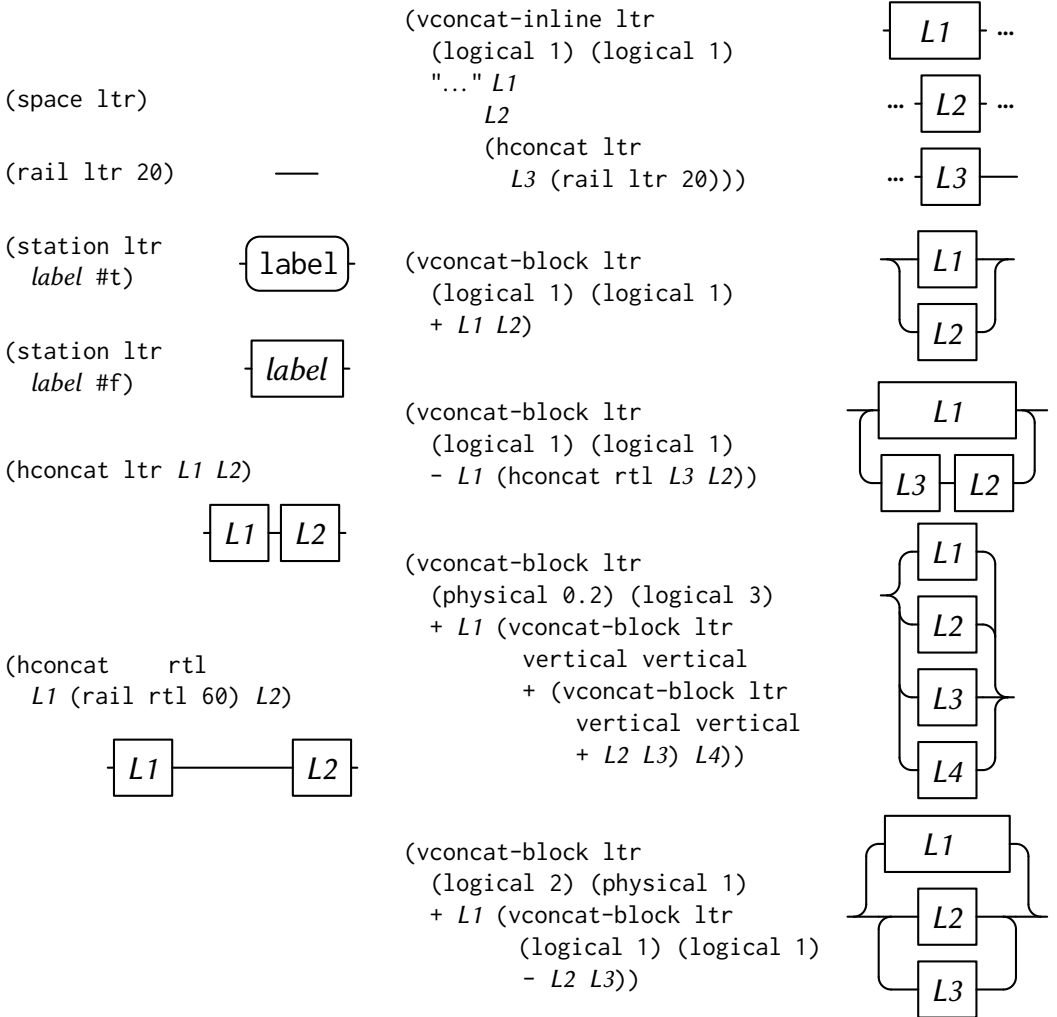

Fig. 9. Layout constructors, and the effect of tip specifications.

- vertical, for collapsing with a containing stack;
- a *logical row number*, a positive integer, for aligning with an inner sublayout after collapse; or
- a *physical proportion*, a real between 0 and 1, interpolating between the highest (0) and lowest (1) possible tips, which are not necessarily aligned with logical rows.

Any other kind of layout has (logical 1) tips on both sides by default. Lastly, we define the *start* and *end sides* of an inline VC as left and right if the direction is left-to-right, else *vice versa*.

2.3 Layout well-formedness

Unlike diagrams, not all layouts in the language above are *well-formed*. For instance, a right-to-left horizontal concatenation does not draw its sublayouts in reverse order and direction, but must be constructed with right-to-left sublayouts in visual order (e.g. bottom left of Fig. 9). In informal terms, our definition of well-formedness (to follow) aims to avoid “nonsense” layouts, where, say, a collapsed edge has no consistent direction, or sublayouts are visually disconnected. Moreover, a well-formed layout leaves no ambiguity or context-dependence in its rendering.

To state the well-formedness rules, we must first define three other layout properties: width, number of logical and connectable rows on either side, and up- and down-connectability on either side. The definition of **width** below assumes a constant S , the unit width around curves and boxes.

- The width of a rail is its width parameter.
- The width of a space is $2S$.
- Stations have implementation-dependent widths, plus $2S$.
- The width of a horizontal concatenation is the sum of its sublayouts’.
- The width of an inline VC is the sum of: (i) the width of its first sublayout; (ii) the width of its marker (implementation-dependent); and (iii) $3S$ if its start-side tip specification is a physical proportion other than 0 (i.e. if it needs a bracket), and likewise for its end side if other than 1.
- The width of a block VC is that of its first sublayout, plus $3S$ for each non-vertical tip.

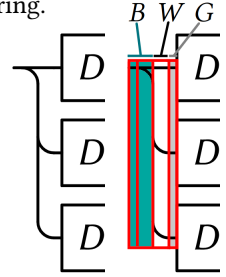

The multiples of S account for vertical brackets in the rendering. As an example, the illustration shows the left side of a positive block VC with a (logical 1) tip. The blue $B = 3S$ width is part of the VC. The white $W = 2S$ width comes from spaces at the left end of each sublayout; the bracket of the VC “reaches into” them. The gray $G = S$ width is intrinsic to the stations.

Second, we define the **number of logical rows** on either side. The **number of connectable rows** is equal to the logical one except where noted. We omit writing “on the given side” for brevity, but all tips and numbers of rows refer to the same universally quantified side:

- Spaces, rails, stations, and block VCs with a non-vertical tip all have 1 row.
- A horizontal concatenation has as many rows as its sidemost sublayout.
- An inline VC has as many rows on its start side as its first sublayout on that side, and likewise for its end side with its last sublayout.
- A positive block VC with a vertical tip has as many rows as the sum of the number of connectable rows of its top and bottom sublayouts.
- A negative block VC with a vertical tip has as many logical rows as the sum of its top and bottom sublayouts, minus the number of connectable rows of its top sublayout, plus 1; and only 1 connectable row. (See Fig. 10.)

Third, we define **up- and down-connectability** on either side. Up-connectability is meant to capture if a layout can be connected to “from above” when contained in block VCs, and likewise for down-connectability; see Fig. 11. “Both-” and “neither-connectable” have their natural meanings. “Up-/down-” means up- and down- separately. Again, we omit writing “on the given side”.

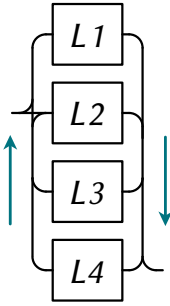

Fig. 10. A negative block VC with its left tip at its first logical row and its right tip at its last. If the left tip were any higher, the edge between L1 and L2 would not have a consistent direction.

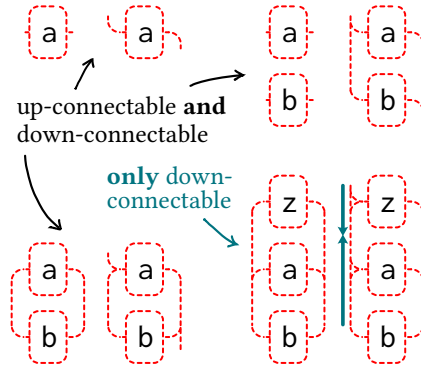

Fig. 11. Each pair of drawings shows a layout by itself and in the hypothetical context of a block VC connecting from above (on the left) or below (right). The top left represents a station "a" surrounded by (invisible) spaces; the top right, (+ "a" "b"); the bottom left, (- "a" "b"); and the bottom right, (- (+ "z" "a") "b"), which is not up-connectable as the marked edge would not have a consistent direction.

- Rails, stations, and block VCs with a non-vertical tip are all neither-connectable.
- A space is both-connectable.
- A horizontal concatenation is up-/down-connectable only if its sidemost sublayout is.
- An inline VC is up-/down-connectable on its start side only if its first sublayout is; and likewise on its end side with its last sublayout.
- The up-/down-connectability of a block VC with a vertical tip and polarity *pol* depends on the nature of its top/bottom sublayout and is best described with tables. Below, "if top/bot" means "if the top/bottom sublayout has the property under consideration".

<i>pol</i>	top sublayout	up-ctbl.	<i>pol</i>	bot sublayout	down-ctbl.
+	-ve block VC	no	+	-ve block VC	no
+	else	if top	+	else	if bot
-	+ve block VC	no (Fig. 11)	-	-ve block VC	no
-	else	if top	-	else	if bot

Finally, we can state the well-formedness rules. These rules are also presented as formulae in Fig. 12.

WF_{st}, WF_{sp}, WF_{tb} Rails, spaces, and stations are well-formed.

WF_c A horizontal or inline vertical concatenation ℓ is well-formed if all sublayouts are well-formed and have the same direction as ℓ .

WF_{hc} In addition to WF_c, a horizontal concatenation is well-formed if all sublayouts are neither-connectable, except possibly the first sublayout on its left or the last sublayout on its right.

WF_t A VC is well-formed if, on either side, if the tip is (logical r), then r is no greater than the number of logical rows; or if it is vertical, then the VC is either up- or down-connectable.

WF_{ivc} In addition to WF_t, an inline VC is well-formed if:

- All sublayouts are neither-connectable, except possibly the first sublayout on its start side or the last sublayout on its end side.
- The first and last sublayouts have the same width $w \geq m$, and the other sublayouts have width $w - m$, where m is the width of the marker.

$$\begin{array}{c}
\frac{}{\text{WF}(\text{(rail } dir \ w)})} \text{WF}_{\text{st}} \\
\frac{}{\text{WF}(\text{(space } dir)})} \text{WF}_{\text{sp}} \\
\frac{}{\text{WF}(\text{(station } dir \ lbl \ t?)})} \text{WF}_{\text{tb}} \\
\frac{\forall i, \text{WF}(\ell_i) \quad \ell_i.dir = dir}{\text{WF}_{\text{conc}}(dir \ \ell_1 \dots)} \text{WF}_{\text{c}} \\
\text{WF}_{\text{conc}}(dir \ \ell_1 \dots) \\
\frac{\forall 2 \leq i, \ell_i.left.ctbl = \text{neither} \\ \forall i \leq n-1, \ell_i.right.ctbl = \text{neither}}{\text{WF}(\text{(hconcat } dir \ \ell_1 \dots \ell_n)})} \text{WF}_{\text{hc}} \\
\frac{\text{WF}(\ell) \quad \forall side \in \{\text{left}, \text{right}\}, \\ \ell.side.ctbl = \text{neither}}{\widehat{\text{WF}}(\ell)} \widehat{\text{WF}} \\
\frac{ts = (\text{logical } r) \implies r \leq side.num\text{-rows} \\ ts = \text{vertical} \implies side.ctbl \neq \text{neither}}{\text{WF}_{\text{tip}}(side \ ts)} \text{WF}_{\text{t}} \\
\frac{\ell_{top}.width = \text{WF}(\ell_{top}) \quad \text{WF}(\ell_{bot}) \\ \ell_{bot}.width \quad \forall side, \text{WF}_{\text{tip}}(side \ ts_{side}) \\ \ell_{top}.dir = dir \quad \ell_{top}.side.ctbl \geq \text{down} \\ \ell_{bot}.dir = pol(dir) \quad \ell_{bot}.side.ctbl \geq \text{up}}{\text{WF}(\text{(vconcat-block } dir \\ ts_{left} \ ts_{right} \ pol \ \ell_{top} \ \ell_{bot}))} \text{WF}_{\text{bvc}} \\
\frac{\text{WF}_{\text{conc}}(dir \ \ell_1 \dots) \quad \forall side, \text{WF}_{\text{tip}}(side \ ts_{side}) \\ \forall 2 \leq i, \ell_i.start.ctbl = \text{neither} \\ \forall i \leq n-1, \ell_i.end.ctbl = \text{neither} \\ \ell_1.width = \ell_n.width = w \geq m = mk.width \\ \forall 2 \leq i \leq n-1, \ell_i.width = w - m}{\text{WF}(\text{(vconcat-inline } dir \\ ts_{left} \ ts_{right} \ mk \ \ell_1 \dots \ell_n))} \text{WF}_{\text{ivc}}
\end{array}$$

Fig. 12. Layout well-formedness.

WF_{bvc} In addition to WF_t, a block VC with direction *dir* and polarity *pol* is well-formed if:

- Both sublayouts are well-formed and have the same width.
- The top sublayout is down-connectable on both sides, and has direction *dir*.
- The bottom sublayout is up-connectable on both sides, and has direction *dir* iff *pol* is +.

$\widehat{\text{WF}}$ In addition to all the above, a top-level (i.e. outermost) layout is well-formed if it is neither-connectable on both sides.

2.4 Compilation or “laying out” relation

To *lay out* a diagram is to compile a diagram *d* to a layout *l* such that (i) *d* and (diagram-of *l*) are equivalent, with equivalence as defined at the end of §2.1, and the function diagram-of as defined below; and (ii) $\widehat{\text{WF}}(l)$ as defined above.

$$\begin{array}{ll}
(\text{diagram-of } (\text{space } dir)) & := () \\
(\text{diagram-of } (\text{rail } dir \ w)) & := () \\
(\text{diagram-of } (\text{station } dir \ label \ #t)) & := "label" \\
(\text{diagram-of } (\text{station } dir \ label \ #f)) & := [label] \\
(\text{diagram-of } (\text{hconcat ltr } l_1 \dots l_n)) & := ((\text{diagram-of } l_1) \dots (\text{diagram-of } l_n)) \\
(\text{diagram-of } (\text{hconcat rtl } l_1 \dots l_n)) & := ((\text{diagram-of } l_n) \dots (\text{diagram-of } l_1)) \\
(\text{diagram-of } (\text{vconcat-inline } dir \\ \quad ts \ rts \ mk \ l_1 \dots l_n)) & := ((\text{diagram-of } l_1) \dots (\text{diagram-of } l_n)) \\
(\text{diagram-of } (\text{vconcat-block } dir \\ \quad ts \ rts \ pol \ l_1 \ l_2)) & := (pol (\text{diagram-of } l_1) (\text{diagram-of } l_2))
\end{array}$$

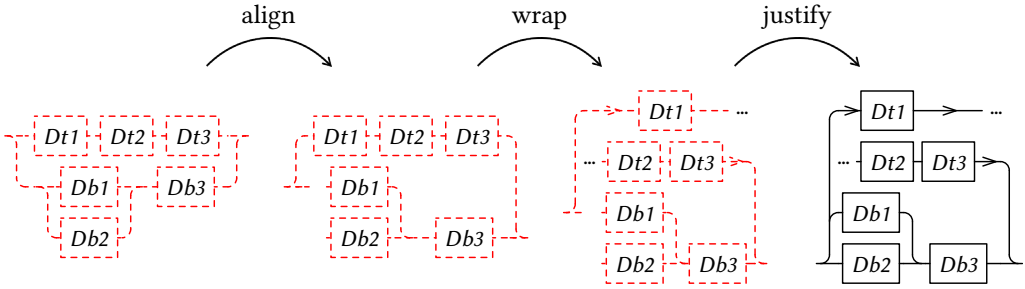

Fig. 3. (reproduced from page 3) Our three-step algorithm for compiling a diagram to a layout.

3 A three-step layout algorithm

In the previous section, we defined the problem of railroad layout. In this section, we describe how we solve it. The space of possible layouts for a diagram is large, with several degrees of freedom at each level of nesting; our solution aims to navigate that space while balancing flexibility, efficiency, and ease of use. In broad strokes, our algorithm has three steps (illustrated in Fig. 3):

1. *Alignment*: determining whether the layout of each subdiagram collapses with its container, and if not, determining its vertical positioning. This is controlled by the `align-items` policy.
2. *Wrapping*: deciding how to wrap the sublayouts of each sequence across visual rows to meet a target width. We discuss wrapping parameters in §3.2.
3. *Justification*: deciding how to distribute the width available inside a container among and around its sublayouts. This is controlled by the `justify-content` policy.

Operationally, each step aligns with an aspect of the compilation relation from §2.4. Alignment is about choosing tip specifications and placing spaces such that the layout is well-formed. Wrapping is about choosing a composition of horizontal and inline vertical concatenations for each sequence. Justification is about placing rails (ε -sequences) to add up to the correct widths. None of these choices affect diagram equivalence as defined at the end of §2.1.

In this section, we build our layout algorithm as a progressive lowering from diagrams to layouts. The first lowering is immediate: per the compilation relation, tokens become stations; stacks become block VCs, although tip specifications are not known yet; and bottom subdiagrams of negative stacks sequences are reversed. Assuming the top-level term is left-to-right, it is easy to compute subterm directions to satisfy the directional conditions of well-formedness. This gives an *immediate diagram* as in Fig. 13.

```

id := (station dir lbl tm?)
    | (dir id..)
    | (vconcat-block dir
        pol id id)

```

Fig. 13. The immediate diagram (*id*) language. *dir*, *lbl*, *tm?*, *pol* are as in Fig. 8.

3.1 Alignment and justification à la flexbox

Layouts of linear content often have a *main axis* aligned with the inherent linear order and an orthogonal *cross axis*, each with a natural *start* and *end* side.² For instance, the main axis of English text is left-to-right, and the cross axis is top-to-bottom (Fig. 14a); the main axis of a vinyl is circular, and the cross axis is radial. Railroad layouts (in this paper) have a horizontal main axis with a direction given by their *dir* parameter, and a top-to-bottom cross axis. Then, alignment and justification are about the cross- and main-axis positioning of sublayouts in a container, respectively.

²(Although we explain our terminology without further citation below, it is heavily inspired by the CSS Flexible Box Layout Module [W3C 2018], or *flexbox* for short. We discuss key differences in §5.)

- (i) All subdiagrams must have at least their min-content widths ($n_A = 10$, $n_B = 10$ in the illustration) and at least a gap-width (a global parameter) rail between them.
- (ii) As the available width grows, all subdiagrams should grow to their max-content widths ($x_A = 12$, $x_B = 20$) at equal rates.⁴
- (iii) Only after all have reached their max-content widths should any extra width (E) be used, in part for spacing ($fa \cdot E$, where fa is a global parameter flex-absorb) and in part for letting subdiagrams grow further at equal rates, if they can.

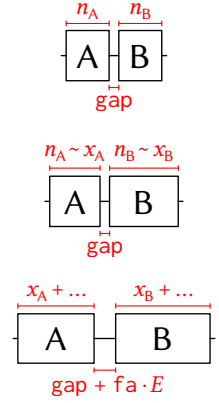

Fig. 16. Justification aims to ensure three properties at each level of nesting.

the next section but assume its result, viz. Fig. 19, to explain justification below. In particular, we assume the definitions of the min-content and max-content width for each term: the minimum width of its eventual layout if, respectively, all wrapping opportunities are taken, or none are.

The last step of lowering to the layout language is justification. It chooses one of the possible wraps and distributes extra width around and among items in each (wrapped) row, aiming to ensure three properties at each level of nesting, explained in Fig. 16. The policies for distributing width around items (if any) are illustrated in Fig. 14d. This process satisfies width-related well-formedness criteria by creating horizontal concatenations and rails while preserving diagram equivalence.

Our compiler implements justification as a recursive algorithm on wrapped diagrams with an additional *target-width* argument. The top-level *target-width* requested by the user must be at least the min-content of the top-level diagram to ensure that some layout is possible. Then:

- For stations and spaces, the algorithm does nothing, as they are inflexible.
- For each vertical concatenation, the algorithm (i) subtracts the fixed widths associated with tips and markers from *target-width*; (ii) ensures that each subdiagram is a horizontal concatenation (potentially by constructing one); and finally (iii) recurses on each (horizontal concatenation) subdiagram with the (updated) *target-width*.
- For each ordered set of wraps, the algorithm selects the first (i.e. most preferred) wrap whose min-content is no greater than *target-width* (i.e. which is guaranteed to fit).

For each horizontal concatenation, the algorithm is more involved:

1. Let aw and rw be variables representing the *absorbed* and *remaining width* to be distributed around and among sublayouts, respectively. Let sw_i be variables representing the *subwidths* assigned to each subdiagram d_i , for $1 \leq i \leq n$.
 - (a) Initialize aw to $(n - 1) \cdot \text{gap}$ (minimum spacing).
 - (b) Initialize each sw_i to $d_i.\text{min-content}$ (minimum widths).
 - (c) Initialize rw to $\text{target-width} - aw - \sum sw_i$.

We will maintain the invariant $rw + aw + \sum sw_i = \text{target-width}$, and rw will be zero by the end.

2. Let the *growth width* $g_i = (d_i.\text{max-content} - d_i.\text{min-content})$. Let the *maximum growth width* $mg = \min(rw, \sum g_i)$. Increment each sw_i by $mg \cdot g_i / \sum g_i$, and decrement rw by mg .

⁴In (ii), “at equal rates” means in proportion to the difference between the max- and min-content of each subdiagram. In (iii), it means in proportion to the max-content. In theory, different proportions could be used (e.g. involving squares of differences), but in practice, the difference in layouts is barely noticeable (a few pixels at most).

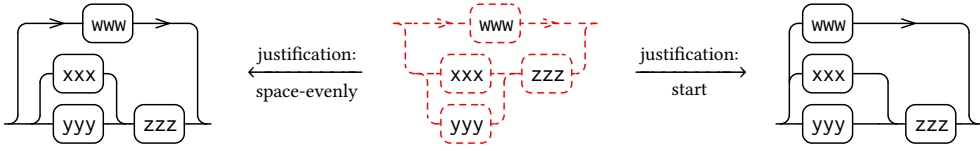

Fig. 17. A sublayout cannot collapse with its container during alignment (here, bottom-alignment) if the justification policy (here, space-evenly) could potentially insert a rail between them.

3. Increment aw by $rw \cdot \text{flex-absorb}$, and decrement rw by the same amount.
4. Let d_j , etc. denote only those subdiagrams that are concatenations (and hence can grow further). If there are none, increment aw by rw and set rw to zero. Else, increment each sw_j by $rw \cdot (d_j \cdot \text{max-content}) / \sum (d_j \cdot \text{max-content})$ and set rw to zero.
5. Distribute aw among rails between and around subdiagrams per `justify-content`, `gap`, and the current direction. Recursively justify each subdiagram with target width sw_j . Return a new horizontal concatenation with said justified subdiagrams and rails.

We make three remarks about the relationship between alignment and justification. First, alignment applies to each sublayout of a container individually, whereas justification only makes sense as a collective property of all the sublayouts taken together, so the former policy is called `align-items` and the latter `justify-content`. Second, if a sequence wraps across multiple rows, alignment and justification apply to each row independently, although policies may specify different behaviors for the first, middle, and last rows. And third, alignment actually depends on the justification policy, because the side of a stack can collapse with its container only if the two are guaranteed to be directly adjacent, without the possibility of any rails in between (e.g. Fig. 17). Now, justification must happen after wrapping because it works on each wrapped row, and wrapping must happen after alignment because it depends on widths, which depend on tip specifications; but the dependency is not circular, because alignment only depends on the justification policy, and not its realization.

The net result of the lowering is thus a well-formed layout, equivalent to the original diagram, that has width exactly *target-width*, with alignment and justification per the `align-items`, `justify-content`, `flex-absorb`, and `gap` global parameters.

3.2 Wrapping as optimization

Many layout problems are stated in terms of hard constraints and softer optimization objectives. 1-dimensional problems like text wrapping and code pretty-printing treat layout width as a hard constraint, while trying to minimize properties like height,⁵ deviance from normative spacing, and drastic variation between lines [Knuth and Plass 1981; Porncharoenwase et al. 2023]. In contrast, the constraints and objectives for 2-dimensional layout problems are typically isotropic properties, unlike size. For instance, among Graphviz’s 8 graph layout algorithms, 5 do not favor any axis over another; 1 (“circo”) distinguishes radial and circular axes, but minimizes edge crossings (independent of direction); and 2 (“dot” and “twopi”) are explicitly hierarchical layouts that impose a 1-dimensional structure (“discrete ranks or levels”) on the graph [Graphviz contributors 2022].

Railroad layouts, being 1.5-dimensional (§1.2), fall somewhere in between. Like 1-dimensional layouts, they follow a reading order and are wrapped in practice (e.g. Fig. 1c, 1d), so we treat target

⁵This seems obvious but bears further thought. It is the main axis that has a hard constraint, and the cross axis that is subject to minimization. Layouts with different reading orders behave accordingly: for instance, traditional Chinese calligraphy was laid out on horizontal scrolls, with a top-to-bottom main axis (limited by paper height) and a right-to-left cross axis (e.g. [Chengsu and Xizhi 650]). 1-dimensional layouts are informally often measured along the cross axis—books in pages, code in lines, scrolls in inches—implicitly assuming the layout makes good use of a reasonable main-axis size.

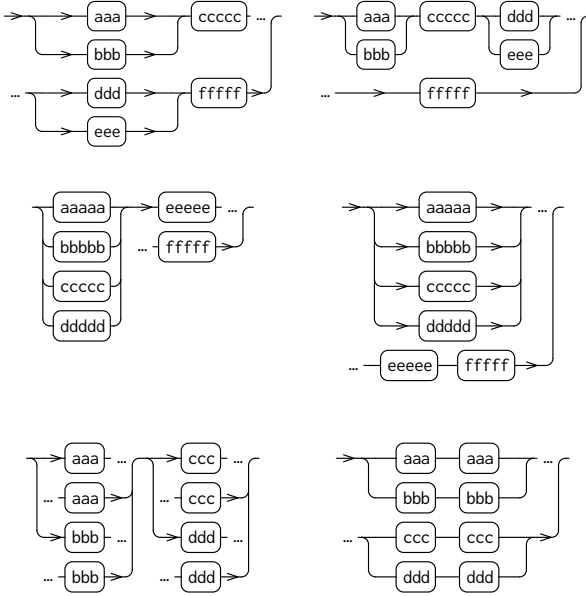

Fig. 18. Each pair of drawings shows two layouts of the same diagram at the same width. The first shows a text-like tradeoff between height and balance. The second shows a code-like “indentation” choice. The third shows a wrapping decision that neither (1-dimensional) layout can express.

sequence wrap of d

```

 $sw_d := row_d$ 
      | (vconcat-inline
        |  $dir\ ts\ ts\ mk$ 
        |  $row_d\ row_d\ row_d\dots$ )
 $row_d := (hconcat\ dir\ d\ d\dots)$ 

```

locally wrapped diagram

```

 $lwd := (station\ dir\ lbl\ tm?)$ 
      | (vconcat-block  $dir$ 
        |  $ts\ ts\ pol\ lwd\ lwd$ )
      | (space  $dir$ )
      | ordered set  $sw_{lwd\dots}$ 

```

global wrap

```

 $gw := (station\ dir\ lbl\ tm?)$ 
      | (vconcat-block  $dir$ 
        |  $ts\ ts\ pol\ gw\ gw$ )
      | (space  $dir$ )
      |  $sw_{gw}$ 

```

globally wrapped diagram

```

 $gwd := \mathbf{ordered\ set}\ gw\dots$ 

```

Fig. 19. The wrapped diagram languages. dir , lbl , $tm?$, ts , pol are as defined in Fig. 8.

width as a hard constraint. In fact, it can be an exact constraint, as railroad layouts stretch more and suffer less from sparse rows than text or code. But Fig. 18 illustrates how the usual parameters of 1-dimensional layout—width, height, and balance—cannot explain all railroad layout decisions, as they do not account for the additional “.5 dimension”. Informally, layouts with less and shallower wrapping are preferred for ease of reading, while trying to make good use of available space.

One of our key contributions is to identify that encoding these preferences as optimization for just the wrapping step is sufficient for practical purposes, instead of phrasing the whole railroad layout problem as optimization. This helps us avoid the instability typical of optimization-based 2-dimensional layouts and develop heuristics for *local wrapping* (of every sequence) in addition to *global wrapping* (of the whole diagram). In computational terms, we express the result of wrapping as a total order over possible *wraps*, i.e. compositions of horizontal and inline vertical concatenations for each sequence, either per sequence (“local”) or for all sequences in the diagram at once (“global”). This results in a *locally* or *globally wrapped diagram* as in Fig. 19. Standard techniques can then find the optimal (per the total order) wrap subject to a target width constraint.⁶

Next, rather than try to define a single total order to cater to all styles and use cases, we describe a few principled optimality parameters that explain wrapping decisions we observed in the wild. We begin with three preliminary definitions: the *wrap specification* for a sequence, the *min-content* and *max-content* widths of a wrapped diagram, and the *height* of a globally wrapped diagram.

A *wrap specification* encodes a composition of horizontal and inline vertical concatenations for a sequence as a set of positive integer *wrap points* in ascending order, each specifying the index of

⁶Technically, a total order is stronger than we need. An order that ensured that any subset of wraps bounded by width had a least element would be sufficient. We have not found the distinction to matter, so we opt for the simpler definition.

the first subdiagram on a row (and hence each no less than 1 and no greater than the number of subdiagrams). Naturally, 1 must be a wrap point; the wrap specification $\{1\}$ means there is only one row, i.e. just a horizontal concatenation, and other specifications signify an inline VC containing horizontal concatenations.⁷ For example, for a sequence of d_1, d_2, d_3, d_4 , the wrap specification $\{1, 4\}$ means that d_1, d_2 , and d_3 are on the first row, and d_4 is on the second row by itself.

The min- or max-content width of a wrapped diagram is the minimum width of its eventual layout if, respectively, all wrap points are taken, or none are. (These notions are analogous to CSS.)

- For stations and spaces, both are equal to the layout width as defined in §2.2.
- For a horizontal concatenation, min-content is computed just like the layout width, except using the min-contents of its subdiagrams instead of their layout widths, and accounting for the minimum gap between subdiagrams; and likewise for max-content.
- For a vertical concatenation, min-content is computed just like the layout width, except using the maximum min-content among its subdiagrams instead of the layout width of the first sublayout; and likewise for max-content.
- For a set of wrapped diagrams, min-content is the minimum min-content in the set, and max-content is the max-content of the element in which all wrap specifications are $\{1\}$.

Note that we are not actually performing layout to compute these properties, but just using the same formulae. Note also that a globally wrapped diagram is a set of global wraps, but global wraps contain no sets themselves (see Fig. 19). Hence, min- and max-content coincide for a global wrap to just be equal to its layout width, which we will call just the content width, because the formulae for the two properties only differ when there is a set of possibilities.

Lastly, the *height* of a global wrap is straightforward to compute. Stations have implementation-dependent heights; the height of a vertical concatenation is the sum of the heights of its subdiagrams, plus any space between rows; and the height of a horizontal concatenation can be computed by vertically aligning the internal tips of its subdiagrams to form a “baseline”, and taking the difference between the largest extent above and below that baseline of any subdiagram.

We can now explain the wrapping decisions we observed in manual layouts as finding an optimal global wrap with the objectives below. $gw_1 <_g gw_2$ means gw_1 is preferable to gw_2 .

Greater content width. In other words, we prefer layouts that use more of the available width.

All else being equal, $gw_1.\text{content} > gw_2.\text{content}$ implies $gw_1 <_g gw_2$.

Less and shallower wrapping. We combine the two criteria because it is more natural than describing each independently of the other. Let the *depth* d_t of each term t in a global wrap be defined as zero for the top-level term and one greater than the containing term for each subterm. Let wl_t be the length of the wrap specification if t is a sequence wrap, else zero. Let $p_d(d_t)$ be a real-valued *depth penalty* function and $p_{wl}(wl_t)$ be a real-valued *wrap-length penalty* function. Then, the *wrap penalty* $p_w(gw)$ is $\sum_t p_{wl}(wl_t) \cdot p_d(d_t)$. We need p_d and p_{wl} to be monotonic and positive; and all else being equal, $p_w(gw_1) < p_w(gw_2)$ implies $gw_1 <_g gw_2$.

Lower height. All else being equal, $gw_1.\text{height} < gw_2.\text{height}$ implies $gw_1 <_g gw_2$.

The last three criteria are phrased in terms of “all else being equal” assumptions. Two practical ways to satisfy them all at once are (i) to make $<_g$ a lexicographic order, defining a priority order among the three, or (ii) to make $<_g$ a numerical order on a linear combination of content width, wrap penalty, and height, where the first has a negative weight and the other two have positive weights. Either option makes $<_g$ a total order.

⁷Although it would be valid to nest inline VCs further, our encoding cannot express it, because we have not found it useful in practice and it can be achieved with nested sequences anyway.

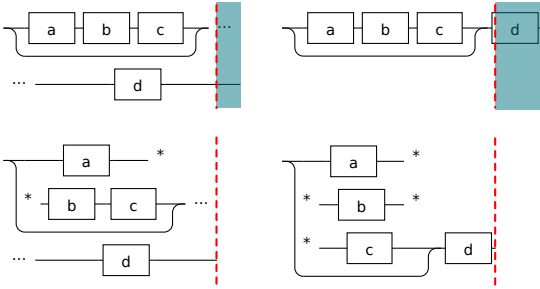

Fig. 20. Between two sequence wraps (top) that produce wrapped diagrams (bottom) of a given target width (dashed red), the left one has lesser excess max-content width (shaded blue), leading to less internal wrapping.

Of course, it is impractical to enumerate all global wraps to choose one: a diagram with k sequences of n subdiagrams each has $2^{k(n-1)}$ possible wraps. This motivates our locally wrapped diagrams, for which a recursive layout process can alternate between justification and choosing a wrap for each sequence, avoiding the combinatorial explosion. Below, we translate the global objectives into reasonable local versions. Recall that min-content and max-content are now distinct, and the unresolved ambiguity in subterms means that we cannot yet compute the height of a diagram.

Lesser max-content width beyond target width. For global wraps, we prefer *greater* content widths for using more of the available space, because we know they are no greater than the target width. But for sequence wraps, the max-content width is typically greater than the target width; the smaller the excess, the closer its subdiagrams will be to their “full” max-content, reducing further nested wrapping. (See Fig. 20.)

Lesser max-content width for multi-row sequences. As the max-content of a multi-row sequence is the maximum of its subdiagrams’, minimizing it leads to more balanced rows and better use of horizontal space, as moving any subdiagram from one row to another would only increase it. (The first row of Fig. 18 illustrates this objective.)

Less and shallower wrapping. As for global wraps.

As before, lexicographic order or numerical order on a linear combination of max-content and the wrap penalty are practical choices. We evaluate them in §4. (min-content seems irrelevant to the order. It roughly scales with the width of the widest or most deeply nested station in a diagram, not with any holistic property. Moreover, in our experiments, we have not yet found a case in which min-content distinguishes between two otherwise equal sequence wraps.)

3.3 Implementation

We implemented a prototype of the algorithm above in Scala (compiled with Scala.js). It is available at github.com/epfl-systemf/librrd. As a summary, the parameters to layout are:

- the target width (and whether it should be achieved by global or local wrapping);
- `align-items`, the policy for vertical alignment of sublayouts;
- `justify-content`, the policy for horizontal justification of sublayouts;
- `flex-absorb`, the proportion of any extra width a horizontal concatenation uses for justification before passing the rest on to its sublayouts; and
- the minimum gap between sublayouts of a horizontal concatenation.

Layouts are rendered to SVG with classes and hierarchical structure amenable to further CSS styling. Our implementation is 1065 SLOC (excluding empty lines and comments), plus 260 SLOC for rendering. A web UI is available at systemf.epfl.ch/etc/librrd/, which implements an order over sequence wraps (local wrapping) that we have found to work well in practice. It first minimizes $\max(0, w \cdot \text{max-content} - \text{target-width})^2 + 10 \cdot p_w(w)$ with wrap-length penalty $p_{wl}(wl) = wl$ and depth penalty $p_d(d) = 2^{2d}$, and then minimizes max-content absolutely.

regex	BNF rule	diagram	(a layout)
ε	(empty)	()	\Rightarrow
a	a	"a"	
(n/a)	<a>	[a]	
$r \cdot s$	$r s$	((rrd r) (rrd s))	
$r s$	$r s$	(+ (rrd r) (rrd s))	
r^*	(n/a)	(- () (rrd r))	

(a) Translating nonempty regular expressions and BNF rules to railroad diagrams. r, s are nonempty regular expressions or rules, and a is any literal symbol or rule name. Dashed red boxes denote recursive translations.

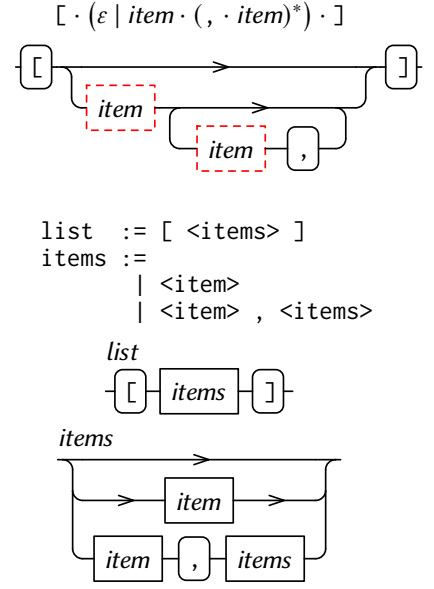

(b) Syntax of a JSON list, as a regular expression and in BNF, and the corresponding diagrams. Parentheses are only to indicate order of operations.

Table 1. Regular expressions and rules in Backus-Naur form can be translated to railroad diagrams.

4 Evaluation

We started §2 by defining a language to express railroad diagrams, and by the end of §3, we had a principled algorithm to produce layouts ready for rendering. In this section, we evaluate whether both ends of this pipeline are practical. For the front end, we show that our diagram language is well-suited for common applications, viz. illustrating formal grammars, by describing how regular expressions and Backus-Naur form can be compiled to it (§4.1). For the back end, we argue that our compiler is practical by comparing its output to diagrams laid out by hand (§4.2) and by other tools (§4.3). We also show that our compiler is performant enough for interactive use (§4.4).

4.1 Regular expression and Backus-Naur frontends

A recursive translation from nonempty regular expressions to our diagram language is given in Table 1a. (It is identical to the construction in [Hinze 2019] inspired by [Manna 1974].) An empty regular expression (i.e. \emptyset , the empty language) cannot be drawn; to draw an arbitrary regular expression, empty subexpressions must first be eliminated using standard equivalences like $r \cdot \emptyset = \emptyset$.

For a grammar specified in Backus-Naur form (BNF), the right-hand side of each rule is translated to a railroad diagram. A rule can refer to another of name a with the syntax $\langle a \rangle$, represented as a nonterminal token $[a]$. The rest of the translation is presented in the same Table 1a.

Although technically sufficient, the treatment of iteration/recursion in both translations above is a little unsatisfying. Consider the definition of JSON list syntax as a regular expression and in BNF in Table 1b, and the translation to railroad diagrams, assuming a list item is separately defined. In the regular expression diagram, we may prefer *item* to appear only once, as the top of the negative

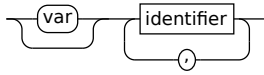

(a) Fig. 5a, but as a well-nested diagram.

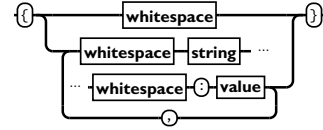

(b) Fig. 5b, but as a well-nested layout.

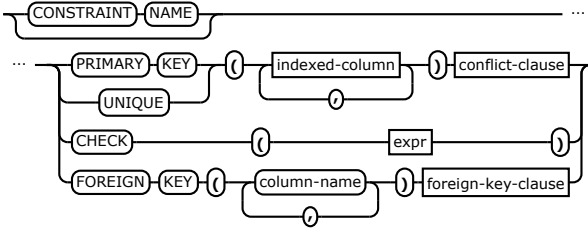

(c) Fig. 5c, but with a single semantic axis.

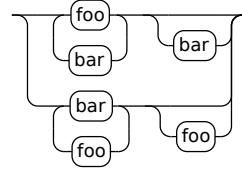

(d) Fig. 5d, but using common constructs.

Fig. 21. Our approximations of the diagrams excluded from our scope in Fig. 5.

stack; similarly, we may prefer to make the recursion explicit in the BNF diagram as a negative stack. But we may prefer this transformation *not* to happen if there are several kinds of lists, and it just happens to be the case in the one depicted above that the first item is of the same kind as the rest. We cannot accommodate such preferences merely by adding rules to our translation table. Rather, seen as a notation for syntax diagrams, both regular expressions and BNF have a conflict between *canonicity*—objects are equivalent iff their representations are equal—and *idiomaticity*—the ability to conveniently express common representation idioms, like negative stacks for recursion. (This terminology was introduced by [Chiplunkar and Pit-Claudel 2023].)

Our diagram language, together with our approach to its compilation, is idiomatic, as it is specifically designed to express railroad diagrams under common constraints. However, it is not canonical: nested positive stacks can be reassociated without affecting the rendering, and the diagram $(- (- D_1 D_2) D_3)$ can seemingly be rewritten to $(- D_1 (+ D_2 D_3))$. The deeper problem is that railroad diagrams do not yet enjoy the solid theoretical foundations that other syntax notations do, from either the theory of computation or of graphs and automata, that would let us reason more precisely about rewriting, canonicity, and semantics in general.

4.2 Manual layout in the wild

Fig. 5 showed a few examples of diagrams outside our scope. In Fig. 21, we show our best approximation of each. It would not make sense to directly compare rendering properties like width and height, because they depend as much on stylistic choices like fonts and spacing as on layout. Neither would it make sense to compare wrap penalties, because we cannot infer the penalty functions implicitly expressed in those diagrams. We can only argue that our layouts are comparably compact and readable with the additional merit of being automatically laid out. Meanwhile, it is worth noting that the diagrams in Fig. 5 (except 5d) were laid out by hand to document very widely used syntaxes: Apple Pascal, JSON, and SQLite. High-impact settings may motivate creators to invest in custom manual layout even when automated tools are available.

SQLite makes for an instructive practical case study of using railroad diagrams in documentation. A brief history:⁸ the SQLite project started documenting its syntax with railroad diagrams in 2008, using Tcl scripts to render from a railroad layout DSL. In 2020, the project dropped the scripts in

⁸From check-ins 289df32643f94b1c and 9f5383c82461ffe9.

favor of directly specifying *renderings* in Pikchr, a modernized implementation of the PIC graphics language [Kernighan 1991], citing, among other reasons, “additional flexibility in the formatting of syntax diagrams [to make them] easier to read and understand” and the renderings being “easier to maintain” [Pikchr contributors 2024]. The manual renderings indeed had features that the automatic ones did not (collapsing, custom alignment and justification, ill-nested components), greater use of wrapping and vertical semantic ε s, and a simpler compilation. But, being hand-written, they introduced stylistic inconsistencies that automatic rendering would avoid (e.g. Fig. 22, Fig. 23a). In this tradeoff between manual layout and manual rendering, the creators evidently chose the latter.

Our approach is an appealing third option in such a tradeoff space. Not only would it recover the benefits of automatic rendering for stylistic consistency, but it would also guarantee *layout consistency*, going beyond both manual layout and rendering. For instance, our notion of alignment would avoid the inconsistencies in Fig. 22, Fig. 23b, and Fig. 23c in current SQLite documentation. Moreover, the translations presented in §4.1 open up the possibility of generating documentation diagrams for a language from the same standard syntax notation its parser uses, avoiding issues like in Fig. 23d. These benefits would come at only a small cost: out of SQLite’s 71 syntax diagrams,

- 45 can be perfectly expressed in our layout language;
- 22 can be expressed in our diagram language but must be laid out differently, due to ill-nesting or vertical semantic ε s in the original layouts; and
- 4 are ill-nested diagrams that would have to be rewritten to equivalent well-nested ones.

One of the 22 from the second category above is shown in Table 2, along with its specification in the pre-2020 SQLite DSL, our diagram language, and Pikchr. (Its pre-2020 layout was perfectly expressible in our layout language but its modern one is not, due to a vertical semantic ε .) On one hand, the rendering from our prototype compiler is not significantly less readable or compact, and it corresponds to just one of many possible configurations for wrapping, alignment, and justification. On the other, our specification is the same size as the pre-2020 manual layout, and simpler, as it does not use layout-specific constructors like `stack` (for wrapping) or `optx` (for alignment), instead leaving those decisions to the compiler. To be clear, we do not aim to cast our prototype as a surefire replacement for SQLite’s current diagrams, but rather as a reasonable alternative in contexts with similar demands for consistency, flexibility, and maintainability.

4.3 Automatic layout in the wild

Existing railroad diagram tools fall two broad categories: *rendering tools* that render layout descriptions, and *grammar translation tools* that turn grammar notations into renderings. We pick a few representatives of each category and describe their capabilities and limitations. We argue that in comparison, our system fills a niche between the two, and can expand the capabilities of both.

Rendering tools define DSLs for specifying railroad layouts and compile these specifications to various backends. [Thibedeau 2019] cites the pre-2020 SQLite DSL as inspiration, and offers similar primitives for manual wrapping (called `stack`), manual alignment (with `opt` and `optx`, but only for two-way stacks with ε sublayouts), etc. It renders to the “cairo” graphics library which can produce SVG, PNG, and PDF output, among other formats. The design of the following tools is largely similar: [atp-mipt 2024; Daenen 2024; Groen 2020; Hollemans 2019; Lueg and Brandl 2024; Takada 2025]. One that stands out is [Atkins 2024], for two reasons: (i) its layout DSL is considerably larger, with uncommon constructs such as Fig. 5d; and (ii) it lets users tag layout components with arbitrary CSS classes that are applied to the corresponding SVG elements, enabling a greater range of custom styling. (It does not use any graphics libraries to construct its SVG output.) These features, along with the fact that it has two parallel implementations in popular languages (Python and JavaScript), may explain why several other tools (e.g. [Krauss 2021; Lischke 2024; Lopez 2024])

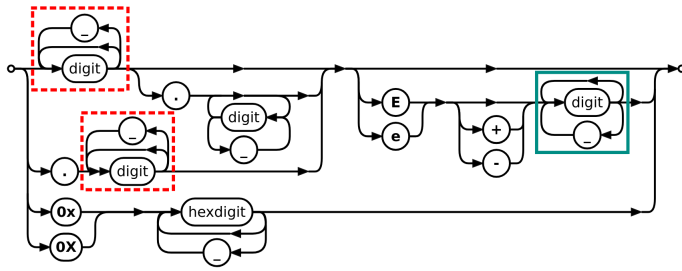

Fig. 22. The two dashed red rectangles indicate identical layouts, but the bottom one has an extra arrowhead, likely a human error. The solid blue rectangle indicates the same conceptual diagram as the other two, but laid out differently, for no apparent reason; laying them all out the same way would not have changed the overall height of the diagram. (SQLite numeric-literal diagram from [SQLite contributors 2024].)

```
{stack
  {line CREATE {or {} TEMP TEMPORARY} TABLE
    {opt IF NOT EXISTS}}
  {line {optx /schema-name .} /table-name}
  {or {line ( {loop column-def ,}
    {loop {} {, table-constraint}} )
    {opt WITHOUT ROWID}}}
  {line AS select-stmt}}
```

```
("CREATE"
 (+ (+ () "TEMP") "TEMPORARY") "TABLE"
 (+ ("IF" "NOT" "EXISTS") ())
 (+ ("schema-name" "." ()) "table-name"
 (+ ("AS" "[select-stmt]"
  (" (" - "[column-def]" " , " )
  (- () ( " , " [table-constraint] ) ) )
  (+ () "[table-options]"))))
```

```
linerad = 10px
linewid = 0.5
sh = 0.21
```

```
circle radius 10%
AB: arrow 2*arrowht
CR: oval "CREATE" fit
T1: oval "TEMP" fit with .w at (linewid right of CR.e, 8*sh below CR)
T2: oval "TEMPORARY" fit with .w at 1.25*sh below T1.w
TBL: oval "TABLE" fit with .w at (linewid right of T2.e, CR)
arrow from CR.e right even with T2; then down even with T1.w
arrow from CR.e right linerad then down even with T1 then to T1.w
arrow from CR.e right linerad then down even with T2 then to T2.w
line from T2.e right linerad then up even with TBL \
then to arrowht left of TBL.w
line from T1.e right even with linerad right of T2.e then up linerad
arrow from TBL.e right
oval "IF" fit
arrow right 2*arrowht
oval "NOT" fit
arrow 2*arrowht
ETS: oval "EXISTS" fit
# IF NOT EXISTS bypass
Y1: .5*sh below T2.s # vertical position of back-arrow
arrow from TBL.e right linerad then down even with Y1 then left even with T2
arrow from ETS.e right linerad then down even with Y1 \
then left even with ETS.w
line left even with TBL.w
```

(62 more hand-written lines...)

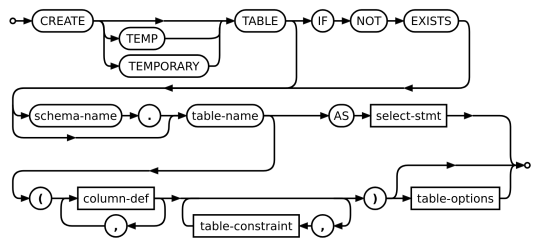
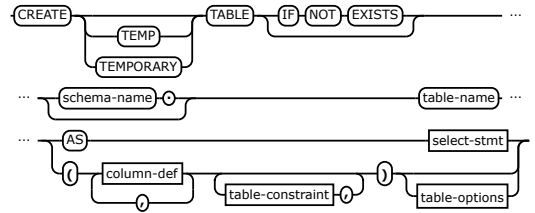
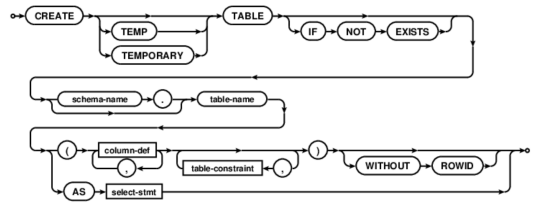

Table 2. SQLite create-table-stmt diagram in the pre-2020 DSL (check-in bd9cdee968), our diagram language, and current Pikchr syntax (check-in e668c1ce28). Note that wrapping is specified explicitly with the stack constructor in the old DSL, but computed automatically in our tool; and our + constructor is variously expressed as or, opt, or optx in the old DSL, depending on the desired layout.

use it as a library. [Abrecht 2023], an in-progress work, tries to use CSS not just for styling but also for rendering, with an XML-like layout language directly embedded in a webpage.

Grammar translation tools take descriptions of *grammars* as input, instead of layouts, and try to ensure the rendered diagram matches the specified grammar. [Avallo 2020] renders from JavaScript-style regular expressions, [Rademacher 2025] from EBNF, and [Anderson and Pickett 2019] (used in IBM documentation, such as Fig. 1d) from a fragment of the XML-based DITA markup language.⁹ The latter two are the only tools we found that perform any automatic wrapping, and both have a greedy algorithm without any user-facing parameters besides the target width. In all grammar translators, the conflict between canonicity and idiomaticity that we described in §4.1 is evident. [Rademacher 2025] implements additional translation rules to better handle recursion, as well as some inlining of nonterminals and factoring of common subexpressions, but these are coarse-grained global settings that affect all rules in a grammar. [Avallo 2020] uses a simple translation and does not produce nonempty loops at all. Many other tools run into the same conflict—[Deckers 2024; Dopler and Schörghenheimer 2005; Hyde 2009; Kirpichenko 2022; Pyeatt 2023; Thiemann 2010; Voglsperger 2024]—and some choose to introduce layout-specific annotations (e.g., to explicitly notate loops) into their otherwise grammar-focused notations. [Voglsperger 2024] takes a unique approach to inlining, where users can click to expand and collapse nonterminals, making it the only tool we have seen that depends on a dynamic rendering format.

Our approach starts from a specification of neither a layout nor a grammar, but a diagram, and compiles it to a layout independent of rendering. Grammar notations are intended for describing formal languages with no canonical visual representation, while the layout DSLs above are tightly coupled with rendering and have no definite notions of diagrammatic equivalence; our diagram language is the missing intermediate representation. The way we characterize the compilation problem lets us implement at least four features that no other tool has to our knowledge:

- parametric wrapping, either globally or locally;
- independent alignment of the two sides of a sublayout, e.g. to collapse one or both sides of a stack automatically in valid contexts, such as happens several times in Fig. 21c;
- direction-aware justification; and
- wrapping and justification that account for the possible internal wrapping of sublayouts.

We posit that our layouts can easily be rendered with additional backends or features from the rendering tools above, and that our diagram language can be an idiomatic target for grammar translation tools that would let them address questions of canonicity independently of layout.

4.4 Performance

We measured how long our prototype compiler took to lay out a few sample diagrams with the same parameters that produced the the layout of each shown in this paper. (Two large ones, SQLite’s `insert-stmt` and `compound-select-stmt`, are in the appendix.) For each diagram, we computed the mean and standard deviation over 10 runs, in milliseconds. We measured layout time on a laptop with an i7-1265U processor at 2.7 GHz and 32 GB of memory, running the Scala.js 1.19.0 compiler and the Node.js 20.10.0 runtime under Ubuntu 22.04.5. Table 3 shows the results.

As a point of comparison, we cite Penrose [Ye et al. 2020], an optimization-based mathematical diagramming tool intended for iterative, exploratory use. Our tool, despite being written with no explicit attention to performance, is well under the 500 ms limit Penrose considers the target for “data visualization, live programming, and other exploratory creative tools”.

⁹The DITA standard defines the `<syntaxdiagram>` fragment as “represent[ing] the syntax of [...] a command, function call, or programming language statement”, not a general railroad diagram language [Eberlein and Anderson 2018].

Diagram	# of constructors	Mean layout time (ms)	Std. dev. (ms)
JSON list (Fig. 21b)	13	44.1	0.6
SQLite table-constraint (Fig. 21c)	34	55.8	4.4
SQLite create-table-stmt (Table 2)	38	55.3	1.3
SQLite compound-select-stmt (Fig. 24)	41	50.1	5.9
SQLite insert-stmt (Fig. 25)	74	75.8	4.7

Table 3. Layout time statistics for a few sample diagrams.

5 Related work

In §1.2, we described how railroad layout is a *1.5-dimensional* problem falling outside the scope of conventional 1- and 2-dimensional approaches to layout. In this section, we briefly survey those approaches to expand on that idea.

A classic 1-dimensional layout problem is pretty-printing. Starting from [Oppen 1980], a steady stream of research—including [Bernardy 2017; Bonichon and Weis 2017; Hughes 1995; Kiselyov et al. 2012; Pugh and Sinofsky 1987; Swierstra and Chitil 2009; Wadler 2003], and most recently [Porncharoenwase et al. 2023]—has explored the space of document specification languages, optimality criteria, algorithmic efficiency, correctness, and programming techniques. However, none can express the branching and remerging in railroad layouts, or the reversed layout of loops.

Some 1-dimensional layouts work with flexible boxes instead of rigid characters and spaces. [Knuth and Plass 1981], designed for \TeX , uses boxes to line-wrap, justify, and hyphenate a paragraph of text, with a practical heuristic for a global optimization problem; however, it gives no special consideration to nested structure beyond lines, words, and characters. CSS flexbox [W3C 2018] solves the same problem for arbitrary boxes, possibly with nested flex layouts or other content, but (unlike our algorithm) does not account for the differing stretchability of boxes during wrapping or justification, and uses a simple greedy wrapping algorithm. Neither \TeX nor flexbox supports independent left and right baselines for boxes as is needed for railroad layout.

Graph layout is perhaps the best-studied 2-dimensional layout problem. [Tamassia 2013] surveys the research behind powerful widely-used tools like Graphviz [Gansner and North 2000] and the algorithms in D3 [Bostock et al. 2011]. Arbitrary mathematical graphs do not have an inherent reading order like code or text; many layout algorithms, like force-directed layout, are accordingly rotationally symmetric. Some algorithms designed for graphs with additional structure, like trees and DAGs, favor one direction over the other. Graphs that come closest to railroad diagrams are *two-terminal series-parallel graphs*—graphs that are either just two vertices with an edge, or a series or parallel composition of other series-parallel graphs [Brandstädt et al. 1999]—and the yWorks graph drawing tool [yWorks 2025] offers a series-parallel layout visually similar to railroad layout. However, it does not perform wrapping. But a more fundamental difference is that series-parallel graphs are defined to be either undirected or directed but acyclic [Alur et al. 2023], whereas railroad layouts specifically have loops, and hence more constraints on collapsing.

Many other 2-dimensional layout problems and tools are further afield from railroad diagrams. A large category is statistical graphs and data-driven visualizations, starting with [Wilkinson 2005]’s seminal work on statistical graphs, inspiring libraries like ggplot2 [Wickham 2016], Vega and Vega-Lite [Heer and Bostock 2010; Satyanarayan et al. 2017], D3 [Bostock et al. 2011], and Matplotlib [Hunter 2007]. Another category is graphics programming, i.e. languages and tools to specify individual pictures with low-level constructs, like PIC [Kernighan 1991], Asymptote [Bowman and Hammerlindl 2008], SVG [W3C 2011], TikZ [Tantau 2023], Diagrama [Florence

[n. d.]], `elm-diagrams` [Vilter 2016], and the Haskell “diagrams” library [Diagrams Contributors [n. d.]]. Some domain-specific visualization tools provide a higher level of abstraction for narrower domains, like Penrose [Ye et al. 2020], Mermaid [Mermaid contributors [n. d.]], Geogebra [GeoGebra Contributors [n. d.]], TikZ libraries and frontends like TikZiT [Kissinger 2020], and program state visualizations like Aquascope for Rust [Crichton and Gray 2023], PythonTutor [Guo 2013], and Gnu DDD [Zeller and Lütkehaus 1996]. Lastly, frameworks like Lean Widgets [Nawrocki et al. 2023] and Alectryon [Pit-Claudel 2020] enable the use of existing visualization tools in the context of computerized proofs.

6 Conclusion

Railroad diagrams are a common visualization of grammars, but limited tooling and a lack of formal attention to their layout has mostly confined them to hand-drawn documentation. In this paper, we presented the first formal treatment of railroad layout, along with a principled implementation that performs *line wrapping* to meet a target width, as well as vertical *alignment* and horizontal *justification* per user-specified policies. We presented a practical heuristic for the optimization problem of nested line wrapping.

We then showed how our approach to automatic railroad layout has practical value for the programming languages, formal methods, and software engineering community. It can replace existing uses of (manually laid-out) railroad diagrams and enable new ones, including in interactive settings like proof assistants. Both our layout language and our approach to compilation can be extended to accommodate further variation in hand-drawn layouts.

The unique nature of railroad layout as a 1.5-dimensional layout problem suggests a number of directions for future work. On one hand, future work could explore whether railroad layout can subsume pretty-printing, and whether the elegant successes of techniques like program calculation for pretty-printers replicate. On the other, a generalization of series-parallel graphs with reversed parallel composition could model railroad diagrams, and serve as a semantic foundation similar to automata for other grammar notations.

Data-Availability Statement

A complete copy of our layout library is available as supplementary material, along with example input, a command-line interface, a GUI, a script to automatically reproduce the figures contained in this paper, and a README explaining how to exercise these artifacts.

Acknowledgments

We thank Viktor Kunčák for noting the connection with series-parallel graphs and for numerous other pointers to the literature. We thank the anonymous peer reviewers for their helpful feedback. This material is based upon work supported by the Air Force Research Laboratory (AFRL) and Defense Advanced Research Projects Agencies (DARPA) under Contract No. FA8750-24-C-B044. Any opinions, findings, and conclusions or recommendations expressed in this material are those of the author(s) and do not necessarily reflect the views of the AFRL and DARPA.

Appendix A: Examples of inconsistencies in manual layouts

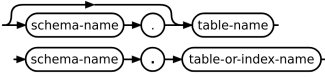

(a) An example of inconsistent rendering. Punctuation terminals are generally in bold, but the one on top (from alter-table-stmt) has normal weight.

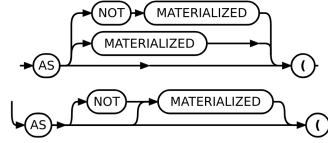

(b) An example of inconsistent layout of the same conceptual subdiagram in the same context. (From common-table-expression and with-clause).

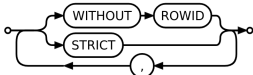

(c) table-options is the only diagram of 71 that ever uses center-alignment.

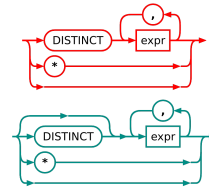

(d) Diff of SQLite expr diagram in check-in 12118bdbb8: “Fix the expression syntax diagram. DISTINCT is not required for the first argument of a function.” In this case, the disconnection between the source grammar and the diagram leads to a semantic bug.

Fig. 23. Layout and rendering inconsistencies in SQLite syntax diagrams [SQLite contributors 2024].

Appendix B: Large SQL-style diagrams

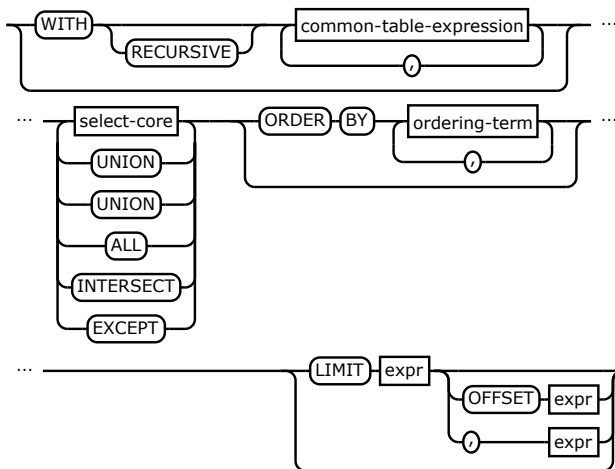

Fig. 24. Our reproduction of a large SQLite diagram (for compound-select-stmt).

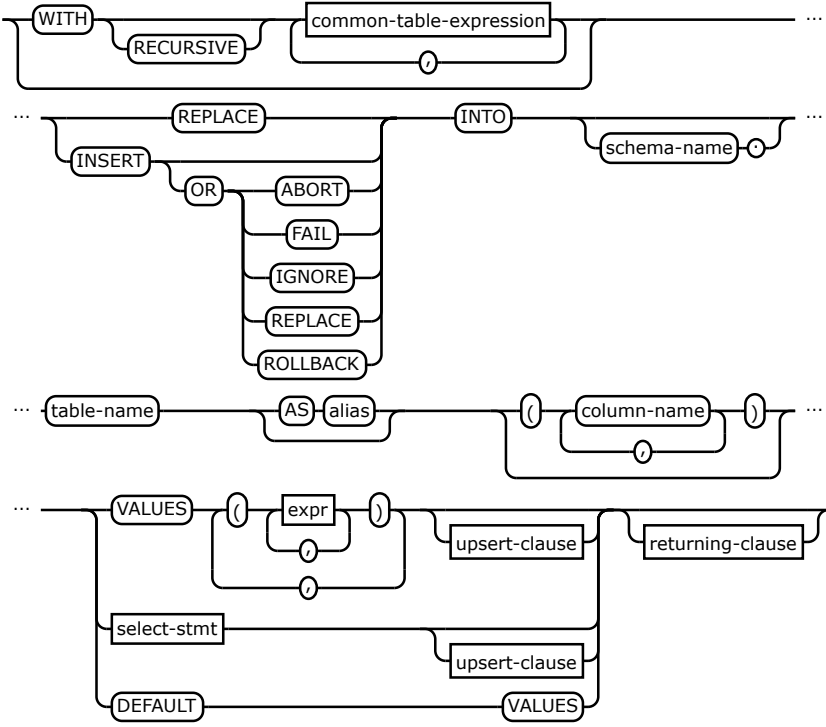

Fig. 25. Our reproduction of another large SQLite diagram (for insert-stmt).

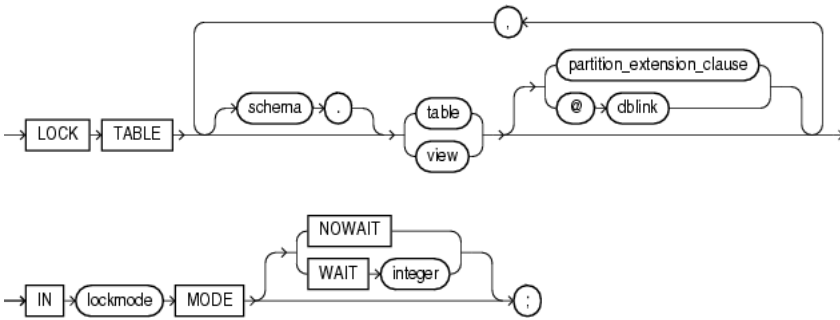

Fig. 26. Syntax diagram for Oracle SQL lock_table [Krishnamurthy 2025].

References

- Daniel Abrecht. 2023. Railroad CSS. <https://daniel-abrecht.github.io/railroad-css/>
- Rajeev Alur, Caleb Stanford, and Christopher Watson. 2023. A Robust Theory of Series Parallel Graphs. *Proceedings of the ACM on Programming Languages* 7, POPL (Jan. 2023), 1058–1088. doi:10.1145/3571230
- Robert D. Anderson and Deborah Pickett. 2019. Svg-Syntaxdiagrams. IBM. <https://github.com/robander/svg-syntaxdiagrams>
- Tab Atkins, Jr. 2024. Railroad-Diagram Generator. <https://github.com/tabatkins/railroad-diagrams/>
- atp-mipt. 2024. JSyntax. <https://github.com/atp-mipt/jsyntax>
- Jeff Avallone. 2020. Regexper. <https://regexper.com>
- Jean-Philippe Bernardy. 2017. A Pretty but Not Greedy Printer (Functional Pearl). *Proceedings of the ACM on Programming Languages* 1, ICFP (Aug. 2017), 6:1–6:21. doi:10.1145/3110250
- Richard S. Bird. 1986. Transformational Programming and the Paragraph Problem. *Science of Computer Programming* 6 (Jan. 1986), 159–189. doi:10.1016/0167-6423(86)90023-7
- Richard Bonichon and Pierre Weis. 2017. Format Unraveled. In *Journées Francophones Des Langages Applicatifs: JFLA 2017*. Gourette, France. <https://hal.science/hal-01503081>
- Michael Bostock, Vadim Ogievetsky, and Jeffrey Heer. 2011. D3: Data-driven Documents. *IEEE Transactions on Visualization & Computer Graphics* 17, 12 (2011), 2301–2309. doi:10.1109/TVCG.2011.185
- John C. Bowman and Andy Hammerlindl. 2008. Asymptote: A Vector Graphics Language. *TUGboat* 29 (2008). <https://www.math.ualberta.ca/~bowman/publications/asyTUG.pdf>
- Andreas Brandstädt, Van Bang Le, and Jeremy P. Spinrad. 1999. Algebraic Compositions and Recursive Definitions. In *Graph Classes: A Survey*. Society for Industrial and Applied Mathematics, Philadelphia, PA, USA, 167–185. doi:10.1137/1.9780898719796.ch11
- Burroughs Corporation. 1972. *Burroughs - B 6700/B 7700 Command and Edit (CANDE) Language Information Manual*. Technical Report 5000318. Burroughs Corporation, USA. https://bitsavers.org/pdf/burroughs/LargeSystems/B6500_6700/5000318_B6700_CANDE_Oct72.pdf
- Feng Chengsu and Wang Xizhi. 650. Lantingji Xu Scroll (Shenlong Version). Courtesy user Aoser on Wikimedia Commons. <https://commons.wikimedia.org/wiki/File:%E7%A5%9E%E9%BE%8D%E8%98%AD%E4%BA%AD%E5%BA%8F%E5%85%A8.JPG>
- Shardul Chiplunkar and Clément Pit-Claudel. 2023. Diagrammatic Notations for Interactive Theorem Proving. In *4th International Workshop on Human Aspects of Types and Reasoning Assistants (HATRA '23)*. doi:10.5075/epfl-SYSTEMF-305144
- Paolo Ciancarini, Angelo Di Iorio, Luca Furini, and Fabio Vitali. 2011. High-Quality Pagination for Publishing. *Software: Practice and Experience* 42, 6 (July 2011), 733–751. doi:10.1002/spe.1096
- Will Crichton and Gavin Gray. 2023. Aquascope: Look Beneath the Surface of Rust. Cognitive Engineering Lab. <https://github.com/cognitive-engineering-lab/aquascope>
- Douglas Crockford. 2001. JSON Object Syntax. <https://www.json.org/json-en.html>
- Quint Daenen. 2024. Railroad. <https://github.com/0x51-dev/railroad>
- Oege de Moor and Jeremy Gibbons. 1999. Bridging the Algorithm Gap: A Linear-Time Functional Program for Paragraph Formatting. *Science of Computer Programming* 35, 1 (Sept. 1999), 3–27. doi:10.1016/S0167-6423(99)00005-2
- Christopher Deckers. 2024. RRDDiagram. <https://github.com/Chrriis/RRDiagram>
- Diagrams Contributors. [n. d.]. Diagrams. Retrieved 2023-07-13 from <https://archives.haskell.org/projects.haskell.org/diagrams/>
- Markus Dopler and Stefan Schörghener. 2005. EBNF Visualizer. <http://dotnet.jku.at/applications/Visualizer/>
- Kristen James Eberlein and Robert D. Anderson. 2018. Darwin Information Typing Architecture (DITA). <http://docs.oasis-open.org/dita/dita/v1.3/dita-v1.3-part3-all-inclusive.html>
- Ecma. 2017. The JSON Data Interchange Syntax. <https://ecma-international.org/publications-and-standards/standards/ecma-404/>
- Spencer Florence. [n. d.]. Diagrama: A Diagram Drawing Library. Retrieved 2023-07-13 from <https://docs.racket-lang.org/diagrama/index.html>
- Emden R. Gansner and Stephen C. North. 2000. An Open Graph Visualization System and Its Applications to Software Engineering. *Software: Practice and Experience* 30, 11 (2000), 1203–1233. doi:10.5555/358668.358697
- GeoGebra Contributors. [n. d.]. GeoGebra. Retrieved 2023-07-13 from <https://www.geogebra.org/>
- Graphviz contributors. 2022. Layout Engines. Retrieved 2025-03-20 from <https://graphviz.org/docs/layouts/>
- Matthijs Groen. 2020. Utf-Railroad. <https://github.com/matthijsgroen/utf-railroad>
- Philip J. Guo. 2013. Online Python Tutor: Embeddable Web-Based Program Visualization for Cs Education. In *Proceeding of the 44th ACM Technical Symposium on Computer Science Education (SIGCSE '13)*. Association for Computing Machinery, New York, NY, USA, 579–584. doi:10.1145/2445196.2445368

- Jeffrey Heer and Michael Bostock. 2010. Declarative Language Design for Interactive Visualization. *IEEE Transactions on Visualization and Computer Graphics* 16, 6 (Nov. 2010), 1149–1156. doi:10.1109/TVCG.2010.144
- Ralf Hinze. 2019. Self-Certifying Railroad Diagrams. In *Mathematics of Program Construction*, Graham Hutton (Ed.). Springer International Publishing, Cham, 103–137. doi:10.1007/978-3-030-33636-3_5
- Matthijs Hollemans. 2019. Railroad-Diagrams-Swift. <https://github.com/hollance/Railroad-Diagrams-Swift>
- John Hughes. 1995. *The Design of a Pretty-printing Library*. Technical Report. Chalmers University of Technology. <https://belle.sourceforge.net/doc/hughes95design.pdf>
- J. D. Hunter. 2007. Matplotlib: A 2D Graphics Environment. *Computing in Science & Engineering* 9, 3 (2007), 90–95. doi:10.1109/MCSE.2007.55
- Nathan Hurst and Kim Marriott. 2008. Satisficing Scrolls: A Shortcut to Satisfactory Layout. In *Proceedings of the Eighth ACM Symposium on Document Engineering*. ACM, Sao Paulo, Brazil, 131–140. doi:10.1145/1410140.1410169
- Julian Hyde. 2009. Clapham. <http://clapham.hydromatic.net/>
- IBM Corporation. 2025. *IBM MQ 9.4 Reference*. Technical Report. <https://www.ibm.com/docs/en/ibm-mq/9.4?topic=mq-reference>
- Charles Jacobs, Wilmot Li, Evan Schrier, David Barger, and David Salesin. 2003. Adaptive Grid-Based Document Layout. *ACM Transactions on Graphics* 22, 3 (July 2003), 838–847. doi:10.1145/882262.882353
- Ramesh Johari, Joe Marks, Ali Partovi, and Stuart Shieber. 1997. Automatic Yellow-Pages Pagination and Layout. *Journal of Heuristics* 2, 4 (March 1997), 321–342. doi:10.1007/BF00132503
- Tom Kamifujii and Jef Raskin. 1979. Apple Pascal Syntax Chart. Courtesy Dana Sibera “NanoRaptor”. <http://www.danamania.com/print/Apple%20Pascal%20Poster/PascalPosterV3%20A1.pdf>
- Eric A. Kenninga. 2003. Optimal Line Break Determination. 13 pages.
- Brian W Kernighan. 1991. *PIC — A Graphics Language for Typesetting User Manual*. Technical Report 116. AT&T Bell Laboratories, Murray Hill, NJ 07974. <https://pikchr.org/home/uv/pic.pdf>
- Stanislav Kirpichenko. 2022. VirtDiagramsDSL. <https://github.com/Stasychbr/VirtDiagramsDSL>
- Oleg Kiselyov, Simon Peyton-Jones, and Amr Sabry. 2012. Lazy v. Yield: Incremental, Linear Pretty-Printing. In *Programming Languages and Systems (Lecture Notes in Computer Science)*, Ranjit Jhala and Atsushi Igarashi (Eds.). Springer, Berlin, Heidelberg, 190–206. doi:10.1007/978-3-642-35182-2_14
- Aleks Kissinger. 2020. TikZiT. <https://tikzit.github.io/>
- Donald E. Knuth and Michael F. Plass. 1981. Breaking Paragraphs into Lines. *Software: Practice and Experience* 11, 11 (Nov. 1981), 1119–1184. doi:10.1002/spe.4380111102
- Dexter Kozen. 1997. Kleene Algebra with Tests. *ACM Transactions on Programming Languages and Systems* 19, 3 (May 1997), 427–443. doi:10.1145/256167.256195
- Philip Krauss. 2021. RRD-ANTLR4. <https://github.com/flashpixx/RRD-ANTLR4>
- Usha Krishnamurthy. 2025. *SQL Language Reference 23ai*. Technical Report F47038-21. Oracle Corporation. <https://docs.oracle.com/en/database/oracle/oracle-database/23/sqlrf/index.html>
- Mike Lischke. 2024. VSCode-ANTLR4. <https://github.com/mike-lischke/vscode-antlr4>
- Rafael Lopez. 2024. PyRailroad. <https://github.com/Epithumia/pyrailroad>
- Lukas Lueg and Georg Brandl. 2024. Railroad. <https://github.com/lukaslueg/railroad>
- Zohar Manna. 1974. *Mathematical Theory of Computation*. McGraw-Hill Book Company, New York, NY, USA.
- Mermaid contributors. [n. d.]. Mermaid | Diagramming and Charting Tool. Retrieved 2023-07-13 from <https://mermaid.js.org/>
- Wojciech Nawrocki, Edward W Ayers, and Gabriel Ebner. 2023. An Extensible User Interface for Lean 4. In *14th International Conference on Interactive Theorem Proving (ITP 2023) (Leibniz International Proceedings in Informatics (LIPIcs))*, Schloss Dagstuhl – Leibniz-Zentrum für Informatik, Dagstuhl, Germany, 24:1–24:20. doi:10.4230/LIPIcs.ITP.2023.24
- Derek C. Oppen. 1980. Prettyprinting. *ACM Transactions on Programming Languages and Systems* 2, 4 (Oct. 1980), 465–483. doi:10.1145/357114.357115
- Pavel Panchekha, Michael D. Ernst, Zachary Tatlock, and Shoaib Kamil. 2019. Modular Verification of Web Page Layout. *Proceedings of the ACM on Programming Languages* 3, OOPSLA (Oct. 2019), 151:1–151:26. doi:10.1145/3360577
- Pavel Panchekha and Emina Torlak. 2016. Automated Reasoning for Web Page Layout. In *Proceedings of the 2016 ACM SIGPLAN International Conference on Object-Oriented Programming, Systems, Languages, and Applications (OOPSLA 2016)*. Association for Computing Machinery, New York, NY, USA, 181–194. doi:10.1145/2983990.2984010
- Arno J. H. Peels, Norbert J. M. Janssen, and Wop Nawijn. 1985. Document Architecture and Text Formatting. *ACM Transactions on Information Systems* 3, 4 (Oct. 1985), 347–369. doi:10.1145/4656.4657
- Robin Piedeleu and Fabio Zanasi. 2023. A Finite Axiomatisation of Finite-State Automata Using String Diagrams. *Logical Methods in Computer Science* 19, 1 (Feb. 2023), 13:1–13:38. doi:10.46298/lmcs-19(1:13)2023
- Pikchr contributors. 2024. How Pikchr Generates the SQLite Syntax Diagrams. Retrieved 2025-03-24 from <https://pikchr.org/home/doc/trunk/doc/sqlitesyntax.md>

- Clément Pit-Claudel. 2020. Untangling Mechanized Proofs. In *Proceedings of the 13th ACM SIGPLAN International Conference on Software Language Engineering*. ACM, Virtual USA, 155–174. doi:10.1145/3426425.3426940
- Sorawee Porncharoenwase, Justin Pombrio, and Emina Torlak. 2023. A Pretty Expressive Printer. *Proceedings of the ACM on Programming Languages* 7, OOPSLA2 (Oct. 2023), 261:1122–261:1149. doi:10.1145/3622837
- William W. Pugh and Steven J. Sinofsky. 1987. *A New Language-Independent Prettyprinting Algorithm*. Technical Report TR 87-808. Cornell University. <https://www.cs.tufts.edu/~nr/cs257/archive/steven-sinofsky/prettyprinting-87-808.pdf>
- Larry D. Pyeatt. 2023. Ebnf2tikz. <https://github.com/pyeatt/ebnf2tikz/>
- Gunther Rademacher. 2025. Rr. <https://github.com/GuntherRademacher/rr/>
- Arvind Satyanarayan, Dominik Moritz, Kanit Wongsuphasawat, and Jeffrey Heer. 2017. Vega-Lite: A Grammar of Interactive Graphics. *IEEE Transactions on Visualization and Computer Graphics* 23, 1 (Jan. 2017), 341–350. doi:10.1109/TVCG.2016.2599030
- SQLite contributors. 2024. Syntax Diagrams for SQLite. <https://www.sqlite.org/syntaxdiagrams.html>
- Guy Lewis Steele, Jr. 2017. It’s Time for a New Old Language. Retrieved 2025-03-04 from <https://groups.csail.mit.edu/mac/users/gjs/6.945/readings/Steele-MIT-April-2017.pdf>
- S. Doaitse Swierstra and Olaf Chitil. 2009. Linear, Bounded, Functional Pretty-Printing. *Journal of Functional Programming* 19, 1 (Jan. 2009), 1–16. doi:10.1017/S0956796808006990
- Yudai Takada. 2025. Railroad Diagrams. https://github.com/ydah/railroad_diagrams
- Roberto Tamassia (Ed.). 2013. *Handbook of Graph Drawing and Visualization* (1st ed.). Chapman & Hall/CRC, New York, NY, USA. <https://cs.brown.edu/people/rtamassi/gdhandbook/>
- Till Tantau. 2023. The TikZ and PGF Packages. www.ctan.org/pkg/pgf
- Kevin Thibedeau. 2019. Syntrax. <https://github.com/kevinpt/syntrax>
- Peter Thiemann. 2010. Ebnf2ps: Peter’s Syntax Diagram Drawing Tool. <http://www2.informatik.uni-freiburg.de/~thiemann/haskell/ebnf2ps/>
- Pete Vilter. 2016. Elm-Diagrams. <https://package.elm-lang.org/packages/vilterp/elm-diagrams/latest>
- Alexander Voglsperger. 2024. EBNF Railroad Visualizer. https://github.com/MrMinemeet/ebnf_railroad_visualizer
- W3C. 2011. Scalable Vector Graphics (SVG) 1.1 (Second Edition). <https://www.w3.org/TR/SVG11/>
- W3C. 2018. *CSS Flexible Box Layout Module Level 1*. Candidate Recommendation. W3C. <https://www.w3.org/TR/css-flexbox-1/>
- W3C. 2025. *CSS Box Alignment Module Level 3*. Working Draft. W3C. <https://www.w3.org/TR/css-align-3/>
- Philip Wadler. 2003. A Prettier Printer. In *The Fun of Programming*, Jeremy Gibbons and Oege de Moor (Eds.). Macmillan Education UK, London, 223–243. doi:10.1007/978-1-349-91518-7_11
- Hadley Wickham. 2016. *Ggplot2: Elegant Graphics for Data Analysis*. Springer-Verlag, New York, NY, USA. <https://ggplot2.tidyverse.org>
- Leland Wilkinson. 2005. *The Grammar of Graphics* (2nd ed.). Springer-Verlag, New York. doi:10.1007/0-387-28695-0
- Niklaus Wirth. 1970. *The Programming Language Pascal*. Report. ETH Zürich, Zürich, Switzerland. doi:10.3929/ethz-a-004150844
- Katherine Ye, Wode Ni, Max Krieger, Dor Ma’ayan, Jenna Wise, Jonathan Aldrich, Joshua Sunshine, and Keenan Crane. 2020. Penrose: From Mathematical Notation to Beautiful Diagrams. *ACM Transactions on Graphics* 39, 4 (Aug. 2020). doi:10.1145/3386569.3392375
- yWorks. 2025. yFiles for HTML. yWorks. <https://www.yworks.com/yfiles-overview>
- Andreas Zeller and Dorothea Lütkehaus. 1996. DDD—a Free Graphical Front-End for UNIX Debuggers. *ACM SIGPLAN Notices* 31, 1 (Jan. 1996), 22–27. doi:10.1145/249094.249108