

# Shapley Revisited: Tractable Responsibility Measures for Query Answers

MEGHYN BIENVENU, Univ. Bordeaux, CNRS, Bordeaux INP, LaBRI, UMR 5800, France

DIEGO FIGUEIRA, Univ. Bordeaux, CNRS, Bordeaux INP, LaBRI, UMR 5800, France

PIERRE LAFOURCADE, Univ. Bordeaux, CNRS, Bordeaux INP, LaBRI, UMR 5800, France

The Shapley value, originating from cooperative game theory, has been employed to define responsibility measures that quantify the contributions of database facts to obtaining a given query answer. For non-numeric queries, this is done by considering a cooperative game whose players are the facts and whose wealth function assigns 1 or 0 to each subset of the database, depending on whether the query answer holds in the given subset. While conceptually simple, this approach suffers from a notable drawback: the problem of computing such Shapley values is #P-hard in data complexity, even for simple conjunctive queries. This motivates us to revisit the question of what constitutes a reasonable responsibility measure and to introduce a new family of responsibility measures – weighted sums of minimal supports (WSMS) – which satisfy intuitive properties. Interestingly, while the definition of WSMSs is simple and bears no obvious resemblance to the Shapley value formula, we prove that every WSMS measure can be equivalently seen as the Shapley value of a suitably defined cooperative game. Moreover, WSMS measures enjoy tractable data complexity for a large class of queries, including all unions of conjunctive queries. We further explore the combined complexity of WSMS computation and establish (in)tractability results for various subclasses of conjunctive queries.

☞ This pdf contains internal links: clicking on a notion leads to its *definition*.

☞ This article is based on the PODS’25 paper [4].

## 1 Introduction

Responsibility measures assign scores to database facts based upon how much they contribute to the obtention of a given query answer, thereby providing a quantitative notion of explanation for query results. In the present paper, we shall take a fresh look at how to define and compute such responsibility measures, focusing on the class of monotone non-numeric queries, which notably includes (unions of) conjunctive queries and path queries. Although several responsibility measures have been explored in the database literature [1, 20, 24, 28], one particular measure, based upon the Shapley value, has been the focus of much of the recent work [3, 6, 16–18, 20, 26].

We recall that the Shapley value [29] was first introduced in game theory for the purpose of fairly distributing wealth amongst the players in a cooperative game. Formally, such a game is defined using a “wealth function”  $\omega : 2^{\text{Players}} \rightarrow \mathbb{R}_{\geq 0}$  which assigns a number to every subset of players. The Shapley value then defines a function  $\phi_\omega : \text{Players} \rightarrow \mathbb{R}$  from players to numbers, which measures their individual contributions. The Shapley function has been famously characterized as the only function satisfying four fundamental axioms (which will be detailed in Section 3).

In the database context, the Shapley value has been utilized for distributing the responsibility for a given query answer among database facts. This is done by considering games in which the facts are the players and the query is captured using the wealth function. For *numeric queries* (i.e., queries yielding a number when evaluated on a database), the sensible choice for the wealth function is the query itself [20]. That is, for a given input numeric query  $q$ , database  $\mathcal{D}$ , and set of facts  $S \subseteq \mathcal{D}$  over which we want to distribute the contribution – known as ‘endogenous’ facts for historical

reasons –, the Shapley value distributes the total wealth  $q(\mathcal{D}) = N$  among the facts of  $S$  (i.e., the ‘players’) using  $q$  itself as the wealth function.

For non-numeric queries, whose output is a set of tuples of constants rather than a number, it is less obvious how to define the wealth function. The solution that was originally proposed in [20] and adopted in all subsequent studies is to first reduce to the Boolean case by considering the Boolean query  $q(\bar{a})$  associated with the input query  $q$  and answer tuple  $\bar{a}$ , and then to treat Boolean queries as numeric queries that output 0 or 1 depending on whether the query holds true in a set of facts. We shall refer to the Shapley value obtained by encoding queries using such a 0/1 wealth function as the *drastic* Shapley value.

The use of the drastic Shapley value for responsibility attribution of non-numeric queries has received significant attention of late [3, 6, 16–18, 20, 26]. The main focus has been on precisely identifying the data complexity of computing the drastic Shapley value, considering various classes of queries and drawing connections to the related tasks of probabilistic query evaluation and model counting. The key takeaway is that drastic Shapley value computation is computationally challenging, being  $\text{FP}^{\#P}$ -complete in data complexity even for some very simple conjunctive queries. The situation is more favourable if one moves from exact to approximate computation, namely, Monte-Carlo sampling provides a fully polynomial randomized approximation scheme (FPRAS) for every UCQ [20, Corollary 4.13], even if practical implementations appear to be challenging (see experiments and discussions in [6, §6.2]).

Another potential drawback to the drastic Shapley value is that it may be hard to interpret the resulting scores, in particular to understand how a change in the database would impact the relative scores of a pair of facts, which may be influenced by seemingly unrelated facts (as exemplified by Example 4.1). In its original conception, the Shapley value uses a wealth function whose numbers correspond to some ‘cost’ or ‘wealth’ in some implicit *unit of measure* (e.g. dollars, number of workers, number of tuples satisfying some property). This same idea carries over to numeric queries, as the ‘total wealth’ to distribute is given by the query itself, which outputs a number with a clear meaning. However, the drastic Shapley approach casts the Boolean values ‘true’ and ‘false’ into the (real) numbers 1 and 0, in order to apply operations like mean. This can make the interpretation of the drastic Shapley value not always intuitive to a non-expert end user, which might hence hinder its use for explainability tasks.

Given both the high computational complexity and non-obvious interpretability of the drastic Shapley value, a natural question is whether we can find another responsibility measure for non-numeric queries that is computationally and conceptually simpler. One might be tempted to reply ‘no’, arguing that the uniqueness result for the Shapley axioms forces us to adopt the drastic Shapley value. However, these axioms were introduced for cooperative games, rather than responsibility measures for queries, and their meaning crucially depends on the manner in which queries are translated into games. In fact, we shall see that when these axioms are translated from games to responsibility measures, using the drastic wealth function, only two of the four axioms yield unarguably desirable properties for such measures (and one axiom is actually nonsensical).

In view of the preceding discussion, it is both natural and possible to explore alternative responsibility measures for non-numeric queries. This will be the main topic of the present paper, whose conceptual and technical contributions are summarized in what follows.

Our first conceptual contribution is to propose a set of *desirable properties for responsibility measures*, focusing on the case of monotone non-numeric queries. We begin by examining in Section 3 the properties that result from mapping the Shapley axioms into the database setting using the drastic Shapley wealth function. We observe that only two yield clearly desirable properties in our setting, while the other two are either nonsensical or of debatable interest. As this leaves us

with only two, rather weak, properties, we then introduce in Section 4.1 two additional properties that capture intuitions as to how a reasonable responsibility measure should behave.

Our second conceptual contribution is to propose in Section 4.2 a *novel family of responsibility measures* specifically tailored to monotone non-numeric queries, which we name *weighted sums of minimal supports* (WSMS). As the name suggests, the measure of a fact consists of a weighted sum of the sizes of minimal supports of the query (answer) that contain the fact. These measures have an intuitive definition, they enjoy the identified desired properties, and the values arising from these measures have a simple interpretation. Further, we can show that each measure from this family can be equivalently seen as the Shapley value of a suitable cooperative game (Section 4.3). We also argue that the family is flexible and can accommodate weight functions giving more importance to small supports than to the number of supports, or vice-versa (Section 4.4).

Our main technical contribution is a *complexity analysis of WSMS computation*. In Section 5, we show that, in contrast to the drastic Shapley value, WSMSs enjoy tractable data complexity for all unions of conjunctive queries (and more generally, bounded queries) via a straightforward algorithm. For combined complexity, we obtain a general  $\text{FP}^{\#\text{P}}$  bound for a wide range of query classes (Section 6.1). We then focus on conjunctive queries (CQs) and show that, unfortunately, even for acyclic CQs without constants, computing WSMS is  $\#\text{P}$ -hard. However, for acyclic self-join free CQs, the WSMS computation can be reduced to evaluating ‘counting CQs’ (more precisely, counting the number of homomorphisms from acyclic CQs), which is known to be tractable. Further, in Section 6.3 we show that if both the generalized hypertree width and the amount of self-joins (via a measure we define with this purpose) are bounded, then WSMSs on CQs can be computed in polynomial time.

As a final contribution, we explore the *properties of some related measures*. First, having observed that WSMSs are closely connected to the MI inconsistency measure [15], we define in Section 7.1 three new responsibility measures based upon inconsistency measures and show that they are less suitable for semantic or computational reasons. We likewise show in Section 7.2 that redefining WSMSs by counting homomorphisms rather than minimal supports yields a measure which violates a basic property. Finally, in Section 7.3, we recall the SHAP score that has been used for explaining classifiers in machine learning and suggest how the WSMS definition could be adapted to fix some semantic problems with the SHAP score (albeit at the cost of a higher computational complexity).

## 2 Preliminaries

We fix disjoint infinite sets  $\text{Const}$ ,  $\text{Var}$  of *constants* and *variables*, respectively. For any syntactic object  $O$  (e.g. database, query), we will use  $\text{var}(O)$  and  $\text{const}(O)$  to denote the sets of variables and constants contained in  $O$ , and let  $\text{term}(O) \doteq \text{var}(O) \cup \text{const}(O)$  denote its set of *terms*.

A *(relational) schema* is a finite set of relation symbols, each associated with a (positive) arity. A *(relational) atom* over a schema  $\Sigma$  takes the form  $R(\bar{t})$  where  $R$  is a *relation name* from  $\Sigma$  of some arity  $k$ , and  $\bar{t} \in (\text{Const} \cup \text{Var})^k$ . A *fact* is an atom which contains only constants. A *database*  $\mathcal{D}$  over a schema  $\Sigma$  is a finite set of facts over  $\Sigma$ .

A *(non-numeric) query*  $q$  of arity  $k \geq 0$  over schema  $\Sigma$  is a syntactic object associated with a *semantics* consisting of a function that maps every database  $\mathcal{D}$  over  $\Sigma$  to a set  $q(\mathcal{D})$  of  $k$ -tuples of elements from  $\text{const}(\mathcal{D})$ ,<sup>1</sup> called the *answers* to  $q$  on  $\mathcal{D}$ . When  $k = 0$ , we say that  $q$  is a *Boolean query*, and we shall write  $\mathcal{D} \models q$  in place of  $\mathcal{D}(q) = \{()\}$ . As explained in Section 3.1, it will be sufficient to work with Boolean queries, so *except where otherwise indicated, we will henceforth abuse terminology and write query to mean Boolean query*.

<sup>1</sup>Note the common notation between the syntax  $q$  and the (implicit) semantics  $\mathcal{D} \mapsto q(\mathcal{D})$ .

We shall further focus our attention on *monotone* queries, i.e. queries  $q$  such that  $\mathcal{D} \models q$  implies  $\mathcal{D} \cup \mathcal{D}' \models q$  for every pair of databases  $\mathcal{D}, \mathcal{D}'$ . When  $\mathcal{D} \models q$  and  $q$  is monotone, we call  $\mathcal{D}$  a *support* for  $q$  and say it is a *minimal support* if  $\mathcal{D}$  properly contains no other support. We denote by  $MS_q(\mathcal{D})$  the set of all minimal supports for  $q$  that are subsets of  $\mathcal{D}$ . A monotone query  $q$  is *bounded* if the sizes of minimal supports for  $q$  are bounded by a constant (independent of the database). We say that a fact  $\alpha \in \mathcal{D}$  is *relevant* for  $q$  in  $\mathcal{D}$  if  $\alpha \in S$  for some  $S \in MS_q(\mathcal{D})$ , and *irrelevant* otherwise.

We now define some concrete classes of monotone (Boolean) queries. A *conjunctive query* (CQ) over  $\Sigma$  takes the form  $q = \exists \bar{x} \varphi$  where  $\varphi$  is a conjunction of atoms over  $\Sigma$  and  $\bar{x} = \text{var}(\varphi)$ . We use  $\text{atoms}(q)$  to denote the set of atoms of a CQ  $q$ . An *acyclic CQ* (ACQ) is a CQ  $q = \exists \bar{x} \varphi$  such that there is a tree whose vertices are  $\text{atoms}(q)$  and such that for vertices  $\alpha, \alpha', \beta$ ,  $\text{var}(\alpha) \cap \text{var}(\alpha') \subseteq \text{var}(\beta)$  whenever  $\beta$  lies on the unique simple path between  $\alpha, \alpha'$ . We shall denote by CQ (resp. ACQ) the class of CQs (resp. ACQs). Other prominent classes of monotone queries include: *unions of conjunctive queries* (UCQs), which are finite disjunctions of CQs, and *path queries*, which take the form  $\mathcal{L}(c, d)$  where  $\mathcal{L}$  is a language over a set of binary relation names and  $c, d$  are constants, with the semantics of testing whether there is a directed path from  $c$  to  $d$  whose label is in  $\mathcal{L}$  in the input database. In particular, a (Boolean) *regular path query* (RPQ) is a path query where  $\mathcal{L}$  is a regular language.

We recall that the semantics of a CQ  $q$  is defined by  $\mathcal{D} \models q$  iff there is a function  $h : \text{term}(q) \rightarrow \text{term}(\mathcal{D})$  such that (i)  $R(\bar{t}) \in \text{atoms}(q)$  implies  $R(h(\bar{t})) \in \mathcal{D}$ , and (ii)  $h(c) = c$  for every  $c \in \text{const}(q)$ . Such a function is called a (query) *homomorphism* (from  $q$  to  $\mathcal{D}$ ), and we write  $q \xrightarrow{\text{hom}} \mathcal{D}$  to indicate the existence of such a homomorphism. We shall also consider homomorphisms of a CQ  $q$  to another CQ  $q'$ , denoted  $q \xrightarrow{\text{hom}} q'$  and defined similarly. The *core* of a CQ  $q$ , denoted  $\text{core}(q)$ , is the unique (up to isomorphism) minimal equivalent query [5].

We use the standard notion of *polynomial-time Turing-reductions* between numeric problems  $\Psi_1, \Psi_2$ , and we write  $\Psi_1 \leq_{\text{poly}} \Psi_2$  if there is a polynomial-time algorithm for  $\Psi_1$  using a  $\Psi_2$  oracle.

### 3 Responsibility Measures and the Drastic Shapley Value

The (drastic) Shapley value has been widely studied as a way of defining a responsibility measure for database queries. A seminal and oft-cited result [29] in cooperative game theory establishes that the Shapley value is the unique wealth distribution measure that satisfies a specific set of ‘Shapley axioms’. It is tempting to think that this unicity result transfers to the setting of database responsibility measures, and thus that the drastic Shapley value considered in prior work is the only reasonable approach. However, we consider that there is no single valid notion of a responsibility measure, and we shall show in this section that the Shapley axioms are insufficient to argue the contrary. We start by introducing the notion of responsibility measure for non-numeric database queries, before recalling the definition of the Shapley value from game theory and how it has been utilized to define a concrete such responsibility measure. Finally, we discuss the relevance of the Shapley axioms in the database setting and motivate the interest of exploring alternative measures.

#### 3.1 Responsibility Measures

In line with prior studies [3, 16, 20, 24], we work with *partitioned databases*, in which the database  $\mathcal{D}$  is partitioned into *endogenous* and *exogenous* facts, denoted by  $\mathcal{D}_n$  and  $\mathcal{D}_x$  respectively. The aim will be to quantify the responsibility of a given endogenous fact to the obtention of some query answer. Formally, we shall be interested in *responsibility measures*, defined as functions  $\phi$  which take as input a partitioned database  $\mathcal{D}$ , a (possibly non-Boolean) query  $q$ , an answer  $\bar{a}$  to  $q$  in  $\mathcal{D}$ , and a fact  $\alpha \in \mathcal{D}_n$ , and which output a quantitative score measuring how much  $\alpha$  contributes to  $\bar{a} \in q(\mathcal{D})$ . We may however simplify the presentation by replacing the input answer  $\bar{a}$  and (possibly non-Boolean)

query  $q$  by the associated Boolean query  $q(\bar{a})$ , defined by letting  $\mathcal{D} \models q(\bar{a})$  iff  $\bar{a} \in q(\mathcal{D})$ . In this manner, we can eliminate the answer tuple from the arguments of the responsibility measure and work instead with ternary responsibility measures, i.e.  $\phi(\mathcal{D}, q, \alpha)$  with Boolean  $q$ . Henceforth, we shall thus assume w.l.o.g. that the input query is always Boolean, as well as monotone.<sup>2</sup> We discuss in Sections 3.3 and 4.1 the desirable properties of responsibility measures.

### 3.2 Shapley Value: From Games to Databases

A *cooperative game* is given by a finite set of players  $P$  and a *wealth function*  $\xi : 2^P \rightarrow \mathbb{Q}$  that represents the wealth generated by every possible coalition of players, such that  $\xi(\emptyset) = 0$ . To define the *Shapley value*, assume players arrive one by one in a random order, and each earns the difference between the coalition's wealth before she arrives and after. The *Shapley value* of a player  $p \in P$  is her expected earnings in this scenario, which can be expressed as:

$$\text{Sh}(P, \xi, p) \triangleq \frac{1}{|P|!} \sum_{\sigma \in \mathbb{P}(P)} (\xi(\sigma_{<p} \cup \{p\}) - \xi(\sigma_{<p})) \quad (1)$$

where  $\mathbb{P}(P)$  denotes the set of permutations of  $P$  and  $\sigma_{<p}$  the set of players that appear strictly before  $p$  in the permutation  $\sigma$ .

Besides the Shapley value, another wealth distribution scheme, the *Banzhaf power index*, has been applied to responsibility distribution for database queries [1, 28].<sup>3</sup> This alternative scheme is closely related to the Shapley value, to the point where [17] introduced the notion of *Shapley-like* scores to collectively designate a class of wealth distribution schemes that contains them both. Formally, Shapley-like scores are defined by the formula:

$$\mathcal{S}_c(P, \xi, p) \triangleq \sum_{B \subseteq P \setminus \{p\}} c(|B|, |P|) (\xi(B \cup \{p\}) - \xi(B)) \quad (2)$$

where  $c(|B|, |P|)$  is a *coefficient function* characterising the measure. The Shapley value is obtained by letting  $c(|B|, |P|) = \frac{|B|!(|P|-|B|-1)!}{|P|!}$  and the Banzhaf power index by letting  $c(|B|, |P|) = 1$ .

To employ these notions in the database setting, one must specify how to build games from queries and databases. Concretely, we need a *wealth function family*  $\Xi^\star$  which takes as parameters a query  $q$  and a set  $\mathcal{D}_x$  of exogenous facts and defines a wealth function  $\xi_{q, \mathcal{D}_x}^\star$ . For instance the standard wealth function family in the literature [3, 20] is what we call the *drastic* wealth function family,<sup>4</sup> denoted by  $\Xi^{\text{dr}}$  and defined as follows:  $\xi_{q, \mathcal{D}_x}^{\text{dr}}$  assigns 1 to every set  $S$  of facts such that  $S \cup \mathcal{D}_x \models q$  and 0 to the others, unless  $\mathcal{D}_x \models q$  in which case it assigns 0 to all sets.

Once a wealth function family has been defined, it can be combined with the Shapley value to obtain a responsibility measure, whose output is  $\text{Sh}(\mathcal{D}_n, \xi_{q, \mathcal{D}_x}^\star, \alpha)$ . Given a class of queries  $\mathcal{C}$ , we denote by  $\text{SVC}_{\mathcal{C}}^\star$  the associated computational problem of computing, for a given query  $q \in \mathcal{C}$ , partitioned database  $\mathcal{D}$  and fact  $\alpha \in \mathcal{D}_n$ , the value  $\text{Sh}(\mathcal{D}_n, \xi_{q, \mathcal{D}_x}^\star, \alpha)$ . When  $\mathcal{C}$  consists of a single query  $q$ , we simply write  $\text{SVC}_q^\star$ . Note the superscript  $\star$  that is consistent across all notations. Prior work on Shapley value computation for Boolean queries considered  $\star = \text{dr}$ , i.e.  $\text{SVC}_q^{\text{dr}}$  and  $\text{SVC}_{\mathcal{C}}^{\text{dr}}$ .

<sup>2</sup>The study of non-monotone queries is left for future work, see Section 8.

<sup>3</sup>The ‘causal effect’ measure considered in [28] coincides with the Banzhaf power index [20, Proposition 5.5].

<sup>4</sup>The name *drastic* is borrowed from the closely related *drastic inconsistency measure* (see, e.g., measure ‘ $I_d$ ’ in [21, 30]) assigning 0 or 1 depending on whether the database is consistent w.r.t. a property. See also Section 7.1.

### 3.3 Shapley Axioms

The importance of the Shapley value stems from satisfying several axioms, deemed desirable in many scenarios for fair distribution of wealth or responsibility in cooperative games. The four fundamental axioms put forth by Shapley for a real-valued wealth distribution function  $\psi$  (whose inputs are a set of players, a wealth function, and a distinguished player) are as follows:

- (Sym) *Symmetry*: if two players  $\alpha, \beta \in P$  are equivalent in the sense that  $\forall S \subseteq P \setminus \{\alpha, \beta\}. \xi(S \cup \{\alpha\}) = \xi(S \cup \{\beta\})$ , then  $\psi(P, \xi, \alpha) = \psi(P, \xi, \beta)$ ;
- (Null) *Null player*: any (so-called *null*) player who does not contribute to increasing the wealth (i.e., such that  $\xi(S \cup \{\alpha\}) = \xi(S)$  for all  $S$ ) must obtain 0 as contribution;
- (Lin) *Linearity*: the value of the sum of two wealth functions  $\xi_1 + \xi_2$  is just the sum of values over the separate wealth functions:  $\psi(P, \xi_1 + \xi_2, \alpha) = \psi(P, \xi_1, \alpha) + \psi(P, \xi_2, \alpha)$ ;
- (Eff) *Efficiency*: the sum  $\sum_{\alpha \in P} \psi(P, \xi, \alpha)$  of all contributions equals the total wealth  $\xi(P)$ .

Shapley has famously shown in [29, p. 295] that Sh is the *unique* function  $\psi$  satisfying (Sym)–(Eff) and hence that the Shapley value is ‘the’ function to consider in any context where the axioms above make sense and should be met.<sup>5</sup>

However, the preceding axioms are phrased in terms of cooperative games, whereas we are interested in properties of responsibility measures, which take queries and databases as arguments. The interpretation of the Shapley axioms in the database setting thus crucially depends on the way we model the queries as cooperative games, i.e. the wealth function family we use. Given that all prior work has focused on the drastic wealth function,  $\Xi^{\text{dr}}$ , it is instructive to instantiate the above axioms with  $\Xi^{\text{dr}}$  in order to understand which properties of responsibility measures have been invoked to justify the drastic Shapley value for non-numeric queries. We first consider (Sym):

- (Sym-dr) If two facts  $\alpha, \beta \in \mathcal{D}_n$  are equivalent in the sense that for all  $S \subseteq \mathcal{D}_n \setminus \{\alpha, \beta\}, S \cup \{\alpha\} \cup \mathcal{D}_x \models q$  iff  $S \cup \{\beta\} \cup \mathcal{D}_x \models q$ , then  $\phi(\mathcal{D}, q, \alpha) = \phi(\mathcal{D}, q, \beta)$ .

We consider (Sym-dr) to be a very desirable property. In fact, we would suggest to strengthen it as follows to ensure syntax independence not only for the input facts but also for the queries:

- (Sym-db) If two queries  $q_1, q_2$  have the same semantics (i.e., define the same Boolean function), and facts  $\alpha, \beta \in \mathcal{D}_n$  are such that for all  $S \subseteq \mathcal{D}_n \setminus \{\alpha, \beta\}, S \cup \{\alpha\} \cup \mathcal{D}_x \models q_1$  iff  $S \cup \{\beta\} \cup \mathcal{D}_x \models q_2$ , then  $\phi(\mathcal{D}, q_1, \alpha) = \phi(\mathcal{D}, q_2, \beta)$ .

Turning now to (Null), we observe that *null players* translate into irrelevant facts, yielding:

- (Null-dr) If a fact  $\alpha \in \mathcal{D}_n$  is irrelevant, then  $\phi(\mathcal{D}, q, \alpha) = 0$ .

Again, we find (Null-dr) desirable but insufficient, as we wish to be able to decide relevance:

- (Null-db) If a fact  $\alpha \in \mathcal{D}_n$  is irrelevant then  $\phi(\mathcal{D}, q, \alpha) = 0$ ; otherwise  $\phi(\mathcal{D}, q, \alpha) > 0$ .<sup>6</sup>

Moving on to (Lin), we come to our first issue. This axiom should intuitively translate as “the sum of the responsibility for two queries is the responsibility for the sum query”, which makes sense when dealing with numeric queries (for which the sum query is well defined), but whose meaning is unclear for non-numeric queries. When instantiated with  $\Xi^{\text{dr}}$ , the property is nonsensical because for all non-trivial cases  $\xi_{q_1, \mathcal{D}_x}^{\text{dr}}(\mathcal{D}_n) + \xi_{q_2, \mathcal{D}_x}^{\text{dr}}(\mathcal{D}_n) = 2$ , which cannot coincide with  $\xi_{q, \mathcal{D}_x}^{\text{dr}}(\mathcal{D}_n)$  (whose value is 0 or 1), no matter which Boolean  $q$  we use to represent the ‘sum query’.<sup>7</sup>

Let us finally consider the meaning of (Eff) once instantiated with the drastic wealth function:

<sup>5</sup>In [29], Shapley presents only 3 axioms: (Null) is omitted and a different stronger alternative axiom for (Eff) is used, which implies both (Null) and (Eff) as stated here. We prefer to adopt the widely used modern presentation of the Shapley axioms, see for example [19, §2].

<sup>6</sup>Recall that the query  $q$  we consider is always Boolean and monotone.

<sup>7</sup>An alternative to the linearity axiom that still makes sense for Boolean games has been introduced in [8, Axiom S3’], but we believe it still doesn’t yield a very natural axiom for responsibility measures. See Remark A.1.

(Eff-dr) The sum  $\sum_{\alpha \in \mathcal{D}_n} \phi(\mathcal{D}, q, \alpha) = 1$  if  $\mathcal{D} \models q$  and  $\mathcal{D}_x \not\models q$ , and 0 otherwise.

While it seems reasonable enough to ask that the sum of contributions of the facts is equal to the value attained by the full set of endogenous facts, it is rather more questionable why we should always arrive at the same total value of 1 when  $\mathcal{D} \models q$  and  $\mathcal{D}_x \not\models q$ , irrespective of the particular  $q$  and  $\mathcal{D}$ . The fact that queries are modelled using constant-sum games means that the drastic Shapely value is highly sensitive to database changes: the addition of *any* new relevant fact will affect the values of *all* relevant facts, as they need to share the same total wealth (of 1). This, in turn, can make it challenging to interpret the drastic Shapley value of facts without appealing to the probabilistic process that underlies Equation (1). Note that this differs markedly from the case of numeric queries for which the total value – defined via the query result – varies according to the input database and finds its meaning in the query itself.

In view of the identified issues with the translations of (Lin) and (Eff) into the database setting, the Shapley axioms cannot be used to argue that the drastic Shapley value is the only (or the best) approach to defining a reasonable responsibility measure. Indeed, only (Sym-db) and (Null-db) are truly natural, and they constitute rather weak minimal requirements.

This raises the obvious questions: *What are desirable properties for responsibility measures of non-numeric queries? And how can they be realized?* In Section 4, we address these questions and propose a novel family of measures conforming to the identified properties.

## 4 Alternative responsibility measures

As discussed in Section 3, the Shapley axioms provide insufficient justification for arguing that the drastic Shapley value is the *only reasonable* or the *best* measure for non-numeric queries. Further,  $\text{SVC}_q^{\text{dr}}$  is #P-hard for some very simple CQs [20]. This motivates us to consider alternative measures, which can be done in two ways:

- Approach 1:* we may consider alternative responsibility attribution functions more specifically tailored to monotone non-numeric queries which may not be based on a Shapley score, or  
*Approach 2:* we may insist in the use of the Shapley value but for a different associated wealth function, one in which axioms (Eff) and (Lin) are more meaningful.

This section is organized as follows. In Section 4.1 we follow the first approach by identifying a set of truly desirable properties and proposing an alternative family of measures conforming to them in Section 4.2. Then in Section 4.3 we show that these alternative measures can all be seen as Shapley values for different wealth functions, and thus that they could also have been found by following the second approach. Finally Section 4.4 will suggest explicit measures within the family.

### 4.1 Desired Properties of Responsibility Measures

We already have from Section 3 the properties (Sym-db) and (Null-db) which capture some basic requirements. To identify further desirable properties, we shall go back to [20] where the drastic Shapley value was first introduced. There, a previously defined quantitative measure (the causal responsibility [24]) was argued to yield counterintuitive results on a specific example [20, Example 5.2], a slight adaptation of which is presented in Figure 1-(a). Indeed, the causal responsibility assigns the same score to all edges in this example, even though  $e_0$  intuitively has more responsibility as it satisfies the query on its own, whereas  $e_1$  and  $e_2$  must be used together. More generally, this idea can be captured by the following axiom (*AOTBE* stands for “All Other Things Being Equal”):

(MS1) *AOTBE*, a fact that appears in smaller minimal supports should have higher responsibility.

In a similar vein, it turns out that the causal responsibility also gives the same score to  $e_5$  and  $e_7$  in the example represented in Figure 1-(b). Again, this is counterintuitive because the fact  $e_5$  only

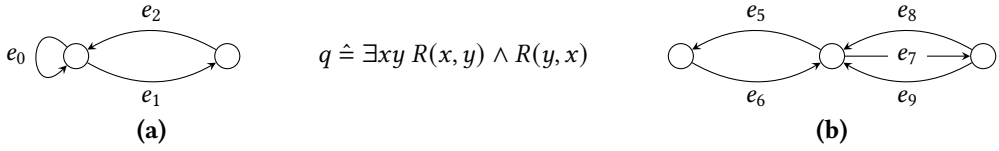

Fig. 1. Pathological examples for some responsibility measures. The databases are represented as graphs with nodes being constants and edges being  $R$ -tuples.

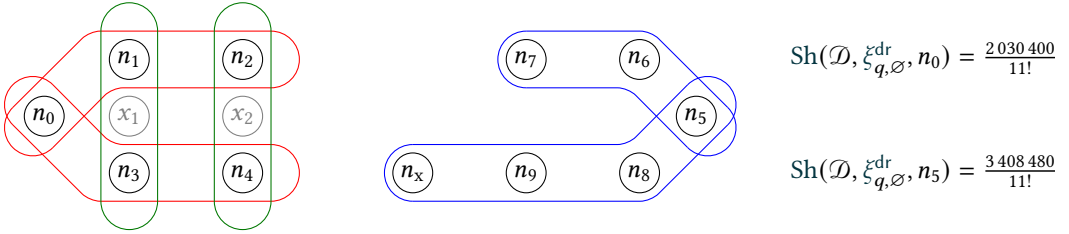

Fig. 2. Instance for Example 4.1.  $\mathcal{D}_n \hat{=} \{n_1, \dots, n_x\}$ ,  $\mathcal{D}_x \hat{=} \{x_1, x_2\}$ , and the query  $q$  is such that the minimal supports are the colored regions (the red ones contain  $e_0$ , the blue ones  $e_5$  and the green ones neither).

appears in a single minimal support ( $\{e_5, e_6\}$ ) while  $e_7$  appears in two ( $\{e_7, e_8\}$  and  $\{e_7, e_9\}$ ). This suggests the following more general property:

(MS2) AOTBE, a fact that appears in more minimal supports should have higher responsibility.

The axioms (MS1) and (MS2) have been stated informally. While mathematically precise formulations can be achieved and can be found in Appendix B.1, they turn out to be quite technical as the notion of “AOTBE” is non-trivial to formalize. For instance, the most naïve definitions will fail to predict the behavior of the drastic Shapley value on the following example.

*Example 4.1.* Consider the instance depicted in Figure 2. Fact  $n_0$  appears in two minimal supports of size 3 (in red) while  $n_5$  appears in one of size 3 and one of size 4 (in blue). However, the situation isn’t entirely symmetrical between  $n_0$  and  $n_5$  because the minimal supports that contain neither of them (in green) interfere with  $n_0$  only. As it turns out, the drastic Shapley value will consider that this difference is sufficient to attribute a smaller value to  $n_0$ . Note that if one were to remove  $x_1$  and  $x_2$ , the green minimal supports would disappear and  $n_0$  would get the highest value. This may be unexpected to a non-expert end user, since these two facts don’t share any minimal support with either  $n_0$  nor  $n_5$ .  $\triangle$

In order to obtain a concrete criterion that is not too complex, we shall focus on a particular class of scenarios – depicted in Figure 3 – in which there are no non-trivial interactions between the minimal supports. The fact that any two minimal supports may only intersect on  $\{\alpha\}$  or  $\{\beta\}$  prevents such unwanted interactions, while the condition that  $|A_i| \leq |B_i|$  for all  $i$  ensures a loose domination of  $\alpha$  over  $\beta$ . By requiring that this domination is strict in some sense, we finally obtain the following necessary condition for a responsibility measure  $\phi$ . Note that although this condition may seem very specific, it already suffices to cover the cases in Figure 1.

(MStest) Let  $A_1, \dots, A_k, B_1, \dots, B_l$  be sets of facts, with  $k \geq l$ , such that for all  $i, j$   $A_i \cap B_j = \emptyset$ , for all  $i, j$  with  $i \neq j$   $A_i \cap A_j = \{\alpha\}$ ,  $B_i \cap B_j = \{\beta\}$  and  $|A_i| \leq |B_i|$ . Consider an instance on the



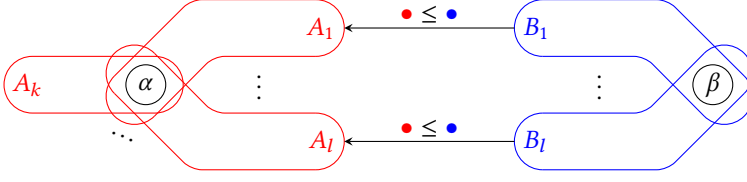

Fig. 3. A visual representation of the setting considered by (MSStest). The  $A_i, B_j$  are the minimal supports of  $q$ .

input database  $\mathcal{D} = A_1 \cup \dots \cup A_k \cup B_1 \cup \dots \cup B_l$  where  $q$  is such that the minimal supports are the  $A_i$  and  $B_j$ . If furthermore  $k > l$  or  $\exists i. |A_i| < |B_i|$ , then  $\phi(\mathcal{D}, q, \alpha) > \phi(\mathcal{D}, q, \beta)$ .

## 4.2 Weighted Sums of Minimal Supports

Given that minimal supports are central to (MS1), (MS2) and also (Null-db), it seems natural to employ this notion directly in the definition of responsibility measures. We shall thus introduce the *weighted sum of minimal supports* (or *WSMS*), as the quantitative responsibility measure

$$\phi_{\text{wsms}}^w(\mathcal{D}, q, \alpha) \doteq \sum_{\substack{S \in \text{MS}_q(\mathcal{D}) \\ \alpha \in S}} w(|S|, |\mathcal{D}|) \quad \text{if } \mathcal{D}_x \not\models q, \text{ or } 0 \text{ otherwise} \quad (3)$$

for some *weight function*  $w : \mathbb{N} \times \mathbb{N} \rightarrow \mathbb{R}$ . We say that  $w$  is a *tractable weight function* if it can further be computed in polynomial time. Note the special case for  $\mathcal{D}_x \models q$ , like the one for  $\Xi^{\text{dr}}$ .

**PROPOSITION 4.2.** *If  $w$  is positive and strictly decreasing (i.e., such that  $k < l \Rightarrow w(k, n) > w(l, n)$  for every  $n$ ), then  $\phi_{\text{wsms}}^w$  satisfies (Sym-db), (Null-db) and (MSStest). Further, any drastic Shapley-like score with positive coefficient function satisfies these axioms as well.*<sup>8</sup>

Arguably the most natural positive and strictly decreasing function is the *inverse weight function*  $\text{inv}_w : k, s \mapsto 1/k$ . As Proposition 4.3 shows,  $\phi_{\text{wsms}}^{\text{inv}_w}$  coincides with the Shapley value of the wealth function family  $\Xi^{\text{ms}}$ , defined by  $\xi_{q, \mathcal{D}_x}^{\text{ms}}(\mathcal{D}_n) = \sum_{S \in \text{MS}_q(\mathcal{D}_n \uplus \mathcal{D}_x)} \frac{|S \cap \mathcal{D}_n|}{|S|}$  if  $\mathcal{D}_x \not\models q$ , and 0 otherwise. In the non-trivial case where  $\mathcal{D}_x \models q$ , a minimal support  $S \subseteq \mathcal{D}_n$  contributes 1 to the total, while a minimal support that is, say,  $1/3$  exogenous, only contributes  $2/3$ . On purely endogenous databases, the formula therefore simplifies to  $\xi_{q, \emptyset}^{\text{ms}}(\mathcal{D}_n) = |\text{MS}_q(\mathcal{D}_n)|$ . Intuitively, this measure considers that the fact that  $\mathcal{D} \models q$  is more robust the more minimal supports for  $q$  can be found in  $\mathcal{D}$ . A similar idea underlies the so-called *MI inconsistency measure* [15] (see Section 7 for more details).

**PROPOSITION 4.3.** *The MS Shapley value, that is, the Shapley value of  $\Xi^{\text{ms}}$ , satisfies the formula:*

$$\text{Sh}(\mathcal{D}_n, \xi_{q, \mathcal{D}_x}^{\text{ms}}, \alpha) = \phi_{\text{wsms}}^{\text{inv}_w}(\mathcal{D}, q, \alpha) = \sum_{\substack{S \in \text{MS}_q(\mathcal{D}) \\ \alpha \in S}} \frac{1}{|S|} \quad \text{if } \mathcal{D}_x \not\models q, \text{ or } 0 \text{ otherwise.}$$

**PROOF.** Consider a query  $q$  and a partitioned database  $\mathcal{D} \doteq \mathcal{D}_n \uplus \mathcal{D}_x$ . For every  $S \in \text{MS}_q(\mathcal{D})$  define the query  $q|_S$  whose only minimal support is  $S$ , that is  $B \models q|_S$  iff  $S \subseteq B$ . It can be easily seen that  $\xi_{q, \mathcal{D}_x}^{\text{ms}}$  on  $\mathcal{D}$  can be expressed as  $\xi_{q, \mathcal{D}_x}^{\text{ms}} = \sum_{S \in \text{MS}_q(\mathcal{D})} \xi_{q|_S, \mathcal{D}_x}^{\text{ms}}$  if  $\mathcal{D}_x \not\models q$ , 0 otherwise.

Since the other case is trivial, assume  $\mathcal{D}_x \not\models q$  and consider some  $S \in \text{MS}_q(\mathcal{D})$ . By (Null),  $\text{Sh}(\mathcal{D}_n, \xi_{q|_S, \mathcal{D}_x}^{\text{ms}}, \alpha) = 0$  for any endogenous fact  $\alpha$  outside  $S$ . By (Sym), the remaining endogenous facts (i.e. the elements of  $S \cap \mathcal{D}_n$ ) must all have the same value, and their sum is fixed to  $\frac{|S \cap \mathcal{D}_n|}{|S|}$

<sup>8</sup>All these measures also satisfy (the formal versions of) (MS1) and (MS2) by Propositions B.1 and B.2 in the appendix.

by (Eff) (recall we assume  $\mathcal{D}_x \not\models q$ ). Overall this means that  $\text{Sh}(\mathcal{D}_n, \xi_{q|S, \mathcal{D}_x}^{\text{ms}}, \alpha) = 1/|S|$  if  $\alpha \in S$  and 0 otherwise. Note that, so long as  $\mathcal{D}_x \not\models q$ , this value isn't affected by the distribution of exogenous facts. Finally by (Lin) we can sum the contributions of all subgames to get the desired formula.  $\square$

Proposition 4.3 is essentially the result [15, Proposition 8], which solely relies on the Shapley axioms (Sym)–(Eff). We believe this is evidence that these axioms make more sense for WSMSs. In particular, the axiom (Lin), when instantiated with  $\Xi^{\text{ms}}$ , implies “if  $\text{MS}_{q_1}(\mathcal{D}) \cap \text{MS}_{q_2}(\mathcal{D}) = \emptyset$ , then  $\phi(\mathcal{D}, q_1, \alpha) + \phi(\mathcal{D}, q_2, \alpha) = \phi(\mathcal{D}, q_1 \wedge q_2, \alpha)$  for all  $\alpha$ ”. This property is key to Proposition 4.3 and further to the efficient computation of the MS Shapley value (see Sections 5 and 6), whereas the instantiation of (Lin) by  $\Xi^{\text{dr}}$  yields a nonsensical statement.

The first observation that can be made regarding  $\phi_{\text{wsms}}^{\text{invw}}$  in contrast with the drastic Shapley value is the fact that only the latter is affected by the way minimal supports may intersect. As such,  $\phi_{\text{wsms}}^{\text{invw}}$  will ignore the “green” minimal supports in Example 4.1 and attribute a greater value to  $e_0$ . In short the drastic Shapley value considers the interactions between all minimal supports, while WSMSs don't. We find no conceptual reason to argue that one approach gives better explanations than the other. However, we can say that the explanations given by  $\phi_{\text{wsms}}^{\text{invw}}$  are *simpler*, both conceptually (it is a straightforward average) and computationally (intuitively, even when the number of minimal supports is manageable, considering all their possible interactions can be costly).

### 4.3 WSMSs are Shapley-like Scores

In Section 3, we insisted on the term “drastic Shapley value”, which is simply called “Shapley value” in the database literature [3, 20]. This is because, as we have seen, the Shapley value proper isn't a quantitative measure, but rather a family of measures parameterized by a wealth function family  $\Xi$ . Moreover, while  $\Xi^{\text{dr}}$  is a very natural choice, it is not the only reasonable wealth function family one can define for non-numeric queries. Indeed, Proposition 4.3 shows that instantiating the Shapley value using  $\Xi^{\text{ms}}$  yields the intuitive measure  $\phi_{\text{wsms}}^{\text{invw}}$ . Interestingly, we can generalize the latter result to show that *every* WSMS is actually a Shapley value in disguise:

**PROPOSITION 4.4.** *For every WSMS  $\phi_{\text{wsms}}^w$  and every Shapley-like score  $\mathcal{S}_c$  whose coefficient function  $c$  is positive on all inputs, there exists a family  $\Xi \triangleq (\xi_{q, \mathcal{D}_x})$  such that for every query  $q$ , database  $\mathcal{D}$  and  $\alpha \in \mathcal{D}$ ,  $\phi_{\text{wsms}}^w(\mathcal{D}, q, \alpha) = \mathcal{S}_c(\mathcal{D}_n, \xi_{q, \mathcal{D}_x}, \alpha)$ .*

In light of the previous proposition, given a WSMS  $\phi_{\text{wsms}}^w$ , we shall denote by  $\Xi^w$  the wealth function family such that  $\phi_{\text{wsms}}^w(\alpha) = \text{Sh}(\mathcal{D}_n, \xi_{q, \mathcal{D}_x}^w, \alpha)$  and  $\text{SVC}_c^w$  the associated computational problem. We henceforth abandon the notation  $\phi_{\text{wsms}}^w$  in favor of the Shapley-based alternative.

### 4.4 Other Notable WSMSs

By its very nature, the drastic Shapley value gives a lot of importance to small minimal supports, to the point where a fact  $\alpha$  such that  $\{\alpha\} \models q$  will always receive a maximal drastic Shapley value [3, Lemma 6.3]. This is not the case of the MS Shapley value, which will favor three minimal supports of size 2 against one singleton support. It is however possible to choose a positive and strictly decreasing WSMS such that smaller minimal supports will always dominate.

**PROPOSITION 4.5.** *Define the weight function  $w_s(k, n) \triangleq 2^{-kn}$  and denote  $\Xi^s = \Xi^{w_s}$  for short. The function  $w_s$  is tractable, positive and strictly decreasing, and if  $\alpha, \beta \in \mathcal{D}_n$  are such that the smallest minimal support containing  $\alpha$  is smaller than the smallest minimal support containing  $\beta$ , then  $\text{Sh}(\mathcal{D}_n, \xi_{q, \mathcal{D}_x}^s, \alpha) > \text{Sh}(\mathcal{D}_n, \xi_{q, \mathcal{D}_x}^s, \beta)$ , unless  $\mathcal{D}_x \models q$ .*

PROOF SKETCH. The binary representation of  $\text{Sh}(\mathcal{D}_n, \xi_{q, \mathcal{D}_x}^s, \alpha)$  will essentially encode the vector of numbers of minimal supports for  $q$  that contain  $\alpha$ , grouped by increasing size.<sup>9</sup>  $\square$

Alternatively, one can also decide that the number of minimal supports should be the main factor for the responsibility measure.

PROPOSITION 4.6. *Define the weight function  $w_{\#}(k, n) \hat{=} 1 + w_s(k, n)$  and denote  $\Xi^{\#} = \Xi^{w_{\#}}$  for short.  $w_{\#}$  is tractable, positive and strictly decreasing, and if  $\alpha, \beta \in \mathcal{D}_n$  are such that  $\alpha$  appears in more minimal supports than  $\beta$ , then  $\text{Sh}(\mathcal{D}_n, \xi_{q, \mathcal{D}_x}^{\#}, \alpha) > \text{Sh}(\mathcal{D}_n, \xi_{q, \mathcal{D}_x}^{\#}, \beta)$ , unless  $\mathcal{D}_x \models q$ .*

PROOF SKETCH.  $\left[ \text{Sh}(\mathcal{D}_n, \xi_{q, \mathcal{D}_x}^{\#}, \alpha) \right]$  equals the number of minimal supports that contain  $\alpha$ .  $\square$

## 5 Data Complexity

We shall now investigate the complexity of computing weighted sums of minimal supports, i.e., computing  $\text{SVC}_{\mathcal{C}}^w$  for weight functions  $w$ . We start with the *data complexity*, i.e., the complexity of  $\text{SVC}_q^w$  for individual queries  $q$ , independently of their representation.

The simplicity of Equation (3) defining WSMSs not only makes these measures easier to interpret, but also easier to compute in many cases. Essentially, this is because the problem boils down to counting the minimal supports of every size. This straightforward reduction is formalized in the following lemma, which makes use of the aggregate query  $\#_q^{\text{fms}}$  that, given a number  $k$  and database  $\mathcal{D}$ , computes the number of minimal supports of  $q$  in  $\mathcal{D}$  having exactly  $k$  facts (fms stands for fixed-size ms, in line with ‘fixed-size model counting’ [16, §3]). For a class  $\mathcal{C}$  of Boolean queries, we use  $\text{EVAL-}\#_{\mathcal{C}}^{\text{fms}}$  for the problem of, given a query  $q \in \mathcal{C}$ , a number  $k$  and a database  $\mathcal{D}$ , evaluating  $\#_q^{\text{fms}}$  on  $k, \mathcal{D}$ . If  $\mathcal{C}$  contains a single query  $q$ , we simply write  $\text{EVAL-}\#_q^{\text{fms}}$ .

LEMMA 5.1. *For a tractable weight function  $w$  and Boolean monotone query  $q$ ,  $\text{SVC}_q^w \leq_{\text{poly}} \text{EVAL-}\#_q^{\text{fms}}$ .*

With Lemma 5.1, we can effectively compute  $\text{SVC}_q^w$  for every query whose minimal supports can be enumerated in polynomial time, which includes UCQs or more generally bounded queries.

THEOREM 5.2.  *$\text{SVC}_q^w \in \text{FP}$  for every tractable weight function  $w$  and every Boolean monotone query  $q$  that is bounded and can be evaluated in polynomial time.*

PROOF. By definition, the minimal supports for  $q$  are bounded by some constant  $M$ , so one can simply enumerate all subsets of  $\mathcal{D}$  of size at most  $M$ , and check which ones are minimal supports in order to compute  $\#_q^{\text{fms}}(k, \mathcal{D})$  for every  $k$ , and finally apply Lemma 5.1.  $\square$

Observe that enumerating minimal supports is a somewhat brutal approach to evaluating  $\#_q^{\text{fms}}(k, \mathcal{D})$ . As exemplified by the following proposition, in some cases counting may be tractable even when the exponential number of minimal supports makes their enumeration intractable.

PROPOSITION 5.3. *Let  $w$  be a tractable weight function and  $q$  a regular path query. Then,  $\text{SVC}_q^w$  restricted to acyclic graph databases (i.e., only binary relations and no directed cycles) is in FP.*

PROOF SKETCH. When  $\mathcal{D}$  is acyclic, the number of paths of any given size from  $c$  to  $d$  that are labelled by a word in  $\mathcal{L}$  can be computed in polynomial time by dynamic programming.  $\square$

On arbitrary graphs containing cycles, deciding whether an edge lies on a simple path is already a known NP-complete problem [10], so no measure that satisfies (Null-db) will be in FP for RPQs, unless  $\text{P} = \text{NP}$ . In fact, we now prove a FP/#P-hard dichotomy (Theorem 5.6) which shows that, for a wide class of WSMSs, their computation is #P-hard for (almost) any unbounded RPQ.

<sup>9</sup>For simplicity this  $w_s$  allocates  $n = |\mathcal{D}|$  bits to every possible size, but this can obviously be optimized.

Before we prove this dichotomy, we need to show a lower-bound equivalent of Lemma 5.1. We say a weight function  $w$  is *reversible* if the total number of minimal supports for any  $q$  in any database  $\mathcal{D}$  can be computed in polynomial time given access to an oracle for  $\text{Sh}(\mathcal{D}, \xi_{q, \emptyset}^w, \alpha)$ , for all  $\alpha \in \mathcal{D}$ .<sup>10</sup> We shall abuse terminology and say the family  $\Xi^w$  itself is reversible when  $w$  is.

*Remark 5.4.* The three families  $\Xi^{\text{ms}}$ ,  $\Xi^s$  and  $\Xi^\#$  considered thus far are all reversible.

The next lemma shows how the problem  $\text{EVAL-}\#_q^{\text{ms}}$  of evaluating  $\#_q^{\text{ms}}$ , i.e., counting, for the given database  $\mathcal{D}$ , the *total* number of minimal supports of  $q$  in  $\mathcal{D}$ , can yield lower bounds for  $\text{SVC}_q^w$ .

LEMMA 5.5. *For a reversible weight function  $w$  and Boolean monotone query  $q$ ,  $\text{EVAL-}\#_q^{\text{ms}} \leq_{\text{poly}} \text{SVC}_q^w$ .*

We now give the announced dichotomy for RPQs, whose proof relies upon Lemmas 5.1 and 5.5.

THEOREM 5.6. *Let  $w$  be a reversible tractable weight function, and a regular path query  $q \hat{=} \mathcal{L}(c, d)$ . Then  $\text{SVC}_q^w \in \text{FP}$  if  $\mathcal{L}$  is finite or  $\varepsilon \in \mathcal{L}$  and  $c = d$ , and  $\#\text{P}$ -hard otherwise.*

PROOF SKETCH. We reduce from the problem of counting simple paths between two distinguished vertices  $v_s$  and  $v_t$  in a directed graph, using the pumping lemma for regular languages.  $\square$

Note that the proof of Proposition 5.6 fails if we consider existentially quantified RPQs, as discussed in the appendix. However, we have no reason to think that the problem is tractable:

CONJECTURE 5.7. *Let  $w$  be a reversible tractable weight function, and let  $q$  be a homomorphism-closed<sup>11</sup> Boolean query. Then  $\text{SVC}_q^w \in \text{FP}$  if  $q$  is equivalent to a UCQ and  $\#\text{P}$ -hard otherwise.*

## 6 Combined Complexity

We will now study the combined complexity of computing weighted sums of minimal supports.

### 6.1 Arbitrary Query Classes

We first give a general upper bound assuming some minimal conditions, namely that the query evaluation task lies within the polynomial hierarchy and the weight function is tractable.

PROPOSITION 6.1. *Let  $\mathcal{C}$  be a class of Boolean monotone queries for which the (combined) query evaluation is in PH, and  $w$  be a tractable weight function. Then  $\text{SVC}_{\mathcal{C}}^w \in \text{FP}^{\#\text{P}}$ .*

PROOF. With Lemma 5.1 in mind, our first step is to show that  $\#_{\mathcal{C}}^{\text{fms}} \in \#\text{PH}$ , where  $\#\text{PH}$  is the class of all computational problems that can be defined as the number of accepting runs of a polynomial-time nondeterministic Turing machine (PNTM) that has access to a PH oracle [13]. We thus construct a PNTM with PH oracle that, on any input query  $q \in \mathcal{C}$  database  $\mathcal{D}$ , has exactly one accepting run for every minimal support of size  $k$  for  $q$  in  $\mathcal{D}$ . For this, we non-deterministically pick a subset  $S$  of  $\mathcal{D}$  and then use the PH oracle to check if it is a minimal support. Since answering  $q$  is in PH, a first call can decide if  $S \models q$  and a second one that for all  $S' \subseteq S$ ,  $S' \not\models q$ .

Now that we have shown  $\#_{\mathcal{C}}^{\text{fms}} \in \#\text{PH}$ , Lemma 5.5 implies  $\text{SVC}_{\mathcal{C}}^w \in \text{FP}^{\#\text{PH}}$ , and we conclude by the fact that  $\text{FP}^{\#\text{PH}} = \text{FP}^{\#\text{P}}$  [31, Theorem 4.1].  $\square$

<sup>10</sup>Observe that we do not need to compute the number of minimal supports of each size, but only the total number.

<sup>11</sup>A constant-free query  $q$  is *homomorphism-closed* if  $\mathcal{D}' \models q$  whenever  $\mathcal{D} \xrightarrow{\text{hom}} \mathcal{D}'$  and  $\mathcal{D} \models q$ , where  $\mathcal{D} \xrightarrow{\text{hom}} \mathcal{D}'$  is defined similarly to query homomorphisms but without condition (ii). For queries with constants, we must use the more general notion of  $C$ -homomorphism that fixes a set  $C$  of constants to ensure that the query constants are preserved [3].

## 6.2 (Acyclic) Conjunctive Queries

We will now provide a more detailed analysis for CQs, which will exploit connections to the related problem of counting query homomorphisms. To this end, we define  $\#_q^{\text{hom}}$  as the query which counts the number of homomorphisms  $q \xrightarrow{\text{hom}} \mathcal{D}$  and use  $\text{EVAL-}\#_{\mathcal{C}}^{\text{hom}}$  to refer to the associated evaluation problem for a given class  $\mathcal{C}$  of CQs. We observe that for every CQ  $q$  and database  $\mathcal{D}$ , each homomorphism  $h : q \xrightarrow{\text{hom}} \mathcal{D}$  *induces* the support  $\{h(\alpha) : \alpha \text{ atom of } q\}$ , hence  $\#_q^{\text{ms}}(\mathcal{D}) \leq \#_q^{\text{hom}}(\mathcal{D})$ . However, as the next example illustrates, counting homomorphisms is not quite the same as counting minimal supports:

*Example 6.2.* Consider the CQ  $\exists xyzw R(x, y) \wedge R(y, z) \wedge R(z, w)$  and the database  $\mathcal{D} = \{R(a, b), R(b, c), R(c, a)\}$ . While the query has only one (minimal) support (i.e.,  $\mathcal{D}$  itself), it has three different homomorphisms characterized by their values on  $x, y, z, w$ :  $\{(a, b, c, a), (b, c, a, b), (c, a, b, c)\}$ .  $\triangle$

It is known that counting homomorphisms from CQs (or, equivalently, counting the answers to non-Boolean CQs without any existential variable) is #P-complete in general [9, Theorem 1.1], but it becomes tractable for ACQs [25, Theorem 1] and more generally for classes of CQs having bounded ‘generalized hypertree width’ [25, Theorem 7]. Interestingly, we show here that these tractability results do not generalize to counting minimal supports. In fact, we prove that counting minimal supports for ACQs is #P-hard even in the absence of constants and over a fixed schema.

**THEOREM 6.3.**  *$\text{EVAL-}\#_{\text{ACQ}}^{\text{ms}}$  is #P-hard under polynomial-time 1-Turing reductions<sup>12</sup>, even in the absence of constants. Hence,  $\text{EVAL-}\#_{\text{ACQ}}^{\text{ms}}$  is #P-hard under polynomial-time Turing reductions.*

**PROOF.** We reduce from the *perfect matching counting* problem, which is the problem of, given a bipartite graph  $G = (V, E)$ , counting the number of subsets  $M \subseteq E$  (called *perfect matchings*) such that each vertex of  $V$  is contained in exactly one edge of  $M$ . This problem is known to be #P-complete [32, Problem 2] under polynomial-time Turing reductions, and was later shown to be hard even under polynomial-time 1-Turing reductions [33].

Suppose  $V$  is partitioned into  $V_1 \cup V_2$  and assume  $V_1 = \{a_1, \dots, a_n\}$ ,  $V_2 = \{b_1, \dots, b_n\}$  and denote  $I = \{1, \dots, n\}$  (observe that if  $|V_1| \neq |V_2|$  there are no perfect matchings). We will build a database  $D_G$  and a constant-free ACQ  $q_G$  such that the number of perfect matchings on  $G$  is equal to  $\#_{q_G}^{\text{ms}}(D_G) - n$ . For clarity, we first show a reduction which uses an unbounded relational schema  $\sigma_G = \{R_1, \dots, R_n\}$  where each  $R_i$  is binary.

$D_G$  We shall abuse notation and use the elements of  $V_1 \cup V_2$  as constant names. The database  $D_G$  is built over the domain  $V_1 \cup V_2 \cup \{c_{i,v,v'} \mid i \in [n-1], v, v' \in V_1 \cup V_2\}$ . The  $c$ -constants are there only to build some paths between the elements of  $V_1 \cup V_2$  reading ‘ $R_1 \dots R_n$ ’ or ‘ $R_n \dots R_1$ ’. Figure 4 contains an example from which the reader can deduce how  $D_G$  is defined (the  $c$ -constants are implicit in the figure). More formally, we define  $D_G$  as the smallest set containing:

- All facts  $R_1(v, v), \dots, R_n(v, v)$  for every  $v \in V_2$ .
- A path reading  $R_n, R_{n-1}, \dots, R_1$  from  $a_i$  to  $a_{i+1}$  for every  $i$  –formally, all facts  $R_n(a_i, c_{1,a_i,a_{i+1}}), R_{n-1}(c_{1,a_i,a_{i+1}}, c_{2,a_i,a_{i+1}}), \dots, R_1(c_{n-1,a_i,a_{i+1}}, a_{i+1})$  for every  $i \in [n-1]$ .
- A path reading  $R_1, R_2, \dots, R_n$  between any  $a_i$  and  $b_j$  connected by an edge in  $G$  –formally, all facts  $R_1(a_i, c_{1,a_i,b_j}), R_2(c_{1,a_i,b_j}, c_{2,a_i,b_j}), \dots, R_n(c_{n-1,a_i,b_j}, b_j)$  for every  $\{a_i, b_j\} \in E$ .

$q_G$  The ACQ  $q_G$  is defined as in Figure 4. We give names only to some of the variables of  $q_G$ :  $X = \{x_1, \dots, x_n\}$  which will be mapped to the  $a_i$ ’s, and  $Y = \{y_1, \dots, y_n\}$  which will be mapped to the  $b_i$ ’s. All others will be mapped to intermediate constants along paths in  $\mathcal{D}_G$ .

<sup>12</sup>That is, Turing reductions that only allow a single call to an oracle.

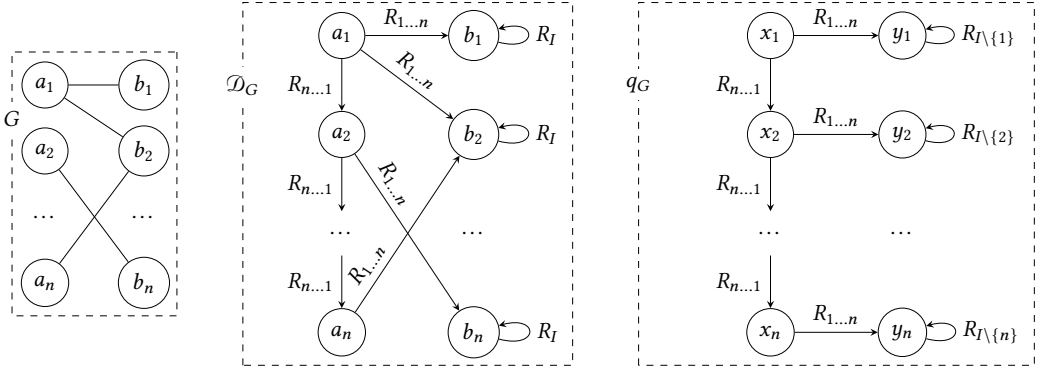

Fig. 4. Construction for the reduction in the proof of Theorem 6.3.  $\xrightarrow{R_{1\dots n}}$  (resp.  $\xrightarrow{R_{n\dots 1}}$ ) is an abbreviation for the path  $\xrightarrow{R_1} \dots \xrightarrow{R_n}$  (resp.  $\xrightarrow{R_n} \dots \xrightarrow{R_1}$ ), and  $\xrightarrow{R_j}$  means a parallel edge for every  $j \in J$ .

It is easy to see that the  $\mathcal{S}_j \hat{=} R_I(b_j, b_j)$  (i.e.  $R_1(b_j, b_j), \dots, R_n(b_j, b_j)$ ) are all minimal supports for  $q_G$  in  $\mathcal{D}_G$ . Similarly, if we take a perfect matching in  $G$  under the form of a bijective  $\mu : V_1 \rightarrow V_2$  s.t.  $\forall j \in I. (a_j, \mu(a_j)) \in E$ , then we can easily build a minimal support for  $q_G$  by taking an isomorphic image of  $q_G$  with  $(x_j, y_j) \mapsto (a_j, \mu(a_j))$ . We now show that there is no minimal support for  $q_G$  in  $\mathcal{D}_G$  other than these.

Assume that  $\mathcal{S}$  is a minimal support for  $q_G$  in  $\mathcal{D}_G$  that doesn't contain any  $\mathcal{S}_j$ . Since  $\mathcal{S} \models q$ , then  $\mathcal{S}$  must be the homomorphic image of  $q_G$  by some homomorphism  $h$ . First consider the spine  $x_1 \xrightarrow{R_{n\dots 1}} \dots \xrightarrow{R_{n\dots 1}} x_n$  of  $q_G$ . It must necessarily map to  $a_1 \xrightarrow{R_{n\dots 1}} a_n$  because that is the only path in  $\mathcal{D}_G$  that doesn't contain any  $\mathcal{S}_j$  and is homomorphic to  $x_1 \xrightarrow{R_{n\dots 1}} \dots \xrightarrow{R_{n\dots 1}} x_n$ . In other words  $\forall j \in I. h(x_j) = a_j$ .

Now consider a branch  $x_i \xrightarrow{R_{1\dots n}} y_i$  of  $q_G$ . Since  $h(x_i) = a_i$  and  $x_i$  has at most two outgoing edge, only one of which is a  $R_1$ , the branch must necessarily map to some  $a_i \xrightarrow{R_{1\dots n}} b_j$ , with  $(a_i, b_j) \in E$ . In other words,  $h(y_j)$  is always a neighbour of  $a_j$  in  $G$ . Moreover, if we were to have  $h(y_i) = h(y_{i'}) = b_j$  with  $i \neq i'$ , then  $\mathcal{S}$  would necessarily contain  $R_{I \setminus \{i\}}(b_j, b_j) \cup R_{I \setminus \{i'\}}(b_j, b_j) = \mathcal{S}_j$ , which is impossible. Overall,  $\mathcal{S}$  must therefore induce a **perfect matching** as described above, with  $\mu(a_j) \hat{=} h(y_j)$ .

One shortcoming of the reduction above is that we have used a **schema** which depends on the problem instance. However, this was done for the sake of clarity of exposition, and we show how to modify the reduction above to use a **bounded schema**  $\sigma = \{S, T, R\}$ , where  $S$  is unary and  $T, R$  are binary. For this, we replace everywhere (in the query and in the database) each appearance of  $R_i(t, t')$  with a path from  $t$  to  $t'$  reading  $TR^i$  (by using fresh  $i$  new constants or variables). The proof follows the same lines.  $\square$

**COROLLARY 6.4.**  $\text{SVC}_{\text{ACQ}}^w$  is #P-hard for any reversible weight function  $w$ . In particular for  $\text{SVC}_{\text{ACQ}}^{ms}$ .

**PROOF.** This is a direct consequence of Lemma 5.5, Theorem 6.3, and Remark 5.4.  $\square$

### 6.3 Conjunctive Queries with Bounded Self-joins

In order to identify some tractable cases, we will turn our attention to the class **sjf-CQ** of *self-join free* CQs, which contains CQs which do not contain two distinct atoms with the same relation name. The interest of this class lies in the fact that for **self-join free** CQs, the number of minimal supports always coincides with the number of homomorphisms:

*Remark 6.5.* For every self-join free CQ  $q$  and database  $\mathcal{D}$ ,  $\#_q^{\text{hom}}(\mathcal{D}) = \#_q^{\text{ms}}(\mathcal{D}) = \#_q^{\text{fms}}(k, \mathcal{D})$ , where  $k = |\text{atoms}(q)|$  (in particular,  $\#_q^{\text{fms}}(k', \mathcal{D}) = 0$  for any  $k' \neq k$ ).

As a corollary, we have that  $\text{EVAL-}\#_{\text{sjf-ACQ}}^{\text{fms}}$  is tractable for the class **sjf-ACQ** of acyclic self-join free CQs since it is tractable for  $\text{EVAL-}\#_{\text{sjf-ACQ}}^{\text{hom}}$  [25, Theorem 1]. This means that we can reuse the efficient divide-and-conquer algorithms exploiting the tree-like structure of queries that have been previously devised for counting homomorphisms.

In the presence of self-joins, we know from Theorem 6.3 that the problem remains  $\#P$ -hard, but the proof uses an *unbounded* number of self-joins, raising the obvious question of what happens if the number of self-joins is bounded. We shall now show a positive result, namely, that counting minimal supports is in polynomial time if we simultaneously bound the number of self-joins and restrict to acyclic or more generally tree-like conjunctive queries. The measure of “tree-like” which we will use here is that of *generalized hypertree width*, which we will not define here but can be found, e.g., in [11, Definition 3.1]. ACQs correspond to CQs of generalized hypertree width 1.

Two distinct atoms  $\alpha, \beta$  of a CQ  $q$  are *mergeable* if there are two homomorphisms  $h_\alpha : \alpha \xrightarrow{\text{hom}} \mathcal{D}$ ,  $h_\beta : \beta \xrightarrow{\text{hom}} \mathcal{D}$  to an arbitrary database  $\mathcal{D}$  such that  $h_\alpha(\alpha) = h_\beta(\beta)$  (in particular they must have the same relation name). An atom  $\alpha$  is (individually) mergeable if it is mergeable with some other atom in  $q$ . The *self-join width* of a CQ  $q$  is the size of

$$\mathbf{M}_q \triangleq \{t \in \text{terms}(\alpha) : \alpha \text{ is a mergeable atom of } q\}.$$

In particular, self-join free queries have self-join width 0. Note that a CQ like  $q \triangleq \exists xyR(c, x) \wedge R(c', y)$ , where  $c, c'$  are distinct constants, also has self-join width 0 since it has no two mergeable atoms. Also observe that in the absence of mergeable atoms, each minimal support corresponds to a distinct homomorphism, and each homomorphism gives rise to a distinct minimal support.

**THEOREM 6.6.** *For any class  $\mathcal{C}$  of CQs having bounded generalized hypertree width and bounded self-join width,  $\text{EVAL-}\#_{\mathcal{C}}^{\text{fms}}$  and  $\text{EVAL-}\#_{\mathcal{C}}^{\text{ms}}$  are in polynomial time.<sup>13</sup>*

**PROOF SKETCH.** We will use CQs with equality and/or disequality atoms denoted by  $\text{CQ}^{\neq}, \text{CQ}^{\neq,=}, \text{CQ}^{\neq, \neq}$ , where the notions of homomorphisms from such queries to databases is restricted accordingly. Observe that any equality atom  $x = t$  can always be removed by replacing every occurrence of  $x$  with  $t$  (or removing the equality if  $t = x$ ). We write  $\widehat{q}$  to denote the canonical<sup>14</sup> equivalent  $\text{CQ}^{\neq}$  (resp. CQ) query resulting from applying the preceding simplifications, for any  $\text{CQ}^{\neq,=}$  (resp.  $\text{CQ}^{\neq, \neq}$ )  $q$ .

Let  $q$  be a CQ from  $\mathcal{C}$ . Consider  $\mathcal{E}$  to be the set of all *equivalence relations* over  $\mathbf{M}_q$  (i.e., relations  $E \subseteq \mathbf{M}_q \times \mathbf{M}_q$  being reflexive, symmetric and transitive) not containing any pair  $(c, c')$  of distinct constants. For any  $E \in \mathcal{E}$ , define  $q_E \in \text{CQ}$  as  $\text{core}(\widehat{p})$ , where  $p \in \text{CQ}^{\neq}$  is defined as the result of adding to the query  $q$  the equality atoms  $t = t'$  for every  $(t, t') \in E$ . Let  $q_E^{\neq} \in \text{CQ}^{\neq}$  be  $q_E$  with some added disequality atoms  $t \neq t'$  for  $t, t' \in \text{terms}(q_E)$  such that  $(t, t') \in (\mathbf{M}_q \times \mathbf{M}_q) \setminus E$ . Let  $\mathbf{P}_q \triangleq \{q_E : E \in \mathcal{E} \text{ s.t. } q_{E'}^{\neq} \xrightarrow{\text{hom}} q_E^{\neq} \text{ implies } q_E^{\neq} \xrightarrow{\text{hom}} q_{E'}^{\neq}, \text{ for all } E' \in \mathcal{E}\}$ .

The proof of the statement can be shown by establishing the following facts:

- (1) If a homomorphism  $h : q_E^{\neq} \xrightarrow{\text{hom}} \mathcal{D}$  induces  $S$ , then  $|S|$  is the number of atoms of  $q_E$ .
- (2)  $\mathbf{P}_q$  can be computed in polynomial time.
- (3) The set of minimal supports of  $q$  on  $\mathcal{D}$  is partitioned into

$$\{S \subseteq \mathcal{D} : S \text{ is induced by a homomorphism } q_E^{\neq} \xrightarrow{\text{hom}} \mathcal{D}\}_{q_E \in \mathbf{P}_q}.$$

<sup>13</sup>We understand this statement as a “promise problem”, that is, the input to the evaluation problem is a query from  $\mathcal{C}$ , as opposed to some arbitrary string.

<sup>14</sup>Canonical in the sense of unique up to variable renaming.

(4) For every  $q_E \in P_q$  and database  $\mathcal{D}$ , we have

$$\#_{q_E}^{\text{hom}}(\mathcal{D}) = |\text{Aut}(q_E^\#)| \cdot |\{S : S \text{ induced by homomorphism } q_E^\# \xrightarrow{\text{hom}} \mathcal{D}\}|$$

where  $\text{Aut}(q_E^\#)$  is the set of automorphisms  $q_E^\# \xrightarrow{\text{hom}} q_E^\#$ .

(5)  $|\text{Aut}(q_E^\#)|$  and  $\#_{q_E}^{\text{hom}}(\mathcal{D})$  can be computed in polynomial time.

Hence, for every fixed  $k$ ,  $\#_q^{\text{fms}}(k, \mathcal{D})$  can be computed in polynomial time: it suffices to compute, in polynomial time,  $\sum_{q_E \in P_k} (\#_{q_E}^{\text{hom}}(\mathcal{D}) / |\text{Aut}(q_E^\#)|)$  for the set  $P_k \subseteq P_q$  of queries having  $k$  atoms.  $\square$

## 7 Related Measures

We review some measures known in the literature and compare them with the WSMS family.

### 7.1 Shapley Value of Inconsistency Measures

As discussed earlier, the drastic and the MS Shapley values are analogues to previously studied inconsistency measures [15, 21]. Livshits and Kimelfeld [21] have considered three further inconsistency measures, denoted by  $I_P$ ,  $I_{MC}$  and  $I_R$  respectively, defined in the absence of exogenous atoms. The first two translate into the following families of wealth functions:

- $\Xi^P$  is the analogue of  $I_P$ :  $\xi_{q, \emptyset}^P(S)$  is the number of facts that are relevant to  $q$  in  $S$ .
- $\Xi^{MC}$  is the analogue of  $I_{MC}$ :  $\xi_{q, \emptyset}^{MC}(S) = mc(S) + ss(S) - 1$  where  $mc(S)$  is the number of maximal subsets  $\Delta \subseteq S$  s.t.  $\Delta \not\models q$ , and  $ss(S) \triangleq |\{s \in S : \{s\} \models q\}|$ .<sup>15</sup>

We did not extend these definitions to add exogenous facts, because the following result proves that they are not suitable responsibility measures using our criteria, even without them.

**PROPOSITION 7.1.** *The Shapley values of  $\Xi^P$  and  $\Xi^{MC}$  don't satisfy (MStest), even assuming  $\mathcal{D}_x = \emptyset$ .*

**PROOF.** The Shapley value of  $\Xi^P$  attributes the score 1 to all facts in the example depicted in Figure 1-(a) ( $k = l = 1, |A_1| = 1, |B_1| = 2$  with the notations of (MStest)), and the one of  $\Xi^{MC}$  attributes the score  $144/120$  to all facts in the variant defined by  $k = l = 1, |A_1| = 2, |B_1| = 3$ .  $\square$

We do extend the definition of the third to account for  $\mathcal{D}_x$ , in order to prove its suitability.

- $\Xi^R$  is the analogue of  $I_R$ :  $\xi_{q, \mathcal{D}_x}^R(S)$  is the size of the smallest  $\Gamma \subseteq S$  such that  $(S \setminus \Gamma) \cup \mathcal{D}_x \not\models q$ .

**PROPOSITION 7.2.** *The Shapley value of  $\Xi^R$  satisfies (Sym-db), (Null-db) and (MStest).*

These results show that  $\Xi^P$  and  $\Xi^{MC}$  do not yield suitable responsibility measures, but  $\Xi^R$  remains a reasonable option. While we shall leave a more thorough investigation of  $\Xi^R$  to future work (in particular, it remains to determine if the Shapley value of  $\Xi^R$  satisfies (MS1) and (MS2) as formally defined in Appendix B.1), we can already show that it is difficult to compute. Indeed, not only is  $\Xi^R$  intractable in data complexity (due to the similarity with  $\Xi^{\text{dr}}$ ) but it is not even approximable via a fully polynomial randomized approximation scheme (FPRAS).

**PROPOSITION 7.3.** *There exist CQs  $q, q'$  such that  $\text{SVC}_q^R$  is #P-hard and such that  $\text{SVC}_{q'}^R$  possesses no FPRAS unless  $\text{NP} \subseteq \text{BPP}$  nor any multiplicative approximation of factor 1.3606 unless  $\text{P} = \text{NP}$ .*

<sup>15</sup>The definition in [21] is simpler than ours because in their context (functional dependencies), the analogue of such a “singleton support” cannot appear, hence  $ss(S) = 0$ ; the full definition can be found in [12, Definition 2] ( $I_M$  measure).



## 7.2 Counting Homomorphisms of Minimal Supports

A natural idea for an alternative measure for (Boolean) UCQs would be to replace “counting minimal supports” with “counting homomorphisms” in the definition of  $\xi^{\text{ms}}$  to obtain a wealth function family  $\Xi^{\text{hom}}$  based on counting homomorphisms (i.e.,  $\xi_{q, \mathcal{D}_n}^{\text{hom}} \triangleq |\{h : q \xrightarrow{\text{hom}} \mathcal{D}_n\}|$ ). Adopting  $\Xi^{\text{hom}}$  in place of  $\Xi^{\text{ms}}$  would allow us to obtain further tractability results, as we have seen that counting homomorphisms can be computationally simpler than counting minimal supports (Theorem 6.3). Unfortunately, although  $\Xi^{\text{hom}}$  seems reasonable at first sight, we show that it cannot decide relevance, which may be considered a minimum requirement for any responsibility measure:

**PROPOSITION 7.4.** *The Shapley value of  $\Xi^{\text{hom}}$  does not satisfy (Null-db). Moreover, an irrelevant fact may have a larger value than relevant ones by an arbitrarily large (multiplicative or additive) margin.*

**PROOF SKETCH.** Consider the CQ  $q \triangleq \exists xyz R(x, y) \wedge R(y, z)$  and the purely endogenous database  $\mathcal{D} \triangleq \{R(c, c), R(c, d)\}$ . The fact  $R(c, d)$  appears in the assignment  $(c, c, d) \mapsto (x, y, z)$  hence  $\text{Sh}(\mathcal{D}, \xi_{q, \emptyset}^{\text{hom}}, R(c, d)) > 0$ , but it is irrelevant because  $R(c, c)$  satisfies  $q$  on its own. A slight variation of the above instance can get an irrelevant fact to have the highest value by an arbitrary margin.  $\square$

## 7.3 Explainable AI and SHAP Score

The Shapley value has also been applied to define a popular quantitative measure of responsibility for machine learning, namely the SHAP score [22], which we shall briefly define later. Despite its popularity in practice, recent work [23] has cast doubts on the theoretical guarantees this measure provides. Although the context is substantially different from query answering, we discuss it here because we believe the present work can provide valuable insights on the issue.

Consider a *classifier*, which we shall simply model as a function  $\mathcal{M} : \mathbb{B}^{\mathcal{F}} \rightarrow \mathbb{B}$ , where  $\mathcal{F}$  is a finite set of *features* and  $\mathbb{B}$  is the Boolean set  $\{0, 1\}$ .<sup>16</sup> Given an input instance  $\alpha \in \mathbb{B}^{\mathcal{F}}$ , we wish to explain the classification  $\mathcal{M}(\alpha)$  by identifying the most relevant features.

In order to obtain a quantitative score from the Shapley value, one simply needs to define a relevant game whose players are the features in  $\mathcal{F}$ . In the context of query answering, we have seen that one straightforward approach (giving rise to the drastic Shapley value) consists in using the query itself, seen as a 0/1 function over the subsets of the input. But this is not possible for classifiers because  $\mathcal{M}$  needs all the features of its input to have some value. The solution chosen to define the SHAP score consists in taking the average value of  $\mathcal{M}$  across all completions of  $\alpha|_S$  (that is,  $\alpha$  restricted to the features in  $S$ ):  $\xi^{\text{SHAP}}(S) \triangleq \frac{1}{2^{|\mathcal{F} \setminus S|}} \sum_{x \in \mathbb{B}^{\mathcal{F}}, x|_S = \alpha|_S} \mathcal{M}(x)$ . The *SHAP score* is then defined as the Shapley value applied to the game  $(\mathcal{F}, \xi^{\text{SHAP}})$ .

In order to analyse the SHAP score, [23] defines the notion of an *abductive explanation* (AXp for short) as an inclusion-minimal subset  $S \subseteq \mathcal{F}$  such that for all  $x \in \mathbb{B}^{\mathcal{F}}, x|_S = \alpha|_S \Rightarrow \mathcal{M}(x) = \mathcal{M}(\alpha)$ . AXps are precisely analogous to the minimal supports of the database setting, and [23] essentially shows that the SHAP score does not satisfy the analogue of the (Null-db) axiom, which we argued was a very natural condition in our setting.

However, due to the closeness of AXps and minimal supports, one can easily adapt Section 4 of the present paper to define ‘Weighted Sums of AXps’ (*WSAXps*). These quantitative measures, which also derive from the Shapley value, will naturally display all of the good properties of WSMs and therefore make viable candidates for addressing the theoretical drawbacks of the SHAP score. Unfortunately, however, whereas minimal supports can be efficiently counted for relevant classes of database queries, the problem of counting the number of the AXps of each size will be intractable for pretty much any interesting class of classifiers. Moreover, this high complexity is inescapable:

<sup>16</sup>For the sake of simplicity, we only consider Boolean classifiers here.

as deciding feature relevance is NP-hard for very simple classes of classifiers [14, Proposition 11], no measure satisfying the ML analogue of (Null-db) can be tractable.

## 8 Conclusions

We have revisited the question of how the Shapley value can be used to define responsibility measures for non-numeric queries. Our proposed family of responsibility measures – weighted sums of minimal supports (WSMSs) – can be viewed as the Shapley values of suitably defined games and have been shown to satisfy desirable semantic properties. Moreover, due to their simple definition, WSMSs are amenable to interpretation and can be efficiently computed for a large class of queries (including all UCQs), making them an appealing alternative to the drastic Shapley value. We should point out that the two main measures that have been studied in the literature, namely the drastic Shapley value and the *drastic Banzhaf value* (i.e., the Banzhaf power index applied to the drastic wealth function family) both satisfy our new desiderata for responsibility measures. More precisely, they satisfy the axioms (Sym-db), (Null-db) and (MStest) by Proposition 4.2, as well as (the formal versions of) the stronger (MS1) and (MS2) by Propositions B.1 and B.2 in the appendix. Therefore, both remain perfectly adequate and sensible measures despite the shortcomings discussed.

Our work has focused on monotone queries, but the drastic Shapley value has also been applied to CQs with negative atoms [26]. A natural next step would thus be to explore alternative responsibility measures for non-monotone queries, in particular, a suitable adaptation of WSMSs. In the presence of exogenous facts, the notion of *generalized supports*, which is very close to that of supports, has proven quite relevant [3]. Replacing minimal supports by minimal generalized supports in the definition of WSMSs could therefore provide an interesting alternative framework in this context. We have also suggested WSAXps as alternatives to the SHAP score in the context of XAI. Although WSAXps are computationally expensive, they provide strong theoretical guarantees, so it would be interesting to study approximations and to compare them experimentally with the SHAP score.

## Acknowledgments

All authors have been partially supported by ANR AI Chair INTENDED, grant ANR-19-CHIA-0014.

## References

- [1] Omer Abramovich, Daniel Deutch, Nave Frost, Ahmet Kara, and Dan Olteanu. 2024. Banzhaf Values for Facts in Query Answering. *Proceedings of the ACM on Management of Data (PACMMOD)* 2, 3 (SIGMOD) (2024), 123:1–123:26. <https://doi.org/10.1145/3654926>
- [2] Roland Bacher. 2002. Determinants of Matrices Related to the Pascal Triangle. *Journal de théorie des nombres de Bordeaux* 14, 1 (2002), 19–41. <https://doi.org/10.5802/jtnb.344>
- [3] Meghyn Bienvenu, Diego Figueira, and Pierre Lafourcade. 2024. When is Shapley Value Computation a Matter of Counting? *Proceedings of the ACM on Management of Data (PACMMOD)* 2, 2 (PODS) (2024), 105. <https://doi.org/10.1145/3651606>
- [4] Meghyn Bienvenu, Diego Figueira, and Pierre Lafourcade. 2025. Shapley Revisited: Tractable Responsibility Measures for Query Answers. *Proceedings of the ACM on Management of Data (PACMMOD)* 3, 2 (PODS) (2025), 112.
- [5] Ashok K. Chandra and Philip M. Merlin. 1977. Optimal Implementation of Conjunctive Queries in Relational Data Bases. In *Proceedings of the 9th Annual ACM Symposium on Theory of Computing, May 4-6, 1977, Boulder, Colorado, USA*, John E. Hopcroft, Emily P. Friedman, and Michael A. Harrison (Eds.). ACM, 77–90. <https://doi.org/10.1145/800105.803397>
- [6] Daniel Deutch, Nave Frost, Benny Kimelfeld, and Mikaël Monet. 2022. Computing the Shapley Value of Facts in Query Answering. In *ACM SIGMOD International Conference on Management of Data (SIGMOD)*. ACM, 1570–1583. <https://doi.org/10.1145/3514221.3517912>
- [7] Irit Dinur and Samuel Safra. 2005. On the Hardness of Approximating Minimum Vertex Cover. *Annals of Mathematics* 162, 1 (2005), 439–485. arXiv:3597377
- [8] P. Dubey. 1975. On the Uniqueness of the Shapley Value. *International Journal of Game Theory* 4, 3 (1975), 131–139. <https://doi.org/10.1007/BF01780630>

- [9] Martin E. Dyer and Catherine S. Greenhill. 2000. The complexity of counting graph homomorphisms. *Random Struct. Algorithms* 17, 3-4 (2000), 260–289. [https://doi.org/10.1002/1098-2418\(200010/12\)17:3/4<260::AID-RSA5>3.0.CO;2-W](https://doi.org/10.1002/1098-2418(200010/12)17:3/4<260::AID-RSA5>3.0.CO;2-W)
- [10] Steven Fortune, John Hopcroft, and James Wyllie. 1980. The Directed Subgraph Homeomorphism Problem. *Theoretical Computer Science* 10, 2 (1980), 111–121. [https://doi.org/10.1016/0304-3975\(80\)90009-2](https://doi.org/10.1016/0304-3975(80)90009-2)
- [11] Georg Gottlob, Gianluigi Greco, Nicola Leone, and Francesco Scarcello. 2016. Hypertree Decompositions: Questions and Answers. In *ACM Symposium on Principles of Database Systems (PODS)*. ACM Press, 57–74. <https://doi.org/10.1145/2902251.2902309>
- [12] John Grant and Anthony Hunter. 2011. Measuring Consistency Gain and Information Loss in Stepwise Inconsistency Resolution. In *Proceedings of the 11th European Conference on Symbolic and Quantitative Approaches to Reasoning with Uncertainty (ECSQARU'11)*. Springer-Verlag, Berlin, Heidelberg, 362–373.
- [13] Lane A. Hemaspaandra and Heribert Vollmer. 1995. The Satanic Notations: Counting Classes beyond #P and Other Definitional Adventures. *ACM SIGACT News* 26, 1 (1995), 2–13. <https://doi.org/10.1145/203610.203611>
- [14] Xuanxiang Huang, Martin C. Cooper, Antonio Morgado, Jordi Planes, and Joao Marques-Silva. 2023. Feature Necessity & Relevancy in ML Classifier Explanations. In *Tools and Algorithms for the Construction and Analysis of Systems*, Sriram Sankaranarayanan and Natasha Sharygina (Eds.). Springer Nature Switzerland, Cham, 167–186. [https://doi.org/10.1007/978-3-031-30823-9\\_9](https://doi.org/10.1007/978-3-031-30823-9_9)
- [15] Anthony Hunter and Sébastien Konieczny. 2010. On the Measure of Conflicts: Shapley Inconsistency Values. *Artificial Intelligence* 174, 14 (2010), 1007–1026. <https://doi.org/10.1016/j.artint.2010.06.001>
- [16] Ahmet Kara, Dan Olteanu, and Dan Suciu. 2024. From Shapley Value to Model Counting and Back. *Proceedings of the ACM on Management of Data (PACMMOD)* 2, 2 (PODS) (2024), 79. <https://doi.org/10.1145/3651142>
- [17] Pratik Karmakar, Mikaël Monet, Pierre Senellart, and Stéphane Bressan. 2024. Expected Shapley-Like Scores of Boolean Functions: Complexity and Applications to Probabilistic Databases. *Proc. ACM Manag. Data* 2, 2 (2024), 92:1–92:26. <https://doi.org/10.1145/3651593>
- [18] Majd Khalil and Benny Kimelfeld. 2023. The Complexity of the Shapley Value for Regular Path Queries. In *International Conference on Database Theory (ICDT) (Leibniz International Proceedings in Informatics (LIPIcs))*, Vol. 255. Schloss Dagstuhl - Leibniz-Zentrum für Informatik, 11:1–11:19. <https://doi.org/10.4230/LIPICS.ICDT.2023.11>
- [19] Annick Laruelle and Federico Valenciano. 2001. Shapley-Shubik and Banzhaf Indices Revisited. *Mathematics of Operations Research* (2001). <https://doi.org/10.1287/moor.26.1.89.10589>
- [20] Ester Livshits, Leopoldo E. Bertossi, Benny Kimelfeld, and Moshe Sebag. 2021. The Shapley Value of Tuples in Query Answering. *Logical Methods in Computer Science (LMCS)* 17, 3 (2021). [https://doi.org/10.46298/LMCS-17\(3:22\)2021](https://doi.org/10.46298/LMCS-17(3:22)2021)
- [21] Ester Livshits and Benny Kimelfeld. 2022. The Shapley Value of Inconsistency Measures for Functional Dependencies. *Logical Methods in Computer Science (LMCS)* 18, 2 (2022). [https://doi.org/10.46298/LMCS-18\(2:20\)2022](https://doi.org/10.46298/LMCS-18(2:20)2022)
- [22] Scott M Lundberg and Su-In Lee. 2017. A Unified Approach to Interpreting Model Predictions. In *Advances in Neural Information Processing Systems*, Vol. 30. Curran Associates, Inc.
- [23] Joao Marques-Silva and Xuanxiang Huang. 2024. Explainability Is Not a Game. *Commun. ACM* 67, 7 (2024), 66–75. <https://doi.org/10.1145/3635301>
- [24] Alexandra Meliou, Wolfgang Gatterbauer, Katherine F. Moore, and Dan Suciu. 2010. The Complexity of Causality and Responsibility for Query Answers and non-Answers. *Proc. VLDB Endow.* 4, 1 (2010), 34–45.
- [25] Reinhard Pichler and Sebastian Skritek. 2013. Tractable counting of the answers to conjunctive queries. *Journal of Computer and System Sciences (JCSS)* 79, 6 (2013), 984–1001. <https://doi.org/10.1016/J.JCSS.2013.01.012>
- [26] Alon Reshef, Benny Kimelfeld, and Ester Livshits. 2020. The Impact of Negation on the Complexity of the Shapley Value in Conjunctive Queries. In *ACM Symposium on Principles of Database Systems (PODS)*. ACM, 285–297. <https://doi.org/10.1145/3375395.3387664>
- [27] Jacques Sakarovitch. 2009. *Elements of Automata Theory*. Cambridge University Press. <https://doi.org/10.1017/CBO9781139195218>
- [28] Babak Salimi, Leopoldo Bertossi, Dan Suciu, and Guy Van den Broeck. 2016. Quantifying Causal Effects on Query Answering in Databases. In *8th USENIX Workshop on the Theory and Practice of Provenance (TaPP)*.
- [29] Lloyd S Shapley. 1953. A value for  $n$ -person games. *Contribution to the Theory of Games* 2 (1953).
- [30] Matthias Thimm. 2017. On the Compliance of Rationality Postulates for Inconsistency Measures: A More or Less Complete Picture. *Künstliche Intell.* 31, 1 (2017), 31–39. <https://doi.org/10.1007/S13218-016-0451-Y>
- [31] Seinosuke Toda and Osamu Watanabe. 1992. Polynomial-Time 1-Turing Reductions from #PH to #P. *Theoretical Computer Science* 100, 1 (1992), 205–221. [https://doi.org/10.1016/0304-3975\(92\)90369-Q](https://doi.org/10.1016/0304-3975(92)90369-Q)
- [32] Leslie G. Valiant. 1979. The Complexity of Enumeration and Reliability Problems. *SIAM J. Comput.* 8, 3 (1979), 410–421. <https://doi.org/10.1137/0208032>
- [33] Viktória Zankó. 1991. #P-Completeness via Many-One Reductions. *Int. J. Found. Comput. Sci.* 2, 1 (1991), 77–82. <https://doi.org/10.1142/S0129054191000066>

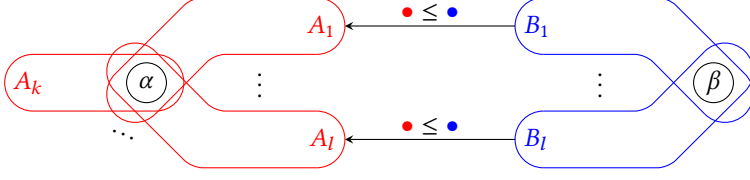

Fig. 3. A visual representation of the setting considered by (MStest). The  $A_i, B_j$  are the minimal supports of  $q$ .

## A Appendix to Section 3 “Responsibility Measures and the Drastic Shapley Value”

*Remark A.1.* The following alternative to the linearity axiom that still makes sense for Boolean games has been introduced in [8, Axiom S3’], and later used in more modern axiomatizations of the Shapley value restricted to monotone Boolean games, also called Shapley-Shubik value [19, §2]:

(Tr) *Transfer:* Given two wealth functions  $\xi_1$  and  $\xi_2$  with values in  $\mathbb{B}$ ,

$$\psi(P, \xi_1 \vee \xi_2, \alpha) + \psi(P, \xi_1 \wedge \xi_2, \alpha) = \psi(P, \xi_1, \alpha) + \psi(P, \xi_2, \alpha)$$

where  $\vee$  and  $\wedge$  are the Boolean disjunction and conjunction respectively. Since this axiom is by design restricted to Boolean wealth functions, it can be instantiated with the  $\Xi^{\text{dr}}$  family:

(Tr-dr) *Transfer:* Given two Boolean queries  $q_1$  and  $q_2$  with values in  $\mathbb{B}$ ,

$$\phi(\mathcal{D}, q_1 \vee q_2, \alpha) + \phi(\mathcal{D}, q_1 \wedge q_2, \alpha) = \phi(\mathcal{D}, q_1, \alpha) + \phi(\mathcal{D}, q_2, \alpha)$$

Although (Tr) is a nice axiom in that it allows to show the unicity of the Shapley value restricted to Boolean games, we don’t believe (Tr-dr) to be an obviously desirable feature for a responsibility measure. Even if one were to believe so, it should be noted that all WSMSs satisfy it, by virtue of the fact that they are Shapley values in disguise (see Proposition 4.4).

## B Appendix to Section 4 “Alternative responsibility measures”

### B.1 Formal statements of (MS1) and (MS2)

In this section we present and explain formal definitions of the axioms (MS1) and (MS2). Recall that they were informally written as follows.

(MS1) All other things being equal, a fact that appears in larger minimal supports should have lower responsibility.

(MS2) All other things being equal, a fact that appears in fewer minimal supports should have lower responsibility.

The key to formalizing these axioms is to define a good notion of *domination witness*  $\Delta(\alpha, \beta)$  that should ensure that  $\alpha$  must dominate  $\beta$ . A first attempt simply relies on the canonical way of comparing the cardinals of two sets, which consists in finding some injective mapping  $f$  between them. Given a fact  $\alpha \in \mathcal{D}$ , we say that  $S \subseteq \mathcal{D} \setminus \{\alpha\}$  is a *completing set* for  $\alpha$  if  $S \cup \{\alpha\} \in \text{MS}_q(\mathcal{D})$ , and denote the set of all completing sets for  $\alpha$  by  $\text{CS}(\mathcal{D}, q, \alpha)$ .

An *a-domination witness*  $\Delta(\alpha, \beta)$  of  $\alpha$  over  $\beta$  is given by:

- an injective mapping  $f : \text{CS}(\mathcal{D}, q, \beta) \hookrightarrow \text{CS}(\mathcal{D}, q, \alpha)$ ;
- for every  $S \in \text{CS}(\mathcal{D}, q, \beta)$ , an injective mapping  $\eta_S : f(S) \hookrightarrow S$ .

(MS1a) If there exists an a-domination witness  $\Delta(\alpha, \beta)$  such that one of the  $\eta_S : f(S) \hookrightarrow S$  isn’t surjective, then  $\phi(\mathcal{D}, q, \alpha) > \phi(\mathcal{D}, q, \beta)$ .

(MS2a) If there exists an a-domination witness  $\Delta(\alpha, \beta)$  such that  $f : \text{CS}(\mathcal{D}, q, \beta) \hookrightarrow \text{CS}(\mathcal{D}, q, \alpha)$  isn’t surjective, then  $\phi(\mathcal{D}, q, \alpha) > \phi(\mathcal{D}, q, \beta)$ .

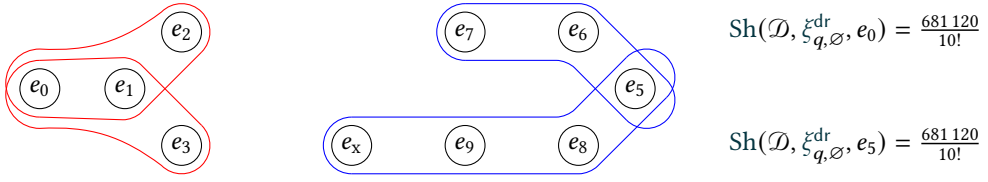

Fig. 6. Example of intersecting minimal supports. The database  $\mathcal{D}$  is the set  $\{e_0 \dots e_9, e_x\}$ , and the query  $q$  is such that the minimal supports are the colored regions (the red ones contain  $e_0$  and the blue ones contain  $e_5$ ).

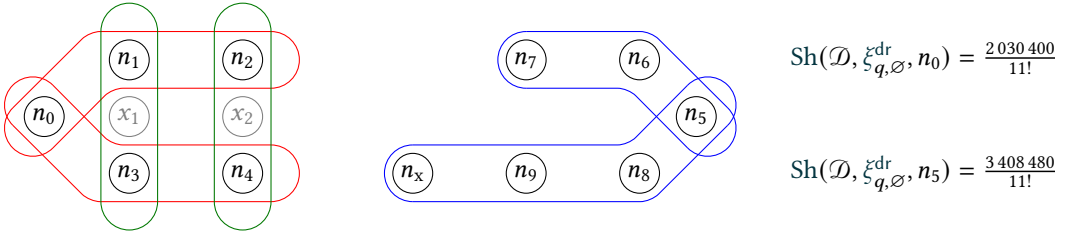

Fig. 2. Instance for Example 4.1.  $\mathcal{D}_n \hat{=} \{n_1, \dots, n_x\}$ ,  $\mathcal{D}_x \hat{=} \{x_1, x_2\}$ , and the query  $q$  is such that the minimal supports are the colored regions (the red ones contain  $e_0$ , the blue ones  $e_5$  and the green ones neither).

Observe that in the simplified setting used to define (MStest) and depicted in Figure 3,  $f$  corresponds to the black arrows and each  $\eta_S$  certifies that  $|f(S)| \leq |S|$ .

However, the notion of a-domination witness is too simplistic because it considers all minimal supports as independent when in reality they can share many elements. To illustrate this consider the example represented in Figure 6.  $e_0$  appears in two minimal supports of size 3, whereas  $e_5$  only appears in a minimal support of size 3 and one of size 4; only comparing the cardinals would thus result in a claim that  $e_0$  should necessarily have a higher responsibility than  $e_1$ . However, there is another difference between the two in the fact that the completing sets of  $e_0$  intersect whereas those of  $e_5$  don't, and as it turns out the drastic Shapley value gives the score of  $\frac{681120}{10!}$  to both. In order to compare "all other things being equal" we therefore need to add a hypothesis to the definition of a-domination witness to ensure the intersections between the completing sets are taken into consideration.

A *b-domination witness*  $\Delta(\alpha, \beta)$  of  $\alpha$  over  $\beta$  is given by:

- an injective mapping  $f : \text{CS}(\mathcal{D}, q, \beta) \hookrightarrow \text{CS}(\mathcal{D}, q, \alpha)$ ;
- for every  $S \in \text{CS}(\mathcal{D}, q, \beta)$ , an injective mapping  $\eta_S : f(S) \hookrightarrow S$ ;
- a bijection  $\eta : \mathcal{D} \setminus \{\alpha\} \hookrightarrow \mathcal{D} \setminus \{\beta\}$  such that for all  $S \in \text{CS}(\mathcal{D}, q, \beta)$ , and all  $\gamma \in f(S)$ ,  $\eta_S(\gamma) = \eta(\gamma)$ .

Essentially, the new hypothesis states that the different  $\eta_S$  must agree on the value of any  $\gamma$ . This solves the issue with the example on Figure 6 by preventing the two completing sets of  $e_5$  from mapping to the two completing sets of  $e_0$ : say  $f$  maps  $\{e_6, e_7\}$  to  $\{e_1, e_2\}$  and  $\{e_8, e_9, e_x\}$  to  $\{e_1, e_3\}$ ; then no correct  $\eta$  would exist because  $\eta(e_1)$  would need to be in  $\{e_6, e_7\} \cap \{e_8, e_9, e_x\} = \emptyset$ .

While this second iteration is a step in the right direction, it isn't quite enough. To see this, recall Example 4.1 from the main body (depicted in Figure 2). In this example, the completing sets for  $e_0$  and  $e_5$  are all disjoint from one another, meaning there exists a b-domination witness of  $n_0$  over  $n_5$ , but the completing sets for  $n_0$  intersect some minimal supports (in green) that don't contain it,

thereby weakening its contribution (according to the drastic Shapley value at least). We therefore need to add a final condition to avoid this last kind of interference.

A *domination witness*  $\Delta(\alpha, \beta)$  of  $\alpha$  over  $\beta$  is given by:

- an injective mapping  $f : \text{CS}(\mathcal{D}, q, \beta) \hookrightarrow \text{CS}(\mathcal{D}, q, \alpha)$ ;
- for every  $S \in \text{CS}(\mathcal{D}, q, \beta)$ , an injective mapping  $\eta_S : f(S) \hookrightarrow S$ ;
- there exists a bijection  $\eta : \mathcal{D} \setminus \{\alpha\} \hookrightarrow \mathcal{D} \setminus \{\beta\}$  such that for all  $S, \gamma$ ,  $\eta_S(\gamma) = \eta(\gamma)$ ;
- for all  $X \in \mathcal{D} \setminus \{\alpha\}$ , if  $X$  contains some minimal support then  $\eta(X)$  does.

(MS1) If there exists a domination witness  $\Delta(\alpha, \beta)$  such that one of the  $\eta_S : f(S) \hookrightarrow S$  isn't surjective, then  $\phi(\mathcal{D}, q, \alpha) > \phi(\mathcal{D}, q, \beta)$ .

(MS2) If there exists a domination witness  $\Delta(\alpha, \beta)$  such that  $f : \text{CS}(\mathcal{D}, q, \beta) \hookrightarrow \text{CS}(\mathcal{D}, q, \alpha)$  isn't surjective, then  $\phi(\mathcal{D}, q, \alpha) > \phi(\mathcal{D}, q, \beta)$ .

We now show that the drastic Shapley and drastic Banzhaf values satisfy these axioms indeed.

**PROPOSITION B.1.** *Let  $\phi_c$  be a drastic Shapley-like score (i.e. a Shapley-like score applied to  $\Xi^{\text{dr}}$ ) with positive coefficient function  $c$ . Then  $\phi$  satisfies (Sym-db), (Null-db), (MS1) and (MS2).*

**PROOF.** Recall that drastic Shapley-like scores are defined by the following equation

$$\begin{aligned} \phi_c(\mathcal{D}, q, \alpha) &= \mathcal{S}_c(\mathcal{D}_n, \xi_{q, \mathcal{D}_x}^{\text{dr}}, \alpha) \\ &= \sum_{B \subseteq \mathcal{D}_n \setminus \{\alpha\}} c(|B|, |\mathcal{D}|)(v(B \cup \{\alpha\}) - v(B)) \quad \text{if } \mathcal{D}_x \not\equiv q, 0 \text{ otherwise} \end{aligned} \quad (4)$$

with  $c$  the coefficient function and  $v$  the 0/1 function associated with the query.

(Sym-db) derives from the known axiom (Sym) of Shapley-like scores. For (Null-db): if a player  $\alpha$  is irrelevant, then the sum in Equation (4) is empty, hence  $\phi_c(\mathcal{D}, q, \alpha) = 0$ . Otherwise there is at least a term in the sum; now  $c$  has positive values and  $v(B \cup \{\alpha\}) - v(B) \in \{0; 1\}$  since  $q$  is monotone and Boolean, therefore  $\phi_c(\mathcal{D}, q, \alpha) > 0$ .

Now assume there exists a domination witness  $\Delta(\alpha, \beta)$ . We can apply  $\eta$ , which is a bijection, in (4) to express  $\phi_c(\mathcal{D}, q, \beta)$  as a sum over subsets of  $\mathcal{D} \setminus \{\alpha\}$ :

$$\phi_c(\mathcal{D}, q, \beta) = \sum_{X \subseteq \mathcal{D} \setminus \{\alpha\}} c(|\eta(X)|, |\mathcal{D}|)(v(\eta(X) \cup \{\beta\}) - v(\eta(X)))$$

Consider some  $X \subseteq \mathcal{D} \setminus \{\alpha\}$  such that  $v(\eta(X) \cup \{\beta\}) - v(\eta(X)) \neq 0$ , i.e. some  $\eta(X)$  that contains a completing set  $S$  for  $\beta$  and no minimal support. By the definition of domination witnesses,  $X$  then contains  $\eta^{-1}(S) = \eta_S^{-1}(S) = f(S)$ , which is a completing set for  $\alpha$ , and no minimal support. In other words, we have  $v(X \cup \{\alpha\}) - v(X) \neq 0$ , and since the only other possible value is 1 as explained earlier,  $v(\eta(X) \cup \{\beta\}) - v(\eta(X)) = v(X \cup \{\alpha\}) - v(X)$ , which yields the following:

$$\begin{aligned} \phi_c(\mathcal{D}, q, \beta) &\leq \sum_{X \subseteq \mathcal{D} \setminus \{\alpha\}} c(|X|, |\mathcal{D}|)(v(X \cup \{\alpha\}) - v(X)) \\ &= \phi_c(\mathcal{D}, q, \alpha) \end{aligned}$$

At this stage, all it takes for the above inequality to become strict is a coalition  $X$  such that  $v(\eta(X) \cup \{\beta\}) - v(\eta(X)) < v(X \cup \{\alpha\}) - v(X)$ , and this coalition can be obtained from the definition of each axiom.

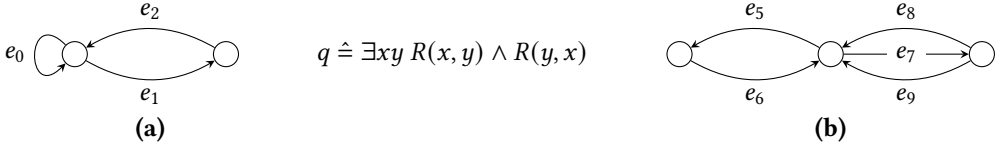

Fig. 1. Pathological example for some quantitative measures of responsibility. The databases are represented as graphs with nodes being constants and edges being  $R$ -tuples.

- (MS1) If one of the  $\eta_S : f(S) \leftrightarrow S$  isn't surjective, then  $\eta(f(S))$  is a proper subset of  $S$ , meaning it isn't (nor contains) a **completing set** for  $\alpha$ , therefore  $X = f(S)$  gives the desired result.
- (MS2) If  $f : \text{CS}(\mathcal{D}, q, \beta) \leftrightarrow \text{CS}(\mathcal{D}, q, \alpha)$  isn't surjective, then there is a  $X \in \text{CS}(\mathcal{D}, q, \alpha)$  that has no inverse image by  $f$ . We can further assume that all  $\eta_S$  are bijective, otherwise the result is already given by (MS1); in other words, for every **completing set**  $S$  for  $\beta$ ,  $\eta^{-1}(S)$  is a **completing set** for  $\alpha$ . Since  $\eta$  is bijective, if  $\eta(X)$  were to contain some  $S \in \text{CS}(\mathcal{D}, q, \beta)$ , then  $\eta^{-1}(S) \subseteq X$  would be a **completing set** for  $\alpha$ , which is contradictory. At last,  $\eta(X)$  cannot contain any **minimal support** because  $X$  doesn't. Overall, this  $X$  gives the desired result.  $\square$

Note that if one prefers the simpler (and stronger) axioms (MS1a) and (MS2a), which boil down to considering that the interactions between the minimal supports have little impact on responsibility, one can use any WSMS.

**PROPOSITION B.2.** *If  $w$  is positive and strictly decreasing, then  $\phi_{\text{wsms}}^w$  satisfies (Sym-db), (Null-db), (MS1a) and (MS2a).*

**PROOF.** (Sym-db) It is a direct consequence of (Sym) and the fact that  $w$  is only a function of the minimal supports for  $q$ , which are invariant under query equivalence.

(Null-db) If a fact  $\alpha$  is irrelevant, then it appears in no minimal support hence the sum in Equation (3) is empty. Otherwise,  $\alpha$  appears in some minimal support and the sum is non-empty. Further, all terms will be positive because  $w$  is, hence the result.

(MS1a) and (MS2a) If there exists a domination witness  $\Delta(\alpha, \beta)$ :

$$\begin{aligned}
 \phi_{\text{ms}}^w(\mathcal{D}, q, \beta) &= \sum_{S \in \text{CS}(\mathcal{D}, q, \beta)} w(|S| + 1, \mathcal{D}) && \left| \text{by (3)} \right. \\
 &\leq \sum_{S \in \text{CS}(\mathcal{D}, q, \beta)} w(|f(S)| + 1, \mathcal{D}) && \left| |S| \geq |f(S)| \Rightarrow w(|S| + 1, \mathcal{D}) \leq w(|f(S)| + 1, \mathcal{D}) \right. \\
 &\leq \sum_{X \in \text{CS}(\mathcal{D}, q, \alpha)} w(|X| + 1, \mathcal{D}) && \left| \text{because } f \text{ is injective} \right.
 \end{aligned}$$

and the hypothesis of (MS1a) (resp. (MS2a)) makes the second (resp. first) inequality strict.  $\square$

## B.2 Other missing proofs

It has been claimed in the main text that (MStest) suffices to cover the cases in Figure 1. We formally state and show this claim below.

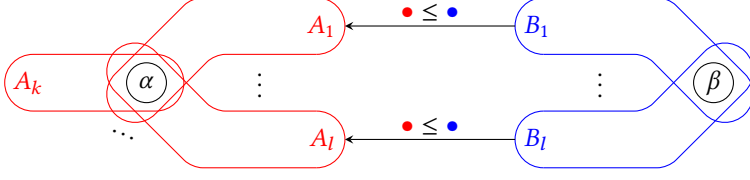

Fig. 3. A visual representation of the setting considered by (MStest). The  $A_i$  in red contain  $\alpha$  but not  $\beta$ , the  $B_j$  in blue contain  $\beta$  but not  $\alpha$ , and the minimal supports that contain both have been omitted.

CLAIM B.3. Consider the example of Figure 1. Then any measure  $\phi$  that satisfies (MStest) will be such that  $\phi(\mathcal{D}_{(a)}, q, e_0) > \phi(\mathcal{D}_{(a)}, q, e_1)$  and  $\phi(\mathcal{D}_{(b)}, q, e_7) > \phi(\mathcal{D}_{(b)}, q, e_5)$ .

PROOF. (a) Set  $k = l = 1$ ,  $\alpha = e_0$ ,  $\beta = e_1$ ,  $A_1 = \{e_0\}$  and  $B_1 = \{e_1, e_2\}$ , (MStest) ensures  $\phi(\mathcal{D}_{(a)}, q, e_0) > \phi(\mathcal{D}_{(a)}, q, e_1)$ .

(b) Set  $k = 2$ ,  $l = 1$ ,  $\alpha = e_7$ ,  $\beta = e_5$ ,  $A_1 = \{e_7, e_8\}$ ,  $A_2 = \{e_7, e_9\}$ , and  $B_1 = \{e_5, e_6\}$ . (MStest) ensures  $\phi(\mathcal{D}_{(b)}, q, e_7) > \phi(\mathcal{D}_{(b)}, q, e_5)$ .  $\square$

PROPOSITION 4.2. If  $w$  is positive and strictly decreasing (i.e., such that  $k < l \Rightarrow w(k, n) > w(l, n)$  for every  $n$ ), then  $\phi_{\text{wsms}}^w$  satisfies (Sym-db), (Null-db) and (MStest). Further, any drastic Shapley-like score with positive coefficient function satisfies these axioms as well.<sup>17</sup>

PROOF. We check that (MStest) is implied by (the formal version of) (MS1) and (MS2), making this proposition a trivial consequence of Propositions B.1 and B.2.

Take the notations from (MStest), as recalled in Figure 3. The completing sets for  $\alpha$  (resp.  $\beta$ ) are the  $A_i \setminus \{\alpha\}$  (resp. the  $B_i \setminus \{\beta\}$ ), which we shorten to  $A_i^\alpha$  (resp.  $B_i^\beta$ )

Define the domination witness  $\Delta(\alpha, \beta)$  as follows:

- The injective mapping  $f : \text{CS}(\mathcal{D}, q, \beta) \hookrightarrow \text{CS}(\mathcal{D}, q, \alpha)$  is defined by  $f(B_i^\beta) = A_i^\alpha$  for every  $i \leq l$ .
- For every  $i \leq l$ ,  $|A_i| \leq |B_i|$  implies the existence of some injective mapping  $\eta_{B_i^\beta} : A_i^\alpha \hookrightarrow B_i^\beta$ .
- The only elements that are changed by some  $\eta_S$  are the elements of some  $A_i^\alpha$ , which only appear in one of them, hence only have one possible image. This means that the bijection  $\eta : \mathcal{D} \setminus \{\alpha\} \hookrightarrow \mathcal{D} \setminus \{\beta\}$  that swaps  $\alpha$  with  $\beta$ , every  $\gamma \in A_i^\alpha$  with  $\eta_{A_i^\alpha}(\gamma)$  and leaves the rest unchanged is such that for all  $S, \gamma$ ,  $\eta_S(\gamma) = \eta(\gamma)$ .
- For all  $X \in \mathcal{D} \setminus \{\alpha\}$ , if  $X$  contains some minimal support then it can only be some  $B_i$ , because all others contain  $\alpha$ . Now by definition  $\eta$  swaps every element of  $A_i$  with some element of  $B_i$  meaning that  $\eta(B_i) \subseteq \eta(X)$  will contain the minimal support  $A_i$ .

As shown above,  $\Delta(\alpha, \beta)$  is a domination witness indeed. We conclude with the last hypothesis of (MStest): if  $\exists i. |A_i| < |B_i|$  then  $\eta_{A_i^\alpha}$  isn't surjective and (MS1) gives the desired result, and if  $k > l$  then  $f$  isn't surjective and (MS2) does.  $\square$

PROPOSITION 4.4. For every WSMS  $\phi_{\text{wsms}}^w$  and every Shapley-like score  $\mathcal{S}_c$  whose coefficient function  $c$  is positive on all inputs, there exists a family  $\Xi \triangleq \left( \xi_{q, \mathcal{D}_x} \right)$  such that for every query  $q$ , database  $\mathcal{D}$  and  $\alpha \in \mathcal{D}$ ,  $\phi_{\text{wsms}}^w(\mathcal{D}, q, \alpha) = \mathcal{S}_c(\mathcal{D}_n, \xi_{q, \mathcal{D}_x}, \alpha)$ .

<sup>17</sup>All these measures also satisfy (the formal versions of) (MS1) and (MS2) by Propositions B.1 and B.2 in the appendix.



PROOF. To obtain a WSMS, we shall use a score function  $\xi_{MS_q(\mathcal{D}), \mathcal{D}_x}^Y$  which itself is a weighted sum of minimal supports in some sense. Note that to simplify the notations later we directly take the set of minimal supports as a parameter instead of the query.

$$\begin{aligned} \xi_{MS_q(\mathcal{D})}^Y : 2^{\mathcal{D}_n} &\rightarrow \mathbb{R} \\ B &\mapsto \sum_{\substack{S \in MS_q(\mathcal{D}) \\ S \subseteq B}} \gamma(S, \mathcal{D}_n, \mathcal{D}_x) \end{aligned}$$

The coefficients  $\gamma(S, \mathcal{D}_n, \mathcal{D}_x)$  are to be set later.

It is easy to see that any Shapley-like score follows the linearity axiom  $\mathcal{S}_c(\mathcal{D}_n, \xi, \alpha) + \mathcal{S}_c(\mathcal{D}_n, \xi', \alpha) = \mathcal{S}_c(\mathcal{D}_n, \xi + \xi', \alpha)$ . From this we can get:

$$\mathcal{S}_c(\mathcal{D}_n, \xi_{MS_q(\mathcal{D})}^Y, \alpha) = \sum_{S \in MS_q(\mathcal{D})} \mathcal{S}_c(\mathcal{D}_n, \xi_{\{S\}}^Y, \alpha) \quad (5)$$

We now fix some  $S \in MS_q(\mathcal{D})$ , and denote by  $S_n$  its endogenous part. If  $\alpha \notin S_n$ , it is easy to see that  $\mathcal{S}_c(\mathcal{D}_n, \xi_{\{S\}}^Y, \alpha) = 0$ . Now consider  $\alpha \in S_n$ , and denote  $S_n^- \triangleq S_n \setminus \{\alpha\}$ . By applying (2) we get

$$\begin{aligned} \mathcal{S}_c(\mathcal{D}_n, \xi_{\{S\}}^Y, \alpha) &= \sum_{\substack{B \subseteq \mathcal{D}_n \setminus \{\alpha\} \\ S_n^- \subseteq B}} c(|B|, |\mathcal{D}_n|) \gamma(S, \mathcal{D}_n, \mathcal{D}_x) \\ &= \sum_{k=0}^{|\mathcal{D}_n| - 1} c(k, |\mathcal{D}_n|) \gamma(S, \mathcal{D}_n, \mathcal{D}_x) |\{B \subseteq \mathcal{D}_n \setminus \{\alpha\} \mid S_n^- \subseteq B \wedge |B| = k\}| \end{aligned}$$

Computing the rightmost factor boils down to choosing the  $k - |S_n^-|$  elements of  $B \setminus S_n$  out of the  $|\mathcal{D}_n| - |S_n|$  possible ones, since there is no choice on the others. This gives

$$\mathcal{S}_c(\mathcal{D}_n, \xi_{\{S\}}^Y, \alpha) = \gamma(S, \mathcal{D}_n, \mathcal{D}_x) \sum_{k=|S_n^-|}^{|\mathcal{D}_n| - 1} \binom{|\mathcal{D}_n| - |S_n|}{k - |S_n| + 1} c(k, |\mathcal{D}_n|)$$

Hence by setting

$$\gamma(S, \mathcal{D}_n, \mathcal{D}_x) \triangleq \frac{w(|S|, |\mathcal{D}_n|)}{\sum_{k=|S_n^-|}^{|\mathcal{D}_n| - 1} \binom{|\mathcal{D}_n| - |S_n|}{k - |S_n| + 1} c(k, |\mathcal{D}_n|)}$$

we obtain  $\mathcal{S}_c(\mathcal{D}_n, \xi_{MS_q(\mathcal{D})}^Y, \alpha) = \phi_{\text{wsms}}^w(\mathcal{D}, q, \alpha)$  by Equation (5), as desired. Note that there cannot be a division by 0 in the definition of  $\gamma$  because the coefficient function  $c$  is assumed to be positive on all inputs.  $\square$

PROPOSITION 4.5. *Define the weight function  $w_s(k, n) \triangleq 2^{-kn}$  and denote  $\Xi^s = \Xi^{w_s}$  for short. The function  $w_s$  is tractable, positive and strictly decreasing, and if  $\alpha, \beta \in \mathcal{D}_n$  are such that the smallest minimal support containing  $\alpha$  is smaller than the smallest minimal support containing  $\beta$ , then  $\text{Sh}(\mathcal{D}_n, \xi_{q, \mathcal{D}_x}^s, \alpha) > \text{Sh}(\mathcal{D}_n, \xi_{q, \mathcal{D}_x}^s, \beta)$ , unless  $\mathcal{D}_x \models q$ .*

PROOF. Given its closed form formula,  $w_s$  can be computed in polynomial time by elementary means. It is also obviously positive and strictly decreasing. To show the remaining property, first recall that  $\Xi^w$  is tailored so as to make the following hold:

$$\text{Sh}(\mathcal{D}_n, \xi_{q, \mathcal{D}_x}^s, \alpha) = \sum_{\substack{S \in MS_q(\mathcal{D}) \\ \alpha \in S}} 2^{-|S||\mathcal{D}_n|} \quad \text{if } \mathcal{D}_x \not\models q, 0 \text{ otherwise}$$

Now assume  $\mathcal{D}_x \not\models q$  and consider  $\alpha, \beta \in \mathcal{D}_n$  such that the smallest minimal support that contains  $\alpha$  (resp.  $\beta$ ) is of size  $k_\alpha$  (resp.  $k_\beta$ ), with  $k_\alpha < k_\beta$ . On the one hand  $\text{Sh}(\mathcal{D}_n, \xi_{q, \mathcal{D}_x}^s, \alpha) \geq 2^{-k_\alpha n}$  because any minimal support of size  $k_\alpha$  will contribute that much to the above sum. On the other hand, if we denote by  $M_\beta$  the number of minimal supports that contain  $q$ , the above formula implies  $\text{Sh}(\mathcal{D}_n, \xi_{q, \mathcal{D}_x}^s, \alpha) \leq M_\beta \cdot 2^{-k_\beta n} \leq M_\beta \cdot 2^{-(k_\alpha-1)n}$ . Now  $M_\beta \leq 2^{n-1} < 2^n$  because  $2^{n-1}$  is the total number of subsets of  $\mathcal{D}_n$  that contain  $\beta$ , hence  $\text{Sh}(\mathcal{D}_n, \xi_{q, \mathcal{D}_x}^s, \beta) < 2^{-k_\alpha n} < \text{Sh}(\mathcal{D}_n, \xi_{q, \mathcal{D}_x}^s, \alpha)$ .  $\square$

**PROPOSITION 4.6.** *Define the weight function  $w_\#(k, n) \doteq 1 + w_s(k, n)$  and denote  $\Xi^\# = \Xi^{w_\#}$  for short.  $w_\#$  is tractable, positive and strictly decreasing, and if  $\alpha, \beta \in \mathcal{D}_n$  are such that  $\alpha$  appears in more minimal supports than  $\beta$ , then  $\text{Sh}(\mathcal{D}_n, \xi_{q, \mathcal{D}_x}^\#, \alpha) > \text{Sh}(\mathcal{D}_n, \xi_{q, \mathcal{D}_x}^\#, \beta)$ , unless  $\mathcal{D}_x \models q$ .*

**PROOF.** Again, given its closed form formula,  $w_\#$  can be computed in polynomial time by elementary means; it is also obviously positive and strictly decreasing and we have the following formula by definition of  $\Xi^w$ :

$$\text{Sh}(\mathcal{D}_n, \xi_{q, \mathcal{D}_x}^s, \alpha) = \sum_{\substack{S \in \text{MS}_q(\mathcal{D}) \\ \alpha \in S}} \left(1 + 2^{-|S||\mathcal{D}_n|}\right) \quad \text{if } \mathcal{D}_x \not\models q, 0 \text{ otherwise}$$

Now if  $\mathcal{D}_x \not\models q$ , all minimal supports are of size at least one and there must necessarily be strictly fewer than  $2^{|\mathcal{D}_n|}$  of them. This means that all the  $2^{-|S||\mathcal{D}_n|}$  terms add up to a value strictly below 1, hence  $\left\lfloor \text{Sh}(\mathcal{D}_n, \xi_{q, \mathcal{D}_x}^\#, \alpha) \right\rfloor$  equals the number of minimal supports that contain  $\alpha$ . From this we can conclude immediately.  $\square$

## C Appendix to Section 5 “Data Complexity”

**LEMMA 5.1.** *For a tractable weight function  $w$  and Boolean monotone query  $q$ ,  $\text{SVC}_q^w \leq_{\text{poly}} \text{EVAL-}\#_q^{\text{fms}}$ .*

**PROOF.** Let  $w$  be a tractable weight function and  $\mathcal{D}$ ,  $\alpha$  define an instance of  $\text{SVC}_q^w$ .  $\text{Sh}(\mathcal{D}_n, \xi_{q, \mathcal{D}_x}^s, \alpha)$  can be expressed as follows using Equation (3):

$$\text{Sh}(\mathcal{D}_n, \xi_{q, \mathcal{D}_x}^s, \alpha) = \sum_{k=1}^{|\mathcal{D}|} \sum_{\substack{S \in \text{MS}_q(\mathcal{D}) \\ \alpha \in S, |S|=k}} w(k, |\mathcal{D}_n|) \quad \text{if } \mathcal{D}_x \not\models q, 0 \text{ otherwise}$$

Now the leftmost sum is the definition of  $\#_q^{\text{fms}}(k, \mathcal{D})$ , hence  $\text{SVC}_q^w \leq_{\text{poly}} \text{EVAL-}\#_q^{\text{fms}}$ .  $\square$

**PROPOSITION 5.3.** *Let  $w$  be a tractable weight function and  $q$  a regular path query. Then,  $\text{SVC}_q^w$  restricted to acyclic graph databases (i.e., only binary relations and no directed cycles) is in FP.*

**PROOF.** This proof will assume some measure of familiarity with deterministic finite word automata. We refer the interested reader to the first chapters of [27] for the relevant definitions.

Let  $\mathcal{D}$  be an acyclic database,  $\mathcal{L}(c, d)$  a regular path query and a tuple  $\mu \in \mathcal{D}$ . Without loss of generality, we can assume that  $\text{Const}(\mathcal{D}) = [n]$ , and that the natural order of the vertices form a topological sort of  $\mathcal{D}$ , i.e.  $\exists R.R(i, j) \in \mathcal{D} \Rightarrow i < j$ . Given that  $\mathcal{L}$  is regular, we can take its minimal automaton  $\mathcal{A}^\mathcal{L} = (Q^\mathcal{L}, \Sigma^\mathcal{L}, \delta^\mathcal{L}, q_0^\mathcal{L}, F^\mathcal{L})$ .<sup>18</sup>

Since  $w$  is tractable, Equation (3) can be applied in polynomial time provided we compute, for every  $k \in [n-1]$ , the number of paths from  $c$  to  $d$  labelled with a word in  $\mathcal{L}$  of size  $k$ . Note that, since  $\mathcal{D}$  is acyclic, there is no need to worry about minimality. Formally, this is the number

<sup>18</sup> $Q^\mathcal{L}$  is the set of states,  $\Sigma^\mathcal{L}$  the alphabet,  $\delta^\mathcal{L} : Q^\mathcal{L} \times \Sigma^\mathcal{L} \rightarrow Q^\mathcal{L}$  the transition function,  $q_0^\mathcal{L}$  the initial state and  $F^\mathcal{L}$  the set of final states; we abuse notations and extend the transition function to a function  $\delta^\mathcal{L} : Q^\mathcal{L} \times (\Sigma^\mathcal{L})^* \rightarrow Q^\mathcal{L}$  over words.

$sp_k^{c,q_0 \rightarrow \mu \rightarrow d,F}$  of paths of length  $k$  from  $s$  to  $t$  passing through  $\mu$  that are labelled with a word  $w$  such that  $\delta^{\mathcal{L}}(q_0, w) \in F$ . Define for every  $i, j \in V, p, q \in Q^{\mathcal{L}}$  and  $k \in [n-1]$  the number  $sp_k^{i,p \rightarrow j,q}$  of paths of length  $k$  from  $i$  to  $j$  such that  $\delta^{\mathcal{L}}(p, w) = q$ . Since  $\mathcal{D}$  is acyclic, these values follow the following recursive equation:

$$sp_k^{i,p \rightarrow j,q} = \begin{cases} \sum_{\substack{R(j',j) \in \mathcal{D} \\ \delta^{\mathcal{L}}(q',R)=q \\ i \leq j'}} sp_{k-1}^{i,p \rightarrow j',q'} & \text{if } i < j \\ 1 & \text{if } i = j, p = q \text{ and } k = 0 \\ 0 & \text{otherwise} \end{cases} \quad (6)$$

From Equation (6), the  $sp_k^{i,p \rightarrow j,q}$  can all be computed by dynamic programming, which allows the computation of the number of paths we want because it can be expressed as follows, with  $\mu \hat{=} R_\mu(\mu_s, \mu_t)$  (we sum for every possible lengths  $k', k''$ , intermediate state  $q$  and final state  $q_f$ ).

$$sp_k^{c,q_0 \rightarrow \mu \rightarrow d,F} = \sum_{k'+k''=k-1} \sum_{q \in Q} \sum_{q_f \in F} sp_{k'}^{c,q_0 \rightarrow \mu_s,q} \times sp_{k''}^{\mu_t, \delta^{\mathcal{L}}(q, R_\mu) \rightarrow d, q_f}$$

□

*Remark 5.4.* The three families  $\Xi^{ms}$ ,  $\Xi^s$  and  $\Xi^\#$  considered thus far are all reversible.

**PROOF.**  $\Xi^{ms}$  By definition,  $\xi_{q,\emptyset}^{ms}(\mathcal{D})$  is the total number of minimal supports we wish to compute. This can be done by simply taking the sum over all  $\alpha \in \mathcal{D}$  of  $\text{Sh}(\mathcal{D}, \xi_{q,\emptyset}^{ms}, \alpha)$ , by (Eff).

$\Xi^s$  Consider the binary representation of  $\text{Sh}(\mathcal{D}, \xi_{q,\emptyset}^s, \alpha)$ .

$$\text{Sh}(\mathcal{D}, \xi_{q,\emptyset}^s, \alpha) = \sum_k 2^{-k|\mathcal{D}|} \#_{q,\alpha}^{fms}(k, \mathcal{D})$$

where  $\#_{q,\alpha}^{fms}(k, \mathcal{D})$  is the number of minimal supports of  $q$  in  $\mathcal{D}$  that contain  $\alpha$ . For any  $k$ ,  $\#_{q,\alpha}^{fms}(k, \mathcal{D}) \leq 2^{|\mathcal{D}|-1} < 2^{|\mathcal{D}|}$  because  $2^{|\mathcal{D}|-1}$  is the total number of subsets of  $\mathcal{D}$  that contain  $\alpha$ . This means that  $\#_{q,\alpha}^{fms}(k, \mathcal{D})$  will be written starting from the bit of weight  $2^{-k|\mathcal{D}|}$  and will never overflow on the bit of weight  $2^{-(k-1)|\mathcal{D}|}$ . Subsequently, each of the  $\#_{q,\alpha}^{fms}(k, \mathcal{D})$  can directly be read out of the binary representation of  $\text{Sh}(\mathcal{D}, \xi_{q,\emptyset}^s, \alpha)$ . From there, the number  $\#_q^{fms}(k, \mathcal{D})$  of minimal supports of size  $k$  for  $q$  in  $\mathcal{D}$  can be computed as  $\#_q^{fms}(k, \mathcal{D}) = 1/k \sum_{\alpha \in \mathcal{D}} \#_{q,\alpha}^{fms}(k, \mathcal{D})$ , because each minimal support of size  $k$  will be counted  $k$  times, and the total number follows suit.

$\Xi^\#$  Since  $\text{Sh}(\mathcal{D}, \xi_{q,\emptyset}^s, \alpha) < 1$ , the fractional part of  $\text{Sh}(\mathcal{D}, \xi_{q,\emptyset}^\#, \alpha)$  is equal to  $\text{Sh}(\mathcal{D}, \xi_{q,\emptyset}^s, \alpha)$ , from which the total number of minimal supports can be derived as shown above. □

**LEMMA 5.5.** For a reversible weight function  $w$  and Boolean monotone query  $q$ ,  $\text{EVAL-}\#_q^{ms} \leq_{poly} \text{SVC}_q^w$ .

**PROOF.** Let  $w$  be a reversible weight function. This means that the total number of minimal supports for  $q$  in any  $\mathcal{D}$  can be computed in polynomial time given access to an oracle for  $\text{SVC}_q^w$ , which is precisely the definition of the Turing reduction  $\text{EVAL-}\#_q^{ms} \leq_{poly} \text{SVC}_q^w$ . □

**THEOREM 5.6.** Let  $w$  be a reversible tractable weight function, and a regular path query  $q \hat{=} \mathcal{L}(c, d)$ . Then  $\text{SVC}_q^w \in \text{FP}$  if  $\mathcal{L}$  is finite or  $\varepsilon \in \mathcal{L}$  and  $c = d$ , and  $\#P$ -hard otherwise.

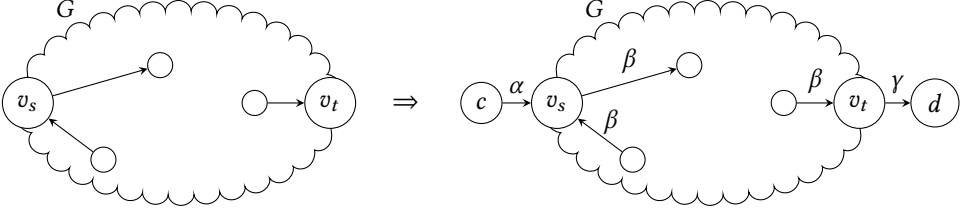

Fig. 10. Illustration of the graph database  $\mathcal{D}_G$ . Each arrow represents a path with the given label.

PROOF. If  $\mathcal{L}$  is finite then  $q$  can be expressed as a UCQ, and tractability follows from Theorem 5.2. If  $\varepsilon \in \mathcal{L}$  and  $c = d$ , then  $q$  is trivially always true.

Otherwise, we show #P-hardness by a reduction from the problem of counting the number of simple paths in directed graphs. Formally, we have a directed graph  $G = (V, E)$ , two vertices  $v_s, v_t \in V$ , and we wish to compute the number of simple paths from  $v_s$  to  $v_t$  in  $G$ . This problem is known to be #P-complete [32, Problem 14]. We shall assume, without any loss of generality, that  $v_s \neq v_t$ . Indeed, if we wish to count the simple paths that start and end at some vertex  $v$ , we can split this vertex into a pair  $v_s, v_t$  with all outgoing edges leaving  $v_s$  and all incoming edges entering  $v_t$  (formally, we have the edge  $(v_s, u)$  for every  $(v, u) \in E$  and the edge  $(u, v_t)$  for every  $(u, v) \in E$ ).

Since  $w$  is reversible, there is a reduction from counting the number of minimal supports for  $q$  in the input database to computing  $\text{SVC}_q^w$ , by Lemma 5.5. Leveraging this fact, we now build an input database that has as many minimal supports for  $q$  as there are simple paths from  $v_s$  to  $v_t$  in  $G$ .

Since  $\mathcal{L}$  is infinite and regular, the pumping lemma for regular languages states that there exists a sublanguage  $\alpha\beta^*\gamma \subseteq \mathcal{L}$ , with  $\alpha, \beta, \gamma \in \Sigma^+$ .<sup>19</sup> To build our input database  $\mathcal{D}_G$ , we start by taking all vertices in  $V$  as constants and adding, for each  $(u, v) \in E$ , a path labelled by  $\beta$  from  $u$  to  $v$ , using as many fresh intermediate constants as needed. We then add the distinguished constants  $c$  and  $d$ , with a path labelled by  $\alpha$  from  $c$  to  $v_s$  and one labelled by  $\beta$  from  $v_t$  to  $d$ . The final construction is depicted in Figure 10.

First recall that we have assumed that either  $\varepsilon \notin \mathcal{L}$  or  $c \neq d$ , meaning that the minimal supports for  $q$  must be paths of length at least 1. By construction, every simple path from  $c$  to  $d$  corresponds to a unique simple path from  $v_s$  to  $v_t$  in  $G$ , and it will be labelled by some word in  $\alpha\beta^*\gamma \subseteq \mathcal{L}$ , meaning it will be a minimal support for  $q$ . Conversely every minimal support for  $q$  has to be a path from  $c$  to  $d$  and by minimality this means that there are no other minimal supports than the simple paths. Overall, the number of minimal supports for  $q$  in  $\mathcal{D}_G$  matches the number of simple paths from  $v_s$  to  $v_t$  in  $G$  as desired, implying that  $\text{SVC}_q^w$  is #P-hard.  $\square$

Note that the proof fails if we consider existentially quantified RPQs. Indeed consider the query  $q \doteq \exists x. R^+(x, x)$  whose minimal supports are the simple cycles of  $R$ -edges: if we build the above reduction for, say  $\alpha = \beta = \gamma = R$ , each path from  $v_s$  to  $v_t$  in  $\mathcal{D}_G$  will still be a minimal support for  $q$ , but every simple cycle in  $G$  will create an additional, unwanted, minimal support for  $q$ .

## D Appendix to Section 6 “Combined Complexity”

*Remark D.1.* For every CQ  $q$  and database  $D$ ,  $\#_q^{\text{ms}}(D) \leq \#_q^{\text{hom}}(D)$ .

PROOF. Each minimal support gives rise to a different homomorphism (possibly many, as in Example 6.2), but two distinct minimal supports cannot be the image of the same homomorphism.  $\square$

<sup>19</sup>Note that we require that all three are non-empty.

We introduce some notation and terminology used in the following proofs. For an atom  $\alpha = R(\bar{t})$ , let us write  $\alpha[i]$  to denote the  $i$ -th element of  $\bar{t}$  (a constant or variable). A *subquery* of a CQ  $q$  is any query resulting from removing atoms from  $q$  – in particular  $\text{core}(q)$  is a subquery of  $q$ .

LEMMA D.2. *Computing the self-join width of a CQ is in polynomial time. A CQ  $q$  is equivalent to a CQ of self-join width at most  $k$  if, and only if,  $\text{core}(q)$  has self-join width at most  $k$ .*

PROOF. For every pair of distinct atoms  $\alpha, \alpha'$  one can check in linear time whether  $\alpha$  and  $\alpha'$  are mergeable (using any unification algorithm). Further, the self-join width of a subquery of  $q$  is smaller or equal than the self-join width of  $q$ , and thus the self-join width of  $\text{core}(q)$  is the minimum self-join width among all queries equivalent to  $q$ .  $\square$

LEMMA D.3. *If a CQ  $q$  has no mergeable atoms, then  $\#_q^{\text{hom}}(\mathcal{D}) = \#_q^{\text{ms}}(\mathcal{D}) = \#_q^{\text{fms}}(|\text{atoms}(q)|, \mathcal{D})$ .*

PROOF. If a CQ  $q$  has no mergeable atoms and two homomorphism  $h_1, h_2 : q \rightarrow \mathcal{D}$  have images  $S_1, S_2$  such that  $S_1 \subseteq S_2$ , then  $h_1 = h_2$ , otherwise there would be a fact  $\gamma \in S$  and two distinct atoms  $\alpha, \beta$  of  $q$  such that  $h_1(\alpha) = \gamma = h_2(\beta)$ . This would make  $\alpha$  and  $\beta$  mergeable, which is a contradiction. As a consequence, each homomorphism  $h : q \xrightarrow{\text{hom}} \mathcal{D}$  induces a different (minimal), hence  $\#_q^{\text{hom}}(\mathcal{D}) = \#_q^{\text{ms}}(\mathcal{D})$ .

Further, any homomorphism  $h : q \xrightarrow{\text{hom}} \mathcal{D}$  must map every atom to a different fact, because two atoms need to be mergeable in order to homomorphically map to the same fact. Subsequently, the image of  $q$  by  $h$  must be of size  $k = |\text{atoms}(q)|$ , hence  $\#_q^{\text{ms}}(\mathcal{D}) = \#_q^{\text{fms}}(k, \mathcal{D})$ .  $\square$

THEOREM 6.6. *For any class  $\mathcal{C}$  of CQs having bounded generalized hypertree width and bounded self-join width,  $\text{EVAL-}\#_{\mathcal{C}}^{\text{fms}}$  and  $\text{EVAL-}\#_{\mathcal{C}}^{\text{ms}}$  are in polynomial time.<sup>20</sup>*

Before going into the details of the proof, we need to introduce  $\text{CQ}^{\neq}$ , the class of CQs extended with *disequality atoms* of the form  $x \neq t$  where  $x$  is a variable and  $t$  is a term (i.e., a variable or a constant). It has the obvious semantics, wherein the relation associated to  $\neq$  is  $\{(c, c') \in (\text{const}(\mathcal{D}) \cup \text{const}(q))^2 : c \neq c'\}$ . We will also consider  $\text{CQ}^{\neq,=}$  and  $\text{CQ}^=$  where we also allow for *equality atoms*  $x = t$ , and say  $q$  is a  $\text{CQ}^{\neq}$ , a  $\text{CQ}^{\neq,=}$  or a  $\text{CQ}^=$  when it is in the respective class. Observe, however, that equality atoms can always be removed by replacing every occurrence of  $x$  with  $t$  if  $x$  is distinct from  $t$ , or simply removing the equality if  $t$  is equal to  $x$ . We write  $\widehat{q}$  to denote the canonical<sup>21</sup> equivalent CQ <sup>$\neq$</sup>  (resp. CQ) query for any CQ <sup>$\neq,=$</sup>  (resp. CQ <sup>$=$</sup> )  $q$ . Notice that a CQ <sup>$\neq,=$</sup>  is still monotone (although not necessarily closed under homomorphisms). The notion of *homomorphism* is adapted to CQ <sup>$\neq,=$</sup>  queries in the obvious way: restricting the valid mappings  $h$  to verify  $h(t) \neq h(t')$  if the atom  $t \neq t'$  is in the query and to verify  $h(t) = h(t')$  if the atom  $t = t'$  is in the query.

The generalized hypertree width of a CQ <sup>$\neq$</sup>  query is defined just as for CQs, by treating  $\neq$  as any binary relation name.

*Remark D.4.* If  $q$  has generalized hypertree width  $k$  and self-join width  $\ell$  then  $\widehat{p}$  in the definition of  $q_E$  cannot have generalized hypertree width greater than  $k + \ell$ .<sup>22</sup>

<sup>20</sup>We understand this statement as a “promise problem”, that is, the input to the evaluation problem is a query from  $\mathcal{C}$ , as opposed to some arbitrary string.

<sup>21</sup>Canonical in the sense of unique up to variable renaming.

<sup>22</sup>Indeed, if we add all variables of  $\text{var}(\widehat{p}) \cap M_q$  to all bags of a tree decomposition of generalized hypertree width  $k$ , we end up with a decomposition of width at most  $k + \ell$ .

*Remark D.5.* For any two Boolean CQs (or  $\text{CQ}^=$ ,  $\text{CQ}^\neq$ ,  $\text{CQ}^{\neq,=}$ )  $q, q'$  if  $h : q \xrightarrow{\text{hom}} q'$  and further  $q'$  is the *homomorphic image*<sup>23</sup> of  $q$  via  $h$ , then the generalized hypertree width of  $q$  is smaller or equal to that of  $q'$ .

*Remark D.6.* If  $q$  has generalized hypertree width  $k$  and self-join width  $\ell$ , then  $q_E$  cannot have generalized hypertree width greater than  $k + \ell$ . This is because  $q_E$  is the homomorphic image<sup>24</sup> of a query of width  $\leq k + \ell^2$  by Remark D.4, and thus by Remark D.5 the width does not increase. Further  $q_E^\neq$  cannot have generalized hypertree width greater than  $k + 2\ell$ , by adding all variables of  $\text{var}(q_E) \cap \mathbf{M}_q$  to all bags.

Further, since counting the number of homomorphisms for any class of bounded generalized hypertree width CQs is in polynomial time [25, Theorem 7], the same holds for  $\text{CQ}^\neq$ s: indeed, it suffices to materialize a relation for  $\neq$  beforehand.

**COROLLARY D.7** (OF [25, THEOREM 7]). *For any class of  $\text{CQ}^\neq$  queries of bounded generalized hypertree width, counting the number of homomorphisms is in polynomial time.*

**PROOF.** Keeping the notations from the proof sketch of Theorem 6.6, we need to compute  $\#_q^{\text{fms}}(k, \mathcal{D})$  in polynomial time for every fixed  $k$ , as this is the solution to  $\text{EVAL-}\#_C^{\text{fms}}$ .  $\text{EVAL-}\#_C^{\text{ms}}$  can then be solved by simply taking the sum of  $\#_q^{\text{fms}}(k, \mathcal{D})$  for every  $k$ . For this, we prove the following claims which correspond to the different steps of the proof sketch:

- (1) is Claim D.8;
- (2) is Claim D.9;
- (3) is Claim D.11;
- (4) is Claim D.12;
- (5) is Claim D.13.

Remember the definition of  $\mathbf{P}_q \hat{=} \{q_E : E \in \mathcal{E} \text{ s.t. } q_{E'} \xrightarrow{\text{hom}} q_E^\neq \text{ implies } q_E^\neq \xrightarrow{\text{hom}} q_{E'}^\neq \text{ for all } E' \in \mathcal{E}\}$ . We first remark that, since each  $q_E$  is a core, and the core is unique modulo *isomorphism* (i.e., the relation of variable renaming), we can (and shall) assume that every two distinct queries from  $\mathbf{P}_q$  are non-isomorphic.

The *canonical database* of a conjunctive query is the database obtained from the query by turning atoms over a relation name  $R$  into tuples of the relation  $R$  replacing each variable with a fresh constant. For any two Boolean CQs  $p, p'$  we have that  $p \xrightarrow{\text{hom}} p'$  iff  $\mathcal{D}_{p'} \models p$ , where  $\mathcal{D}_{p'}$  is the canonical database of  $p'$ .

**CLAIM D.8.** If a homomorphism  $h : q_E^\neq \xrightarrow{\text{hom}} \mathcal{D}$  induces  $S$ , then  $|S|$  is the number of atoms of  $q_E$ .

**PROOF.** By means of contradiction, take any two distinct atoms  $\alpha, \beta$  of  $q_E$  such that  $h(\alpha) = h(\beta)$ . Since  $\alpha$  and  $\beta$  are distinct, they are mergeable and there is some pair of distinct terms  $(t, t') \in \text{terms}(\alpha) \times \text{terms}(\beta) \subseteq \mathbf{M}_q \times \mathbf{M}_q$  such that  $h(t) = h(t')$ . Remember that  $q_E$  has no equality atoms and every pair of distinct terms from  $\mathbf{M}_q$  (such as  $t, t'$ ) present in  $q_E$  must appear as a disequality atom in  $q_E^\neq$ . Hence,  $t \neq t'$  is in  $q_E^\neq$ , contradicting the fact that  $h(t) = h(t')$  for a homomorphism  $h : q_E^\neq \xrightarrow{\text{hom}} \mathcal{D}$ .  $\diamond$

**CLAIM D.9.**  $\mathbf{P}_q$  can be computed in polynomial time.

**PROOF.** First observe that  $\mathcal{E}$  is of constant size since  $\mathbf{M}_q$  is assumed to be of constant size. Consider  $E \in \mathcal{E}$  and the corresponding  $q_E = \text{core}(\widehat{p})$  where, remember,  $p$  is the addition of a constant number of equalities to  $q$ , and  $\widehat{p}$  is the result of making a constant number of variable replacements. Hence,

<sup>23</sup>That is, the atoms of  $q'$  are  $\{h(\alpha) : \alpha \text{ is an atom of } q\}$ .

<sup>24</sup>The core of a query is always a homomorphic image of the query.

$\widehat{p}$  can be computed in polynomial time and has generalized hypertree width bounded by  $k + \ell$  by Remark D.4. This implies that  $\text{core}(\widehat{p})$  can be computed in polynomial time: we can check if a subquery  $p'$  of  $\widehat{p}$  is equivalent to  $p$  by simply testing  $\mathcal{D}_{p'} \models \widehat{p}$ , which can be done in polynomial time due the bounded generalized hypertree width of  $\widehat{p}$ , where  $\mathcal{D}_{p'}$  is the canonical database of  $p'$  by Corollary D.7. We can thus obtain  $\text{core}(\widehat{p})$  by greedily removing atoms until no subquery is equivalent to the query, since the core ensures that any way of removing atoms leads to the same query.  $\diamond$

CLAIM D.10. If for some  $E, E' \in \mathcal{E}$  there are homomorphisms  $q_E^\# \xrightarrow{\text{hom}} \mathcal{D}$  and  $q_{E'}^\# \xrightarrow{\text{hom}} \mathcal{D}$  inducing  $S$  and  $S'$  respectively with  $S' \subseteq S$ , then there is a homomorphism  $q_{E'}^\# \xrightarrow{\text{hom}} q_E^\#$ .

PROOF. Let  $h : q_E^\# \xrightarrow{\text{hom}} \mathcal{D}$  and  $h' : q_{E'}^\# \xrightarrow{\text{hom}} \mathcal{D}$  the homomorphisms of the statement.

We define  $g : \text{terms}(q_{E'}^\#) \rightarrow \text{terms}(q_E^\#)$  as follows:

- For every  $t \in \text{terms}(q_{E'}^\#) \setminus \mathbf{M}_q$  we define  $g(t) \hat{=} t$ . Note that these are terms appearing exclusively in non-mergeable atoms of  $q$ , and hence they are present in every  $q_{E''}$ -query for  $E'' \in \mathcal{E}$ .
- Now suppose  $t \in \text{terms}(q_{E'}^\#) \cap \mathbf{M}_q$ . Let  $\tilde{h} : q \xrightarrow{\text{hom}} q_E$  and  $\tilde{h}' : q \xrightarrow{\text{hom}} q_{E'}$ . Since  $t$  is in the  $\tilde{h}'$ -image of some mergeable atom  $\alpha$  of  $q$ , the  $h$ -preimage of  $h'(\tilde{h}'(\alpha))$  must also be in the  $\tilde{h}$ -image of some mergeable atom  $\beta$  of  $q$  (otherwise, we would have  $h(\tilde{h}(\beta)) = h'(\tilde{h}'(\alpha))$  contradicting that  $\beta$  is non-mergeable in  $q$ ). Moreover, since we ask that all  $\mathbf{M}_q$ -variables are pairwise distinct in  $h$ , there is exactly one element  $t'$  in  $h^{-1}(h'(t)) \cap \mathbf{M}_q$ . We then define  $g(t) \hat{=} t'$ .

We finally show that  $g$  is indeed a homomorphism. First, note that for every pair of distinct terms  $t, t'$  in  $\mathbf{M}_q \cap \text{var}(q_{E'}^\#)$ , we have  $g(t) \neq g(t')$  (otherwise,  $h'$  would not be a homomorphism  $h' : q_{E'}^\# \xrightarrow{\text{hom}} S'$ ). Hence, it suffices to show that  $g$  is a homomorphism  $g : q_{E'}^\# \xrightarrow{\text{hom}} q_E$ .

Take an atom  $\alpha$  of  $q_{E'}$  and let us show that  $g(\alpha)$  is in  $q_E$ . Consider the fact  $h'(\alpha)$  of  $S'$ , and let  $\beta$  be an atom of  $q_E$  such that  $h(\beta) = h'(\alpha)$ . We show that  $g(\alpha) = \beta$ .

Let  $x \in \text{terms}(\alpha)$ . If  $x \notin \mathbf{M}_q$ , then  $\alpha$  comes from a non-mergeable atom of  $q$  and if  $x = \alpha[i]$  then  $g(x) = \beta[i]$  for every  $i$ .

If  $x \in \mathbf{M}_q$  and  $x = \alpha[i]$ , by definition of  $g$  it follows that  $g(x) \in \mathbf{M}_q$  and further that  $g(\alpha[i]) = \beta[i]$  for every  $i$ .  $\diamond$

CLAIM D.11. The set of minimal supports of  $q$  in  $\mathcal{D}$  is partitioned into

$$\{S \subseteq \mathcal{D} : S \text{ is induced by a homomorphism } q_E^\# \xrightarrow{\text{hom}} \mathcal{D}\}_{q_E \in \mathbf{P}_q}.$$

PROOF. **Supports are minimal.** Let  $S$  be a support induced by a homomorphism  $h : q_E^\# \xrightarrow{\text{hom}} \mathcal{D}$ . Let us show first that  $S$  is a minimal support of  $q$ . By means of contradiction, suppose it is not the case, and let  $S' \subsetneq S$  be induced by a homomorphism  $h' : q \xrightarrow{\text{hom}} S'$ . Let  $E' \in \mathcal{E}$  be the reflexive-symmetric-transitive closure<sup>25</sup> of  $\{(t, t') \in \mathbf{M}_q \times \mathbf{M}_q : h'(t) = h'(t')\}$ . It follows that  $h' : q_{E'}^\# \xrightarrow{\text{hom}} S'$ .

We have that  $q_{E'}^\# \xrightarrow{\text{hom}} q_E^\#$  due to Claim D.10. By definition of  $\mathbf{P}_q$  we must also have the converse homomorphism  $q_E^\# \xrightarrow{\text{hom}} q_{E'}^\#$ , which means that  $S'$  is also induced by some homomorphism  $q_E^\# \xrightarrow{\text{hom}} S'$ . But this contradicts Claim D.8 since  $|S'| < |S|$ .

**Supports are distinct.** By means of contradiction, suppose there is a minimal support  $S$  induced by two distinct  $q_E, q_{E'} \in \mathbf{P}_q$ . In other words, there are  $h : q_E^\# \xrightarrow{\text{hom}} \mathcal{D}$  and  $h' : q_{E'}^\# \xrightarrow{\text{hom}} \mathcal{D}$  inducing the same (minimal) support  $S \subseteq \mathcal{D}$ . By Claim D.10 it follows that  $q_E^\#$  and  $q_{E'}^\#$  are homomorphically

<sup>25</sup>We assume that  $h(c) = c$  for every constant  $c$ .

equivalent, and then so are  $q_E$  and  $q_{E'}$ . Since  $q_E$  and  $q_{E'}$  are cores by definition, they must be isomorphic, and this contradicts that they are distinct by definition of  $\mathbf{P}_q$ .  $\diamond$

We call a homomorphism  $h : q_E^\# \rightarrow q_E^\#$  an *automorphism* of  $q_E^\#$ , and we denote by  $\text{Aut}(q_E^\#)$  the set of all automorphisms of  $q_E^\#$ .

CLAIM D.12. For every  $q_E \in \mathbf{P}_q$  and database  $\mathcal{D}$  we have

$$\#_{q_E^\#}^{\text{hom}}(\mathcal{D}) = |\text{Aut}(q_E^\#)| \cdot |\{S : S \text{ induced by homomorphism } q_E^\# \xrightarrow{\text{hom}} \mathcal{D}\}|.$$

PROOF. Take any support  $S$  induced by  $h : q_E^\# \xrightarrow{\text{hom}} \mathcal{D}$ . Any homomorphism  $h' : q_E^\# \xrightarrow{\text{hom}} \mathcal{D}$  inducing  $S$  is so that  $h'$  is the composition of an automorphism of  $q_E^\#$  with  $h$  due to Claim D.10. Hence, the set of homomorphisms inducing  $S$  is  $\{h \circ g : g \in \text{Aut}(q_E^\#)\}$ . Hence there are  $|\text{Aut}(q_E^\#)|$  many homomorphisms in  $q_E^\#(\mathcal{D})$  for each support in  $\{S : S \text{ induced by homomorphism } q_E^\# \xrightarrow{\text{hom}} \mathcal{D}\}$ . Further, two distinct induced supports cannot arise from the same homomorphism.  $\diamond$

CLAIM D.13.  $|\text{Aut}(q_E^\#)|$  and  $\#_{q_E^\#}^{\text{hom}}(\mathcal{D})$  can be computed in polynomial time.

PROOF. Remember that the generalized hypertree width of  $q_E^\#$  cannot exceed  $k+2\ell$  by Remark D.6, where  $k$  is the generalized hypertree width of  $q$  and  $\ell$  its self-join width. Hence, by Corollary D.7  $\#_{q_E^\#}^{\text{hom}}(\mathcal{D})$  can be computed in polynomial time.

Finally, we observe that  $|\text{Aut}(q_E^\#)|$  is equal to  $\#_{q_E^\#}^{\text{hom}}(\mathcal{D}_{q_E})$ , where  $\mathcal{D}_{q_E}$  is the canonical database of  $q_E$ ,<sup>26</sup> and thus  $|\text{Aut}(q_E^\#)|$  can be also computed in polynomial time.  $\diamond$

Once these claims are established, let  $P_k \subseteq \mathbf{P}_q$  be the set of all queries having exactly  $k$  atoms. Then, by Claims D.11 and D.12 it follows that

$$\#_q^{\text{fms}}(k, \mathcal{D}) = \sum_{q_E \in P_k} \frac{\#_{q_E^\#}^{\text{hom}}(\mathcal{D})}{|\text{Aut}(q_E^\#)|}.$$

which can be computed in polynomial time by Claim D.13.  $\square$

## E Appendix to Section 7 “Related Measures”

PROPOSITION 7.2. *The Shapley value of  $\Xi^R$  satisfies (Sym-db), (Null-db) and (MStest).*

PROOF. (Sym-db) If two queries  $q_1, q_2$  define the same Boolean function, and two facts  $\alpha, \beta \in \mathcal{D}_n$  are equivalent in the sense that for all  $S \subseteq \mathcal{D}_n \setminus \{\alpha, \beta\}$ ,  $S \cup \{\alpha\} \cup \mathcal{D}_x \models q_1$  iff  $S \cup \{\beta\} \cup \mathcal{D}_x \models q_2$ , then the optimal repairs will be equivalent in the sense that for all  $S \subseteq \mathcal{D}_n \setminus \{\alpha, \beta\}$ ,  $\xi_{q_1, \mathcal{D}_x}^R(S \cup \{\alpha\}) = \xi_{q_2, \mathcal{D}_x}^R(S \cup \{\beta\})$ . (Sym-db) is therefore satisfied as a consequence of (Sym).

(Null-db) An irrelevant fact will have no consequence on the size of the optimal repair, meaning it will be a null player for  $\xi_{q, \mathcal{D}_x}^R$ . (Null-db) is therefore satisfied as a consequence of (Null).

(MStest) Consider an instance  $\mathcal{D}_n = A_1 \cup \dots \cup A_k \cup B_1 \cup B_l$  and  $q$  like in the definition of (MStest). The optimal repair in that instance is  $\{\alpha, \beta\}$ , which is of size two. Intuitively, there will be two points of wealth, one shared amongst the facts that appear in some  $A_i$ , another amongst those that appear in some  $B_j$ , and for every coalition where the addition of  $\beta$  changes  $\xi_{q, \mathcal{D}_x}^R$  there is a corresponding coalition where the addition of  $\alpha$  does.

<sup>26</sup>In this case, we materialize the  $\neq$  relation and treat the  $\neq$  relation of  $q_E$  as any binary relation.



Formally, since for all  $i \leq l$ ,  $|A_i| \leq |B_i|$ , we can define for all  $i \leq l$  an injective mapping  $\eta_i : A_i \hookrightarrow B_i$ , and given the intersections we can assume that  $\eta_i(\beta) = \alpha$  for all  $i$ . We can define the permutation  $\eta$  that swaps every  $\gamma \in A_i$  with  $\eta_i(\gamma)$ , thereby extending all  $\eta_i$  at once (it is well-defined because there are no intersections besides  $\{\alpha\}$  and  $\{\beta\}$ ).

Now we have the permutation  $\eta$ , consider a coalition  $S \subseteq \mathcal{D}_n$  such that  $\xi_{q, \mathcal{D}_x}^R(S \cup \{\beta\}) \neq \xi_{q, \mathcal{D}_x}^R(S)$ . This happens when the addition of  $\beta$  completes one of the  $B_j$ , thereby increasing  $\xi_{q, \mathcal{D}_x}^R$  by 1. This means  $B_j \setminus \{\beta\} \subseteq S$  for some  $j$  hence  $A_j \setminus \{\alpha\} \subseteq \eta^{-1}(S)$  by definition of  $\eta$ , and  $\xi_{q, \mathcal{D}_x}^R(\eta^{-1}(S) \cup \{\alpha\}) - \xi_{q, \mathcal{D}_x}^R(\eta^{-1}(S)) = 1$ . We finally apply Equation (2), since the Shapley value is a Shapley-like score:

$$\begin{aligned}
\text{Sh}(\mathcal{D}_n, \xi_{q, \mathcal{D}_x}^R, \beta) &= \sum_{S \subseteq \mathcal{D}_n \setminus \{\beta\}} c(|S|, |\mathcal{D}_n|) (\xi_{q, \mathcal{D}_x}^R(S \cup \{\beta\}) - \xi_{q, \mathcal{D}_x}^R(S)) & (a) \\
&= \sum_{\substack{S \subseteq \mathcal{D}_n \setminus \{\beta\} \\ \xi_{q, \mathcal{D}_x}^R(S \cup \{\beta\}) - \xi_{q, \mathcal{D}_x}^R(S) = 1}} c(|S|, |\mathcal{D}_n|) \\
&\leq \sum_{\substack{\eta^{-1}(S) \subseteq \mathcal{D}_n \setminus \{\alpha\} \\ \xi_{q, \mathcal{D}_x}^R(\eta^{-1}(S) \cup \{\alpha\}) - \xi_{q, \mathcal{D}_x}^R(S) = 1}} c(|\eta^{-1}(S)|, |\mathcal{D}_n|) & (b) \\
&= \text{Sh}(\mathcal{D}_n, \xi_{q, \mathcal{D}_x}^R, \alpha)
\end{aligned}$$

(a) is Equation (2) and (b) comes from the fact that  $\xi_{q, \mathcal{D}_x}^R(S \cup \{\beta\}) - \xi_{q, \mathcal{D}_x}^R(S) = 1$  implies  $\xi_{q, \mathcal{D}_x}^R(\eta^{-1}(S) \cup \{\alpha\}) - \xi_{q, \mathcal{D}_x}^R(S) = 1$ . The converse, however, is false provided  $k > l$  or  $|A_i| < |B_i|$  for some  $i$ : in this case there will be some  $A_i$  such that  $\eta(A_i)$  isn't some  $B_j$ , and  $S \hat{=} \eta(A_i \setminus \{\alpha\})$  provides a counter-example, which makes the inequality (b) strict, yielding  $\text{Sh}(\mathcal{D}_n, \xi_{q, \mathcal{D}_x}^R, \beta) < \text{Sh}(\mathcal{D}_n, \xi_{q, \mathcal{D}_x}^R, \alpha)$  as desired.  $\square$

**PROPOSITION 7.3.** *There exist CQs  $q, q'$  such that  $\text{SVC}_q^R$  is #P-hard and such that  $\text{SVC}_{q'}^R$  possesses no FPRAS unless  $\text{NP} \subseteq \text{BPP}$  nor any multiplicative approximation of factor 1.3606 unless  $\text{P} = \text{NP}$ .*

**PROOF.** The statement follows from Propositions E.1 and E.2 below.  $\square$

**PROPOSITION E.1.** *There exists a CQ  $q$  such that  $\text{SVC}_q^R$  is #P-hard.*

**PROOF.** Define two sjf-CQs  $q_0 \hat{=} \exists xyz R(x) \wedge S(x, y) \wedge T(y) \wedge P(z)$ , and  $q_1 \hat{=} \exists xy R(x) \wedge S(x, y) \wedge T(y)$ . We prove the hardness of  $\text{SVC}_{q_0}^R$  by showing  $\text{SVC}_{q_1}^{\text{dr}} \leq_{\text{poly}} \text{SVC}_{q_0}^R$ , since  $\text{SVC}_{q_1}^{\text{dr}}$  is known to be #P-hard [20, Proposition 4.6]. In fact the following proof is heavily inspired by the one for [20, Proposition 4.6].

The key observation to build the reduction is the following: if we only restrict ourselves to partitioned databases  $\mathcal{D}$  that only contain a single endogenous  $P$ -atom  $\mu \hat{=} P(c)$  (and no exogenous ones), then the optimal repair measure will never be higher than 1 (removing  $\mu$  will always falsify  $q_0$ ) and more precisely we will have  $\xi_{q_0, \mathcal{D}_x}^R(B \cup \{\mu\}) = \xi_{q_1, \mathcal{D}_x}^{\text{dr}}(B)$  for every  $B \in \mathcal{D}_n \setminus \{\mu\}$ .

With this observation in mind, let  $\mathcal{D}^{\text{in}}$  be an input instance for  $\text{SVC}_{q_1}^{\text{dr}}$ . Without loss of generality we can assume that all atoms in  $\mathcal{D}^{\text{in}}$  have predicates in  $\{R, S, T\}$ : any atom on other predicates are irrelevant to  $q_1$  and can be removed without affecting the Shapley value. Let  $n \hat{=} |\mathcal{D}_n^{\text{in}}|$  and for every  $i \in \llbracket 0, n \rrbracket$  build the partitioned database  $\mathcal{D}^i$  defined by  $\mathcal{D}_n^i \hat{=} \mathcal{D}_n^{\text{in}} \uplus \{\mu\} \uplus \{S(c_0, c_k) \mid k \in [i]\}$  and

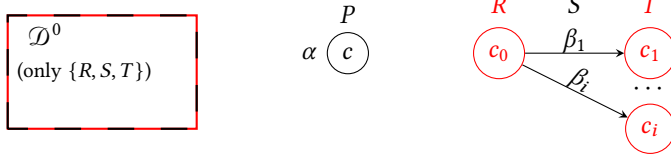

Fig. 11. Construction of  $\mathcal{D}^i$  from  $\mathcal{D}^{in}$ , with the endogenous parts in black and the exogenous ones in red.

$\mathcal{D}_x^{in} \uplus \{R(c_0)\} \uplus \{T(c_k) \mid k \in [i]\}$ , with the  $c_k$  being fresh constants. Also denote  $\beta_k \triangleq S(c_0, c_k)$  for short. This construction is depicted in Figure 11.

We now use Equation (2) to express  $\text{Sh}(\mathcal{D}_n^i, \xi_{q_0, \mathcal{D}_x^i}^R, \mu)$ , with  $c(j, m) \triangleq \frac{j!(m-j-1)!}{m!}$ :

$$\text{Sh}(\mathcal{D}_n^i, \xi_{q_0, \mathcal{D}_x^i}^R, \mu) = \sum_{B \subseteq \mathcal{D}_n^i \setminus \{\mu\}} c(|B|, |\mathcal{D}_n^i|) \left( \xi_{q_0, \mathcal{D}_x^i}^R(B \cup \{\mu\}) - \xi_{q_0, \mathcal{D}_x^i}^R(B) \right)$$

Which we can rewrite as follows, given  $|\mathcal{D}_n^i| = n + i + 1$ :

$$\text{Sh}(\mathcal{D}_n^i, \xi_{q_0, \mathcal{D}_x^i}^R, \mu) = \sum_{j=0}^{n+i} \sum_{\substack{B \subseteq \mathcal{D}_n^i \setminus \{\mu\} \\ |B|=j}} c(j, n+i+1) \left( \xi_{q_0, \mathcal{D}_x^i}^R(B \cup \{\mu\}) - \xi_{q_0, \mathcal{D}_x^i}^R(B) \right)$$

Now we need to consider the sets  $B \subseteq \mathcal{D}_n^i \setminus \{\mu\}$  such that  $\xi_{q_0, \mathcal{D}_x^i}^R(B \cup \{\mu\}) \neq \xi_{q_0, \mathcal{D}_x^i}^R(B)$ . As discussed above,  $\xi_{q_0, \mathcal{D}_x^i}^R(B) = 0$  since  $\mu \notin B$ , so this precisely happens when  $\xi_{q_0, \mathcal{D}_x^i}^R(B \cup \{\mu\}) \neq 0$  i.e. when  $\xi_{q_1, \mathcal{D}_x^i}^{\text{dr}}(B) \neq 0$  that is when  $B \cup \mathcal{D}_x^i \models q_1$ . This happens in the following two mutually exclusive cases:

- (i)  $B$  contains some  $\beta_k$ ;
- (ii)  $B \subseteq \mathcal{D}_n^{in}$  and  $B \cup \mathcal{D}_x^i \models q_1$ .

To choose some  $B$  of size  $j$  that doesn't satisfy ((i)), one simply has to choose the  $j$  elements of  $B$  amongst the  $n$  elements of  $\mathcal{D}_n$  (since all  $\beta_k$  are forbidden). Hence the number of  $B$  of size  $j$  that satisfies ((i)) is  $\binom{n+i}{j} - \binom{n}{j}$ . As for ((ii)), since none the constants  $c_k$  appears in  $\mathcal{D}^{in}$  and the variables in  $q_1$  are connected, the exogenous elements added during the construction of  $\mathcal{D}^i$  cannot help a subset of  $\mathcal{D}_n^{in}$  to satisfy  $q_1$ , hence the condition  $B \cup \mathcal{D}_x^i \models q_1$  can be replaced by  $B \cup \mathcal{D}_x^{in} \models q_1$ . Denote by  $\text{fgmc}_j$  the number of such  $B$ s, that is the number of  $B \subseteq \mathcal{D}_n^{in}$  of size  $j$  such that  $B \cup \mathcal{D}_x^i \models q_1$ . This name has been chosen because these are the solutions to the FGMC $_{q_0}$  as defined in [3, §3.2] on the instance  $\mathcal{D}^{in}$ , which we now try to compute. For this we rearrange the above equation:

$$\begin{aligned} \text{Sh}(\mathcal{D}_n^i, \xi_{q_0, \mathcal{D}_x^i}^R, \mu) &= \sum_{j=0}^{n+i} \sum_{\substack{B \subseteq \mathcal{D}_n^i \setminus \{\mu\} \\ |B|=j \\ B \models \text{(i)}}} c(j, n+i+1) + \sum_{j=0}^{n+i} \sum_{\substack{B \subseteq \mathcal{D}_n^i \setminus \{\mu\} \\ |B|=j \\ B \models \text{(ii)}}} c(j, n+i+1) \\ &= \sum_{j=0}^{n+i} c(j, n+i+1) \left( \binom{n+i}{j} - \binom{n}{j} \right) + \sum_{j=0}^n c(j, n+i+1) \text{fgmc}_j \end{aligned}$$

For short, denote  $\text{Sh}^i \triangleq \text{Sh}(\mathcal{D}_n^i, \xi_{q_0, \mathcal{D}_x^i}^R, \mu) - \sum_{j=0}^{n+i} c(j, n+i+1) \left( \binom{n+i}{j} - \binom{n}{j} \right)$ . Observe that this value can be computed in polynomial time from a call to a  $\text{SVC}_{q_0}^R$  oracle. Now if we further denote by  $Y$  the column vector  $(\text{Sh}^0 \dots \text{Sh}^n)$ , by  $X$  the column vector  $(\text{fgmc}_0 \dots \text{fgmc}_n)$ , and by  $A$  the

square matrix of general term  $c(j, n + i + 1) = \frac{j!(n+i-j)!}{(n+i+1)!}$  for  $i, j \in \llbracket 0, n \rrbracket$ , the above gives  $Y = AX$ .

We now show that  $A$  is invertible. For this we multiply every line by  $(n + i + 1)!$ , divide every column by  $j!$  and reverse the column order to obtain the matrix of general term  $(i + j)!$ , which is invertible by [2, proof of Theorem 1.1]. By computing the inverse of  $A$  we can finally obtain  $X$  in polynomial time using an oracle to  $\text{SVC}_{q_0}^R$ . We have thus shown that  $\text{FGMC}_{q_1} \leq_{\text{poly}} \text{SVC}_{q_0}^R$ , and we can conclude by [3, Proposition 3.3.(3)], which states that  $\text{SVC}_{q_1}^{\text{dr}} \leq_{\text{poly}} \text{FGMC}_{q_1}$ .  $\square$

Based on Proposition E.1 alone,  $\Xi^R$  is no better than  $\Xi^{\text{dr}}$  complexity-wise. In fact it is even worse, because the latter can be approximated on all UCQs thanks to a fully polynomial randomized approximation scheme (FPRAS), while the same cannot be done for the former:

**PROPOSITION E.2.** *There exists a CQ  $q$  such that  $\text{SVC}_q^R$  possesses no FPRAS unless  $\text{NP} \subseteq \text{BPP}$  nor any multiplicative approximation of factor 1.3606 unless  $\text{P} = \text{NP}$ .*

**PROOF.** We briefly recall the **VertexCover** problem: Given an undirected graph  $G = (V, E)$  and an integer  $k$ , we ask if there exists subset  $V' \subseteq V$  of size  $|V'| \leq k$  that touches all edges in  $E$ . This is a very well-known NP-complete problem that is the subject of various inapproximability results which we shall discuss later.

Consider the CQ  $q \triangleq \exists xy R(x) \wedge S(x, y) \wedge R(y)$  and the partitioned database  $\mathcal{D}^G$  defined by  $\mathcal{D}_n^G \triangleq R(v) \mid v \in V$ ,  $\mathcal{D}_x^G \triangleq S(u, v) \mid \{u, v\} \in E$ . By construction, for any  $B \subseteq \mathcal{D}_n^G$ ,  $B \cup \mathcal{D}_x \models q$  iff  $B$  is an *independent set* of  $G$  (i.e. a set of vertices that induces no edge). Therefore any  $\Gamma \subseteq \mathcal{D}_n$  such that  $(\mathcal{D}_n \setminus \Gamma) \models q$  is a vertex cover of  $G$ , and  $\xi_{q, \mathcal{D}_x}^R(\mathcal{D}_n)$  is the size of the smallest vertex cover of  $G$ . At last, observe that  $\sum_{\alpha \in \mathcal{D}_x} \text{Sh}(\mathcal{D}_n^G, \xi_{q, \mathcal{D}_x}^R, \alpha) = \xi_{q, \mathcal{D}_x}^R(\mathcal{D}_n)$  as a consequence of the (Eff) axiom of the Shapley value. Overall this means that any algorithm that gives a multiplicative approximation of  $\text{SVC}_q^R$  will solve **VertexCover** with the same approximation ratio.

Now **VertexCover** is notoriously difficult to approximate; more precisely it is NP-hard to approximate within a factor of smaller than  $10\sqrt{5} - 21 = 1.3606 \dots$  [7, Theorem 1.1].

As for the randomized approximation, recall that a *FPRAS* for a numerical function  $f$  is defined as a randomized algorithm  $A(x, \varepsilon, \delta)$  where  $x$  is an input for  $f$  and  $\varepsilon, \delta \in (0, 1)$  that runs in polynomial time in  $x$ ,  $1/\varepsilon$  and  $\log(1/\delta)$  that guarantees  $\mathbf{P} \left[ \frac{f(x)}{1+\varepsilon} \leq A(x, \varepsilon, \delta) \leq (1+\varepsilon)f(x) \right] \geq 1 - \delta$ , where  $\mathbf{P}$  is the probability over the randomness of  $A$ . Also recall that **BPP** is the class of decision problems for which there exists a polynomial time randomized algorithm that always gives the correct answer with probability at least  $2/3$ .

If there existed a FPRAS  $A$  for the function **VertexCover** which maps every graph  $G$  to the size of its minimal vertex cover, we could use the parameters  $\varepsilon = 1/3n$  and  $\delta = 1/3$ , where  $n$  is the number of vertices in the input graph. This would run in polynomial time and guarantee:

$$\mathbf{P} \left[ \frac{\text{VertexCover}(G)}{1 + 1/3n} \leq A(G, \varepsilon, \delta) \leq (1 + 1/3n)\text{VertexCover}(G) \right] \geq 1 - 1/3$$

This can be rewritten as follows by minimal manipulations:

$$\mathbf{P} \left[ (1 - 1/3n)\text{VertexCover}(G) \leq A(G, \varepsilon, \delta) \leq (1 + 1/3n)\text{VertexCover}(G) \right] \geq 2/3$$

Furthermore  $\text{VertexCover}(G) \leq n$  because it is the size of a subset of vertices of  $G$ . This means that the following holds:

$$\mathbf{P} \left[ \text{VertexCover}(G) - 1/3 \leq A(G, \varepsilon, \delta) \leq \text{VertexCover}(G) + 1/3 \right] \geq 2/3$$

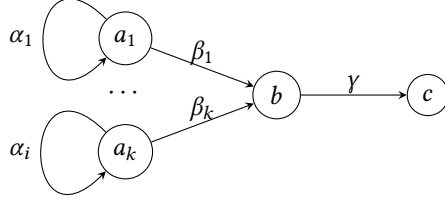

Fig. 12. Instance where the Shapley value of gives the largest value to the irrelevant  $\gamma$ .

In other words, the algorithm  $\tilde{A}$  that outputs the closest integer to  $A$  will give the correct value of  $\text{VertexCover}(G)$  with probability at least  $2/3$ . By definition this would mean  $\text{VertexCover} \in \text{BPP}$  hence  $\text{NP} \subseteq \text{BPP}$  by NP-completeness of  $\text{VertexCover}$ .  $\square$

PROPOSITION 7.4. *The Shapley value of  $\Xi^{\text{hom}}$  does not satisfy (Null-db). Moreover, an irrelevant fact may have a larger value than relevant ones by an arbitrarily large (multiplicative or additive) margin.*

PROOF. Consider the CQ  $q \doteq \exists x_0 x_1 x_2 x_3 R(x_0, x_1) \wedge R(x_1, x_2) \wedge R(x_2, x_3)$  and the purely endogenous database  $\mathcal{D}$  that contains, for every  $i \in [k]$  ( $k$  is a fixed parameter),  $\alpha_i \doteq R(a_i, a_i)$ ,  $\beta_i \doteq R(a_i, b)$  and  $\gamma \doteq R(b, c)$  (see Figure 12).

The homomorphisms from  $q$  to  $\mathcal{D}$  are as follows:

- $\alpha_i$  appears in 3 homomorphisms, which are characterized by their images:  $\{\alpha_i\}$ ,  $\{\alpha_i, \beta_i\}$  and  $\{\alpha_i, \beta_i, \gamma\}$ . Hence  $\text{Sh}(\mathcal{D}, \xi_{q, \emptyset}^{\text{hom}}, \alpha_i) = 1 + \frac{1}{2} + \frac{1}{3} = \frac{11}{6}$ .
- $\beta_i$  appears in 2 homomorphisms:  $\{\alpha_i, \beta_i\}$  and  $\{\alpha_i, \beta_i, \gamma\}$ . Hence  $\text{Sh}(\mathcal{D}, \xi_{q, \emptyset}^{\text{hom}}, \beta_i) = \frac{1}{2} + \frac{1}{3} = \frac{5}{6}$ .
- $\gamma$  appears in  $k$  homomorphisms:  $\{\alpha_i, \beta_i, \gamma\}$  for every  $i \in [k]$ . Hence  $\text{Sh}(\mathcal{D}, \xi_{q, \emptyset}^{\text{hom}}, \gamma) = \frac{k}{3}$ .

The fact with highest score is therefore  $\gamma$ , and by an arbitrary margin because its score grows linearly with  $k$  while the others are constant. However, the only minimal supports in this instance are the  $\{\alpha_i\}$ , which implies in particular that  $\gamma$  is an irrelevant.  $\square$

Note that if we were to set the  $\beta_i$  or one of the  $\alpha_i$  as exogenous,  $\text{Sh}(\mathcal{D}_n, \xi_{q, \mathcal{D}_n}^{\text{hom}}, \gamma)$  would still be linear in  $k$  while in the first case the  $\alpha_i$  would have the smallest values across all facts and in the second there would actually be no relevant fact at all.