

# SoK: A cloudy view on trust relationships of CVMs

How Confidential Virtual Machines are falling short in Public Cloud

Jana Eisoldt  
Barkhausen Institut  
Dresden, Germany  
jana.eisoldt@barkhauseninstitut.org

Anna Galanou  
TU Dresden  
Germany  
anna.galanou@tu-dresden.de

Andrey Ruzhanskiy  
Deutsche Telekom MMS GmbH  
Germany  
andrey.ruzhanskiy@telekom.de

Nils Küchenmeister  
Deutsche Telekom MMS GmbH  
Germany  
nils.kuechenmeister@tu-dresden.de

Yewgenij Baburkin  
Deutsche Telekom MMS GmbH  
Germany  
yewgenij.baburkin@telekom.de

Tianxiang Dai  
Lancaster University Leipzig  
Germany  
t.dai@lancaster.ac.uk

Ivan Gudymenko  
Deutsche Telekom MMS GmbH  
Germany  
ivan.gudymenko@telekom.de

Stefan Köpsell  
Barkhausen Institut  
Dresden, Germany  
stefan.koepsell@barkhauseninstitut.org

Rüdiger Kapitza  
FAU Erlangen-Nürnberg  
Germany  
ruediger.kapitza@fau.de

## ABSTRACT

Confidential computing in the public cloud intends to safeguard workload privacy while outsourcing infrastructure management to a cloud provider. This is achieved by executing customer workloads within so called Trusted Execution Environments, such as Confidential Virtual Machines (CVMs), which protect them from unauthorized access by cloud administrators and privileged system software. At the core of confidential computing lies remote attestation—a mechanism that enables workload owners to verify the initial state of their workload and furthermore authenticate the underlying hardware.

While this represents a significant advancement in cloud security, this SoK critically examines the confidential computing offerings of market-leading cloud providers to assess whether they genuinely adhere to its core principles. We develop a taxonomy based on carefully selected criteria to systematically evaluate these offerings, enabling us to analyse the components responsible for remote attestation, the evidence provided at each stage, the extent of cloud provider influence and whether this undermines the threat model of confidential computing. Specifically, we investigate how CVMs are deployed in the public cloud infrastructures, the extent to which customers can request and verify attestation evidence, and their ability to define and enforce configuration and attestation requirements. This analysis provides insight into whether confidential computing guarantees—namely confidentiality and integrity—are genuinely upheld. Our findings reveal that all major cloud providers retain control over critical parts of the trusted software stack and, in some cases, intervene in the standard remote attestation process. This directly contradicts their claims of delivering confidential computing, as the model fundamentally excludes the cloud provider from the set of trusted entities.

## KEYWORDS

Confidential Computing, Remote Attestation, AMD SEV-SNP, Intel TDX, Intel SGX, Cloud Security, Systematisation of Knowledge

## 1 INTRODUCTION

Confidential computing has gained significant traction in public cloud environments [5, 28, 46], promising privacy and enhanced security for sensitive workloads by migrating them into hardware-protected Trusted Execution Environments (TEEs). These guarantee protection against unauthorised access from external entities, including threats from the cloud providers themselves. Early research systems that paved the way for this development, such as Haven [11], Scone [10], and Graphene-SGX [60], envisioned a system model in which users would not lose control of their code and data while using cloud resources, but their integrity and confidentiality would be maintained. This is achieved by enforcing a clear separation of trust: Cloud customers would control their workloads, while untrusted infrastructure—including the host operating system, hypervisor, and cloud provider—would only be trusted to provide and manage resources. This leaves the hardware vendor of the used servers entrusted with the actual integrity and confidentiality protection provided by the hardware mechanisms and associated Trusted Computing Base (TCB) (e.g., firmware) required to establish the TEEs. In fact, these assumptions still build the basis for recent research systems [24, 35] because they are based on the fundamental concepts of trusted execution and are backed by current hardware extensions, such as Intel Software Guard Extensions (SGX) [19], AMD Secure Encrypted Virtualization - Secure Nested Paging (SEV-SNP) [4] and Intel Trust Domain Extensions (TDX) [33]. By providing strong hardware-backed isolation, coupled with remote attestation, these hardware extensions allow users to verify the integrity and protection of their execution environments without relying on infrastructure providers.

However, as confidential computing evolved and is increasingly embraced by public cloud providers who aim to address customer needs, security concerns, and regulatory requirements, the described idealised separation of trust has been eroded by a transfer of control over the TCB enabling TEEs. Cloud providers began to integrate their own middleware and attestation mechanisms, effectively acting as gatekeepers for verifying the TEE integrity and

authenticity. This is particularly concerning, since remote attestation is the foundation of confidential computing, enabling TEE owners/users to verify the integrity and authenticity of their execution environment before handling sensitive data. Ideally, attestation should provide cryptographic proof that the workload runs in an untampered, hardware-enforced TEE, isolated from any external interference. However, the actual trust models underpinning remote attestation in public cloud environments often diverge from the assumptions users might expect. More specifically, even though the typical TEE threat model considers the cloud provider untrusted, most of the current cloud offerings still require users to rely on the provider itself to perform attestation. This creates a fundamental mismatch between the theoretical guarantees of confidential computing and the practical reality of how it is implemented.

This mismatch becomes especially relevant since many solutions in the domain of privacy-preserving data processing utilise confidential computing and its assumed security guarantees to achieve the envisioned privacy goals. A few examples are: Mo et al. [49] survey research publications that envision enhancing privacy and security for machine learning using confidential computing, Segarra et al. [56] propose to use confidential computing to protect the processing of medical data and Khan et al. [38] propose to use confidential computing to protect sensor data fusion.

However, while the former are primarily research efforts that build on the conceptually achievable trust assumptions, there is also the German certification body gematik, which mandates the use of confidential computing due to its strong security and privacy guarantees. This is particularly vital because gematik requires the use of TEEs in a number of use cases, for example in the context of Confidential Healthcare Cloud (HCC) [26], electronic patient records (ePA) [25] and sectoral identity provider (Sek-IDP) [27]. Infrastructure providers in these cases must be technically prohibited from creating user profiles, as well as from accessing underlying cryptographic material. Also referred to as provider exclusion.

Due to these stark discrepancies regarding trust assumptions between proposed solutions in research, commercial cloud offerings, and public certification bodies, this SoK paper aims to provide a comprehensive study of public cloud confidential computing services, with a particular focus on remote attestation mechanisms. Thereby, we analyse how major cloud providers structure their attestation flows, where trust is placed, and how these models compare to the original security principles of confidential computing technologies. Our systematisation of knowledge makes the following contributions:

- development of a taxonomy for the evaluation of remote attestation frameworks in public cloud offerings;
- analysis and evaluation of the major public cloud offerings;
- examination of what confidential computing offerings are currently able to deliver and where they fail.
- Finally, we discuss possible root causes of the discrepancy between trust assumptions in research systems and the analysed commercial cloud offerings.

The rest of the paper is structured as follows: In Section 2, we provide the essential foundations for the SoK, including the threat model for confidential computing and some background on current hardware extensions (i.e., AMD SEV-SNP and Intel TDX) to enable

cloud-based confidential computing. This is followed by a discussion of related studies in Section 3. Section 4 presents a taxonomy for analysing the confidential computing cloud offerings under consideration. Next, Section 5 details the actual analysis of the major public cloud offerings, while Section 6 draws final conclusions.

## 2 BACKGROUND

In this section, we start by describing the threat model of confidential computing, based on which we highlight the shortcomings of the analysed public cloud offerings in Section 5. Furthermore, we introduce the Remote Attestation procedures (RATS) architecture to formally define the main actors in the attestation process and, to make the analysis more comprehensive. Finally, we provide more technical details on the underlying technologies, namely Trusted Platform Module, AMD SEV-SNP, and Intel TDX.

### 2.1 Threat Model

As a basis for this study, we assume a typical threat model for TEEs. We consider the cloud provider to be untrusted, as proposed by various research systems [10, 11, 60]. Furthermore, an attacker may have complete control over the software environment, including all privileged system software (i.e., hypervisor, host operating system), with the goal of breaking the confidentiality or integrity of the code running in the TEE.

Availability threats, such as interfering with TEE execution, are not of interest: By design, the cloud provider and the surrounding system software are able to stop execution of TEEs at any time. Besides that, we consider side-channel attacks to be out of scope and assume that enclaves do not have any security-related vulnerabilities that could lead to data leakage or integrity violations. We also fully trust the design and correct implementation of all the hardware and software mechanisms necessary to implement the TEE, including all necessary cryptographic operations.

### 2.2 Remote Attestation

Remote attestation, as defined by the RATS architecture [13], is a process in which one entity (Attester) produces believable information (Evidence) about itself to enable a remote entity (Relying Party) to decide whether to consider the Attester trustworthy. Figure 1 depicts this architecture. The process is facilitated by an additional party, called Verifier, who appraises the Evidence and creates Attestation Results. The Relying Party uses these results later on to make trust decisions. Additional roles include Endorser and Reference Value Provider, who supplies Endorsements and Reference Values, respectively, to the Verifier.

The RATS architecture [50] involves a two-stage appraisal procedure, verifying the Evidence and the Attestation Results. For the first step, the Verifier applies policies and supply chain input, such as Endorsements and Reference Values, to create Attestation Results from the Evidence provided by the Attester. During the second part of the procedure, the Relying Party applies its own policies to the Attestation Results associated with an Attester’s Evidence, which originates from a trusted Verifier. This appraisal leads to trust decisions regarding the Attester.

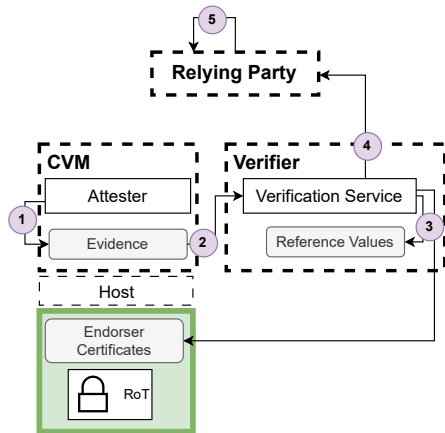

**Figure 1: RATs Architecture workflow: (1) Attester produces evidence; (2) evidence is send to Verifier; (3) Verifier validates evidence based on Reference Values and Endorsements; (4) Attestation Result is shared with Relying Party; (5) Relying Party makes trust decision.**

### 2.3 Trusted Platform Module

A Trusted Platform Module (TPM) [59] is a secure crypto-processor designed to provide hardware-based cryptographic functions and tamper-resistant storage. It can be used for random number generation, secure generation and storage of cryptographic keys, data encryption (symmetric and asymmetric), as well as cryptographic hash functions. Its main use case is typically measured boot, where the TPM acts as Hardware Root of Trust (HROt), hashing the boot components of a system sequentially, and storing these hashes in immutable chains in TPM’s Platform Configuration Registers (PCRs). PCRs cannot be directly written to; instead, values are “extended” through a hashing process, creating a cumulative record of the system’s state. The TPM acts as a Root of Trust for reporting as well, providing integrity data that can be queried by external verifiers, boot loaders, kernels, or software agents. Secure Boot [36] on the other hand, provides active enforcement against untrusted binaries by verifying their digital signatures and allowing only signed code to execute during startup.

Furthermore, a TPM provides secure key generation, storage, and management, ensuring that cryptographic keys remain protected from software-based attacks. Keys handled by a TPM are typically non-exportable, meaning private keys never leave the TPM and can also be made persistent in the TPM’s non-volatile random-access memory (NVRAM). In a physical TPM, NVRAM is a physical component integrated into the TPM chip itself and provides tamper-resistant storage, ensuring that sensitive data remains protected even when the system is off.

In case the host system is used to deploy multiple virtual machines (VMs) that cannot share the same physical TPM for security reasons, virtual TPMs (vTPMs) [12] can be used instead. These are software-based emulations of the physical TPMs, tailored for virtualised settings, allowing VMs to access trusted computing

features without dedicated hardware TPMs. vTPMs can replicate the full range of TPM functionalities, but they come with certain trade-offs. Their security guarantees are generally less robust than those of physical TPMs, and they have a larger attack surface. This increased vulnerability stems from the necessary involvement of the hypervisor in managing the vTPMs, which introduces additional complexity and potential points of compromise. An example of such compromise is the simulated NVRAM. Unlike hardware TPMs, where NVRAM is physically secured within the chip, vTPMs typically simulate it as a file stored on the host system. While this file is often encrypted to protect confidentiality, it does not inherently provide integrity protection against tampering or rollback attacks, so the stored key handles, which can eventually be used for attestation purposes, are susceptible to leakage or corruption.

### 2.4 Intel TDX

Trust Domain Extensions (TDX) [15] is Intel’s latest confidential computing technology, designed to provide robust isolation at the VM level, by deploying Trust Domains (TDs), which are protected from the host operating system, hypervisor, and other VMs running on the same hardware. TDs are hardware-isolated VMs whose memory remain encrypted with a unique key during runtime leveraging Intel’s Total Memory Encryption – Multi-Key (TME-MK).

Verifying the integrity and authenticity of a TD is possible by performing remote attestation over the TD Quote, which is TDX-signed proof about the state of the TD and the underlying platform. The TDX module [34] records measurements of the TD’s state before and after launch; before its initialisation measurements pertaining to the guest’s initial configuration and firmware image are recorded on the Measurement of Trust Domain (MRTD), while after its initialisation the four Run-Time Measurement Registers (RTMRs) can be used and extended by the virtual firmware (e.g., TDVF or TD-Shim) [31] to record TD’s runtime state. The first register typically records the firmware data, i.e. TD-Shim configuration, the second one includes the measurements of OS code (e.g., kernel image), the third one reflects the boot configuration (e.g., command line parameters, initrd) and the last one can be leveraged by runtime integrity monitoring systems to record events triggered by userland applications and the system after boot.

The TD Quote [32, 33] is essentially a signed TD report, hence a report must be requested first from the TDX module. This contains guest-specific information, platform security version, a Message Authentication Code (MAC) for integrity protection, as well as a 64-byte user-provided *report\_data*, which typically is a nonce provided by the attestation service. After the report has been created, it is sent to the TD Quoting Enclave (TDQE), an SGX enclave. The TDQE verifies the report locally by checking the MAC and then signs it with its Attestation Key (AK) to create the TD Quote.

Besides the signed report, the TD Quote also contains the Attestation Key Certificate (signed by the Provisioning Certification Key) and the Provisioning Certification Key (PCK) Certificate (signed by Intel). Similar to the Datacenter Attestation Primitives (DCAP) attestation flow [20] the generation of the Attestation Key occurs during the provisioning of the TDQE, where after the creation of this key pair, the Provisioning Certification Enclave (PCE) signs the public part of the AK using the PCK. An Intel-provided PCK

Certificate, containing the public key corresponding to the PCK signature, is made available to the Quoting Enclave (QE). The PCK Certificate’s trust is rooted in an Intel Certificate Authority (CA).

## 2.5 AMD SEV-SNP

AMD Secure Encrypted Virtualization - Secure Nested Paging [4] is the third iteration of AMD’s Secure Encrypted Virtualization (SEV) technology introducing memory integrity protection to the VM-based TEEs. AMD SEV employs a unique encryption key for each VM to protect its memory contents during runtime, leveraging the AMD Secure Processor (AMD-SP), a dedicated on-chip component that operates independently of the hypervisor. Within the SEV-SNP architecture, the TCB is comprised by the hardware and several firmware components, such as the AMD-SP API and the CPU microcode patch, which are considered upgradeable. AMD SEV-SNP also enables the VM owner to further partition its address space into four hierarchical levels, providing fine-grained security control between different components of the software stack through hardware-isolated abstraction layers within the VM. These are called Virtual Machine Privilege Levels (VMPLs) [22, 39, 58] and are numbered VMPL0 to VMPL3, with VMPL0 being the most privileged and VMPL3 the least. Higher privileged VMPLs can implement secure services [2, 40] for lesser privileged VMPLs. For example, VMPL0 can be used to run security-critical code or implement a vTPM, isolating it from potentially compromised lower-privilege levels. VMPLs can also enable a guest to contain its own management layer running at a high VMPL, controlling the permissions on its other pages. This allows secure virtualisation of a security-enforcing hypervisor within the guest VM itself, thereby enabling secure nested virtualisation [61].

To verify the integrity and authenticity of an SNP-protected VM, a remote party can request an attestation report that will eventually be generated by the AMD-SP. The report contains several key components [3]; namely the TCB version which includes information about the firmware and hardware versions, the VM’s initial state cryptographic measurements which reflect VM’s initial memory contents, configuration and 64-bytes of user supplied data, such as a nonce to prevent replay attacks. The report can be signed by one of the following attestation keys, which are both dependent on the TCB version; the Versioned Chip Endorsement Key (VCEK), which is derived from chip-unique secrets making it platform specific, or the Versioned Loaded Endorsement Key (VLEK), which is derived from a seed maintained by the AMD Key Distribution System (KDS). Each Cloud Service Provider (CSP) that enrolls with AMD has dedicated VLEK seeds, allowing for workload movement within the CSP realm. Both VLEK and VCEK are signed by AMD SEV Key (ASK), that in turn is signed by AMD Root Key (ARK), which is the master key behind the AMD certificate authority. The latter is self-signed and kept private by AMD. The attestation report also contains other data, like the *CHIP\_ID*, a unique identifier for the AMD processor chip (used with VCEK) and the *CSP\_ID*, the CSP identifier (used with VLEK). It can also hold the digest of an ID key, which can be passed as an argument during the launch of the VM to uniquely identify it, as well as the VMPL identifier to report on which privilege level the application that requested the report runs on.

Regarding the VM’s initial state measurement, which is also included in the attestation report, it typically includes only the hash of the virtual firmware because it corresponds to the first virtual firmware volume loaded during the boot process. This limited measurement is insufficient for ensuring the integrity of the entire VM, as it does not account for the operating system or root filesystem state [21, 23]. To address this limitation, measured direct boot has been implemented as a series of patches to the hypervisor, QEMU, and the virtual firmware (i.e., OVMF). This approach creates space in the firmware binary to store a table containing hashes of the kernel, initial RAM disk (initrd), and kernel command line. When QEMU boots a VM, it calculates hashes for these components and injects them into the special table. OVMF then measures each component during startup and compares the measurements with those in the designated table. This ensures more comprehensive representation of the VM’s initial state, as their cryptographic hashes are reflected in the launch measurement in the attestation report.

## 3 RELATED WORK

A wide range of surveys exist on TEEs. Sabt et al. [54] describe the key properties and concepts of TEEs to enable a clear definition of it. Munoz et al. [51] analyse vulnerabilities in TEEs, whereby they enlist a wide range of possible software-based, side-channel and architectural attacks. Li et al. [41] systematically examine the design choices of TEEs and discuss the security implications.

With regard to attestation, Ménétrey et al. [42] compare attestation mechanisms of different TEE implementations. Their work provides an overview of attestation mechanisms, which is an important basis for our analysis of commercial offerings. Niemi et al. [52] provide a survey of attestation frameworks. Their work classifies open-source enclave projects, while we study CVM-based offerings. Similarly to our work, Scopelliti et al. [55] analyse trust relationships in confidential computing offerings in the cloud. They define different attestation levels and apply them to the AMD SEV-SNP based CVM offerings by Amazon Web Services (AWS), Azure and Google Cloud Platform (GCP). Their analysis covers a subgroup of the offerings we study. Furthermore, our work provides a more fine-grained analysis of the underlying architecture and the implications for remote attestation.

## 4 TAXONOMY

Our taxonomy provides the means to investigate whether confidential computing offerings truly allow to keep the infrastructure provider outside of the trust model. Prior to this work, Niemi et al. [52] defined eight questions for the evaluation of attestation frameworks. While they take the theoretical foundations of attestation into account, we use the current state-of-the-art as the baseline for our study. Besides that, Scopelliti et al. [55] provide a classification of CVM offerings in different attestation levels. While this work provides valuable criteria for analysing attestation, our taxonomy gives a broader analysis of aspects contributing to hardware-based confidential computing, such as different RoT participating in the attestation process and the establishment of a unique target identity. We aim to apply our taxonomy to two types of VM-based execution contexts; containers and VMs on Intel TDX and AMD SEV-SNP platforms. We consider those to be the target of the attestation.

Our taxonomy consists of three categories: *Identity Establishment*, *Attestation-collateral Metrics* and *TCB*.

### 4.1 Identity Establishment

The owner of a confidential computing secured execution context expects to be able to bind a unique identity to the target, mitigating the risk of impersonation attacks. Furthermore, there must be at least one HRoT, which is involved in collecting, reporting and signing the evidence. To verify the integrity and authenticity of such evidence, the verifier will need to validate the signature of the HRoT. Additionally, there may be further Roots of Trust, acting as trust anchors for collecting and reporting runtime measurements. In the following sections, we use RoT as the general term representing software-based components, such as vTPMs, while HRoT solely refers to hardware-backed entities and their respective keys, like in the case of TEEs.

To summarise, we aim at answering the following questions:

- (1) Which hardware identity is involved in collecting and signing the evidence?
- (2) How is the identity of the target established?
- (3) How is the target identity linked to the evidence?

### 4.2 Attestation-collateral Metrics

Attestation-collateral metrics (in the following sections called metrics) are used for defining the target’s properties, so that decisions on integrity and authenticity are possible [52]. These metrics can contain one or more of the following: cryptographic hashes of the target’s context (e.g., files, data and events), identities linked to the target, allowing for *hash-based* or *key-based attestation*, respectively, or configuration data of the target. The hash-based metrics can be collected during loading time of the target or during its runtime. Hash-based metrics are static, meaning that they are only collected by the RoT during the initialisation of the target’s context and are immutable after that, while key-based metrics are dynamic. They can be extended based on user-provided policies and can be event-triggered if paired with a runtime-integrity monitoring framework (i.e. Integrity Measurement Architecture (IMA)). The key-based metrics are set during the target configuration and reported by the RoT in the attestation collateral.

During the target configuration, some security policies can be enforced, i.e. secure boot, or usage of vTPM. The enforcement of this can also be reported.

During the reporting of the attestation-collateral metrics, the verifier has the possibility to pass arbitrary data that will be cryptographically linked to the attestation report by the hardware in the attestation report. The attestation report will contain the collected metrics, the verifier-provided data and possibly information about the TEE platform. It will be signed by the HRoT.

Therefore, the following properties will be evaluated:

- (1) What are the load time metrics?
- (2) If runtime metrics are available, which entity is responsible for collecting them?
- (3) Is it possible to link user-provided data in the attestation collateral during reporting?
- (4) Is the configuration of security policies supported and is it part of the attestation collateral?

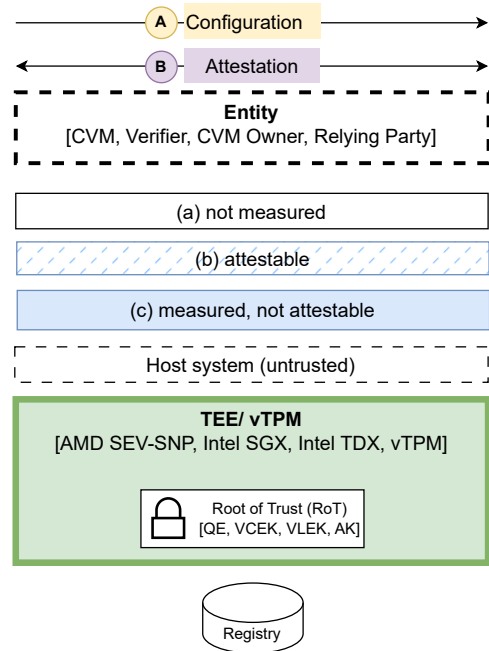

**Figure 2: Graphical notation for describing architectures used throughout the paper. We differentiate between (a) TEE components, which are not measured by a RoT, (b) components which are attestable, as they are measured and the measurement can be reproduced, and (c) components, which are measured, but due to closed source software not attestable, as measurements cannot be reproduced.**

- (5) If key-based attestation is used: How is it enforced, and which are the RoTs for this?
- (6) Are the collected metrics attestable and reproducible?

### 4.3 Trusted Computing Base

According to the threat model, which was described in Section 2.1, the TCB contains the TEE itself and the hardware it runs on. Furthermore, we use the term trusted stakeholders to describe entities that need to be trusted during attestation.

We differentiate between components that need to be implicitly trusted, and components, that can be verified. Implicit trust is typically at least required in the TEE’s hardware and firmware. The guest expects that all other components within the TCB are measurable and attestable.

Therefore, the following questions will be investigated:

- (1) Which components can be verified by a relying party and which have to be trusted implicitly?
- (2) What stakeholders are involved in the attestation?
- (3) Is it possible to configure the TCB?

## 5 ANALYSIS

Based on the described taxonomy, we evaluate different CVM and confidential container offerings in the domain of public clouds. Figure 2 depicts the graphical notation we use in the following.

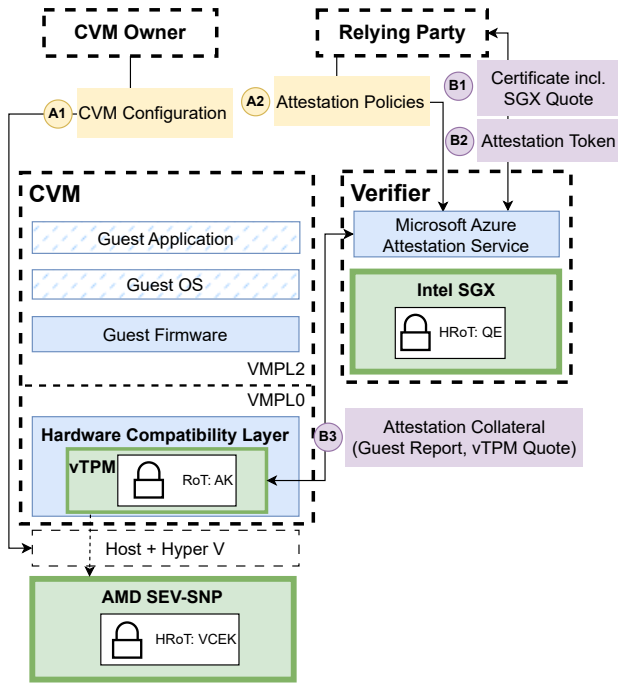

**Figure 3: Azure SEV CVM: Architecture. MAA is considered as the verifier but is optional and could be replaced.**

We target Infrastructure as a Service (IaaS) offerings, focussing on hardware-based CVM offerings, also analysing confidential container solutions enabled by CVMs. Based on market share, we selected Azure (20%), AWS (31%) and Google Cloud (12%) as the most relevant CSPs [57].

After analysing the different solutions individually, we provide a comparison of the different offerings. Finally, we discuss possible root causes that may be responsible for the identified deficiencies.

### 5.1 Microsoft Azure

Microsoft Azure has the following CVM offerings:

- (1) CVMs using AMD SEV-SNP
- (2) Confidential containers running in AMD SEV-SNP CVMs

Intel TDX based CVMs are currently only available as a preview version. Therefore, this offering is not being considered.

**5.1.1 AMD SEV-SNP CVMs.** Azure CVMs do not have direct access to the hardware, instead, they rely on a paravisor called Hardware Compatibility Layer (HCL). Azure is developing an open source version of it, called OpenHCL [53], but at the time of writing it is not being used in their offerings. When attesting a CVM, three different components must be considered:

- (1) the CVM itself;
- (2) the vTPM, part of the CVM;
- (3) Microsoft Azure Attestation (MAA) Service, the verifier provided by Azure.

Figure 3 shows the architecture of the SEV-SNP CVM offering provided by Azure. It considers the usage of MAA as verifier, which

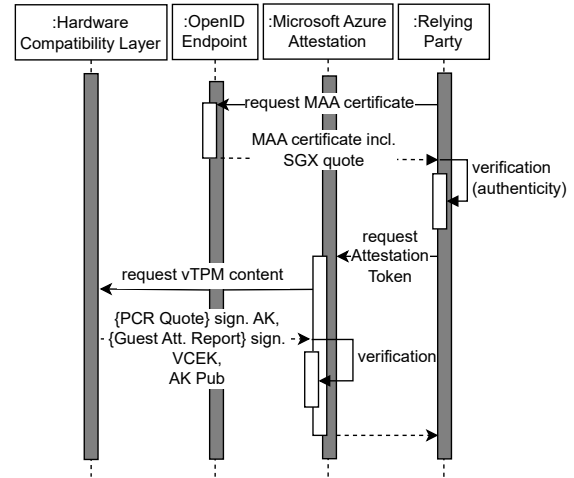

**Figure 4: Azure SEV CVM: Sequence diagram of attestation when using MAA.**

is optional. The retrieval of the attestation collateral (B2) by an arbitrary verifier remains the same; it is requested from the vTPM hosted inside the CVM, where the guest attestation report is cached. In the setup phase, the owner is able to configure the target with regard to the used base image and security policies, which allow to enable vTPM and secure boot, respectively [48]. Further detailed configuration options are not provided for secure boot. Furthermore, the relying party can configure the attestation policies of the MAA service, which is acting as verifier and running in an SGX enclave. The configuration is done by providing attestation policies, which are consulted by MAA when verifying a report.

PCRs of the vTPM can be extended for runtime attestation, if enabled. The vTPM follows the TPM 2.0 specification [59]. Azure uses the term ‘runtime claims’ [47] to summarise Azure-specific NVRAM content, which covers the CVM’s security configuration and the vTPM’s AK. A hash of this content is linked to the attestation report.

A guest attestation report is requested during the loading time by the HCL and cached in the vTPM. The vTPM furthermore allows to retrieve signed TPM Quotes from the NVRAM. Further content of the NVRAM, such as the AK public and AK certificate, can be read as well. The AK is used for signing the quotes, verification of the quote’s authenticity can therefore be achieved using the AK certificate. Verification of the guest attestation report’s authenticity can be done after retrieving the VCEK and AK certificates from the Azure Instance Metadata Service and the certificate chain from AMD’s KDS [45].

The CVM can be attested by consulting the Azure provided verifier MAA as shown in Figure 4. A self-signed certificate of the MAA can be retrieved from a provided JSON Web Key Set (JWKS) endpoint. The certificate is extended with the DCAP attestation quote of the MAA service, allowing to attest the authenticity of the service. On request of the relying party, the MAA retrieves the

guest attestation report from the CVM's vTPM. The response is a so-called attestation token, the result of evaluating the previously defined attestation policies. The attestation token is signed with MAA's private key.

*Identity Establishment.* The hardware identity of the AMD Secure Processor (AMD SEV-SP), VCEK, is responsible for collecting and signing the evidence. The owner is not able to pass a key-based identity during boot so uniquely identifying the CVM in that way is not possible. Its hardware-recorded measurement cannot serve as a unique identity either for two main reasons; the measured envelope is not fully representative of the CVM state and many of its components are closed source and hence cannot be reproduced, as we will explain in the next section.

The vTPM [47] uses a persistent AK, with a certificate issued by Azure, for signing evidence. The AK is linked to the CVM by including the hash of the 'runtime claims' in the attestation report. Although we were able to verify this certificate against some key provided in an Azure FAQ, the corresponding CA is not well documented. It is not transparent to the user how the AK is generated, so it is unclear if it is based on a random process. Though an Endorsement Key (EK) exists, we were unable to confirm a linking of the AK to it.

The MAA service, acting as a verifier, retrieves the attestation report from the vTPM and provides a signed attestation token to the relying party. It runs in an SGX enclave and has its hardware identity rooted in the DCAP QE. It is already alive during the setup of the CVM.

Depending on the chosen attestation path, different identities are involved in reporting. The measurements are initially collected by the AMD SEV-SP and signed with a VCEK. During runtime, metrics are collected by the vTPM running in the HCL, which uses a persistent key, the AK, for signing. The identity of the vTPM is linked to the CVM's VCEK by including the AK's public part in the attestation report. If verification is conducted by using MAA, this service is responsible for signing the attestation token and verifying the identities used to record the attestation collateral.

*Attestation-collateral Metrics.* The user can configure user security policies, which are limited to enabling secure boot and vTPM. These can be reported to the relying party by the MAA service or retrieved from the vTPM's NVRAM. This content cannot be authenticated, as it is unsigned; only the quotes are signed by the AK.

During loading time, the initial firmware is measured. The measurement cannot be attested, as the HCL and guest firmware are closed source and therefore not reproducible. If the vTPM is used, runtime measurements can be collected by extending the PCR registers. The identity of the vTPM, the AK, is linked to the attestation report via including a hash in the `report_data` field. The runtime measurements are in principle attestable, but require implicit trust in the HCL, where the vTPM is emulated.

The MAA service, acting as verifier, allows custom data to be included in an attestation token for ensuring freshness of the token. This data solely allows to customise the attestation token and ensure its freshness, but not of the attestation report. The service runs in an SGX enclave and is attestable with regard to authenticity. The certificate of MAA includes the SGX attestation quote of the

enclave, which contains the hash-based MRENCLAVE value of the MAA. The measurement cannot be reproduced by the MAA users, as the implementation is closed source. Validating the integrity of the measurement is only possible by comparing it to an Azure-provided value.

*TCB.* The TCB of the CVM is composed of the software running on the AMD SEV-SP, HCL, guest firmware, and guest OS. Since guest firmware and HCL are closed source and the measurements are therefore not reproducible, the user is not able to attest if the guest has been booted correctly. Implicit trust in these components is therefore necessary. The guest OS can be measured by the vTPM and attested, if the HCL is trusted.

If the user delegates verification to MAA, Azure participates in the attestation and has to be trusted implicitly, as the service's integrity can only be attested using an Azure-provided reference value. Reproducing the measurement is not possible, as the service is build from a closed-source implementation. Configuration of the TCB is limited to selecting the target guest OS image, the firmware cannot be customised.

*Conclusion.* The AMD SEV-SP CVM solution offered by Azure is able to provide the following:

- Retrieval of loading-time metrics, either by reading a cached guest attestation report from a vTPM or alternatively by requesting Attestation Tokens from a verifier called MAA provided by Azure.
- A vTPM inside of the CVM can be utilised for collecting runtime claims. The AK of the vTPM, used for collecting and signing, is bound to the CVM via a hash in the `report_data` field of the attestation report.

The following shortcomings do exist:

- The CVM has no direct access to hardware, so that attestation reports cannot be directly retrieved. Instead, it relies on Azure's HCL as paravisor.
- The owner is unable to uniquely identify the target, as no identity data can be passed and the measurements do not allow unique identification of the target either.
- Interactions with the MAA require implicit trust in Azure.
- The vTPM is solely implemented in software, using Azure closed-source code. The user is unable to attest this component. Therefore, Azure needs to be implicitly trusted.
- Freshness of attestation reports is not given, as they are requested by the HCL at loading time and cached in the vTPM. No custom data can be provided when retrieving the guest attestation report from vTPM.
- The TCB cannot be attested, as the HCL and guest firmware are closed source and measurements are therefore not reproducible.

*5.1.2 Confidential Containers.* Azure offers confidential container groups running in SEV-SNP CVMs [44] based on Parma [35]. Parma provides the possibility to launch a group of containers within a CVM with verifiable execution policies that are enforced by the guest agent. The execution policies link the image layers via *dm-verity* hashes [37], so that tampering can be detected by the guest agent prior to launch. Furthermore, the execution policies define

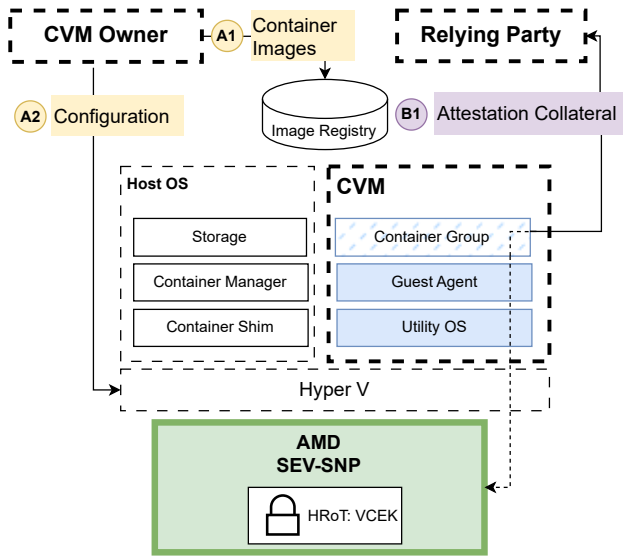

Figure 5: Azure SEV-SNP CVM Container Group architecture.

commands, entry points, and environment variables that are enforced by the guest agent. The AMD SEV-SP measures the Utility VM (UVM), composed of guest OS and guest agent, at loading time. The policies are included in the `host_data` attribute of the guest attestation report, allowing the verifier to validate if the container group has been launched with the expected configuration. The container shim, running on the host, passes the policy to the guest agent, which measures the policy and compares it to the value encoded in the attestation report.

Azure adopts Parma for their confidential container group offering, shown in Figure 5. Similar to the Parma model, the owner is able to configure execution policies, which are to be enforced by the guest agent and linked to the guest attestation report. However, configuration of the UVM, such as OS or firmware, is not possible. Attestation reports can be requested by privileged containers directly from the hardware.

*Identity Establishment.* The AMD SEV-SP is responsible for collecting the evidence, attestation reports are signed with a VCEK. The identity of the target cannot be established by providing an key-based identity before launch. As discussed in the next section, verifying the measured envelope is not feasible, making identification through measurements equally impossible.

*Attestation-collateral Metrics.* The launch measurement of the CVM cannot be attested, as the UVM is closed source. A hash of the Confidential Computing Enforcement (CCE) policies, which were configured prior to launch, are linked to the attestation report. However, as the underlying UVM is not attestable, it is unclear if the execution policies are actually enforced. Attestation of the CCE policies is therefore only possible if the underlying guest agent is implicitly trusted.

*TCB.* The TCB of a Confidential Container Group is composed of the AMD SEV-SP, the UVM, and the container image layers. It

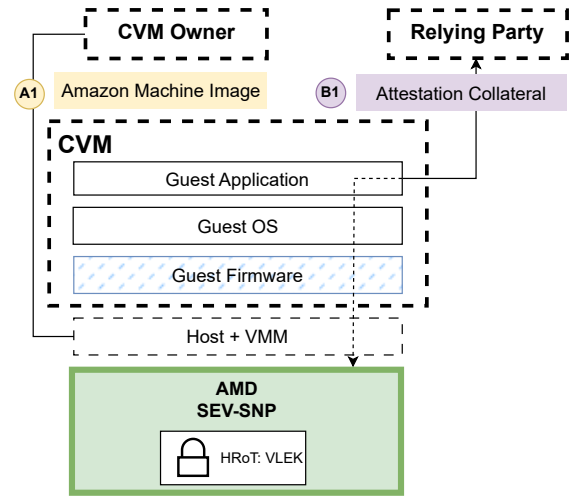

Figure 6: AWS SEV-SNP CVM: Architecture.

is not possible to attest the UVM, therefore implicit trust in this component is required. As the UVM is provided by Azure and cannot be verified, the CSP needs to be trusted, which contradicts the trust model we described in Section 2.1. Attestation of the CCE policies, covering also container image layers, is possible, but only if the UVM is trusted to enforce the policies. The TCB can only be configured with regard to the container image layers, selecting the underlying UVM is not possible.

*Conclusion.* Azure’s confidential container groups have the following properties in regard to attestation:

- Reports can be retrieved from hardware.
- CCE policies allow to define the container image layers and behaviour of the container group in an attestable manner.

It has the following shortcomings:

- No unique identity of the container group is established.
- The UVM cannot be attested, as the implementation is closed source. Therefore, it has to be trusted to enforce the policy.
- Trust in the CSP is required as the UVM is provided by Azure.
- Configuration of the UVM is not possible.

## 5.2 Amazon Web Services (AWS)

AWS offerings can leverage SEV-SNP or the AWS Nitro System for confidential computing. Nitro Enclaves [6] are managed and enforced by the Nitro Hypervisor, leading to Amazon both acting as hardware vendor and cloud provider. As our trust model assumes that the infrastructure provider does not need to be trusted, we therefore only consider the SEV-SNP offering.

*5.2.1 AMD SEV-SNP CVMs.* The workflow of setting up an AMD SEV-SNP CVM is shown in Figure 6. As depicted, the owner configures the CVM through an Amazon Machine Image (AMI). The image is either derived from an existing AMI or imported as a self-configured VM image. In both cases, the image is handled and



modified by an AWS closed source tool prior to launch and cannot be exported. Providing an identity block or using custom firmware is not possible. After launch, attestation reports can be retrieved directly from the hardware. The verification is left to the user and can therefore be achieved by using open-source tools.

*Identity Establishment.* The HRoT is the AMD SEV-SP, the attestation reports are collected and signed with a VLEK. The owner cannot bind identity data to the CVM prior to launch for establishing the target’s identity. Since the components in the measured envelope do not cover the necessary context of the CVM, uniquely identifying it by its measurement is not feasible either.

*Attestation-collateral Metrics.* The measured envelope is solely composed of the virtual firmware. Reproducing and verifying its measurement is possible, as the used firmware is open source [8]. User-provided data can be linked on request of an attestation report, so that freshness can be ensured by the verifier. Alternatively, the owner can bind a public key to the target. Runtime metrics are not available.

The owner of a CVM is able to configure the usage of a vTPM, more particular a NitroTPM [7], which runs outside of the CVM and would require trust in the hypervisor. As this is in conflict with our trust model, we do not consider this options. Besides that, the configuration of secure boot is possible, which allows to customise the boot chain of the VM. However, we were not able to detect any changes in the attestation report’s measurement, as only the virtual firmware, but not the kernel, is measured. The UEFI variable store is loaded only after the *sev init* is completed [9]. Therefore the configuration of secure boot does not influence the launch measurement.

*Trusted Computing Base.* The used guest firmware is measured and open source [8], hence the measurement can be reproduced and verified. Attesting the guest OS is not possible due to two reasons. Firstly, there exists no possibility to measure the guest OS, as the firmware cannot be customised and using the NitroTPM would require trust in the hypervisor. Secondly, a measurement of the guest OS would not be reproducible, as the image cannot be retrieved by the customer after being modified by AWS tooling. As the owner is able to configure secure boot, configuring the TCB is feasible to some extent, but this is not reflected on the launch measurement as we previously explained. Modifications of the boot chain enforced by secure boot are therefore not captured by the measurement.

Due to the modified and non-attestable guest OS, AWS becomes a trusted stakeholder on attestation. This contradicts the standard trust model, which considers only the hardware vendor as trusted.

*Conclusion.* We notice the following properties of the SEV-SNP CVM offering by AWS in regard to attestability:

- The guest OS is able to retrieve attestation reports using open source tools.
- Custom data can be linked to the target on request of an attestation report. Thus, the verifier can ensure freshness and the owner can bind cryptographic material to the CVM.

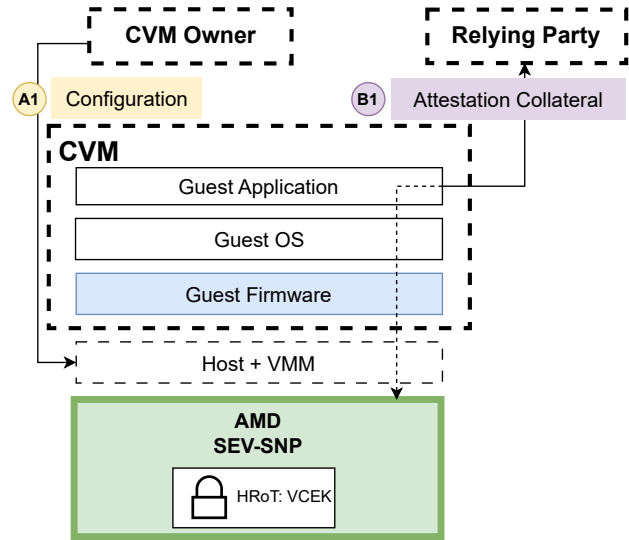

Figure 7: GCP SEV-SNP CVM: Architecture.

- The recorded measurement in the hardware attestation report can be verified, as the guest firmware is open source and can be reproduced.

However, we also noticed the following shortcomings:

- The owner is not able to uniquely identify the CVM. This makes impersonation attacks possible, in which a tampered CVM is used without notice by the user.
- The usage of custom firmware is not possible.
- The relying party is not able to fully attest the TCB, as attesting the guest OS is not possible.
- Runtime measurements cannot be made without trust in the CSP, as a NitroTPM would need to be used, which runs outside of the CVM and is managed by the hypervisor.

### 5.3 Google Cloud

Google Cloud provides the following options for hardware-based confidential computing:

- (1) CVMs using AMD SEV-SNP
- (2) CVMs using Intel TDX
- (3) Confidential containers, called ‘Confidential Space’, which leverage AMD SEV CVMs

As AMD SEV does not provide integrity protection over the CVM or post boot attestation for its context, and because the solution solely relies on a cloud provider-managed vTPM as a RoT for recording/reporting, we only consider the offerings that are based on AMD SEV-SNP and Intel TDX.

*5.3.1 AMD SEV-SNP CVMs.* The interactions on setting up and attesting a GCP CVM are shown in Figure 7. The owner is able to select a preconfigured, optionally customised, image [29]. The guest OS can retrieve the attestation reports directly from the hardware. The verification of attestation reports can be achieved using open-source tools.

*Identity Establishment.* The hardware identity to collect and sign the evidence is a VCEK. It is not possible for the owner to provide identity data prior to launch. Unique identification via the components in the measured envelope is not possible either, as guest OS and guest application are not covered in the measurement.

*Attestation-collateral Metrics.* At loading time, the AMD SEV-SP and guest firmware are measured. The collected measurement cannot be reproduced, as the firmware is closed source. Verification is only possible by comparing the measurement with the reference values of Google [17]. It is not possible to conduct runtime measurements. This would only be possible using the GCP provided vTPM, but we were unable to find any information about its operation. We therefore assume that it is running outside the CVM, which requires trust in the CSP. As this contradicts the adopted trust model, we do not consider this as an option for collecting runtime metrics. Guest attestation reports can be retrieved from the hardware using open-source tools, with the option to provide arbitrary data that is cryptographically linked to the attestation report.

GCP allows to enrich a CVM with further security policies, i.e. secure boot, vTPM, and integrity monitoring, whereby integrity monitoring reports the results of measured boot [18]. The enforcement is reported via a Google provided monitoring tool [16] and is not part of the attestation report, therefore it cannot be attested. Secure boot can be activated or deactivated, respectively, and a behaviour in case of violation can be defined.

*Trusted Computing Base.* The TCB consists of the AMD SEV-SP firmware, guest firmware, and guest OS. The guest firmware is owned by Google and closed source, measurements are therefore not reproducible. The guest OS is not attestable without using the Google provided vTPM, which does not conform with our trust model. Given that the guest firmware is closed source, implicit trust in Google is required since its implementation cannot be validated. Customising the TCB is limited to configuring the OS based on a Google-provided image. The firmware cannot be customised.

*Conclusion.* The SEV-SNP CVM offering provides the following assurances:

- The guest OS can interact with the HRoT directly.
- Custom data can be provided on request of a report, allowing to bind a public key to the target or ensuring freshness via a nonce.

The following deficiencies exist:

- No unique identity of the target is established. Due to that, impersonation attacks cannot be detected.
- The measurements of the guest firmware cannot be reproduced, as it is closed source.
- It is not possible to collect runtime metrics.

**5.3.2 Intel TDX CVMs.** Figure 8 depicts the configuration and attestation of a CVM. Prior to launch, the owner of a CVM can select the used guest image. This guest image can be either a preconfigured one, or a customer provided [29], with a specific kernel configuration supporting TDX. Furthermore, similar to the offering for AMD SEV-SNP CVMs, secure boot, vTPM, and Integrity Monitoring can be enabled as well. The guest can retrieve quotes directly from hardware and the verification can be done using open source tools.

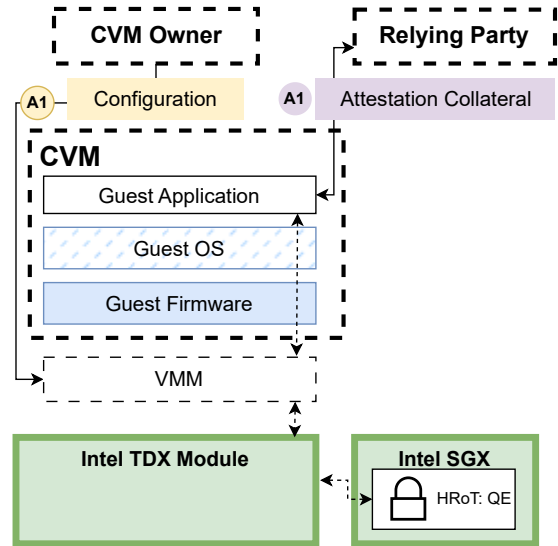

Figure 8: GCP TDX CVM: Architecture.

*Identity Establishment.* The hardware identity used for signing the evidence is the QE running on Intel SGX. The recording of loading time measurements is conducted by the TDX module, while the recording of runtime measurements is done by the virtual firmware. The latter allows unique identification of the target by measurement.

*Attestation-collateral Metrics.* The loading time measurement covers the virtual firmware of the CVM. The virtual firmware is not attestable, as the measurement can only be compared to a Google-provided value and not reproduced [30]. At runtime, the RTMRs can be used for collecting measurements. The registers initially contain measurements of the configuration of the TD virtual firmware, the TD OS loader and kernel, and the OS application. As described, the virtual firmware is recording the measurements. As this component is not attestable, implicit trust is required on conducting runtime measurements. If the owner enabled secure boot, this is reflected in the event log, but not on the attestation report.

*Trusted Computing Base.* The TCB is composed of the Intel TD firmware, guest firmware, and guest OS. Since the guest firmware cannot be attested and is provided by the Google, the CSP becomes a trusted stakeholder for attestation. Customising the TCB is providing the OS image.

*Conclusion.* The TDX CVM is able to provide the following:

- The guest is able to directly retrieve TD quotes.
- The offering allows the unique identification of the target via its measurements.
- Runtime measurements can be conducted by trusting the virtual firmware.

We notice the following limitations:

- The virtual firmware is closed-source software owned by Google, therefore not attestable. Due to that, Google becomes a trusted stakeholder.

- Runtime measurements are collected by the virtual firmware, which cannot be verified.

## 5.4 Comparison

Our analysis covers four hardware-based CVM offerings, three of which are based on AMD SEV-SNP (AWS, Azure, GCP) and one on Intel TDX (GCP). Furthermore, we studied one confidential container offering, provided by Azure and based on AMD SEV-SNP CVMs. Table 1 shows the results of our comparison, which is described below.

*Identity Establishment.* An unique identity can be established during loading time by a key representing the owner or by cryptographic measurements that uniquely represent the target. If this is not possible, a user is unable to detect impersonation attacks and therefore cannot be sure that they use the TEE they received the attestation collateral for. Only the TDX CVM offering by GCP allows for the unique establishment of a target identity and this is facilitated by the representative measurement recorded in the attestation collateral. During runtime, the target’s public key can be linked to an attestation report, allowing the establishment of a secure channel with the relying party. This can be done in all offerings, but in the case of Azure SEV-SNP CVMs the provided verifier has to be trusted since the attestation reports cannot be retrieved directly.

*Attestation-collateral Metrics.* Configuring security policies, such as secure boot, is possible in all solutions. However, the enforcement of policies is attestable only in Azure SEV-SNP CVMs, and only by depending on the provided verifier (i.e. MAA) and the HCL, which emulates the vTPM. All offerings allow the collection of load-time metrics, but in most cases, they are not attestable. Only SEV-SNP CVMs in AWS use open source firmware, allowing to reproduce measurements. The collection of runtime metrics is promised by all CVM offerings, but the recording of them needs to be performed by a verifiable RoT. As described previously, no offering enables such verifiability. Besides that, the RoT for collecting evidence must reside inside of the CVM, instead of being managed by the CSP. This condition is fulfilled by Azure SEV-SNP CVMs and GCP TDX, because of which we evaluate their attestable runtime metrics as partially supported.

*Trusted Computing Base.* None of the solutions allows to attest all components of the TCB, as depicted previously. Configuring the TCB is limited to choosing the target OS or the container image for the CVM and container offerings respectively. AWS is the only offering that allows the owner to configure secure boot with trusted signatures, so that the TCB can be customised, but a choice over the virtual firmware is not possible.

Our trust model assumes that only the hardware vendor needs to be trusted on attestation. None of the offerings is able to fulfil this requirement, as either closed source software, provided by the CSP, is used, or not all components of the TCB can be measured and therefore verified.

*Preliminary Conclusion.* We see a strong discrepancy between the security principles needed for confidential computing and what

is actually being offered in commercial solutions. None of the studied architectures provides all the necessary building blocks we expect for attestation, leading to the CSP becoming an implicitly trusted stakeholder. Strictly speaking, the use of these solutions is rendered superfluous, as it is of the utmost importance to keep the infrastructure provider outside of the trust model and comply with the confidential computing paradigm.

## 5.5 Identification of Root Causes

Despite the promise of confidential computing to provide hardware-backed security guarantees for workloads running on untrusted cloud infrastructures, based on our findings, public cloud offerings are not capable of achieving this vision. Although the use of TEEs creates expectations of minimised trust dependencies, in practice, cloud providers retain significant control over key components of the system and its attestation. This discrepancy arises from various factors, including legal obligations, operational constraints, and economic incentives, which ultimately influence how the architectures of the offered solutions are being designed.

When it comes to legal obligations, government entities may exert pressure on cloud providers to grant access to customer data. For instance, under legal frameworks like the U.S. CLOUD Act [1], service providers can be compelled to disclose data stored on their servers, regardless of the data’s physical location. This is also applicable to public sector organisations that often operate under stringent compliance requirements concerning data sovereignty and privacy. While intended to enhance security and compliance, arrangements set to meet these requirements can introduce additional trust dependencies that deviate from the pure confidential computing paradigm. The shortfalls we have identified in this paper might also be rooted in some operational constraints where part of the TCB within the TEE, i.e. virtual firmware, cannot be provided by cloud customers because of technical reasons or lack of resources and necessarily falls under the responsibility of the cloud provider. This unavoidably comes with some additional caveats, including transparency of the code used, centralised control over it, and lack of flexibility towards the cloud customer.

Last but not least, in some use-case scenarios where multiple parties engage in collaborative computations, like anti-money laundering, collaborative drug development [43] or privacy-preserving machine learning [14], the primary concern often centres on protecting each entity’s proprietary data and code from other participants, rather than focussing on the cloud provider’s access. In such cases, the cloud provider is often considered a neutral party, and the emphasis is on ensuring that the collaborating entities cannot access each other’s sensitive information. Therefore, even though the parties involved in these computations are deeply concerned about certain security guarantees, their trust model does not necessarily exclude the cloud provider.

## 6 CONCLUSION

In this paper, we examined the confidential computing offerings of the three major CSPs, namely Azure, AWS, and GCP, focussing on VM-based execution contexts using AMD SEV-SNP and Intel TDX. Leveraging our proposed taxonomy, we analysed these solutions in terms of CVM setup and remote attestation. Our analysis revealed

		Microsoft Azure		AWS	Google Cloud	
		CVM	Container	CVM	CVM	CVM
<b>Platform</b>		SEV-SNP	SEV-SNP	SEV-SNP	SEV-SNP	TDX
<b>Direct Retrieval of Reports</b>		○	●	●	●	●
<b>Unique Target Identity</b>	Loading-time	○	○	○	○	●
	Runtime	●	●	●	●	●
<b>Attestable Metrics</b>	Policies	●	○	○	○	○
	Loading-time	○	○	●	○	○
	Runtime	●	○	○	○	●
<b>TCB</b>	Customisability	○	○	●	○	○
	Stakeholders	AMD, Azure	AMD, Azure	AMD, AWS	AMD, Google	Intel, Google

Legend: ● supported ○ supported with extended trust ○ not supported

**Table 1: Comparison of attestation in confidential computing offerings based on the developed taxonomy.**

significant gaps between the intended threat model and the realities of current implementations. In particular, the CSPs retain control over critical components of the TCB, including those responsible for remote attestation. Moreover, entities tasked with recording and reporting the TCB state are either unverifiable or exist outside the TEE, remaining under CSP control. Given that remote attestation is the cornerstone of trust in confidential computing, it is crucial to emphasise that the way cloud providers market these solutions may give customers a misleading sense of security regarding the confidentiality and integrity of their data.

### ACKNOWLEDGEMENT

This work has been partly funded by the German Federal Office for Information Security (BSI) project 6G-ReS (grant no. 01MO23013D), the Federal Ministry of Education and Research of Germany project 6G-CampuSens (project id. 16KISK205) as well as SEMECO-Q1 (grant no. 03ZU1210AA) and IPCEI-CIS (grant no. 13IPC005). Additionally, the authors are also financed based on the budget passed by the Saxonian State Parliament in Germany.

### REFERENCES

[1] 2018. CLOUD Act. [https://www.justice.gov/d9/pages/attachments/2019/04/09/cloud\\_act.pdf](https://www.justice.gov/d9/pages/attachments/2019/04/09/cloud_act.pdf).

[2] Advanced Micro Devices, Inc. 2023. Secure VM Service Module for SEV-SNP Guests. <https://www.amd.com/content/dam/amd/en/documents/epyc-technical-docs/specifications/58019.pdf>

[3] Advanced Micro Devices, Inc. 2023. *SEV Secure Nested Paging Firmware ABI Specification*. Technical Specification 56860. AMD. <https://www.amd.com/content/dam/amd/en/documents/epyc-technical-docs/specifications/56860.pdf> Accessed on February 02, 2025.

[4] Advanced Micro Devices, Inc. 2025. *AMD SEV-SNP: Strengthening VM Isolation with Integrity Protection and More*. White Paper. AMD. Accessed on February 02, 2025.

[5] Amazon Web Services, Inc. 2021. Confidential computing: an AWS perspective | Amazon Web Services. <https://aws.amazon.com/blogs/security/confidential-computing-an-aws-perspective>. [Online; accessed 28. Feb. 2025].

[6] Amazon Web Services, Inc. 2025. Nitro Enclaves. <https://aws.amazon.com/ec2/nitro/nitro-enclaves>. [Online; accessed 6. Feb. 2025].

[7] Amazon Web Services, Inc. 2025. NitroTPM for Amazon EC2 instances - Amazon Elastic Compute Cloud. <https://docs.aws.amazon.com/AWSEC2/latest/UserGuide/nitrotpm.html>. [Online; accessed 11. Feb. 2025].

[8] Amazon Web Services, Inc. 2025. uefi. <https://github.com/aws/uefi>. [Online; accessed 6. Feb. 2025].

[9] Amazon Web Services, Inc. 2025. uefi. <https://github.com/aws/uefi/blob/5c3ac896f6ea3923a96944dc23e808385939c0a1edk2-stable202211/0026-edk2-stable202211-OvmfPkg-PlatformPei-Initialize-variable-store-after-SEV.patch#L4>. [Online; accessed 20. Feb. 2025].

[10] Sergei Arnautov, Bohdan Trach, Franz Gregor, Thomas Knauth, Andre Martin, Christian Priebe, Joshua Lind, Divya Muthukumaran, Dan O’Keeffe, Mark L. Stillwell, David Goltzsche, Dave Evers, Rüdiger Kapitza, Peter Pietzuch, and Christof Fetzter. 2016. SCONE: Secure Linux Containers with Intel SGX. In *12th USENIX Symposium on Operating Systems Design and Implementation (OSDI 16)*. USENIX Association, Savannah, GA, 689–703. <https://www.usenix.org/conference/osdi16/technical-sessions/presentation/arnautov>

[11] Andrew Baumann, Marcus Peinado, and Galen Hunt. 2015. Shielding Applications from an Untrusted Cloud with Haven. *ACM Trans. Comput. Syst.* 33, 3, Article 8 (Aug. 2015), 26 pages. <https://doi.org/10.1145/2799647>

[12] Stefan Berger, Ram’ on C’aceres, Kenneth A. Goldman, Ronald Perez, Reiner Sailer, and Leendert van Doorn. 2006. vTPM: Virtualizing the Trusted Platform Module. In *USENIX Security Symposium*. <https://api.semanticscholar.org/CorpusID:17899967>

[13] Henk Birkholz, Dave Thaler, Michael Richardson, Ned Smith, and Wei Pan. 2023. Remote ATtestation procedureS (RATS) Architecture. RFC 9334. <https://doi.org/10.17487/RFC9334>

[14] Dan Bogdanov, Sven Laur, and Jan Willemsen. 2018. Real-World Applications of Secure Multi-Party Computation. *Cryptology ePrint Archive* (2018). <https://eprint.iacr.org/2018/450.pdf>

[15] Pau-Chen Cheng, Wojciech Ozga, Enrique Valdez, Salman Ahmed, Zhongshu Gu, Hani Jamjoom, Hubertus Franke, and James Bottomley. 2024. Intel TDX Demystified: A Top-Down Approach. *ACM Comput. Surv.* 56, 9, Article 238 (April 2024), 33 pages. <https://doi.org/10.1145/3652597>

[16] Google Cloud. 2025. Monitoring integrity on Shielded VMs. <https://cloud.google.com/compute/shielded-vm/docs/integrity-monitoring>. [Online; accessed 11. Feb. 2025].

[17] Google Cloud. 2025. Verify a Confidential VM instance’s firmware. <https://cloud.google.com/confidential-computing/confidential-vm/docs/verify-firmware>. [Online; accessed 11. Feb. 2025].

[18] Google Cloud. 2025. What is Shielded VM? <https://cloud.google.com/compute/shielded-vm/docs/shielded-vm>. [Online; accessed 11. Feb. 2025].

[19] Intel Corporation. 2014. *Intel Software Guard Extensions Programming Reference*. Technical Report 329298-002US. Intel Corporation. <https://www.intel.com/content/dam/develop/external/us/en/documents/329298-002-629101.pdf>

[20] Intel Corporation. 2023. *Intel® SGX Data Center Attestation Primitives (Intel® SGX DCAP)*. Technical Report 344991-004US. Intel Corporation. <https://www.intel.com/content/dam/develop/public/us/en/documents/intel-sgx-dcap-ecdsa-orientation.pdf>

[21] Decentriq. 2024. Swiss cheese to cheddar: securing AMD SEV-SNP early boot. <https://www.decentriq.com/article/swiss-cheese-to-cheddar-securing-amd-sev-snp-early-boot> Accessed on February 02, 2025.

[22] Enclave. 2025. Virtual Machine Privilege Levels | Confidential Computing 101. <https://docs.enclave.cloud/confidential-cloud/technology-in-depth/amd-sev/technology/fundamentals/features/virtual-machine-privilege-levels>. Accessed on February 02, 2025.

[23] Anna Galanou, Khushboo Bindlish, Luca Preibsch, Yvonne-Anne Pignolet, Christof Fetzter, and Rüdiger Kapitza. 2023. Trustworthy confidential virtual

- machines for the masses. In *Middleware 2023 - Proceedings of the 24th ACM/IFIP International Middleware Conference*. 316–328. <https://doi.org/10.1145/3590140.3629124>
- [24] Xinyang Ge, Hsuan-Chi Kuo, and Weidong Cui. 2022. Hecate: Lifting and shifting on-premises workloads to an untrusted cloud. In *Proceedings of the 2022 ACM SIGSAC Conference on Computer and Communications Security*. 1231–1242.
- [25] gematik. 2024. E-Rezept\_Feature-Dokumente. [https://gemspec.gematik.de/releases/E-Rezept\\_Feature-Dokumente/](https://gemspec.gematik.de/releases/E-Rezept_Feature-Dokumente/). [Online; accessed 27. Feb. 2025].
- [26] gematik. 2024. Prerelease: Dev\_HCC. [https://gemspec.gematik.de/prereleases/Dev\\_HCC/](https://gemspec.gematik.de/prereleases/Dev_HCC/). [Online; accessed 27. Feb. 2025].
- [27] gematik. 2025. Spezifikation Sektoraler Identity Provider. [https://gemspec.gematik.de/docs/gemSpec/gemSpec\\_IDP\\_Sek/latest/](https://gemspec.gematik.de/docs/gemSpec/gemSpec_IDP_Sek/latest/). [Online; accessed 27. Feb. 2025].
- [28] Google Cloud. 2025. Confidential Computing | Google Cloud. <https://cloud.google.com/security/products/confidential-computing?hl=en>. [Online; accessed 28. Feb. 2025].
- [29] Google Cloud. 2025. Create custom Confidential VM images. <https://cloud.google.com/confidential-computing/confidential-vm/docs/create-custom-confidential-vm-images>. [Online; accessed 10. Feb. 2025].
- [30] Google Cloud. 2025. Verify a Confidential VM instance’s firmware. <https://cloud.google.com/confidential-computing/confidential-vm/docs/verify-firmware#intel-tdx>. [Online; accessed 25. Feb. 2025].
- [31] Intel Corporation. 2023. *Intel® TDX Virtual Firmware Design Guide*. Technical Report 344991-004US. Intel Corporation. <https://cdrdv2-public.intel.com/733585/tdx-virtual-firmware-design-guide-rev-004-20231206.pdf>
- [32] Intel Corporation. 2024. Intel® Trust Domain Extensions (Intel® TDX). <https://www.intel.com/content/www/us/en/developer/tools/trust-domain-extensions/overview.html>. Accessed on February 02, 2025.
- [33] Intel Corporation. 2024. Intel® Trust Domain Extensions (Intel® TDX) - Documentation. <https://www.intel.com/content/www/us/en/developer/tools/trust-domain-extensions/documentation.html>. Accessed on February 02, 2025.
- [34] Intel Corporation. 2025. Intel TDX Enabling Guide. <https://cc-enabling.trustedservices.intel.com/intel-tdx-enabling-guide/01/introduction/>. Accessed on February 02, 2025.
- [35] Matthew A Johnson, Stavros Volos, Ken Gordon, Sean T Allen, Christoph M Wintersteiger, Sylvan Clebsch, John Starks, and Manuel Costa. 2024. Confidential Container Groups: Implementing confidential computing on Azure container instances. *Queue* 22, 2 (2024), 57–86.
- [36] Juniper Networks. 2020. What’s the Difference between Secure Boot and Measured Boot? <https://community.juniper.net/blogs/elevate-member/2020/12/22/whats-the-difference-between-secure-boot-and-measured-boot>
- [37] The kernel development community. 2025. dm-verity. <https://docs.kernel.org/admin-guide/device-mapper/verity.html>. [Online; accessed 21. Feb. 2025].
- [38] Arslan Khan, Joseph I. Choi, Dave Jing Tian, Tyler Ward, Kevin R. B. Butler, Patrick Traynor, John M. Shea, and Tan F. Wong. 2021. Privacy-Preserving Localization using Enclaves. In *2021 IEEE 12th Annual Ubiquitous Computing, Electronics & Mobile Communication Conference (UEMCON)*, 0269–0278. <https://doi.org/10.1109/UEMCON53757.2021.9666706>
- [39] Kevin Kollenda. 2022. *General overview of AMD SEV-SNP and Intel TDX*. Technical Report. Friedrich-Alexander-Universität Erlangen-Nürnberg. <https://sys.cs.fau.de/extern/lehre/ws22/akss/material/amd-sev-intel-tdx.pdf> Accessed on February 02, 2025.
- [40] Michael Larabel. 2023. The Linux SVSM project. *LWN.net* (January 2023). <https://lwn.net/Articles/921266/>
- [41] Mengyuan Li, Yuheng Yang, Guoxing Chen, Mengjia Yan, and Yinqian Zhang. 2024. Sok: Understanding design choices and pitfalls of trusted execution environments. In *Proceedings of the 19th ACM Asia Conference on Computer and Communications Security*. 1600–1616.
- [42] James Ménétrey, Christian Göttel, Anum Khurshid, Marcelo Pasin, Pascal Felber, Valerio Schiavoni, and Shahid Raza. 2022. Attestation mechanisms for trusted execution environments demystified. In *IFIP International Conference on Distributed Applications and Interoperable Systems*. Springer, 95–113.
- [43] Microsoft Azure. 2023. Common Azure confidential computing scenarios and use cases. <https://learn.microsoft.com/en-us/azure/confidential-computing/use-cases-scenarios>.
- [44] Microsoft Azure. 2024. Confidential containers on Azure. <https://learn.microsoft.com/en-us/azure/confidential-computing/confidential-containers>. [Online; accessed 12. Feb. 2025].
- [45] Microsoft Azure. 2024. Leverage virtual TPMs in Azure confidential VMs. <https://learn.microsoft.com/en-us/azure/confidential-computing/how-to-leverage-virtual-tpms-in-azure-confidential-vm>. [Online; accessed 25. Feb. 2025].
- [46] Microsoft Azure. 2025. Azure Confidential Computing – Protect Data In Use | Microsoft Azure. <https://azure.microsoft.com/en-us/solutions/confidential-compute>. [Online; accessed 28. Feb. 2025].
- [47] Microsoft Azure. 2025. Azure Confidential VM guest attestation design detail. <https://learn.microsoft.com/en-us/azure/confidential-computing/guest-attestation-confidential-virtual-machines-design>. [Online; accessed 10. Feb. 2025].
- [48] Microsoft Azure. 2025. Create an Azure confidential VM with ARM template. <https://learn.microsoft.com/en-us/azure/confidential-computing/quick-create-confidential-vm-arm>. [Online; accessed 6. Feb. 2025].
- [49] Fan Mo, Zahra Tarkhani, and Hamed Haddadi. 2024. Machine Learning with Confidential Computing: A Systematization of Knowledge. *ACM Comput. Surv.* 56, 11 (June 2024), 281:1–281:40. <https://doi.org/10.1145/3670007>
- [50] Kathleen Moriarty and Ned Smith. 2024. Remote Attestation Procedures IETF Working Group Overview and Engagement. [https://crypto.orange-labs.fr/acg/workshop/pdf/6-IETF-Remote\\_Attestation\\_Procedures\\_-\\_Attestation\\_Workshop-nms1.pdf](https://crypto.orange-labs.fr/acg/workshop/pdf/6-IETF-Remote_Attestation_Procedures_-_Attestation_Workshop-nms1.pdf)
- [51] Antonio Muñoz, Ruben Rios, Rodrigo Román, and Javier López. 2023. A survey on the (in) security of trusted execution environments. *Computers & Security* 129 (2023), 103180.
- [52] Arto Niemi, Sampo Sovio, and Jan-Erik Ekberg. 2022. Towards interoperable enclave attestation: Learnings from decades of academic work. In *2022 31st Conference of Open Innovations Association (FRUCT)*. IEEE, 189–200.
- [53] Hari Pulapaka. 2024. OpenHCL: Evolving Azure’s virtualization model. <https://techcommunity.microsoft.com/blog/windowsplatform/openhcl-evolving-azure%e2%80%99s-virtualization-model/4248345>.
- [54] Mohamed Sabt, Mohammed Achemlal, and Abdelmadjid Bouabdallah. 2015. Trusted execution environment: What it is, and what it is not. In *2015 IEEE Trustcom/BigDataSE/ISPA*, Vol. 1. IEEE, 57–64.
- [55] Gianluca Scopelliti, Christoph Baumann, and Jan Tobias Mühlberg. 2024. Understanding Trust Relationships in Cloud-Based Confidential Computing. In *2024 IEEE European Symposium on Security and Privacy Workshops (EuroS&PW)*. IEEE, 169–176.
- [56] Carlos Segarra, Ricard Delgado-Gonzalo, Mathieu Lemay, Pierre-Louis Aublin, Peter Pietzuch, and Valerio Schiavoni. 2019. Using Trusted Execution Environments for Secure Stream Processing of Medical Data. In *Distributed Applications and Interoperable Systems*, José Pereira and Laura Ricci (Eds.). Springer International Publishing, Cham, 91–107. [https://doi.org/10.1007/978-3-030-22496-7\\_6](https://doi.org/10.1007/978-3-030-22496-7_6)
- [57] Synergy Research Group. 2024. Cloud Market Growth Surge Continues in Q3 – Growth Rate Increases for the Fourth Consecutive Quarter | Synergy Research Group. <https://www.srgresearch.com/articles/cloud-market-growth-surge-continues-in-q3-growth-rate-increases-for-the-fourth-consecutive-quarter> [Online; accessed 13. Jan. 2025].
- [58] Technical University of Munich. 2025. *An Empirical Analysis of AMD SEV-SNP and Intel TDX*. Technical Report. TUM. <https://dse.in.tum.de/wp-content/uploads/2024/11/sigmetrics25summer-CVM-Explained.pdf> Accessed on February 02, 2025.
- [59] Trusted Computing Group. 2019. *Trusted Platform Module Library Specification, Family 2.0, Level 00, Revision 01.59*. Specification. Trusted Computing Group. <https://trustedcomputinggroup.org/resource/tpm-library-specification/>
- [60] Chia-Che Tsai, Donald E. Porter, and Mona Vij. 2017. Graphene-SGX: a practical library OS for unmodified applications on SGX. In *Proceedings of the 2017 USENIX Conference on Usenix Annual Technical Conference* (Santa Clara, CA, USA) (USENIX ATC ’17). USENIX Association, USA, 645–658.
- [61] Yuxin Ye, Wenhao Shi, Haibo Hu, Zhengyu Gu, Chengyu Qian, Zhi Wang, Xiang Qian, Huibo Xue, and Xinyu Zhang. 2022. Hecate: Lifting and Shifting On-Premises Workloads to an Untrusted Cloud. In *Proceedings of the 2022 ACM SIGSAC Conference on Computer and Communications Security*. 2775–2789. <https://doi.org/10.1145/3548606.3560592>