

# Resolvi: A Reference Architecture for Scalable and Interoperable Entity Resolution

Andrei Olar<sup>a</sup>

<sup>a</sup>*Mathematics and Computer Science Faculty, Babes-Bolyai University, Str. M. Kogalniceanu, nr. 1, 400084 Cluj-Napoca, Romania*

---

## Abstract

Entity resolution (ER) is a critical task in data management which identifies whether multiple records refer to the same real-world entity. Despite its significance across domains such as healthcare, finance, and machine learning, implementing effective ER systems remains challenging due to the abundance of methodologies and tools, leading to a paradox of choice for practitioners. This paper proposes Resolvi, a reference architecture which prioritizes extensibility, interoperability, and scalability in ER systems. By analyzing existing ER frameworks and literature, we establish a structured approach to designing ER solutions that address common challenges. Additionally, we explore best practices for system implementation and deployment strategies to facilitate large-scale entity resolution. Through this work, we aim to provide a foundational blueprint that assists researchers and practitioners in developing robust, scalable ER systems while reducing the complexity of architectural decisions.

---

## 1. Introduction

Entity resolution (abbrev. ER) is the task of determining whether multiple information records refer to the same real-world entity. Despite the straightforward definition, ER is supported by a vast field of research and has critical applications in domains such as healthcare [48, 57], finance [18], population censuses [58], and fraud detection [45]. It also plays a fundamental role in data integration, data cleaning, and machine learning pipeline preparation [11, 12, 51].

The terminology surrounding ER is diverse. It is commonly referred to as record linkage, deduplication, merge/purge, or entity matching [12, 51, 6]. In some contexts, it appears under the names entity alignment or named entity recognition and disambiguation (NERD) [56]. This terminological variation reflects the breadth and complexity of the field, creating challenges in unifying methodologies and system architectures.

Although ER has been extensively studied, existing literature primarily focuses on individual solutions, with generic systems being far less common. While

---

*Email address:* andrei.olar@ubbcluj.ro (Andrei Olar)

existing surveys [12, 51, 6] provide valuable overviews, they often contribute to the paradox of choice [62], as practitioners must navigate an overwhelming number of methodologies, tools, and frameworks. Each generic system promotes its own original design, contributing to choice overload. Notably, no reference architecture exists that systematically captures common design principles and implementation patterns for ER systems. The absence of such an architecture hinders standardization across ER implementations which, in turn, raises ER adoption costs.

This **paper introduces an ER reference architecture** that synthesizes insights from existing ER systems and literature to provide a structured foundation for ER system design. The research is guided by two primary questions:

**RQ1: What are the generic use cases of entity resolution systems, and how do these use cases inform the design of abstract components and processes commonly found in entity resolution architectures and implementations?**

**RQ2: Does the entity resolution problem admit a reference architecture, or are there boundaries past which generalization and abstraction lose their usefulness?**

The rest of the paper is organized as follows. Initially, the focus is on providing background information on related work and the reference architecture concept, quickly moving to establishing a standard vocabulary for ER concepts within the reference architecture and highlighting reference ER system implementations. Then, the narrative naturally veers towards generic requirements, use cases and logical components. The centerpiece of the paper is the attempt to describe the ER process at runtime in an abstract way, encompassing as many ER flavours as possible. This is followed by a discussion around design and implementation guidelines, deployment considerations, the feedback process for the reference architecture and the above research questions before concluding.

## 2. Background

### 2.1. Related Work

The idea to study generic architectural concepts in the sphere of ER was kindled by reading excellent reviews [12, 6, 72, 65, 37, 46] on the subject. These surveys provided valuable overviews of ER and an entry point to discover ER systems. The reference architecture itself was crafted by inspecting the source code of deduplication or record linkage systems [15, 10, 25, 40, 67, 46, 21, 35, 16, 36, 68, 23, 60], while entity alignment concepts were gathered from systems which are based on literature reviews [65, 72].

In the absence of a comprehensive review focusing on the disambiguation aspect of named entity recognition and disambiguation, several independent sources were studied to better understand the problem. The opinion that named entity disambiguation systems are designed very similarly to merge/purge systems is rooted in the NERD framework [56] itself, which implements a special ontology-based merge algorithm of extracted named entities. FOX [64] uses

building blocks which are prevalent in record linkage systems, too (e.g indexing components, external knowledge bases). Modern systems such as Ensemble Nerd [9] use separate black box subsystems (in this case neural networks) to perform feature extraction and matching, similarly to Ditto [35]. Finally, to the best of our knowledge there is no dispute over the need to extract structured information from unstructured text across the named entity recognition literature.

To construct a viable reference architecture, examples of existing reference architectures [54, 43] as well as reference architecture frameworks [2, 47] and studies [13, 20] were consulted. Ideas such as documenting patterns and joining business and technical contexts in a reference architecture were inspired by the Rational Unified Process (RUP) [34]. The existence of multiple perspectives over the same rough generic concepts was inspired by the 4+1 View Model [33], also used in RUP. Lastly, UML 2.5 [14] was used in most figures in order to adhere to a standard visual communication framework.

## 2.2. The Reference Architecture Concept

We begin by defining what constitutes a reference architecture. One perspective describes it as *capturing the essence of existing architectures, and the vision of future needs and evolution to provide guidance to assist in developing new system architectures* [13]. Another definition emphasizes *an abstraction of software elements, together with the main responsibilities and interactions of such elements, capturing the essentials of existing software systems in a domain and serving as a guide for the architectural design of new software systems (or versions of them) in the domain* [20]. Both definitions highlight the dual purpose of reference architectures: synthesizing existing knowledge and offering structured guidance for future developments.

In practice, reference architectures consolidate architectural knowledge and best practices, ensuring systematic reuse and providing a standardized blueprint for system design [13, 20]. Beyond their conceptual role, they offer concrete benefits, particularly in standardization, where they establish common terminology, models, structures and processes. Existing systems serve as examples, illustrating how abstract architectural concepts manifest in practice.

To enhance clarity and consistency, a standard design language is usually adopted to represent architectural components. In crafting this reference architecture the 4+1 view model [33] was adapted to provide multiple points of view over abstract concepts. Relevant design patterns [19] to the target domain and implementation best practices were identified.

Reference architectures evolve through structured methodologies, incorporating empirical insights based on collaboration to enhance maturity and adoption [20]. Several frameworks (e.g., [2, 47]) exist to support the development of reference architectures, providing methodological guidance. Their usefulness to the reader lies in how they categorize reference architectures. For instance, the current reference architecture is a “Type 3” architecture according to [2]. It was derived from observations made on existing ER systems and may be used only to facilitate creating new system architectures or to align existing architectures.

### 2.3. ER Vocabulary

One of the important functions of a reference architecture is to establish common ground through the standardization of terminology in the target domain. The terminology used in entity resolution literature is often confusing. For instance, papers by the same authors use different terminology to describe the same concept (e.g “description” [12] and “entity profile” [52]). Table 1 provides a definition list containing the terms used in this reference architecture as they relate to the ER problem.

Table 1: Entity resolution terminology.

Term	Definition
data source	a source of information which contains data that potentially refer to a real-world object
information record	a discrete chunk of information from a data source
record	<i>information record</i>
data record	<i>information record</i>
extraction trait	data extraction algorithm that can process information records in a relevant way for entity resolution
entity reference	potential reference to a real-world object (typically obtained from a single data source using a selection of extraction traits)
entity profile	representation of a real-world object based on information from the available data sources (typically obtained from multiple entity references)
entity	a real-world object

The reference architecture describes two aspects of ER systems. More commonly, ER is a process which outputs entity profiles based on entity references from input data sources. This process is referred to as the ER *runtime*. A second equally common aspect of ER systems involves configuring the ER runtime and evaluating the performance of ER. This constitutes the *design time* aspect of an entity resolution system.

### 2.4. Reference ER Systems

As already established, ER has many flavours with names that reflect specific modi operandi. Some flavours can often be melded into a single, more dominant flavour. For instance, deduplication can be viewed as an instantiation of merge/purge. In turn, the merge/purge problem can be viewed a special

case of record linkage where the record linkage process mandatorily ends with the specific action of merging linked entity references in-place in entity profiles instead of allowing an open course of actions for dealing with the linked entity references. Lastly, even though it is sometimes described as a mere step in the ER runtime [67, 53, 23], we consider “entity matching” to be a particular ER flavour (record linkage flavour, to be exact) where the final entity profiles are not obtained as a result of clustering linked entity references.

Having this in mind, the reference architecture focuses on record linkage systems because of its seeming centrality to the ER problem. It is also the most studied ER flavour, with the longest history, going back more than half a century [48, 17].

Other ER flavours follow the outline of the record linkage runtime process, too. Even though the implementation details are different, entity alignment or NERD systems can be implemented using similar design concepts. The departure from record linkage seems to be the most pronounced in the case of entity alignment which operates on knowledge graphs [65, 72]. This reference architecture will do its best to supplant the divergences specific to entity alignment with suggestions on how to adhere to its generic abstract outlook. On the other hand, most of the abstractions described in the reference architecture should be applicable to designing NERD systems with only minor changes.

The following principle guides the selection process for reference ER systems: “proven architectures of past and existing products are transformed in a reference architecture” [13]. To increase the reference architecture’s verifiability, only systems which meet the following criteria were taken into account:

- code inspection availability;
- end-to-end (E2E) entity resolution implementation;
- actively maintained.

The large number of candidate ER systems remaining applying the above criteria prompted filtering the remaining systems based on their implementation of key aspects were of particular subjective interest. The final selection is available in Table 2.

Systems that were not open source [70] at the time of writing and ones that did not seem to be actively maintained [10] were also evaluated via peer reviewed articles published about them. Other systems stood out, but were architecturally very similar to one or more of the reference ER systems. This includes systems like the Silk Framework [25], Zingg [68], OYSTER [67], FastLink [16], Dedupe [23] or RecordLinkage [15] all of which have a runtime design which is very similar to the JedAI Toolkit [53].

Our review of the existing ER systems yielded some preliminary observations. Active learning solutions seemed to be prevalent at design time [23, 68]. Most of the systems we surveyed were able to provide some means to evaluate ER quality. Our subjective preference for ER systems which automate design

Table 2: Systems that implement entity resolution. Each system was chosen for highlighting a key aspect.

Name	Technology	Key Aspect
ditto [35] + Magellan [30]	Python	Pre-trained Neural Networks
deepmatcher [46]	Python	Neural Network Architecture
Duke	JVM	Automated Rule Configuration
JedAI Toolkit [53]	JVM	Core Pipeline Architecture
FAMER [60]	JVM	Distributed Graph Linkage Incremental ER
Splink [36]	JVM	Distributed Probabilistic Linkage
d-blink [40]	Python	Probabilistic Clustering

time choices promoted Duke [21] to our list of reference systems due to its genetic algorithm which determines optimal record linkage configurations without user participation.

Performance and scalability are common cross-cutting concerns brought up in the ER space [51]. This led to promoting d-blink [40], Splink [36] and FAMER [60] as reference systems because they were designed on top of generic runtimes designed for distributed computing.

Most of the extensibility built into existing systems focuses on the key aspects of ER (matching, clustering, data preprocessing). The Magellan [30] framework for entity matching is extensible in a completely different way: it allows using matching components such as Ditto [35] or replacing the entire rule-based ER runtime with a full neural network architecture designed for ER such as DeepMatcher [46]. This emphasizes the higher extensibility of ER systems with a framework design.

### 3. ER Requirements

The architecture of software systems is linked to both the business context and the technical context [13, 2] of the problem they attempt to solve. The requirements related to the business context constitute the *problem domain* [55]. The technical context is typically composed from the system requirements which define the system’s capabilities, also known as *architectural characteristics* [55].

#### 3.1. Business Requirements

Part of the reason for creating a reference architecture is to identify goals that all system architectures implementing the reference architecture will adhere to. In the case of entity resolution, there are requirements which determine whether a system performs entity resolution or some other task.

The first such requirement is determining whether multiple information refer to the same *real world object*. With the risk of stating the obvious, this entails

that the system should discern what a real world object is. Human assistance in this regard is arguably required at this point in our technological development. It logically follows that completely unsupervised entity resolution solutions are more unreliable than supervised ones. Consequently, *humans should at least be allowed in the loop at design time.*

The second requirement that results directly from the definition of ER is to return *all* references to the same real world object from the presented input data. This requirement entails that the presented output is necessarily either a single entity reference or the result of a merge operation between multiple references. In this context, the variability of the output over time in contrast with the stability of the resolved real-world object is highlighted [70]. Taking the idea a step further, the *entity profiles resolved today might be used as entity references tomorrow.* Allowing extension in this regard could be beneficial.

Users might want to inspect all entity profiles resulting from a single scan of multiple data sources. This is known as **batch ER** [12]. The alternative is to feed the ER system information one record at a time. Entity profiles which refer to the same entity are retrieved progressively with each input information record. This is known as **incremental ER** [24]. *ER systems may implement one or both variants.*

### 3.2. Architectural Characteristics

Just as business requirements dictate whether a system performs entity resolution, certain architectural characteristics are universally required for systems that execute end-to-end entity resolution.

ER is a highly polymorphic task with a huge number of applications. Among the top priorities when implementing any such system is its **extensibility**. Extensibility is exhibited to various degrees in practice today. Perhaps the most important reason for making extensibility the top priority of this reference architecture is the variability of implementation choices made by the existing ER systems. Whether discussing a customizable number of data sources [60, 53] or the ability to completely replace the core runtime logic [30, 46], ER systems today are nothing if not flexible. The technological diversity ranging from systems using SQL [36] to ones using advanced neural networks [35] is another reason for the reference architecture to prioritize extensibility. This prioritization necessarily entails a higher degree of generalization and abstraction.

ER is valuable standalone or as part of a more complex process. Therefore, the best ER systems will be highly interoperable either by supporting many data contracts or by using widely adopted technologies and data formats. **Interoperability** is an obvious concern to some of the inspected reference systems [53, 21, 60, 36]. Because the reference architecture values interoperability, the concepts and recommendations presented favour the adoption of frameworks or standards wherever possible.

Basic ER implementations that rely on similarities between entity references have a minimum time complexity of  $\mathcal{O}(n^2)$  [12] where  $n$  is the total number of entity references available to the system. The high complexity coupled with the

need to process large amounts of data makes performance and scalability indispensable architectural characteristics of any modern ER system. **Performance** is the ability of a system to use the available hardware resources efficiently [55] (i.e the system does not waste computations). **Scalability** is the ability of a system to use hardware resources effectively as the demand on the system increases [55] (e.g the system is able to access more resources as it receives more input). As a consequence of valuing performance and scalability, the reference architecture insists on aspects which promote these qualities, such as blocking, filtering, parallel execution or distributed computation.

#### 4. ER Use Cases

It is important to distinguish the problem domain of specific ER systems from generic use cases which apply to all ER systems. This section goes over three collections of use cases that are present in all of the reference ER systems. Each collection is represented with a use case diagram. Use case diagrams are a type of UML diagram used to represent the dynamic aspect [8] of a system.

##### 4.1. Roles

Use cases are linked to actors who fulfill certain roles. **End users** are regular users who want to run ER jobs to assemble entity profiles. **Administrators** are members of staff who set up the ER system and have a basic understanding of ER. This role may correspond to real-world roles such as “data engineer”, “system administrator” or “data scientist”. **Developers** create new functionality that is connected to ER. They may assist administrators in setting up the functionality that they developed. This role may correspond to real-world “software engineer”, “data engineer”, “data scientist” or “machine learning engineer” roles.

The generic use cases are presented under the assumption of a multi-user organisation. This choice is justified by the high costs of running ER and the need to involve multiple people in the setup process. Note that there is no assumption about authentication or, indeed, security in general because these concerns vary with the problem domain.

##### 4.2. Entity Resolution Runtime

Figure 1 shows the collection of use cases associated with the ER *runtime*. All existing systems implement core ER use cases such as supplying the system with input data, configuring parameters, running ER and allowing inspection of entity profiles.

Even though existing systems prioritized enabling zero-configuration entity resolution, the option to run ER irrespective of the dataset is not yet available. Currently the best choice is between a careful selection of dataset features relevant for entity resolution [36] or using active learning [27, 28]. Genetic programming [21] offers additional hope for reducing user involvement in ER process parametrization.

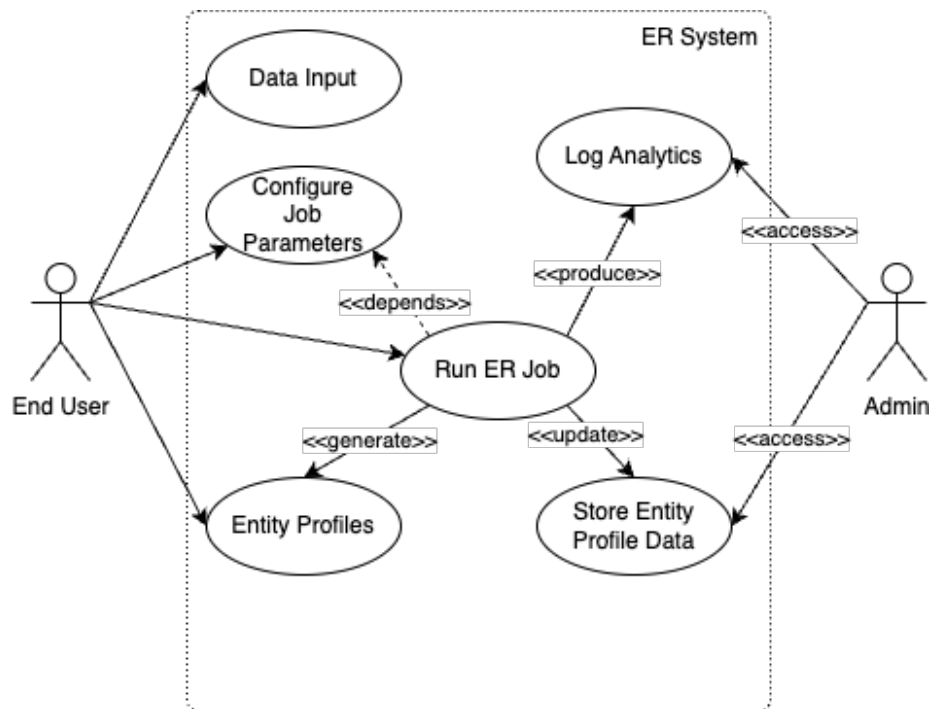

Figure 1: At runtime several use cases of the ER system are accessed by end users and admins. The “runtime” is detailed in Subsection 4.2.

Some ER systems store entity references and entity profiles for later use. Storing the state is particularly important for performing progressive ER [60, 53, 21] or to preserve stable identifiers across time for entity profiles [70].

System architectures should center the design of their runtime around end users. Additional system use cases such as storing a runtime state should be designed with administrators in mind, too. It is strongly recommended that systems architectures focus on performance monitoring as well as other analysis and observability mechanisms which facilitate understanding the ER runtime. These mechanisms are particularly important to administrators.

#### 4.3. System Configuration

Configuration is performed on three levels in an ER system: ER runtime parameters, runtime customization and system configuration. The first level which addresses parameterizing the ER runtime has already been described in Subsection 4.2. Figure 2 shows the use cases connected to the other two levels.

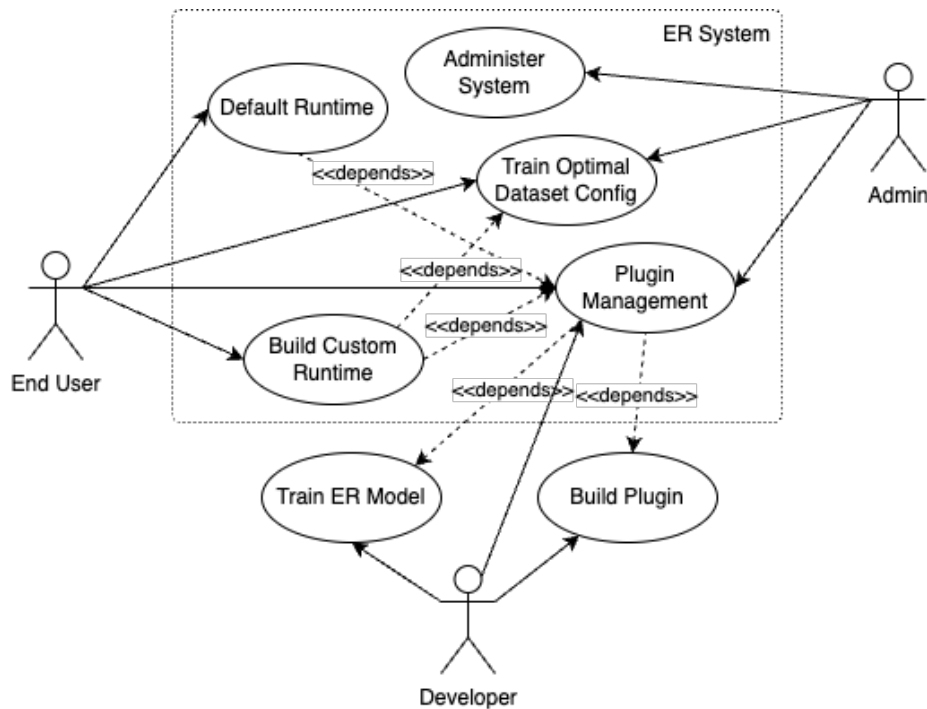

Figure 2: ER system configuration from Subsection 4.3. Building custom runtimes and choosing a default runtime are interesting to the end user. Administering the system and its plugins falls unto the administration personnel. Developing plugins and training ER models is a task for developers.

In existing systems, the end user can customize the runtime itself by choosing a default runtime [36, 60] or even building one from existing components exposed

by the system [25, 53]. Another runtime customization is the ability to train a configuration optimised for a specific dataset either via active learning [68] or genetic algorithms [21]. This configuration can then be attached to many ER runtime executions. This approach stands in contrast to building the optimal configuration at runtime through unsupervised learning [36]. In that case a runtime configuration of the data record attributes that are relevant in ER is sufficient.

System configuration is exhibited in existing ER systems through plugin management for some (DeepMatcher [46] can use Magellan [30] for entity reference extraction) or for all of the ER runtime components (both FAMER [60] and JedAI [53] allow extending almost all components used at runtime). Some systems are designed as applications to be used by end users. JedAI [67] and FAMER [60] are in this category. These systems typically implement a runtime paradigm ((rule-based or graph-based, respectively)) which cannot be changed through configuration. In contrast, systems may be designed as frameworks [25, 30], enabling the configuration of the runtime architecture itself. The DeepMatcher design [46] allows using neural networks throughout the entire runtime or only a part of it by allowing the ER application developers to replace the way embeddings are generated, for example. This reference architecture favours framework design because it is more extensible. ER system designs should allow swapping out some or all runtime components at design time without changing the underlying abstractions presented within this reference architecture.

Specific ER system architectures should involve *administrators* in most configuration use cases. This recommendation assumes that administrators are better prepared on security and configuration topics than end users and that in practice they usually have broader access to the system than developers. *Developers* also play a role in the design of the ER runtime. They may train machine learning models or implement plugins that perform various ER tasks such as matching, clustering or data ingestion. These models and plugins are visible to end users through configuration. Developers may register and unregister the models and plugins they author. They also typically maintain plugin implementations and models.

Plugin management may be performed by all three roles: administrators, end users and developers. End users might focus on choosing the plugins they need to configure custom runtimes, whereas developers would focus on managing their own plugins. Finally, administrators could enforce system-wide rules for using plugins. A system architecture that allows external developer involvement (through plugin management or otherwise), may be desirable. However, it raises many potential concerns, primarily from the sphere of data privacy and security. Careful consideration must be offered when designing solutions with this level of extensibility.

We saw that configuration can occur at three levels: parametrization, runtime configuration, and system configuration. The configuration of an ER system depends on its technical goal, problem domain, and technology context. This limits the reference architecture, as no universal recommendations or abstractions apply solely to ER systems. The best approach is to follow established

design principles and best practices when defining logical components and the configuration processes. Throughout the remainder of this paper we will not insist on the configuration of ER systems.

#### 4.4. Entity Resolution Evaluation

ER evaluation is described in literature in terms of both the performance [63, 52] and the quality [66, 32, 42, 39] of ER. Additionally, standalone libraries for computing ER metrics [4, 49] and systems for comparing evaluation reports [31] were developed. Although ER evaluation methods rely on ground truth information supplied by end users or administrators, there are approaches which discuss evaluation statistics that work even in the absence of a benchmark dataset [5]. This interest is driven by the desire to reduce the labeling effort which accompanies the creation of a relevant evaluation dataset [41, 5]. Figure 3 shows the use cases surrounding the evaluation of ER.

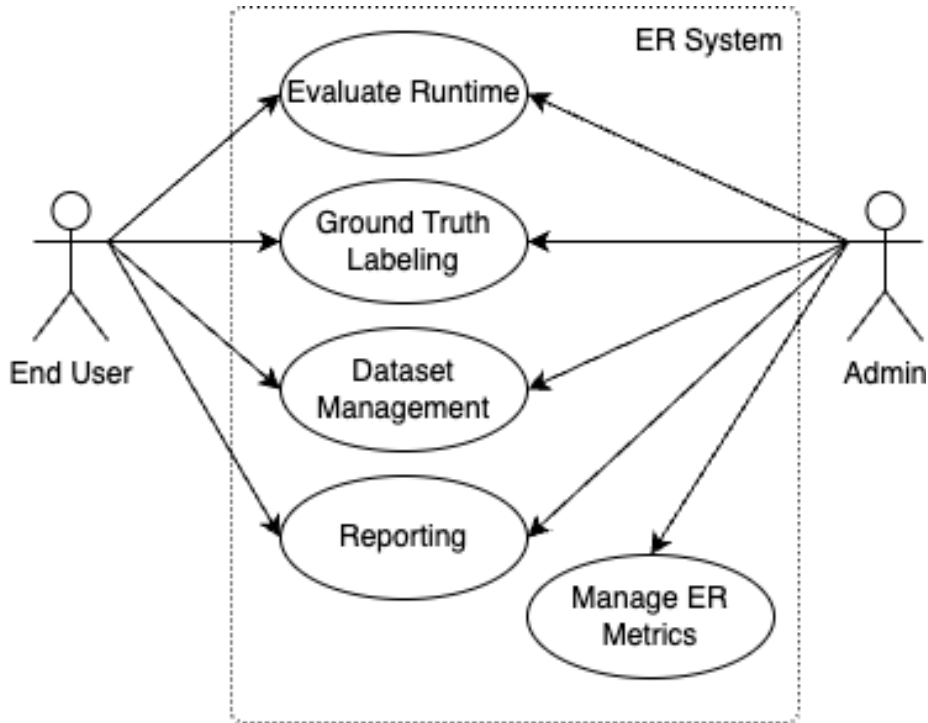

Figure 3: ER system configuration from Subsection 4.4. Building custom runtimes and choosing a default runtime are interesting to the end user. Administering the system and its plugins falls unto the administration personnel. Developing plugins and training ER models is a task for developers.

Existing systems allow end users to label comparison results as true or false positives (known as ground truth labeling) in active learning scenarios [23, 68].

Other systems [67, 53] use the same labeling mechanism to create and manage benchmark datasets for specific problem domains. All reference systems allow evaluating the ER runtime, and consulting the evaluation results in reports. Benchmark datasets are usually provided by the system, but the ability to manage them varies even between the reference systems with some [53] being more proficient than others [21].

In our view, end users would use the ER system to evaluate the ER runtime, label ground truth data, manage benchmark datasets or view ER evaluation reports. Administrators would use the system similarly to users, with an added ability to configure the available metrics for evaluating the ER runtime.

System architectures derived from this reference should incorporate ER evaluation use cases. In terms of a recommended logical or procedural approach, there is none. The reason behind this is that ER systems may be evaluated on design time or at runtime. Depending on the above choice, evaluation can be very simple (similar to what all existing systems implement today) or very complex (real-time monitoring of the results, for example). While ER evaluation design is important, it is adjacent to ER runtime design. Furthermore, reference implementations of ER evaluation systems which focus on the real-time evaluation of ER at runtime are missing, to the best of our knowledge. Throughout the remainder of this paper we will not dive deeper into topics related to ER evaluation, leaving that expansion on this paper as future work.

## 5. ER Logical Components

This section focuses on highly abstract and generic logical components of the ER runtime. The configuration and evaluation use cases can be designed by using generic principles and, because of the multitude of choices, there do not seem to be standard abstractions or design patterns which apply to the ER problem in ways that should be highlighted.

Reference architectures are used to evidentiate design patterns [2] and the **natural structuring of the ER runtime as a pipeline** is a key observation in this regard. All reference ER systems exhibit pipeline structures even though the specific details of each implementation vary widely. The main components of the ER pipeline exhibited in the reference systems' designs correspond to existing literature on the subject [12]: input data processor, comparison preparation, matching engine, clustering engine, and entity profile presentation layer.

The pipeline design pattern is a well-established concept in both literature and practice [69, 38]. It structures computation as a sequence of processing components, where each component receives input, transforms it, and passes the output to the next stage in the pipeline. This design pattern promotes modularity, configurability, and scalability, allowing each component to operate independently and process data as soon as it becomes available [69]. The pipeline structure closely mirrors neural network architectures, where layers sequentially process and refine representations. Prior work has successfully lever-

aged this structure for neural network-based ER systems [46], since ER similarly involves sequential transformations of data.

Unlike the traditional pipeline design, which enforces a rigid sequence of execution [69], the existing reference systems exhibit a more flexible version of the pipeline design, closer in kind to the State-based pipeline model [38]. System architectures may determine which components of the pipeline are applicable to their specific problem domain and system constraints. This flexibility supports various pipeline types—classic, neural network-based, progressive, or hybrid—allowing each implementation to define its own components and execution logic.

### 5.1. Information Flow

The pipeline nature of entity resolution (ER) becomes evident when analysing its information flow at an abstract level. Figure 4 illustrates the runtime information flow for that which is termed *batch ER* in literature [12].

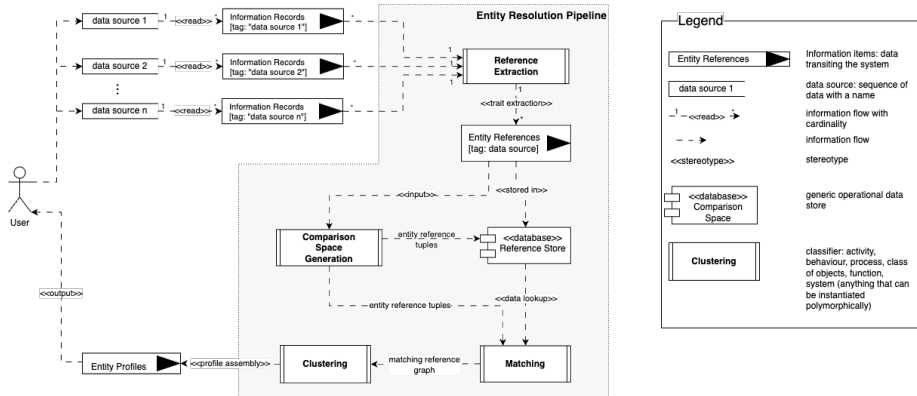

Figure 4: Batch entity resolution information flow at runtime, as described in Subsection 5.1.

In batch ER, input data consists of multiple data sources containing information records, typically provided by the end user. The representation of these records varies by source type and often requires dedicated adapters, as seen in existing implementations [53, 21, 25, 60]. Some systems support streaming data sources [60], effectively removing the upper bound on the number of processable records.

This lack of an upper bound can lead to performing what is known as *incremental ER* [24, 12]. It differs from batch ER in two key aspects: the requirement for maintaining a runtime state and the continuous ingestion of input data rather than batch processing. Continuous ingestion also introduces the possibility of supporting certain architecture styles better (e.g service oriented architecture, event driven architecture).

Due to these runtime differences, incremental ER systems are typically implemented as long-lived processes, whereas batch ER solutions are commonly

discrete jobs. However, this distinction does not preclude leveraging established distributed processing frameworks, such as Apache Spark [36] or Flink [60], to manage long-running processes capable of handling multiple parallel requests. In the context of incremental ER, Figure 5 highlights the differences at the individual ER job level, assuming a long-running process designed to handle concurrent requests.

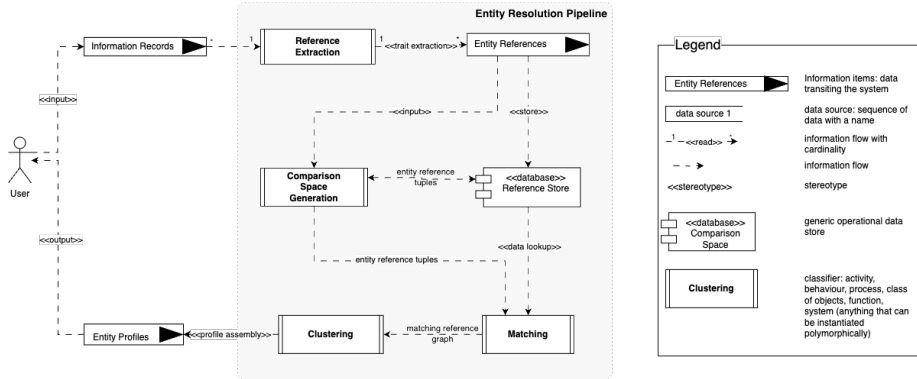

Figure 5: Incremental ER information flow at runtime, as described in Subsection 5.1.

System	Incremental	Batch	Source Code
ditto [35] + Magellan [30]	✗	✓	ditto.run_all_er_magellan
deepmatcher [46]	✗	✓	deepmatcher.runner
Duke	✓	✓	duke.Duke duke.server
JedAI Toolkit [53]	✗	✓	jedai.workflowbuilder
FAMER [60]	✓	✓	FamerConfiguration IncrementalConfiguration
Splink [36]	✗	✓	internals.database_api internals.linker
d-blink [40]	✗	✓	dblink.Run

Table 3: Incremental and batch capability of the reference ER systems.

Regardless of specific implementation details, entity resolution fundamentally follows a pipeline model, transforming input records into structured entity profiles. According to the original pipeline design pattern, the most effective approach to pipeline construction is component-based design. Figure 6 illustrates key top-level abstractions common to all reference ER systems, though they may appear in different forms in practice. The diagram emphasizes the diversity of input sources and the various ways output data can be represented. Additionally, it serves as a reminder that pipeline components primarily process

entity references and entity profiles. This characteristic structure of the ER pipeline enhances system comprehensibility, particularly for newcomers. The key takeaway is that once entity references have been determined within each data source, they can be processed iteratively to generate entity profiles in the desired format using a series of pipeline components.

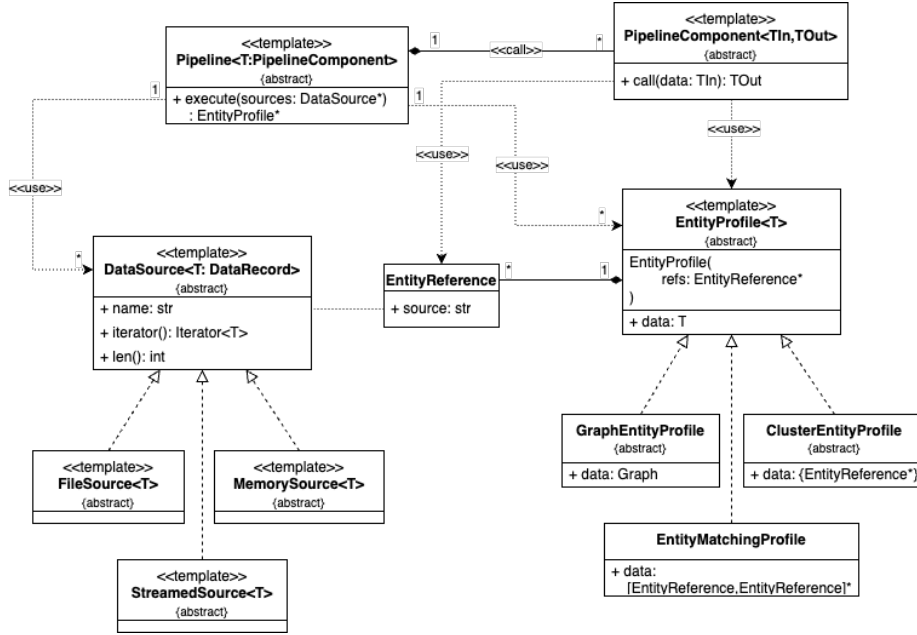

Figure 6: Top level ER abstractions which set the framework for ER, as described in Sub-section 5.1.

The following subsections provide more detailed descriptions for key pipeline components from Figures 4 and 5.

### 5.2. Entity Reference Extraction

Information in an ER system undergoes a series of transformations, the first of which is arguably the most impactful, as it standardizes input across diverse data sources. This process, sometimes referred to as data cleaning [12, 52, 40], is known here as entity reference extraction and is responsible for converting raw information records into structured entity references.

Broadly, entity reference extraction follows two dominant paradigms. Some systems favor extracting vectors from the input information, producing numerical representations suitable for training or integrating with neural networks. More traditionally, the extracted information is structured into objects with attributes. Note that such objects include node vertices, mapping types or columnar storage data types (e.g. dataframes). Table 5.2 shows this entity reference extraction categorization for our selection reference systems.

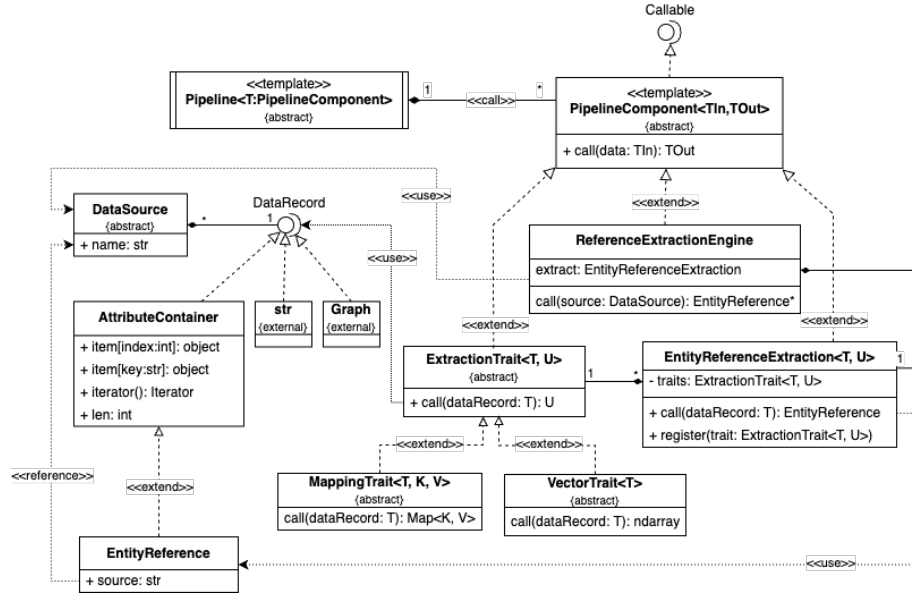

Figure 7: The entity reference extraction subsystem, described in Subsection 5.2, consists of multiple logical components that transform any type of input into a structured collection of entity references.

System	Representation	Source Code
ditto [35] + Magellan [30]	Attributes	py_entitymatching.io ditto_light.dataset ditto_light.augmenter
deepmatcher [46]	Attributes, Vectors, Hybrid	py_entitymatching.io attr_summarizers
Duke	Attributes N-Triples	datasources LuceneDatabase
JedAI Toolkit [53]	Attributes	jedai.datareader jedai.datamodel
FAMER [60]	Graph Vertices	famer.preprocessing.io
Splink [36]	Attributes	splink.internals.database_api splink.internals.splink_dataframe
d-blink [40]	Attributes	dblink.Project

Table 4: Entity reference extraction (described in Subsection 5.2) implementations in the reference systems.

Outside of our selection of reference ER systems, a particularly interesting case of attribute-based extraction arises in Named Entity Recognition and Disambiguation (NERD) systems. Frameworks such as spaCy [44] and NLTK [7] extract named entities from unstructured text while also providing associated attributes. This structured output makes NERD-derived data structuring similar to that used in classical record linkage tasks.

In the case of entity alignment the extracted data is structured as a knowledge graph [72]. Unlike graph-based record linkage implemented by FAMER[60], which primarily stores similarity relationships between entity references, entity alignment operates over knowledge graphs, identifying correspondences across different graphs. While both methods generate graph representations, their treatment in the ER pipeline differs: entity alignment constructs separate knowledge graphs per each data source, whereas graph-based record linkage represents each entity reference as a vertex, integrating all references into a single logical graph. This divergence from the typical record linkage logic must first be addressed by entity alignment system architectures in the entity reference extraction component.

Much of the terminology introduced in earlier sections of this reference architecture is rooted in entity reference extraction. Figure 7 outlines general abstractions derived from all reference ER systems. While implementation details vary, every reference system includes an extraction engine which orchestrates data retrieval and transformation into an internal representation. The specifics of this format are left open and differ widely in practice.

Entity reference extraction may rely on abstractions we refer to as extraction traits. These are flexible, extensible algorithms that define the format, function, and meaning of extracted data. Traits can be simple, extracting fundamental data types like floating-point numbers or keywords (e.g `dblink.Project` CSV parsing), or compound, combining multiple traits (e.g `ditto.light.augment` module which allows performing several chained operations on the data). The main purpose of extraction traits is to adapt data representations to internal ones. Making extraction traits part of an ER system’s architecture allows tailoring its data ingestion to various use cases while maintaining a consistent pipeline for downstream ER tasks.

Despite methodological differences, all approaches ultimately produce an instance of an internal data structure specific to each ER system. The instance produced by an assortment of extraction traits is referred to as an entity reference. The data structure useful in ER contains one or more entity references. An admitted limitation of the reference architecture is the inability to specify which data structure is most suitable. This limitation stems from the multiple available options, the choice between which is driven by the ER model choice. For example, in record linkage scenarios we might use an algebraic set whereas entity alignment requires using knowledge graphs.

Multiple design patterns are often evidenced in extraction trait design, with the result being most frequently recognized as adapters, builders or composite objects [19]. Designing families of extraction traits might also be of interest because of technology constraints (e.g multiple data source types). Such

designs are often recognized as abstract factories [19].

Once entity references have been extracted, they serve as the foundation for subsequent ER phases, ensuring that all downstream transformations operate on a consistent representation of input data.

### 5.3. Comparison Space Generator

The computational complexity of entity resolution (ER) scales quadratically with the total number of entity references in the system, as every entity reference must be compared to every other. In incremental ER, this issue appears mitigated due to the asymmetry between the input record size and the internal entity reference database. However, Simonini et al. [63] emphasize that incremental ER must be fast and cannot afford exhaustive matching across an entire large database. Instead, it relies on blocking and neighborhood indexing to restrict comparisons to a small, relevant subset of records. The methods introduced in their work (PSN, PBS, PPS) prioritize comparisons efficiently, ensuring that entity clusters form incrementally without requiring exhaustive pairwise matching.

Another observation on existing systems is that a reliance on both matching and clustering is not necessary for performing ER. Alternatives exist which bypass either matching[40] or clustering[46]. One might assume that omitting the traditional matching step removes the need to constrain the number of comparisons. However, the fundamental challenge of a quadratic comparison space remains in all cases, as pointed out by previous literature reviews [52].

Figure 8 should be regarded as a straw man which highlights key mechanisms for controlling the comparison space within the ER runtime. Methods such as blocking, indexing, and filtering serve to reduce the number of comparisons that must be performed further in the ER pipeline.

System	B	I	F	Source Code
ditto [35] + Magellan [30]	✓	✗	✗	<code>py_entitymatching.blocker</code>
deepmatcher [46]	✓	✗	✗	<code>py_entitymatching.blocker</code>
Duke	✓	✓	✗	<code>AbstractBlockingDatabase</code> <code>LuceneDatabase</code>
JedAI Toolkit [53]	✓	✓	✓	<code>jedai.blockbuilding</code> <code>jedai.blockprocessing</code>
FAMER [60]	✓	✗	✓	<code>famer.linking.blocking</code> <code>linking.selection</code>
Splink [36]	✓	✗	✗	<code>splink.internals.blocking</code>
d-blink [40]	✗	✓	✗	<code>dblink.partitioning</code>

Table 5: Comparison space generation techniques supported by the reference systems. **B** stands for *blocking*, **I** stands for *indexing* and **F** stands for comparison *filtering*.

Blocking, indexing and filtering are collectively referred to as comparison space generation methods from here on. Table 5.3 lists how each of the reference systems handles comparison space generation.

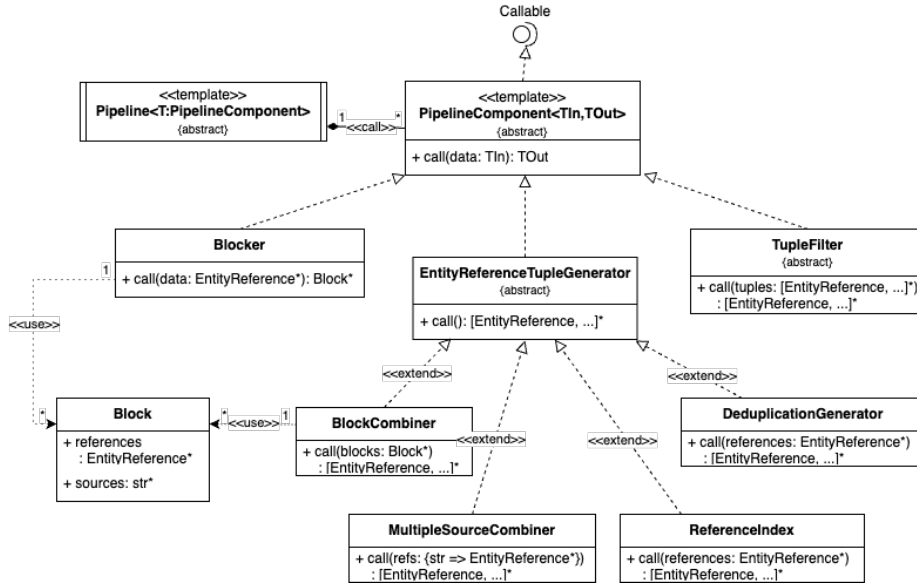

Figure 8: Comparison space generation yields collection of entity references through various methods such as blocking and indexing, described in Subsection 5.3.

As with entity reference extraction, there is a limit to the amount of details that can be specified in the reference architecture. For example, while tempting to imagine modelling comparison space generation methods using a coherent unitary contract, this is not necessarily possible. The JedAI system provides a good example in this regard. Its `org.scify.jedai.blockprocessing` package defines several filtering and indexing implementations which expect as input the output of a blocking operation. Therefore, detailing the design of individual comparison space generators does not seem wise.

On the other hand, it is common in practice for pairs of entity references to be output by the comparison generation subsystem. This can be seen in practice across all reference systems, including FAMER (which outputs pairs of graph vertices). However, in Figure 8 we envision the possibility that multiple entity references participate in subsequent comparisons. The reference architecture is suitable for models which generalize ER matching to this effect [59] because of this. This provides an extension point for using such models.

Finally, implementing system architectures may wish to allow storing the comparison space in a dedicated reference store to reduce the running time of subsequent resolutions over the same data or to support incremental ER.

#### 5.4. Matching Engine

The vast majority of the reference ER systems we examined include a matching subsystem as part of their batch ER pipelines. The matching engine represents a black-box component, and there are two key reasons for this.

Existing ER systems employ a range of matching approaches, including probabilistic matching[36], deterministic rule-based matching[53], neural network-based matching[46, 35], and graph-based methods[60]. Each of these models expects different input formats and produces distinct outputs. Furthermore, matching is a highly active area of research, leading to diverse methodologies that vary significantly across implementations. As such, defining the matching subsystem is left open.

Additionally, the matching process can be symbolically reduced to a functional representation, barring the need to inspect the detailed logical components involved. The black box approach to matching starting with the Stanford Entity Resolution Framework (SERF) [3]. One critique of the SERF match function is that it implicitly assumes a fixed output structure, whereas in practice, matching strategies differ widely.

While matching and clustering often work together in ER, they are not strictly dependent on each other. At least one must be present to resolve entities. Matching reflects the fundamental way in which an observer—human or algorithmic—identifies similarity between data points and prior knowledge. The presence of a matching subsystem in the ER pipeline has pragmatic benefits. For example, a matching subsystem can produce a similarity graph which captures similarity relationships between entities, resulting in more nuanced clustering strategies downstream [53, 60]. Additionally, due to a lower amount of information presented to the user, interfaces highlighting individual pairs of potentially matching entity references might be easier to build and easier to make user friendly.

System architectures should design the matching engine in the most suitable way to their problem domain and chosen ER model. Certain architecture may benefit from leveraging multiple matching engines. A legitimate concern may regard the ability to scale the matching engine independently of the other components in the ER pipeline because of the higher computational expense inherent in this component. Finally, the possibility to implement systems that do not leverage similarity, renders the matching engine as an optional component in the ER pipeline. These considerations render the *Strategy* design pattern [19] useful for encapsulating the algorithms which sit at the core of the matching engine.

### 5.5. Reference Store

The Reference Store appears in both incremental and batch ER, even though it is strictly necessary only for the incremental variant. Existing systems often implement it as an in-memory structure. Common representations include a sequence of pairs of matching entity references [35], a similarity graph [53] or a logical graph [60]. Certain closed-source implementations reportedly persist long-lived identifiers linked to entity references [70], though their exact design remains unknown.

This component plays the central role in entity alignment where it is synonymous with either the source or the target knowledge graph [72, 65]. For record

linkage implementations, Duke’s `Database` components provide a flexible example of a reference store. Splink’s use of Apache Spark tables to store and quickly retrieve relevant data exemplified in its `blocking` module is another example which showcases how the reference store logical abstraction might be designed in practice.

When it is designed as a component, it is reminiscent of the *Memento* design pattern [19] because it is primarily used to store and access previous versions of the same data. Common concerns to consider when designing the reference store include data availability and integrity.

### 5.6. Clustering Engine

Clustering plays a crucial role in entity resolution (ER) by grouping linked entity references that correspond to the same real-world object. It follows the principle that things which co-occur or exhibit strong relational ties likely refer to the same underlying entity. This mechanism is complementary to matching which uses the general concept of similarity to provide the evidence of solid relational ties. Both mechanisms contribute to ER in an essential way, though only at least one of them is strictly necessary.

Widely regarded as an essential step, not all reference systems implement it transparently. Some ER systems, such as Duke [21] obfuscate clustering by making it part of intermediate storage operations which use its system of `MatcherListener`. System developers are informed about clustering possibilities only once the `LinkDatabaseMatchListener` and `LinkDatabase` concepts are perused. This is the only example of obfuscating the pipeline structure of the ER process among the reference ER systems. On the other hand, some entity matching systems such as Ditto [35] or DeepMatcher [46] focus solely on identifying matching entity references, partially or completely omitting transitive resolution. In some cases, this approach can be beneficial, as it offloads the *bad-triplet* problem [1] to downstream systems.

At the other end of the spectrum, entity alignment and record linkage systems designed around graph models inherently support clustering. Some ER solutions go further by eliminating the matching phase entirely. For example, clustering subsumes matching by employing functional similarity measures and a carefully chosen merge function [3], generic distance metrics [71], or probabilistic models which form clusters directly from the comparison space using similarity functions to model colocation (D-blink [40]).

When applied, clustering typically operates on data supplied by the reference store. In cases where matching is omitted, the entity reference store effectively defines the relevant comparison space. Systems such as the JedAI [53] and FAMER [60] already support various clustering algorithms [50, 61], offering flexible options for different ER workflows.

Given its varying adoption across reference systems and the limited research on cluster coherence [70], system architectures may design a clustering engine if their specific problem domain and ER model of choice require one. In object-oriented designs, the *Strategy* design pattern [19] may be used to encapsulate the various algorithms sitting at the core of the clustering engine.

New system architectures should carefully consider clustering engines that work with incremental ER. Only some clustering algorithms (such as agglomerative clustering) are generally incremental, i.e. can be easily carried out using the batch linkage method [24].

Finally, the evaluation of clustering performance is not as common among the reference ER systems as the fundamental importance of the clustering subsystem to ER would imply. D-blink [40] is an example system which implements this feature. ER system architectures which incorporate clustering engines should also provide the means for evaluating clustering performance along with matching performance. Future efforts in this area would improve ER system transparency and reliability.

### 5.7. Presentation Layer

The logical component found across all ER systems is the entity profile presentation layer which has the responsibility of making *entity profiles* available to ER consumers. While entity profile formatting or display vary according to the needs of each implementation, all ER systems define a logical component which assembles entity profiles. The data representation of entity profiles varies along with the chosen approach to ER. The act of designing ER system architectures necessarily involves choosing an ER model which best suits the problem domain. The entity profile assembler logic will necessarily be dictated by the selected ER model.

This poses a problem for the interoperability of ER systems because of the myriad ways to represent entity profiles used in practice. Ditto represents entity profiles as pairs of matching entity references (Ditto [35]). Entity profiles take the form of algebraic set partitions when using Duke’s equivalence class linker [21], JedAI’s `ExactClustering` component [53] or D-blink’s default output [40]. FAMER represents entity profiles as subgraphs [60]. Similarly, entity alignment [65] systems also represent entity profiles as graphs. The main distinction is that in this case entity profiles are created guided by the knowledge graph’s ontology rather than by relationships between entity references.

SERF [3] introduces a black-box merge function that constructs more *dominant* entity references incrementally using the matching engine’s output. The R-Swoosh algorithm which defines this approach is exemplified in practice by the Oyster [67] ER system. The final entity references constructed in this way represent the entity profiles, their data structure being determined flexibly by the black box merge function. Merge dominance logically enables the use of the ER pipeline’s output as entity references in subsequent runs. Although treating entity profiles as entity references provides flexibility, it also introduces challenges. The traceability and explainability of ER may be reduced, as subsequent links derived from newly generated entity profiles could obscure provenance, affecting auditability and trust. Additionally, if entity clusters lack coherence, erroneous merges may propagate downstream, exacerbating the bad-triplet problem.

The above aspects highlight the need for careful selection of entity profile representations. Structured attributes, clusters, and merged profiles each present

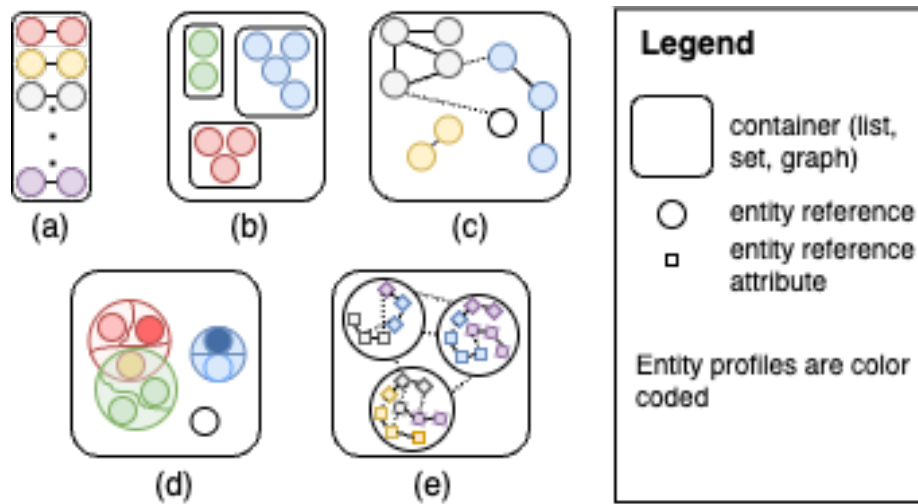

Figure 9: Examples of entity profile representations. In entity matching models, a pair of entity references often constitutes the entity profile (a). Traditional clustering-based approaches resolve transitivity but they typically assign each entity reference to a single cluster (b). A logical or similarity graph generalizes this further, allowing entity profiles to emerge as subgraphs where an entity reference may belong to multiple profiles (c). More advanced models, such as SERF’s merge dominance framework (d) and entity alignment models (e), construct entity profiles by merging attributes from entity references. The SERF model treats entity profiles as entity references themselves, enabling incremental refinement, while entity alignment follows a knowledge graph ontology, reducing the importance of original entity references. Subsection 5.7 describes the role of these representations in the reference architecture.

trade-offs in interpretability and usability. Preserving traceability when merging references is critical for explainable ER, particularly in regulated domains favouring representations of ER profiles which are more easily deconstructible to source entity references, such as clusters or graphs. Ensuring cluster coherence before treating entity profiles as entity references helps prevent iterative resolution errors.

In terms of output quantity, there is a key distinction between incremental ER and batch ER. Incremental ER returns only entity profiles based on records up until the latest input [24], perhaps even focused on the latest record. In contrast, batch ER and entity alignment return all resolved entity profiles at once. This distinction affects how results are consumed: incremental ER may provide focused, query-driven resolution, whereas batch ER enables global reconciliation of all records.

Viewing incremental ER as a query-driven system can hint at possible ways to solve the interoperability problem mentioned earlier in this section. A component oriented design coupled with a web service architecture might provide the standardization required to make ER systems more interoperable.

A well set up reference store mitigates many of the concerns related to entity profile usage and representation. Entity profile design and its integration into the ER pipeline—particularly in incremental ER—should be guided by the specific problem domain. Key motivations include provenance tracking, structured representations, security and privacy considerations, and scalable entity aggregation.

## 6. ER Runtime Process

Up until this point, the paper focused on generic use cases and abstract logical components. Procedurally ER may be interpreted as a series of subprocesses and activities which, in abstract, remain consistent across existing approaches.

Figure 10 presents a generalized blueprint of the ER pipeline, capturing its fundamental stages. It also emphasizes key subprocesses through capital-letter annotations.

This blueprint should not be interpreted as a fixed sequence of algorithmic steps. As noted in Section 5, ER runtimes exhibit significant variability, ranging from implementations closely aligned with this conceptual model to architectures based on SERF [3] or end-to-end neural network approaches [46]. While the blueprint serves as a reference for identifying common structural components across ER systems, the ultimate design and composition of an ER pipeline remain at the discretion of system architects.

### 6.1. Entity Reference Extraction

Entity resolution systems differ in their representation of entity references, which may take the form of tuples [46], mappings [21, 36], sets of named attributes [53], vectors [35], or vertices within a logical graph [60]. Regardless of the chosen format, structuring data is a fundamental step in the ER process. It ensures that the input is represented in a consistent and processable manner.

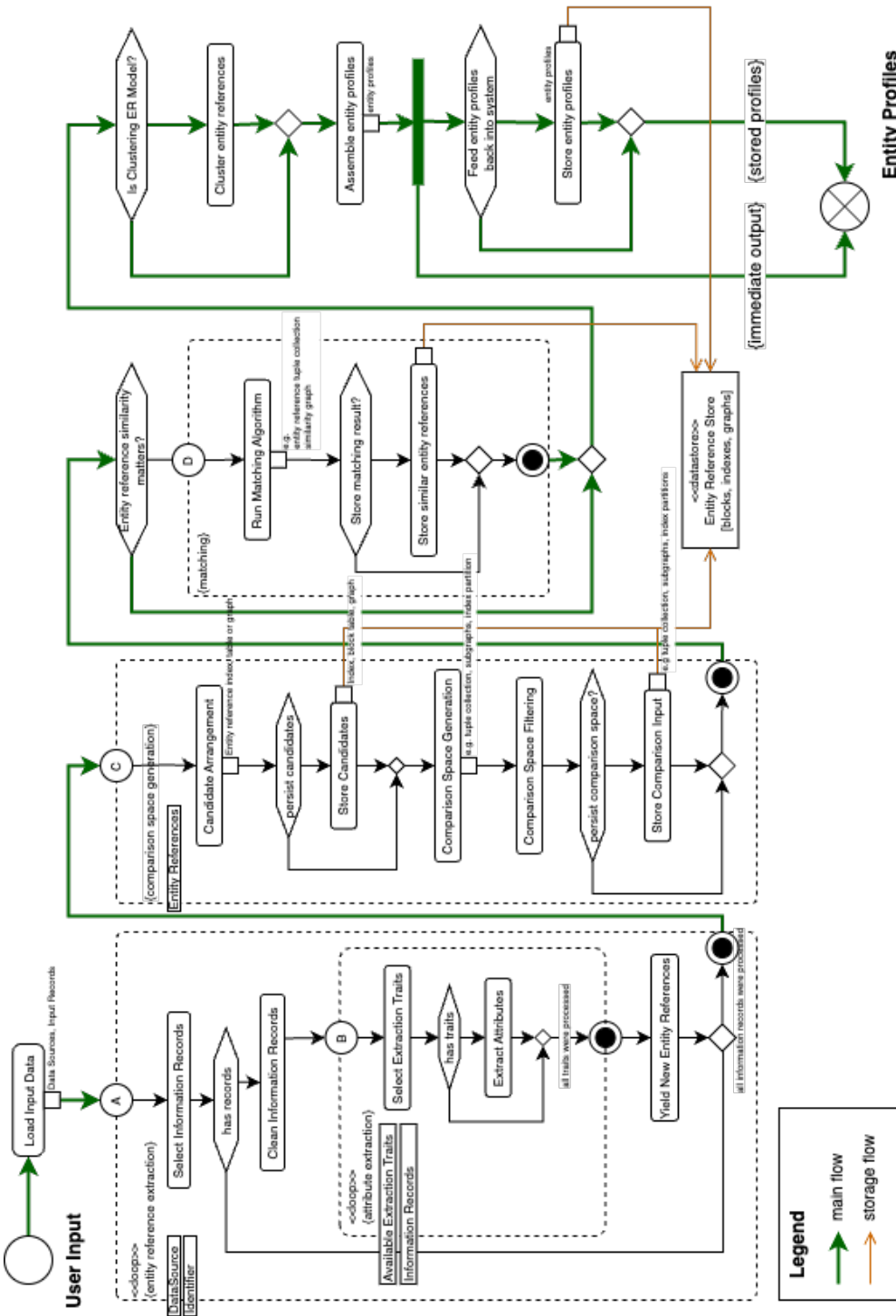

Figure 10: Entity Resolution Process described in Section 6. The process begins with loading input data, which may originate from multiple data sources (in batch ER) or be ingested incrementally. Next, entity reference extraction (A) converts information records into structured entity references, using traits (B) to extract relevant attributes. Once entity references are generated, the comparison space (C) is constructed to reduce the computational complexity of ER. If resolution is achieved through similarity-based analysis, the system performs matching (D). Otherwise, it proceeds directly to clustering and assembling entity profiles. Optionally, resolved entity profiles can be fed back into the system by storing them in the entity reference store. The entity reference store may also retain other intermediate artifacts throughout the process. The process concludes by returning the final entity profiles.

The extraction process (**A**) begins with the selection of relevant information from the input data. This data may be introduced incrementally or in batch. Using source identifiers to indicate provenance is a common approach [46, 53]. Unlike existing systems that rely on structured input formats, such as treating each row of a CSV file as a distinct information record, this approach generalizes the extraction process to accommodate unstructured data sources. Named Entity Recognition and Disambiguation (NERD) systems [56] exemplify how information records may be derived without explicit schema constraints. Once identified, the extracted records usually undergo a cleaning phase, where inconsistencies are resolved, and redundant or irrelevant data is removed. This ensures a standardized quality across extracted information.

Following data selection and cleaning, it is customary to extract attributes (**B**). This subprocess may take one or more clean information records as input. While systems typically process information records one at a time (e.g lines in a CSV file), there are cases when multiple information records are relevant together (e.g scraping a web page for cohesive information). Because each inspected system has its own attribute extraction mechanisms, we introduce a common abstraction called *extraction traits* to generalize attribute extraction. Extraction traits are predefined algorithms identify meaningful attributes in the cleaned information records. In that, extraction traits are a form of *Adapters* [19]. Extraction traits may also be *Composite* [19] objects, thus enriching the attribute extraction capabilities of the ER system. Each extraction trait may yield a collection of attributes, with system-specific logic. Extraction traits should be allowed to determine whether records are skipped, merged, or split, too. These transformations are treated as black-box processes, as the reference architecture can not impose constraints on the internal logic of extraction algorithms. The only recommendation is that the process operate over a positive number of input records and return attributes that partially define an entity reference. The attribute extraction subprocess (**B**) ends when all predefined extraction traits were employed to process the information records.

The entity reference extraction process (**A**) continues with the construction of entity references. This activity naturally follows the attribute extraction process. Depending on system requirements, entity references may be formed by concatenating extracted attributes [53]. More complex setups integrate entity reference construction in more complex designs, such as neural network architectures [46]. While this framework is well suited for entity references structured as mappings or tuples, its usage in vector-based representations requires adaptation. In such cases, entity references may either be treated as mappings with one or more vector attributes or be defined as a fixed set of attributes corresponding to the vector's dimensions.

Once entity references are assembled, the process continues iteratively until no further input data remains. This allows enough flexibility to design batch, incremental, and online ER systems.

When the input data shares the same structure as the internal representation of entity references, the extraction process may trivially allow data to pass through without modification.

### 6.2. Comparison Space Generation

In its basic form ER has a time complexity of  $\mathcal{O}(n^2)$  [12], where  $n$  represents the total number of entity references. This complexity arises from the need to compare all entity references among themselves, making the approach infeasible for large-scale data. To mitigate this, blocking, indexing, and filtering techniques [52] reduce the number of comparisons while preserving resolution quality. These techniques benefit both batch and incremental ER by improving processing efficiency.

Since the number and type of comparison-reducing methods vary across implementations, a flexible abstraction, termed the *comparison space*, is introduced. This concept organizes entity references in structured ways that facilitate minimizing the number of required similarity comparisons while retaining essential relationships.

The process of generating the comparison space, denoted as **(C)** in Figure 10, consists of three main phases: candidate arrangement, comparison input generation, and filtering. Candidate arrangement reorganizes entity references into efficient data structures without loss of information. Techniques such as blocking, indexing, and graph edge modification exemplify this step, resulting in structures like block tables, balanced trees, or graphs. In some cases, these structures may be persistently stored for later retrieval.

Once candidate arrangement is complete, comparison input generation produces reference pairs or groups suitable for the subsequent matching phase. Since matching algorithms operate on predefined input parameters, this step determines the number of comparisons that will be executed.

Filtering further refines the comparison space by eliminating low-relevance entity pairs before matching. While this step enhances efficiency, it may introduce information loss if certain entity references are entirely excluded [12].

The final comparison space, potentially stored for optimization, allows flexibility in tuning matching and clustering strategies. This structured approach ensures that ER systems scale efficiently without compromising accuracy.

As a final recommendation, the actions for storing the “comparison space” might benefit from following the *Memento* design pattern [19].

### 6.3. Matching and Clustering

Entity resolution fundamentally relies on two core components: matching and clustering.

Matching, represented abstractly in Figure 10 as subprocess **(D)**, identifies references to the same entity by evaluating their similarity. This process remains a black box within the reference architecture due to the diversity of available techniques. Traditional approaches range from probabilistic and deterministic methods to state-of-the-art deep learning models, including transformers [35] and graph neural networks [72]. As the most extensively studied aspect of entity resolution, matching remains at the forefront of research and system optimization.

Clustering, in contrast, takes advantage of entity references being organized within a metric space or a graph, leveraging spatial proximity or graph theory to infer co-referential relationships. Though historically receiving less attention than matching in ER research, it has become more studied lately [40, 71]. As with matching, clustering is a black box within the reference architecture due to the number of options available.

While robust ER solutions integrate both matching and clustering, only one of these components is strictly necessary. The Swoosh family of algorithms [3] allows assigning various degrees of importance to matching and clustering by carefully choosing the match and merge functions. Systems that employ both matching and clustering may benefit from storing matching results. Similarity graphs [53] and logical graphs [60] may provide good starting points for representing entity reference relationships, facilitating further processing and analysis.

From both a logical and deployment perspective, the entity reference store serves as a natural repository for storing matching output, ensuring efficient retrieval and refinement into clusters.

#### 6.4. Entity Profile Assembly

The last step of the ER process consists in building the entity profile. Entity profiles are built from entity reference clusters or directly from the output of the matching subprocess.

Because of the large number of ways of aggregating entity references into a coherent entity profile, system designs might benefit from leveraging the *Builder* design pattern [19] in entity profile assembly.

Certain ER models (like SERF [3]) allow entity profiles to be viewed as entity references. This allows feeding entity profiles back into the system by storing entity profiles in the entity reference store described in Subsection 5.5.

## 7. Implementation and Deployment Guidelines

### 7.1. Development Considerations

Even though every implementation is unique, the inspected reference systems exhibit idiomatic programming techniques and favor abstraction over hardcoded logic. This approach improves system maintainability, and indirectly extensibility, allowing support for diverse data formats and algorithms which drive the ER process. Separating the user interface from the core ER system is beneficial, especially when the UI evolves independently. FAMER [60] and JedAI [53] exemplify this approach in practice. Similarly, modularizing ER phases enables independent evolution and scalability of components.

Systems that implement a clear and structured pipeline (e.g., FAMER, JedAI, Splink, dblink) are more maintainable than those lacking an idiomatic runtime configuration (e.g., Ditto, DeepMatcher) or those which apply patterns in unconventional ways. For instance, Duke employs the *Observer* pattern [19], typically used for event-driven programming, to manage workflow execution.

We advocate extending the *Law of Least Astonishment* [26] to source code. In other words, code should be structured in a way that minimizes surprises for reviewers. While this guideline was formulated in a less formal context than literate programming [29], it remains a surprisingly effective principle for improving code maintainability and readability, thereby increasing extensibility as well.

Interoperability is an important factor in ER system design, ensuring that both input data and output results are structured for seamless integration into larger workflows. Input records exist in multiple formats, ranging from highly structured databases to unstructured text. In multimodal ER, information must be extracted from sources containing non-textual data, requiring adaptable extraction pipelines. This necessity highlights the close intermingling of extensible design principles and interoperable systems which is so vital for successful end to end ER systems.

In incremental ER, an API-based approach should be favored, with a clearly defined query contract for real-time resolution. A clear separation between input contracts and the internal representation of entity references is highly encouraged to prevent internal design changes from affecting the interoperability of the system. Similarly, entity profiles should be as standardized and portable as possible, prioritizing machine-readable formats to facilitate downstream integration. Usability concerns such as human-readable output should remain secondary and preferably implemented separately.

The requirement to implement custom scaling and parallelization mechanisms depends almost entirely on the size of the data being processed. ER systems should leverage existing distributed computing frameworks [40, 36, 60], reducing the complexity of handling large-scale data processing.

While the JVM, Python, and R dominate current ER implementations, the problem itself is not bound to any particular technology. All ER models can be materialized easily using widespread programming paradigms such as modularization, object orientation or componentization. Our selection of reference systems clearly exemplifies this possibility.

## 7.2. Deployment Considerations

The scalability needs of a system determine in large part its deployment. ER systems scale proportionally to the volume of processed entity references. This is true both of batch and incremental ER systems. Lightweight deployments are feasible for small datasets or system development, but scaling the deployment often presents its set of challenges and trade-offs.

Key factors influencing deployment decisions include:

- **Dataset size:** Smaller datasets enable more compact deployments. Some systems [21, 53] can run on a local machine without issues.
- **Portability:** Large-scale ER benefits from distributed runtimes like Apache Spark [40, 36] or Flink [60], but this reduces the portability of the system.

- **Distributed computations in incremental ER:** Unlike batch ER, incremental ER requires maintaining intermediate state, making parallel computations more complex. At the extreme, the CAP theorem [22] becomes relevant for the intermediate state storage.
- **Highly available reference store:** Depending on data availability and durability requirements, the reference store described in Subsection 5.5 may need to be deployed in a high-availability (HA) configuration.

While scalability often comes at the expense of portability, containerization (e.g Docker, Kubernetes) and micro virtual machines (e.g AWS Lambda, Azure functions) can mitigate these limitations by standardizing deployment environments. Micro virtual machines may not be suitable for compute-intensive tasks like batch matching because of resource constraints. They remain suitable for lower-cost ER phases such as entity reference extraction.

Beyond scalability and performance considerations, deployment strategies must align with privacy, security, and regulatory requirements. ER systems frequently operate in sensitive domains, such as medical record linkage, where privacy-preserving algorithms and strict data locality policies are essential. These setups are favoured by local, bare metal deployments, not cloud native ones. On the other hand if global availability, security and auditability concerns rank highly, cloud native architectures have distinctive advantages. These auxiliary concerns greatly influence the choice of storage, communication and data-sharing mechanisms.

## 8. Conclusion

### 8.1. Concluding Remarks on Research Questions

In the preceding sections, we saw that the main use cases of ER systems broadly fall into three categories: configuration, runtime and evaluation use cases. Configuration use cases were referred to as the ‘design time’ interface of the system and highlighted user roles and potential actions that occur when the ER system is prepared for operation. In contrast, the runtime use cases highlight the activities surrounding ER systems which occur while they resolve entity references into entity profiles. Finally, evaluation use cases highlight activities which are performed either at design time or at runtime to assess the quality and performance of ER.

Then we proceeded by outlining logical (Section 5) and procedural (Section 6) abstractions common to all ER systems, regardless of their focus—record linkage, deduplication, entity alignment, NERD, or other variations. These abstractions apply to both batch and incremental ER. Recommendations were provided, and potential pitfalls addressed to ensure that the logical and procedural components of ER system designs remain extensible, interoperable, and scalable. Key design principles, such as loose coupling and high cohesion, were emphasized alongside established patterns (like the pipeline model) to enhance

code maintainability and readability. Distributed computing frameworks, including Apache Spark and Flink, were advocated as preferable alternatives to custom-built runtimes. From the outset, component orientation was recommended, particularly given the black-box nature of match and merge operations.

This brings us to the core question: what key insights can we offer for designing entity resolution systems? The answer to this question determines the practical effectiveness of the reference architecture.

A fundamental requirement for ER systems is end-to-end entity resolution. While we have argued that either matching or clustering is sufficient for ER, systems should strive to incorporate multiple methods for determining which entity references contribute to an entity profile. Our firm recommendation is that ER pipeline components be designed to create value beyond their individual contributions. This is achievable only through careful use of abstractions such as the ER pipeline and the reference store. Further, batch and incremental ER both provide value, but truly remarkable ER systems implement both paradigms. Incremental ER in particular lends itself extremely well to modern architectural approaches such as service-oriented architecture or event-driven architecture.

A natural consequence of end-to-end ER design is the need for appropriate evaluation. Assessing clustering performance solely through statistical metrics (e.g., precision, recall, F-measure) leads to information loss. Conversely, evaluating pairwise clustering performance when no matching has occurred introduces extraneous data with no meaningful interpretation. Regardless of the specific combination of matching, clustering, or other pipeline components, ER evaluation must be implemented and finely tuned to the runtime environment.

Another critical consideration is the flexibility of the reference architecture. Configuration, matching, and clustering remain largely at the discretion of system designers. While this stance may be viewed as a limitation of the reference architecture, avoiding the prescription of rigid implementations for these areas is wholly intentional. Configuration choices are often tied to the underlying technology, while matching and clustering depend on the selected ER model. Furthermore, future methods for selecting entity references beyond matching and clustering may emerge, and the reference architecture strongly supports extensibility in this regard. Matching flexibility allows for deterministic, probabilistic, and machine-learning-based ER models. Clustering approaches may include algebraic, probabilistic, or graph-based methods. The pipeline design enables seamless substitution of rule-based engines with neural network models.

Beyond extensibility, large-scale ER requires careful attention to scalability and performance. Comparison space generation and reference storage are fundamental abstractions which must be present in all ER systems. A component-oriented approach is strongly recommended, as it facilitates scalability by providing standardized interfaces between component-specific logic and the overarching pipeline.

ER systems must efficiently process diverse input data while maintaining strict output consistency. To support downstream integration, the reference architecture promotes standardization: input flexibility is encouraged, while output representation is constrained. Logical components surround the core ER

processes, ensuring uniformity in input reduction via comparison space generation and in entity profile assembly based on ER models. Despite differences in implementation, core entity profile assembly activities remain consistent across ER systems.

These principles lead to a reference architecture that prioritizes component-oriented design, emphasizing extensibility in configuration, core runtime components, and evaluation. Interoperability is achieved by allowing input flexibility through entity reference extraction while enforcing output standardization through entity profile assembly. Scalability and performance are upheld through essential abstractions, including comparison space generation and the reference store.

Ultimately, this article presents a structured yet adaptable approach to ER within well-defined boundaries. The proposed abstractions, principles, and patterns combine themselves into a reference architecture which can be a structured foundation for future research and practical implementations.

### *8.2. Feedback Process and Validation*

The reference architecture proposed in this paper was developed through a rigorous study and synthesis of existing systems. By abstracting their source code into generic concepts and processes, it ensures empirical soundness. Efforts were made to maintain a clear correspondence between these abstractions and their concrete implementations, as outlined throughout the paper. As such, the architecture provides a structured yet flexible foundation for designing ER solutions. However, given the vast scope of existing knowledge, this initial version remains an imperfect work, at best.

Rather than developing another ER system (which would only contribute to the paradox of choice alluded to in the introduction), a more effective approach is to iteratively refine the architecture based on feedback from practitioners. This transforms it into a dynamic framework, continuously improved using empirical evaluation and contributions from the ER community.

To support this evolution, researchers and architects are encouraged to reach out to the authors to establish a collaborative framework. At a minimum, this approach would allow integrating insights from real-world implementations, industry constraints, and emerging trends. The ultimate goal is to sustain an adaptive design that informs and supports the development of ER systems over time.

### *8.3. Final Words*

ER is an area of research with a vast and diverse literature which may cause a paradox of choice for newcomers to the field. The present paper introduces a reference architecture for ER focused on extensibility, interoperability and scalability. The reference architecture delineates the bounds where generalization and abstraction yield diminishing returns, particularly for ER configuration and evaluation, but also for the ER runtime to a lesser extent. Yet, to our knowledge, this is the first attempt at writing a reference architecture for ER and the first attempt to unify so many ER flavours using the same abstractions.

The paper was written in hopes of triggering an effort to standardize ER design across all flavours of ER. Subsequent iterations of this reference architecture (based on feedback and collaboration), and the standardization of the broader ER problem domain would both be welcome.

## References

- [1] Ailon, N., Charikar, M., Newman, A., 2005. Aggregating inconsistent information: ranking and clustering, in: Proceedings of the Thirty-Seventh Annual ACM Symposium on Theory of Computing, Association for Computing Machinery, New York, NY, USA. p. 684–693. URL: <https://doi.org/10.1145/1060590.1060692>, doi:10.1145/1060590.1060692.
- [2] Angelov, S., Grefen, P., Greefhorst, D., 2012. A framework for analysis and design of software reference architectures. *Information and Software Technology* 54, 417–431. URL: <https://www.sciencedirect.com/science/article/pii/S0950584911002333>, doi:<https://doi.org/10.1016/j.infsof.2011.11.009>.
- [3] Benjelloun, O., Garcia-Molina, H., Menestrina, D., Su, Q., Whang, S.E., Widom, J., 2009. Swoosh: a generic approach to entity resolution. *The VLDB Journal* 18, 255–276. URL: <https://doi.org/10.1007/s00778-008-0098-x>, doi:10.1007/s00778-008-0098-x.
- [4] Binette, O., 2023. Er-evaluation: An end-to-end evaluation framework for entity resolution systems. URL: <https://github.com/Valires/ER-Evaluation>. accessed at 2025-02-21.
- [5] Binette, O., Baek, Y., Engineer, S., Jones, C., Dasyuva, A., Reiter, J.P., 2024. How to evaluate entity resolution systems: An entity-centric framework with application to inventor name disambiguation. *ArXiv abs/2404.05622*. URL: <https://api.semanticscholar.org/CorpusID:269004955>.
- [6] Binette, O., Steorts, R.C., 2022. (almost) all of entity resolution. *Science Advances* 8. URL: <https://www.science.org/doi/abs/10.1126/sciadv.abi8021>, doi:10.1126/sciadv.abi8021.
- [7] Bird, S., Loper, E., 2004. NLTK: The natural language toolkit, in: Proceedings of the ACL Interactive Poster and Demonstration Sessions, Association for Computational Linguistics, Barcelona, Spain. pp. 214–217. URL: <https://aclanthology.org/P04-3031/>.
- [8] Booch, G., Rumbaugh, J.E., Jacobson, I., 1998. The unified modeling language user guide. *J. Database Manag.* 10, 51–52. URL: <https://api.semanticscholar.org/CorpusID:27636970>.

- [9] Canale, L., Lisena, P., Troncy, R., 2018. A novel ensemble method for named entity recognition and disambiguation based on neural network, in: Vrandečić, D., Bontcheva, K., Suárez-Figueroa, M.C., Presutti, V., Celino, I., Sabou, M., Kaffee, L.A., Simperl, E. (Eds.), *The Semantic Web – ISWC 2018*, Springer International Publishing, Cham. pp. 91–107.
- [10] Christen, P., 2008. Febrl -: an open source data cleaning, deduplication and record linkage system with a graphical user interface, in: *Proceedings of the 14th ACM SIGKDD International Conference on Knowledge Discovery and Data Mining*, Association for Computing Machinery, New York, NY, USA. p. 1065–1068. URL: <https://doi.org/10.1145/1401890.1402020>, doi:10.1145/1401890.1402020.
- [11] Christen, P., Christen, P., 2012. Data matching systems. *Data Matching: Concepts and Techniques for Record Linkage, Entity Resolution, and Duplicate Detection*, 229–242.
- [12] Christophides, V., Efthymiou, V., Palpanas, T., Papadakis, G., Stefanidis, K., 2020. An overview of end-to-end entity resolution for big data. *ACM Comput. Surv.* 53. URL: <https://doi.org/10.1145/3418896>, doi:10.1145/3418896.
- [13] Cloutier, R., Muller, G., Verma, D., Nilchiani, R., Hole, E., Bone, M., 2010. The concept of reference architectures. *Systems Engineering* 13, 14–27. URL: <https://incose.onlinelibrary.wiley.com/doi/abs/10.1002/sys.20129>, doi:<https://doi.org/10.1002/sys.20129>, arXiv:<https://incose.onlinelibrary.wiley.com/doi/pdf/10.1002/sys.20129>.
- [14] Cook, S., Bock, C., Rivett, P., Rutt, T., Seidewitz, E., Selic, B., Tolbert, D., 2017. Unified Modeling Language (UML) Version 2.5.1. Standard. Object Management Group (OMG). URL: <https://www.omg.org/spec/UML/2.5.1>.
- [15] De Bruin, J., 2019. Python Record Linkage Toolkit: A toolkit for record linkage and duplicate detection in Python. URL: <https://doi.org/10.5281/zenodo.3559043>, doi:10.5281/zenodo.3559043.
- [16] ENAMORADO, T., FIFIELD, B., IMAI, K., 2019. Using a probabilistic model to assist merging of large-scale administrative records. *American Political Science Review* 113, 353–371. doi:10.1017/S0003055418000783.
- [17] Fellegi, I.P., Sunter, A.B., 1969. A theory for record linkage. *Journal of the American Statistical Association* 64, 1183–1210. URL: <https://www.tandfonline.com/doi/abs/10.1080/01621459.1969.10501049>, doi:10.1080/01621459.1969.10501049.
- [18] Fior, J., Favale, T., Cagliero, L., Giordano, D., Mellia, M., Baralis, E., Ronchiadin, S., Baracco, P., Moncalvo, D., 2022. Legal entity disambiguation for financial crime detection, in: *2022 IEEE International Conference*

on Big Data (Big Data), pp. 6639–6641. doi:10.1109/BigData55660.2022.10020700.

- [19] Gamma, E., Helm, R., Johnson, R., Vlissides, J., 1994. Design Patterns: Elements of Reusable Object-Oriented Software. Addison-Wesley Professional. URL: <https://www.informit.com/store/design-patterns-elements-of-reusable-object-oriented-9780201633610>.
- [20] Garcés, L., Martínez-Fernández, S., Oliveira, L., Valle, P., Ayala, C., Franch, X., Nakagawa, E.Y., 2021. Three decades of software reference architectures: A systematic mapping study. *Journal of Systems and Software* 179, 111004. URL: <https://www.sciencedirect.com/science/article/pii/S0164121221001011>, doi:<https://doi.org/10.1016/j.jss.2021.111004>.
- [21] Garshol, L.M., 2014. Duke. URL: <https://github.com/larsga/Duke/releases/tag/duke-1.2>. accessed on 2025-02-18.
- [22] Gilbert, S., Lynch, N., 2002. Brewer’s conjecture and the feasibility of consistent, available, partition-tolerant web services. *SIGACT News* 33, 51–59. URL: <https://doi.org/10.1145/564585.564601>, doi:10.1145/564585.564601.
- [23] Gregg, F., Eder, D., 2024. Dedupe. URL: <https://github.com/dedupeio/dedupe>. accessed on 2025-02-18.
- [24] Gruenheid, A., Dong, X.L., Srivastava, D., 2014. Incremental record linkage. *Proc. VLDB Endow.* 7, 697–708. URL: <https://doi.org/10.14778/2732939.2732943>, doi:10.14778/2732939.2732943.
- [25] Isele, R., Bizer, C., 2013. Active learning of expressive linkage rules using genetic programming. *Journal of Web Semantics* 23, 2–15. URL: <https://www.sciencedirect.com/science/article/pii/S1570826813000231>, doi:<https://doi.org/10.1016/j.websem.2013.06.001>. data Linking.
- [26] James, G., 1987. *The Tao of Programming*. InfoBooks, USA.
- [27] Kasai, J., Qian, K., Gurajada, S., Li, Y., Popa, L., 2019. Low-resource deep entity resolution with transfer and active learning, in: Korhonen, A., Traum, D., Màrquez, L. (Eds.), *Proceedings of the 57th Annual Meeting of the Association for Computational Linguistics*, Association for Computational Linguistics, Florence, Italy. pp. 5851–5861. URL: <https://aclanthology.org/P19-1586/>, doi:10.18653/v1/P19-1586.
- [28] Kirielle, N., Christen, P., Ranbaduge, T., 2022. Transer: Homogeneous transfer learning for entity resolution, in: *International Conference on Extending Database Technology*. URL: <https://doi.org/10.48786/edbt.2022.03>, doi:10.48786/edbt.2022.03.

- [29] Knuth, D.E., 1984. Literate programming. *Comput. J.* 27, 97–111. URL: <https://doi.org/10.1093/comjnl/27.2.97>, doi:10.1093/comjnl/27.2.97.
- [30] Konda, P., Das, S., Suganthan G.C., P., Martinkus, P., Ardalan, A., Ballard, J.R., Govind, Y., Li, H., Panahi, F., Zhang, H., Naughton, J., Prasad, S., Krishnan, G., Deep, R., Raghavendra, V., 2018. Technical perspective: Toward building entity matching management systems. *SIGMOD Rec.* 47, 33–40. URL: <https://doi.org/10.1145/3277006.3277015>, doi:10.1145/3277006.3277015.
- [31] Köpcke, H., Thor, A., Rahm, E., 2009. Comparative evaluation of entity resolution approaches with fever. *Proc. VLDB Endow.* 2, 1574–1577. URL: <https://doi.org/10.14778/1687553.1687595>, doi:10.14778/1687553.1687595.
- [32] Köpcke, H., Thor, A., Rahm, E., 2010. Evaluation of entity resolution approaches on real-world match problems. *Proc. VLDB Endow.* 3, 484–493. URL: <https://doi.org/10.14778/1920841.1920904>, doi:10.14778/1920841.1920904.
- [33] Kruchten, P., 1995. The 4+1 view model of architecture. *IEEE Software* 12, 42–50. doi:10.1109/52.469759.
- [34] Kruchten, P., 2004. *The rational unified process: an introduction*. Addison-Wesley Professional.
- [35] Li, Y., Li, J., Suhara, Y., Doan, A., Tan, W.C., 2020. Deep entity matching with pre-trained language models. *Proc. VLDB Endow.* 14, 50–60. URL: <https://doi.org/10.14778/3421424.3421431>, doi:10.14778/3421424.3421431.
- [36] Linacre, R., Lindsay, S., Manassis, T., Slade, Z., Hepworth, T., Kennedy, R., Bond, A., 2022. Slink: Free software for probabilistic record linkage at scale. *International Journal of Population Data Science* 7. URL: <https://ijpds.org/article/view/1794>, doi:10.23889/ijpds.v7i3.1794.
- [37] Liu, R., Mao, R., Luu, A.T., Cambria, E., 2023. A brief survey on recent advances in coreference resolution. *Artificial Intelligence Review* 56, 14439–14481. URL: <https://doi.org/10.1007/s10462-023-10506-3>, doi:10.1007/s10462-023-10506-3.
- [38] MacDonald, S., Szafron, D., Schaeffer, J., 2004. Rethinking the pipeline as object-oriented states with transformations. *Ninth International Workshop on High-Level Parallel Programming Models and Supportive Environments*, 2004. Proceedings. , 12–21 URL: <https://api.semanticscholar.org/CorpusID:1282916>.

- [39] Maidasani, H., Namata, G., Huang, B., Getoor, L., 2012. Entity resolution evaluation measures. URL: <https://api.semanticscholar.org/CorpusID:15934618>.
- [40] Marchant, N.G., Kaplan, A., Elazar, D.N., Rubinstein, B.I.P., Steorts, R.C., 2021. d-blink: Distributed end-to-end bayesian entity resolution. *Journal of Computational and Graphical Statistics* 30, 406–421. URL: <https://doi.org/10.1080/10618600.2020.1825451>, doi:10.1080/10618600.2020.1825451, arXiv:<https://doi.org/10.1080/10618600.2020.1825451>.
- [41] Marchant, N.G., Rubinstein, B.I.P., 2017. In search of an entity resolution oasis: optimal asymptotic sequential importance sampling. *Proc. VLDB Endow.* 10, 1322–1333. URL: <https://doi.org/10.14778/3137628.3137642>, doi:10.14778/3137628.3137642.
- [42] Menestrina, D., Whang, S.E., Garcia-Molina, H., 2010. Evaluating entity resolution results. *Proc. VLDB Endow.* 3, 208–219. URL: <https://doi.org/10.14778/1920841.1920871>, doi:10.14778/1920841.1920871.
- [43] Michael, J., Shekhovtsov, V.A., 2024. A model-based reference architecture for complex assistive systems and its application. *Software and Systems Modeling* 23, 1247–1274. URL: <https://doi.org/10.1007/s10270-024-01157-1>, doi:10.1007/s10270-024-01157-1.
- [44] Montani, I., Honnibal, M., Boyd, A., Van Landeghem, S., Peters, H., 2023. explosion/spacy: v3.7.2: Fixes for apis and requirements. URL: <https://zenodo.org/doi/10.5281/zenodo.10009823>, doi:10.5281/ZENODO.10009823.
- [45] Mookiah, P., Holmes, I., Watkins, J., O’Connell, T., 2019. A real-time solution for application fraud prevention. URL: <https://api.semanticscholar.org/CorpusID:198917274>.
- [46] Mudgal, S., Li, H., Rekatsinas, T., Doan, A., Park, Y., Krishnan, G., Deep, R., Arcaute, E., Raghavendra, V., 2018. Deep learning for entity matching: A design space exploration, in: *Proceedings of the 2018 International Conference on Management of Data*, Association for Computing Machinery, New York, NY, USA. p. 19–34. URL: <https://doi.org/10.1145/3183713.3196926>, doi:10.1145/3183713.3196926.
- [47] Nakagawa, E.Y., Guessi, M., Maldonado, J.C., Feitosa, D., Oquendo, F., 2014. Consolidating a process for the design, representation, and evaluation of reference architectures, in: *2014 IEEE/IFIP Conference on Software Architecture*, pp. 143–152. doi:10.1109/WICSA.2014.25.
- [48] Newcombe, H.B., Kennedy, J.M., Axford, S.J., James, A.P., 1959. Automatic linkage of vital records. *Science* 130, 954–959. URL: <https://www.science.org/doi/abs/10.1126/science.130.3381.954>, doi:10.1126/science.130.3381.954.

- [49] Olar, A., Dioşan, L., 2024. Pyresolvemetrics: A standards-compliant and efficient approach to entity resolution metrics , 257–263doi:10.5220/0012546300003693.
- [50] Papadakis, G., Efthymiou, V., Thanos, E., Hassanzadeh, O., Christen, P., 2023. An analysis of one-to-one matching algorithms for entity resolution. *The VLDB Journal* 32, 1369–1400. URL: <https://doi.org/10.1007/s00778-023-00791-3>, doi:10.1007/s00778-023-00791-3.
- [51] Papadakis, G., Ioannou, E., Thanos, E., Palpanas, T., 2021. *The Four Generations of Entity Resolution*. Springer Cham. doi:<https://doi.org/10.1007/978-3-031-01878-7>.
- [52] Papadakis, G., Skoutas, D., Thanos, E., Palpanas, T., 2020. Blocking and filtering techniques for entity resolution: A survey. *ACM Comput. Surv.* 53. URL: <https://doi.org/10.1145/3377455>, doi:10.1145/3377455.
- [53] Papadakis, G., Tsekouras, L., Thanos, E., Giannakopoulos, G., Palpanas, T., Koubarakis, M., 2018. The return of jedai: end-to-end entity resolution for structured and semi-structured data. *Proc. VLDB Endow.* 11, 1950–1953. URL: <https://doi.org/10.14778/3229863.3236232>, doi:10.14778/3229863.3236232.
- [54] Pääkkönen, P., Pakkala, D., 2015. Reference architecture and classification of technologies, products and services for big data systems. *Big Data Research* 2, 166–186. URL: <https://www.sciencedirect.com/science/article/pii/S2214579615000027>, doi:<https://doi.org/10.1016/j.bdr.2015.01.001>.
- [55] Richards, M., Ford, N., 2020. *Fundamentals of Software Architecture*. O’Reilly Media.
- [56] Rizzo, G., Troncy, R., 2012. NERD: A framework for unifying named entity recognition and disambiguation extraction tools, in: Segond, F. (Ed.), *Proceedings of the Demonstrations at the 13th Conference of the European Chapter of the Association for Computational Linguistics*, Association for Computational Linguistics, Avignon, France. pp. 73–76. URL: <https://aclanthology.org/E12-2015/>.
- [57] Rocca, W.A., Yawn, B.P., Yawn, B.P., Sauver, J.L.S., Grossardt, B.R., Melton, L.J.I., 2012. History of the rochester epidemiology project: half a century of medical records linkage in a us population. *Mayo Clinic proceedings* 87 12, 1202–13. URL: <https://doi.org/10.1016/j.mayocp.2012.08.012>, doi:10.1016/j.mayocp.2012.08.012.
- [58] Ron Goeken, Lap Huynh, T.A.L., Vick, R., 2011. New methods of census record linking. *Historical Methods: A Journal of Quantitative and Interdisciplinary History* 44, 7–14. URL: <https://doi.org/10.1080/01615440.2010.517152>, doi:10.1080/01615440.2010.517152,

arXiv:<https://doi.org/10.1080/01615440.2010.517152>. PMID: 21566706.

- [59] Sadinle, M., Fienberg, S.E., 2013. A generalized fellegi–sunter framework for multiple record linkage with application to homicide record systems. *Journal of the American Statistical Association* 108, 385–397. URL: <https://doi.org/10.1080/01621459.2012.757231>, doi:10.1080/01621459.2012.757231, arXiv:<https://doi.org/10.1080/01621459.2012.757231>.
- [60] Saeedi, A., Nentwig, M., Peukert, E., Rahm, E., 2018. Scalable matching and clustering of entities with famer. *Complex Systems Informatics and Modeling Quarterly*, 61–83 URL: <https://csimq-journals.rtu.lv/csimq/article/view/csimq.2018-16.04>, doi:10.7250/csimq.2018-16.04.
- [61] Saeedi, A., Peukert, E., Rahm, E., 2017. Comparative evaluation of distributed clustering schemes for multi-source entity resolution, in: Kirikova, M., Nørvåg, K., Papadopoulos, G.A. (Eds.), *Advances in Databases and Information Systems*, Springer International Publishing, Cham. pp. 278–293.
- [62] Schwartz, B., 2015. *The Paradox of Choice*. John Wiley & Sons, Ltd. chapter 8. pp. 121–138. URL: <https://onlinelibrary.wiley.com/doi/abs/10.1002/9781118996874.ch8>, doi:<https://doi.org/10.1002/9781118996874.ch8>, arXiv:<https://onlinelibrary.wiley.com/doi/pdf/10.1002/9781118996874.ch8>.
- [63] Simonini, G., Papadakis, G., Palpanas, T., Bergamaschi, S., 2019. Schema-agnostic progressive entity resolution. *IEEE Transactions on Knowledge and Data Engineering* 31, 1208–1221. doi:10.1109/TKDE.2018.2852763.
- [64] Speck, R., Ngomo, A.C.N., 2017. Ensemble learning of named entity recognition algorithms using multilayer perceptron for the multilingual web of data, in: *Proceedings of the 9th Knowledge Capture Conference, Association for Computing Machinery, New York, NY, USA*. URL: <https://doi.org/10.1145/3148011.3154471>, doi:10.1145/3148011.3154471.
- [65] Sun, Z., Zhang, Q., Hu, W., Wang, C., Chen, M., Akrami, F., Li, C., 2020. A benchmarking study of embedding-based entity alignment for knowledge graphs. *Proc. VLDB Endow.* 13, 2326–2340. URL: <https://doi.org/10.14778/3407790.3407828>, doi:10.14778/3407790.3407828.
- [66] Talburt, J.R., Wang, R.Y., Hess, K., Kuo, E., 2007. An algebraic approach to data quality metrics for entity resolution over large datasets. URL: <https://doi.org/10.4018/978-1-59904-024-0.CH001>, doi:10.4018/978-1-59904-024-0.CH001.

- [67] Talburt, J.R., Zhou, Y., 2013. A Practical Guide to Entity Resolution with OYSTER. Springer Berlin Heidelberg, Berlin, Heidelberg. pp. 235–270. URL: [https://doi.org/10.1007/978-3-642-36257-6\\_11](https://doi.org/10.1007/978-3-642-36257-6_11), doi:10.1007/978-3-642-36257-6\_11.
- [68] Team, T.Z., 2024. Zingg. URL: <https://github.com/zinggAI/zingg/releases/tag/v0.4.0>. accessed at 2025-02-17.
- [69] Vermeulen, A., Beged-Dov, G., Thompson, P., 1995. The pipeline design pattern, in: Conference on Object-Oriented Programming Systems, Languages, and Applications. URL: <https://api.semanticscholar.org/CorpusID:53891259>.
- [70] Yan, Y., Meyles, S., Haghighi, A., Suciu, D., 2020. Entity matching in the wild: A consistent and versatile framework to unify data in industrial applications, in: Proceedings of the 2020 ACM SIGMOD International Conference on Management of Data, Association for Computing Machinery, New York, NY, USA. p. 2287–2301. URL: <https://doi.org/10.1145/3318464.3386143>, doi:10.1145/3318464.3386143.
- [71] Zeakis, A., Papadakis, G., Skoutas, D., Koubarakis, M., 2023. Pre-trained embeddings for entity resolution: An experimental analysis. Proc. VLDB Endow. 16, 2225–2238. URL: <https://doi.org/10.14778/3598581.3598594>, doi:10.14778/3598581.3598594.
- [72] Zeng, K., Li, C., Hou, L., Li, J., Feng, L., 2021. A comprehensive survey of entity alignment for knowledge graphs. AI Open 2, 1–13. URL: <https://www.sciencedirect.com/science/article/pii/S2666651021000036>, doi:<https://doi.org/10.1016/j.aiopen.2021.02.002>.