

LLM-Enhanced Multiple Instance Learning for Joint Rumor and Stance Detection with Social Context Information

RUICHAO YANG, Department of Computer Science, Hong Kong Baptist University, Hong Kong, China

JING MA*, Department of Computer Science, Hong Kong Baptist University, Hong Kong, China

WEI GAO, School of Computing and Information Systems, Singapore Management University, Singapore

HONGZHAN LIN, Department of Computer Science, Hong Kong Baptist University, Hong Kong, China

The proliferation of misinformation, such as rumors on social media, has drawn significant attention, prompting various expressions of stance among users. Although rumor detection and stance detection are distinct tasks, they can complement each other. Rumors can be identified by cross-referencing stances in related posts, and stances are influenced by the nature of the rumor. However, existing stance detection methods often require post-level stance annotations, which are costly to obtain. We propose a novel LLM-enhanced MIL approach to jointly predict post stance and claim class labels, supervised solely by claim labels, using an undirected microblog propagation model. Our weakly supervised approach relies only on bag-level labels of claim veracity, aligning with multi-instance learning (MIL) principles. To achieve this, we transform the multi-class problem into multiple MIL-based binary classification problems. We then employ a discriminative attention layer to aggregate the outputs from these classifiers into finer-grained classes. Experiments conducted on three rumor datasets and two stance datasets demonstrate the effectiveness of our approach, highlighting strong connections between rumor veracity and expressed stances in responding posts. Our method shows promising performance in joint rumor and stance detection compared to the state-of-the-art methods.

Additional Key Words and Phrases: Multiple Instance Learning, Rumor Detection, Stance Detection, Propagation Structure, Hierarchical Attention Mechanism

ACM Reference Format:

Ruichao Yang, Jing Ma*, Wei Gao, and Hongzhan Lin. 2025. LLM-Enhanced Multiple Instance Learning for Joint Rumor and Stance Detection with Social Context Information. *ACM Trans. Intell. Syst. Technol.* 0, 0, Article 0 (2025), 25 pages. <https://doi.org/XXXXXXX.XXXXXX>

1 INTRODUCTION

The rapid expansion of social networks has led to a proliferation of rumors, posing significant threats to the online community and causing detrimental consequences for individuals and society at large [45]. For instance, during the COVID-19 pandemic, a false rumor claimed that “magnetism will be generated in the body after the injection of

*Jing Ma is the corresponding author.

Authors' addresses: Ruichao Yang, csryang@comp.hkbu.edu.hk, Department of Computer Science, Hong Kong Baptist University, Hong Kong, China; Jing Ma*, majing@comp.hkbu.edu.hk, Department of Computer Science, Hong Kong Baptist University, Hong Kong, China; Wei Gao, School of Computing and Information Systems, Singapore Management University, Singapore, weigao@smu.edu.sg; Hongzhan Lin, Department of Computer Science, Hong Kong Baptist University, Hong Kong, China, cshzlin@comp.hkbu.edu.hk.

Permission to make digital or hard copies of all or part of this work for personal or classroom use is granted without fee provided that copies are not made or distributed for profit or commercial advantage and that copies bear this notice and the full citation on the first page. Copyrights for components of this work owned by others than ACM must be honored. Abstracting with credit is permitted. To copy otherwise, or republish, to post on servers or to redistribute to lists, requires prior specific permission and/or a fee. Request permissions from permissions@acm.org.

© 2025 Association for Computing Machinery.

Manuscript submitted to ACM

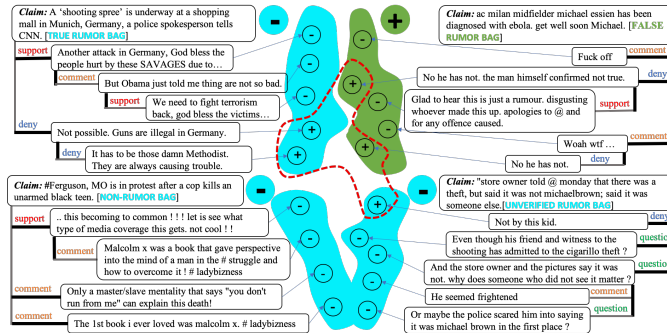

Fig. 1. An illustration of tree-based MIL binary classification for simultaneous rumor and stance detection.

coronavirus vaccine”¹. This misinformation went viral and was shared millions of times on social media platforms, contributing to public vaccination hesitancy and delaying the establishment of herd immunity.

Rumor detection typically aims to classify a piece of information, such as a given claim, into either a rumor or non-rumor [8, 49]. A noteworthy observation is that initially unverified posts, i.e., rumorously claims, may eventually be proven true, false, or a mixture of both. Therefore, a subtly different task from rumor detection is rumor verification, which involves estimating the specific veracity of a given claim related to a particular subject matter [13]. Rumor verification is, therefore, typically modeled as a multi-class rather than binary classification task. In this article, we do not make a strict distinction between these two and refer to both uniformly as rumor detection. Despite this difference, a crucial phenomenon is that posts related to rumors often trigger a wide range of mostly controversial stance expressions among online users. These stance signals have been found valuable for rumor detection in numerous previous approaches [39, 53]. While some unsupervised stance detection methods have been suggested [1, 24, 28], they tend to exhibit poor generalizability due to their reliance on manually crafted features or specific models pre-trained on certain topics or tasks, which are hardly transferable to free-form social media context. Consequently, there is a pressing need to develop a method that addresses the challenge of effective rumor-stance related tasks without assuming the availability of post-level stance labels.

To the best of our knowledge, no existing rumor-stance model has addressed the challenge of missing post stance labels while only having rumor veracity labels at the claim level, except for our recent work [16], which attempts to detect rumors and stances within a joint Multiple Instance Learning (MIL) framework using only claim veracity labels for supervision based on bottom-up/top-down propagation trees. Our approach is inspired by the observable patterns that correlate different stances with specific veracity classes of rumors. For instance, as shown in Figure 1, a false rumor claim such as “ac milan midfielder michael essien has been diagnosed with ebola” sparks both commenting, denial, and questioning posts, while a true rumor claim such as “A ‘shooting spree’ is underway at a shopping mall” mostly triggers supporting and comment posts among others. Meanwhile, the propagation structure of posts provides valuable insights into how a claim is disseminated and shaped among users over time [37, 53]. Hence, the stances expressed in these structured responses contain useful signals for assessing the nuanced veracity of a rumorously event, such as true rumor, false rumor, unverified rumor, and non-rumor. Examining the veracity of rumors reveals that false rumors tend to attract more denial posts and exhibit a more intricate chain of interactions, such as “support → deny” and “deny → support”, in contrast to true claims. Intuitively, we can deduce the stances of individual posts by initially determining the stances of key nodes directly, and then expanding to connected nodes using the distinctive edges in the response structure.

¹<https://www.bbc.com/news/av/57207134>

This paper is a substantially extended version of our previous weakly supervised approach [16], based on MIL framework [19], which allows us to jointly detect rumors and stances using only the veracity labels of rumorous claims, referred to as bag-level (or event-level) annotation. Traditionally, an MIL-based classifier is used to classify individual instances (e.g., sentences) within a bag (e.g., document) and then deduce the bag-level prediction by aggregating the instance-level predictions, relying solely on bag-level annotations for weak supervision during training. However, the original MIL framework assumes binary and homogeneous class labels at both levels. In contrast, both rumor and stance detection typically deal with multiple class labels, with distinct differences between rumor and stance classes. The main challenge lies in establishing correlations between these two different sets of class labels and making both tasks learnable within the existing MIL framework. Another challenge is how to infer from one set of classes to another based on the feature representations learned from propagation trees, which embody the essential structure of social media posts.

To address these challenges, we first convert the multi-class classification problem into multiple MIL-based binary problems. One might wonder why multiple binary MIL-based problems could perform better in the joint detection of rumor and stance. Figure 1 illustrates the intuition of our joint prediction model. In this model, we treat the combination of False rumor and Deny stance (F-D pair) as the positive class (i.e., the target class) at both bag and instance levels, while considering all other classes as negative. Assuming that rumor veracity labels include four categories, and post stance labels also consist of four categories, there exist various veracity-stance class pairs. Each veracity-stance pair can represent a target class for binary classification of claim veracity and post stance jointly. To synthesize the results from this set of veracity-stance binary classification models, we introduce a novel hierarchical attention mechanism. This serves two key purposes: (1) it aggregates the stances obtained from each binary MIL model to infer the veracity of a rumor claim, and (2) it combines the multiple binary results into a unified result that encompasses multiple classes in terms of veracity and stance.

Furthermore, to strengthen post representation within the conversational threads, inspired by the success of the transformer network, we enhance the post encoder in our previous work [16] by incorporating bottom-up/top-down tree transformers [37] to boost the post stance representation. Apart from this tree-based model, we further propose to leverage Large Language Models (LLMs) in our MIL-based framework to fully utilize the complex interactions between post pairs, overcoming the limitation of propagation directions. This is because a salient defect of our previous MIL-based approach [16] is its oversimplified correlations for inferring veracity based on stances. To address the issue, we assume that LLMs can generate explanations for each post stance regarding the rumor type of the corresponding claim. While LLMs have shown impressive capabilities in various downstream tasks, their performance in rumor-stance tasks, particularly when considering social context information, remains understudied. Directly using LLMs to predict the stance of posts may introduce unpredictable noise, making it challenging to accurately predict rumor veracity. In light of this, our work focuses on using LLMs to generate reliable explanations for post stance. Another issue of our former MIL-based approach [16] is that the model with a single propagation direction limits its broader contextual reasoning ability. To this end, we use LLM-generated explanations to enhance the representation of claims and posts, as well as the interaction between any two elements during the information dissemination process. In this way, our approach overcomes the limitation of the propagation direction, thereby improving performance in rumor-stance tasks within a unified framework.

Consequently, this paper serves as a natural follow-up of our previous work [16] with several substantial extensions: 1) We replace the original GRU-based bottom-up/top-down post encoder with a tree transformer-based framework to significantly enhance claim/post representation and robustness of the post encoder. 2) We introduce an LLM-enhanced MIL method to overcome the limitations of existing bottom-up/top-down models, which are unable to capture the complex

interactions between post pairs limited by propagation directions. 3) We design a novel hierarchical stance tree attention mechanism enhanced by the LLM-generated stance explanation to make the binary class prediction on posts and claims, focusing on utilizing the most reliable posts and improving the explainability of the classification. 4) We develop a claim-explanation-guided attention aggregation mechanism that combines stance and rumor predictions from multiple binary MIL classifiers into a unified multi-class output. This mechanism offers a more robust way to combine multiple predictions by concentrating on the informative veracity-stance pairs, improving both rumor detection and stance results. 5) Conducting systematic experiments and analyses using datasets of different languages based on Twitter and Weibo. The results demonstrate that our proposed method achieves superior performance compared to state-of-the-art methods, indicating its generalize ability across different languages and social media platforms. Our paper makes the following contributions:

- We substantially extend the initial MIL-based weakly supervised method published in our recent work [16], by proposing a novel LLM-enhanced MIL model to enhance post encoding with stance explanations generated by LLM for improved representation of claims and posts, as well as the interaction between any two elements during the information dissemination process. Our approach overcomes the limitation of the propagation direction, thereby improving performance in rumor-stance tasks within a unified framework.
- We design a hierarchical stance tree attention mechanism to leverage LLM-generated stance explanations to improve rumor detection in binary classifiers. This novel mechanism integrates both post content and stance explanation, enabling more effective representations of complex inter-post relationships.
- We propose a new technique integrating claim explanations into the final attention process for multiple binary classifiers, enhancing the final prediction by incorporating the contextual insights from these explanations.
- We achieve promising results on three widely used datasets based on Twitter and Weibo posts, demonstrating the effectiveness of our approach for both rumor and stance detection at the bag-level and post-level, respectively.

2 RELATED WORK

2.1 Rumor Detection

Early research on automatic rumor detection focused on pre-defined features or rules [43] to train supervised classification models. To circumvent tedious feature engineering, subsequent studies proposed data-driven methods based on neural network models [31, 32, 50] and multi-task learning frameworks [36, 39, 53]. Advanced approaches were then proposed to leverage propagation information [3, 33, 35, 41, 58]. In this study, we formulate our approach based on a propagation structured model, with a specific emphasis on deducing post-level stances using weak supervision with only claim-level annotation. Drawing inspiration from the efficacy of propagation information, our methods are designed based on graph structure for incorporating social context information.

2.2 Stance Detection

Manual analysis of stance has revealed a close relationship between specific veracity categories and stances [42]. Subsequent studies explored various hand-crafted features [14] for training stance detection models. More recently, deep neural networks have been employed for stance representation learning and classification [25, 29, 53, 59, 62]. However, the aforementioned methods typically require a substantial stance corpus annotated at the post level for training. While several unsupervised models based on pre-defined models [1, 24] and unsupervised structural embedding [47] for stance detection exist, their generalizability is consistently a critical concern due to their specific problem settings, reliance on manually crafted features. In this paper, we propose a weakly supervised propagation model to concurrently classify rumor veracity and post stances on social media without the need for post stance labels.

2.3 Multiple Instance Learning (MIL)

MIL is a form of weakly supervised learning designed to train a classifier with coarse-grained bag-level annotations to assign labels to fine-grained instances arranged in the bag [7]. In recent years, MIL has proven effective and found successful applications in various Natural Language Processing (NLP) tasks [56]. However, the original MIL framework is specifically designed for the binary classification of instances lacking complex structures, and bag-level labels are expected to conform to instance-level labels. In our work, we study an LLM-enhanced MIL framework to transform the multi-class problem into multiple binary classifiers, resolving the label incompatibility between bag and instance levels.

2.4 Large Language Models (LLMs)

Generative Pre-trained Transformers (GPTs) are a class of LLMs that have revolutionized artificial intelligence in recent years. The significant scientific advancements made by models such as ChatGPT [9], LLaMA [51], and ALPACA [17] have gained researchers' attention in the field of rumor detection and stance detection. Yan et al. [54] and Yang et al. [55] leveraged LLM to enhance the rumor detection, Lan et al. [26] and Gambini et al. [20] utilized LLM for stance detection. These methods primarily focus on directly predicting rumor or stance types using LLMs. In this paper, we leverage the generative capacity of LLMs to produce explanations for post stances towards claim veracity, aiming to enhance the reliability and explainability of these stances for final rumor detection.

3 PROBLEM STATEMENT

We define a rumor dataset as $\{C\}$, where each instance $C = (c, X, y)$ is a tuple consisting of a claim c , a conversation thread responding to it denoted as $X = (t_1, t_2, \dots, t_T)$, and a veracity label y of the claim. Note that although the posts are presented in chronological order, there are explicit connections such as response or repost relations among them, and message propagation paths (i.e., edges). We define the following two tasks:

- **Stance Detection:** The task is to determine the post-level stance p_i for a post t_i expressed over the veracity of claim c . That is, $f : \{c, t_1, t_2, \dots, t_T\} \rightarrow \{p_1, p_2, \dots, p_T\}$, where p_i is the stance label of t_i that takes one of Support (S), Deny (D), Question (Q), or Comment (C)², and $\{c, t_1, t_2, \dots, t_T\}$ follows specific propagation structure (e.g., time sequence, tree, or graph).
- **Rumor Detection:** The task is to classify the claim c on top of all the post stances as one of the four possible veracity labels $y \in \{\text{Non-rumor (N), True rumor (T), False rumor (F), Unverified rumor (U)}\}$. That is, $g : \{p_1, p_2, \dots, p_T\} \rightarrow y$. In our approach, we hypothesize that the task can be modeled following the weighted collective assumption of MIL in the sense that the bag-level label relies more on the vital instances [19].

4 WEAKLY SUPERVISED PROPAGATION MODEL

The central concept of our approach is around detecting rumors through a cross-checking process by examining In this section, we will revisit our existing MIL-based methods [16], discuss their limitations, and then propose an LLM-enhanced method with MIL framework for joint rumor and stance detection.

4.1 Background

The original MIL framework is specifically designed for binary classification of instances lacking complex structures, bag-level labels are expected to conform to instance-level labels [7, 19]. Given the nuanced categories of stance and

²Here the Comment is assigned to the posts that do not have clear orientations to the claim's veracity.

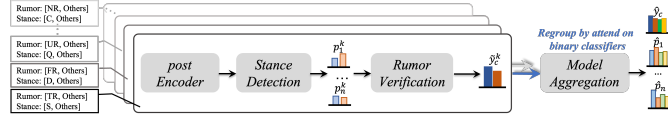

Fig. 2. An overview for our MIL-based weakly supervised framework.

rumor veracity, we initially decompose the multi-class problem into multiple binary classification problems, and then we aggregate the predicted binary classes to form multi-way classes. Without the loss of generality, let us assume the number of rumor classes is N_r and that of stance classes is N_s . As a result, there can be $K = N_r * N_s$ possible veracity-stance target class pairs, corresponding to K binary classifiers weakly supervised for concurrently detecting rumor veracity and post stance. Figure 2 provides an overview of our proposed method, which consists of the post encoder, stance detection, rumor detection, and model aggregation processes. However, existing MIL-based methods only use Gated Recurrent Unit (GRU) [5] and bottom-up/top-down tree structure to represent posts, which cannot fully utilize interactions between posts at different positions. So, we intend to get a more nuanced understanding of each post via modeling the long-distance interactions among posts.

An obvious defect of the above post representation learning process is that both bottom-up and top-down structures represent direct vertical responsive or reference relationships only, and it ignores the complex interactions between any pair of posts which could help post representation by gathering information from the other parallel informative posts. So, we disregard the direction of information flow and model the conversation topology among posts as an undirected tree, which retains the intrinsic characteristics (e.g., user stances) as described in the following section. As a result, the rumor-indicative features from the perspective of vertical and parallel perception can be fully captured.

4.2 Post Encoder

The core idea of the post encoder in the weakly supervised propagation model lies in two main considerations. The first consideration is to utilize the complex interaction between a post and its parent (i.e., the influencing factors or prior context) as well as its child nodes (i.e., the downstream effects or spread). Through this way, we can leverage the structural dependencies to better understand how a post’s state is shaped by its position within the tree. Another consideration is to resort to LLMs for generating explanations for each post’s stance.

Our proposed post encoder as shown in Figure 3, where the input of the post encoder includes a claim, its corresponding posts, and the propagation structure. To provide the structure of the conversation tree to the LLM, we prepend a prefix to each post to explicitly present the structural information of the conversation thread before the encoding process, which is illustrated in the figure. For example, the prefixes are formatted as " t_1 replied to c ", " t_2 replied to t_1 ", and so on. These prefixes provide the model with a clear structural context, facilitating a better understanding of the relationships between posts.

In order to model the interactions between words at different positions to jointly attend to the tokens from different representation spaces, we transform t_i to h_i and c to h_c with the Sentence-BERT [48]³. Let a post of word sequence $t_i = \{w_1 w_2 \cdots w_{|t_i}|\}$, where $w_j \in \mathbb{R}^d$ is a d -dimensional vector that can be initialized with pre-trained word embeddings. We represent the claim and its related posts using Sentence-BERT [48] that maps the sequence into a fixed-size vector:

$$\begin{aligned} h_c &= SBERT(w_1, w_2, \cdots, w_{|c|}, \theta_c) \\ h_i &= SBERT(w_1, w_2, \cdots, w_{|t_i|}, \theta_X) \end{aligned} \quad (1)$$

³Here we opted for Sentence-BERT as it yielded the most superior experimental results compared with other transformer architectures. Without loss of generality, Sentence-BERT can be replaced with other language models such as ELMO [15], Roberta [34], and BERT [12].

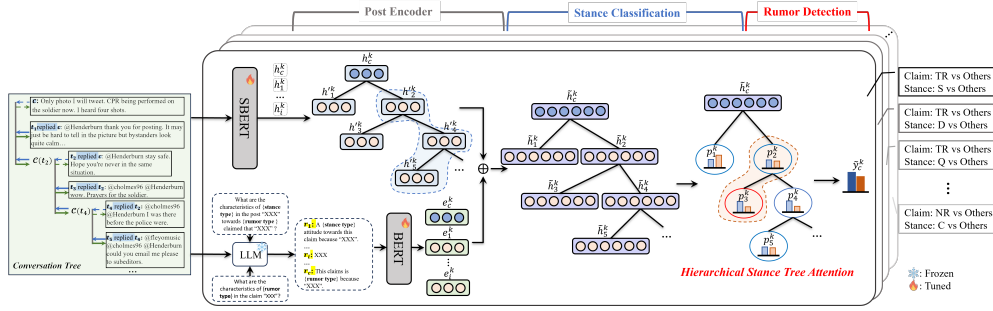

Fig. 3. A framework of LLM-enhanced weakly supervised propagation model. \tilde{h}_i^k represents the final post encoding, p_i^k denotes the stance probability of the post t_i , and \tilde{y}_c^k represents the rumor c 's veracity probability given by classifier k .

where $SBERT(\cdot)$ denotes the standard Sentence-BERT transition equations, $|\cdot|$ is the number of words, $w_{|c|}$ and $w_{|t_i|}$ are the last word of c and t_i , respectively. And θ_c and θ_X contain all the parameters in the post encoder.

4.2.1 Post-level Representation. We model the interaction among posts as an undirected tree to eliminate direction restrictions, allowing potential information flow between any pair of posts. For example, the child nodes reflect the attitude tendency towards the parent node, and the parent node guides the attitude tendency of the child node. Let $\mathcal{M}(i)$ denote the node set connected to t_i (except the source node c). The post-level representation can be updated as follows:

$$\alpha_{ij}^k = \frac{\exp(h_j^k \cdot h_i^{kT})}{\sum_{j \in \mathcal{M}(i)} \exp(h_j^k \cdot h_i^{kT})} \quad (2)$$

$$h_i^k = \rho h_i^k + (1 - \rho) \sum_{j \in \mathcal{M}(i)} \alpha_{ij}^k \cdot h_j^k$$

where α_{ij}^k denotes the attention coefficient of each neighbor node t_j of the node t_i , h_j^k denotes the post embedding obtained in Equation 1, and ρ represents the retention ratio of the current node. We empirically set ρ in our experiments.

4.2.2 Explanation-level Representation. The shallow text representation of posts above is insufficient to fully encode the underlying context and nuanced attitudes for accurately identifying rumor and stance types. Previous studies indicate that LLMs can capture intricate relationships among words, context, etc., to generate deeper semantic representations of text for rumor detection [54]. Therefore, we utilize ChatGPT⁴ to generate contextually-aware explanations, providing insights into the complex relationships between posts and their associated rumor or stance types. For example, we craft the following prompt to guide the LLM to generate stance explanations for a post:

What are the characteristics of "support stance" in the post "t₄ replied t₂: @cholmes96 @Henderburn I was there before the police were.", towards "true rumor" claimed that "c: Only photo I will tweet. CPR being performed on the soldier now. I heard four shots." ?

This example is designed to generate stance explanations for a post with a supportive stance towards a true rumor. The stance type, post content, rumor type, and claim content in the quotation marks can be directly replaced for the corresponding information of a different input. Based on the post content and stance explanations, we can further prompt the LLM to generate claim-type explanations for binary models aggregation. Here is an example prompt:

What are the characteristics of "Ture rumor" in the claim "c: Only photo I will tweet. CPR being performed on the soldier now. I heard four shots." ?

⁴ChatGPT can be replaced by other LLMs such as Llama 2 [51], OPT [60], BLOOM [27], and Claude [10] for explanation generation.

Since the generated rationales are typically longer than a post, we encode each explanation R_i with BERT [12] rather than Sentence-BERT, which yields:

$$e_c^k, e_i^k = \text{BERT}(r_c, r_1, \dots, r_{|R_i|}, \theta_r^k) \quad (3)$$

where $|\cdot|$ and $r_{|R_i|}$ denote the number of words and the last word of explanation R_i , respectively, θ_r represents the parameters in BERT encoder. Then we concatenate the post-level and explanation-level representations to get the final post representation for binary post prediction, which yields:

$$\begin{aligned} \tilde{h}_c^k &= h_c^k \oplus e_c^k \\ \tilde{h}_i^k &= h_i^k \oplus e_i^k \end{aligned} \quad (4)$$

where h_c^k is the claim embedding obtained in Equation 1, h_i^k denotes the post-level representation obtained in Equation 2, e_i^k represents the explanation-level representation obtained in Equation 3.

4.3 MIL-based Binary Stance Classification

In our LLM-enhanced weakly supervised model, each binary classifier follows a variant of standard MIL [2], where the target class is treated as positive and the other classes as negative. For classifier k , to better capture the stance of each post towards the claim, we couple each claim-post pair (c, t_i) and use a fully connected softmax layer to predict the binary stance probability distribution of t_i towards the claim vector h_c^k based on classifier k :

$$p_i^k = \text{softmax}(W_1^k \tilde{h}_i^k + W_2^k h_c^k + b_o^k) \quad (5)$$

where W_*^k are trainable weights, \tilde{h}_i^k and h_c^k are obtained in Equation 4 and Equation 2, respectively. b_o^k are the weights and bias. The probability values $\{p_i^k\}(j = 1, 2, \dots, T)$ can be considered as the stance-indicative probabilities of all the nodes inferred from the claim veracity.

The key intuition is that the binarization of the classes can be used to distinguish the salience of mappings between rumor and stance classes. So, the model can focus more on a salient subset of veracity-stance target class pairs such as F-D, T-S, U-Q, and N-C, embodying that close veracity-stance correspondences [42] will outweigh other possible pairs by using an attentive process to automatically adjust the weights of the binary models corresponding to the pairs. We will present an aggregation method in Section 4.5 to combine the predictions of binary models based on the learned weights for the final multi-class prediction.

4.4 MIL-based Binary Rumor Classification

To infer claim veracity based on the posts' stances, we propose to attend over evidential nodes within the stance tree. For this purpose, we design a *Hierarchical Stance Tree Attention Mechanism* to aggregate the stances, which consists of *Local Attention* and *Stance Explanation-guided Global Attention Mechanism*.

4.4.1 Local Attention. The Local Attention is designed to simulate the local interaction and capture the fine-grained stance tendencies in the conversation tree. For example, the child nodes tend to reflect the attitude towards their parent node, and the parent node tends to guide the attitude of its child nodes. So, we aim to integrate each node's stance with its parent and child nodes to better capture the local context. Specifically, let $\mathcal{P}(i)$ denote the node set connected to t_i

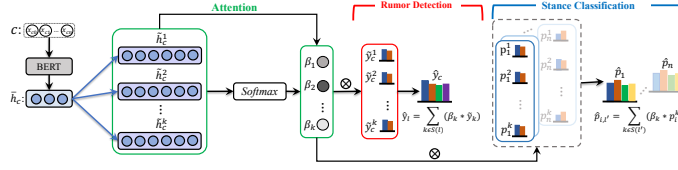

Fig. 4. The aggregation model for predicting fine-grained claim veracity and post stance, where β_k is the attention score obtained from Equation 8, \tilde{y}_k and p_i^k denote binary rumor and stance probabilities computed by the k -th classifier, respectively.

(except the source node c). The stance probability distribution of t_i can be updated as follows:

$$\alpha_{ij}^k = \frac{\exp(\tilde{h}_j^k \cdot \tilde{h}_i^{k\top})}{\sum_{j \in \mathcal{M}(i)} \exp(\tilde{h}_j^k \cdot \tilde{h}_i^{k\top})} \quad (6)$$

$$\tilde{p}_i^k = \lambda p_i^k + (1 - \lambda) \sum_{j \in \mathcal{M}(i)} \alpha_{ij}^k \cdot p_j^k$$

where α_{ij}^k denotes the attention coefficient of each neighbor node t_j of the node t_i , \tilde{p}_i denotes the updated stance probability of node t_i , and λ represents the retention ratio of the current node. We empirically set λ in our experiments.

4.4.2 Stance Explanation-guided Global Attention. Intuitively, LLM can generate explanations that align local stance interactions (e.g., post-to-claim or post-to-post) with bag-level claim veracity. So, we design global attention to differentiate the importance of different local stances enhanced by explanations for rumor veracity inference. Specifically, we first compute the attention coefficient that indicates the importance of each node towards the claim based on explanation-level representation. And then aggregate the stances according to the attention coefficients. This yields:

$$\delta_i^k = \frac{\exp(e_i^k \cdot h_c^{k\top})}{\sum_{i=1}^n \exp(e_i^k \cdot h_c^{k\top})} \quad (7)$$

$$\tilde{y}_c^k = \sum_{i=1}^n \delta_i^k \cdot \tilde{p}_i^k$$

where δ_i^k denotes the attention coefficient of each node, and \tilde{y}_c^k is the predicted probability of rumor veracity.

4.5 Binary Models Aggregation

It is intuitive to contend that each binary classifier contributes differently to the final multi-class prediction, due to the different capacity of each model capturing the veracity-stance correlation. Therefore, we design a claim explanation-guided attention mechanism to attend over the binary classifiers as shown in Figure 4. This yields:

$$\tilde{h}_c = \text{BERT}(w_1, w_2, \dots, w_{|c|}, \bar{\theta}_c)$$

$$\beta_k = \frac{\exp(\tilde{h}_c \cdot \tilde{h}_c^{k\top})}{\sum_k \exp(\tilde{h}_c \cdot \tilde{h}_c^{k\top})} \quad (8)$$

where BERT represents the standard BERT transition equation, \tilde{h}_c denotes the global representation of the claim c , $|\cdot|$ is the number of words, $w_{|c|}$ is the last word of c , $\bar{\theta}_c$ denotes all the parameters in the claim encoder⁵, and \tilde{h}_c^k is the claim representation fused with claim explanation obtained from the k -th classifier (see Equation 4).

Finally, on top of the obtained attention scores of binary models, we use a weighted aggregation method to obtain the prediction of *stance classification* and *rumor veracity* by summing over $K = N_r * N_s$ attention coefficients and K classifiers outputs:

⁵Note that the BERT transition equation has a similar yet independent set of parameters with Equation 3.

Stance Detection. For each post t_i under claim c , we obtain K probability scores from all the binary classifiers, i.e., $\{p_i^1, p_i^2, \dots, p_i^K\}$. We utilize an attention-weighted sum to get the final post-level stance prediction \hat{p}_i . We regroup all the binary stance classifiers with the same target stance class $l_s \in \{S, D, Q, C\}$ into one set and then compute the final stance probability by:

$$\hat{p}_{i,l_s} = \sum_{k \in \mathcal{I}(l_s)} \beta_k \cdot p_i^k \quad (9)$$

where $\mathcal{I}(l_s)$ represents the indicator set of the binary classifiers with l_s as the target stance class, p_i^k is the predicted stance probability of the post t_i given by classifier k , and therefore \hat{p}_{i,l_s} indicates the probability that the post t_i is classified as stance l_s . Note that these binary classifiers of the same target stance class are different models because each classifier is supervised by a different target veracity label of the claim. Thus, the final probability distribution over all the stances can be obtained as $\hat{p}_i = [\hat{p}_i^S, \hat{p}_i^D, \hat{p}_i^Q, \hat{p}_i^C]$.

Rumor Detection. We regroup all the binary claim veracity classifiers and put the classifiers with the same rumor class label $l_c \in \{N, T, F, U\}$ into one set. And then the claim veracity probability can be computed similarly to the weighted sum of all the outputs from binary rumor veracity classifiers:

$$\hat{y}_{c,l_c} = \sum_{k \in \mathcal{I}(l_c)} \beta_k \cdot \hat{y}_c^k \quad (10)$$

where $\mathcal{I}(l_c)$ is the indicator set of the binary classifiers with l_c as the target veracity class and \hat{y}_c^k is the predicted binary veracity class probability of the claim c given by the classifier k . Note that the binary veracity classifiers with the same target veracity class are distinguishable by the different target stance classes they are associated with, which give different stance probability predictions. Thus, the final probability distribution over the rumor veracity classes can be represented as $\hat{y}_c = [\hat{y}_c^N, \hat{y}_c^T, \hat{y}_c^F, \hat{y}_c^U]$.

5 MODEL TRAINING

To train each binary classifier, we transform the finer-grained rumor and stance labels into binary labels for ground-truth representation. For example, for the classifier with [T, S] (i.e., True-Support) veracity-stance pair as the target, the ground-truth veracity label of claim y is represented as either ‘T’ or ‘others’, and the model outputs the stance for each post represented by a probability belonging to target class ‘S’. A variant of this similar setting is applicable to all the binary classifiers with different target classes. This yields the way to obtain our binary ground truth:

$$y^k = \begin{cases} 1 & \text{if the target of classifier } k \text{ is the same as } y \\ 0 & \text{others} \end{cases} \quad (11)$$

where $y \in \{N, T, F, U\}$ is defined for the rumor detection task, and the ground truth refers to the veracity label of claims instead of stance due to the unavailability of the label at the post level.

Binary MIL-based Classifiers Training. All the binary classifiers are trained to minimize the negative log-likelihood between the predicted distribution of a given claim and that of the ground truth:

$$L_{bin} = - \sum_{k=1}^K \sum_{c=1}^C y_c^k * \log \hat{y}_c^k + (1 - y_c^k) * \log(1 - \hat{y}_c^k) \quad (12)$$

where $y_c^k \in [0, 1]$ indicating the ground truth of the c -th claim obtained in Equation 11, \hat{y}_c^k is the predicted probability for the c -th claim in classifier k , C is the total number of claims, and K is the number of binary classifiers.

Aggregation Model Training. To train the aggregation model, we again utilize the negative log-likelihood loss function to minimize the distribution of claim prediction and that of the ground truth:

$$L_{agg} = - \sum_{n=1}^N \sum_{m=1}^M y_{m,n} * \log \hat{y}_{m,n} + (1 - y_{m,n}) * \log(1 - \hat{y}_{m,n}) \quad (13)$$

where $y_{m,n} \in [0, 1]$ is the binary value indicating if the ground-truth rumor veracity class of the claim c_n is m , $\hat{y}_{m,n}$ is the predicted probability the claim c_n belonging to class m by Equation 10, and M is the number of rumor veracity classes.

Training Settings. During training, all the model parameters are updated by back-propagation with Adam [23] for speeding up convergence. We use pre-trained GloVe Wikipedia 6B word embeddings [46] to represent input words, set the model dimension d to 300, feed-forward network dimension to 600, and empirically initialize the learning rate as 0.001. The training process ends when the loss value converges or the maximum epoch number is met, for which we set the number of the maximum epochs as 200. We set the retention ratio of the current node $\lambda = 0.7$. We train the aggregation model after all the binary classifiers are fully trained. When training the aggregation model, only the parameter θ_a is updated while the other parameters remain unchanged.

6 EXPERIMENTS AND RESULTS

6.1 Datasets

We utilize rumor and stance datasets with propagation structure collected from Twitter⁶ and Sina Weibo⁷ as follows.

6.1.1 Datasets from Twitter. To train our model, we refer to three public benchmark datasets with claim veracity labels and propagation tree structure of claims for rumor detection task, namely Twitter15, Twitter16 [39], and PHEME⁸. In each dataset, a group of claims together with their relevant posts are provided, where the claims are treated as bags, and posts are regarded as instances. Each claim is annotated with one of the four class labels: non-rumor, true-rumor, unverified-rumor, and false-rumor. Note that only these bag-level labels are available in the training datasets. We filter out the retweets since they simply repost the claim text without providing any additional information.

For model evaluation, since both post-level stance and claim-level veracity are needed, we resort to two rumor-stance datasets namely RumorEval2019-S [13]⁹ and SemEval8 [6, 63]. The original datasets were used for joint detection of rumors and stances, where each claim is annotated with one of the three veracity classes (i.e., true-rumor, false-rumor and unverified-rumor), and each post was originally assigned one of four stances towards the claim (i.e., agreed, disagreed, appeal-for-more-information, comment). We augmented RumorEval2019-S dataset by gathering additional 100 non-rumor claims together with their relevant posts from Twitter following the method described by Zubiaga et al. [64]. Then we asked three annotators independent of this work to annotate the stance of posts, the inter-annotator agreement score based on Cohen’s kappa is 0.725. For stance labels, we convert the original labels into {S, D, Q, C} based on a set of rules proposed in [14]. Table 1 and Table 3 gives the statistics of our Twitter dataset for training and testing.

6.1.2 Dataset from Weibo. We choose a public dataset collected from Weibo¹⁰ to extend our experimental evaluation. We resort to this dataset for two reasons: (1) We conduct experiments on the Chinese dataset to demonstrate that our methods have a good generalization ability to different languages; (2) Weibo is a two-class rumor detection dataset,

⁶www.twitter.com

⁷www.weibo.com

⁸This PHEME dataset is not the one used for stance detection [64] [11]. Instead, it is defined specifically for rumor detection task: https://figshare.com/articles/PHEME_dataset_of_rumours_and_non-rumours/4010619.

⁹We only use the posts from Twitter in RumorEval2019 and discard Reddit data. Note that although the original RumorEval2019-S and SemEval8 datasets contain some same claims, we further extend RumorEval2019-S dataset by including additional 100 non-rumor samples to form a more challenging and general dataset, which includes true rumor, false rumor, unverified rumor, and non-rumor samples. Since SemEval8 only contains true rumor, false rumor, and unverified rumor samples, experiments on these two datasets can evaluate the generalization power of our methods.

¹⁰<https://www.dropbox.com/s/46r50ctrfa0ur1o/rumdect.zip?dl=0>

Table 1. Statistics of the training (left) and test datasets (right).

Statistics	Train			Test	
	Twitter15	Twitter16	PHEME	RumorEval2019-S	SemEval-8
# of Rumor categories	4	4	4	4	4
# of Stance categories	---	---	---	4	3
# of claim	1,308	818	6,425	397	297
# of Non-rumors	374 (28.6%)	205 (25.1%)	4,023 (62.6%)	100 (25.2%)	---
# of False rumors	370 (28.3%)	207 (25.3%)	638 (9.9%)	62 (15.6%)	62 (20.8%)
# of True rumors	190 (14.5%)	205 (25.1%)	1,067 (16.6%)	137 (34%)	137 (46.1%)
# of Unverified rumors	374 (28.6%)	201 (24.5%)	697 (10.8%)	98 (24.7%)	98 (33.0%)
# posts of Support	---	---	---	961 (17.8%)	645 (15.1%)
# posts of Deny	---	---	---	441 (8.1%)	334 (7.8%)
# posts of Question	---	---	---	428 (7.9%)	361 (8.5%)
# posts of Comment	---	---	---	3,583 (66.2%)	2,923 (68.6%)

and we can demonstrate that our method works well on a different classification scheme and different social media platform. Since it only has claim-level rumor labels, we sample a set of claims to annotate posts’ stances for evaluation. Due to the tremendous number of Weibo posts in each claim, we label the first 3,500 posts chronologically for each claim manually. This is to balance coverage and computational feasibility, as well as demonstrate that our model can efficiently verify the rumors being spread in the early stage of their propagation. As a result of post stance annotation, the inter-annotator agreement score based on Cohen’s kappa is 0.759. We provide the statistics of the resulting dataset in Table 2. Note that we follow the method proposed in Ma et al. [38] to simplify propagation tree structures.

Table 2. Statistics of the Weibo Dataset.

Statistic	Train	Test	Total
# source tweets	4,204	460	4,664
# non-rumors	2,121	230	2,351
# false rumors	2,083	230	2,313
# posts of Support	-	46,697 (22.70%)	-
# posts of Deny	-	26,122 (12.70%)	-
# posts of Question	-	22,144 (10.70%)	-
# posts of Comment	-	110,962 (53.90%)	-
# tree nodes	3,599,731	205,925	3,805,656
Avg. posts/tree	856	447	816
Max posts/tree	59,318	3461	59,318
Min posts/tree	10	11	10

Table 3. Statistics of stance distribution for each rumor category in Twitter Dataset.

Dataset	RumorEval2019-S				SemEval-8		
	True rumor	False rumor	Unverified rumor	Non-rumor	True rumor	False rumor	Unverified rumor
# of Support	302 (5.58%)	102 (1.88%)	241 (4.45%)	316 (5.84%)	302 (7.08%)	102 (2.39%)	241 (5.65%)
# of Deny	110 (2.03%)	88 (1.63%)	136 (2.51%)	107 (1.98%)	110 (2.58%)	88 (2.06%)	136 (3.19%)
# of Question	156 (2.88%)	50 (0.92%)	155 (2.86%)	67 (1.24%)	156 (3.66%)	50 (1.17%)	155 (3.64%)
# of Comment	1,247 (23.04%)	513 (9.48%)	1,163 (21.49%)	660 (12.19%)	1,247 (29.25%)	513 (11.45%)	1,163 (29.82%)

Table 4. Statistics of stance distribution for each rumor category in Weibo Dataset.

Statistic	True Rumor	False Rumor
# posts of Support	33,665 (16.3%)	13,032 (6.3%)
# posts of Deny	6,256 (3.0%)	19,866 (9.7%)
# posts of Question	8,272 (4.0%)	13,872 (6.8%)
# posts of Comment	40,966 (19.9%)	69,996 (34.0%)

6.2 Experimental Setup

We hold out 30% of the test sets as validation data for tuning hyper-parameters. Due to the imbalanced rumor and stance class distribution, we adopt AUC, micro-averaged and macro-averaged F1 scores, and class-specific F-measure as evaluation metrics in addition to accuracy. We implement all the neural models with Pytorch. When testing on RumorEval2019-S

dataset, we train 16 binary classifiers in total considering that there are 4 veracity and 4 stance categories to be determined. And we train 12 binary stance classifiers for testing on SemEval-8 dataset since it contains 3 veracity and 4 stance categories. There are 2 veracity and 4 stance categories in the Weibo dataset, so we develop 8 binary weak classifiers for it.

6.3 Stance Detection Performance

Since our stance detection model is weakly supervised by coarse label (i.e., claim veracity) instead of explicit post-level stance label, we choose to compare with both unsupervised methods and supervised methods: (1) **C-GCN** [53]: An unsupervised graph convolutional network that classifies the stances by modeling tweets with conversation structure. (2) **Zero-Shot** [1]: A pre-trained stance detection method that captures relationships between topics, without the need of training examples. (3) **Pre-Rule** [24]: An unsupervised method to detect the stance in online debates by identifying effect words based on the pre-defined rules which are designed for support and deny stance. (4) **BerTweet** [44]: A language model pre-trained on 850M tweets, which is applied here for post stance detection. (5) **BrLSTM** [25]: An LSTM-based model that models the conversational branch structure of posts to detect stance. (6) **MT-GRU** [39]: A multi-task learning model based on RNN to jointly detect rumors and stances by learning the common and task-invariant features. (7) **PE-HCN** [62]: A stance detection method based on the hierarchical capsule network. (8) **JointCL** [29]: A zero-shot stance detection model utilizing contrastive learning. (9) **Llama 2-ST** [51]: A pre-trained large language model developed by Meta for only stance detection task. (10) **Llama 2-MT** [51]: A pre-trained large language model prompted to perform multi-tasks of stance detection and rumor verification together. (11) **ChatGPT-ST** [9]: A pre-trained large language model developed by OpenAI for only stance detection task. (12) **ChatGPT-MT** [9]: A pre-trained large language model prompted to perform multi-tasks of stance detection and rumor verification together. (13) **BU/TD-MIL (TRAINSET)** [16]: Our MIL-based weakly supervised method with bottom-up/top-down GRU post encoder [40] for stance detection trained on different **TRAINSET**¹¹. For the supervised baselines in particular, we use the corresponding validation sets, denoted as **V**¹², to train them since they need stance labels of posts which do not exist in the **TRAINSET**. To make a fair comparison with these supervised stance detection baselines that are trained on validation sets, we also train our models on the same data although only claim veracity labels are used. (14) **JSDRV** [55]: A joint stance detection and rumor verification framework that leverages large language models as the foundation annotators. (15) **BU/TD-MILE (TRAINSET)**: Our enhanced MIL-based weakly supervised stance detection model trained on different **TRAINSET** with bottom-up/top-down tree transformer [37] post encoder. (16) **LLM-MIL (TRAINSET)**: Our proposed LLM-enhanced MIL framework for stance detection trained on different **TRAINSET**, which allows information flowing between post pairs.

In Table 5 and Table 6, we use the open-source of Zero-Shot and Pre-rule, which does not report AUC. C-GCN, Zero-shot, Pre-Rule, and BerTweet are models without the need of annotated data for stance detection, while BrLSTM, MT-GRU, PE-HCN, and JointCL are four popular supervised stance detection baseline models. Because they need post-level stance labels which is not available in the training set, we use the post stance annotation in the validation datasets left out from RumorEval2019-S, SemEval-8, and Weibo to train them. To make a comparison with these supervised baselines with the same training data, we train a variant of our methods (i.e., TD/BU-MIL (V), TD/BU-MILE (V), and LLM-MIL (V)) using the same validation dataset by only using the claim veracity labels.

¹¹**TRAINSET** can be **T15**, **T16** and **Phe**, which are the short-forms of Twitter15, Twitter16 and PHEME datasets, respectively.

¹²**V** is the corresponding validation sets used to train models from RumorEval2019-S, SemEval-8 or Weibo datasets where models are tested.

Table 5. Comparison with baselines for stance detection in Twitter Platform. (S: Support; D: Deny; Q: Question; C: Comment)

Dataset	RumorEval2019-S							SemEval8						
	AUC	MicF	MacF	S F1	D F1	Q F1	C F1	AUC	MicF	MacF	S F1	D F1	Q F1	C F1
C-GCN	0.633	0.629	0.416	0.331	0.173	0.429	0.730	0.610	0.625	0.411	0.327	0.161	0.430	0.728
Zero-Shot	-	0.369	0.324	0.301	0.168	0.342	0.486	-	0.383	0.344	0.278	0.162	0.480	0.456
Pre-Rule	-	0.605	0.478	0.657	0.419	-	-	-	0.429	0.389	0.432	0.644	-	-
BerTweet	0.643	0.619	0.492	0.497	0.203	0.513	0.753	0.621	0.611	0.428	0.512	0.131	0.326	0.742
BrLSTM (V)	0.710	0.660	0.420	0.460	0.000	0.391	0.758	0.676	0.665	0.401	0.493	0.000	0.381	0.730
MT-GRU (V)	0.714	0.636	0.432	0.313	0.156	0.506	0.748	0.669	0.630	0.413	0.498	0.116	0.312	0.729
PE-HCN (V)	0.714	0.638	0.499	0.401	0.374	0.471	0.751	0.670	0.635	0.493	0.410	0.360	0.452	0.750
JointCL (V)	0.716	0.639	0.505	0.532	0.210	0.516	0.760	0.678	0.640	0.475	0.536	0.136	0.478	0.751
Llama 2-ST	0.649	0.630	0.500	0.501	0.203	0.532	0.763	0.647	0.631	0.471	0.533	0.138	0.472	0.740
Llama 2-MT	0.647	0.632	0.500	0.502	0.199	0.533	0.766	0.649	0.630	0.473	0.534	0.142	0.471	0.742
ChatGPT-ST	0.650	0.632	0.505	0.502	0.201	0.538	0.780	0.648	0.631	0.473	0.540	0.135	0.478	0.739
ChatGPT-MT	0.650	0.632	0.506	0.510	0.210	0.534	0.770	0.650	0.635	0.476	0.536	0.145	0.478	0.745
BU-MIL	0.707	0.665	0.432	0.344	0.174	0.445	0.762	0.666	0.642	0.420	0.329	0.169	0.423	0.758
TD-MIL	0.722	0.691	0.434	0.344	0.179	0.467	0.767	0.669	0.651	0.426	0.335	0.175	0.430	0.763
JSDRV	0.725	0.723	0.605	0.546	0.476	0.595	0.801	0.725	0.705	0.522	0.563	0.216	0.506	0.801
BU-MILE (V)	0.719	0.644	0.522	0.536	0.255	0.516	0.780	0.690	0.666	0.475	0.534	0.130	0.479	0.756
BU-MILE (T15)	0.730	0.682	0.546	0.562	0.310	0.525	0.786	0.713	0.674	0.488	0.549	0.145	0.487	0.770
BU-MILE (T16)	0.728	0.681	0.539	0.558	0.291	0.526	0.779	0.701	0.678	0.488	0.552	0.145	0.482	0.771
BU-MILE (Phe)	0.730	0.685	0.596	0.532	0.482	0.589	0.780	0.711	0.679	0.530	0.535	0.297	0.587	0.701
TD-MILE (V)	0.718	0.660	0.526	0.542	0.269	0.523	0.771	0.700	0.669	0.479	0.540	0.126	0.480	0.770
TD-MILE (T15)	0.729	0.693	0.524	0.570	0.217	0.528	0.779	0.716	0.676	0.497	0.570	0.150	0.489	0.780
TD-MILE (T16)	0.729	0.692	0.542	0.560	0.300	0.526	0.780	0.700	0.679	0.492	0.556	0.149	0.485	0.778
TD-MILE (Phe)	0.731	0.694	0.543	0.554	0.298	0.536	0.783	0.720	0.680	0.506	0.539	0.209	0.497	0.780
LLM-MIL (V)	0.720	0.670	0.533	0.558	0.278	0.519	0.778	0.690	0.671	0.490	0.543	0.151	0.483	0.782
LLM-MIL (T15)	0.732	0.683	0.570	0.549	0.385	0.547	0.799	0.713	0.678	0.505	0.575	0.170	0.470	0.805
LLM-MIL (T16)	0.735	0.698	0.570	0.540	0.383	0.558	0.799	0.702	0.697	0.508	0.567	0.189	0.480	0.796
LLM-MIL (Phe)	0.734	0.725	0.600	0.551	0.482	0.567	0.800	0.729	0.708	0.512	0.565	0.218	0.464	0.801

6.3.1 *Twitter Dataset.* In Table 5, the first group refers to unsupervised baselines. Zero-Shot and Pre-Rule perform worse than other methods, as they are pre-trained models based on out-of-domain data and cannot generalize well to Twitter data. The results on Q and C by Pre-Rule are absent since its pre-defined linguistic rules are designed for identifying the stance of Support and Deny only. The propagation-based method C-GCN performs better since it attempts to capture structural information in propagation by modeling the neighbors of each post. BerTweet performs best in the first group as it is a BERT-based language model fine-tuned on an enormous Twitter dataset before being applied to downstream tasks.

The second group considers supervised baselines. MT-GRU performs worse than PE-HCN and JointCL, we speculate that this may be because both PE-HCN and JointCL utilize propagation information. And JointCL performs better among them by leveraging of both context-aware and target-aware features in a contrastive framework, which is beneficial to generalize the stance features to unseen data. BrLSTM improves unsupervised baselines with a large margin in terms of Micro-F1, as BrLSTM is focused on modeling complex propagation structures while MT-GRU is a sequential model. But BrLSTM is poor at classifying denial stance as it is data-driven and the proportion of the denying stance is relatively small in the training data. Our method LLM-MIL (V) outperforms the supervised models clearly in micro-F1 and macro-F1 under the supervision of claim veracity labels only, demonstrating the superiority of our models compared to the fully supervised ones.

The third group includes results of using LLMs such as Llama 2 and ChatGPT. While Llama 2-ST/MT and ChatGPT-ST/MT outperform all unsupervised baselines, directly using them for stance detection yields unsatisfactory results compared to the supervised model. Furthermore, the performance of the different versions (ST and MT) of Llama 2 and

ChatGPT is on the par, suggesting that directly prompting these models to perform both tasks simultaneously yields similar results to performing them separately.

The fourth group consists of weakly supervised methods previously proposed by et al [16] and Yang et al. [55]. The fifth group contains our enhanced weakly supervised models that leverage bottom-up/top-down tree transformer [37] as a post encoder. JS DRV performs best because it leverages LLMs as a basic annotator, together with reinforcement learning continuously fine-tuning the model to select high-quality post-stance pairs, thereby mitigating the influence of noise. BU/TD-MILE (V) outperforms BU/TD-MIL (V), and BU/TD-MILE (Phe) achieves superior performance than BU/TD-MIL (Phe) in the stance detection task, as BU/TD-MILE utilizes the tree transformer, which can learn the latent representation of long dependency between words in a post and meaning interaction of posts in a subtree. Moreover, TD-MILE performs comparably with BU-MILE, while the top-down variants appear a little bit better, which indicates that although both benefit from the structure information utilizing tree transformer, the bottom-up model may suffer from larger information loss. This result is consistent with the findings presented in [37, 40].

Our LLM-enhanced MIL method achieves the best Micro-F1 score when trained on the PHEME dataset, which has significantly exceeded all methods when training data is large enough. It suggests that the LLM-enhanced MIL framework is not limited by propagation direction and can make better use of the propagation structure and LLMs than any other baseline methods. We also observe that JS DRV achieves the best Macro-F1 score, followed by LLM-MIL(Phe). The class-specific F1 score improves for the "Support" and "Deny" categories, but decreases for the "Question" category substantially. This might be because questioning posts often contain inherent doubts and uncertainties, so LLMs might struggle to capture the key clues, leading to hallucinations and generating unreliable explanations. In particular, BU-MILE, TD-MILE, and LLM-MIL (Phe) perform better than their counterparts trained on Twitter15/16 datasets. This might be attributed to PHEME containing more claims than Twitter15/16 for weak supervision. We conjecture that the performance of our method can be further improved when trained on larger datasets.

6.3.2 Weibo Dataset. The stances in the Weibo dataset are labeled with four-way classes (Support, Deny, Comment, and Question), and Table 6 shows the stance detection result across all the compared methods. At first glance, Weibo data follows a similar performance to Twitter data. However, there are still significant differences worth discussing.

Among unsupervised baselines, BerTweet performs worse than C-GCN and Pre-Rule, as BerTweet is fine-tuned with the Chinese language whereas it is pre-trained on the English language corpus. Unsurprisingly, it may not perform as well as it should. However, BerTweet performs better than Zero-Shot, indicating that a large amount of training corpus still has a strong inspiring effect on the unknown post representation learning process. The second and third group shows a similar performance compared with the Twitter dataset, which is also a four-category classification problem on social media with regard to user opinions.

The fourth group consists of our weakly supervised method BU/TD-MIL proposed in et al [16] and Yang et al. [55], and the fifth group refers to our enhanced weakly supervised methods with bottom-up/top-down tree transformer [37] post encoder. It is worth mentioning that TD-MILE (V) outperforms JointCL (V) on the Weibo dataset, indicating that our MIL-based method has the potential to surpass supervised models. This might be because the prototype generation process in JointCL is designed for the English corpus and the generalization to the Chinese corpus is limited.

Our proposed LLM-enhanced MIL models still outperform all the baselines on Micro-F1 score, and only underperform JS DRV on Macro-F1 score, which is consistent with the results we have obtained on the three Twitter datasets. We conjecture that our models enhance the representation learning of content information while the important backbone structural information can also be retained.

Table 6. Comparison with baselines for stance detection on Weibo Dataset. (S: Support; D: Deny; Q: Question; C: Comment)

Method				S	D	Q	C
	AUC	MicF	MacF	F1	F1	F1	F1
C-GCN	0.630	0.631	0.417	0.329	0.172	0.433	0.732
Zero-Shot	-	0.371	0.325	0.311	0.169	0.343	0.476
Pre-Rule	-	0.615	0.536	0.651	0.421	-	-
BerTweet	0.625	0.601	0.405	0.339	0.140	0.402	0.738
BrLSTM (V)	0.709	0.650	0.404	0.462	0.000	0.392	0.763
MT-GRU (V)	0.716	0.634	0.433	0.316	0.155	0.509	0.752
PE-HCN (V)	0.715	0.639	0.464	0.435	0.201	0.465	0.754
JointCL (V)	0.719	0.652	0.492	0.499	0.211	0.500	0.756
Llama 2-ST	0.713	0.629	0.424	0.395	0.161	0.373	0.765
Llama 2-MT	0.712	0.629	0.424	0.391	0.160	0.375	0.763
ChatGPT-ST	0.715	0.631	0.425	0.397	0.167	0.370	0.767
ChatGPT-MT	0.716	0.632	0.424	0.389	0.170	0.374	0.764
BU-MIL	0.719	0.650	0.532	0.518	0.360	0.505	0.748
TD-MIL	0.719	0.653	0.549	0.520	0.365	0.569	0.743
JSDRV	0.721	0.690	0.578	0.548	0.385	0.612	0.766
BU-MILE (V)	0.719	0.651	0.535	0.529	0.371	0.520	0.720
BU-MILE	0.722	0.680	0.573	0.544	0.380	0.606	0.761
TD-MILE (V)	0.720	0.655	0.537	0.530	0.375	0.520	0.723
TD-MILE	0.721	0.683	0.574	0.544	0.382	0.609	0.761
LLM-MIL (V)	0.720	0.663	0.540	0.539	0.375	0.519	0.726
LLM-MIL	0.722	0.699	0.570	0.549	0.389	0.574	0.768

Table 7. Results on Rumor Detection in Twitter Platform. (N: Non-rumor; F: False rumor; T: True rumor; U: Unverified rumor)

Dataset	RumorEval2019-S							SemEval8					
	AUC	MicF	MacF	T	F	U	N	AUC	MicF	MacF	T	F	U
F1				F1	F1	F1	F1				F1	F1	
AE	0.601	0.513	0.487	0.562	0.307	0.479	0.601	0.569	0.502	0.439	0.403	0.398	0.517
UFD	0.672	0.567	0.549	0.568	0.483	0.506	0.641	0.491	0.505	0.507	0.500	0.439	0.583
BerTweet	0.693	0.752	0.729	0.755	0.647	0.699	0.813	0.684	0.660	0.697	0.708	0.624	0.756
pVAE	0.690	0.748	0.730	0.762	0.658	0.690	0.810	0.685	0.657	0.697	0.700	0.633	0.758
GCAN	0.693	0.645	0.253	0.249	0.310	0.113	0.339	0.688	0.645	0.255	0.241	0.326	0.198
TD-RvNN	0.881	0.753	0.727	0.755	0.666	0.673	0.815	0.885	0.748	0.694	0.712	0.617	0.753
PLAN	0.892	0.800	0.792	0.819	0.760	0.780	0.812	0.880	0.794	0.753	0.741	0.694	0.825
DDGCN	0.897	0.806	0.795	0.835	0.763	0.766	0.817	0.890	0.796	0.753	0.741	0.694	0.825
Llama 2-ST	0.682	0.754	0.450	0.660	0.271	0.400	0.469	0.682	0.746	0.424	0.632	0.260	0.380
Llama 2-MT	0.685	0.758	0.465	0.678	0.301	0.403	0.478	0.682	0.756	0.427	0.635	0.263	0.382
ChatGPT-ST	0.682	0.756	0.465	0.678	0.301	0.403	0.478	0.680	0.758	0.430	0.638	0.263	0.390
ChatGPT-MT	0.686	0.762	0.470	0.680	0.311	0.409	0.480	0.683	0.758	0.430	0.638	0.268	0.384
BU-MIL	0.904	0.776	0.763	0.793	0.666	0.770	0.833	0.902	0.763	0.729	0.728	0.649	0.809
TD-MIL	0.917	0.809	0.776	0.826	0.659	0.669	0.852	0.908	0.798	0.741	0.741	0.672	0.810
JSDRV	0.908	0.842	0.804	0.829	0.774	0.824	0.787	0.909	0.834	0.784	0.820	0.741	0.792
BU-MILE (T15)	0.906	0.815	0.782	0.826	0.758	0.717	0.827	0.910	0.808	0.759	0.756	0.693	0.828
BU-MILE (T16)	0.901	0.810	0.786	0.825	0.762	0.719	0.838	0.899	0.800	0.755	0.759	0.692	0.814
BU-MILE (Phe)	0.915	0.816	0.785	0.825	0.770	0.715	0.830	0.910	0.810	0.758	0.763	0.698	0.813
TD-MILE (T15)	0.908	0.816	0.786	0.829	0.760	0.720	0.835	0.910	0.808	0.764	0.776	0.700	0.816
TD-MILE (T16)	0.909	0.813	0.789	0.828	0.760	0.729	0.839	0.898	0.803	0.769	0.771	0.709	0.827
TD-MILE (Phe)	0.901	0.820	0.789	0.829	0.761	0.738	0.828	0.910	0.811	0.775	0.778	0.711	0.836
LLM-MIL (T15)	0.908	0.846	0.783	0.830	0.778	0.802	0.722	0.908	0.831	0.780	0.827	0.749	0.767
LLM-MIL (T16)	0.901	0.846	0.789	0.839	0.774	0.806	0.737	0.900	0.835	0.781	0.829	0.749	0.765
LLM-MIL (Phe)	0.920	0.848	0.802	0.840	0.779	0.812	0.777	0.912	0.836	0.781	0.831	0.742	0.771

6.4 Rumor Detection Performance

We compare our methods with the following state-of-the-art structured and unstructured rumor detection baselines: (1) **AE** [61]: An unsupervised method based on autoencoder to perform rumor detection. (2) **UFD** [57]: An unsupervised

Table 8. Rumor Detection Results on Weibo Dataset.

Method				Rumor			Non-Rumor		
	AUC	MicF	MacF	Pre.	Rec.	F1	Pre.	Rec.	F1
AE	0.625	0.620	0.594	0.631	0.567	0.597	0.572	0.610	0.590
UFD	0.737	0.635	0.624	0.645	0.609	0.626	0.604	0.639	0.621
BerTweet	0.806	0.854	0.728	0.751	0.713	0.732	0.700	0.752	0.725
ptVAE	0.805	0.856	0.732	0.76	0.71	0.734	0.703	0.759	0.730
GCAN	0.903	0.848	0.738	0.738	0.73	0.734	0.719	0.766	0.742
TD-RvNN	0.968	0.946	0.938	0.942	0.95	0.946	0.910	0.953	0.931
PLAN	0.962	0.948	0.935	0.942	0.938	0.940	0.910	0.950	0.930
GAN	-	0.952	0.943	0.940	0.956	0.948	0.952	0.923	0.937
DDGCN	0.960	0.940	0.934	0.945	0.938	0.941	0.914	0.938	0.926
Llama 2-ST	0.814	0.860	0.734	0.756	0.731	0.743	0.714	0.736	0.725
Llama 2-MT	0.814	0.861	0.735	0.758	0.729	0.743	0.715	0.740	0.727
ChatGPT-ST	0.813	0.865	0.738	0.763	0.729	0.746	0.718	0.742	0.730
ChatGPT-MT	0.815	0.866	0.739	0.76	0.732	0.746	0.721	0.745	0.733
BU-MIL	0.893	0.948	0.932	0.959	0.925	0.942	0.910	0.933	0.921
TD-MIL	0.895	0.949	0.935	0.953	0.941	0.947	0.912	0.935	0.923
JSDRV	0.968	0.960	0.945	0.961	0.955	0.958	0.920	0.944	0.932
BU-MILE	0.972	0.958	0.939	0.96	0.948	0.954	0.914	0.936	0.925
TD-MILE	0.970	0.959	0.940	0.958	0.949	0.953	0.917	0.938	0.927
LLM-MIL	0.972	0.963	0.944	0.961	0.957	0.959	0.919	0.940	0.929

rumor detection method based on user opinion and user credibility. (3) **BerTweet** [44]: A language model pre-trained on 850M tweets, which is applied here for rumor detection. (4) **ptVAE** [18]: A tree variational autoencoder model for unsupervised rumor detection leveraging tree propagation structure. (5) **GCAN** [35]: A graph-aware co-attention model utilizing retweet structure to verify the source tweet. (6) **TD-RvNN** [38]: A tree-structured attention network for rumor detection with top-down propagation structure. (7) **PLAN** [22]: A transformer based rumor detection model utilizing user interactions. (8) **GAN** [41]: A transformer-based detection model leveraging generative adversarial learning¹³. (9) **DDGCN** [50]: A rumor detection utilizing the dynamics of propagation messages and external background knowledge. (10) **Llama 2-ST/MT** [51]: A large language model pre-trained on various domains myriad corpus, we use it for single rumor verification task, and joint stance detection and rumor verification task, respectively. (11) **ChatGPT-ST/MT** [9]: A large language model developed by OpenAI, we use it for single rumor verification task, and joint detection of stance and rumor veracity, respectively. (12) **BU/TD-MIL(TrainSet)** [16]: Our MIL-based weakly supervised method with bottom-up/top-down GRU post encoder [40] for rumor detection trained on different TrainSet. (13) **JSDRV** [55]: A joint stance detection (SD) and rumor verification framework that leverages large language models as the foundation annotators. (14) **BU/TD-MILE(TrainSet)**: Our enhanced MIL-based weakly supervised rumor detection method trained on different TrainSet utilizing bottom-up/top-down tree transformer [37] as post encoder. (15) **LLM-MIL(TrainSet)**: Our newly proposed MIL-based model with graph transformer trained on different TrainSet for rumor detection.

6.4.1 Twitter Dataset. In Table 7, the first group relates to unsupervised baselines. AE and UFD perform worse than ptVAE, as AE and UFD merely rely on content and user information while ptVAE additionally utilizes propagation structure with a variational autoencoder. BerTweet outperforms ptVAE slightly, considering it is a large language model trained on an enormous tweets corpus and has better generalizability to unseen data.

The second group consists of supervised baselines. We observe that GCAN is worse than the other systems, which only consider local structures, such as direct neighborhoods. In contrast, TD-RvNN models the global propagation contexts by aggregating the entire propagation information recursively. PLAN outperforms TD-RvNN as it incorporates

¹³Generative adversarial learning is usually applied in two category samples. So, we only report experimental results on the Weibo dataset. And the original code does not report the AUC score.

post-level cross-attention, taking into account the interaction of any pair of posts, which has superior representation ability than RvNN. DDGCN performs best across all supervised baselines given that it not only incorporates the dynamics of message propagation feature but also considers the dynamics of background knowledge in a unified framework, which provides additional evidential information.

The third group includes LLMs like Llama 2 and ChatGPT. While Llama 2-ST/MT and ChatGPT-ST/MT outperform all unsupervised baselines, they perform worse in rumor detection compared to the supervised model, indicating that directly using LLMs to predict rumors may suffer from inherent issues of LLMs.

The fourth group refers to weakly supervised methods proposed in et al [16] and Yang et al. [55], and the fifth group refers to our enhanced weakly supervised methods that replace GRU post encoder with tree transformer, as aforementioned. We can see that BU/TD-MILE surpasses BU/TD-MIL by a large margin in the rumor detection task across all training datasets. This can be attributed to the capability of BU/TD-MILE that not only utilizes propagation structure but also leverages the tree transformer to model the long dependency between words as well as posts, which further enhances the post representation. Furthermore, TD-MILE outperforms BU-MILE, as the former considers both local and global contexts while the latter only considers the local contexts during the stance aggregation process. We also observe that our enhanced weakly supervised methods outperform all the unsupervised and supervised baselines on all the training sets, demonstrating the strength of representation enhanced by the tree transformer.

Our LLM-enhanced MIL method achieves the best Micro-F1 score when trained on the PHEME dataset, which has significantly exceeded all methods when training data is large enough. It suggests that the LLM-enhanced MIL framework is not limited by propagation direction and can make better use of the propagation structure and LLMs than any other baseline methods. We observe that JS DRV achieves the best Macro-F1 score, followed by LLM-MIL(Phe). Similarly, the class-specific F1 score gets improved for the "Support" and "Deny" categories while dropping for the "Question" category substantially due to the similar reason of hallucinations and generation of unreliable explanations. In particular, BU-MILE, TD-MILE, and LLM-MIL (Phe) perform better than their counterparts trained on Twitter15/16 datasets. This might be attributed to PHEME containing more claims than Twitter15/16 for weak supervision. We conjecture that the performance of our method can be further improved when trained on larger datasets.

Our LLM-enhanced MIL method achieves better Micro- and Macro-F1 scores compared with TD-MILE (Phe) on the test sets. This can be explained by our design that LLM-MIL not only uses graph attention and explanations generated by ChatGPT for post representation but also aggregates stances with the graph-based attention mechanism, which can capture complex interactions between related posts under each claim and promote the impact of indicative stances on the rumor detection task. In contrast, TD-MILE only utilizes local subtree contexts for post representation. Meanwhile, the PHEME dataset has more claims and relevant posts than the Twitter15 and Twitter16 datasets, making the relationship between posts naturally more complex. Then graph attention and ChatGPT can take advantage of the complex graph structure. We also observe that our LLM-enhanced method achieves the best Micro-F1 score when trained on the PHEME dataset, while JS DRV achieves the best Macro-F1 score, followed by LLM-MIL (Phe). The class-specific F1 score is improved for "True Rumor" and "False Rumor" categories, but worsens for the "Unverified Rumor" and "Non Rumor" categories, implying hallucination of ChatGPT with questioning posts, which could harm the model's ability to identify unverified rumors and non-rumors.

6.4.2 Weibo Dataset. The claims in the Weibo dataset are labeled with two categories (e.g., rumor, and non-rumor). While a similar trend of performance on Weibo dataset is observed in Table 7, there are some salient differences compared with multi-category classification results.

Different from the multi-class dataset on Twitter, ptVAE outperforms BerTweet in the first group. This might suggest that binary classification is less challenging than finer-grained classification and the propagation-based autoencoder can introduce extra structure for post representation learning. Meanwhile, BerTweet, which is pre-trained on English datasets, has not been fine-tuned on the Chinese Weibo dataset. Therefore, the performance of BerTweet can be somewhat limited.

In the second group relating to supervised methods, PLAN outperforms DDGCN. This can be explained by the intuition that the transformer-based PLAN model can enhance the representation of different features of samples under the long dependency posts structure, while the external knowledge utilized in DDGCN may scatter the attention of the model given a large undirected graph. It is worth noting that GAN performs best among all the supervised baselines. This implies that generative adversarial learning can improve the feature learning process of samples in two opposing types, which shows superior classification capabilities on unseen data.

The third group shows a similar trend compared with the Twitter dataset. And in the fourth group, BU-MIL underperforms PLAN, GAN, and DDGCN and achieves comparable results on MicF with TD-RvNN. We speculate that PLAN and GAN both utilize a transformer model that has a strong ability in post representation, while BU-MIL just uses a GRU encoder. However, in the fifth group, BU/TD-MILE outperforms all the baselines as BU/TD-MILE can fully utilize both stance features and structure information explicitly with the graph structure.

Finally, our LLM-MIL performs only worse than JS DRV with the decreased class-specific F1 score of "Non Rumor" class. However, it performs best compared with all other models on Micro-F1 score, thanks to its improved post representation with ChatGPT and the hierarchical stance graph attention mechanism that can capture complex post interaction and rumor indicative features.

6.5 Ablation Study

To evaluate the impact of each component, we perform an ablation study based on the best-performed LLM-MIL (Phe) models on RumorEval2019-S dataset by removing some components: (1) **w/o s**: remove post-level representation that realized in Equation 2; (2) **w/o e**: remove explanation-level attention that realized in Equations 3; (3) **w/o p**: replace the post encoder (Equations 1-3) with GRU; (4) **w/o o**: remove the local attention mechanism (realized in Equation 6) in stance aggregation process; (5) **w/o g**: replace the global attention mechanism (realized in Equation 7) with mean operator for stance aggregation; (6) **w/o h**: replace the hierarchical attention mechanism (Equation[6-7]) with general dot product attention [52] for stance aggregation; (7) **w/o a**: replace the explanation guided attention mechanism (Equations 8-10) in binary classifiers aggregation process with mean operator.

As shown in Table 9, every ablation leads to a deterioration of the results, which demonstrates these components' importance. **w/o s** implies that post-level representation can help stance representation. **w/o e** indicates that the explanation-level representation generated by LLM is useful to our method. And **w/o p** indicates that replacing token-level and post-level representation with GRU further reduces the performance of our model, demonstrating the effectiveness of the post-level representation. **w/o o** entails that the local attention mechanism improves the stance aggregation process in the model. **w/o g** exhibits that the global attention mechanism is more vital than the local attention mechanism to stance aggregation. **w/o h** reveals that our claim-guided hierarchical attention mechanism can effectively combine the local and global attention from the two different levels. **w/o a** gets the lowest performance scores, where AUC, MicF, and MacF decrease about 8%, 21%, and 27% for rumor detection and 12%, 24%, and 22% for stance detection, which suggests that binary classifiers aggregation based on weighted collective attention mechanism is the most important component in our method.

Table 9. Ablation study results.

Method	Rumor Result			Stance Result		
	AUC	MicF	MacF	AUC	MicF	MacF
w/o s	0.918	0.832	0.800	0.734	0.693	0.566
w/o e	0.917	0.819	0.798	0.732	0.692	0.562
w/o p	0.914	0.821	0.783	0.727	0.674	0.553
w/o o	0.915	0.825	0.795	0.729	0.686	0.560
w/o g	0.915	0.822	0.795	0.726	0.685	0.555
w/o h	0.911	0.815	0.776	0.725	0.673	0.551
w/o a	0.912	0.814	0.771	0.722	0.672	0.548
LLM-MIL	0.920	0.848	0.802	0.734	0.725	0.600

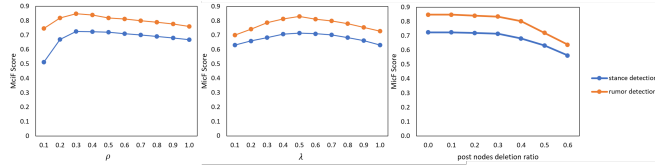
Fig. 5. Impact of the retention ratio ρ , λ , and the ratio of post node deletion for rumor and stance detection tasks.

6.6 Sensitivity Study

We conduct a sensitivity study to see the impact of the hyper-parameter retention ratio ρ for post-level representation and λ in local attention for binary rumor classification. Additionally, we also conduct a study to see the impact of randomly deleting posts nodes for final experiment results. Using LLM-MIL (PHEME) model, we show the variation of micF score on stance and rumor detection tasks with different ρ , λ , and the ratio of post nodes deletion. We present the performance of (a) various values of ρ with $\lambda = 0.5$, (2) different values of λ with $\rho = 0.5$, and (c) different ratios of post nodes deletion with $\rho = 0.3$ and $\lambda = 0.5$. Figure 5 indicates that (1) when the retention ratio $\rho = 0.3$, the performance of LLM-MIL(PHEME) reaches its peak; (2) when retention ratio $\lambda = 0.5$, the performance of LLM-MIL(PHEME) reaches its peak; and (3) when the ratio of post nodes deletion reaches 0.3, the performance of LLM-MIL(PHEME) begins to decline, suggesting that our model is basically resilient to incomplete propagation structure and noise.

6.7 Case Study

To get an intuitive understanding of the LLM-MIL models’ weak binary classifiers and final aggregation model, we design experiments to analyze the behavior of LLM-MIL (PHE) to gain insights into its superior performance in the group of LLM-MIL models.

6.7.1 Case Study for Weak Binary Classifiers. To get an intuitive understanding of the *Hierarchical Stance Tree Attention Mechanism*, we sample two graphs from RumorEval2019-S test set that the source claims have been correctly classified as True and False rumor, and show their corresponding local and stance explanation-guided global attention.

For local attention, we only show one node and its neighbors’ averaged local attention scores over all the binary classifiers for the sake of conciseness: We select node t_3 in the true rumor case, and node t_1 in the false rumor case as displayed in Figure 6. As for global attention, we firstly compute the nodes’ averaged global attention scores over all binary classifiers, and then mark the top-3 important stances with solid blue ovals in the true and false rumor cases, respectively.

We have the following observations. 1) The “support” posts mostly play an important role in the propagation graph with True Rumor as the target class. 2) The “deny” posts contribute more to the propagation graph with False Rumor as the target class. 3) The model with true rumor as the target can capture “support \rightarrow support” propagation pattern ending with t_6 as shown in Figure 6(a). 4) The model with False rumor as target tends to capture the “deny \rightarrow support”

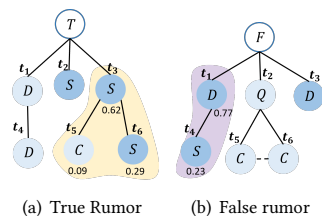

Fig. 6. Case Study for Claim-guided Hierarchical Stance Tree Attention.

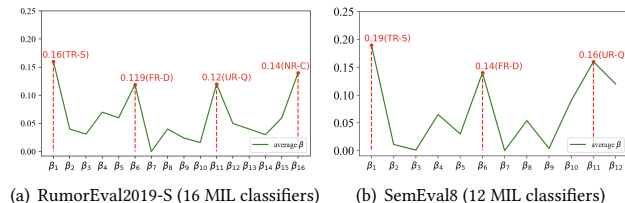

Fig. 7. Average attention scores for binary classifiers obtained from Equation 8.

propagation pattern, which ends with t_4 as shown in Figure 6(b). These observations conform to our assumption and intuition that the propagation structure is vital in the joint task of rumor and stance detection.

6.7.2 Case Study for Aggregation Model. We also conduct experiments to show why the aggregation model can simultaneously boost rumor and stance detection tasks. We randomly sample 100 claims from the PHEME dataset and then disclose the attention scores of all the binary classifiers obtained during the evaluations on the RumorEval2019-S and SemEval8 datasets. The average attention scores over all the claims are shown in Figure 7.

We have the following observations. 1) The top attention scores indicate a close correlation between the specific rumor veracity and stance category, which is compatible with previous findings [42]. For example, the high values of β_1 and β_6 in Figure 7(a) suggest that True Rumor and Supportive stance in the posts are more closely correlated, and likewise the False Rumor and Denial stance. 2) The classifiers with lower attention suggest that the final prediction is less affected by the corresponding veracity-stance relationship, indicating that there is a weak correlation between rumor and stance for the current target class. For example, β_2 and β_3 in Figure 7(b) demonstrates that for the T-D and T-Q target pairs, the veracity-stance correlation has a weak influence on the prediction of the corresponding binary models. This seems to be consistent with the lower proportion of Denying and Questioning posts as shown in Table 1. 3) The rumor veracity can be generally better determined based on a combination of various stances instead of one-sided stances. For instance, Support and Comment stances combined can contribute more than others when True Rumor is the target class, which can be reflected by the relatively high value when combining T-S (β_1) and T-C (β_4) model predictions as shown in Figure 7(a). 4) Similarly, among the classifiers with Question stance as the target class, the T-Q model is generally less important than the other three (i.e., N-Q, F-Q, and U-Q), which indicates the lower proportion of Questioning posts in the True Rumor.

6.8 Error Analysis

To understand the weaknesses of the LLM-MIL and explore the future research direction, we randomly select a misclassified sample from RumorEval2019-S to manually analyze the error the model is prone to make. As Figure 8 shows, a False Rumor claimed that “Emergency Emergency” was the final distress call that was sent from the cockpit of flight #4U9525” has been misclassified as a “True Rumor”. We analyze this error committed by our model and find

<p>Claim: NEWS: 'Emergency Emergency' was the final distress call that was sent from the cockpit of flight #4U9525 - @PollyR_Aviation [False Rumor]</p> <p>Explanation: This claim exhibits the characteristics of a true rumor because it references an actual event that is highly plausible and aligns with widely discussed facts (the crash of flight 4U9525). However, the fact that it comes from an unofficial source and has not yet been fully confirmed by authoritative investigations means it remains a rumor. As such, it embodies the characteristics of a true rumor: based on true information but lacks complete, official verification at the time of dissemination. [Predicted Claim Type: True Rumor]</p>
<p>P1: @airlivenet @PollyR_Aviation is that a normal call in this situation? [question]</p> <p>Explanation: In this post, rather than rejecting or questioning the veracity of the claim, the user is asking for more context or information to understand the situation better. This implies support for the claim, since they're looking for reasons to justify it as true. The phrasing "is that a normal call?" suggests that if it's verified as a normal distress call, the claim would be validated. [Predicted Stance Type: Support]</p>
<p>P2: RT @airlivenet: NEWS: 'Emergency Emergency' was the final distress call that was ... - @PollyR_Aviation [comment]</p> <p>Explanation: The post P2 represents a comment stance because it repeats the claim without offering any support or disagreement. The tone is neutral and informative, with no attempt to influence the discussion or add new insights. This type of response is typically non-judgmental and does not contribute to the evaluation or verification of the claim. Instead, it serves as a way to acknowledge or reference the information without taking a clear stance on its truthfulness or accuracy. [Predicted Stance Type: Comment]</p>
<p>P3: I doubt any pilot would say 'Emergency', but rather 'Mayday' [deny]</p> <p>Explanation: In this post, the deny stance is characterized by the user expressing doubt and disagreement with the claim about the final distress call on flight #4U9525. The user provides reasoning to explain why the claim is likely, directly challenging the factual accuracy of the claim. This stance aims to dispute the claim, offering an alternative and more plausible explanation while rejecting the validity of the original information. [Predicted Stance Type: Deny]</p>
<p>P4: @PascalSyn @airlivenet it's a scale. Emergency &lt; Mayday [comment]</p> <p>Explanation: The post P4 represents a comment stance because it provides an informative and neutral clarification about distress call terminology ("Emergency < Mayday") without expressing any support or denial regarding the truthfulness of the rumor. [Predicted Stance Type: Comment]</p>
<p>P5: @damienramage @airlivenet No, then you would say PANPAN. Trust me, I'm a pilot! Besides, Mayday is when lives are in danger... [deny]</p> <p>Explanation: In this case, the deny stance is clear in the post's contradiction of the claim and the alternative information provided by the user. The post undermines the claim by offering a different understanding of the distress call, grounded in the user's self-proclaimed expertise as a pilot. The use of authority, offering a correction (PANPAN instead of Emergency), and providing an explanation of the correct distress call terminology all contribute to the denial of the original claim. So, the user's stance is to deny the accuracy of the claim. [Predicted Stance Type: Deny]</p>
<p>P6: @airlivenet it's a 2019 declaring an emergency the proper procedure if you still have control of the situation? [question]</p> <p>Explanation: In this case, the support stance is shown through the post's affirmation of the validity of the distress call procedure mentioned in the original claim. The user is defending the general idea of declaring an emergency when control of the situation is maintained, indirectly endorsing the truthfulness of the claim. The post provides a logical justification for why such a distress call would be appropriate. By asking a clarifying question, the user emphasizes that declaring an emergency is a standard practice, thereby supporting the original claim. [Predicted Stance Type: Support]</p>
<p>P7: @PascalSyn @airlivenet or think you do? or it hasn't been assessed? [question]</p> <p>Explanation: This post demonstrates doubt and seeks clarification by posing multiple questions ("or think you do?" and "or it hasn't been assessed?") without directly supporting or denying the claim. It builds on prior assertions, remains neutral, and avoids strong sentiment. [Predicted Stance Type: Question]</p>
<p>P8: @airlivenet @PollyR_Aviation @erislomb Looks terribly off course on a map. Nothing earlier? Like much earlier? [question]</p> <p>Explanation: In this post, the query stance is characterized by the user's inquisitive approach to the claim about the distress call. The user is asking multiple clarifying questions and seeking additional information to better understand the context and circumstances around the claim, without asserting any judgment on its truthfulness. The focus is on gaining more context to evaluate the claim, which is typical of a query stance. [Predicted Stance Type: Question]</p>
<p>P9: @airlivenet @PollyR_Aviation sound true, so sad... prayers to the families and friends... [comment]</p> <p>Explanation: In this post, the comment stance is characterized by the user's emotional reaction to the claim, primarily expressing sympathy and sadness without challenging or supporting the veracity of the rumor. The user is not questioning, analyzing, or offering factual arguments; instead, they are providing a personal, empathetic commentary on the situation. This makes the post a typical example of a comment stance. [Predicted Stance Type: Comment]</p>

Fig. 8. Error analysis of LLM-MIL. The yellow box represents the claim, the green box represents the related posts, and the ground truth label of the claim and posts are enclosed in "[]" at the end of the text. Each claim and post is associated with not only the corresponding explanation generated by LLM but also the claim veracity and stance type predicted by the LLM-MIL.

that while the explanations generated by LLM for most posts are reliable and most posts can be correctly classified by LLM-MIL, several issues are observed: 1) LLM may hallucinate or fall into extremism when encountering questioning posts. For example, if a user does not deny the source claim but tries to find evidence, it may be considered to support the source claim as highlighted by the pink-color explanations for P1 and P6. 2) When LLM recognizes multiple questions integrated into one post, it tends to classify such post into questioning stance, as shown by the yellow-color explanations for P7 and P8. Hence, while LLM can generate plausible explanations in many cases, we should pay attention on how it identifies and interprets questioning stance and improve its shortfall on that.

6.9 Evaluation of LLM-generated Explanations

To evaluate the generated explanations, we randomly sample 10 claims from RumorEval2019-S dataset along with the claim veracity explanations. For brevity and fairness, we randomly select 5 explanation samples for each type of post stances given a claim. Since there is no gold ground-truth for post stance and claim veracity explanation, we provide human-expert explanations for the claims and selected posts. Additionally, we employ the following 5 metrics [30] to evaluate the quality of explanations: 1) Conciseness; 2) Readability; 3) Soundness; 4) Informativeness; 5) Persuasiveness. Although ChatGPT [4] can be used for automatic evaluation, our explanations (which are generated by ChatGPT) may be biased towards its preference leading to unfair evaluation results. Hence, we ask 6 annotators to label the explanations and provide their confidence in a 5-point Likert Scale [21] for each metric.

Table 10 exhibits three key observations: 1) Humans can generate concise content with accurate key points, while LLMs often produce overly lengthy explanations. 2) The readability and soundness scores for both explanations are comparable, indicating LLMs can generate fluent and logical explanation sentences as human beings for claims and stances. 3) The informativeness and persuasiveness scores for LLM-generated explanations are higher than human

beings. This might be because LLMs can capture contextual details precisely beyond human and induce more specific information relevant to the post to make the explanations more persuasive.

Table 10. Evaluation results of the LLM-generated explanations

Explanations	Conciseness	Readability	Soundness	Informativeness	Persuasiveness
LLM	3.76	4.35	3.67	4.13	4.12
Human	4.16	4.36	3.63	3.81	3.67

7 DISCUSSION

While we integrate LLM explanations and hierarchical attention mechanisms, our computation overhead does not increase significantly. This is because 1) we only prompt LLM in zero-shot setting to generate explanations for each sample without fine-tuning the model, and 2) the hierarchical stance tree attention mechanism allows for parallel computation across claims. For example, we use a Tesla V100-32GB GPU for training, which just takes 2 hours and 45 minutes for the Twitter15 dataset, and the time elapsed for inference was less than 15 minutes. By leveraging standard optimizations, parallelization, and efficient memory management, our approach can handle the demands of large datasets while providing accurate results. Furthermore, while our model has shown promising results on different datasets, languages, and platforms, there is, to our best knowledge, no generative AI-based rumor dataset in the community, and we plan to collect and analyze such datasets in our future study.

8 CONCLUSION

Inspired by the multi-instance learning method, we propose a novel weakly supervised framework enhanced by Large Language Model-generated explanations, which is named as LLM-MIL, for detecting rumorous claims and determining the stances of their associated posts simultaneously. Our model is trained solely with bag-level annotations, specifically claim veracity labels. It incorporates a stance aggregation attention mechanism, allowing for the joint inference of both rumor veracity and unseen post-level stance labels. Across both Twitter and Weibo platforms, our approach demonstrates promising results for both rumor and stance detection tasks, outperforming state-of-the-art supervised and unsupervised models.

ACKNOWLEDGMENTS

This work is supported by National Natural Science Foundation of China Young Scientists Fund (No. 62206233) and Hong Kong RGC ECS (No. 22200722).

REFERENCES

- [1] Emily Allaway and Kathleen McKeown. 2020. Zero-Shot Stance Detection: A Dataset and Model Using Generalized Topic Representations. In *Proceedings of the 2020 Conference on Empirical Methods in Natural Language Processing (EMNLP)*. 8913–8931.
- [2] Stefanos Angelidis and Mirella Lapata. 2018. Multiple instance learning networks for fine-grained sentiment analysis. *Transactions of the Association for Computational Linguistics* 6 (2018), 17–31.
- [3] Tian Bian, Xi Xiao, Tingyang Xu, Peilin Zhao, Wenbing Huang, Yu Rong, and Junzhou Huang. 2020. Rumor detection on social media with bi-directional graph convolutional networks. In *Proceedings of the AAAI conference on artificial intelligence*, Vol. 34. 549–556.
- [4] Yi Chen, Rui Wang, Haiyun Jiang, Shuming Shi, and Ruifeng Xu. 2023. Exploring the Use of Large Language Models for Reference-Free Text Quality Evaluation: An Empirical Study. In *Findings of the Association for Computational Linguistics: IJCNLP-AAACL 2023 (Findings)*. 361–374.
- [5] Kyunghyun Cho, Bart van Merriënboer, Dzmitry Bahdanau, and Yoshua Bengio. 2014. On the Properties of Neural Machine Translation: Encoder–Decoder Approaches. In *Proceedings of SSST-8, Eighth Workshop on Syntax, Semantics and Structure in Statistical Translation*. 103–111.
- [6] Leon Derczynski, Kalina Bontcheva, Maria Liakata, Rob Procter, Geraldine Wong Sak Hoi, and Arkaitz Zubiaga. 2017. SemEval-2017 Task 8: RumourEval: Determining rumour veracity and support for rumours. In *SemEval-2017*. 69–76.

- [7] Thomas G Dietterich, Richard H Lathrop, and Tomás Lozano-Pérez. 1997. Solving the multiple instance problem with axis-parallel rectangles. *Artificial intelligence* 89, 1-2 (1997), 31–71.
- [8] Yasan Ding, Bin Guo, Yan Liu, Yunji Liang, Haocheng Shen, and Zhiwen Yu. 2022. Metadector: Meta event knowledge transfer for fake news detection. *ACM Transactions on Intelligent Systems and Technology (TIST)* 13, 6 (2022), 1–25.
- [9] Brown et al. 2020. Language Models are Few-Shot Learners. In *Advances in Neural Information Processing Systems*, H. Larochelle, M. Ranzato, R. Hadsell, M.F. Balcan, and H. Lin (Eds.), Vol. 33. Curran Associates, Inc., 1877–1901.
- [10] Caruccio et al. 2024. Claude 2.0 large language model: Tackling a real-world classification problem with a new iterative prompt engineering approach. *Intelligent Systems with Applications* 21 (2024), 200336.
- [11] Derczynski et al. 2015. Pheme: Computing veracity—the fourth challenge of big social data. In *ESCW-PN*.
- [12] Devlin et al. 2019. BERT: Pre-training of Deep Bidirectional Transformers for Language Understanding. In *NAACL: Human Language Technologies, Volume 1 (Long and Short Papers)*. 4171–4186.
- [13] Gorrell et al. 2019. SemEval-2019 task 7: RumourEval, determining rumour veracity and support for rumours. In *Proceedings of the 13th International Workshop on Semantic Evaluation*. 845–854.
- [14] Lukasiak et al. 2016. Hawkes processes for continuous time sequence classification: an application to rumour stance classification in twitter. In *Proceedings of the 54th Annual Meeting of the Association for Computational Linguistics (Volume 2: Short Papers)*. 393–398.
- [15] Peters et al. 2018. Deep Contextualized Word Representations. In *NAACL-HLT, Volume 1 (Long Papers)*. 2227–2237.
- [16] Ruichao Yang et al. 2022. A Weakly Supervised Propagation Model for Rumor Verification and Stance Detection with Multiple Instance Learning. In *SIGIR '22*, Enrique Amigó, Pablo Castells, Julio Gonzalo, Ben Carterette, J. Shane Culpepper, and Gabriella Kazai (Eds.). ACM, 1761–1772.
- [17] Taori et al. 2023. Alpaca: A strong, replicable instruction-following model. *Stanford Center for Research on Foundation Models*. <https://crfm.stanford.edu/2023/03/13/alpaca.html> 3, 6 (2023), 7.
- [18] Lanting Fang, Kaiyu Feng, Kaiqi Zhao, Aiqun Hu, and Tao Li. 2023. Unsupervised Rumor Detection Based on Propagation Tree VAE. *IEEE Transactions on Knowledge and Data Engineering* (2023).
- [19] James Foulds and Eibe Frank. 2010. A review of multi-instance learning assumptions. *The knowledge engineering review* 25, 1 (2010), 1–25.
- [20] Margherita Gambini, Caterina Senette, Tiziano Fagni, and Maurizio Tesconi. 2024. Evaluating large language models for user stance detection on X (Twitter). *Machine Learning* (2024), 1–24.
- [21] Ankur Joshi, Saket Kale, Satish Chandel, and D Kumar Pal. 2015. Likert scale: Explored and explained. *British journal of applied science & technology* 7, 4 (2015), 396.
- [22] Ling Min Serena Khoo, Hai Leong Chieu, Zhong Qian, and Jing Jiang. 2020. Interpretable rumor detection in microblogs by attending to user interactions. In *Proceedings of the AAAI conference on artificial intelligence*, Vol. 34. 8783–8790.
- [23] Diederik P. Kingma and Jimmy Ba. 2015. Adam: A Method for Stochastic Optimization. In *3rd International Conference on Learning Representations, ICLR 2015, San Diego, CA, USA, May 7-9, 2015, Conference Track Proceedings*, Yoshua Bengio and Yann LeCun (Eds.). <http://arxiv.org/abs/1412.6980>
- [24] Jonathan Kobbe, Ioana Hulpuş, and Heiner Stuckenschmidt. 2020. Unsupervised stance detection for arguments from consequences. In *Proceedings of the 2020 Conference on Empirical Methods in Natural Language Processing (EMNLP)*. 50–60.
- [25] Elena Kochkina, Maria Liakata, and Isabelle Augenstein. 2017. Turing at SemEval-2017 Task 8: Sequential Approach to Rumour Stance Classification with Branch-LSTM. In *Proceedings of the 11th International Workshop on Semantic Evaluation (SemEval-2017)*. 475–480.
- [26] Xiaochong Lan, Chen Gao, Depeng Jin, and Yong Li. 2024. Stance detection with collaborative role-infused llm-based agents. In *Proceedings of the International AAAI Conference on Web and Social Media*, Vol. 18. 891–903.
- [27] Teven Le Scao, Angela Fan, Christopher Akiki, Ellie Pavlick, Suzana Ilić, Daniel Hesslow, Roman Castagné, Alexandra Sasha Luccioni, François Yvon, Matthias Gallé, et al. 2023. Bloom: A 176b-parameter open-access multilingual language model. (2023).
- [28] Yingjie Li, Chenye Zhao, and Cornelia Caragea. 2023. TTS: A Target-based Teacher-Student Framework for Zero-Shot Stance Detection. In *Proceedings of the ACM Web Conference 2023*. 1500–1509.
- [29] Bin Liang et al. 2022. JointCL: A Joint Contrastive Learning Framework for Zero-Shot Stance Detection. In *ACL*. 81–91.
- [30] Hongzhan Lin, Ziyang Luo, Wei Gao, Jing Ma, Bo Wang, and Ruichao Yang. 2024. Towards explainable harmful meme detection through multimodal debate between large language models. In *Proceedings of the ACM on Web Conference 2024*. 2359–2370.
- [31] Hongzhan Lin, Jing Ma, Liangliang Chen, Zhiwei Yang, Mingfei Cheng, and Chen Guang. 2022. Detect Rumors in Microblog Posts for Low-Resource Domains via Adversarial Contrastive Learning. In *Findings of the Association for Computational Linguistics: NAACL 2022*. 2543–2556.
- [32] Hongzhan Lin, Jing Ma, Mingfei Cheng, Zhiwei Yang, Liangliang Chen, and Guang Chen. 2021. Rumor Detection on Twitter with Claim-Guided Hierarchical Graph Attention Networks. In *Proceedings of the 2021 Conference on Empirical Methods in Natural Language Processing*. 10035–10047.
- [33] Hongzhan Lin, Pengyao Yi, Jing Ma, Haiyun Jiang, Ziyang Luo, Shuming Shi, and Ruifang Liu. 2023. Zero-shot rumor detection with propagation structure via prompt learning. In *Proceedings of the AAAI Conference on Artificial Intelligence*, Vol. 37. 5213–5221.
- [34] Yinhan Liu, Myle Ott, Naman Goyal, Jingfei Du, Mandar Joshi, Danqi Chen, Omer Levy, Mike Lewis, Luke Zettlemoyer, and Veselin Stoyanov. 2019. Roberta: A robustly optimized bert pretraining approach. *arXiv preprint arXiv:1907.11692* (2019).
- [35] Yi-Ju Lu and Cheng-Te Li. 2020. GCAN: Graph-aware Co-Attention Networks for Explainable Fake News Detection on Social Media. In *Proceedings of the 58th Annual Meeting of the Association for Computational Linguistics*. 505–514.
- [36] Nanhang Luo, Dongdong Xie, Yiwen Mo, Fei Li, Chong Teng, and Donghong Ji. 2024. Joint rumour and stance identification based on semantic and structural information in social networks. *Applied Intelligence* 54, 1 (2024), 264–282.

- [37] Jing Ma and Wei Gao. 2020. Debunking Rumors on Twitter with Tree Transformer. In *COLING*. 5455–5466.
- [38] Jing Ma, Wei Gao, Shafiq Joty, and Kam-Fai Wong. 2020. An Attention-based Rumor Detection Model with Tree-structured Recursive Neural Networks. *ACM Transactions on Intelligent Systems and Technology (TIST)* 11, 4 (2020), 1–28.
- [39] Jing Ma, Wei Gao, and Kam-Fai Wong. 2018. Detect rumor and stance jointly by neural multi-task learning. In *WWW*. 585–593.
- [40] Jing Ma, Wei Gao, and Kam-Fai Wong. 2018. Rumor Detection on Twitter with Tree-structured Recursive Neural Networks. In *Proceedings of the 56th Annual Meeting of the Association for Computational Linguistics (Volume 1: Long Papers)*. 1980–1989.
- [41] Jing Ma, Jun Li, Wei Gao, Yang Yang, and Kam-Fai Wong. 2021. Improving rumor detection by promoting information campaigns with transformer-based generative adversarial learning. *IEEE Transactions on Knowledge and Data Engineering* (2021).
- [42] Marcelo Mendoza, Barbara Poblete, and Carlos Castillo. 2010. Twitter under crisis: Can we trust what we RT?. In *Proceedings of the first workshop on social media analytics*. 71–79.
- [43] Stuart E Middleton and Vadims Krivcovs. 2016. Geoparsing and geosemantics for social media: Spatiotemporal grounding of content propagating rumors to support trust and veracity analysis during breaking news. *ACM Transactions on Information Systems (TOIS)* 34, 3 (2016), 1–26.
- [44] Dat Quoc Nguyen, Thanh Vu, and Anh Tuan Nguyen. 2020. BERTweet: A pre-trained language model for English Tweets. In *Proceedings of the 2020 Conference on Empirical Methods in Natural Language Processing: System Demonstrations*. 9–14.
- [45] Symeon Papadopoulos, Kalina Bontcheva, Eva Jaho, Mihai Lupu, and Carlos Castillo. 2016. Overview of the Special Issue on Trust and Veracity of Information in Social Media. *ACM Trans. Inf. Syst.* 34, 3, Article 14 (apr 2016), 5 pages. <https://doi.org/10.1145/2870630>
- [46] Jeffrey Pennington, Richard Socher, and Christopher D Manning. 2014. Glove: Global vectors for word representation. In *Proceedings of the 2014 conference on empirical methods in natural language processing (EMNLP)*. 1532–1543.
- [47] Hongyan Ran and Caiyan Jia. 2023. Unsupervised Cross-Domain Rumor Detection with Contrastive Learning and Cross-Attention. In *AAAI 2023*, Brian Williams, Yiling Chen, and Jennifer Neville (Eds.). AAAI Press, 13510–13518. <https://doi.org/10.1609/aaai.v37i11.26584>
- [48] Nils Reimers and Iryna Gurevych. 2019. Sentence-BERT: Sentence Embeddings using Siamese BERT-Networks. In *EMNLP-IJCNLP*. 3982–3992.
- [49] Karishma Sharma, Feng Qian, He Jiang, Natali Ruchansky, Ming Zhang, and Yan Liu. 2019. Combating fake news: A survey on identification and mitigation techniques. *ACM Transactions on Intelligent Systems and Technology (TIST)* 10, 3 (2019), 1–42.
- [50] Mengzhu Sun, Xi Zhang, Jiaqi Zheng, and Guixiang Ma. 2022. Ddgcnn: Dual dynamic graph convolutional networks for rumor detection on social media. In *Proceedings of the AAAI conference on artificial intelligence*, Vol. 36. 4611–4619.
- [51] Hugo Touvron, Louis Martin, Kevin Stone, Peter Albert, Amjad Almahairi, Yasmine Babaei, Nikolay Bashlykov, Soumya Batra, Prajjwal Bhargava, Shrubti Bhosale, et al. 2023. Llama 2: Open foundation and fine-tuned chat models. *arXiv preprint arXiv:2307.09288* (2023).
- [52] Ashish Vaswani, Noam Shazeer, Niki Parmar, Jakob Uszkoreit, Llion Jones, Aidan N Gomez, Łukasz Kaiser, and Illia Polosukhin. 2017. Attention is all you need. *Advances in neural information processing systems* 30 (2017).
- [53] Penghui Wei, Nan Xu, and Wenji Mao. 2019. Modeling Conversation Structure and Temporal Dynamics for Jointly Predicting Rumor Stance and Veracity. In *EMNLP-IJCNLP*. 4787–4798.
- [54] Yeqing Yan, Peng Zheng, and Yongjun Wang. 2024. Enhancing large language model capabilities for rumor detection with knowledge-powered prompting. *Engineering Applications of Artificial Intelligence* 133 (2024), 108259.
- [55] Ruichao Yang, Wei Gao, Jing Ma, Hongzhan Lin, and Bo Wang. 2024. Reinforcement Tuning for Detecting Stances and Debunking Rumors Jointly with Large Language Models. In *Findings of ACL 2024*. 13423–13439. <https://doi.org/10.18653/v1/2024.findings-acl.796>
- [56] Ruichao Yang, Wei Gao, Jing Ma, Hongzhan Lin, and Zhiwei Yang. 2023. WSDMS: Debunk Fake News via Weakly Supervised Detection of Misinforming Sentences with Contextualized Social Wisdom. In *EMNLP*. 1525–1538.
- [57] Shuo Yang, Kai Shu, Suhang Wang, Renjie Gu, Fan Wu, and Huan Liu. 2019. Unsupervised fake news detection on social media: A generative approach. In *Proceedings of the AAAI conference on artificial intelligence*, Vol. 33. 5644–5651.
- [58] Jianfei Yu, Jing Jiang, Ling Min Serena Khoo, Hai Leong Chieu, and Rui Xia. 2020. Coupled hierarchical transformer for stance-aware rumor verification in social media conversations. Association for Computational Linguistics.
- [59] Qiang Zhang, Shangsong Liang, Aldo Lipani, Zhaochun Ren, and Emine Yilmaz. 2019. From Stances’ Imbalance to Their Hierarchical Representation and Detection. In *The World Wide Web Conference*. 2323–2332.
- [60] Susan Zhang, Stephen Roller, Naman Goyal, Mikel Artetxe, Moya Chen, Shuohui Chen, Christopher Dewan, Mona Diab, Xian Li, Xi Victoria Lin, et al. 2022. Opt: Open pre-trained transformer language models. *arXiv preprint arXiv:2205.01068* (2022).
- [61] Yan Zhang, Weiling Chen, Chai Kiat Yeo, Chiew Tong Lau, and Bu Sung Lee. 2017. Detecting rumors on online social networks using multi-layer autoencoder. In *2017 IEEE technology & engineering management conference (TEMSCON)*. IEEE, 437–441.
- [62] Guangzhen Zhao and Peng Yang. 2020. Pretrained embeddings for stance detection with hierarchical capsule network on social media. *ACM Transactions on Information Systems (TOIS)* 39, 1 (2020), 1–32.
- [63] Arkaitz Zubiaga, Maria Liakata, Rob Procter, G Wong Sak Hoi, and Peter Tolmie. 2016. PHEME rumour scheme dataset: journalism use case. *PHEME rumour scheme dataset: journalism use case* (2016).
- [64] Arkaitz Zubiaga, Maria Liakata, Rob Procter, Geraldine Wong Sak Hoi, and Peter Tolmie. 2016. Analysing how people orient to and spread rumours in social media by looking at conversational threads. *PloS one* 11, 3 (2016), e0150989.