HISTOGRAM APPROACHES FOR IMBALANCED DATA STREAMS REGRESSION

Ehsan Aminian
Faculty of Sciences
University of Porto
Porto, Portugal
Ehaminian@gmail.com

Joao Gama
Faculty of Sciences
University of Porto
Porto, Portugal
jgama@fep.up.pt

Rita P. Ribeiro
Faculty of Sciences
University of Porto
Porto, Portugal
rpribeiro@fc.up.pt

January 30, 2025

ABSTRACT

Handling imbalanced data streams in regression tasks presents a significant challenge, as rare instances can appear anywhere in the target distribution rather than being confined to its extreme values. In this paper, we introduce novel data-level sampling strategies, HistUS and HistOS, that utilize histogram-based approaches to dynamically balance data streams. Unlike previous methods based on Chebyshev’s inequality, our proposed techniques identify and handle rare cases across the entire distribution effectively. We demonstrate that HistUS and HistOS outperform traditional methods through extensive experiments on synthetic and real-world datasets, leading to more accurate and robust regression models in streaming environments.

1 Introduction

The digital age has seen a massive influx of data from sources such as IoT devices, social media, and sensors, generating continuous, high-speed, and potentially infinite data streams. Unlike static datasets, these streams demand real-time processing and adaptive algorithms due to their dynamic, temporally ordered nature. Traditional machine learning methods, designed for finite and stationary data, struggle to address these requirements, necessitating specialized techniques for evolving data.

On the other hand, *imbalanced learning* where rare events—such as financial fraud (Hernandez Aros et al., 2024), rare medical conditions Gupta et al. (2023), or extreme environmental phenomena Snieder et al. (2021)—hold greater significance than frequent ones Krawczyk (2016) is a challenging issue in data mining. For example, in flood warning systems, high-flow events are rare but critical, while low-flow instances dominate datasets Snieder et al. (2021). Traditional models, optimized for overall accuracy, often neglect these underrepresented cases, leading to poor performance on crucial predictions. This issue arises in both classification and regression contexts. In classification, models are biased toward majority classes, while in regression, predictions skew toward frequent target values (Cohen, 2022; He and Garcia, 2009).

This paper tackles the combined challenges of data stream learning and imbalanced learning by focusing on *imbalanced regression in data streams*, a domain where prior work has largely centered on classification (Ribeiro and Moniz, 2020), leaving regression understudied.

In our previous work Aminian et al. (2021), we presented our initial attempt to address imbalanced data streams in the regression domain by introducing two methods based on Chebyshev’s inequality, titled ChebyUS and ChebyOS. The methods aimed to achieve a balanced training set with similar proportions of frequent and rare cases by sampling strategies helping mitigate bias toward frequent cases and potentially improving the model’s performance in handling imbalanced regression tasks. However, a notable limitation of these approaches is the assumption that rare cases are confined solely to the extreme values (tails) of the target variable’s distribution.

This paper proposes novel data-level sampling strategies that overcome this limitation. Our new methods eliminate the assumption that rare cases reside only at the distribution tails, acknowledging that they may occur anywhere within the target variable’s range. By enabling the identification and handling of rare cases regardless of their location in the distribution, these advancements pave the way for more accurate and robust models.

The remainder of this section is organized as follows. In the following section, we formally define the problem followed by Section 6 where we introduce the histogram-based approaches, detailing the formulation of the probability function and the proposed methods, `HistUS` and `HistOS`. Section 7 describes the experimental evaluation, including the relevance function, dataset characteristics, and evaluation methodology which is followed by presenting and analyzing the experimental results, highlighting the impact of the parameters on performance and a comparison with Chebyshev-based methods. Finally, the paper is concluded in section 8.

2 Related work

Addressing the challenges of imbalanced regression requires not only improving predictive models but also accurately identifying rare instances within the data. Unlike classification problems, where the imbalance is defined by a disproportionate number of samples in minority classes, regression involves a continuous target variable, making the identification of rare cases inherently more complex. As a result, specialized methodologies are needed to assess the rarity of instances within the target distribution. In the following, we first explore different strategies for identifying rare instances in imbalanced regression before reviewing various methods designed to address this problem.

2.1 Identifying Rare Instances in Imbalanced Regression

One widely adopted approach is to estimate instance rarity using *Kernel Density Estimation (KDE)*. This method determines the density of target values and assigns greater importance to instances in low-density regions. Steininger et al. (2021) introduced *DenseWeight*, which leverages *KDE* to compute instance weights based on the density of their corresponding target values, prioritizing those that are underrepresented in the dataset. A similar *KDE*-based technique was proposed by Sadouk et al. (2021), though their methodology differs in the procedures used to quantify rarity. A key advantage of these approaches is their ability to identify rare instances across the entire target space without making assumptions about their location.

An alternative method for detecting rare instances was proposed by Ribeiro (2011), who introduced a relevance function derived from the box-and-whisker plot as follows: A relevance value of 0 is assigned to the median, while a relevance value of 1 is assigned to the upper adjacent value and all values above it, as well as to the lower adjacent value and all values below it. The median and adjacent values are then used as control points for piecewise cubic Hermite interpolation, which constructs the relevance function. This function assigns relevance values to all points between the lower adjacent value and the median, as well as between the median and the upper adjacent value, and those exceeding a user-defined threshold are classified as rare. Unlike *KDE*-based methods, which focus on overall data density, this approach primarily highlights extreme values in the target distribution.

Another notable approach is the relevance function used in *SmoteR* (Torgo et al., 2013) and Branco et al. (2017), which identifies rare instances by focusing on the tails of the target variable’s distribution. These methods employ a piecewise linear relevance function that assigns higher scores to instances with extreme target values (either very high or very low). The thresholds for defining rare instances are user-defined and can be based on percentiles or domain knowledge. Unlike the boxplot-based method, which relies on statistical rules like the interquartile range, this relevance function provides greater flexibility in defining what constitutes a rare instance, making it adaptable to various datasets and problem domains.

A related method, *Relevance-based Stratification for Binning*, extends the use of the relevance function to partition the data into bins based on the relevance scores of the target variable. This approach, also introduced by Branco et al. (2019), sorts the dataset by the target variable and creates bins whenever the relevance of the target value crosses a user-defined threshold. Instances in bins with high relevance scores are considered rare and are candidates for over-sampling, while those in low-relevance bins are candidates for under-sampling. This method is particularly useful for adapting classification-based pre-processing techniques, such as random over-sampling and the introduction of Gaussian noise, to regression tasks.

3 Review of Imbalanced Regression methods

Imbalanced learning has been widely studied, primarily in the context of classification tasks, where the goal is to improve predictive performance for underrepresented classes. However, handling imbalance in regression presents

additional challenges, as rare instances are not explicitly defined by class labels but instead must be identified based on the distribution of target values. Several approaches have been proposed to address this issue, which can be broadly categorized into data-level, algorithm-level, and hybrid techniques.

The relationships between these different approaches are illustrated in Figure 1, which provides a taxonomy of existing methods for handling imbalanced regression. This classification highlights the diverse range of techniques that have been proposed and sets the foundation for the discussion of their details in subsequent sections.

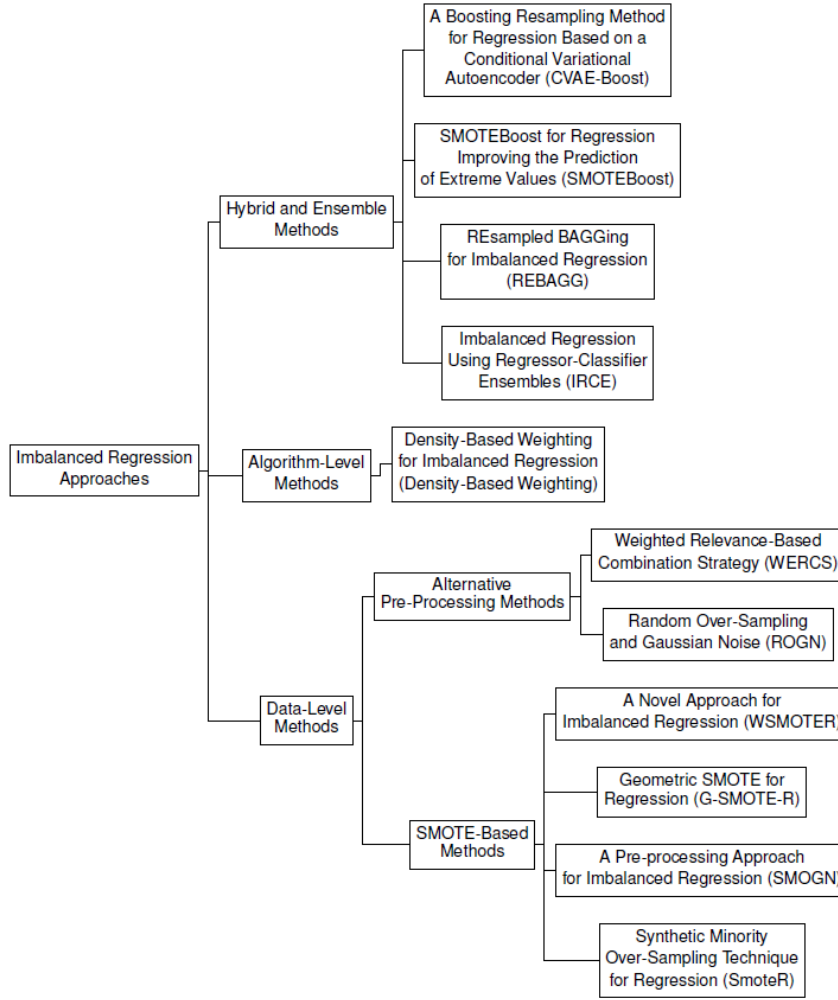

Figure 1: Taxonomy of Approaches for Imbalanced Regression

Extensive research has been conducted to address the challenge of imbalanced learning, with data-level approaches being one of the most widely used strategies in both classification and regression tasks Hoens and Chawla (2013). These methods modify the dataset itself rather than altering the learning algorithm, making them model-agnostic solutions for handling imbalanced distributions. Among data-level strategies, sampling techniques are the most commonly applied. Over-sampling increases the presence of rare instances by replicating them within the dataset, allowing the learning model to better capture their characteristics (Batista et al., 2004). In contrast, under-sampling mitigates the dominance of frequent instances by selectively removing them (Kubat et al., 1997), thereby preventing the model from being overly biased toward majority cases. Some approaches also combine both techniques to balance the dataset more effectively (Chawla et al., 2002), ensuring that rare instances gain better representation without excessively inflating the data size.

Since many data-level techniques in regression are inspired by the Synthetic Minority Over-sampling Technique (SMOTE), I have structured the following discussion into two categories. First, in the *SMOTE-Based Methods* subsection, we present SMOTE and its adaptations specifically designed for regression tasks. Then, in the *Alternative*

Pre-Processing Methods subsection, we explore other resampling techniques that do not rely on SMOTE but offer different strategies to address the imbalance problem.

3.1 SMOTE-Based Methods

3.1.1 SMOT

The Synthetic Minority Over-sampling Technique (SMOTE) (Chawla et al., 2002) is a widely recognized method designed to address the challenge of class imbalance in classification tasks. Unlike traditional oversampling methods that simply duplicate minority class instances, SMOTE generates synthetic examples of the minority class, thereby reducing the risk of overfitting and improving the model’s ability to generalize. The process begins by identifying instances of the minority class. For each minority instance x_i , SMOTE locates its k -nearest neighbors within the same class, where k is a user-defined parameter typically set to 5. Next, synthetic instances are created by interpolating between x_i and a randomly selected neighbor x_{zi} . This interpolation is achieved using the formula:

$$x_{\text{new}} = x_i + \delta \times (x_{zi} - x_i),$$

where δ is a random number between 0 and 1. This ensures that the synthetic instance x_{new} lies somewhere along the line segment connecting x_i and x_{zi} , introducing variability while maintaining the minority class’s distribution. The process is repeated iteratively for each minority instance until the dataset is sufficiently balanced.

One of the key advantages of SMOTE is its ability to improve the representation of the minority class without merely duplicating existing instances. This approach helps machine learning models learn a more robust decision boundary, enhancing their performance on imbalanced datasets. Additionally, by generating synthetic samples, SMOTE introduces diversity into the minority class, which mitigates the risk of overfitting to specific examples. However, SMOTE is not without limitations. A notable drawback is the potential for class overlap, as the method generates synthetic samples without considering the distribution of the majority class. This can lead to ambiguous regions in the feature space, increasing the likelihood of misclassifications. Furthermore, SMOTE’s reliance on interpolation makes it unsuitable for datasets with categorical variables unless modified to handle mixed data types. Another challenge arises when the minority class is sparse, as the synthetic instances generated may not accurately reflect the true underlying distribution, potentially introducing noise into the dataset.

3.1.2 SmoteR

Synthetic Minority Over-sampling Technique for Regression (SmoteR) (Torgo et al., 2013) is an extension of the SMOTE method, specifically designed to address imbalanced datasets in regression tasks where rare instances—such as extreme values—are underrepresented. SmoteR tackles this issue by generating synthetic samples for these rare cases, ensuring that the model can better learn from the full spectrum of target values. The methodology of SmoteR closely follows the principles of SMOTE but is adapted to handle continuous target variables.

The process begins by identifying rare cases using a relevance function, which assigns scores to instances based on their target values. Instances with target values that deviate significantly from the majority are flagged as "rare" or "highly relevant." Once these rare cases are identified, the dataset is partitioned into two groups: normal instances, which have target values close to the majority, and highly relevant instances, which represent the rare or extreme cases. To reduce the dominance of the majority (normal) instances, SmoteR performs random under-sampling on this group, ensuring that the model is not overwhelmed by frequent cases. For the highly relevant instances, SmoteR applies a modified version of SMOTE. Two rare instances are selected, and a synthetic instance is generated by interpolating between them. The target value of the synthetic instance is calculated as a weighted average of the target values of the two selected examples. This process of under-sampling normal cases and over-sampling rare cases helps balance the dataset, ensuring that both frequent and rare instances are adequately represented during training.

One of the key advantages of SmoteR is its ability to handle continuous target variables, making it a valuable tool for regression tasks. By generating synthetic samples for rare instances, SmoteR enables models to better capture the relationships between extreme target values and their associated features, improving predictive accuracy for these cases. However, SmoteR is not without its limitations. The effectiveness of the method heavily depends on the proper design of the relevance function, which may vary depending on the specific problem and domain. Additionally, like SMOTE, SmoteR introduces synthetic examples, which can increase the risk of overfitting, particularly when the minority instances are sparse or the dataset is small.

3.1.3 SMOGN

SMOGN—a Pre-processing Approach for Imbalanced Regression Problems using SMOTE and Gaussian Noise, proposed by Branco et al. (2017) as a powerful pre-processing tool, is an extension of the Synthetic Minority Over-sampling

Technique (SMOTE) specifically designed for regression tasks. It addresses the challenge of imbalanced datasets by generating synthetic instances with added Gaussian noise. The methodology of SMOGN begins by identifying rare instances using a relevance function, which classifies instances as "rare" or "frequent" based on their target values. Once these rare instances are identified, SMOGN applies the principles of SMOTE to generate synthetic examples by interpolating between two rare instances. To introduce variability and prevent overfitting, Gaussian noise is added to both the features and the target values of the synthetic instances. Additionally, frequent instances—those with common target values—are under-sampled to reduce their dominance in the dataset, ensuring that the model is not biased toward the more prevalent target values.

One of the key advantages of SMOGN is its ability to prevent overfitting. By adding Gaussian noise to the synthetic samples, SMOGN ensures that the generated instances are diverse and do not simply replicate existing data points. This variability helps the model generalize better to unseen data.

3.1.4 G-SMOTE-R

Camacho et al. (2022) propose an extension of the Geometric Synthetic Minority Oversampling Technique (G-SMOTE) (Douzas and Bacao, 2019) for regression tasks, termed *Geometric SMOTE for Regression (G-SMOTE-R)* to address the challenge of imbalanced learning in regression. As the name indicates, G-SMOTE-R addresses this issue by creating synthetic samples in the rare regions of the target variable, helping to balance the dataset and enhancing the model’s capability to predict rare values.

The core of G-SMOTE-R lies in the use of a *relevance function*, which maps the continuous target values to the interval $[0, 1]$. The relevance function is constructed using an automatic method based on the *box-and-whisker plot* Ribeiro (2011) of the target variable. A user-defined relevance threshold is applied to separate rare examples (with relevance above the threshold) from normal examples (with relevance below the threshold). G-SMOTE-R generates synthetic samples for the rare regions using a geometric approach that extends the original G-SMOTE algorithm for classification. The process begins with the identification of rare examples in the dataset based on the relevance function and the user-defined threshold. For each rare example, the algorithm selects its nearest neighbors in the feature space. These neighbors can be either rare or normal examples, depending on the chosen strategy (minority, majority, or combined). Synthetic samples are then generated within a geometric region around the rare example, rather than along the line segment between two examples (as in traditional SMOTE). This region is defined by a hypersphere that is truncated and deformed based on two hyperparameters: the truncation factor and the deformation factor. The truncation factor controls the level of truncation of the hypersphere, while the deformation factor determines the degree of shrinkage of the hyperspherical surface. The combination of these transformations results in a safe geometric region where synthetic samples can be generated. The target value for the synthetic sample is assigned as a weighted average of the target values of the rare example and its neighbors. The weights are determined by the Euclidean distances between the synthetic sample and the original examples, ensuring that the synthetic sample’s target value is closer to the target value of the nearest original example.

3.1.5 WSMOTER

Camacho and Bacao (2024) propose *WSMOTER* (Weighting SMOTE for Regression), a novel data-level approach that adapts the well-known SMOTE (Synthetic Minority Oversampling Technique) algorithm for regression tasks. Unlike existing methods that rely on arbitrary thresholds to partition the target domain into rare and common regions, WSMOTER treats each data point individually, avoiding discretization and making it more aligned with the continuous nature of regression problems.

WSMOTER operates by assigning weights to data points based on their rarity, measured using *DenseWeight*, a kernel density estimation (KDE)-based method as described in 3.3.1. These weights determine the probability of selecting a data point as a seed for generating synthetic instances. The selection process considers both the feature space and the target value neighborhood, ensuring that rare data points are more likely to be oversampled. The target value of the synthetic instance is determined by a weighted average of the target values of the seed points, based on their Euclidean distances. This approach allows WSMOTER to generate synthetic instances that better represent rare regions of the target domain, improving model performance for underrepresented cases in imbalanced datasets.

3.2 Alternative Pre-Processing Methods

3.2.1 ROGN

Branco et al. (2019) propose several pre-processing approaches for handling imbalanced distributions in regression tasks, focusing on generating synthetic data and under-sampling frequent cases to improve model performance on rare

target values. One such method is the *Random Over-Sampling and Gaussian Noise* (ROGN) which is a pre-processing technique designed to address imbalanced regression problems by combining random over-sampling of rare cases with the injection of Gaussian noise. The method begins by using a relevance function $\phi()$ to identify rare instances in the dataset. The relevance function assigns higher scores to instances with extreme target values (either very high or very low), which are considered rare. Once these rare instances are identified, ROGN applies random over-sampling by replicating them to increase their representation in the dataset.

To prevent overfitting and introduce variability, Gaussian noise is added to both the features and the target values of the replicated instances. The noise is sampled from a normal distribution with a mean of zero and a small standard deviation, ensuring that the synthetic instances remain close to the original data distribution. This noise injection step is critical, as it prevents the model from memorizing the replicated instances and encourages generalization to unseen data.

In addition to over-sampling rare cases, ROGN applies random under-sampling to frequent instances to reduce their dominance in the dataset. The combination of over-sampling with noise injection and under-sampling makes ROGN particularly effective for handling imbalanced regression tasks.

One of the key strengths of ROGN is its simplicity and computational efficiency. Unlike more complex methods that rely on interpolation or weighted sampling, ROGN uses straightforward random replication and noise injection, making it easy to implement and tune. However, the method’s performance heavily depends on the proper design of the relevance function and the choice of noise parameters. If the noise level is too high, the synthetic instances may deviate significantly from the original data distribution, leading to poor model performance. Conversely, if the noise level is too low, the method may fail to prevent overfitting.

3.2.2 WERCS

Another approach introduced by the authors is the *Weighted Relevance-based Combination Strategy* (WERCS) which is also a pre-processing method designed to address imbalanced regression problems by combining over-sampling and under-sampling based on instance relevance scores. The method begins by using a relevance function $\phi()$ to assign a relevance score to each instance in the dataset. Instances with extreme target values (either very high or very low) are assigned higher relevance scores, as they are considered rare, while instances with target values close to the majority are assigned lower scores.

Once the relevance scores are computed, WERCS assigns weights to each instance based on these scores. Rare instances receive higher weights, making them more likely to be selected for over-sampling, while frequent instances receive lower weights, making them candidates for under-sampling.

The over-sampling process in WERCS involves replicating rare instances to increase their representation. Unlike methods that rely on interpolation or noise injection, WERCS uses direct replication, which preserves the original data distribution of the rare cases. On the other hand, the under-sampling process randomly removes frequent instances based on their weights, ensuring that the dataset remains balanced without losing critical information from the majority class.

One of the key advantages of WERCS is its flexibility. By using a weighted combination of over-sampling and under-sampling, the method can adapt to different levels of imbalance in the dataset. Additionally, WERCS does not require complex parameter tuning, as the weights are directly derived from the relevance scores. However, the method’s performance heavily depends on the proper design of the relevance function. If the relevance function fails to accurately identify rare instances, the over-sampling and under-sampling processes may not effectively balance the dataset.

3.3 Algorithm-Level Approaches

Algorithm-level techniques also referred to as cost-sensitive learning, modify the learning process to improve performance on imbalanced datasets. This is achieved by adjusting the loss function to assign higher penalties to errors on rare instances, ensuring that the model prioritizes these cases during training. Typically, this involves weighting the training samples so that underrepresented instances contribute more significantly to the learning process, reducing the dominance of frequent cases Fernández et al. (2018).

3.3.1 Density-Based Weighting

To tackle the challenge of learning from imbalanced datasets in regression tasks, Steininger et al. (2021) propose two novel approaches: *DenseWeight*, a sample weighting scheme, and *DenseLoss*, a cost-sensitive learning method for neural network regression.

DenseWeight addresses the imbalance problem by assigning higher weights to data points with rare target values to increase their influence during model training. The rarity of a target value is estimated using kernel density estimation (*KDE*), which approximates the probability density function of the target variable. By normalizing the density values and applying a weighting function, *DenseWeight* ensures that rare target values receive proportionally larger weights. This weighting function is controlled by a hyperparameter α , which allows users to adjust the degree of emphasis on rare cases. For example, setting $\alpha = 0$ results in uniform weighting (no emphasis on rarity), while larger values of α increasingly prioritize rare data points. This flexibility enables users to tailor the model’s focus based on the specific requirements of their application.

DenseLoss builds on *DenseWeight* by integrating these sample weights into the loss function used during neural network training. Specifically, the loss contribution of each data point is scaled by its corresponding weight, ensuring that rare cases have a stronger influence on the gradient updates. This cost-sensitive approach encourages the model to improve its predictions for underrepresented regions of the target distribution, without requiring modifications to the dataset itself. Unlike sampling-based methods, such as SMOTER or SMOGN, which create synthetic samples or remove data points to balance the dataset, *DenseLoss* operates at the algorithm level. This avoids potential issues such as overfitting from oversampling or loss of information from undersampling.

3.4 Hybrid and Ensemble Strategies

Hybrid techniques integrate both data-level and algorithm-level approaches to enhance learning from imbalanced datasets. These methods leverage data manipulation strategies while incorporating algorithmic modifications to improve model performance on underrepresented instances. One widely adopted hybrid approach is ensemble learning (Camacho and Bacao, 2024), which improves predictive accuracy by training multiple models and combining their outputs. A well-known example is boosting, a sequential learning process where each model is trained to correct the errors made by its predecessor. Among boosting methods, AdaBoost Freund and Schapire (1997) is considered one of the most influential due to its ability to adjust instance weights, focusing more on difficult cases iteratively. However, ensemble learning alone is not sufficient to handle imbalanced data effectively. Its success depends on integrating additional techniques, such as data-level resampling or cost-sensitive learning, to ensure better representation of rare instances in the training process Galar et al. (2012).

3.4.1 IRCE

Orhobor et al. (2023) tackle the problem of imbalanced regression by proposing an ensemble-based approach (*Imbalanced regression using regressor-classifier ensembles*) that leverages the distribution of the target variable to improve predictions for rare or extreme values. The core idea of the proposed method is to discretize the continuous target variable into multiple bins using a discretization technique (e.g., frequency-based or clustering-based). For each bin, a regressor is trained to predict the target values within that specific range, while a classifier is trained to estimate the probability that a new sample belongs to that bin. This dual approach allows the model to focus on different regions of the target distribution independently, with the classifiers acting as a mechanism to weigh the predictions of the regressors based on the rarity of the target values. Specifically, the classifiers provide a probabilistic weighting scheme that dynamically adjusts the influence of each regressor’s prediction during inference. This ensures that rare or extreme values, receive more attention during model training and prediction.

The method operates in two phases: a *building phase* and a *prediction phase*. In the building phase, the target variable is discretized into multiple bins, and for each bin, a regressor and a classifier are trained. The classifiers are used to predict the likelihood that a new sample belongs to each bin, while the regressors provide predictions for the target values within their respective bins. During the prediction phase, the predictions from the regressors are combined using the probabilities provided by the classifiers, resulting in a weighted prediction that accounts for the rarity of the target values. The authors note that the computational cost of the method can be high, especially when using large bin sizes or complex models. Despite this, the method’s ability to dynamically adjust its focus based on the rarity of the target values makes it a powerful tool for addressing imbalanced regression problems.

3.4.2 REBAGG

The method proposed by Branco et al. (2018), known as *REsampled BAGging* (REBAGG), combines data pre-processing strategies with bagging-based ensemble techniques to enhance predictive performance for rare instances.

REBAGG also uses the relevance function defined through an automated process based on *box-and-whisker plot* Ribeiro (2011) of the target variable with a user-defined relevance threshold to distinguish rare and frequent instances. REBAGG generates synthetic samples for rare regions through a resampling methodology that merges bagging with data pre-processing strategies. The algorithm operates in two principal phases: initially, it constructs a set of models

utilizing pre-processed samples from the training set, and subsequently, it aggregates the predictions from these models to derive the final output. The resampling techniques incorporated in REBAGG encompass four primary categories: *balance*, *balance.SMT*, *variation*, and *variation.SMT*. The *balance* methods ensure that the new training set maintains an equal representation of rare and normal cases, whereas the *variation* methods permit a fluctuating ratio of rare to normal cases, thereby introducing additional diversity into the training sets. The suffix *SMT* signifies that the SMOTER algorithm is employed to create synthetic rare cases, while methods lacking this suffix depend on exact replicas of existing rare cases. This strategy guarantees that the synthetic samples are both diverse and representative of the rare regions, thereby mitigating the risk of overfitting.

3.4.3 SMOTEBoost for Regression

Moniz et al. (2018) propose an adaptation of the SMOTEBoost approach which is used to direct the distribution of data towards rare cases. SMOTEBoost addresses imbalance learning in regression by combining boosting algorithms with SMOTE. SMOTEBoost generates synthetic samples for the rare regions using a resampling approach that combines boosting with the SMOTE algorithm. The method works by iteratively applying SMOTE to generate synthetic examples of highly relevant cases—the relevance is calculated based on the *box-and-whisker plot* Ribeiro (2011)—which are then used to train weak learners in a boosting framework. At each iteration, the boosting algorithm identifies cases that are difficult to predict, increasing their weights to emphasize their importance in the subsequent training steps. SMOTE is then applied to create additional synthetic examples of these highly relevant cases, balancing the distribution and improving the representation of extreme target values.

3.4.4 CVAE-Boost

Huang et al. (2022) propose a method for addressing imbalanced regression by integrating density-based rare instance identification with a hybrid resampling strategy. Rare instances are detected through a relevance function derived from the inverse of kernel density estimation (KDE) applied to the target values. The KDE models the data distribution, and its inverse emphasizes low-density regions corresponding to rare instances. This measure is standardized via z-score normalization to compute the relevance function $\phi(\cdot)$. Instances with $\phi(\cdot)$ exceeding a predefined threshold (typically set to retain approximately 10% of the data as rare) are classified as rare, while others are labeled normal.

The resampling strategy combines two components. First, a boosting-weighted undersampling technique iteratively removes normal instances, prioritizing those with low relevance scores. The removal process is guided by validation performance: batches of normal samples are discarded only if their exclusion improves or maintains the mean squared error (MSE) on a validation set, ensuring informative samples are retained. Second, synthetic rare instances are generated using a conditional variational autoencoder (CVAE) trained on categorized data (rare low, rare high, normal). The CVAE leverages target-specific structural information to produce plausible synthetic samples, while their target values are predicted using an ensemble model comprising XGBoost, SVR, and Random Forest. A boosting mechanism further refines the synthetic data by discarding samples that fail to improve validation performance.

4 Motivation

Existing approaches, such as those based on Chebyshev’s inequality (Aminian et al., 2021), assume rarity is confined to distribution tails. This assumption fails in scenarios where critical rare cases reside in central regions, leading to systematic underestimation and poor model performance. For instance, in flood prediction systems, high-flow events may sporadically occur in mid-range hydrological conditions, yet Chebyshev-based methods overlook these cases (Snieder et al., 2021). Furthermore, traditional regression models prioritize frequent cases by minimizing global error metrics like MSE, further marginalizing underrepresented values. In this work, we bridge this gap by proposing *HistUS* and *HistOS*—histogram-based under- and over-sampling strategies for online imbalanced regression. Unlike prior methods, our approaches:

- Dynamically identify rare cases *across the entire target distribution*, eliminating restrictive tail assumptions.
- Leverage online histograms to adaptively balance data streams, ensuring models prioritize rare regions.
- Operate incrementally, aligning with the computational constraints of streaming environments.

5 Problem Definition

The challenge of *imbalanced domain learning* arises in predictive tasks where, given a training set $D = \{(\mathbf{x}_i, y_i)\}_{i=1}^n$ with feature vectors $\mathbf{x}_i \in \mathcal{X}$ and target variables $y_i \in \mathcal{Y}$, the goal is to approximate an unknown function $f : \mathcal{X} \rightarrow \mathcal{Y}$.

Depending on whether \mathcal{Y} is discrete or continuous, this defines a classification or regression problem, respectively (Aminian et al., 2021).

In standard regression, models optimize overall error metrics like mean absolute or squared error, prioritizing frequent cases that dominate these estimates. However, this approach is insufficient for *imbalanced regression*, where the target variable distribution is highly skewed, and accurate predictions for rare values are critical (Branco et al., 2016; Ribeiro and Moniz, 2020).

The problem becomes more complex in *online imbalanced regression*, where data arrives sequentially as pairs $\langle \mathbf{x}_t, y_t \rangle$ from an unknown distribution $p_t(\mathbf{x}, y)$. Here, $\mathbf{x}_t \in \mathcal{X}$ is a p -dimensional feature vector at time t , and $y_t \in \mathbb{R}$ is the continuous target value. The learner incrementally updates a hypothesis $H_t : \mathcal{X} \rightarrow \mathcal{Y}$, predicting $\hat{y}_t = H_t(\mathbf{x}_t)$ at each step. After observing the true y_t , the hypothesis is refined to H_{t+1} , iterating as new data arrives.

This work focuses on developing methods for *online imbalanced regression*, aiming to enhance predictive performance on underrepresented target values in streaming environments. The challenge lies in designing algorithms that adaptively handle imbalanced distributions, update models incrementally, and prioritize rare cases without access to the full dataset.

6 Histogram Approaches

In the previous paper, we presented our initial attempt to address imbalanced data streams in the regression domain specifically. We introduced two sampling strategies based on Chebyshev’s inequality: Chebyshev-based Under-Sampling (ChebyUS) and Chebyshev-based Over-Sampling (ChebyOS). ChebyUS leverages Chebyshev’s inequality to calculate a probability based on the data stream’s mean and variance. Incoming examples are then selectively included in the training set by comparing a randomly generated number to this Chebyshev probability, effectively reducing the dominance of frequent cases. Conversely, ChebyOS focuses on oversampling rare cases identified by their Chebyshev probability. A value K is calculated based on this probability, with higher values assigned to rarer cases. The model is then trained on the rare example K times, increasing its representation in the training data.

Using ChebyUS and ChebyOS, our previous work aimed to achieve a balanced training set with similar proportions of frequent and rare cases. This strategy helps mitigate bias towards frequent cases and potentially improves the model’s performance in handling imbalanced regression tasks. However, a notable limitation of these approaches is the assumption that rare cases are confined solely to the extreme values (tails) of the target variable’s distribution.

This paper proposes novel data-level sampling strategies that overcome this limitation. Our new methods eliminate the assumption that rare cases reside only at the distribution tails, acknowledging that they may occur anywhere within the target variable’s range. By enabling the identification and handling of rare cases regardless of their location in the distribution, these advancements pave the way for more accurate and robust models.

6.1 HistUS: Under-Sampling Approach Using Online Histograms

This section presents an under-sampling approach to build regression models from imbalanced data streams. The method utilizes counts and bins extracted from a dynamically constructed online histogram, allowing the training of learning models on a more balanced dataset when the incoming data stream exhibits imbalance.

An initial histogram is created based on samples from the data stream using the *Partitional Incremental Discretization* (PiD) method described in Gama and Pinto (2006). This histogram is a heuristic for assessing the expected rarity of incoming examples. By using the counts and bins of the histogram, we calculate a probability value that provides insight into the degree of rarity associated with each example. A low probability suggests that the example is frequent, whereas a high probability indicates that it is rare. Algorithms 1, 3, and 4 outline the implementation of this method.

Algorithm 1 presents the main procedure, HistUS, which initializes the model and histogram and orchestrates the training and testing phases.

Algorithms 2 and 3 describe the warming and training phases of the proposed HistUS algorithm, respectively. Training of the learner model without a prior estimation of the PiD model is not effective. To address this, the warming phase is introduced to construct an initial estimation of the histogram built by the PiD model.

During the training phase, the learner model is trained using an under-sampling strategy based on probabilities derived from the histogram. Simultaneously, the PiD model is updated throughout the training process and as we see also in the testing phase, to ensure that the probabilities remain accurate and reflective of the evolving data distribution. Algorithm 4 describes the testing phase, where the model continues to process the data stream, making predictions and updating itself.

Algorithm 1 HistUS: Histogram-Based Under-Sampling Algorithm for Data Streams

```

1: procedure HISTUS( $\mathcal{S}$ : Data Stream,  $n_w$ : Warming Set Size,  $n_t$ : Training Set Size,  $\beta$ : Sampling Decay Parameter)
2:    $model \leftarrow InitializeModel()$  ▷ Create an empty predictive model
3:    $histogram \leftarrow PiD()$  ▷ Create an empty histogram model using PiD algorithm
4:    $histogram \leftarrow WarmingPhase(\mathcal{S}, histogram, n_w)$  ▷ Build the initial histogram model
5:    $model, histogram \leftarrow TrainingPhase(\mathcal{S}, model, histogram, n_t, \beta)$ 
6:    $predictions \leftarrow TestingPhase(\mathcal{S}, model, histogram, \beta)$ 
7: end procedure

```

Algorithm 2 Warming Phase Procedure in Algorithm 1

```

1: procedure WARMINGPHASE( $\mathcal{S}$ : Data Stream,  $histogram$ : PiD Model,  $n_w$ : Warming Set Size)
2:    $i \leftarrow 0$ 
3:   while  $i \leq n_w$  do
4:      $\langle x, y \rangle \leftarrow GetExample()$  ▷ Retrieve the next example from the data stream
5:      $histogram \leftarrow UpdatePiDModel(histogram, y)$ 
6:      $i \leftarrow i + 1$ 
7:   end while
8: end procedure

```

Algorithm 3 Training Phase procedure in Algorithm 1

```

1: procedure TRAININGPHASE( $\mathcal{S}$ : Data Stream,  $model$ : Learner model,  $histogram$ : PiD Model,  $n_t$ : Training Set Size,  $\beta$ : Sampling steepness factor)
2:    $i \leftarrow 0$ 
3:   while  $i \leq n_t$  do
4:      $\langle x, y \rangle \leftarrow GetExample(\mathcal{S})$ 
5:      $histogram \leftarrow UpdatePiDModel(histogram, y)$ 
6:      $p \leftarrow ComputeProbability(y, histogram, \beta)$ 
7:      $r \leftarrow RandomNumber()$ 
8:     if  $r \leq p$  then
9:        $model \leftarrow TrainModel(model, \langle x, y \rangle)$ 
10:    end if
11:     $i \leftarrow i + 1$ 
12:  end while
13: end procedure

```

Algorithm 4 Testing phase procedure in Algorithm 1

```

1: procedure TESTINGPHASE( $\mathcal{S}$ : Data Stream,  $model$ : Learner model,  $histogram$ : PiD Model,  $\beta$ : Sampling steepness factor)
2:   while ( $nextExample(\mathcal{S}) \neq NULL$ ) do
3:      $\langle x, y \rangle \leftarrow GetExample(\mathcal{S})$ 
4:      $\hat{y} \leftarrow Estimate(model, y)$ 
5:      $histogram \leftarrow UpdatePiDModel(histogram, y)$ 
6:      $p \leftarrow ComputeProbability(y, histogram, \beta)$ 
7:      $r \leftarrow RandomNumber()$ 
8:     if  $r \leq p$  then
9:        $model \leftarrow TrainModel(model, \langle x, y \rangle)$ 
10:    end if
11:  end while
12: end procedure

```

As stated before, the methods proposed in this section, -as well as in the following section-, estimate the rarity of each incoming instance using an online histogram. During both the training and testing phases, the probability value (i.e. p) is calculated for each target value y , representing its frequency within the data stream. A random number r is then generated, and if $r \leq p$, the instance is selected for training. This under-sampling approach mitigates the over-representation of frequent cases, resulting in a more balanced training dataset.

In the following section, we provide a more detailed explanation of the probability function used in our algorithms.

6.2 Probability Function

The primary objective of this probability function is to regulate the selection of instances for training, thereby implementing sampling strategies based on instance rarity. It leverages count values derived from the histogram constructed *PiD* and is designed to be adaptable, enabling fine-tuning based on domain-specific knowledge of the underlying data distribution.

Given that the target value of the i -th instance is associated with the j -th bin interval, the probability for the instance is computed using the following formula:

$$P(i) = e^{-\beta \times \text{scaled_counter}[j]} \quad (1)$$

Here, β is a parameter that controls the degree of sampling, and $\text{scaled_counts}[j]$ represents the normalized count of instances in bin j , calculated as:

$$\text{scaled_counts}[j] = \frac{\text{counts}[j]}{\max(\text{counts})} \quad (2)$$

where $\text{counts}[j]$ is the number of instances in bin j , and $\max(\text{counts})$ is the maximum count among all bins in the histogram. This scaling ensures that the count values are normalized between 0 and 1.

The exponential function in Equation 1 assigns a higher probability to instances in bins with lower counts (rarer instances), and a lower probability to instances in bins with higher counts (more frequent instances). The parameter β adjusts the steepness of this probability decay.

6.3 HistOS: Over-Sampling Approach Using Online Histograms

The estimated histogram can also be employed to over-sample rare cases. By utilizing probability values derived from the histogram’s counts and bins, the learning models may undergo multiple training iterations for a single incoming example. The implementation of this approach is detailed in Algorithms 5 to 7.

Algorithm 5 HistOS: Histogram-Based Over-Sampling Algorithm for Data Streams

- 1: **procedure** HISTOS(\mathcal{S} : Data Stream, n_w : Warming Set Size, n_t : Training Set Size, α : Division Factor, β : Sampling Decay Parameter)
 - 2: $model \leftarrow \text{InitializeModel}()$ ▷ Create an empty predictive model
 - 3: $histogram \leftarrow \text{PiD}()$ ▷ Create an empty histogram model using PiD algorithm
 - 4: $histogram \leftarrow \text{WarmingPhase}(\mathcal{S}, histogram, n_w)$ ▷ Build the initial histogram model
 - 5: $model, histogram \leftarrow \text{TrainingPhase}(\mathcal{S}, model, histogram, n_t, \alpha, \beta)$
 - 6: $predictions \leftarrow \text{TestingPhase}(\mathcal{S}, model, histogram, \beta)$
 - 7: **end procedure**
-

It is important to note that the Warming Phase is omitted here, as it is identical to Algorithm 2 presented in the HistUS approach.

Algorithm 5 serves as the foundation of the method, closely resembling the structure of the under-sampling approach while introducing the division factor parameter, α . This parameter regulates the over-sampling rate by progressively reducing the computed probability for each incoming example until the termination condition in the training and test phases is satisfied.

Algorithm 6 handles the training phase by sequentially processing the data stream and updating two models: the histogram model (*histogram*) based on the *PiD* method and the learner model (*model*). Each example is used for training at least once. However, rare examples, which have a higher probability value p , may undergo multiple training iterations, enhancing the model’s ability to learn from infrequent cases.

The training process continues until the predefined training set size (n_t) is reached. For each incoming example, the histogram is updated, and the model is trained. The probability p is computed based on the histogram and adjusted using the division factor α and the sampling steepness parameter β . If a randomly generated number r satisfies $r \leq p$, the model undergoes additional training iterations, with p being progressively reduced by a factor of α after each iteration.

Algorithm 6 Training Phase procedure in Algorithm 5

```

1: procedure TRAININGPHASE( $\mathcal{S}$ : Data Stream,  $model$ : Learner model,  $histogram$ : PiD Model,  $n_t$ : Training Set
   Size,  $\alpha$ : Division Factor,  $\beta$ : Sampling steepness factor)
2:    $i \leftarrow 0$ 
3:   while  $i \leq n_t$  do
4:      $\langle x, y \rangle \leftarrow GetExample(\mathcal{S})$ 
5:      $histogram \leftarrow UpdatePiDModel(histogram, y)$ 
6:      $model \leftarrow TrainModel(model, \langle x, y \rangle)$ 
7:      $p \leftarrow ComputeProbability(y, histogram, \alpha, \beta)$ 
8:      $r \leftarrow RandomNumber()$ 
9:     while  $r \leq p$  do
10:       $model \leftarrow TrainModel(model, \langle x, y \rangle)$ 
11:       $p \leftarrow \frac{p}{\alpha}$ 
12:    end while
13:     $i \leftarrow i + 1$ 
14:  end while
15: end procedure

```

Algorithm 7 Testing phase procedure in Algorithm 5

```

1: procedure TESTPHASE( $\mathcal{S}$ : Data Stream,  $model$ : Learner model,  $histogram$ : PiD Model,  $\alpha$ : Division Factor,  $\beta$ :
   Sampling steepness factor)
2:   while ( $nextExample(\mathcal{S}) \llcorner NULL$ ) do
3:      $\langle x, y \rangle \leftarrow GetExample(\mathcal{S})$ 
4:      $\hat{y} \leftarrow Estimate(model, y)$ 
5:      $histogram \leftarrow UpdatePiDModel(histogram, y)$ 
6:      $p \leftarrow ComputeProbability(y, histogram, \alpha, \beta)$ 
7:      $r \leftarrow RandomNumber()$ 
8:     while  $r \leq p$  do
9:       $model \leftarrow TrainModel(model, \langle x, y \rangle)$ 
10:      $p \leftarrow \frac{p}{\alpha}$ 
11:   end while
12: end while
13: end procedure

```

This mechanism ensures that rare instances contribute more significantly to the training process while preventing excessive over-sampling.

Algorithm 7 (Testing phase) Continuously processes the data stream, making predictions, updating the histogram, and retraining the model. The over-sampling mechanism remains consistent with the training phase, ensuring continued model adaptation.

The division factor, α , plays a critical role in regulating the over-sampling rate. After each additional training iteration on an example, the probability p is divided by α , progressively lowering the likelihood of further repetitions. A smaller α value results in more frequent training iterations for rare cases, improving the model’s capacity to learn from infrequent events. The while loop continues until the condition $r > p$ is met, ensuring that additional training iterations are proportional to the rarity of the example.

7 Experimental Evaluation

7.1 Relevance Function

In our pursuit of conveying the varying importance attributed to different values of a target variable, we propose a new method to define the so-called relevance function $\phi: \mathcal{Y} \rightarrow [0, 1]$ that maps the continuous target variable domain into a scale of importance (Ribeiro and Moniz, 2020). Through our method, the relevance linked to each target value is contingent on the number of instances within the same range, using counts derived from the Equal-width Histogram method. We begin by constructing an equal-frequency histogram for the domain of the target variable, defined by a set of k bins, $]-\infty, b_1],]b_1, b_2], \dots,]b_{k-1}, b_k],]b_k, +\infty[$. We can gain insights into each interval’s density by comparing

the count values associated with each bin interval. So, depending on the specific bin interval in which a target value resides, we gauge its relative density to determine its relevance.

The relevance value for each sample in the bin interval is computed by

$$\phi(y_i) = 1 - \rho_j, b_{j-1} \leq y_i < b_j, \forall j = 1, \dots, k, y_i \in]b_{k-1}, b_k] \quad (3)$$

where $\phi(y_i)$ represents the relevance value for the i -th sample and ρ_j corresponds to the relative density of the j -th bin interval to which the sample is affiliated, is calculated by:

$$\rho_j = \frac{n_j}{\max\{n_l : \forall l = 1, \dots, k\}} \quad (4)$$

where n_j and n_l refer to the number of samples included in the l -th and the l -th bin, respectively.

The function $\phi(\cdot)$ is a non-continuous function that conveys domain-specific bias, with values of 0 and 1 representing the minimum and maximum relevance, respectively. The relevance values for bins containing a high number of examples, typically considered frequent cases, are low, whereas the values are high for bins with a small number of examples.

7.2 Results on a synthetic dataset

We created a simple synthetic dataset to validate the effectiveness of our approach in handling data streams where rare cases may appear at any point. This differs from our prior assumption that only extreme values are rare. The dataset consists of one independent variable x and one dependent variable y , with values of y constrained within the range $[1, 1000]$. To introduce imbalanced data distributions, 95% of the instances were designated as frequent, appearing within two specific intervals, $[150, 350]$ and $[650, 850]$, while the remaining 5% were classified as rare and distributed across the lower tail $[0, 150]$, the middle range $[350, 650]$, and the upper tail $[850, 1000]$. Different functional relationships were employed for each segment to ensure diverse patterns in the data. The frequent instances followed quadratic relationships, whereas the rare instances were modeled with cubic transformations to introduce non-linearity. The values of x were sampled from uniform distributions tailored to their respective regions, ensuring controlled variability across the dataset.

The functions governing the relationship between the independent variable x and the dependent variable y are defined as follows. For frequent instances, the relationship is modeled using a quadratic function:

$$y = 0.001x^2 + c \quad (5)$$

where c is a constant ensuring continuity within the specified frequent intervals. In contrast, rare instances are modeled using cubic transformations to introduce non-linearity:

$$y = 0.0001x^3 \quad (6)$$

for rare instances in the lower tail, and

$$y = 0.00001(x - 350)^3 + c \quad (7)$$

for rare instances in the middle interval, ensuring a distinct variation from the frequent cases.

Figure 2 illustrates the distribution of target values y in the synthetic dataset, emphasizing the distinction between frequent and rare instances through color-coded segments. The first plot presents the relationship between the independent variable x and the dependent variable y . The second plot depicts the histogram of y , demonstrating the concentration of frequent instances within specific intervals and the scattered distribution of rare instances. The final plot at the bottom represents the relevance values assigned to different target values, showing a sharp decline in relevance around the densely populated frequent regions, while maintaining high values in the sparse rare regions.

To illustrate the limitations of Chebyshev-based approaches for this type of dataset, we computed the Chebyshev probability and the corresponding K values for the target variable, as depicted in Figure 3.

The first two plots in the figure represent the inverse of the Chebyshev probability ($1 - \text{Probability}$) and the K values, respectively. These plots highlight how the Chebyshev-based probability measure assigns low values in the central region of the distribution while increasing towards the tails. Despite the presence of rare cases in the central region—confirmed

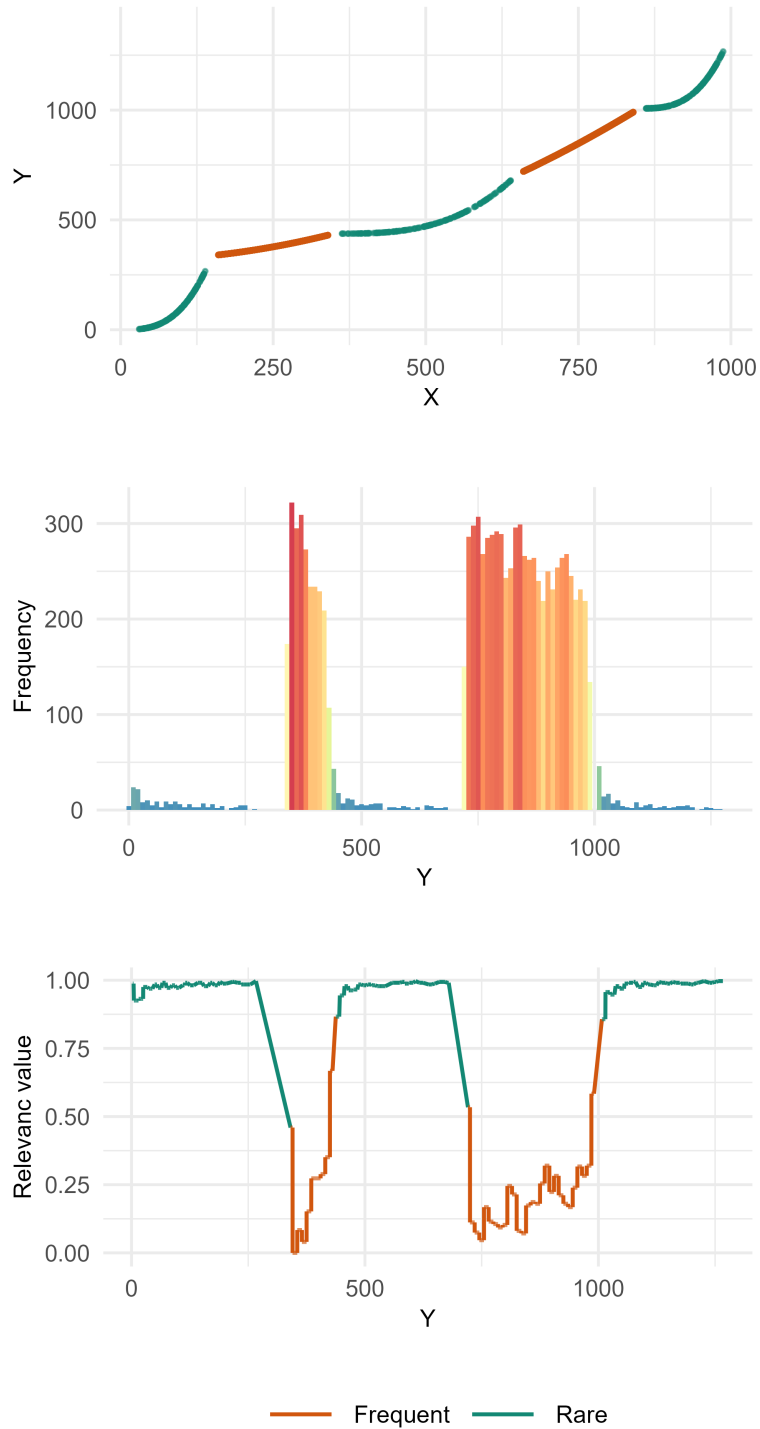
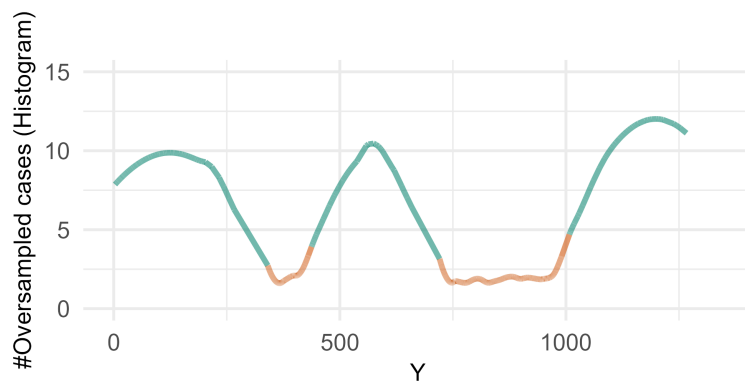
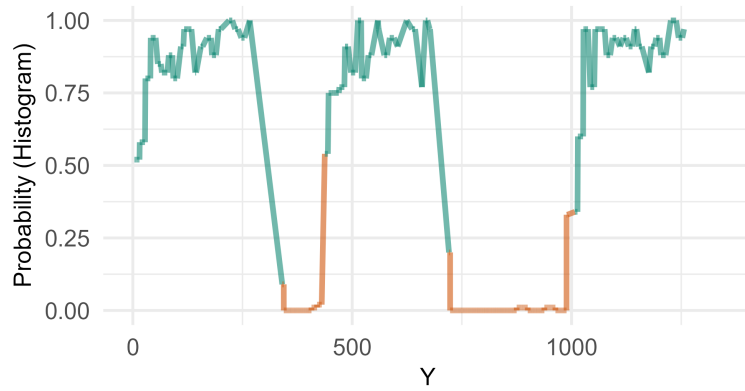
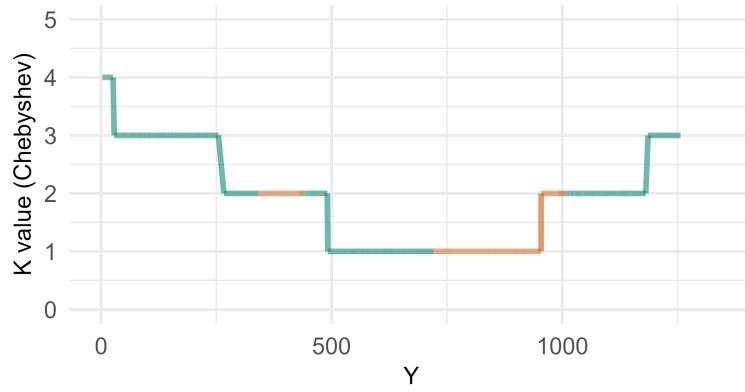
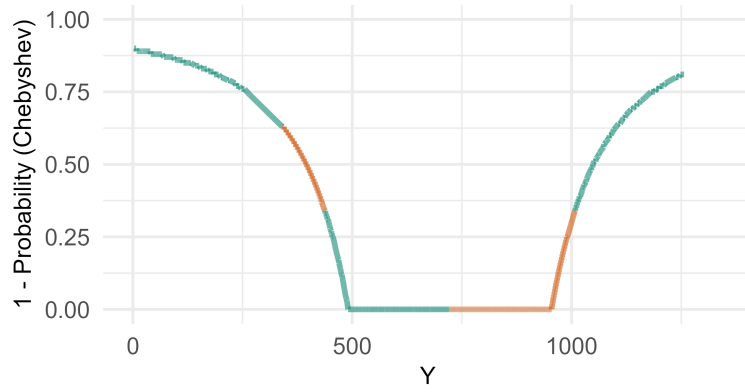

Figure 2: Histogram of target values across the dataset, highlighting frequent and rare cases, along with their relevance values for the generated synthetic dataset.

by high relevance values in Fig 3 —the Chebyshev probability and K values remain low, leading to an underestimation



of rare instances in these regions. This results in inadequate model training, as the approach inherently assumes that rarity is confined to the tails of the distribution.

The third and fourth plots in the figure illustrate the probability values and the number of oversampled cases obtained through the histogram-based approaches. Unlike Chebyshev, these methods effectively detect rare cases across the entire distribution, including the central region. The higher probability and oversampling values in this region demonstrate the superiority of the histogram-based approach in capturing rare instances, ensuring sufficient training data across all rare areas of the dataset. Consequently, we expect these methods to provide a more reliable framework for training machine learning models in scenarios where rare cases are not necessarily located at the extremes of the distribution.

Figure 4 presents the predicted values for rare cases using FIMT-DD - since the data is split into linear regions, FIMT-DD can identify those splits and fit the local models for each segment which is not true regarding the others - models trained with the proposed Chebyshev- and histogram-based strategies. The first two plots correspond to models trained with the Chebyshev-based approach, while the last two plots illustrate the performance of models trained using the histogram-based methods. A clear discrepancy is observed between the predictions: the histogram-based models demonstrate superior learning capability in capturing rare cases particularly located in the center region of the target value. This aligns with our earlier findings in Figure 3, where the Chebyshev-based probability measure failed to adequately identify rare cases located in the central region of the distribution.

Consequently, models trained with the Chebyshev approach exhibit higher prediction errors in these regions, as evident from the deviation of predicted values from the true values. In contrast, the histogram-based models effectively learn from rare cases across the entire distribution, leading to improved predictive performance and better generalization. The results are summarized in Table 1. The table reports the average $RMSE_\phi$, $SERA$ and $RMSE$ values along with their standard deviations, as well as the ranking of each method based on their predictive performance. Lower values indicate better performance. The results confirm the superior performance of the histogram-based methods compared to their Chebyshev-based counterparts.

Table 1: Summary of the results obtained by the proposed sampling strategies (HistUS, HistOS, ChebyUS and ChebyOS) as well as the Baseline method over the synthetic dataset. The table shows the average $RMSE_\phi$ and $SERA$ values for FIMT-DD regression algorithms.

$RMSE_\phi$ Results					
	Baseline	HistUS	HistOS	ChebyUS	ChebyOS
Avg. $RMSE_\phi$	61.16 ± 5.12	51.38 ± 10.22	26.17 ± 2.02	90.31 ± 83.02	37.87 ± 8.09
Avg. Rank	4.0	3.0	1.0	5.0	2.0
$SERA$ Results					
Avg. $SERA$	0.87 ± 0.0	0.78 ± 0.0	0.76 ± 0.0	0.59 ± 0.0	0.89 ± 0.0
Avg. Rank	4.2	2.7	2.3	1.0	4.8
$RMSE$ Results					
Avg. $SERA$	13.93 ± 0.28	12.62 ± 0.44	6.82 ± 0.28	26.63 ± 3.33	8.6 ± 0.26
Avg. Rank	4.0	3.0	1.0	5.0	2.0

In the following subsections, we conduct a detailed investigation into the influence of the parameters β and α on this synthetic dataset. Specifically, we analyze their impact on the probability values and the oversampling rates calculated in the HistUS and HistOS algorithms.

7.2.1 Impact of parameter β on the probability function

Figure 5 illustrates the influence of different values of the parameter β on the probability values obtained over our synthetic dataset. The parameter β governs the extent to which frequent and rare cases are favored in the selection process. As shown in the figure, higher values of β result in a steeper decline in probability, increasing the likelihood of selecting rare cases and reducing the selection of frequent cases. Conversely, lower values of β flatten the probability curve, making the selection more uniform across different bins.

7.2.2 Impact of parameter α on the oversampling rate

Figure 6 illustrates the effect of different values of the parameter α on the frequency of over-sampling across the target values of the generated synthetic dataset. The x-axis represents the target values, while the y-axis denotes the number of times each target value has been over-sampled. The curves correspond to different α values, where lower α leads to a higher frequency of over-sampling. This trend highlights the role of α in controlling the balance between rare

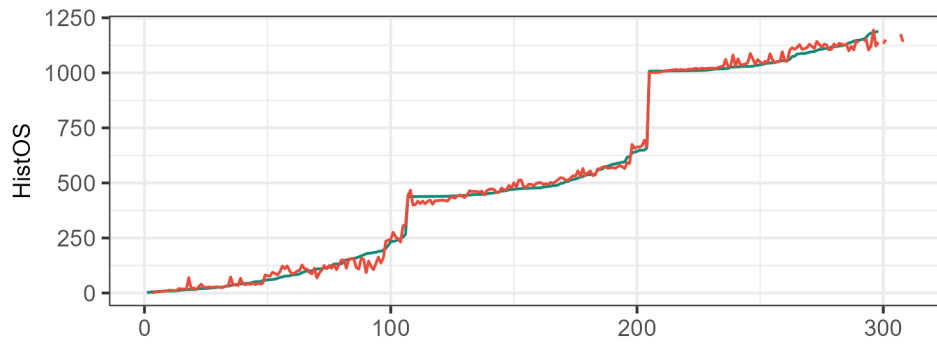
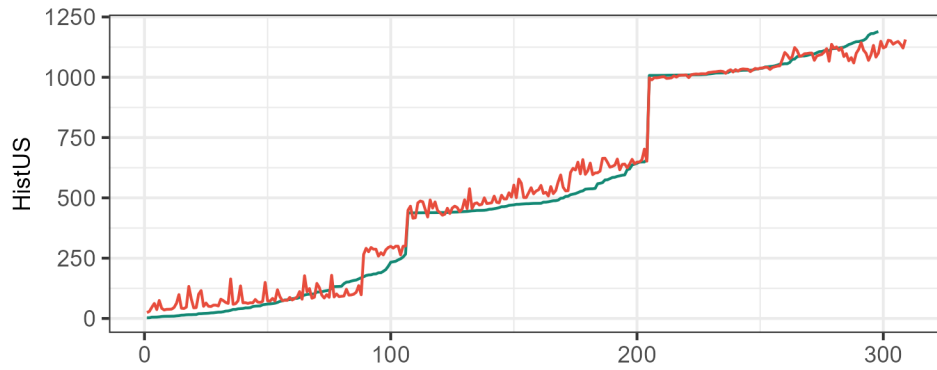
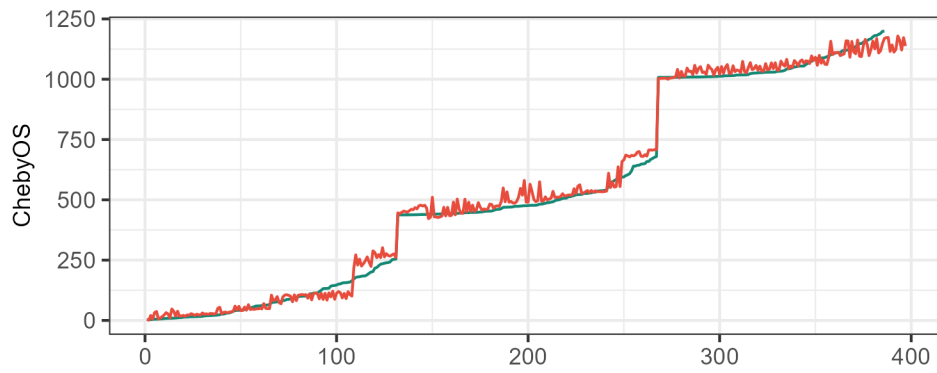
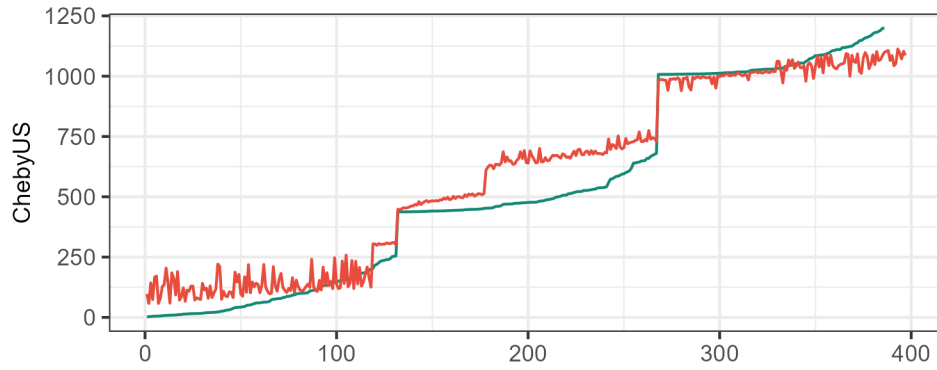

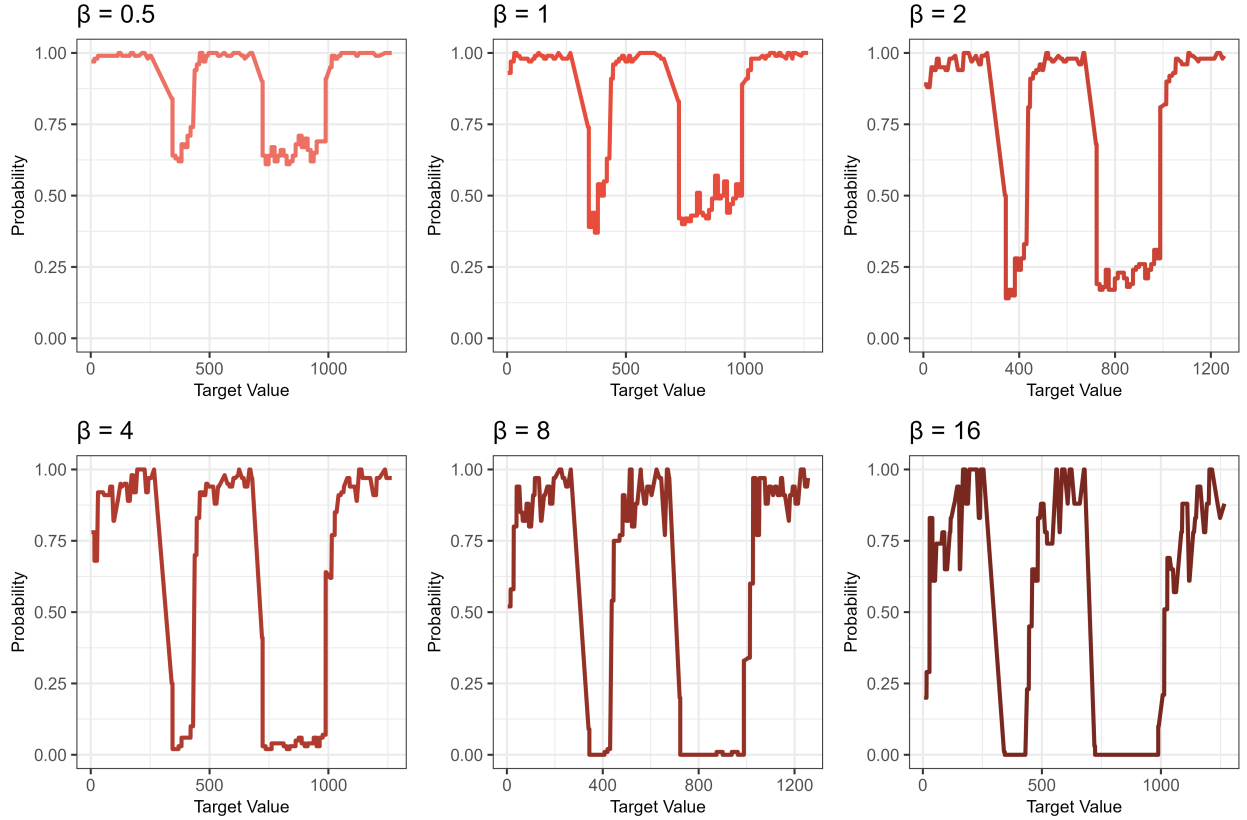

Figure 5: Influence of different values of the parameter β on the probability values obtained over the synthetic dataset.

and frequent target values, with smaller α intensifying the over-sampling of rare cases. It is worth mentioning that, the numbers in the y-axis have been smoothed to enhance clarity, ensuring a more interpretable representation of the underlying trends.

7.3 Experimental Settings

We conducted experiments on thirteen benchmark datasets sourced from the UCI repository (Dua and Graff, 2017). Table 2 presents key statistics for each dataset, including the number of attributes, examples, and the count and percentage of rare cases. Our analysis designated examples with a relevance value exceeding 0.9 as rare cases. No pre-processing step has been done on the data set, and all features of the data sets feed the learner models by their original form and value.

The proposed methodologies were implemented in Kotlin 1.4.10 using the MOA (Massive Online Analysis) framework (Bifet et al., 2010), an open-source tool designed for mining and analyzing large datasets streamingly. We utilised the R programming language for error computation and result analysis (version 4.3.2).

In alignment with our prior paper, we utilised four diverse regression models as base learners to alleviate potential algorithm-dependent biases that could introduce distortions to the results to assess our novel HistOS sampling method. These models included the perceptron (Block, 1988), fast incremental model trees with drift detection (FIMT-DD)(Ikonomovska et al., 2011), TargetMean (which calculates the mean of the target variable from training examples), and AMRules(Duarte et al., 2016). In each experiment, we employed two instances of each learner with identical initial parameters. One instance was trained using our proposed HistOS sampling method, while the other, referred to as the Baseline, underwent training with all examples in the dataset. For each model, we calculated $RMSE$, $RMSE_\phi$, and $SERA$ which are described in the next subsection. Each experiment was conducted ten times, and the results were reported as averages and standard deviations. Throughout all experiments, we adhered to a prequential evaluation procedure (Gama et al., 2013), where models were continuously updated after processing each example. Specifically, each example was used for both testing and training. The evaluation involved initially assessing the model on the instance, followed by a single incremental learning step. Moreover, 15% of examples in each dataset were allocated

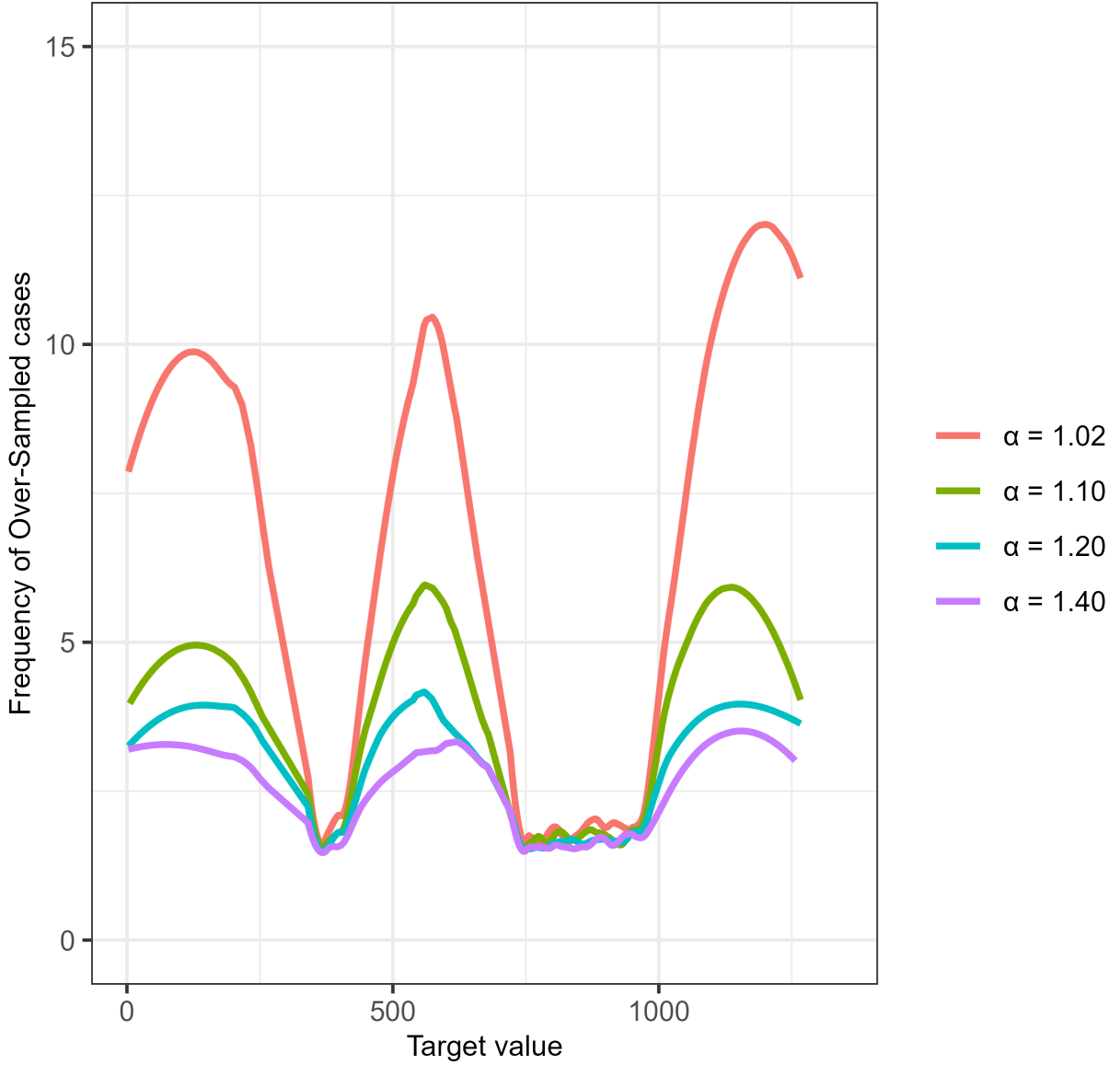

Figure 6: Influence of different values of the parameter α on over-sampling rate. We set $\beta = 1$ in the experiments.

to the warming phase, 20% for training purposes, and the remaining 65% earmarked for model testing. Regarding the parameter β within the probability function, as previously highlighted, its value signifies a balance between the algorithm’s capability to detect rare cases and its inclination to disregard frequent ones. We maintained a consistent value of 1 for β across all experiments after minor adjustments to our datasets. Nonetheless, optimizing this parameter could yield improved outcomes in certain scenarios, albeit these are not detailed here. Similarly, for the parameter α in HiStOS, we set its value to 1.1 across all the experiments.

7.3.1 Squared Error-Relevance Area (SERA)

The Squared Error-Relevance Area (SERA) Ribeiro and Moniz (2020) is an evaluation metric designed to assess model performance in imbalanced regression tasks. As stated before, traditional regression metrics, such as MSE, treat all errors uniformly, which is inadequate in scenarios where rare values require higher predictive accuracy. Like $RMSE_\phi$,

Table 2: Data sets characterization.

Data set	#Attributes	#Examples	#Rare cases (%)
puma32H	34	8,192	211 (%2.58)
cpusum	14	8,192	366 (%4.47)
mv	12	40,768	4,582 (%11.24)
elevator	20	16,599	2,172 (%13.09)
energydata-complete	29	19,735	3,506 (%17.77)
FriedmanArtificialDomain	12	40,768	807 (%1.98)
california	10	20,639	1,272 (%6.16)
bike	18	17,379	3,702 (%21.3)
3d-spatial-network	5	434,873	31,255 (%7.19)
Range-Queries-Aggregates	8	199,843	50,543 (%25.29)
pp-gas-emission	12	36,733	1,823 (%4.96)
GPU-Kernel-Performance	16	241,600	43,019 (%17.81)
polution	13	41,757	4,693 (%11.24)

SERA addresses this limitation by incorporating a relevance function $\phi(y)$ that assigns different importance levels to different target values.

Given a true target value y_i and its corresponding prediction \hat{y}_i , the squared error is computed as:

$$SE_i = (y_i - \hat{y}_i)^2. \quad (8)$$

SERA extends this by weighting the squared error based on the relevance of each target value:

$$WSE_{R_i} = \phi(y_i) \cdot (y_i - \hat{y}_i)^2. \quad (9)$$

The final *SERA* metric is defined as the area under the relevance-weighted squared error curve:

$$SERA = \int_{y_{\min}}^{y_{\max}} \phi(y) \cdot \mathbb{E}[(y - \hat{y})^2 | y] dy. \quad (10)$$

where $\mathbb{E}[(y - \hat{y})^2 | y]$ represents the expected squared error for a given target value y . The relevance function ($\phi(y)$) used in our experiment was described in 7.1.

By weighting errors dynamically based on relevance, *SERA* provides a more informative and context-aware evaluation than traditional error-based metrics, ensuring that models are evaluated with an emphasis on their ability to predict rare, high-impact cases.

As introduced in Section ??, $RMSE_\phi$ extends RMSE by incorporating the relevance function into the error aggregation:

$$RMSE_\phi = \sqrt{\frac{1}{n} \sum_{i=1}^n \phi(y_i) \cdot (y_i - \hat{y}_i)^2}. \quad (11)$$

Unlike *SERA*, which evaluates model performance across the entire relevance spectrum, $RMSE_\phi$ provides a single aggregated score, preserving the interpretability of RMSE while emphasizing errors in high-relevance regions.

Although both metrics address the challenges of evaluating imbalanced regression models, they serve different purposes. *SERA* offers a more detailed assessment of performance variations across relevance levels, whereas $RMSE_\phi$ provides a compact yet informative measure for direct model comparison.

Overall, *SERA* is well-suited for in-depth analysis, while $RMSE_\phi$ is advantageous for tracking performance trends over time.

7.3.2 Results

In this section, we provide a concise overview of our results, while a comprehensive breakdown of all findings is elaborated in Tables ?? to ?? in the Appendix. To facilitate comparison, we have transformed each table into graphical representations, illustrating the wins and losses reported by each learner employing our sampling strategies against its corresponding baseline model in Figure 7 to 12. The significance of wins and losses (at a 95% confidence level), as determined through the Wilcoxon signed-rank test, is also depicted on these graphs.

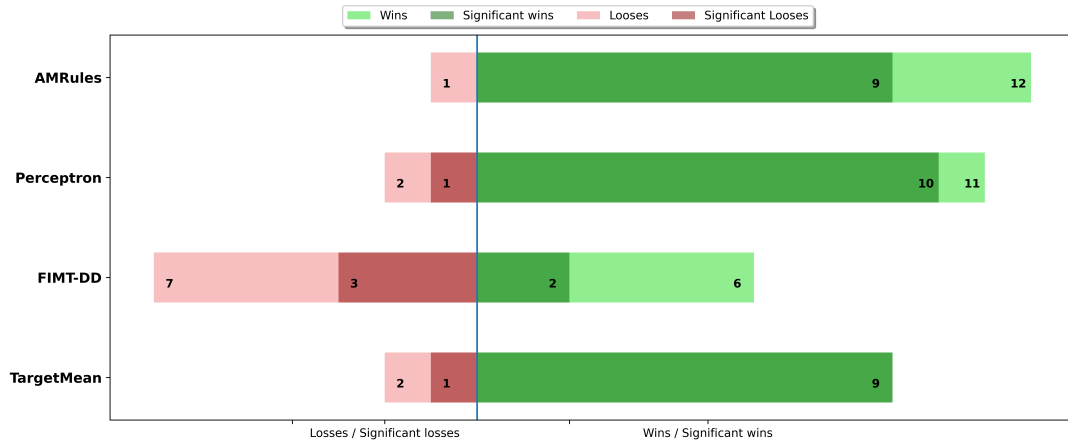

Figure 7: Evaluation function: $RMSE_\phi$, Sampling Strategy: HistUS

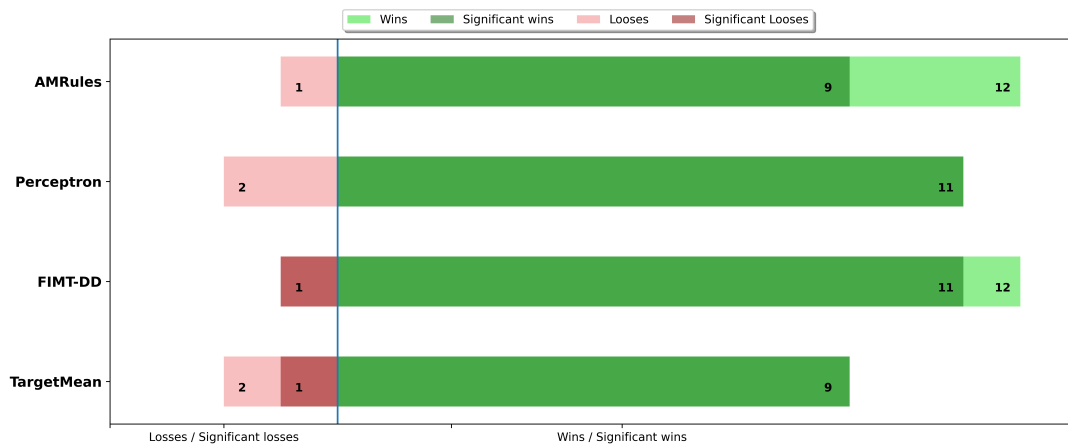

Figure 8: Evaluation function: $RMSE_\phi$, Sampling Strategy: HistOS

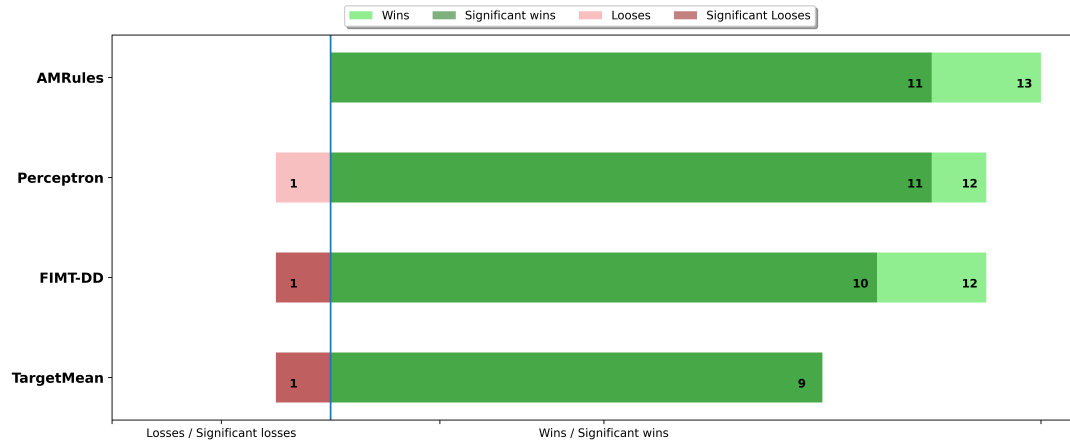

Figure 9: Evaluation function: *SERA*, Sampling Strategy: HistUS

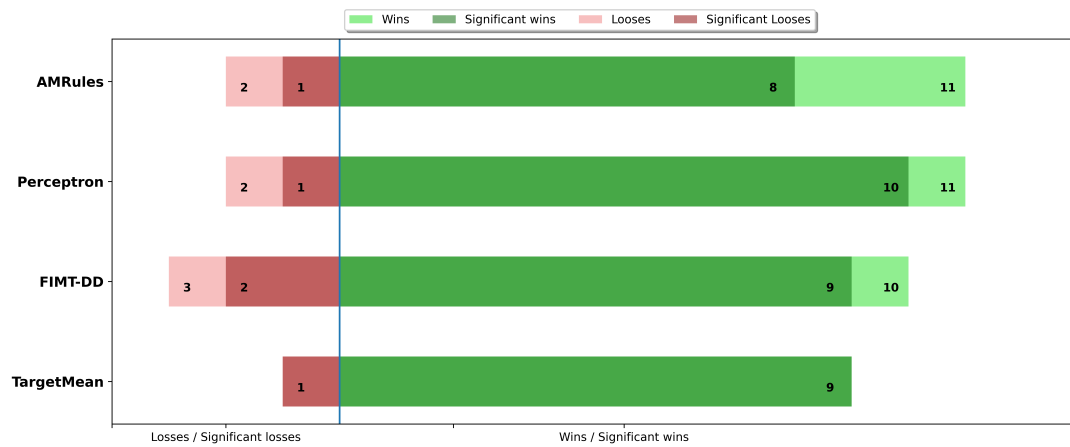

Figure 10: Evaluation function: *SERA*, Sampling Strategy: HistOS

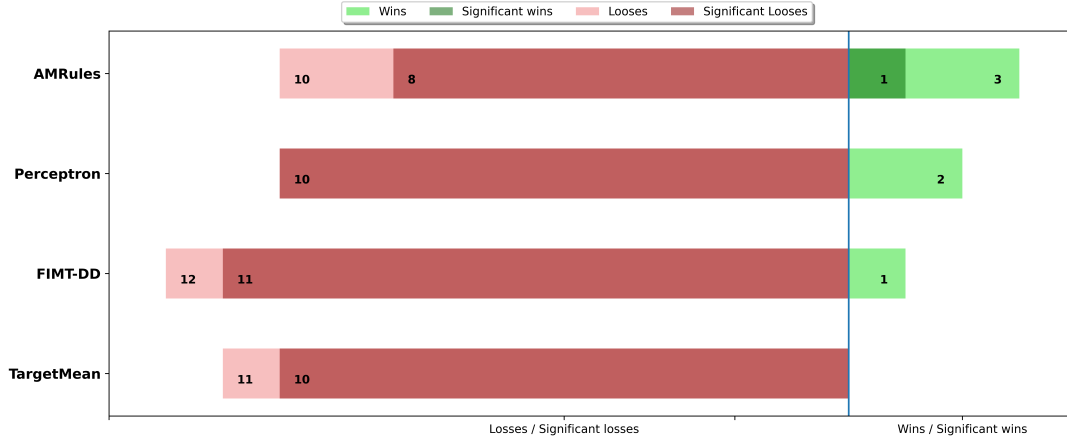

Figure 11: Evaluation function: $RMSE$, Sampling Strategy: HistUS

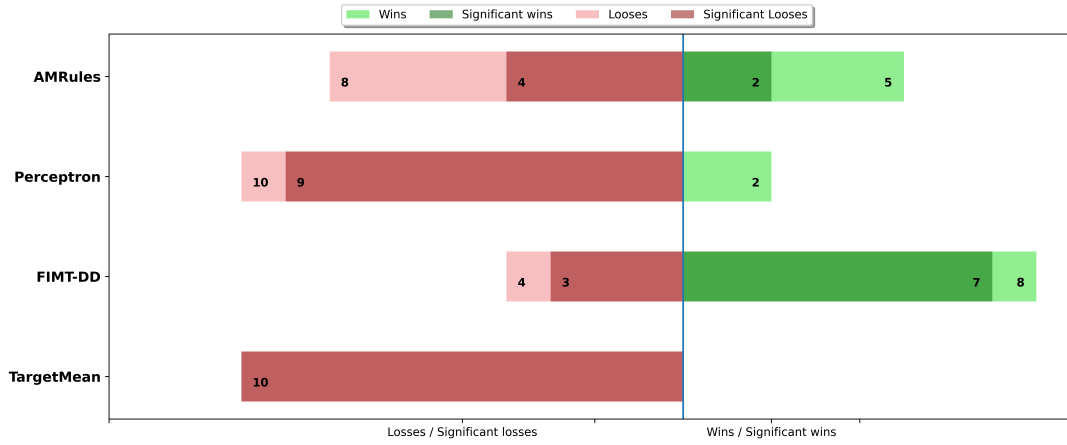

Figure 12: Evaluation function: $RMSE$, Sampling Strategy: HistOS

Additionally, Critical Difference (CD) diagrams, employing the post-hoc Nemenyi test (Demšar, 2006), provide a comparative assessment of the learners’ contributions across different result groups in the experiments in Figures 13 to 18.

Tables 6 to 8 also summarize the experimental results, presenting the average ranks and the number of significant wins for various regression algorithms under three conditions: baseline (no sampling), histogram-based under-sampling (HistUS), and histogram-based over-sampling (HistOS). The threshold thr_ϕ is set to 0.9 in our experiments.

7.3.3 Analysis of the Results

When focusing on the prediction of rare cases, our proposed histogram-based sampling strategies (HistUS and HistOS) demonstrate superior performance compared to the baseline models. This can be observed from:

- The higher number of significant wins for HistUS and HistOS across different algorithms in $RMSE_\phi$ (Table 6) and $SERA$ (Table 7).
- The lower average rank of HistUS and HistOS in these tables, indicating their effectiveness in predicting rare cases.

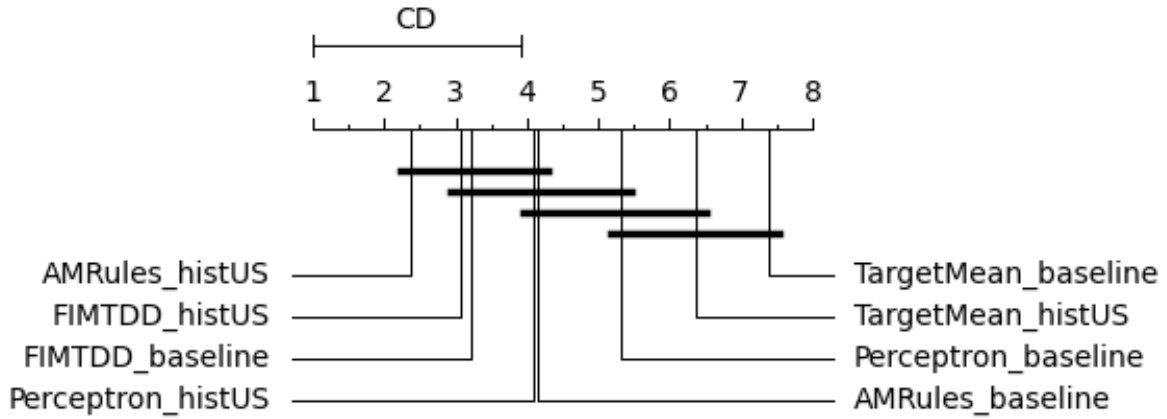

Figure 13: Evaluation function: $RMSE_{\phi}$, Sampling Strategy: HistUS

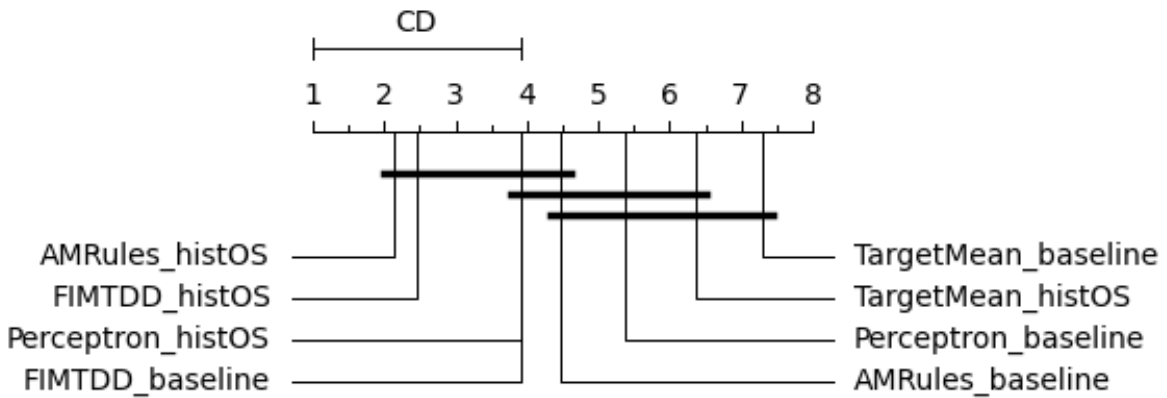

Figure 14: Evaluation function: $RMSE_{\phi}$, Sampling Strategy: HistOS

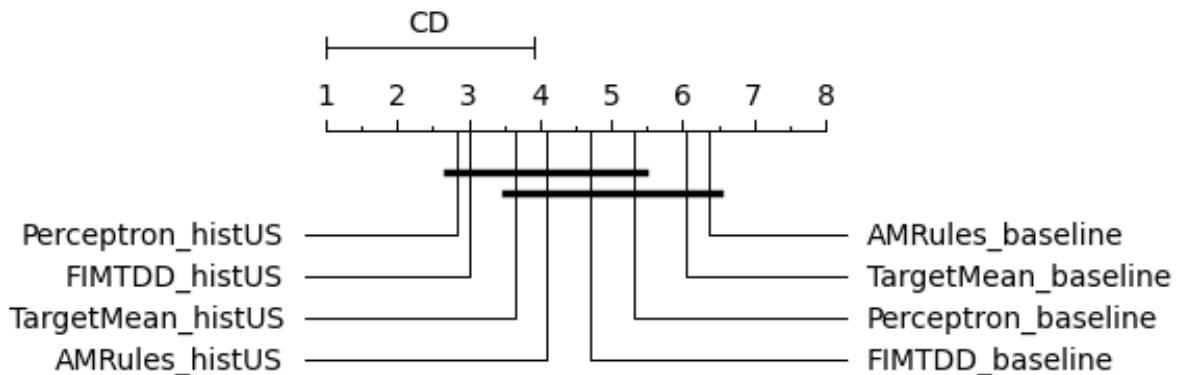

Figure 15: Evaluation function: $SERA$, Sampling Strategy: HistUS

Among the tested algorithms, Perceptron and AMRules particularly benefited from the sampling strategies, with HistOS showing slightly better gains in terms of significant wins.

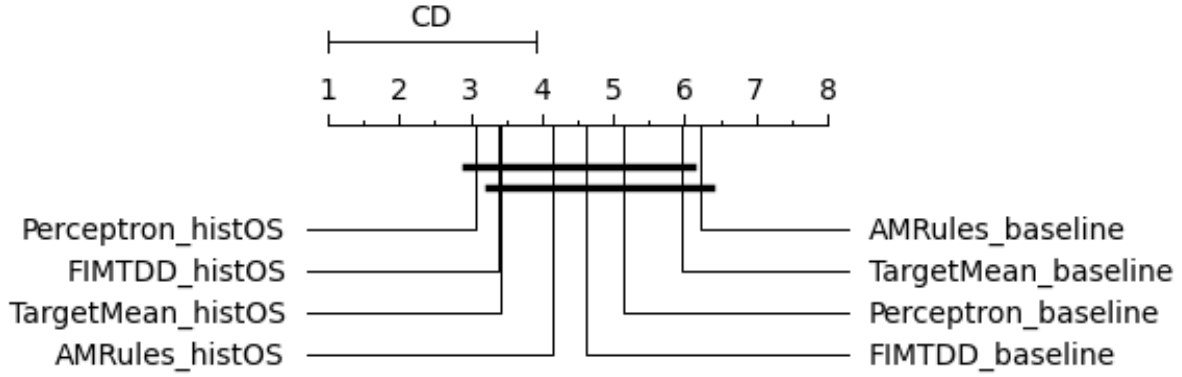

Figure 16: Evaluation function: *SERA*, Sampling Strategy: HistOS

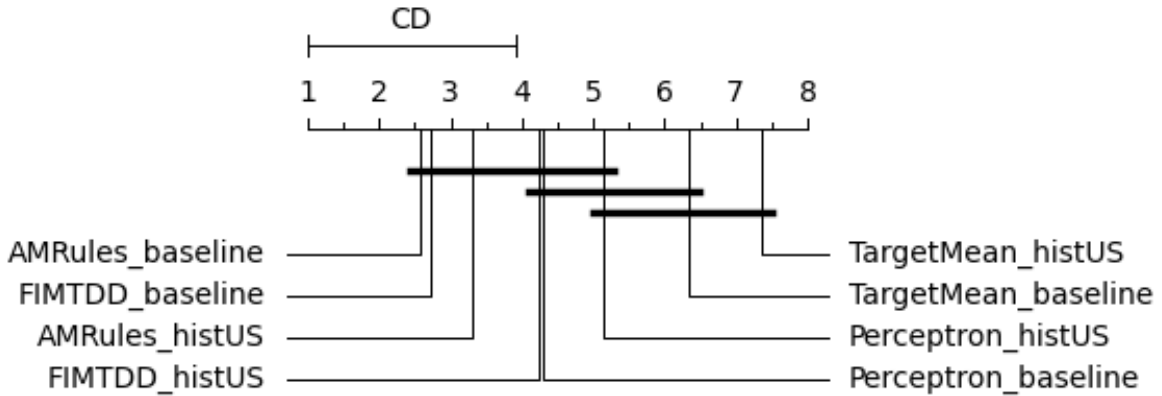

Figure 17: Evaluation function: *RMSE*, Sampling Strategy: HistUS

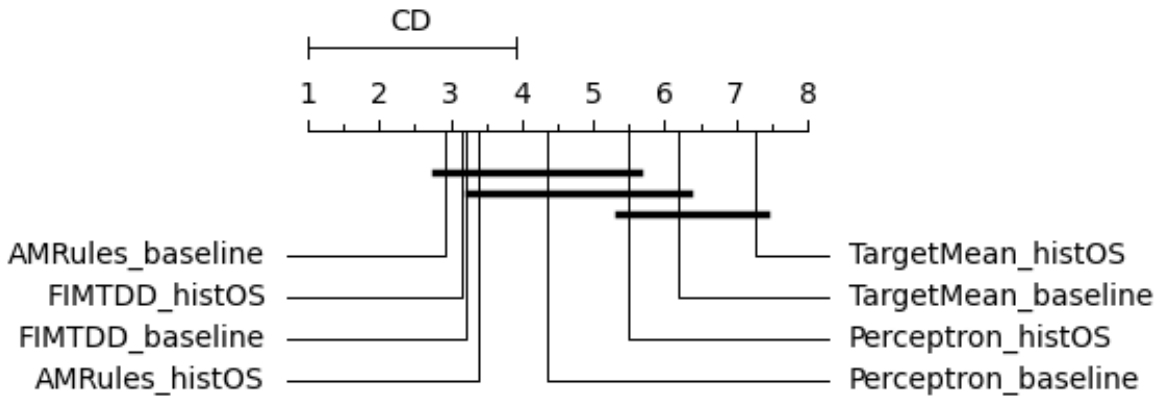

Figure 18: Evaluation function: *RMSE*, Sampling Strategy: HistOS

However, when evaluating the overall regression performance using RMSE (Table 8), the baseline models generally outperform sampling-based approaches.

Based on the above, the results highlight our proposed sampling strategies (HistUS and HistOS) excel in rare case prediction, making them well-suited for applications where capturing rare cases is crucial.

Table 3: Summary of $RMSE_\phi$ results, for four regression algorithms with no sampling (Baseline) and with our proposed sampling histogram-based strategies (HistUS and HistOS).

	AMRules		Perceptron		FIMT-DD		TargetMean	
	Baseline	HistUS	Baseline	HistUS	Baseline	HistUS	Baseline	HistUS
Avg. Rank	4.15	2.38	5.31	4.08	3.23	3.08	7.38	6.38
Sign. Wins	0	9	1	10	3	2	1	9
	Baseline	HistOS	Baseline	HistOS	Baseline	HistOS	Baseline	HistOS
Avg. Rank	4.46	2.15	5.38	3.92	3.92	2.46	7.31	6.38
Sign. Wins	0	9	0	11	1	11	1	9

Table 4: Summary of $SERA$ results, for four regression algorithms with no sampling (Baseline) and with our proposed sampling histogram-based strategies (HistUS and HistOS).

	AMRules		Perceptron		FIMT-DD		TargetMean	
	Baseline	HistUS	Baseline	HistUS	Baseline	HistUS	Baseline	HistUS
Avg. Rank	6.38	4.08	5.31	2.85	4.69	3.0	6.04	3.65
Sign. Wins	0	11	0	11	1	10	1	9
	Baseline	HistOS	Baseline	HistOS	Baseline	HistOS	Baseline	HistOS
Avg. Rank	6.23	4.15	5.15	3.08	4.62	3.38	5.96	3.42
Sign. Wins	1	8	1	10	2	9	1	9

Table 5: Summary of $RMSE$ results, for four regression algorithms with no sampling (Baseline) and with our proposed sampling histogram-based strategies (HistUS and HistOS).

	AMRules		Perceptron		FIMT-DD		TargetMean	
	Baseline	HistUS	Baseline	HistUS	Baseline	HistUS	Baseline	HistUS
Avg. Rank	2.58	3.31	4.31	5.15	2.73	4.23	6.35	7.35
Sign. Wins	8	1	10	0	11	1	10	0
	Baseline	HistOS	Baseline	HistOS	Baseline	HistOS	Baseline	HistOS
Avg. Rank	2.92	3.38	4.35	5.5	3.23	3.15	6.19	7.27
Sign. Wins	4	2	9	2	3	7	10	0

7.4 Comparative Analysis

7.4.1 Comparison between HistUS and HistOS methods:

We also compare our proposed histogram-based sampling strategies (HistUS and HistOS) across the datasets using three performance metrics: $RMSE_\phi$, SERA, and RMSE. The results, summarized in Figures 19 to 24 and Tables 6 to 8, provide insights into the effectiveness of these strategies in enhancing predictive performance for rare cases.

The analysis of $RMSE_\phi$ (Table 6) demonstrates that HistOS consistently outperforms HistUS in rare case prediction, as indicated by its lower average ranks and a higher number of significant wins across all four regression algorithms. Notably, HistOS achieves a significant improvement for FIMT-DD, securing the highest number of wins (12).

The results for SERA (Table 7) further reinforce the superior performance of HistOS, particularly for Perceptron and TargetMean, where it achieves eight significant wins. The overall trend indicates that HistOS provides a more balanced improvement across different regression models, while HistUS, despite its competitive performance, falls slightly behind in terms of both rank and significant wins.

Conversely, when evaluating overall regression performance using RMSE (Table 8), the performance gap between HistUS and HistOS varies across models. HistOS again demonstrates strong results for FIMT-DD, securing 11 significant wins, while HistUS achieves a more balanced performance across AMRules and Perceptron. However, the results for TargetMean suggest that HistOS might introduce some performance degradation in overall RMSE, as indicated by its higher rank and lower number of significant wins.

Overall, the results indicate a clear trade-off: while HistOS generally enhances rare case prediction and achieves higher significance in $RMSE_\phi$ and SERA, its impact on RMSE is more model-dependent.

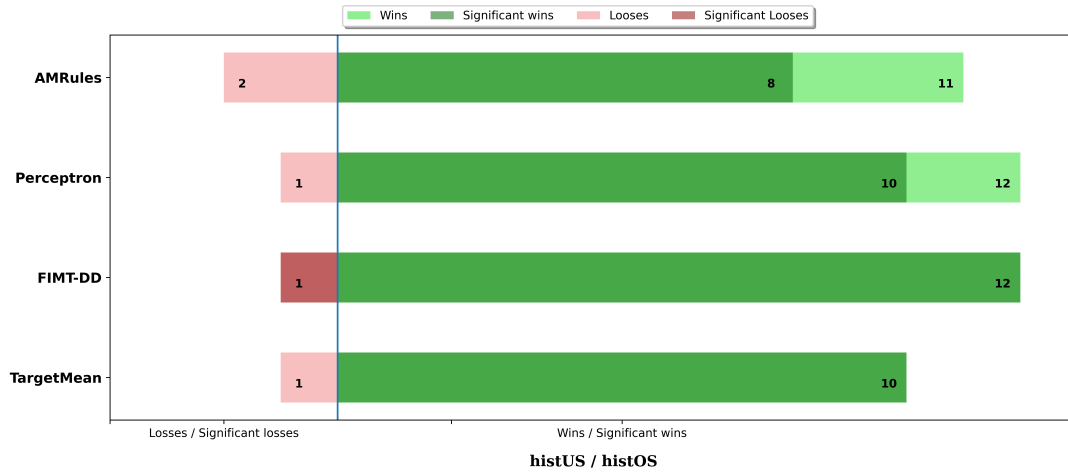

Figure 19: Evaluation: $RMSE_{\phi}$, Methods: HistUS (left) and HistOS (right)

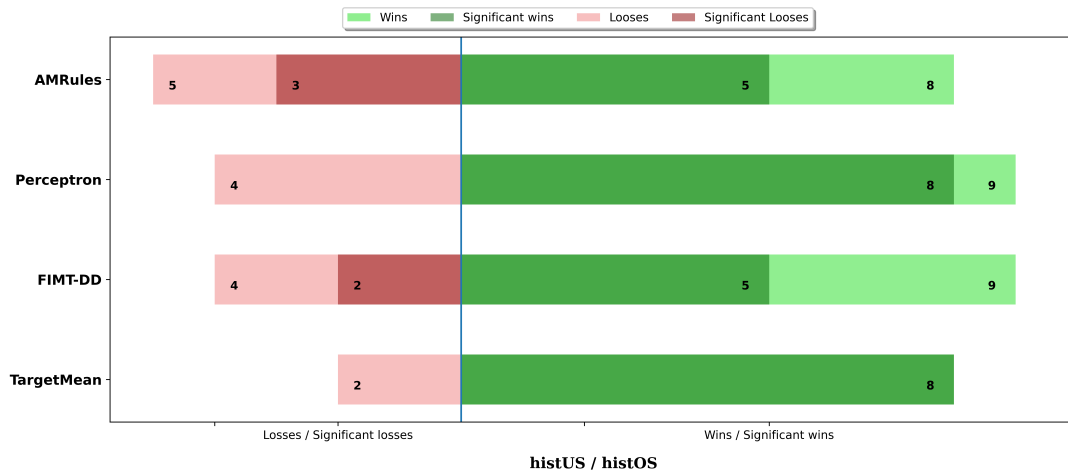

Figure 20: Evaluation: $SERA$, Methods: HistUS (left) and HistOS (right)

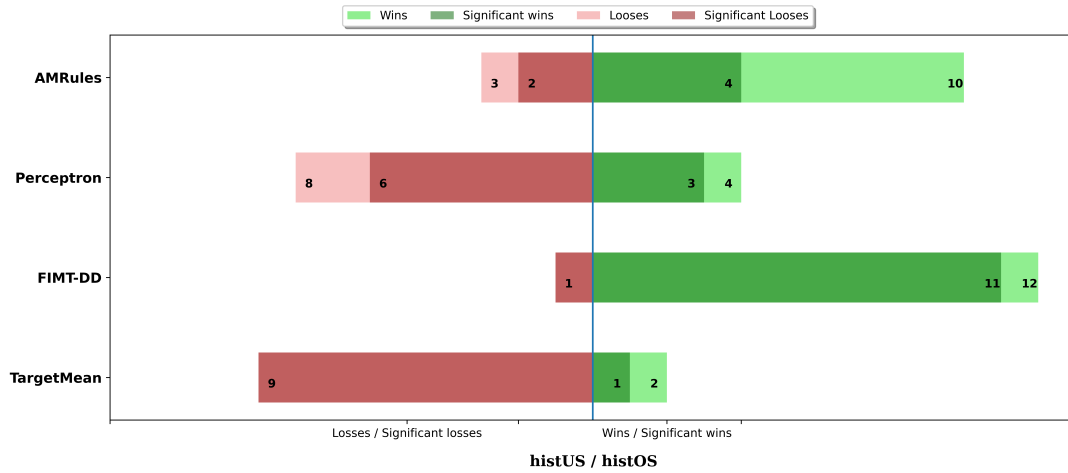

Figure 21: Evaluation: $RMSE$, Methods: HistUS (left) and HistOS (right)

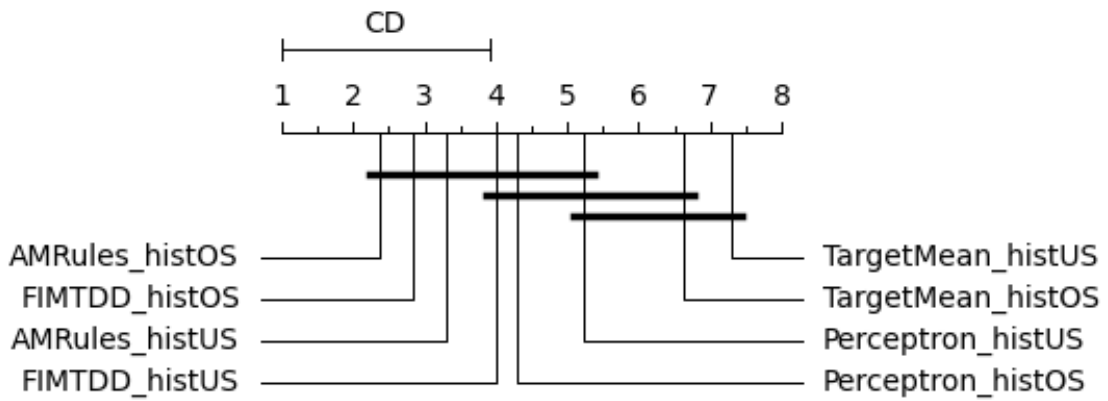

Figure 22: Evaluation: $RMSE_\phi$, Methods: HistUS and HistOS

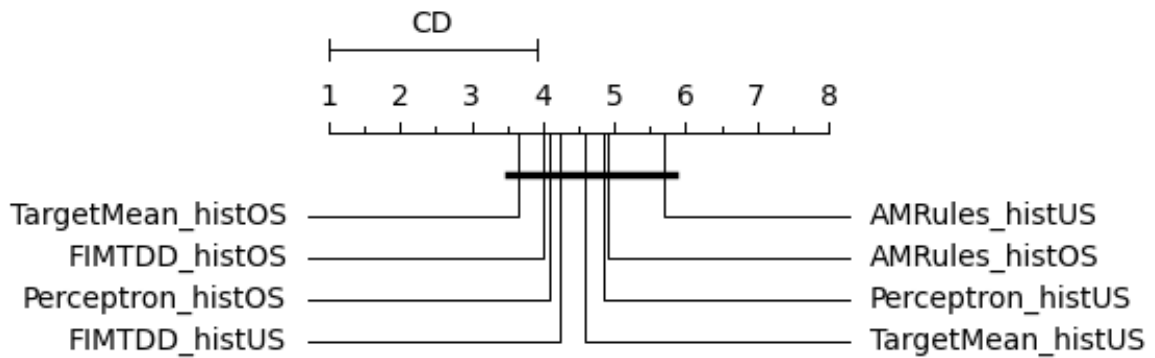

Figure 23: Evaluation: $SERA$, Methods: HistUS and HistOS

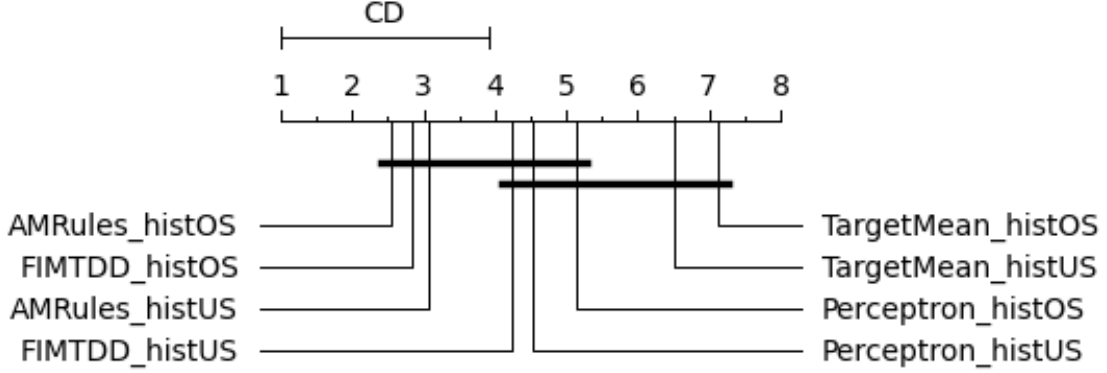

Figure 24: Evaluation: $RMSE$, Methods: HistUS and HistOS

Table 6: Comparison of $RMSE_\phi$ results of our proposed sampling histogram-based strategies (HistUS and HistOS) over four regression algorithms.

	AMRules		Perceptron		FIMT-DD		TargetMean	
	HistUS	HistOS	HistUS	HistOS	HistUS	HistOS	HistUS	HistOS
Avg. Rank	3.31	2.38	5.23	4.31	4.0	2.85	7.31	6.62
Sign. Wins	0	8	0	10	1	12	0	10

Table 7: Comparison of $SERA$ results of our proposed sampling histogram-based strategies (HistUS and HistOS) over four regression algorithms.

	AMRules		Perceptron		FIMT-DD		TargetMean	
	HistUS	HistOS	HistUS	HistOS	HistUS	HistOS	HistUS	HistOS
Avg. Rank	5.69	4.92	4.85	4.08	4.23	4.0	4.58	3.65
Sign. Wins	3	5	0	8	2	5	0	8

Table 8: Comparison of $RMSE$ results of our proposed sampling histogram-based strategies (HistUS and HistOS) over four regression algorithms.

	AMRules		Perceptron		FIMT-DD		TargetMean	
	HistUS	HistOS	HistUS	HistOS	HistUS	HistOS	HistUS	HistOS
Avg. Rank	3.08	2.54	4.54	5.15	4.23	2.85	6.5	7.12
Sign. Wins	2	4	6	3	1	11	9	1

7.4.2 Comparing Histogram and Chebyshev-based approaches

In this section, we analyze the comparative performance of the proposed histogram-based and Chebyshev-based sampling strategies under both under-sampling and over-sampling settings. The evaluation is conducted using two key metrics, $RMSE_\phi$ and SERA, across four regression algorithms. As the relevance value, we use the ϕ value assigned to each instance, as described in Section 7.1. The results, summarized in Figures 25 to 32 and Tables 9 to 12, provide insight into the effectiveness of each approach in handling rare case predictions.

The analysis of $RMSE_\phi$ for under-sampling (Figures 25, 29 and Table 9) shows that ChebyUS consistently outperforms HistUS, achieving a lower average rank across all models and securing significantly more wins, particularly for AMRules (8 wins), Perceptron (10 wins) and TargetMean (11 wins). This suggests that the Chebyshev-based approach is more effective in reducing prediction errors for rare cases when using under-sampling. Similarly, in the over-sampling setting (Figures 26, 30 and Table 10), ChebyOS maintains a competitive performance, outperforming HistOS in AMRules and FIMT-DD, although HistOS demonstrates stronger results in Perceptron and TargetMean.

The comparison based on SERA (Figures 27, 28, 31 and Tables 11 and 12) further supports the superior performance of ChebyUS in rare case prediction. Under-sampling results reveal a clear dominance of ChebyUS, with significantly

lower ranks and a higher number of wins across all regression models. This trend holds across AMRules, Perceptron, FIMT-DD, and TargetMean, confirming that Chebyshev-based under-sampling effectively preserves the structure of rare cases. In contrast, the over-sampling results indicate a more balanced performance between ChebyOS and HistOS. While ChebyOS outperforms HistOS in AMRules, HistOS demonstrates superior performance in Perceptron and TargetMean.

Overall, the results indicate that Chebyshev-based strategies are particularly effective in rare case prediction when using under-sampling, consistently outperforming histogram-based methods in both $RMSE_\phi$ and SERA. However, in over-sampling settings, the performance varies depending on the regression model, with HistOS showing competitive results in certain cases.

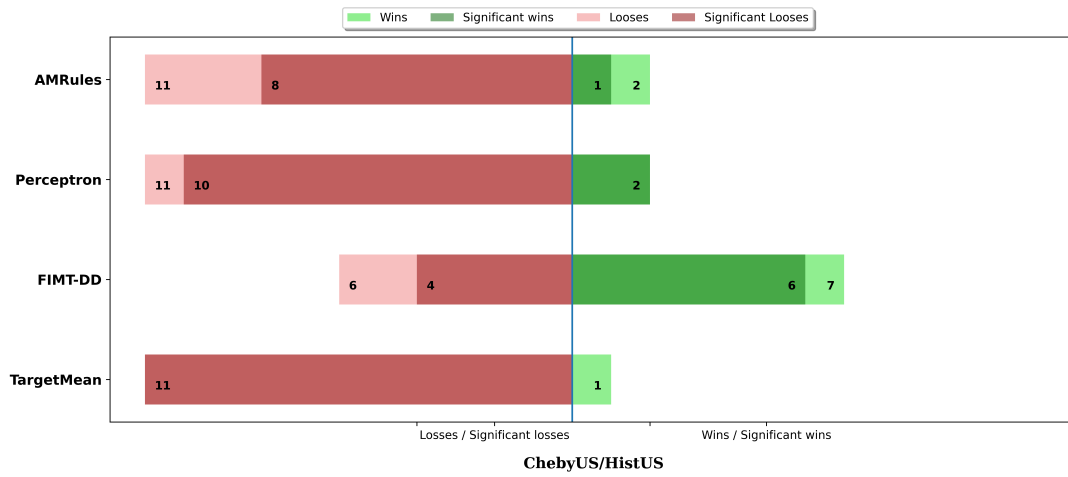

Figure 25: Evaluation: $RMSE_\phi$, Methods: ChebyUS (left) and HistUS (right)

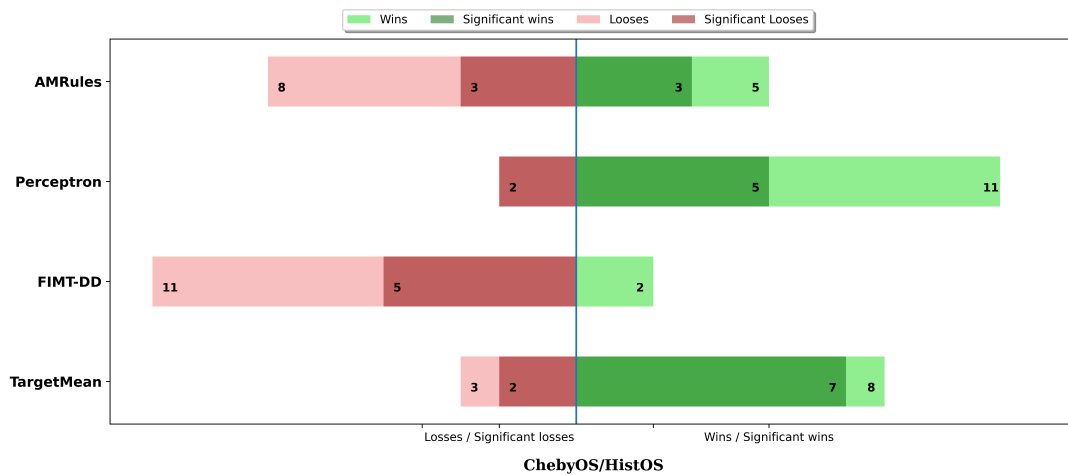

Figure 26: Evaluation: $RMSE_\phi$, Methods: ChebyOS (left) and HistOS (right)

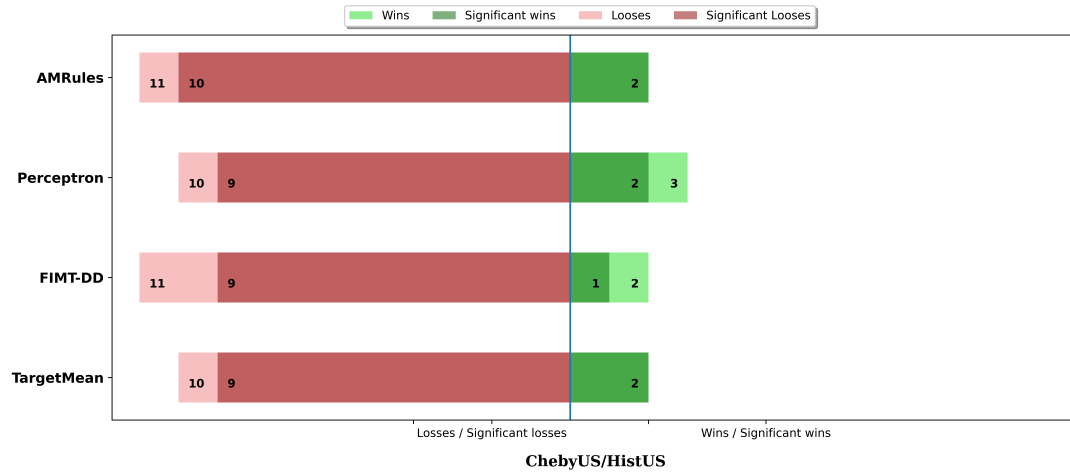

Figure 27: Evaluation: *SERA*, Methods: ChebyUS (left) and HistUS (right)

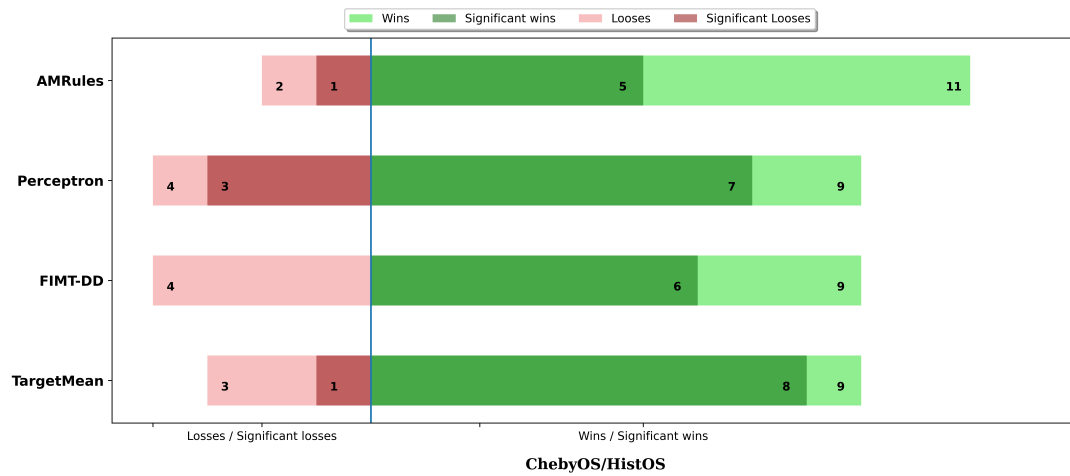

Figure 28: Evaluation: *SERA*, Methods: ChebyOS (left) and HistOS (right)

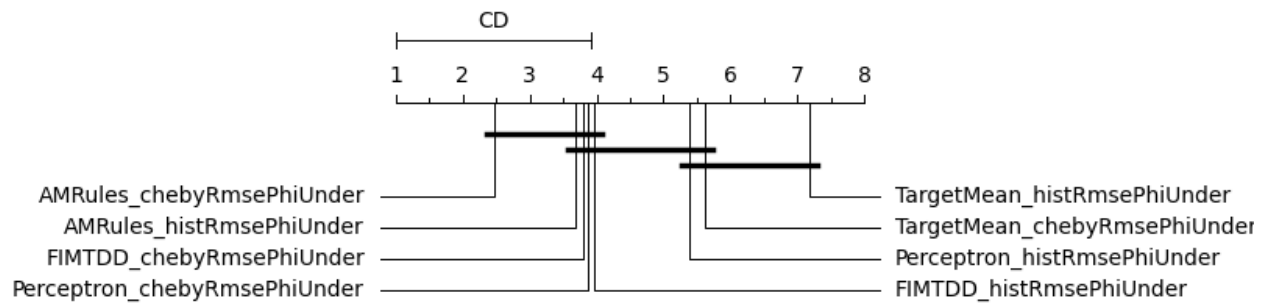

Figure 29: Evaluation: $RMSE_\phi$, Methods: ChebyUS and HistUS

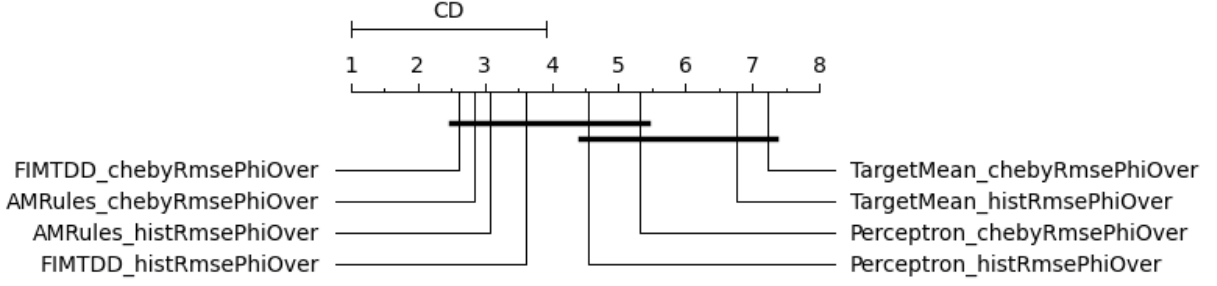

Figure 30: Evaluation: $RMSE_\phi$, Methods: ChebyOS and HistOS

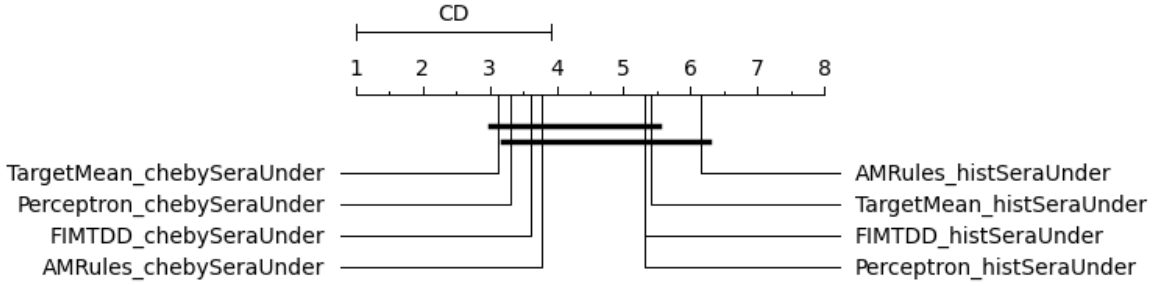

Figure 31: Evaluation: $SERA$, Methods: ChebyUS and HistUS

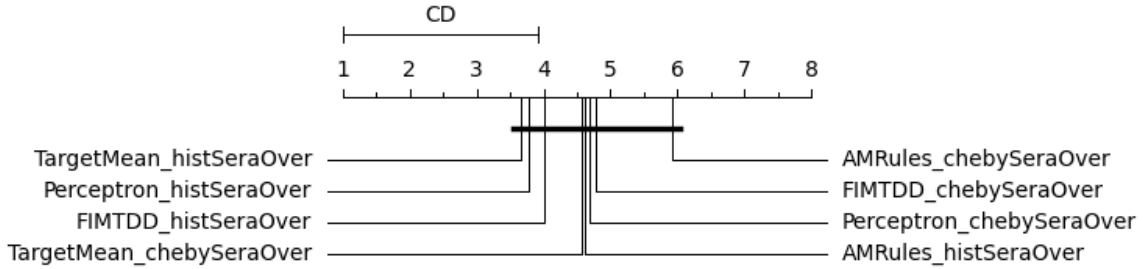

Figure 32: Evaluation: $SERA$, Methods: ChebyOS and HistOS

Table 9: Comparison of $RMSE_\phi$ results of our proposed Under-sampling chebyshev-based and histogram-based strategies (ChebyUS and HistUS) over four regression algorithms.

	AMRules		Perceptron		FIMT-DD		TargetMean	
	ChebyUS	HistUS	ChebyUS	HistUS	ChebyUS	HistUS	ChebyUS	HistUS
Avg. Rank	2.46	3.69	3.88	5.38	3.81	3.96	5.62	7.19
Sign. Wins	8	1	10	2	4	6	11	1

8 Conclusions and Future works

In this paper, we tackled the challenge of learning from imbalanced regression data streams, where rare cases can occur at any point in the distribution. We introduced two novel sampling strategies, HistUS (Histogram-Based Under-Sampling) and HistOS (Histogram-Based Over-Sampling), designed to dynamically detect and handle rare cases using an online histogram-based heuristic. These strategies were developed to overcome a critical limitation of prior

Table 10: Comparison of $RMSE_\phi$ results of our proposed Over-sampling chebyshev-based and histogram-based strategies (ChebyOS and HistOS) over four regression algorithms.

	AMRules		Perceptron		FIMT-DD		TargetMean	
	ChebyOS	HistOS	ChebyOS	HistOS	ChebyOS	HistOS	ChebyOS	HistOS
Avg. Rank	2.85	3.08	5.31	4.54	2.62	3.62	7.23	6.77
Sign. Wins	3	3	2	5	5	2	2	7

Table 11: Comparison of $SERA$ results of our proposed Under-sampling chebyshev-based and histogram-based strategies (ChebyUS and HistUS) over four regression algorithms.

	AMRules		Perceptron		FIMT-DD		TargetMean	
	ChebyUS	HistUS	ChebyUS	HistUS	ChebyUS	HistUS	ChebyUS	HistUS
Avg. Rank	3.77	6.15	3.31	5.31	3.62	5.31	3.12	5.42
Sign. Wins	10	2	9	2	9	1	9	2

Table 12: Comparison of $SERA$ results of our proposed Over-sampling chebyshev-based and histogram-based strategies (ChebyOS and HistOS) over four regression algorithms.

	AMRules		Perceptron		FIMT-DD		TargetMean	
	ChebyOS	HistOS	ChebyOS	HistOS	ChebyOS	HistOS	ChebyOS	HistOS
Avg. Rank	5.92	4.62	4.69	3.77	4.77	4.0	4.58	3.65
Sign. Wins	1	5	3	7	0	6	1	8

approaches, ChebyUS and ChebyOS, which assume that rare cases are confined to the distribution tails. By leveraging histogram-based rarity detection, our methods adaptively adjust the data sampling process, ensuring that rare instances are effectively recognized and utilized for model training.

The experimental evaluation, conducted on a diverse set of 13 real-world datasets, demonstrated that the proposed approaches consistently outperform baseline models in predictive performance. The results indicate that HistUS and HistOS not only reduce prediction errors for rare cases but also improve the overall model generalization. Furthermore, our study highlights the role of two key parameters, β and α , which influence the probability estimation and oversampling rate in our histogram-based methods. A deeper exploration of their impact revealed that tuning these parameters can significantly enhance the effectiveness of rare case detection and model training.

Despite these promising results, several areas remain open for future research. One critical direction is to extend our methods to explicitly handle concept drift, a common challenge in evolving data streams. While the online histogram inherently adapts to changes in data distribution, a more formalized drift detection mechanism could further improve performance under non-stationary conditions. Another important avenue is the investigation of adaptive parameter tuning strategies, where β and α could be dynamically optimized during the learning process rather than being set empirically.

In conclusion, our proposed histogram-based sampling approaches provide an effective solution for imbalanced regression data streams, offering substantial improvements over traditional Chebyshev-based methods. The ability to detect and learn from rare instances throughout the entire distribution—rather than just at the tails—makes our method a valuable tool for real-time data stream applications. Future research will focus on extending these methods to more complex streaming environments, further optimizing their adaptability, and exploring their integration into broader machine-learning frameworks.

References

- Ludivia Hernandez Aros, Luisa Ximena Bustamante Molano, Fernando Gutierrez-Portela, John Johver Moreno Hernandez, and Mario Samuel Rodríguez Barrero. Financial fraud detection through the application of machine learning techniques: a literature review. *Humanities and Social Sciences Communications*, 11(1):1–22, 2024.
- Ashulekha Gupta, N Chaithra, Janhvi Jha, Anu Sayal, Veethika Gupta, and Minakshi Memoria. Machine learning algorithms for disease diagnosis using medical records: A comparative analysis. In *2023 4th International Conference on Intelligent Engineering and Management (ICIEM)*, pages 1–6. IEEE, 2023.
- Everett Snieder, Karen Abogadil, and Usman T Khan. Resampling and ensemble techniques for improving ann-based high-flow forecast accuracy. *Hydrology and Earth System Sciences*, 25(5):2543–2566, 2021.
- Bartosz Krawczyk. Learning from imbalanced data: open challenges and future directions. *Progress in artificial intelligence*, 5(4):221–232, 2016.
- Robin Cohen. *Global diasporas: An introduction*. Routledge, 2022.
- Haibo He and Eduardo A Garcia. Learning from imbalanced data. *IEEE Transactions on knowledge and data engineering*, 21(9):1263–1284, 2009.
- Rita P. Ribeiro and Nuno Moniz. Imbalanced regression and extreme value prediction. *Mach. Learn.*, 109(9-10):1803–1835, 2020. doi: 10.1007/s10994-020-05900-9.
- Ehsan Aminian, Rita P Ribeiro, and João Gama. Chebyshev approaches for imbalanced data streams regression models. *Data Mining and Knowledge Discovery*, 35(6):2389–2466, 2021.
- Michael Steininger, Konstantin Kobs, Pdraig Davidson, Anna Krause, and Andreas Hotho. Density-based weighting for imbalanced regression. *Machine Learning*, 110:2187–2211, 2021.
- Lamyaa Sadouk, Taoufiq Gadi, and El Hassan Essoufi. A novel cost-sensitive algorithm and new evaluation strategies for regression in imbalanced domains. *Expert Systems*, 38(4):e12680, 2021.
- Rita Paula Almeida Ribeiro. *Utility-based Regression*. PhD thesis, Department of Computer Science - Faculty of Sciences University of Porto, 2011.
- Luís Torgo, Rita P Ribeiro, Bernhard Pfahringer, and Paula Branco. Smote for regression. In *Portuguese conference on artificial intelligence*, pages 378–389. Springer, 2013.
- Paula Branco, Luís Torgo, and Rita P. Ribeiro Ribeiro. Smogn: a pre-processing approach for imbalanced regression. In *First international workshop on learning with imbalanced domains: Theory and applications*, pages 36–50. PMLR, 2017.
- Paula Branco, Luis Torgo, and Rita P. Ribeiro. Pre-processing approaches for imbalanced distributions in regression. *Neurocomputing*, 343:76–99, 2019.
- T Ryan Hoens and Nitesh V Chawla. Imbalanced datasets: from sampling to classifiers. *Imbalanced learning: Foundations, algorithms, and applications*, pages 43–59, 2013.
- Gustavo EAPA Batista, Ronaldo C Prati, and Maria Carolina Monard. A study of the behavior of several methods for balancing machine learning training data. *ACM SIGKDD explorations newsletter*, 6(1):20–29, 2004.
- Miroslav Kubat, Stan Matwin, et al. Addressing the curse of imbalanced training sets: one-sided selection. In *Icml*, volume 97, pages 179–186. Nashville, USA, 1997.
- Nitesh V Chawla, Kevin W Bowyer, Lawrence O Hall, and W Philip Kegelmeyer. Smote: synthetic minority over-sampling technique. *Journal of artificial intelligence research*, 16:321–357, 2002. ISSN 1076-9757.
- Luís Camacho, Georgios Douzas, and Fernando Bacao. Geometric smote for regression. *Expert Systems with Applications*, 193:116387, 2022.
- Georgios Douzas and Fernando Bacao. Geometric smote a geometrically enhanced drop-in replacement for smote. *Information sciences*, 501:118–135, 2019.
- Luís Camacho and Fernando Bacao. Wsmoter: a novel approach for imbalanced regression. *Applied Intelligence*, 54(19):8789–8799, 2024.

- Alberto Fernández, Salvador García, Mikel Galar, Ronaldo C Prati, Bartosz Krawczyk, Francisco Herrera, Alberto Fernández, Salvador García, Mikel Galar, Ronaldo C Prati, et al. Cost-sensitive learning. *Learning from imbalanced data sets*, pages 63–78, 2018.
- Yoav Freund and Robert E Schapire. A decision-theoretic generalization of on-line learning and an application to boosting. *Journal of computer and system sciences*, 55(1):119–139, 1997.
- Mikel Galar, Alberto Fernandez, Edurne Barrenechea, Humberto Bustince, and Francisco Herrera. A review on ensembles for the class imbalance problem: bagging, boosting, and hybrid-based approaches. *IEEE Transactions on Systems, Man, and Cybernetics, Part C*, 42(4):463–484, 2012. ISSN 1094-6977.
- Oghenejokpeme I Orhobor, Nastasiya F Grinberg, Larisa N Soldatova, and Ross D King. Imbalanced regression using regressor-classifier ensembles. *Machine Learning*, 112(4):1365–1387, 2023.
- Paula Branco, Luis Torgo, and Rita P. Ribeiro. Rebagg: Resampled bagging for imbalanced regression. In Luís Torgo, Stan Matwin, Nathalie Japkowicz, Bartosz Krawczyk, Nuno Moniz, and Paula Branco, editors, *Proceedings of the Second International Workshop on Learning with Imbalanced Domains: Theory and Applications*, volume 94 of *Proceedings of Machine Learning Research*, pages 67–81. PMLR, 10 Sep 2018. URL <https://proceedings.mlr.press/v94/branco18a.html>.
- Nuno Moniz, Rita Ribeiro, Vitor Cerqueira, and Nitesh Chawla. Smoteboost for regression: Improving the prediction of extreme values. In *2018 IEEE 5th international conference on data science and advanced analytics (DSAA)*, pages 150–159. IEEE, 2018.
- Yang Huang, Duen-Ren Liu, Shin-Jye Lee, Chia-Hao Hsu, and Yang-Guang Liu. A boosting resampling method for regression based on a conditional variational autoencoder. *Information Sciences*, 590:90–105, 2022.
- Paula Branco, Luís Torgo, and Rita P. Ribeiro. A survey of predictive modeling on imbalanced domains. *ACM Comput. Surv.*, 49, 2016.
- Joao Gama and Carlos Pinto. Discretization from data streams: applications to histograms and data mining. In *Proceedings of the 2006 ACM symposium on Applied computing*, pages 662–667, 2006.
- Dheeru Dua and Casey Graff. UCI machine learning repository, 2017. URL <http://archive.ics.uci.edu/ml>.
- Albert Bifet, Geoff Holmes, Richard Kirkby, and Bernhard Pfahringer. MOA: massive online analysis. *J. Mach. Learn. Res.*, 11:1601–1604, 2010. URL <http://portal.acm.org/citation.cfm?id=1859903>.
- H. D. Block. Neurocomputing: Foundations of research. chapter The Perceptron: A Model for Brain Functioning. I, pages 135–150. MIT Press, Cambridge, MA, USA, 1988. ISBN 0-262-01097-6. URL <http://dl.acm.org/citation.cfm?id=65669.104392>.
- Elena Ikonomovska, João Gama, and Saso Dzeroski. Learning model trees from evolving data streams. *Data Min. Knowl. Discov.*, 23(1):128–168, 2011. doi: 10.1007/s10618-010-0201-y. URL <https://doi.org/10.1007/s10618-010-0201-y>.
- João Duarte, João Gama, and Albert Bifet. Adaptive model rules from high-speed data streams. *ACM Trans. Knowl. Discov. Data*, 10(3):30:1–30:22, 2016. doi: 10.1145/2829955.
- João Gama, Raquel Sebastião, and Pedro Pereira Rodrigues. On evaluating stream learning algorithms. *Mach. Learn.*, 90(3):317–346, 2013. doi: 10.1007/s10994-012-5320-9. URL <https://doi.org/10.1007/s10994-012-5320-9>.
- Janez Demšar. Statistical comparisons of classifiers over multiple data sets. *Journal of Machine learning research*, 7 (Jan):1–30, 2006.