

LAYOUTVLM: Differentiable Optimization of 3D Layout via Vision-Language Models

Fan-Yun Sun^{*1}, Weiyu Liu^{*1}, Siyi Gu¹, Dylan Lim¹,
Goutam Bhat², Federico Tombari², Manling Li¹, Nick Haber¹, Jiajun Wu¹

¹Stanford University, ²Google Research

<https://ai.stanford.edu/~sunfanyun/layoutvlm/>

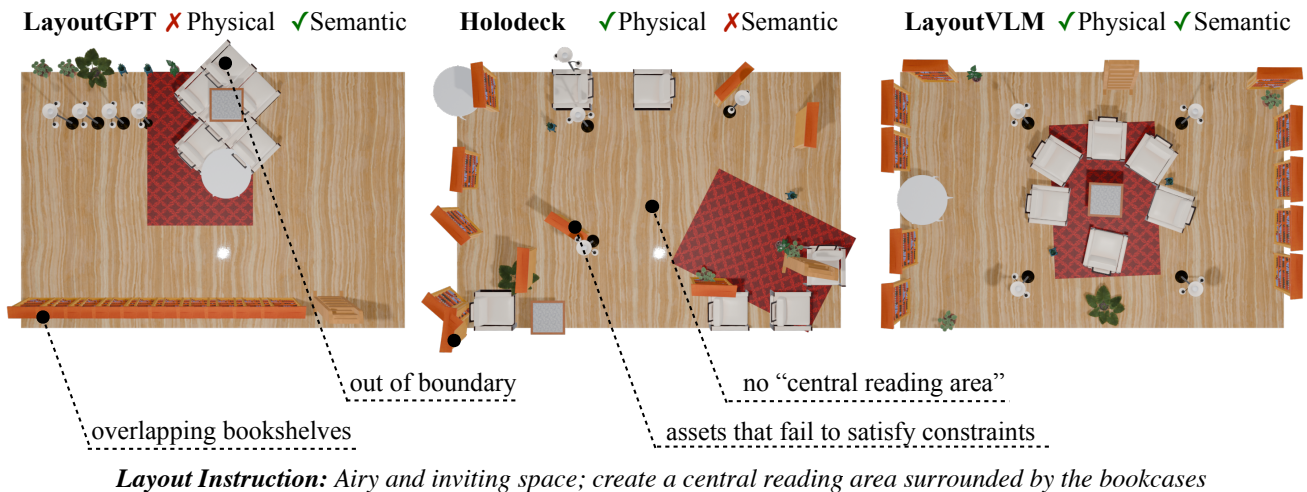

Figure 1. From **unlabeled** 3D assets and language instruction, LAYOUTVLM generates scene layouts that are physically plausible and semantically coherent—two criteria that existing methods often struggle to meet. Our approach addresses this by using a VLM to generate a scene layout representation that defines both an initial layout and spatial relations between assets for differentiable optimization.

Abstract

Spatial reasoning is a fundamental aspect of human cognition, enabling intuitive understanding and manipulation of objects in three-dimensional space. While foundation models demonstrate remarkable performance on some benchmarks, they still struggle with 3D reasoning tasks like arranging objects in space according to open-ended language instructions, particularly in dense and physically constrained environments. We introduce LAYOUTVLM, a framework and scene layout representation that exploits the semantic knowledge of Vision-Language Models (VLMs) and supports differentiable optimization to ensure physical plausibility. LAYOUTVLM employs VLMs to generate two mutually reinforcing representations from visually marked images, and

a self-consistent decoding process to improve VLMs spatial planning. Our experiments show that LAYOUTVLM addresses the limitations of existing LLM and constraint-based approaches, producing physically plausible 3D layouts better aligned with the semantic intent of input language instructions. We also demonstrate that fine-tuning VLMs with the proposed scene layout representation extracted from existing scene datasets can improve their reasoning performance.

1. Introduction

Spatial reasoning and planning involve understanding, arranging, and manipulating objects in 3D space within the constraints of the physical world. These skills are essential for autonomous agents to navigate, plan tasks, and physically interact with objects in complex environments. Auto-

^{*}Equal contribution.

Type	Notation	Explanation
Positional	$\mathcal{L}_{\text{distance}}(p_i, p_j, d_{\min}, d_{\max})$	The distance between the two assets should fall within the range $[d_{\min}, d_{\max}]$.
Positional	$\mathcal{L}_{\text{on_top_of}}(p_i, p_j, b_i, b_j)$	Position one asset on top of another.
Rotational	$\mathcal{L}_{\text{align_with}}(p_i, p_j, \phi)$	Align two assets at a specified angle ϕ .
Rotational	$\mathcal{L}_{\text{point_towards}}(p_i, p_j, \phi)$	Orient one asset to face another with a offset angle ϕ .
Mix	$\mathcal{L}_{\text{against_wall}}(p_i, w_j, b_i)$	Place an asset again wall w_j .

Table 1. **Spatial Relation Definition.** We define five spatial relations that determine how objects are placed relative to each other and within the room. Each constraint is associated with a differentiable cost function based on the object poses, which can be used for optimization. Our spatial relations related to rotation do not require a fixed reference frame and instead are based on relative poses between objects.

matically generating diverse, realistic scenes in simulation has become crucial for scaling up data to train autonomous agents with enhanced spatial reasoning abilities. In this paper, we advance this goal by addressing open-universe layout generation, which involves creating diverse layouts based on unlabeled 3D assets and free-form language instructions.

Traditional scene synthesis and layout generation methods are often constrained by predefined object categories and patterns of object placements learned from synthetic scene datasets [1–3], preventing them from achieving the diversity of scene layouts seen in the real world. Recent methods leverage Large Language Models (LLMs) for open-universe layout generation by utilizing the spatial common-sense embedded in language and program code. However, a key challenge is to achieve both physical plausibility and semantic coherence, as illustrated in Fig. 1. Methods that predict numerical object poses (e.g., LayoutGPT [4]) often produce layouts with object collisions or out-of-bound placements. Other methods, such as Holodeck [5], attempt to improve physical plausibility by predicting spatial relations between assets and solving a constraint optimization problem. However, these approaches either struggle to find feasible solutions for scenes with large numbers of objects or output layouts that lack the semantic nuances specified in the language instructions.

In this paper, we introduce LAYOUTVLM, an open-universe layout generation method that effectively achieves both physical plausibility and semantic alignment. Our approach leverages the complementary nature of numerical object poses and spatial relations, combining them within a differentiable optimization framework to enable robust layout generation. More specifically, LAYOUTVLM first predicts numerical object poses as initialization for the optimization process. Then, LAYOUTVLM jointly optimizes for physics-based objectives and spatial relations, each with their corresponding differentiable objectives. The physics-based objectives ensure physical plausibility, while the spatial relations preserve the overall layout semantics during the optimization process. To improve VLM capabilities for spatial grounding, LAYOUTVLM uses visually marked images, allowing accurate estimation of object placements

within the scene, especially when existing objects exist. We also introduce a self-consistency decoding process that allows LAYOUTVLM to focus on the semantically meaningful spatial relations during optimization. The synergy between numerical values and spatial relations, regulated through self-consistent decoding, ensures accurate and coherent scene layouts.

Our contributions are as follows: first, we introduce a novel scene layout representation that can be combined with differentiable optimization to generate diverse layouts. The scene representation builds on two complementary representations—numerical pose estimates and spatial relations with matching differentiable objectives. Second, we show that we can use VLMs and a self-consistency decoding process to generate our scene layout representation using visually marked scene and asset renderings. Third, through systematic evaluation across 11 room types, we achieved significant improvements when compared to the current best-performing method. Fourth, we show that fine-tuning open-source models on our scene representation with synthetic data yields substantial performance improvements, even for models that struggle with 3D layout generation.

2. Related Work

2.1. Layout Generation & Indoor Scene Synthesis

Recent advances in indoor scene synthesis have explored two main directions. One line of work leverages the strong generative priors of image generation models, often using Neural Radiance Fields (NeRFs) or Gaussian splats as the output representation [6–9]. However, these generated scenes lack separable, manipulable objects and surfaces, rendering them unsuitable for robotics applications where precise object interactions are required. Another line of research focuses on generating scenes using intermediate representations, such as scene graphs or scene layouts, combined with an asset repository [4, 5, 10–12]. The advent of Large Multimodal Models (LMMs) has enabled open-vocabulary 3D scene synthesis, supporting the flexible generation of scenes without dependence on predefined labels or categories [13, 14]. For example, LayoutGPT [4] prompt language models to directly generate 3D Layouts for indoor scenes. Holodeck [5] uses

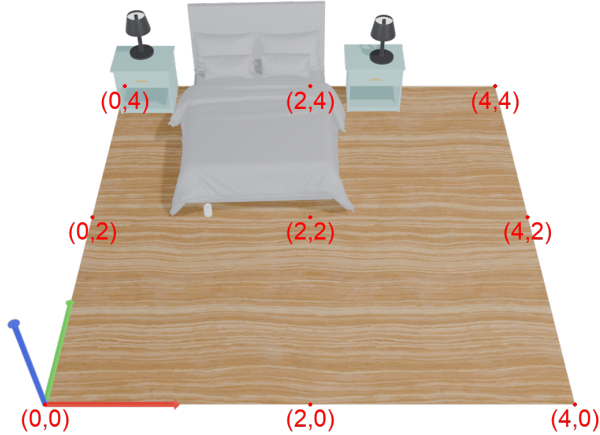

```

1  bed[0].position = [1.5, 3.1, 0.0]
2  bed[0].rotation = [0, 0, -1.57]
3  side_table[0].position = [0.3, 4.1, 0.0]
4  side_table[0].rotation = [0, 0, -1.57]
5  side_table[1].position = [2.7, 4.1, 0.0]
6  side_table[1].rotation = [0, 0, -1.57]
7  table_lamp[0].position = [0.3, 4.1, 0.5]
8  table_lamp[0].rotation = [0, 0, 1.57]
9  table_lamp[1].position = [2.7, 4.1, 0.5]
10 table_lamp[1].rotation = [0, 0, 1.5707]
11
12 for i in range(0, 2):
13     solver.against_wall(side_table[i], walls[2])
14     solver.distance(side_table[i],
15                    |         bed[0],
16                    |         min_distance=1.0,
17                    |         max_distance=3.0)
18 for i in range(0, 2):
19     solver.align_with(side_table[i], bed[0])
20     solver.point_towards(table_lamp[i], bed[0])
21 for i in range(0, 2):
22     solver.on_top_of(table_lamp[i], side_table[i])

```

Figure 2. **Example Scene Representation.** Example of our scene representation for a bedroom. Our scene representation consists of numerical estimates of object poses and spatial relations corresponding to objective functions on these poses. Having the VLMs generate the initial estimates allows us to exploit the semantic knowledge in the large models, and having spatial relations amenable to optimization allows us to generate physically precise placements.

LLMs to generate spatial scene graphs and then uses the specified scene graph to optimize object placements. LAYOUTVLM also falls into this line of work, but instead of using LLMs, we generate scene layout representations from image and text inputs using VLMs. Additionally, we introduce a differential optimization process as opposed to solving a constraint satisfaction problem with search [5].

2.2. Vision-Language Models for 3D Reasoning

Recent works have explored the spatial reasoning capabilities of vision-language models (VLMs). Some studies have trained 3D visual encoders on representations like point clouds and meshes to improve tasks such as 3D scene understanding, question answering, navigation, and planning [15–21]. Other research has adapted 2D VLMs for spatial reasoning by fine-tuning them on visual question-answering datasets involving metric and qualitative spatial relations grounded in 3D environments [22, 23]. A related direction is to reconstruct the 3D scene based on 2D images by training on large synthetic data [24]. However, these approaches primarily focus on perception tasks and do not extend to generating 3D structures. In contrast, our work uses 2D VLMs for the task of 3D layout generation, utilizing techniques originally developed for visual reasoning—such as leveraging images of a scene from different viewing angles [25] and visual markers [26–28]—repurposed here for spatial planning. We also investigate fine-tuning VLMs for 3D layout generation tasks and observe significant improvements in the performance of open-source models.

3. Problem Formulation

The problem of open-universe 3D layout generation is to arrange any assets within a 3D environment based on natural language instructions. Formally, given a layout criterion ℓ_{layout} in natural language, a space defined by four walls oriented along the cardinal directions $\{w_1, \dots, w_4\}$, and a set of N 3D meshes $\{m_1, \dots, m_N\}$, the goal is to create a 3D scene that faithfully represents the provided textual description. Following prior work [5, 14], we assume that the input 3D objects are upright and an off-the-shelf vision-language model (VLM) (i.e., GPT-4o [29]) is employed to determine their front-facing orientations. The VLM also annotates each object with a short textual description s_i , and the dimensions of its axis-aligned bounding box after rotating to face the $+x$ axis will be represented as $b_i \in \mathbb{R}^3$. The target output of layout generation is each object’s pose $p_i = (x_i, y_i, z_i, \theta_i)$, including the object’s 3D position and rotation about the z -axis.

4. LAYOUTVLM

In this paper, we propose LAYOUTVLM, a method to generate physically plausible arrangements of unlabeled 3D assets based on open-vocabulary natural language descriptions of the desired layouts outlined in Figure 3. Our approach employs vision-language models (VLMs) to generate code for our proposed scene layout representation that specifies both an initial layout $\{\hat{p}_i\}_{i=1}^N$, as well as a set of spatial relations between assets (and walls). This representation is then used

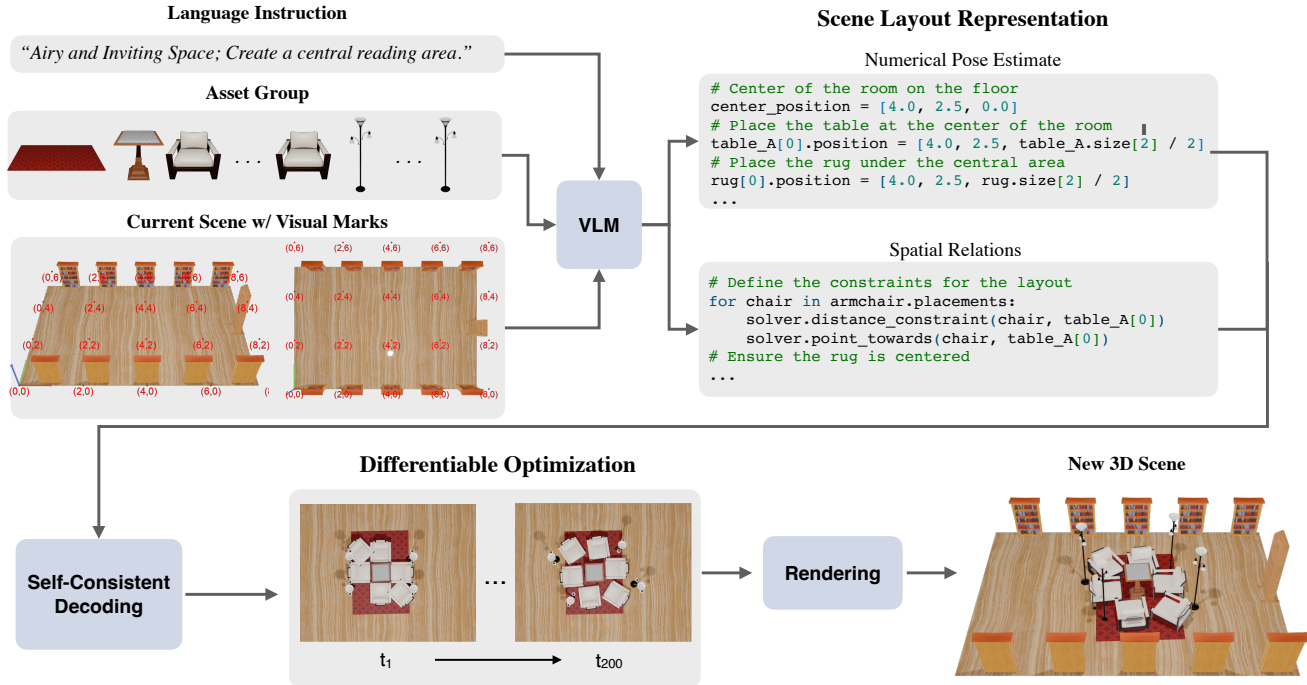

Figure 3. **LAYOUTVLM**. We illustrate the proposed process of generating 3D scene layout with Vision-Language Models.

to produce the final object placements through optimization:

$$\arg \min_{\{p_i\}_{i=1}^N} (\mathcal{L}_{\text{semantic}} + \mathcal{L}_{\text{physics}}),$$

initial solution $\{\hat{p}_i\}_{i=1}^N$.

where $\mathcal{L}_{\text{semantic}}$ is the objective function decoded from the scene layout representation and $\mathcal{L}_{\text{physics}}$ is the objective function we employ to ensure physical plausibility.

In the following sections, we first introduce our scene layout representation, explain how VLMs can reliably generate this representation using visual marks, elaborate on our proposed *self-consistent decoding* process alongside the differentiable optimization process, and discuss finetuning VLMs to improve their understanding of our representation for improved performance.

4.1. Scene Layout Representation

To generate layouts from open-ended language instructions and 3D assets, a desirable representation must be *semantically expressive* for diverse language specifications and *physically precise* to ensure plausible 3D layouts. Our representation includes (a) numerical estimates of object poses $\{\hat{p}_i\}_{i=1}^N$ and (b) spatial relations with differentiable objectives. Initial estimates provide a starting point for optimization, while differentiable objectives guide the process, addressing the challenge of directly predicting physically plausible layouts. The initial layout is key in the optimization process, as poor

initialization can lead to a suboptimal layout (e.g., a table separating the room into two halves where each chair is placed on opposite sides, when the language instruction instructs them to be placed on the same side). The spatial relations are crucial to ensure that the layout semantics are maintained while the layout is adjusted for physical plausibility. In Figure 2, we show an example of our scene representation.

Differentiable Spatial Relations. The goal of these spatial relations is twofold: (a) to capture the semantics of the input language instruction and (b) to preserve these semantics during optimization for physical plausibility. For example, consider the instruction, “set up a dining table.” A vision-language model might initially generate poses where the chairs overlap with the table. Our differentiable spatial relations are designed to adjust these poses during optimization—preventing overlaps—while maintaining the essential semantics, such as “chairs should be positioned near the dining table in a dining setup.” To design a set of spatial relations that can capture a wide range of semantics for indoor scenes, we devise five expressive spatial relations: two positional objectives (i.e., *distance*, *on_top_of*), two orientational objectives (i.e., *align_with*, *point_towards*), and one wall-related objective (i.e., *against_wall*) that pertains to both the position and orientation of an asset. Note that our spatial relations do not rely on a fixed reference frame, unlike classic spatial relations like *in_front_of* and *left_of*. Each spatial relation corresponds to a differentiable objective

function with optional parameters that VLMs can choose to impose on object poses; for example, a *distance* imposes a higher loss if objects are outside a specified distance range, and the VLMs can decide the lower and upper bound for this function. Table 1 presents the notations and meanings of these spatial relations. Formally, we denote a set of spatial relations derived from a scene layout representation as \mathcal{R} .

4.2. Generating Scene Layout Representation with Vision-Language Models

Our approach utilizes the generalization and commonsense reasoning abilities of Vision-Language Models (VLMs) to generate the scene representation outlined above based on the objects, 3D scene, and language instructions. To improve the accuracy of the generated scene representation, we employ two techniques: visual prompting with coordinates and self-consistent decoding.

Visual Prompting. Figure 3 illustrates our VLM-based scene representation generation process. The VLM’s input includes rendered images of the 3D scene and individual asset views. Prior research has shown that visual cues can improve VLMs’ object recognition and spatial reasoning [26]. We provide two types of visual annotations for layout generation: coordinate points in the 3D space spaced 2 meters apart to help the VLM gauge dimensions and scale and visualizations of coordinate frames to maintain consistent spatial references. We also annotate the front-facing orientations of each object with directional arrows, which is essential for generating rotational constraints like *aligned_with* or *point_towards*. In practice, we first use an LLM to group the assets given the textual descriptions s_i of all the input assets to address context length limitations when handling many 3D assets. Then, we place assets in groups, one group at a time. Before generating each group, we re-render the 3D scene to help the VLM identify unoccupied areas, thus facilitating the physically valid placement of remaining assets.

Self-Consistent Decoding. One key challenge is that VLMs struggle with spatial planning; while they may successfully generate spatial relations for pairs of objects, they tend to fail at accounting for overall layout coherence. We hypothesize that self-consistent spatial relations (i.e., "the spatial relations that are also satisfied in the estimated numerical poses of the objects") represent the most critical semantics to preserve during optimization when the object poses are adjusted for better physical plausibility. Thus, we introduce self-consistent decoding for our scene layout representation. Different from standard self-consistency [30], which selects the most consistent answer from multiple reasoning paths following the same format, we require the two distinct but mutually reinforcing representations predicted by the VLM to *self-consistent*. That is, we only retain the spatial relations

satisfied with the predicted poses. After self-consistent decoding, we can formally describe the semantic part of the optimization loss as:

$$\mathcal{L}_{\text{semantic}} = \sum_{\mathcal{L} \in \mathcal{R}} \mathbb{1}[\mathcal{L}_i(\hat{p}_i, \hat{p}_j, \lambda) \leq \epsilon] \cdot \mathcal{L}_i(p_i, p_j, \lambda), \quad (1)$$

where \hat{p}_i and \hat{p}_j are the initial estimated poses, λ represents the additional parameters in the functions (refer to Table 1), and ϵ is a threshold value for determining whether the differentiable spatial relation \mathcal{L} is satisfied in the initial estimates.

4.3. Differentiable Optimization

To generate a scene from the estimated object poses and differentiable constraints, we jointly optimize all objects according to the specified constraints over a set number of iterations. In addition to the spatial relational functions generated by the VLM, we impose Distance-IoU loss on objects’ 3D oriented bounding box [31, 32] for collision avoidance:

$$\mathcal{L}_{\text{physics}} = \sum_{i=1}^N \sum_{\substack{j=1 \\ j \neq i}}^N \mathcal{L}_{\text{DIoU}}(p_i, p_j, b_i, b_j). \quad (2)$$

Eq. 1 and Eq. 2 form the final objective function for the optimization problem. We use projected gradient descent (PGD) to optimize for this objective, projecting assets within the physical boundary every fixed number of iterations during the optimization. With the objective function, we can confine objects within the boundary and avoid unwanted intersections, ensuring physically valid layouts.

4.4. Finetuning VLMs with Scene Datasets

Our scene representation can model a wide variety of physically valid and semantically meaningful 3D layouts. Additionally, we can fine-tune VLMs to quickly adapt to this representation, enabling the generation of specific types of layouts. This scene representation can be automatically extracted from scene layout datasets without requiring manual annotations. Specifically, given a set of posed objects in a 3D scene, we apply the preprocessing procedure outlined in Section 3 to obtain both textual descriptions and oriented bounding boxes for each object. After canonicalizing the objects, we compute cost values for our defined spatial relations based on the ground-truth positions and orientations of the objects, using heuristic thresholds to determine whether each spatial relation is satisfied. The resulting scene representation includes both raw object poses and the satisfied spatial relations, which we then use to fine-tune VLMs to generate these scene representations from input objects and scene renderings. In our implementation, we use the 3D-Front dataset to extract training data for around 9000 rooms. Our approach is capable of identifying layout patterns in 3D scenes, such

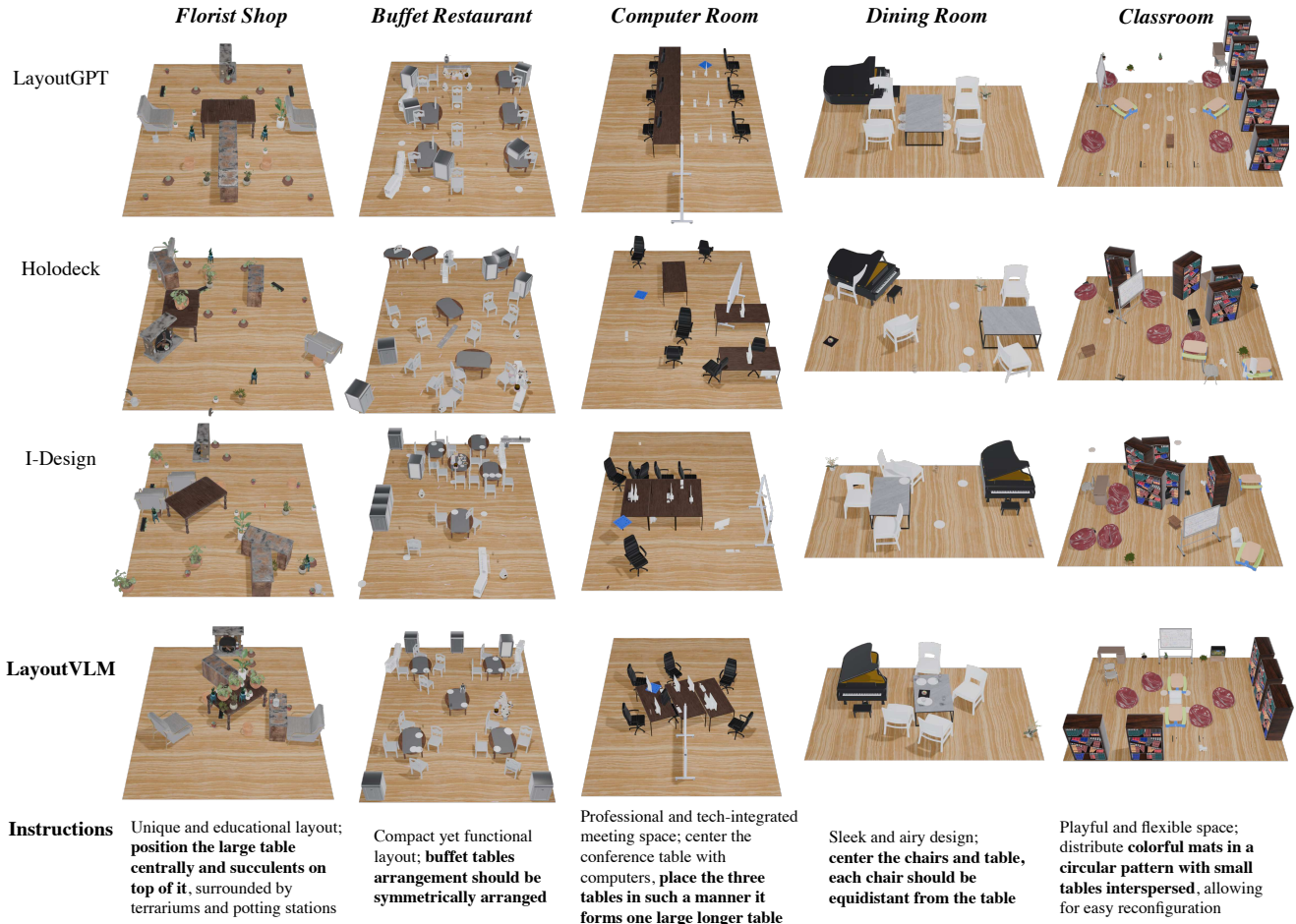

Figure 4. **Qualitative Comparison.** We compare with baseline methods in generating layouts based on detailed language instructions. Our method is able to generate layouts that closely follow the instructions and adhere to physical constraints.

Methods	Bedroom					Living Room					Dining Room					Bookstore					Buffet Restaurant					Children Room				
	CF	IB	Pos.	Rot.	PSA	CF	IB	Pos.	Rot.	PSA	CF	IB	Pos.	Rot.	PSA	CF	IB	Pos.	Rot.	PSA	CF	IB	Pos.	Rot.	PSA	CF	IB	Pos.	Rot.	PSA
LayoutGPT	100.0	66.7	85.7	85.9	52.2	44.4	11.1	74.7	64.4	9.6	88.9	22.2	76.0	68.9	14.8	88.9	55.6	80.9	79.4	35.9	100.0	33.3	81.2	83.3	26.9	100.0	0.0	80.9	82.6	0.0
Holodeck	88.9	22.2	69.3	67.9	14.1	77.8	0.0	66.3	55.6	0.0	88.9	0.0	38.0	36.6	0.0	55.6	0.0	65.7	59.0	0.0	77.8	11.1	47.7	42.4	7.4	77.8	22.2	72.7	70.0	18.7
I-Design	100.0	77.8	72.1	65.4	51.5	33.3	11.1	62.6	46.7	0.0	88.9	66.7	76.4	66.4	34.8	66.7	11.1	68.1	69.4	5.2	100.0	55.6	63.5	57.1	35.2	77.8	55.6	78.1	75.1	34.8
LAYOUTVLM	88.9	100.0	82.3	74.9	68.8	22.2	77.8	68.6	54.4	9.6	88.9	100.0	63.4	56.9	51.1	55.6	100.0	82.0	82.8	49.8	88.9	88.9	74.3	64.8	51.5	100.0	100.0	81.9	88.2	88.5

Methods	Classroom					Computer Room					Deli					Florist Shop					Game Room					Average				
	CF	IB	Pos.	Rot.	PSA	CF	IB	Pos.	Rot.	PSA	CF	IB	Pos.	Rot.	PSA	CF	IB	Pos.	Rot.	PSA	CF	IB	Pos.	Rot.	PSA	CF	IB	Pos.	Rot.	PSA
LayoutGPT	88.9	0.0	76.3	66.7	0.0	100.0	22.2	87.8	85.2	17.8	88.9	0.0	77.2	77.9	0.0	66.7	33.3	81.6	80.2	18.3	55.6	22.2	87.0	82.9	6.7	83.8	24.2	80.8	78.0	16.6
Holodeck	33.3	0.0	45.2	38.6	0.0	100.0	0.0	66.1	59.7	0.0	88.9	33.3	73.9	63.7	24.4	63.9	0.0	73.2	64.7	0.0	55.6	22.2	60.7	58.0	0.0	77.8	8.1	62.8	55.6	5.6
I-Design	55.6	11.1	50.7	47.0	0.0	88.9	22.2	74.0	70.7	8.9	88.9	22.2	67.8	65.9	10.4	77.8	0.0	75.5	68.3	0.0	66.7	44.4	62.8	58.9	17.0	76.8	34.3	68.3	62.8	18.0
LAYOUTVLM	77.8	100.0	74.6	68.6	48.3	100.0	88.9	85.4	84.5	77.0	100.0	88.9	83.4	83.4	74.6	88.9	100.0	83.4	76.4	68.3	88.9	100.0	73.1	70.0	59.5	81.8	94.9	77.5	73.2	58.8

Table 2. **Benchmark Performance.** LAYOUTVLM outperformed existing open-universe layout generation methods across 11 room types.

as a variable number of chairs around a table, nightstands positioned beside a bed, or an entertainment area comprising a TV, coffee table, and sofa. We investigate fine-tuning two VLMs for the layout generation task: the closed-source *GPT-4o* [29] and the open-source *LLaVA-NeXT-Interleave* [33].

5. Experiments

In our experiments, we aim to answer the following three questions: **Q1:** Does LAYOUTVLM outperform existing methods on open-universe 3D layout generation? **Q2:** Are the proposed scene layout representation and VLM-based framework essential for generating prompt-aligned 3D layouts that are physically plausible? **Q3:** With limited data, can we improve upon pre-trained VLMs’ ability to generate

A fancy buffet restaurant with few tables and chairs

Layout Instructions:

Tables are symmetrically placed in the room; each table should have two chairs on opposite sides of the table facing each other, ready for dining ...



All the tables aligned to form a line, dividing the room up into two halves, place all the chairs on one side of the line and the buffets on the other side

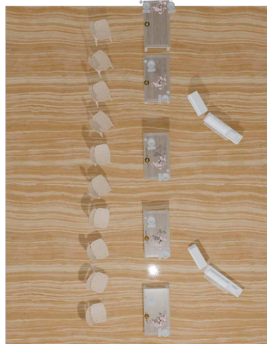

One table is placed in the middle of the room with all the plates and bowls placed on top of it; other tables are placed towards the corners with chairs on top of them.



Stack the tables vertically in the middle of the room. Arrange the utensils in a smaller circle around the tables, then position the chairs in a larger circle surrounding the utensils.

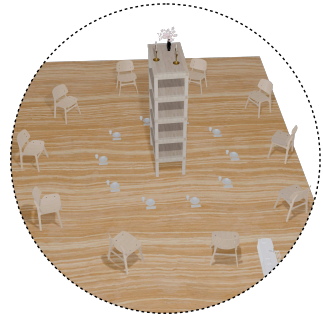
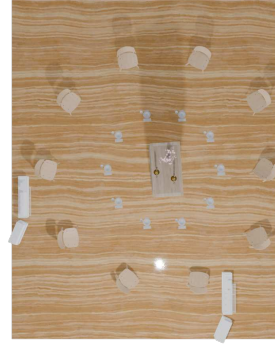

Figure 5. **Examples of Following Detailed Instructions.** We show the same set of assets arranged with different language instructions. The latter two examples show that LAYOUTVLM can closely follow the prompts even when the desired layouts are unconventional.

the proposed scene layout representation?

5.1. Experimental Setup

Evaluation. In our evaluation, we assess models’ abilities in 1) open-vocabulary language instructions, 2) predicting layouts for objects beyond predefined categories, and 3) generating accurate object placements within boundaries while avoiding collisions. We create test cases across 11 room types, with three rooms per type and up to 80 assets per room. Each test case includes human-verified, pre-processed 3D assets sourced from Objaverse [34], language instructions generated by GPT-4, and a floor plan defining space dimensions. All methods use the same pre-processed assets. Details on test case generation are in the appendix.

Evaluation Metrics. We evaluate generated 3D layouts on physical plausibility and semantic coherence with respect to the provided language instructions. Physical plausibil-

ity is measured using the *Collision-Free Score (CF)* and *In-Boundary Score (IB)*. All assets are enforced to be placed, with remaining assets randomly placed if a method fails. Semantic coherence is assessed using *Positional Coherency (Pos.)* and *Rotational Coherency (Rot.)*, measuring alignment with the input prompt. To evaluate semantic coherence across layouts without groundtruth, we use *GPT-4o* to score layouts based on top-down and side-view renderings and the language instructions, leveraging its effectiveness as a human-aligned evaluator in text-to-3D generation [35]. We also introduce the *Physically-Grounded Semantic Alignment Score (PSA)* to assess physical plausibility and semantic alignment, assigning 0 if assets cannot be feasibly placed. PSA is calculated simply the GPT-4o rating weighted by physical plausibility. Scores range from 0 to 100, with higher scores indicating better performance.

Baselines. We evaluate our method against the following baselines: LayoutGPT [4], Holodeck [5], and I-Design [13],

	User			GPT-4o		
	Position	Rotation	PSA	Position	Rotation	PSA
LayoutGPT	1.91	1.86	2.77	2.00	1.82	2.83
Holodeck	3.44	3.50	3.10	3.20	3.43	3.10
I-Design	2.86	2.91	2.64	2.89	2.86	2.62
LAYOUTVLM	1.79	1.73	1.50	1.91	1.89	1.45

Table 3. Average ranks based on user ratings and GPT4-o scores.

	Position	Rotation	PSA
Within Users	0.51	0.57	0.50
Users With GP4-o	0.49	0.61	0.46

Table 4. User-User and User-GPT4o Alignment/Agreement

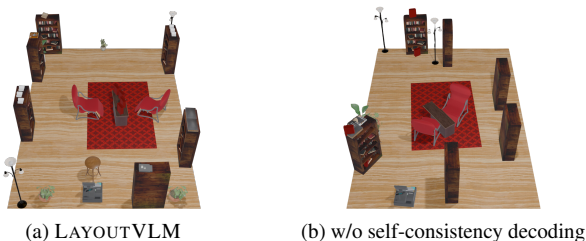

Figure 6. Comparison when w/ and w/o self-consistency decoding.

representing existing methods for open-universe layout generation.

5.2. Benchmark Performance

Our method achieves significantly improved performance over existing methods, as shown in Table 2. Averaging over 11 room types, it improves the PSA score by 40.8 compared to the best-performing baseline, I-Design. LayoutGPT generates layouts with high semantic coherence by having LLMs predict precise object placements but often produces physically infeasible layouts. Holodeck struggles to generate valid and accurate scenes due to its search-based approach, which becomes ineffective with the large number of assets and rigid constraints that fail to accommodate diverse language instructions. Notably, our approach significantly reduces objects placed outside room boundaries while maintaining high positional and rotational coherence.

In Figure 4, we present qualitative examples of layouts generated by each method. Our method finds valid placements for large numbers of assets. For example, in the florist shop, it places over 10 plants on the central table as instructed. In the buffet restaurant, only our method separates tables, places chairs around each table, and arranges plates on top. Examining the baselines, LayoutGPT produces meaningful placements but often results in object collisions (e.g., a piano colliding with a chair in the dining room) and objects placed outside the room boundary (e.g., bookshelves in the classroom). Holodeck struggles to find reasonable placements for large asset counts. The numerical difference in PSA scores between our method and the best-performing

	Physics		Semantics		Overall Score
	CF	IB	Pos.	Rot.	PSA
LAYOUTVLM	81.8 ± 2.5	94.9 ± 2.2	77.5 ± 0.9	73.1 ± 1.1	58.8 ± 3.4
<i>Ablating the key components in LayoutVLM</i>					
w/o Visual Image	67.2 ± 1.1	94.9 ± 0.8	79.1 ± 1.3	74.0 ± 1.2	48.2 ± 1.5
w/o Self-Consistency	71.2 ± 2.5	92.9 ± 2.2	75.5 ± 1.1	72.1 ± 0.7	46.4 ± 2.4
w/o Const.	75.8 ± 2.5	14.1 ± 3.0	70.4 ± 1.3	67.3 ± 0.9	6.7 ± 1.6
<i>Ablating the two types of visual marks</i>					
w/o Visual Asset Mark	79.8 ± 0.6	87.9 ± 3.9	77.7 ± 0.6	72.2 ± 0.8	52.2 ± 5.0
w/o Visual Coordinate	77.2 ± 2.0	88.9 ± 1.7	74.3 ± 1.0	68.9 ± 1.3	46.0 ± 2.7
w/o Any Visual Mark	74.2 ± 6.4	84.9 ± 3.1	74.5 ± 0.8	69.2 ± 0.3	43.0 ± 2.2
<i>Ablating the proposed scene layout representation</i>					
w/o Numerical Init.	74.7 ± 4.0	86.6 ± 2.6	69.5 ± 0.1	65.4 ± 1.4	41.0 ± 1.7
w/o (Spatial) Const.	75.8 ± 2.5	14.1 ± 3.0	70.4 ± 1.3	67.3 ± 0.9	6.7 ± 1.6

Table 5. **Ablation.** Removing visual input impedes spatial planning, while omitting self-consistency and optimization negatively impacts both physical feasibility and layout coherence. We also ablate the importance of both types of visual marks and the two key components in our proposed scene layout representation.

baseline, I-Design, is evident in the qualitative examples.

We further illustrate our model’s ability to generate different layouts in response to user instructions, as shown in Figure 5. Our approach demonstrates the ability to closely follow detailed language instructions to generate different layouts even for the same set of assets. The examples show that our method can meet specific user requirements, such as placing chairs on opposite sides or aligning tables in a row. Additionally, our method can generate less conventional layouts, such as placing chairs on top of tables or stacking tables, showcasing its flexibility in interpreting and executing unique instructions.

5.3. Human Eval to validate our metrics

We follow our baseline I-Design, evaluating layouts using physical plausibility metrics and GPT-4o-rated scores. To further evaluate the alignment between GPT-4o ratings and human ratings, we conducted a user study. Following prior work [35], we recruited five graduate students to rank the methods based on position, orientation, and overall performance. They were given the same instructions used as prompts for the GPT-4o evaluator. We collected 495 ratings for each method and metric pair. We converted GPT-4o scores to rankings and computed Kendall’s Tau [?] in Table 4, showing **strong user-user agreement and user-GPT agreement**. Table 3 reports the average rankings based on user and GPT-4o ratings, demonstrating **strong correlation with the results in our proposed metrics**.

5.4. Ablation Study

We conduct an ablation study to assess the key components of our approach. In w/o Visual, the VLM was replaced with an LLM. The ablation w/o Self-Consistency removes the step of validating predicted constraints with raw poses, while w/o Const. placed objects based solely on predicted

	Physics		Semantics		Overall
	CF	IB.	Pos.	Rot.	PSA
GPT-4o	66.7 ± 5.2	92.6 ± 3.0	71.4 ± 3.1	62.1 ± 2.4	43.2 ± 7.0
GPT-4o (FT on numerical)	77.8 ± 5.2	29.6 ± 3.0	73.8 ± 4.2	68.5 ± 1.9	11.9 ± 0.9
GPT-4o (FT on ours)	77.8 ± 3.0	96.3 ± 1.7	68.2 ± 0.9	62.5 ± 0.8	48.1 ± 1.8
LLaVA (random)	66.7 ± 0.0	3.7 ± 3.0	55.6 ± 1.7	47.5 ± 3.0	0.7 ± 0.6
LLaVA (FT on numerical)	77.8 ± 5.2	18.5 ± 3.0	68.4 ± 0.8	66.0 ± 1.3	6.8 ± 2.2
LLaVA (FT on ours)	85.2 ± 6.0	70.4 ± 8.0	73.8 ± 1.0	66.4 ± 0.5	39.5 ± 5.7

Table 6. **Comparison of Fine-Tuning VLMs on Different Layout Representations.** FT denotes fine-tuning. Fine-tuning with our representation yields better results than using numerical poses, with significant improvements in the open-source model’s performance.

poses, without performing optimization. As shown in Table 5, the results confirm the effectiveness of our method’s design. Although w/o Visual still uses the same optimization process, which improves physical feasibility, we observe a clear advantage in using a VLM. This likely stems from the VLM’s ability to leverage rendered scenes and asset views to enhance spatial planning (e.g., arranging groups of objects in distinct regions). The comparison with w/o Const. confirms that VLMs alone were insufficient; our scene representation—consisting of both numerical object poses and spatial relations—is essential for generating practical layouts. Finally, we observe that self-consistency takes advantage of our scene representation to help ensure that placements met both physical and semantic requirements. We also analyze the effects of two key components in our proposed scene layout representation. The results indicate that **spatial constraints are crucial for ensuring physical validity**, particularly in preventing object overlap, while a good numerical initialization contributes to better semantic scores.

5.5. Finetuning LayoutVLM

In this experiment, we investigate whether fine-tuning pre-trained VLMs with our scene layout representation improves physical feasibility and semantic coherence. Specifically, we compare this approach with fine-tuning VLMs to directly predict numerical poses. Since the 3D-Front training data consist of typical household room types, we evaluated the fine-tuned models on test cases within the residential category (i.e., bedroom, living room, and dining room). As these test cases include unseen 3D assets from Objaverse and even new object categories, this experiment also assessed generalization capability. We extract the ground-truth layouts from 3D scenes by selecting defined spatial relations higher than predetermined thresholds. The language instructions are generated based on the type of rooms annotated in the 3D scene dataset. We finetune the open-sourced LLaVA-NeXT-Interleave [33] model via LoRA and GPT4-o via the publicly available finetuning API.

The results in Table 6 show that: 1) fine-tuning with our scene representation is more effective than using direct nu-

merical values, and 2) our approach significantly improves the performance of the open-source model. The relatively limited improvement in the closed-source model likely stems from its existing ability to leverage our scene representation through prompt instructions, as shown in previous experiments. In contrast, the open-source VLM struggles with zero-shot layout generation. Fine-tuning with our scene representation enables it to generate better layouts for residential room types with unseen objects.

6. Conclusion

In this paper, we present LAYOUTVLM, a comprehensive framework for open-universe 3D layout generation, including a novel scene layout representation that builds on two representations of layout from visually marked images: numerical pose estimates and spatial relations. With the scene layout representation combined with self-consistent decoding, differentiable optimization, and visual prompting, we demonstrated significant improvements over existing LLM and constraint-based approaches. While LAYOUTVLM shows promise, it has limitations, including occasional failures in generating valid layouts due to suboptimal VLM initializations. We hope our work paves the way for future research to explore more complex scenes and address these challenges, pushing the boundaries of 3D layout generation with improved semantic and physical reasoning.

Acknowledgments. This work is in part supported by Google, Analog Devices, the Stanford Center for Integrated Facility Engineering (CIFE), the Stanford Institute for Human-Centered AI (HAI), NSF CCR1 #2120095, AFOSR YIP FA9550-23-1-0127, ONR N00014-23-1-2355, and ONR YIP N00014-24-1-2117.

References

- [1] QiuHong Anna Wei, Sijie Ding, Jeong Joon Park, Rahul Sajnani, Adrien Poulenard, Srinath Sridhar, and Leonidas Guibas. Lego-net: Learning regular rearrangements of objects in rooms. In *Proceedings of the IEEE/CVF Conference on Computer Vision and Pattern Recognition*, pages 19037–19047, 2023. 2
- [2] Nelson Nauata, Sepidehsadat Hosseini, Kai-Hung Chang, Hang Chu, Chin-Yi Cheng, and Yasutaka Furukawa. Housegan++: Generative adversarial layout refinement network towards intelligent computational agent for professional architects. In *Proceedings of the IEEE/CVF Conference on Computer Vision and Pattern Recognition*, pages 13632–13641, 2021.
- [3] Despoina Paschalidou, Amlan Kar, Maria Shugrina, Karsten Kreis, Andreas Geiger, and Sanja Fidler. Atiss: Autoregressive transformers for indoor scene synthesis. *Advances in Neural Information Processing Systems*, 34:12013–12026, 2021. 2
- [4] Weixi Feng, Wanrong Zhu, Tsu-jui Fu, Varun Jampani, Arjun Akula, Xuehai He, Sugato Basu, Xin Eric Wang, and William Yang Wang. Layoutgpt: Compositional visual planning and generation with large language models. *Advances in Neural Information Processing Systems*, 36, 2024. 2, 7
- [5] Yue Yang, Fan-Yun Sun, Luca Weihs, Eli VanderBilt, Alvaro Herrasti, Winson Han, Jiajun Wu, Nick Haber, Ranjay Krishna, Lingjie Liu, et al. Holodeck: Language guided generation of 3d embodied ai environments. In *Proceedings of the IEEE/CVF Conference on Computer Vision and Pattern Recognition*, pages 16227–16237, 2024. 2, 3, 7, 4
- [6] Jonas Schult, Sam Tsai, Lukas Höllein, Bichen Wu, Jialiang Wang, Chih-Yao Ma, Kunpeng Li, Xiaofang Wang, Felix Wimbauer, Zijian He, et al. Controlroom3d: Room generation using semantic proxy rooms. In *Proceedings of the IEEE/CVF Conference on Computer Vision and Pattern Recognition*, pages 6201–6210, 2024. 2
- [7] Xiaoyu Zhou, Xingjian Ran, Yajiao Xiong, Jinlin He, Zhiwei Lin, Yongtao Wang, Deqing Sun, and Ming-Hsuan Yang. Gala3d: Towards text-to-3d complex scene generation via layout-guided generative gaussian splatting. *arXiv preprint arXiv:2402.07207*, 2024.
- [8] Ryan Po and Gordon Wetzstein. Compositional 3d scene generation using locally conditioned diffusion. In *2024 International Conference on 3D Vision (3DV)*, pages 651–663. IEEE, 2024.
- [9] Dave Epstein, Ben Poole, Ben Mildenhall, Alexei A Efros, and Aleksander Holynski. Disentangled 3d scene generation with layout learning. *arXiv preprint arXiv:2402.16936*, 2024. 2
- [10] Ohad Rahamim, Hilit Segev, Idan Achituve, Yuval Atzmon, Yoni Kasten, and Gal Chechik. Lay-a-scene: Personalized 3d object arrangement using text-to-image priors. *arXiv preprint arXiv:2406.00687*, 2024. 2
- [11] Rao Fu, Zehao Wen, Zichen Liu, and Srinath Sridhar. Anyhome: Open-vocabulary generation of structured and textured 3d homes. In *European Conference on Computer Vision*, pages 52–70. Springer, 2025.
- [12] Chenguo Lin and Yadong Mu. Instructscene: Instruction-driven 3d indoor scene synthesis with semantic graph prior. *arXiv preprint arXiv:2402.04717*, 2024. 2
- [13] Ata Çelen, Guo Han, Konrad Schindler, Luc Van Gool, Iro Armeni, Anton Obukhov, and Xi Wang. I-design: Personalized llm interior designer. *arXiv preprint arXiv:2404.02838*, 2024. 2, 7
- [14] Rio Aguina-Kang, Maxim Gumin, Do Heon Han, Stewart Morris, Seung Jean Yoo, Aditya Ganeshan, R Kenny Jones, QiuHong Anna Wei, Kailiang Fu, and Daniel Ritchie. Open-universe indoor scene generation using llm program synthesis and uncurated object databases. *arXiv preprint arXiv:2403.09675*, 2024. 2, 3
- [15] Yining Hong, Haoyu Zhen, Peihao Chen, Shuhong Zheng, Yilun Du, Zhenfang Chen, and Chuang Gan. 3d-llm: Injecting the 3d world into large language models. *Advances in Neural Information Processing Systems*, 36:20482–20494, 2023. 3
- [16] Jianing Yang, Xuweiyi Chen, Nikhil Madaan, Madhavan Iyengar, Shengyi Qian, David F Fouhey, and Joyce Chai. 3d-grand: A million-scale dataset for 3d-llms with better grounding and less hallucination. *arXiv preprint arXiv:2406.05132*, 2024.
- [17] Rao Fu, Jingyu Liu, Xilun Chen, Yixin Nie, and Wenhao Xiong. Scene-llm: Extending language model for 3d visual understanding and reasoning. *arXiv preprint arXiv:2403.11401*, 2024.
- [18] Sijin Chen, Xin Chen, Chi Zhang, Mingsheng Li, Gang Yu, Hao Fei, Hongyuan Zhu, Jiayuan Fan, and Tao Chen. Ll3da: Visual interactive instruction tuning for omni-3d understanding reasoning and planning. In *CVPR*, 2024.
- [19] Zhangyang Qi, Ye Fang, Zeyi Sun, Xiaoyang Wu, Tong Wu, Jiaqi Wang, Dahua Lin, and Hengshuang Zhao. Gpt4point: A unified framework for point-language understanding and generation. In *CVPR*, 2024.
- [20] Runsen Xu, Xiaolong Wang, Tai Wang, Yilun Chen, Jiangmiao Pang, and Dahua Lin. Pointllm: Empowering large language models to understand point clouds. In *ECCV*, 2024.
- [21] Haifeng Huang, Yilun Chen, Zehan Wang, Rongjie Huang, Runsen Xu, Tai Wang, Luping Liu, Xize Cheng, Yang Zhao, Jiangmiao Pang, et al. Chat-scene: Bridging 3d scene and large language models with object identifiers. *NeurIPS*, 2024. 3
- [22] Boyuan Chen, Zhuo Xu, Sean Kirmani, Brain Ichter, Dorsa Sadigh, Leonidas Guibas, and Fei Xia. Spatialvlm: Endowing vision-language models with spatial reasoning capabilities. In *Proceedings of the IEEE/CVF Conference on Computer Vision and Pattern Recognition*, pages 14455–14465, 2024. 3
- [23] An-Chieh Cheng, Hongxu Yin, Yang Fu, Qiushan Guo, Ruihan Yang, Jan Kautz, Xiaolong Wang, and Sifei Liu. Spatial-rppt: Grounded spatial reasoning in vision language model. *arXiv preprint arXiv:2406.01584*, 2024. 3
- [24] Armen Avetisyan, Christopher Xie, Henry Howard-Jenkins, Tsun-Yi Yang, Samir Aroudj, Suvam Patra, Fuyang Zhang, Duncan Frost, Luke Holland, Campbell Orme, et al. Scene-script: Reconstructing scenes with an autoregressive structured language model. *arXiv preprint arXiv:2403.13064*, 2024. 3
- [25] Sha Zhang, Di Huang, Jiajun Deng, Shixiang Tang, Wanli Ouyang, Tong He, and Yanyong Zhang. Agent3d-zero:

- An agent for zero-shot 3d understanding. *arXiv preprint arXiv:2403.11835*, 2024. 3
- [26] Jianwei Yang, Hao Zhang, Feng Li, Xueyan Zou, Chunyuan Li, and Jianfeng Gao. Set-of-mark prompting unleashes extraordinary visual grounding in gpt-4v. *arXiv preprint arXiv:2310.11441*, 2023. 3, 5
- [27] Mu Cai, Haotian Liu, Siva Karthik Mustikovela, Gregory P Meyer, Yuning Chai, Dennis Park, and Yong Jae Lee. Making large multimodal models understand arbitrary visual prompts. In *CVPR*, 2024.
- [28] Xuanyu Lei, Zonghan Yang, Xinrui Chen, Peng Li, and Yang Liu. Scaffolding coordinates to promote vision-language coordination in large multi-modal models. *arXiv preprint arXiv:2402.12058*, 2024. 3
- [29] Josh Achiam, Steven Adler, Sandhini Agarwal, Lama Ahmad, Ilge Akkaya, Florencia Leoni Aleman, Diogo Almeida, Janko Altenschmidt, Sam Altman, Shyamal Anadkat, et al. GPT-4 technical report. *arXiv preprint arXiv:2303.08774*, 2023. 3, 6
- [30] Xuezhi Wang, Jason Wei, Dale Schuurmans, Quoc Le, Ed Chi, Sharan Narang, Aakanksha Chowdhery, and Denny Zhou. Self-consistency improves chain of thought reasoning in language models. In *ICLR*, 2023. 5
- [31] Zhaohui Zheng, Ping Wang, Wei Liu, Jinze Li, Rongguang Ye, and Dongwei Ren. Distance-iou loss: Faster and better learning for bounding box regression. In *Proceedings of the AAAI conference on artificial intelligence*, 2020. 5
- [32] Dingfu Zhou, Jin Fang, Xibin Song, Chenye Guan, Junbo Yin, Yuchao Dai, and Ruigang Yang. Iou loss for 2d/3d object detection. In *2019 international conference on 3D vision (3DV)*, pages 85–94. IEEE, 2019. 5
- [33] Feng Li, Renrui Zhang, Hao Zhang, Yuanhan Zhang, Bo Li, Wei Li, Zejun Ma, and Chunyuan Li. Llava-next-interleave: Tackling multi-image, video, and 3d in large multimodal models. *arXiv:2407.07895*, 2024. 6, 9
- [34] Matt Deitke, Dustin Schwenk, Jordi Salvador, Luca Weihs, Oscar Michel, Eli VanderBilt, Ludwig Schmidt, Kiana Ehsani, Aniruddha Kembhavi, and Ali Farhadi. Objaverse: A universe of annotated 3d objects. In *Proceedings of the IEEE/CVF Conference on Computer Vision and Pattern Recognition*, pages 13142–13153, 2023. 7
- [35] Tong Wu, Guandao Yang, Zhibing Li, Kai Zhang, Ziwei Liu, Leonidas Guibas, Dahua Lin, and Gordon Wetzstein. Gpt-4v (ision) is a human-aligned evaluator for text-to-3d generation. In *Proceedings of the IEEE/CVF Conference on Computer Vision and Pattern Recognition*, pages 22227–22238, 2024. 7, 8
- [36] Alec Radford, Jong Wook Kim, Chris Hallacy, Aditya Ramesh, Gabriel Goh, Sandhini Agarwal, Girish Sastry, Amanda Askell, Pamela Mishkin, Jack Clark, et al. Learning transferable visual models from natural language supervision. In *International conference on machine learning*, pages 8748–8763. PMLR, 2021. 5

LAYOUTVLM: Differentiable Optimization of 3D Layout via Vision-Language Models

Supplementary Material

A. Details of LAYOUTVLM

This section elaborates on the details of our method, including the prompts we used.

A.1. Grouping

To address the challenge of handling large numbers of 3D assets, we cluster related assets into groups using the following prompt:

```
You are an experienced 3D layout designer. You are teaching a junior designer the concept of semantic asset group. Understanding and recognizing semantic asset groups will help the designers to design a room layout more efficiently by decomposing the room layout into smaller, more manageable parts.
```

```
**Definition:**
```

```
A semantic asset group is a collection of assets that are logically related to each other. The grouping of the assets are based on functional, semantic, geometric, and functional relationships between assets.
```

```
Usually assets that are close to each other in space can be grouped together. For example, a bed, a nightstand, and a lamp on top of the nightstand can be grouped together.
```

```
However, it is also possible to group assets that are not physically close to each other but are semantically related. For example, a sofa, a tv console in front of the sofa, and a tv on top of the tv console can be grouped together even though the tv and the tv console is a few meters away from the sofa. They can be grouped together because they are semantically related -- the tv is in front of the sofa.
```

```
**Task:**
```

```
Now, given a 3D scene, you will use it as an example to teach the junior designer how to group assets into semantic asset groups.
```

```
**Step-by-Step Guide:**
```

1. You will first be provided a **list** of assets. Based on the assets, you should describe the general layout of the scene, the types of assets present, **and any** notable features.
2. You will identify the semantic relationships between the assets. You should consider the functional, semantic, **and** geometric relationships between the assets.
3. You will then describe how you would group the assets into semantic asset groups. You should explain the rationale behind each group **and** how the assets within each group are related to each other.
4. You will then order the semantic asset groups based on the sequence **in** which they should be placed **in** the scene. You should consider the significance of each group **and** the logical flow of the scene layout. For example, larger **or** more prominent assets may be placed first to establish the scenes focal points.
5. Finally, you will **format** the grouping

```
information into a clear and organized structure that can be easily understood by other designers or stakeholders.
```

```
**Example:**
```

```
Suppose you are examining a bedroom scene. In the bedroom, there are the following assets:
```

```
bed | ...  
nightstand | ...  
lamp | ...  
bed_bench | ...  
dresser-0 | ...  
dresser-1 | ...  
photo_frame-0 | ...  
dressing_table-0 | ...  
chair-0 | ...
```

1. After examining the scene, you will describe the scene a bedroom with a bed **and** a seating area **for** dressing.
2. You will **list** the assets **and** their relationships:
 - the bed **is** the central piece
 - the nightstand **is next** to the bed **for** placing items. The bedside table should be close to the bed **for** easy **access**.
 - the lamp **is** on the nightstand **for** lighting. The lamp should be close to the bed **for** reading.
 - the end of bed bench **is** at the foot of the bed. The bench **is** at the end of the bed **for** seating **or** placing items.
 - the dresser **is** on the other side of the room. The dresser **is** on the opposite side of the bed **for** storage.
 - the photo frame **is** on the dresser. The photo **is** directly opposite the bed **for** viewing.
 - the dressing table **is in** an **open** area of the room
 - the chair **is in** front of the dressing table **for** seating.
3. You will group the assets into semantic asset groups:
 - Group 1: Bed, Nightstand, Lamp. The rationale **is** that the bed **is** the central piece, the nightstand **is next** to the bed, **and** the lamp **is** on the nightstand. They are related to each other because they are used **for** sleeping **and** reading.
 - Group 2: End of bed bench. The bench **is** at the foot of the bed **for** seating **or** placing items.
 - Group 3: Dresser, Photo frame. The dresser **is** on the opposite side of the bed **for** storage, **and** the photo frame **is** directly opposite the bed **for** viewing.
 - Group 4: Dressing table, Chair. The dressing table **is in** an **open** area of the room, **and** the chair **is in** front of the dressing table **for** seating.
4. You will order the semantic asset groups based on the sequence **in** which they should be placed **in** the scene:
 - Group 1: Bed, Nightstand, Lamp. They should be placed first to establish the sleeping area. They are the focal point of the room.
 - Group 2: End of bed bench. It should be placed **next** to the bed to complement the sleeping area.
 - Group 3: Dresser, Photo frame. They should be placed on the opposite side of the room to

balance the layout.
 - Group 4: Dressing table, Chair. They should be placed **in an open** area of the room to create a dressing area.

5. You will **format** the grouping information into a clear **and** organized structure:

```
```json
{
 "list": [
 {
 "id": 1,
 "name": "sleeping area",
 "assets": ["bed", "nightstand", "lamp"],
 "rational": "they are used for sleeping and reading.",
 "key_relations_between_assets": ["the bed is the central piece", "the nightstand is next to the bed", "the lamp is on the nightstand"],
 "key_relations_with_other_groups": []
 },
 {
 "id": 2,
 "name": "seating area",
 "assets": ["bed_bench"],
 "rational": "this end of bed bench is at the foot of the bed for seating or placing items.",
 "key_relations_between_assets": [],
 "key_relations_with_other_groups": ["the bench complements the sleeping area."]
 },
 {
 "id": 3,
 "name": "storage area",
 "assets": ["dresser-0", "dresser-1", "photo_frame-0"],
 "rational": "the dresser is on the opposite side of the bed for storage, and the photo frame is directly opposite the bed for viewing.",
 "key_relations_between_assets": ["the photo frame is on top of the dresser"],
 "key_relations_with_other_groups": ["the dresser is for storage, and the photo frame is for viewing. To make the photo frame visible from the bed, the dresser should be placed on the opposite side of the bed."]
 },
 {
 "id": 4,
 "name": "dressing area",
 "assets": ["dressing_table-0", "chair-0"],
 "rational": "the dressing table is in an open area of the room, and the chair is in front of the dressing table for seating.",
 "key_relations_between_assets": ["the chair is in front of the dressing table"],
 "key_relations_with_other_groups": ["the dressing area complements the sleeping area and the storage area by providing another function in the room."]
 }
]
}
```
```

...

Now, please proceed by grouping **and** organizing the following **list** of assets according to the layout instruction:

NOTE: it **is** very important to include **all** the assets!!! And please do **not** change the name of the assets.

```
Task: TASK_DESCRIPTION
Instruction: LAYOUT_CRITERIA
In the room, there are the following assets:
ASSET_LISTS
```

A.2. Differentiable Spatial constraint

We define differentiable objectives for the spatial constraints used in our method. We introduce the necessary notations and provide the mathematical formulations below. The pose of an asset m_i is represented as $p_i = (x_i, y_i, z_i, \theta_i)$, the orientation of the asset θ_i is represented with an orientation vector $\mathbf{v}_i = (\cos \theta_i, \sin \theta_i)$, and b_i denotes the 3D bounding box size of the asset. Below are the mathematical objectives for various spatial relations.

Distance Objective

$$\mathcal{L}_{\text{distance}}(p_i, p_j, d_{\min}, d_{\max}) = \text{clamp}(\min(\|p_i - p_j\| - d_{\min}, d_{\max} - \|pos_i - pos_j\|), 0, 1) \quad (3)$$

where $\|pos_i - pos_j\| = \sqrt{(x_i - x_j)^2 + (y_i - y_j)^2}$ is the Euclidean distance between i and j in the x-y plane. The function $\text{clamp}(x, a, b)$ constrains x to $[a, b]$, defined as $\text{clamp}(x, a, b) = \min(\max(x, a), b)$.

On-Top-Of Objective

$$\mathcal{L}_{\text{on_top_of}}(p_i, p_j, b_i, b_j) = -\mathcal{L}_{\text{DIoU}}(p_i, p_j, b_i, b_j). \quad (4)$$

where $\text{IoU}(a, b)$ denotes the Intersection-over-Union of the bounding boxes of a and b . Instead of using a loss function for the z-axis, the On-Top-Of objective directly sets z_i the z-coordinate of the object i to be on top of the object j .

Point-Towards Objective

$$\mathcal{L}_{\text{point_towards}}(p_i, p_j, \phi) = \begin{cases} 0, & \text{if } \mathbf{v}_i \cdot \mathbf{d}_{ij} > 0, \\ 1 - \frac{\mathbf{v}_i \cdot \mathbf{d}_{ij}}{\|\mathbf{v}_i\| \|\mathbf{d}_{ij}\|}, & \text{otherwise,} \end{cases} \quad (5)$$

where \mathbf{d}_{ij} is the direction vector from i to j rotated by ϕ degree around the z-axis.

Align-With Objective

$$\mathcal{L}_{\text{align_with}}(p_i, p_j, \phi) = 1 - \frac{\mathbf{v}_i \cdot \mathbf{v}_j}{\|\mathbf{v}_i\| \|\mathbf{v}_j\|}, \quad (6)$$

where \mathbf{v}_i and \mathbf{v}_j are the orientation vectors of i and j , respectively.

Against-Wall Objective The "Against-Wall" objective consists of two components: (a) the sum of distances from the object's corners to the wall, and (b) a term that encourages the object to point away from the wall. Let $c_i^{(k)}$ be the k -th corner of the i -th object, which is calculated based on the object's x - y position (x_i, y_i) , rotation, and bounding box size b_i . The loss function is:

$$\mathcal{L}_{\text{against_wall}}(p_i, w_j, b_i) = \sum_{k=1}^4 \text{clamp}(\|c_i^{(k)} - w_j\|, 0, 1) + \left(1 - \frac{\mathbf{v}_i \cdot \mathbf{n}_{w_j}}{\|\mathbf{v}_i\| \|\mathbf{n}_{w_j}\|}\right), \quad (7)$$

where $\|c_i^{(k)} - w_j\|$ denotes the Euclidean distance between the k -th corner of the object to the wall segment on the x - y plane and \mathbf{n}_w denotes the normal vector of wall w (i.e., perpendicular to the wall).

Optimization Details We use Adam optimizer and Exponential LR scheduler with a decay factor 0.96. Each optimization runs for 400 steps with projection back to the boundary every 100 iterations. Optimizing a scene with 40 assets takes 1–5 minutes on a single GPU, 5-10 GPT-4o calls (i.e., one per group), varying based on the VLM-defined optimization problem.

Below is the prompt we feed VLM to generate spatial constraints.

```
You are an experienced layout designer that place 3
D assets into a scene. Specify the asset
placement using a Python-based DSL.

**3D Convention:**
- Right-handed coordinate system.
- The X-Y plane is the floor; the Z axis points up.
  The origin is at a corner, defining the
global frame.
- Asset front faces point along the positive X axis
  . The Z axis points up. The local origin is
  centered in X-Y and at the bottom in Z. A [90]
  rotation means that the object will face the
  positive Y axis. The bounding box aligns with
  the assets local frame.

**DSL:**
```python
from pydantic import BaseModel, Field
from typing import List, Optional

class Wall(BaseModel):
 corner1: List[float] = Field(description="XY
 coordinates of first corner")
 corner2: List[float] = Field(description="XY
 coordinates of second corner")

class AssetInstance(BaseModel):
 position: Optional[List[float]] = Field(
 description="XYZ position", default=[0, 0,
 0])
 rotation: List[float] = Field(description="
 counterclockwise rotation in degrees
```

```
around Z-axis.", default=[0])

class Assets(BaseModel):
 description: str = Field(description="Asset
 description")
 placements: List[AssetInstance] = Field(
 description="Instances of the 3D asset
 that will share the same shape and
 dimension.")
 size: Optional[List[float]] = Field(description=
 "BBox size. Z-axis up. Assets front faces
 point along the positive X axis.")

class ConstraintSolver:
 def __init__(self):
 self.constraints = []

 def on_top_of(self, asset1: AssetInstance,
 asset2: AssetInstance):
 pass

 def against_wall(self, asset1: AssetInstance,
 wall: Wall):
 pass

 def distance_constraint(self, asset1:
 AssetInstance, asset2: AssetInstance,
 min_distance, max_distance, weight=1):
 pass

 def align_with(self, asset1: AssetInstance,
 asset2: AssetInstance, angle=0.):
 pass

 def point_towards(self, asset1: AssetInstance,
 asset2: AssetInstance, angle=0.):
 pass

solver = ConstraintSolver()
```

**Constraints:**
- Z-axis: on_top_of
- Planar: distance_constraint
- Orientation: align_with, point_towards
- Planar & Orientation: against_wall
- For constraints with multiple arguments, the
  order determines the constraint direction. For
  example, to update both assets placements
  with align_with, specify the constraint twice,
  swapping the arguments. For example, solver.
  point_towards(chair[0], sofa[0]) makes the
  chair point to the sofa, while solver.
  point_towards(sofa[0], chair[0]) adjusts the
  sofa to point to the chair.

**Task:**
You will receive:
1. High-level design goals.
2. A list of existing scene assets (if any).
3. A list of new assets with their dimensions and
  orientations.
4. A top-down view of the current scene, with a
  marked global frame, 1-meter grid, labeled
  assets, and front-facing orientation arrows.
  Walls are also labeled with orientation arrows
  .
5. A side view of the current scene, with the
global frame and 1-meter grid.
6. A top-down view of each new asset in an empty
  scene, facing the positive X-axis, labeled
  with its name and front-facing arrow.

Your task is to write a program that:
1. Specifies precise position and rotation for the
  new asset placements.
```

- Constraints **for** the asset placements. These constraints will ensure that the layout semantics are maintained when the layout **is** being adjusted to be physically feasible.

```

**Instructions:**
Follow these instructions carefully:
- Specify the constraints for all the assets to be placed, specifically for each asset instance in the placements list of the Assets class.
- Specify at least one planar constraint and one orientation constraint for each asset.
- Do not specify constraints for existing assets or walls.
- Do not re-initialize existing assets or walls.
- Do not hallucinate assets.
- Enclose your answer in the ``python `` code block. PLEASE DO NOT REPEAT THE GIVEN PROGRAM.
- Use code comments to explain your reasoning.
- Do not overwrite asset variable names (e.g., avoid for chair in sofa.placements: ...).
- It is important to find a empty space to place the new sets of assets given the

```

A.3. Self-Consistent Decoding

We propose self-consistent decoding to address the challenge of maintaining layout coherence in VLM-generated spatial plans. Our main hypothesis is that preserving self-consistent spatial relations—those that align with the estimated numerical poses of objects—is essential for ensuring semantic and physical plausibility during optimization. During implementation, we simplify the decoding process by enforcing that each asset maintains at most one orientational constraint, either to “point towards” or “align with” another asset. Additionally, the spatial relation “on top of” is excluded from the self-consistency decoding, as we empirically observe that “on top of” relations are almost accurately and reasonably predicted by our model; thus, enforcing self-consistency is unnecessary.

A.4. Annotating Unlabeled 3D Assets

We annotate the 3D assets used in a similar way as in Holodeck [5], using GPT-4o to determine the front face of the object and to determine the textual description of the asset. More specifically, GPT-4o takes a set of four images as inputs, each showing an object from orthogonal rotations (0°, 90°, 180°, and 270°) and outputs the following attributes for the 3D object:

- **Category:** a specific classification of the object, such as “chair”, “table”, “building”, etc.
- **Variable Name:** a string denoting the python variable name that will be used to refer to this object in our scene layout representation.
- **Front View:** an integer denoting the view representing the front of the object, often the most symmetrical view.
- **Description:** a detailed textual description of the object.
- **Materials:** a list of materials constituting the object.
- **Placement Attributes:** Boolean values (ONCEILING, ONWALL, ONFLOOR, ONOBJECT) indicating typical placement locations. For example, “True” for a ceiling fan’s

placement on the ceiling.

B. Details of our Experiments

B.1. Generating Test Cases

We developed a pipeline for generating valid open-vocabulary 3D layout generation cases to benchmark our method against existing methods.

First, we feed the following prompt to GPT-4o to generate a layout instruction given the room type:

```

Given a task description, return a string description of layout criteria for an interior design focused on the provided task. Include considerations for aesthetics, functionality, and spatial organization. Each layout criteria string should start with the phrase "The layout criteria should follow the task description and be...".

```

```

For example, if the task description is a spacious study room, the layout criteria should be:
"The layout criteria should follow the task description and be spacious, tidy, and minimal
"

```

```

task description: TASK_DESCRIPTION

```

```

Return only the layout criteria and nothing else. Ensure that the criteria is no longer than 1-2 sentences. It is extremely important.

```

Condition on the generated room layout instruction, we then use the following prompt to retrieve a bunch of plausible assets:

```

Given a client’s description of a room or tabletop and the floor vertices of the room, determine what objects and how many of them should be placed in this room or table.

```

```

Objects should follow the requirements below.

```

```

Requirement 1: Be specific about how you describe the objects, while using as simple english as possible. Each object should try to be around two words, including a relevant adjective if possible. Normally this adjective should be the room type, such as "kitchen scale" or "bathroom sink". However, it can also be a color or a material, such as "wooden chair" or "red table" if necessary. Ensure that descriptions are simple - an elementary student should understand what each object is.

```

```

For example, if a client description asks for "weightlifting racks", simplify the description to "weightlifting equipment".

```

```

For example, if a client description asks for "a 1980’s jukebox", simplify the description to "vintage jukebox".

```

```

For example, if a client description includes "aerobic machines", simplify the description to "treadmill" and "exercise bike".

```

```

For example, if a client is describing a kitchen and is asking for a "scale" for food, ensure the object includes an adjective to describe the object, such as "kitchen scale".

```

For example, if a client is describing a bathroom and is asking for a "sink", ensure the object includes an adjective to describe the object, such as "bathroom sink".

Requirement 2: Only choose objects that are singular in nature.

For example, instead of choosing a "speaker system", just choose "speaker".

For example, Instead of choosing "tables" and "chairs", just choose "table" and "chair".

Requirement 3: Ensure that the objects are relevant to the room or tabletop.

A client's description can either describe a room or tabletop arrangement. If it is describing a tabletop arrangement, do not include objects like "table" or "chair" in the response. Only include objects that would be placed on the table.

If it is describing a room arrangement, do not describe include things like "windows" or "doors" in the response.

Only include objects that would be placed in the room. Other than paintings, posters, light fixtures, or shelves,

do not include objects that would be placed on the wall.

Requirement 4: Ensure that rooms have a place to sit and a place to put things down, like a counter, table, or nightstand.

This also means that objects like art easels, work benches, or desks should have corresponding chairs or stools.

For example, if a client is describing a bar, ensure that the response includes a "bar table" or "counter" and "bar stools" as well.

For example, if a client describes a classroom, ensure that all desks have corresponding chairs.

Requirement 5: Try and include as many objects as possible that are relevant to the room or tabletop. Aim for at least 10 objects in each response, but ideally include more.

After ensuring these requirements, return a dictionary objects, where the key is the object name and the value is an array tuple of two values.

The first value of the key array is the number of times that object should occur in the room and the second value is how many types of that object should exist.

For example, for a given description of a garden, you would want many plants, but do not want all of them to be the same type.

Thus, the value of the key array would be [9, 3] for the object "plant". This means that there should be 9 plants in the garden

and there should be 3 different types of ferns in the garden.

For example, for a given description of "A study room 5m x 5m"

Return the Dictionary: {"desk": [1, 1], "chair": [1, 1], "lamp": [1, 1], "bookcase": [2, 1], "laptop_computer": [1, 1], "computer monitor": [1, 1], "printer": [1, 1], "sofa": [1, 1], "flowerpot": [1, 1], "painting": [1, 1]}

For example, for a given description of "A tabletop arrangement with a bowl placed on a plate 1m x 1m"

Return the Dictionary: {"plate": [1, 1], "bowl": [1, 1], "fork": [1, 1], "knife": [1, 1], "spoon": [1, 1], "napkin": [1, 1], "salt shaker": [1, 1], "pepper shaker": [1, 1], "wine glass": [1, 1], "water glass": [1, 1]}

For example, for a given description of "a vibrant game room filled with vintage arcade games and a jukebox, 6m x 6m"

Return the Dictionary: {"jukebox": [1, 1], "arcade machine": [3, 1], "pool table": [1, 1], "darts board": [1, 1], "bar stool": [4, 1], "bar table": [1, 1], "neon sign": [1, 1], "popcorn machine": [1, 1], "vending machine": [1, 1], "air hockey table": [1, 1]}

For example, for a given description of "a lush inside garden filled with a variety of plants and a small birdbath, 5m x 3m"

Return the Dictionary: {"fern": [8, 3], "birdbath": [1, 1], "flowerpot": [3, 1], "watering can": [1, 1], "garden gnome": [1, 1], "garden bench": [1, 1], "garden shovel": [1, 1], "garden rake": [1, 1], "garden hose": [1, 1]}

task description: TASK_DESCRIPTION

layout criteria: LAYOUT_CRITERIA

room size in meters: ROOM_SIZE

Remember, you should only include objects that are most important to be placed in the room or on the table.

The dictionary should not include the room dimensions.

Return only the dictionary of objects and nothing else. It is extremely important.

Subsequently, we embed the generated asset descriptions using CLIP [36] and use the embeddings to retrieve 3D assets from Objaverse. The following prompt is employed to verify whether the retrieved object belongs to the given room:

You are an interior designer. A client **is** suggesting possible objects that he thinks belongs **in** a described room. You are tasked with determining **if** the client **is** correct **or not**, stating whether the proposed **object** belongs **in** the described room.

Given a client's description of a room or tabletop, the description of an object, and images of the object,

determine if the described object should be placed in the room that is described. To help, you are also

given a description of what object the client was initially looking for. Ensure that the style and color

of the object matches the type of the room. If an object is not in the style of what the room type

would typically have, it should not be placed in the room.

Return "True" if the object should be kept in the room and "False" if the object should not be.

For example, if the room description is a "A tabletop arrangement with a bowl placed on a

```
plate 1m x 1m" and the object appears to be "a
shovel":
Return: False
```

```
For example, if the room description is a "A
spacious study room with a desk and chair" and
the object appears to be "an 18th century
book":
Return: True
```

```
For example, for a given description of "a vibrant
game room filled with vintage arcade games and
a jukebox, 6m x 6m" and the object appears to
be "a 1980s pinball machine":
Return: True
```

```
For example, for a given description of an "art
room with chairs", and the object appears to
be a "a pink beach chair":
Return: False
```

```
task description: TASK_DESCRIPTION
layout criteria: LAYOUT_CRITERIA
object description: OBJECT_DESCRIPTION
object client requested: OBJECT_LOOKING_FOR
```

```
Remember, you should only return "True" if the
object should be placed in the room / tabletop
and "False" if the object should not be.
Do not include any other words in your response. It
is extremely important.
```

At last, we conduct many verifications to remove assets that humans deem unsuitable given the room type and layout instruction (e.g., a 3D asset of an entire city should not appear in an indoor scene).

B.2. Evaluation

Evaluating the quality of generated 3D layouts requires metrics that measure both physical plausibility and semantic coherence. In this section, we introduce the evaluation prompts we feed to VLM to assess the performance of layout generation systems.

We measure the positional and rotational *Semantic coherence* score with the following prompts.

```
You are an interior designer.
Given generated renderings of a room, your job is
to evaluate how well an
automated 3D layout generator does.
```

```
The instruction given to the 3D layout generator
was:
```

```
Evaluate the 3D layout generator as follows:
Assess the the relative position (do not consider
orientation) between assets: determine if
related objects are placed near each other in
a way that makes sense for their use.
```

- Scoring Criteria **for** Position:

```
100-81: Excellently Positioned - Related
objects are positioned near each other
perfectly, facilitating their combined use
.
```

```
80-61: Well Positioned - Most related objects
are logically placed near each other, with
few exceptions.
```

```
60-41: Adequately Positioned - Some related
objects are not optimally placed,
impacting their use together.
```

```
40-21: Poorly Positioned - Many related objects
are placed far apart, hindering their
joint use.
```

```
20-1: Very Poorly Positioned - Related objects
are placed without consideration for their
relationship, severely affecting
functionality.
```

```
Please assess the image based on how coherently its
layout aligns with the given target criteria.
Please provide justification and explanation for
the score you give, in detail.
Always end your answer with "### my final rating is
: [replace this with a number between 1-100]".
This is extremely important.
```

```
You are an interior designer.
Given generated renderings of a room, your job is
to evaluate how well an
automated 3D layout generator does.
```

```
The instruction given to the 3D layout generator
was:
```

```
Evaluate the 3D layout generator as follows:
Assess the coherency of asset orientation: Evaluate
if related objects are oriented relative to
each other in a way that makes sense for their
use.
```

- Scoring Criteria **for** Orientation:

```
100-81: Excellently Oriented - The orientation
of objects perfectly complements their use
and relationship with each other.
```

```
80-61: Properly Oriented - Most objects are
oriented sensibly relative to each other,
with minor misalignments.
```

```
60-41: Adequately Oriented - Several objects
have orientations that do not fully
support their use or relation.
```

```
40-21: Poorly Oriented - Many objects are
oriented in ways that detract from their
functionality or relation.
```

```
20-1: Very Poorly Oriented - Objects are
oriented without any apparent logic,
severely undermining their intended use
and relationship.
```

```
Please assess the image based on how coherently its
layout aligns with the given target criteria.
Please provide justification and explanation for
the score you give, in detail.
Always end your answer with "### my final rating is
: [replace this with a number between 1-100]".
This is extremely important.
```

We measure the *Physically-grounded Semantic Alignment Score (PSA)* with *Collision-Free Score (CF)*, *In-Boundary Score (IB)*, and the overall prompt alignment score following prompt.

```
You are an interior designer.
Given generated renderings of a room, your job is
to evaluate how well an
automated 3D layout generator does.
```

```
The instruction given to the 3D layout generator
was:
```

```
Evaluate the 3D layout generator as follows:
```

Layout criteria match: On a scale of 1 to 100, how well does the layout (i.e. just the layout **not** the assets) capture the essence of the specified layout criteria?

- Scoring Criteria:

- 100: Excellent: The layout of the scene (i.e. relative position **and** pose of objects **in** the scene) align very well with the criteria.
- 80: Good: The layout of the scene mostly align with the criteria (only ~10% assets do **not**).
- 60: Ok: The layout of the scene somewhat align well with the criteria (only ~30% assets do **not**).
- 40: Poor: The layout of the scene (over ~50% of the assets) do **not** align with the criteria.
- 20: Very Poor: The layout of the whole scene does **not** capture the target criteria at **all**.

Please assess the image based on how coherently its layout aligns with the given target criteria. Please provide justification **and** explanation **for** the score you give, **in** detail. Always end your answer with "### my final rating is : [replace this with a number between 1-100]". This **is** extremely important.

C. More Qualitative Comparison

In Figure 7, we present more qualitative examples of layouts generated by LAYOUTVLM and baseline methods. LAYOUTVLM consistently outperforms baseline methods across all room types in terms of both physical plausibility and semantic coherency. In the Living Room example, LAYOUTVLM excels in identifying semantic asset group by clustering sofa and table together. By leveraging spatial reasoning from VLMs, we are able to stack assets together, as shown in the Deli example.

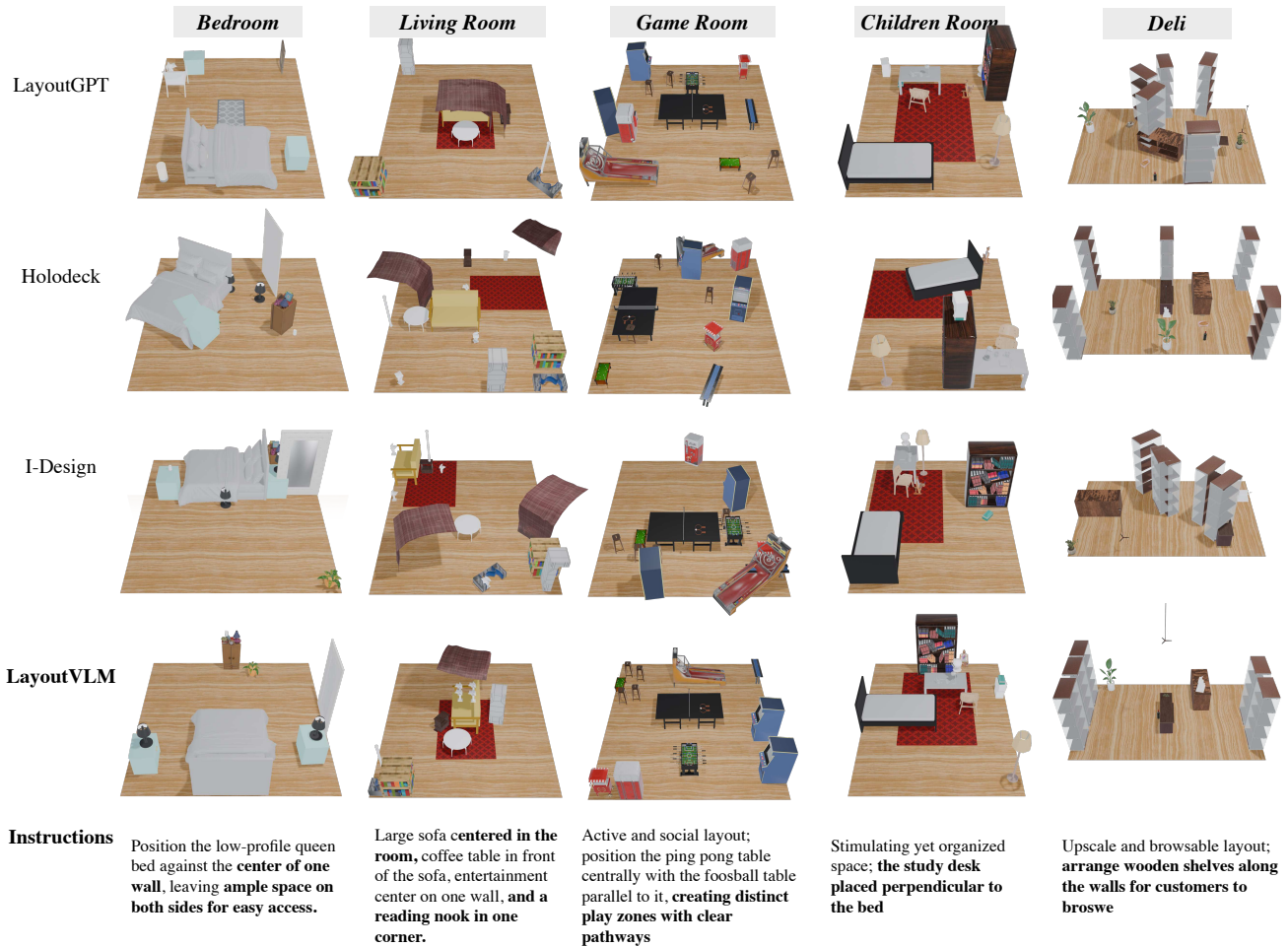

Figure 7. More qualitative comparison with baseline methods in generating layouts based on detailed language instructions.