

EXTREME POINTS IN MULTI-DIMENSIONAL SCREENING

PATRICK LAHR AND AXEL NIEMEYER

ABSTRACT. This paper characterizes extreme points of the set of incentive-compatible mechanisms for screening problems with linear utility. Extreme points are exhaustive mechanisms, meaning their menus cannot be scaled and translated to make additional feasibility constraints binding. In problems with one-dimensional types, extreme points admit a tractable description with a tight upper bound on their menu size. In problems with multi-dimensional types, every exhaustive mechanism can be transformed into an extreme point by applying an arbitrarily small perturbation. For mechanisms with a finite menu, this perturbation displaces the menu items into general position. Generic exhaustive mechanisms are extreme points with an uncountable menu. Similar results hold in applications to delegation, veto bargaining, and monopoly problems, where we consider mechanisms that are unique maximizers for specific classes of objective functionals. The proofs involve a novel connection between menus of extreme points and indecomposable convex bodies, first studied by Gale (1954).

JEL Codes: D82, D44, D86, C78, C65

Keywords: Multi-Dimensional Types, Extreme Points, Exposed Points, Indecomposable Convex Bodies, Multi-Good Monopoly Problem, Linear Delegation, Linear Veto Bargaining

Date: December 3, 2024.

Acknowledgments: We thank Felix Bierbrauer, Peter Caradonna, Simone Cerreia-Vioglio, Gregorio Curello, Laura Doval, Mira Frick, Alkis Georgiadis-Harris, Daniel Gottlieb, Michael Greinecker, Nima Haghpahan, Deniz Kattwinkel, Andreas Kleiner, Elliot Lipnowski, Fabio Maccheroni, Alejandro Manelli, Jeffrey Mensch, Benny Moldovanu, Roger Myerson, Efe Ok, Tom Palfrey, Martin Pollrich, Luciano Pomatto, Justus Preußer, Kota Saito, Larry Samuelson, Fedor Sandomirskiy, Mario Schulz, Ina Taneva, Omer Tamuz, Tristan Tomala, Aleh Tsyvinsky, Rakesh Vohra, and Mark Whitmeyer, as well as seminar audiences at ASU, Columbia, the Paris Game Theory seminar, Paris 1, UCR, and USC for helpful discussions and comments.

Lahr: ENS Paris-Saclay, Department of Economics. *Email:* patrick.lahr@ens-paris-saclay.fr.

Niemeyer: Caltech, Division of the Humanities and Social Sciences. *Email:* niemeyer@caltech.edu.

1. INTRODUCTION

Much of the mechanism design literature assumes that agents’ preferences can be described by a single dimension of private information. Under this assumption, the theory has delivered remarkably clean predictions for optimal mechanisms across various applications. However, in many environments, agents’ preferences are more realistically modeled assuming multiple dimensions of private information, for instance, in allocation problems with multiple heterogeneous goods or collective decision problems with several alternatives. Despite their importance, much less is known about multi-dimensional settings. Several results highlight an inherent complexity of optimal mechanisms in these settings, but explicit descriptions have not been obtained outside of a few special cases.¹

In this paper, we study the structure of optimal mechanisms for a class of mechanism design problems featuring one- and multi-dimensional types. Specifically, we consider linear screening problems. A principal makes an allocation that affects their own and an agent’s utility. Both parties’ utilities are linear in allocations and depend on the agent’s type, where the allocation space and type space are convex sets in Euclidean space. Linear screening covers a range of problems with and without transfers, for example, monopoly and bilateral trade problems or delegation and veto bargaining problems.

Our main results characterize the extreme points of the set of incentive-compatible (IC) mechanisms for linear screening problems. Since the principal maximizes a linear functional—their expected utility—over the set of IC mechanisms, an optimal mechanism can always be found among the extreme points. While every optimal mechanism is a mixture over optimal extreme points, generic objective functionals are uniquely maximized at an extreme point.² Moreover, essentially every extreme point is the unique maximizer of some objective functional.³ Thus, determining the structure of optimal mechanisms across instances of the principal’s problem is tantamount to determining the structure of the extreme points.

The extreme-point approach has seen successful applications in a number of other mechanism design settings, but with the sole exception of Manelli and Vincent (2007) (MV), it has not been applied to settings with multi-dimensional types.⁴ Although MV laid important groundwork for the monopoly problem, our characterizations reveal more explicit insights into the structure of extreme points and apply to a broader class of problems.⁵

Our main insight is that in every one-dimensional problem, the set of extreme points admits a tractable description, whereas in every multi-dimensional problem, the set of extreme points is virtually as rich as the set of all incentive-compatible mechanisms. An important observation is that every extreme point is *exhaustive*: the allocations made by the mechanism—its menu—cannot be scaled and translated to make additional feasibility

¹See, for example, Rochet and Choné (1998), Manelli and Vincent (2006, 2007), Hart and Reny (2015), Daskalakis et al. (2014), Daskalakis et al. (2017), or Hart and Nisan (2019).

²We show that the set of IC mechanisms is norm-compact and convex. The first claim then follows from Choquet’s theorem. The second claim follows from a theorem by Lau (1976) (where genericity is in a topological sense).

³This claim follows from a theorem by Straszewicz and Klee (Klee Jr, 1958). More precisely, the mechanisms that are uniquely optimal for some instance of the principal’s problem, i.e., exposed points, are dense in the set of extreme points.

⁴See, for example, Border (1991), Manelli and Vincent (2010), Kleiner et al. (2021), Nikzad (2022, 2024), or Yang and Zentefis (2024).

⁵We provide a detailed discussion of our relation to MV in Section 9.

constraints binding.⁶ In one-dimensional problems, extreme points admit a tight upper bound on their menu size on top of exhaustiveness. In contrast, in multi-dimensional problems, every exhaustive mechanism can be transformed into an extreme point by applying an arbitrarily small perturbation. For exhaustive mechanisms with a finite menu, this perturbation simply displaces the menu items into general position. In particular, generic exhaustive mechanisms are extreme points.

1.1. Discussion. A common explanation for the difficulty with multi-dimensional screening is that binding incentive constraints depend on the choice of mechanism, making it a priori unclear which constraints will be binding in an optimal mechanism; our results corroborate this explanation. The perturbation described in the previous paragraph modifies the binding incentive constraints of an exhaustive mechanism for an arbitrarily small set of types. Thus, since exhaustive mechanisms are defined only in terms of binding feasibility constraints, the qualitative properties that distinguish extreme points from other mechanisms are essentially only properties of binding feasibility constraints. In contrast, for all one-dimensional problems, properties of binding incentive constraints impose significant restrictions on the structure of the extreme points, e.g., by limiting their menu size to no more than a few allocations in typical applications.

A potential concern is that our results characterize the structure of optimal mechanisms across all instances of the principal’s problem, i.e., for arbitrary utility functions and beliefs about the agent’s type, while in some applications, the principal’s utility function is known. For example, when a monopolist maximizes revenue, certain extreme points are suboptimal for every belief of the monopolist about the agent’s valuations. Our main insights remain the same in sample applications where the principal’s utility is fixed and state-independent, such as in the monopoly problem. In particular, with multi-dimensional types, we show that the extreme points that are (uniquely) optimal for some belief of the principal are again virtually as rich as the set of all IC mechanisms.

Our results offer some insights into the capabilities and limitations of the classical mechanism design paradigm. An important pillar for the success of the theory is that, in many applications, it makes predictions for optimal mechanisms that are independent of the specific details of the environment. We confirm that such predictions are obtainable for all one-dimensional linear screening problems, whereas they are largely unattainable for all multi-dimensional linear screening problems. When the structure of the optimal mechanism depends too finely on the model parameters, it is difficult to derive tangible practical guidance and testable implications from the theory since parameters such as type distributions may be unknown or unobservable in practice.

We emphasize that we do not provide a full solution to multi-dimensional linear screening in that we do not identify the optimal mechanism for each instance of the principal’s problem and show how this mechanism varies across instances. However, given the overwhelming complexity of the structure of extreme points, it seems implausible that such comparative statics exercises are feasible in full generality.

1.2. Technical Contributions. We obtain our results by establishing a connection between extreme points of the set of IC mechanisms and extremal elements of certain spaces of convex sets. Instead of studying the set of IC mechanisms or the agent’s associated indirect utility

⁶A feasibility constraint is an affine restriction on the set of feasible allocations, i.e., a halfspace.

functions,⁷ we study the space of all menus that the principal could offer the agent. By the well-known taxation principle, any IC mechanism is the agent’s choice function from some menu of allocations and vice versa. Since preferences are linear, offering the agent a menu is payoff-equivalent to offering the agent the menu’s convex hull. Thus, we can establish a bijection between payoff-equivalence classes of IC mechanisms and certain convex sets contained in the allocation space. We show that this bijection preserves convex combinations (in the sense of Minkowski) and therefore preserves extreme points. Analogous bijections hold onto the set of indirect utility functions.

The extremal elements of the space of compact convex sets in Euclidean space are relatively well understood in the mathematical literature and are referred to as *indecomposable convex bodies*, first studied by Gale (1954). Most of our results are derived from translating these mathematical insights into economic insights via the connection between IC mechanisms and menus in the form of convex sets. Two kinds of complications arise in this translation. First, feasibility requires that menus are contained in the space of allocations; these constraints are not generally considered in the literature on indecomposability. Second, certain menus are equivalent from the agent’s perspective when the type space is restricted, i.e., when the agent’s preferences are constrained to a subset of all linear preferences.

Indecomposable convex bodies in the plane are points, line segments, and triangles, but they are so plentiful and complex in higher dimensions that a complete description has not been obtained and is not to be expected.⁸ However, what is known in the mathematical literature is enough to obtain the relevant economic insights we present in this paper. The complexity of indecomposable convex bodies in two- versus higher dimensions mirrors the dichotomy between one- and multi-dimensional screening problems since, with linear utility and up to redundancies, an allocation space of a given dimension always corresponds to a type space of one dimension less. (Transfers would here be counted as an allocation dimension of its own.)

1.3. Structure of the Paper. Section 2 introduces relevant notation and mathematical definitions. Section 3 introduces the model. Section 4 gives a characterization of extreme points in terms of mechanisms that make an inclusion-wise maximal set of incentive and feasibility constraints binding. Section 5 clarifies the role of feasibility constraints by defining and characterizing exhaustive mechanisms. Section 6 presents our core results for one- versus multi-dimensional problems, along with several supporting results. Section 7 introduces the relevant mathematical tools and sketches the proof of our core results in the context of a delegation problem among lotteries over finitely many alternatives, with an emphasis on the special role of the three-alternative case.⁹ Section 8 discusses applications to monopolistic selling and veto bargaining, including essentially complete characterizations of undominated mechanisms in the sense of Manelli and Vincent (2007) for these settings. Section 9 provides

⁷For the indirect-utility approach, see e.g. Rochet (1987), Rochet and Choné (1998), Manelli and Vincent (2006, 2007), and Daskalakis et al. (2017).

⁸Schneider (2014) writes (p. 166): “Most [(in the sense of topological genericity)] convex bodies in \mathbb{R}^d , $d \geq 3$, are smooth, strictly convex and indecomposable. It appears that no concrete example of such a body is explicitly known. This is not too surprising, since it is hard to imagine how such a body should be described.” We note that algebraic characterizations of indecomposable polytopes are known; see McMullen (1973), Meyer (1974), and Smilansky (1987). We provide a characterization along these lines in Appendix B.

⁹Problems with three alternatives have been considered as the simplest departure from the two-alternative case often studied in the literature on mechanism design without transfers; see Börgers and Postl (2009).

an extensive discussion of the related literature, including multi-dimensional screening, extreme points in mechanism design, delegation and veto bargaining, and the mathematical foundations underlying this paper. Section 10 concludes.

Appendix A collects several auxiliary results, including the translation between the set of IC mechanisms and a certain space of convex sets. Appendix B deals with the geometry of the set of finite-menu mechanisms and provides an algebraic characterization of finite-menu extreme points (which generalizes the main result in Manelli and Vincent (2007)). Appendix C provides a complete characterization of extreme points for one-dimensional problems omitted from the main text for brevity. Appendix D contains the proofs for all results in the main text.

2. NOTATION AND MATHEMATICAL DEFINITIONS

Let X be a subset of a topological vector space E . $\Delta(X)$ denotes the set of Borel probability measures on X . $\text{int } X$ denotes the interior of X , $\text{bndr } X$ denotes the boundary of X , and $\text{cl } X$ denotes the closure of X . $\text{conv } X$ denotes the convex hull, $\text{cone } X$ denotes the conical hull, and $\text{aff } X$ denotes the affine hull.

Suppose $X \subseteq E$ is convex. $\text{ext } X$ denotes the set of **extreme points** of X , i.e., those $x \in X$ for which $x = \lambda x' + (1 - \lambda)x''$ and $\lambda \in (0, 1)$ implies $x = x' = x''$. $\text{exp } X$ denotes the set of **exposed points** of X , i.e., those $x \in X$ for which there exists a continuous linear functional $f : E \rightarrow \mathbb{R}$ such that $f(x) > f(x')$ for all $x' \in X$, $x \neq x'$. Every exposed point is extreme, but the converse is not generally true. A **face** f of X is a convex subset of X such that for all $x \in f$, $x', x'' \in X$, and $\lambda \in (0, 1)$, $x = \lambda x' + (1 - \lambda)x''$ implies $x', x'' \in f$. The set $X \subseteq E$ is a **polytope** if it is the convex hull of finitely many (extreme) points.

We use the following standard terminology for convex sets in Euclidean space. A **convex body** $K \subset \mathbb{R}^d$ is a non-empty compact convex set. A **polyhedron** $P \subseteq \mathbb{R}^d$ is the finite intersection of closed halfspaces. A **polyhedral cone** is a cone that is also a polyhedron. A polytope in Euclidean space is a bounded polyhedron. Every face f of a polyhedron P can be represented as $f = \arg \max_{a \in P} a \cdot \theta$ for some $\theta \in \mathbb{R}^d$. A face f is **proper** if $f \neq P$. A **vertex** v of P is a face of dimension 0, i.e., an extreme point of P .¹⁰ A **facet** F of P is a face of P such that $\dim F = \dim P - 1$. If $P \subseteq \mathbb{R}^d$ is d -dimensional, then the **facet-defining hyperplane** of F is the unique supporting hyperplane $H = \{y \in \mathbb{R}^d \mid y \cdot n_H \leq c_H\}$ of P such that $F \subseteq H$, where n_H is the outer (unit) normal vector to P on F .

3. MODEL AND PRELIMINARIES

3.1. Allocations and Types. There is a principal and an agent. The principal chooses an allocation $a \in A \subset \mathbb{R}^d$, where A is a d -dimensional polytope. The principal's preferences over allocations depend on the agent's private information, their type $\theta \in \Theta \subset \mathbb{R}^d \setminus \{0\}$, where the set $\{\lambda\theta \mid \theta \in \Theta, \lambda \in \mathbb{R}_+\}$ of all rays through the type space Θ is a d -dimensional polyhedral cone. We say that the type space is **unrestricted** if $\text{cone } \Theta = \mathbb{R}^d$. An agent of type $\theta \in \Theta$ derives utility $a \cdot \theta$ from allocation $a \in A$. Given the agent's type $\theta \in \Theta$, the principal derives utility $a \cdot v(\theta)$ from allocation $a \in A$, where $v : \Theta \rightarrow \mathbb{R}^d$ is a bounded objective function that captures the conflict of interest between both parties. There may be a veto allocation $\underline{a} \in \text{ext } A$ that the agent can enforce unilaterally.

¹⁰The dimension of a convex set $X \subseteq \mathbb{R}^d$, denoted $\dim X$, is the dimension of its affine hull.

Remark. The model subsumes several screening problems as special cases; see Sections 7 and 8 for examples. In particular, we subsume problems with transferable utility by interpreting one allocation dimension as a numeraire for which the principal and the agent have a known marginal utility. That is, $\Theta = \tilde{\Theta} \times \{-1\}$, $v(\theta) = (\dots, 1)$ for all $\theta \in \Theta$, and $A = \tilde{A} \times [0, \kappa]$, where $\kappa \in \mathbb{R}$ is the total endowment of the numeraire.

Since utility is linear, we can identify types on the same ray from the origin because they have the same preferences over the allocations in A . We select normalized types in the unit sphere $\mathbb{S}^{d-1} = \{y \in \mathbb{R}^d : \|y\| = 1\}$ as canonical representatives, i.e., $\Theta \subseteq \mathbb{S}^{d-1}$. In applications, we occasionally make other selections, e.g., when considering transferable utility. Thus, in our model, a d -dimensional allocation space A always corresponds to a $(d - 1)$ -dimensional type space Θ .¹¹

3.2. Mechanisms. The principal designs a (direct and measurable) **mechanism** $x : \Theta \rightarrow A$ to screen the agent.¹² A mechanism asks the agent to report their type θ and then implements an allocation $x(\theta)$. By the revelation principle, it is without loss of generality for the principal to focus on mechanisms that are **incentive-compatible (IC)** and **individually rational (IR)**:

$$x(\theta) \cdot \theta \geq x(\theta') \cdot \theta \quad \forall \theta, \theta' \in \Theta; \quad (\text{IC})$$

$$x(\theta) \cdot \theta \geq \underline{a} \cdot \theta \quad \forall \theta \in \Theta. \quad (\text{IR})$$

IC means that the agent has no incentive to misreport their type. IR means the agent has no incentive to veto the principal's choice. To simplify the analysis, we assume that there exists a type $\underline{\theta} \in \Theta$ for whom the veto allocation is one of their favorite allocations, i.e., $\underline{a} \in \arg \max_{a \in A} a \cdot \underline{\theta}$. If no veto allocation exists, IR is satisfied by convention.

An **optimal** mechanism is any solution to the principal's problem

$$\begin{aligned} \sup_{x: \Theta \rightarrow A} \int_{\Theta} (x(\theta) \cdot v(\theta)) d\mu \\ \text{s.t. } (\text{IC}) \text{ and } (\text{IR}), \end{aligned} \quad (\text{OPT})$$

where $\mu \in \Delta(\Theta)$ is the principal's belief about the agent's type. We assume that μ admits a bounded probability density, i.e., is absolutely continuous.

We say that a set of (IC) and (IR) mechanisms is a **candidate set** for optimality if it contains an optimal mechanism for every objective function v and belief μ of the principal.

3.3. Menus and Payoff-Equivalence. Instead of designing a mechanism, the principal can equivalently offer the agent a menu (or delegation set) $M \subseteq A$, with $\underline{a} \in M$, from which the agent may choose their favorite allocation. That is,

$$x(\theta) \in \arg \max_{a \in M} a \cdot \theta$$

¹¹Contrary to other notions of one-dimensionality in the mechanism design literature (see e.g. Börgers, 2015, Chapter 5.6), a one-dimensional type space need here not imply a linear order on the underlying preferences. For example, $\Theta = \mathbb{S}^1$ may be a circle.

¹²It is without loss of generality to consider deterministic mechanisms: every randomized allocation in $\Delta(A)$ can be replaced with its barycenter since both principal and agent have linear utility. In applications, we may think of the allocation space A as a set of lotteries over an underlying finite set of alternatives. In this case, a mechanism can be *interpreted* as a stochastic mechanism.

defines an IC and IR mechanism $x : \Theta \rightarrow A$ (if maximizers exist). The value function $U(\theta) = \theta \cdot x(\theta)$ is the agent’s **indirect utility function** associated with the mechanism x .

Mechanisms defined by the same menu are **payoff-equivalent**, i.e., the associated indirect utility functions are the same. For IC mechanisms, it can be shown that payoff-equivalence is equivalent to equality almost everywhere (Corollary A.5).¹³ Thus, payoff-equivalent mechanisms yield the principal the same expected utility since the belief μ is absolutely continuous.

We define the (essential) **menu**

$$\text{menu}(x) = \text{cl} \bigcap \{x'(\Theta) \mid x' \text{ satisfies (IC) and (IR) and is payoff-equivalent to } x\}$$

associated with an IC and IR mechanism as (the closure of) the set of allocations that are commonly made by all mechanisms in its payoff-equivalence class. For example, if the **menu size** $|\text{menu}(x)|$ is finite, then the menu simply consists of the allocations that are made by the mechanism with strictly positive probability (cf. Daskalakis et al., 2017, Definition 7).

We henceforth identify payoff-equivalent mechanisms, i.e., $x = x'$ if $x(\theta) = x'(\theta)$ for almost every $\theta \in \Theta$, and write \mathcal{X} for the set of payoff-equivalence classes of IC and IR mechanisms.¹⁴ In Appendix A.2, we show that \mathcal{X} is L^1 -compact and convex. Therefore, a solution to (OPT) exists and can be found among the extreme points of \mathcal{X} (Bauer’s maximum principle).

4. BINDING INCENTIVE AND FEASIBILITY CONSTRAINTS

In this section, we provide a characterization of the extreme points of the set of IC and IR mechanisms in terms of binding incentive and feasibility constraints. Optimal mechanisms solve a linear optimization problem, and therefore, identifying the binding constraints is crucial for finding a solution. This perspective will prove useful in the subsequent sections.

An (IC) constraint is represented by a pair of types $(\theta, \theta') \in \Theta \times \Theta$, and we define

$$\mathcal{IC}(x) = \left\{ (\theta, \theta') \in \Theta \times \Theta \mid \arg \max_{a \in \text{menu}(x)} \theta' \cdot a \subseteq \arg \max_{a \in \text{menu}(x)} \theta \cdot a \right\} \quad (1)$$

as the set of binding IC constraints of mechanism $x \in \mathcal{X}$. This definition considers a constraint as binding if type θ is indifferent to mimicking type θ' *regardless* of how θ' breaks ties.¹⁵

To define feasibility constraints, recall that the allocation space A is a polytope. Thus, there exists a finite set \mathcal{F} of facet-defining hyperplanes $H = \{y \in \mathbb{R}^n \mid y \cdot n_H = c_H\}$ of A . That is, $A = \bigcap \{H_- : H \in \mathcal{F}\}$, where $H_- = \{y \in \mathbb{R}^n \mid y \cdot n_H \leq c_H\}$ are the associated halfspaces containing A . Each halfspace corresponds to an affine restriction on the space of available allocations, and no restriction is redundant given the others; see Figure 1 for an illustration.

We define

$$\mathcal{F}(x) = \{H \in \mathcal{F} \mid \text{menu}(x) \cap H \neq \emptyset\} \quad (2)$$

as the set of binding feasibility constraints of mechanism x .

¹³Almost everywhere equality is with respect to the spherical measure (since $\Theta \subseteq \mathbb{S}^{d-1}$). For a Borel subset $B \subseteq \mathbb{S}^{d-1}$, the spherical measure is proportional to the Lebesgue measure of the set $\{\lambda\theta \mid \theta \in B, \lambda \in [0, 1]\}$.

¹⁴See Appendix A.1 for a brief discussion of tie-breaking.

¹⁵Since ties are null events, $\mathcal{IC}(x)$ coincides for every type θ and almost every deviation θ' with defining an IC constraint as binding if $x(\theta) \cdot \theta = x(\theta') \cdot \theta$. The latter definition of binding constraints is not robust to tie-breaking.

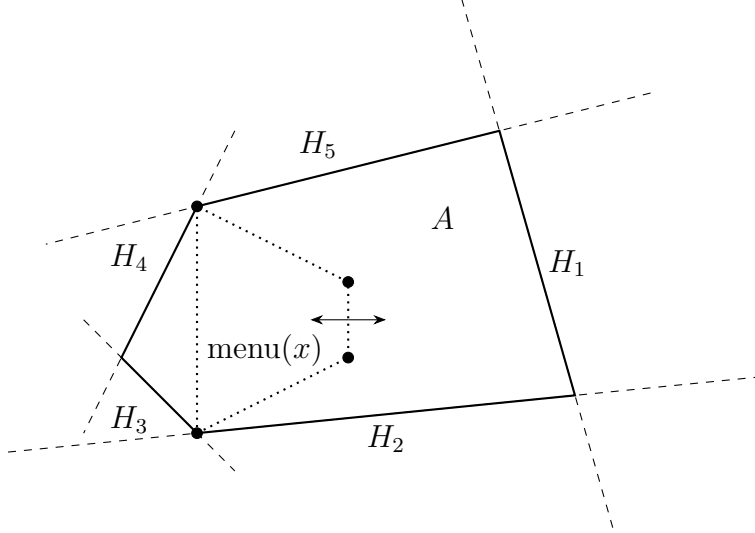

FIGURE 1. The menu of a mechanism $x \in \mathcal{X}$ which is not an extreme point. The allocation space A is a polytope defined by five facet-defining hyperplanes $\mathcal{F} = \{H_1, \dots, H_5\}$. The four allocations marked with dots are the menu of the mechanism. The two rightmost allocations in the menu can be translated horizontally while maintaining the orientation of all dotted lines, keeping the set of binding constraints unchanged. This is clear for the feasibility constraints, and can be seen for the incentive constraints because each type—represented by a direction in \mathbb{R}^2 —still chooses the same menu item(s).

Individual rationality constraints are irrelevant for the formulation of the following result; see Appendix A.3 for an explanation.

Theorem 4.1. *A mechanism $x \in \mathcal{X}$ with finite menu size is an extreme point of \mathcal{X} if and only if there is no other mechanism $x' \in \mathcal{X}$ such that $\mathcal{F}(x) \subseteq \mathcal{F}(x')$ and $\mathcal{IC}(x) \subseteq \mathcal{IC}(x')$.*

Proof. See Appendix D.1. □

Remark. The inclusions $\mathcal{F}(x) \subseteq \mathcal{F}(x')$ and $\mathcal{IC}(x) \subseteq \mathcal{IC}(x')$ in Theorem 4.1 can equivalently be replaced by the equalities $\mathcal{F}(x) = \mathcal{F}(x')$ and $\mathcal{IC}(x) = \mathcal{IC}(x')$.

A mechanism with finite menu size is an extreme point if and only if it is the only mechanism that makes a given inclusion-wise maximal set of constraints binding; Figure 1 illustrates. Of the two types of constraints, binding feasibility constraints are easier to analyze and will be treated separately in the next section.

Let us briefly discuss the proof of Theorem 4.1. If $x = \lambda x' + (1 - \lambda)x''$ is a finite menu mechanism in \mathcal{X} , where $\lambda \in (0, 1)$ and $x', x'' \in \mathcal{X}$, then $\mathcal{IC}(x) = \mathcal{IC}(x') \cap \mathcal{IC}(x'')$.¹⁶ Thus, an important object for understanding extreme points is the set $\{x' \in \mathcal{X} \mid \mathcal{IC}(x) \subseteq \mathcal{IC}(x')\}$ of mechanisms that make an inclusion-wise larger set of IC constraints binding than a given finite-menu mechanism $x \in \mathcal{X}$. We show that this set is a polytope and a face of \mathcal{X} ; in particular, $x \in \text{ext } \mathcal{X}$ if and only if $x \in \text{ext}\{x' \in \mathcal{X} \mid \mathcal{IC}(x) \subseteq \mathcal{IC}(x')\}$. Extreme points of a

¹⁶For almost all type pairs, this is immediate from the definition of the (IC) constraints. See Lemma D.1 for a complete argument.

polytope are uniquely determined by their incident facets, i.e., binding constraints. Thus, $x \in \text{ext } \mathcal{X}$ if and only if x is uniquely determined by its binding feasibility constraints within the face, which completes the proof.

The result does *not* extend to mechanisms with infinite menu size because the relevant face is no longer a polytope.¹⁷ All our subsequent results will nevertheless accommodate mechanisms of infinite menu size.

Remark. The required steps for the proof outlined in the previous paragraph generalize the main results of Manelli and Vincent (2007, Theorems 17, 19, 20, and 24) about extreme points of the multi-good monopoly problem to arbitrary linear screening problems; see Appendix B.

5. EXHAUSTIVE MECHANISMS

In this section, we introduce and characterize *exhaustive* mechanisms and show that every extreme point is exhaustive. Exhaustiveness allows us to isolate the role of binding feasibility constraints in determining which mechanisms are extreme points. Our main results in the next section will clarify the role of binding incentive constraints.

Definition 5.1. *Mechanisms $x, x' \in \mathcal{X}$ are **positively homothetic** if there exists $\lambda \in \mathbb{R}_{++}$ and $t \in \mathbb{R}^d$ such that $x = \lambda x' + t$. Mechanisms $x, x' \in \mathcal{X}$ are **homothetic** if they are positively homothetic or one of them is constant. A mechanism $x \in \mathcal{X}$ is **exhaustive** if there does not exist a mechanism $x' \in \mathcal{X}$ positively homothetic to x such that $\mathcal{F}(x) \subseteq \mathcal{F}(x')$.*

Two mechanisms are (positively) homothetic if one can be obtained from the other by scaling (with a strictly positive scalar) and translation. In geometric terms, a positive homothety leaves invariant the “shape” and “orientation” of menus. In economic terms, a positive homothety leaves invariant the agent’s ordinal preferences over menu items and, in particular, the binding incentive constraints. Positive homothety defines an equivalence relation on \mathcal{X} and every equivalence class of positively homothetic mechanisms contains an exhaustive mechanism, but this mechanism need not be unique; see Figure 2.

Theorem 5.2. *Every extreme point $x \in \text{ext } \mathcal{X}$ is exhaustive.*

Proof. See Appendix D.2. □

For mechanisms with finite menu size, Theorem 5.2 is a corollary of Theorem 4.1. If x is not exhaustive, then there exists a mechanism $x' \in \mathcal{X}$ positively homothetic to x such that $\mathcal{F}(x) \subseteq \mathcal{F}(x')$. $\mathcal{IC}(x) = \mathcal{IC}(x')$ follows immediately from the definition of positive homothety. Therefore, x is not uniquely pinned down by its binding constraints. If x has a finite menu, then Theorem 4.1 completes the proof by contraposition. In general, the argument in Appendix D.2 shows that a mechanism that leaves slack in the feasibility constraints can be decomposed into mechanisms homothetic to itself.

We proceed by characterizing the set of exhaustive mechanisms more explicitly. This characterization is important since every property of exhaustive mechanisms is also a property

¹⁷For example, one can show the existence of strictly incentive-compatible extreme points $x, x' \in \text{ext } X$, i.e., $\mathcal{IC}(x) = \mathcal{IC}(x') = \emptyset$, that make the same feasibility constraints binding, i.e., $\mathcal{F}(x) = \mathcal{F}(x')$. In the linear delegation problem discussed in Section 7, this amounts to showing that there exist smooth and indecomposable convex bodies, i.e., extended menus, that touch the same facets of the unit simplex, which follows by arguments similar to those in the proof of Theorem 6.6; see Schneider (2014, Theorems 2.7.1 and 3.2.18).

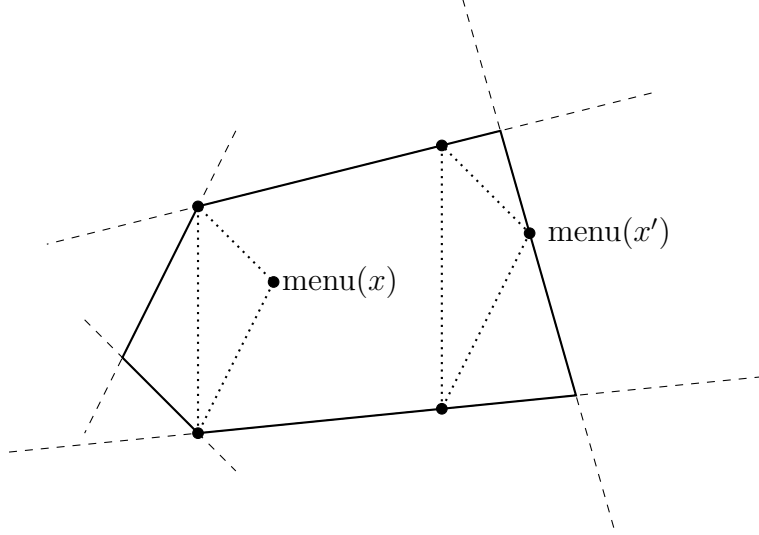

FIGURE 2. Two menus of exhaustive mechanisms homothetic to each other.

of extreme points and hence of optimal mechanisms.¹⁸ Recall that n_H is the normal vector of the facet-defining hyperplane $H \in \mathcal{F}$ of the allocation space A .

Theorem 5.3. *A mechanism $x \in \mathcal{X}$ is exhaustive if and only if one of the following holds:*

- (1) *There exists $a \in \text{ext } A$ such that $\text{menu}(x) = \{a\}$.*
- (2) *(a) $\text{span}\{n_H\}_{H \in \mathcal{F}(x)} = \mathbb{R}^d$ and (b) $\bigcap_{H \in \mathcal{F}(x)} H = \emptyset$.*

Proof. See Appendix D.2. □

That is, a non-constant mechanism is exhaustive if and only if the facet-defining hyperplanes corresponding to the binding feasibility constraints satisfy two conditions: (a) their normal vectors span the ambient space and (b) they have an empty intersection. These conditions ensure that the mechanism can neither be translated or scaled relative to a point in a way that would make additional feasibility constraints binding. Figure 3 illustrates.

An equivalent formulation of condition (2) in Theorem 5.3 is that $\mathcal{F}(x)$ contains $d + 1$ hyperplanes of which (a) d intersect in a single point and (b) the last does not. In particular, if the facet-defining hyperplanes of the allocation space A are in general position, then a non-constant mechanism $x \in \mathcal{X}$ is exhaustive if and only if $|\mathcal{F}(x)| \geq d + 1$.¹⁹ If $d = 2$, then the facet-defining hyperplanes are always in general position; thus, a non-constant mechanism $x \in \mathcal{X}$ is exhaustive if and only if $|\mathcal{F}(x)| \geq 3$.

We illustrate the characterization of exhaustiveness and its economic implications with two examples.

¹⁸While every optimal mechanism is a mixture over optimal extreme points, exhaustiveness is not necessarily preserved under convex combinations. Thus, technically not every optimal mechanism for a given instance (v, μ) of the principal's problem need be exhaustive. However, topologically generic linear objective functionals are uniquely maximized at an extreme point (Lau, 1976). Thus, optimal mechanisms are generically exhaustive.

¹⁹The hyperplanes in \mathcal{F} are in *general position* if every subset of more than d hyperplanes in \mathcal{F} has an empty intersection.

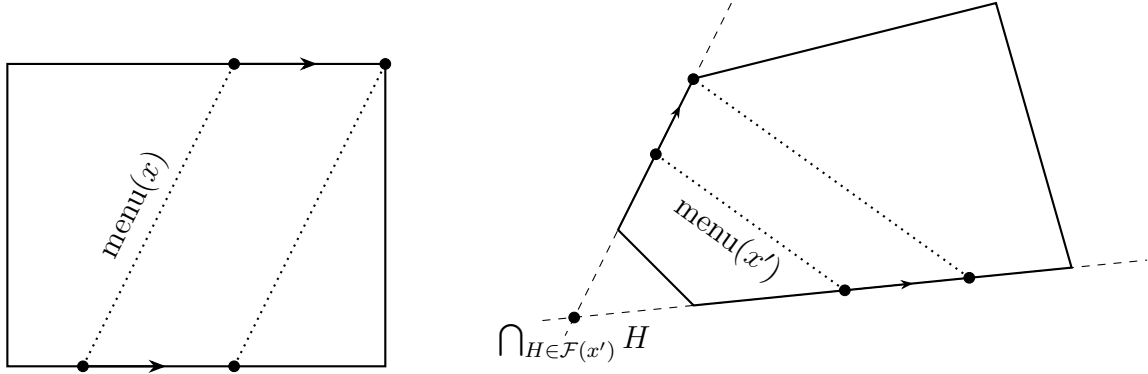

FIGURE 3. Illustrations of conditions (a) and (b) from Theorem 5.3. Left: condition (a) is violated by a menu touching two parallel facets of a rectangle. The menu can be translated horizontally until it touches an inclusion-wise larger set of facets. Right: condition (b) is violated by a menu touching only two facets of a pentagon. The menu can be scaled relative to the intersection point of the two facet-defining lines until it touches an inclusion-wise larger set of facets.

Example 5.4. Let $A = \{a \in \mathbb{R}_+^d \mid \sum_{i=1}^d a_i \leq 1\}$ be the d -dimensional unit simplex embedded in \mathbb{R}^d . The unit simplex is the allocation space when considering lotteries over finitely many alternatives or when dividing time or a budget across a finite set of options (see Sections 7 and 8 for applications). By Theorem 5.3, a non-constant mechanism $x : \Theta \rightarrow A$ is exhaustive if and only if it makes all $d + 1$ feasibility constraints binding.

A facet of the unit simplex, i.e., feasibility constraint, is characterized by those lotteries in which some alternative is chosen with probability 0. Therefore, in economic terms, a non-constant exhaustive mechanism must allow the agent to avoid any particular alternative with probability 1.

Example 5.5. Let $A = [0, 1]^d$ be the unit cube in \mathbb{R}^d . The unit cube is the allocation space in a problem with d goods, one of which could be money. For example, consider a bilateral trade problem where k goods are owned by the principal, $d - k$ goods are owned by the agent, and the principal proposes a menu of possible trades to the agent. By Theorem 5.3, a non-constant mechanism $x : \Theta \rightarrow A$ is exhaustive if and only if it makes d non-parallel feasibility constraints and at least one additional feasibility constraint binding.

A facet of the unit cube, i.e., feasibility constraint, is characterized by those allocations in which some good is either allocated to the principal with probability 1 or to the agent with probability 1. Therefore, in economic terms, an exhaustive mechanism must offer the agent a menu designating at least one good for which the menu contains an option where the agent receives the good with probability 1 and an option where the principal receives the good with probability 1. In addition, for every other good, there must be an option where at least one of the two parties receives the good with probability 1. (The latter condition is automatically satisfied if the menu must include the status quo in which every agent keeps their endowment.)

6. EXTREME POINTS IN ONE- VERSUS MULTI-DIMENSIONAL TYPE SPACES

In this section, we show that the extreme points of the set of IC and IR mechanisms have a simple structure in every problem with one-dimensional types but are virtually as rich as the set of exhaustive mechanisms in every problem with multi-dimensional types. Recall that, in our model, a d -dimensional allocation space A always corresponds to a $(d - 1)$ -dimensional type space Θ . Also recall that \mathcal{F} is the set of feasibility constraints defining the allocation space A .

Theorem 6.1. *Suppose $d = 2$. Then, every extreme point $x \in \text{ext } \mathcal{X}$ is exhaustive and satisfies $|\text{menu}(x)| \leq |\mathcal{F}|$.*

Proof. See Appendix D.3. □

Remark. The bound is tight for the unrestricted type space and attained by allocating to each type one of their most preferred extreme points of the allocation space A .

Theorem 6.1 is the essential insight of a complete characterization of the extreme points for problems with one-dimensional types (Theorem C.1 in Appendix C): extreme points can be succinctly described as choice functions from a limited number of menu items, akin to the well-known posted-price result for the monopoly problem (Myerson, 1981; Riley and Zeckhauser, 1983). The complete characterization shows that a mechanism $x \in \mathcal{X}$ is an extreme point if and only if $\text{menu}(x)$ lacks a certain geometric structure, which we call a *flexible chain*.

In the multi-dimensional case, the structure of extreme points is fundamentally different and markedly more complex. To make this point, we equip the set of IC and IR mechanisms \mathcal{X} with the L^1 -norm

$$\|x\| = \int_{\Theta} \|x(\theta)\| d\theta. \tag{3}$$

We say that a property holds for **most** elements of a subset of a topological space if it holds on a dense set that is also a countable intersection of relatively open sets (i.e., a dense G_{δ}); this is a standard notion of topological genericity.

Theorem 6.2. *Suppose $d \geq 3$. Then, every extreme point is exhaustive and most exhaustive mechanisms are extreme points.*

Theorems 6.1 and 6.2 together show that properties of binding incentive constraints further discipline the set of exhaustive mechanisms if and only if the type space is one-dimensional. Exhaustiveness is a property of binding feasibility constraints alone. Thus, our results corroborate the heuristic understanding in the mechanism design literature that the difficulty with multi-dimensional screening lies in identifying the incentive constraints that are binding in an optimal mechanism.

6.1. Additional Results. In the remainder of this section, we present additional results for the multi-dimensional case that further strengthen Theorem 6.2. We separately discuss extreme points of finite and infinite menu size as well as uniquely optimal mechanisms. All proofs are in Appendix D.3.

We first provide a genericity condition under which an exhaustive mechanism of finite menu size is an extreme point. For this, we say that a set of points $M \subseteq A$ is **in general position** if every hyperplane in \mathbb{R}^d intersects M in at most d points.

Theorem 6.3. *Suppose $d \geq 3$. If $x \in \mathcal{X}$ is exhaustive and $\text{menu}(x)$ is finite and in general position, then $x \in \text{ext } \mathcal{X}$.*

That is, every exhaustive mechanism with a finite menu can be transformed into an extreme point by perturbing its menu into general position. By carrying out such perturbations, we obtain the following genericity result:

Theorem 6.4. *Suppose $d \geq 3$. For every $k \in \mathbb{N}$, the set of extreme points of menu size k is relatively open and dense in the set of exhaustive mechanisms of menu size k .²⁰*

Thus, extreme points remain prevalent among exhaustive mechanisms even when restricting attention to mechanisms that make only a limited number of allocations.

It is easy to show that mechanisms with a finite menu size are dense in the set of all mechanisms. Consequently, we have:

Corollary 6.5. *Suppose $d \geq 3$. The set of extreme points of finite menu size is dense in the set of exhaustive mechanisms.*

We next turn to mechanisms of infinite menu size.

Theorem 6.6. *Suppose $d \geq 3$. Most exhaustive mechanisms are extreme points of uncountable menu size.*

Remark. The proof of Theorem 6.6 establishes the stronger claim that most exhaustive mechanisms are continuous functions (for which the menu is a connected subset of the allocation space). While examples of extreme points with uncountable menu size have been documented in the literature (Manelli and Vincent, 2007; Daskalakis et al., 2017), the existence and prevalence of continuous extreme points is novel.

Exhaustive mechanisms can also be approximated by mechanisms that are uniquely optimal for some objective and prior of the principal. That is, even the most parsimonious candidate sets are dense in the set of exhaustive mechanisms. The formal result is a consequence of a theorem due to Straszewicz and Klee (Klee Jr, 1958), which asserts that the exposed points of a norm-compact convex set are dense in its extreme points.

Corollary 6.7. *Suppose $d \geq 3$. For every exhaustive mechanism $x \in \mathcal{X}$ and every $\varepsilon > 0$, there exists a mechanism $x' \in \text{ext } \mathcal{X}$ such that $\|x - x'\| < \varepsilon$ and such that x' is uniquely optimal for some objective function $v : \Theta \rightarrow \mathbb{R}^d$ and belief $\mu \in \Delta(\Theta)$.*

In Section 8, we show that the gist of our results continues to hold if we only consider those extreme points that are unique maximizers for specific objectives of the principal such as revenue-maximization. That is, candidate sets remain complex even if the principal's objective is a priori known and fixed and only their belief is considered a free parameter.

Remark. We have given an essentially, though not entirely, complete characterization of the extreme points of the set of IC and IR mechanisms. For example, menus that are not in general position and allow some affine dependencies among menu items can still be extreme points. In Appendix B (Theorem B.6), we provide a complete algebraic characterization of finite-menu extreme points. Using the connection to the relevant mathematical concepts to

²⁰An alternative statement is that the set of extreme points of menu size k is relatively open and dense in the set of exhaustive mechanisms of menu size $\leq k$; see the proof.

be established in the next section, the reader can consult the references provided in Section 9 for additional conditions. A complete characterization of all extreme points is not to be expected (see Footnote 8 in the introduction).

7. PROOF IDEAS: THE CASE OF LINEAR DELEGATION

In this section, we explain the methodology behind our results. Our approach is to translate between extreme points of the set of (IC) and (IR) mechanisms and extreme points of the set of all menus. Menus can be identified with convex bodies in allocation space, allowing us to draw upon a mathematical literature that has characterized extremal—there called indecomposable—elements of spaces of convex bodies. We illustrate this transfer of results from mathematics to economics through what we consider to be the simplest multi-dimensional screening problem; detailed proofs and generalizations are relegated to Appendices A and D.

7.1. Linear Delegation. We proceed in the context of the **linear delegation problem** and discuss the necessary adjustments for other problems at the end of this section:

- $A = \{a \in \mathbb{R}_+^d \mid \sum_{i=1}^d a_i \leq 1\}$ is the unit simplex, i.e., the allocation space when considering lotteries over $m = d + 1$ alternatives or when dividing time or a budget across the alternatives (a lists the probabilities or shares of the first d alternatives);
- $\Theta = \mathbb{S}^{d-1}$ is the unrestricted type space, i.e., the agent can have all possible von Neumann-Morgenstern preferences over A ;
- the principal’s objective function $v : \Theta \rightarrow \mathbb{R}^d$ is an arbitrary bounded function, i.e., the principal relies on the agent’s information in order to make an informed decision;
- there is no veto alternative \underline{a} for the agent.

The linear delegation problem features multi-dimensional types whenever there are $m \geq 4$ alternatives and thus differs from classical formulations of delegation problems à la Holmström (1977, 1984), which assume one-dimensional allocation and type spaces and single-peaked preferences; see Section 9 for further discussion.

Next to being a natural application of our model, there are two systematic reasons for considering the linear delegation problem:

- (1) In the linear delegation problem, incentive constraints are completely independent from feasibility constraints in the sense that every mechanism that makes an inclusion-wise maximal set of incentive constraints binding is an extreme point up to positive homothety (Lemma 7.1). This independence simplifies our arguments and renders the connection between extremal menus and indecomposable convex bodies most transparent.
- (2) Every linear screening problem *is* linear delegation with a restricted type space (modulo IR constraints). This is because every linear screening problem can be represented with the unit simplex as its allocation space through an appropriate type space restriction.²¹ With such reformulations, however, cone Θ is no longer full-dimensional, and because of this additional complexity, we do not use reformulations to linear delegation in our general proofs.

²¹Consider a problem with allocation space A and type space Θ . Any allocation polytope $A \subset \mathbb{R}^d$ is the image of a higher-dimensional simplex $S \subset \mathbb{R}^n$ under a linear map $f : \mathbb{R}^n \rightarrow \mathbb{R}^d$ (Grünbaum et al., 1967, Chapter 5.1). An appropriate type space in \mathbb{R}^n corresponding to the simplex is given by $f^T(\Theta)$, where f^T is the transpose of f .

7.2. From Mechanisms to Menus. So far, we have followed the literature in that we have stated our results in terms of direct mechanisms. However, IC mechanisms can equivalently be understood as the agent’s choice functions from different (closed) menus $M \subseteq A$.

We call a closed set $M \subseteq A$ an **extended menu** if every allocation in $A \setminus M$ is strictly preferred by at least one type $\theta \in \Theta$ to every allocation in M . In other words, if M is an extended menu, then there is no allocation that can be added to M without necessarily changing the agent’s choice function. Since the agent has linear utility and we are considering the unrestricted type space in this section, every menu $M \subseteq A$ is extended by passing to its convex hull $\text{conv}(M)$, which is a convex body in allocation space.

It is straightforward to show that the map which assigns to every mechanism $x \in \mathcal{X}$ the extended menu $\text{conv}(\text{menu}(x)) \subseteq A$ is a bijection between the space \mathcal{X} of (payoff-equivalence classes of) IC mechanisms and the space \mathcal{M} of convex bodies in allocation space.

In Appendix A (Theorem A.2), we show that the bijection between \mathcal{X} and \mathcal{M} commutes with convex combinations and, therefore, preserves the linear structure of the underlying spaces. For convex bodies $M, M' \subset \mathbb{R}^d$, this linear structure is given by Minkowski addition and positive scalar multiplication, defined as

$$\lambda M + \rho M' = \{\lambda a + \rho a' \mid a \in M, a' \in M'\}, \quad (4)$$

where $\lambda, \rho \in \mathbb{R}_+$. In particular, extreme points of one space map to extreme points of the other space.

We also show in Appendix A that convergence of extended menus with respect to the Hausdorff distance implies convergence of the corresponding mechanisms in L^1 (Lemma A.7). Thus, any statement about compactness or denseness in the former space carries over to the latter.

7.3. Indecomposability and Exhaustiveness. We next explain how extreme points of the set of extended menus \mathcal{M} can be understood in terms of the notion of indecomposability from the mathematical literature and the notion of exhaustiveness defined in Section 5.

A menu $M \in \mathcal{M}$ is an extreme point of \mathcal{M} if and only if it does not admit either of the following decompositions:

- (1) $M = \lambda M' + (1 - \lambda)M''$ for $\lambda \in (0, 1)$ and $M', M'' \in \mathcal{M}$ homothetic to M ;
- (2) $M = \lambda M' + (1 - \lambda)M''$ for $\lambda \in (0, 1)$ and $M', M'' \in \mathcal{M}$ not homothetic to M .²²

We call (1) a **homothetic decomposition** and (2) a **non-homothetic decomposition**.

Lemma D.2 in Appendix D shows that a mechanism $x \in \mathcal{X}$ is exhaustive if and only if the associated extended menu $M \in \mathcal{M}$ admits no homothetic decomposition. We can straightforwardly extend the definition of exhaustiveness to extended menus because exhaustiveness is solely a property of the feasibility constraints of the allocation space that are intersected by the menu of a mechanism.

Non-homothetic decompositions are closely related to the notion of decomposability from the mathematical literature. A convex body $K \subset \mathbb{R}^d$ is **decomposable** if there exist convex bodies $K', K'' \subset \mathbb{R}^d$ not homothetic to M such that $M = K' + K''$. By scaling the summands, decomposability is equivalent to the existence of convex bodies $K', K'' \subset \mathbb{R}^d$ not homothetic to K such that $K = \lambda K' + (1 - \lambda)K''$ with $\lambda \in (0, 1)$. A convex body that is not decomposable is **indecomposable**.

²²The two cases are mutually exclusive: if one of M' or M'' is homothetic to M , then so is the other.

If an extended menu $M \in \mathcal{M}$ is indecomposable, then M has no non-homothetic decomposition. The converse does not generally hold because the summands $\lambda M'$ and $(1 - \lambda)M''$ of a non-homothetic decomposition in our model are required to be subsets of A , i.e., feasible extended menus.²³ However, when the allocation space is a simplex, indecomposability is necessary and sufficient for the absence of non-homothetic decompositions.

Lemma 7.1. *In the linear delegation problem, an extended menu $M \in \mathcal{M}$ is in $\text{ext } \mathcal{M}$ if and only if M is indecomposable and exhaustive.*

Proof. See Appendix D.4. □

Before proceeding with a characterization of the indecomposable convex bodies, we briefly discuss the economic meaning of indecomposability. Recall that an extreme point of finite menu size is determined by its binding incentive and feasibility constraints (Theorem 4.1). Indecomposability of the associated extended menu ensures that (up to payoff-equivalence) there is no other, non-constant mechanism that makes an inclusion-wise larger set of incentive constraints binding; exhaustiveness ensures the same for the feasibility constraints. Thus, by Lemma 7.1 and in the linear delegation problem, the role of incentive and feasibility constraints in whether or not a mechanism is an extreme point can be completely separated. Indeed, in other linear screening problems, extreme points need *not* make inclusion-wise maximal sets of incentive constraints binding. (Nevertheless, it is helpful to analyze feasibility constraints separately from the incentive constraints, as we have done in Section 5.)

7.4. Characterizing Extreme Points. Given Lemma 7.1, it remains to characterize indecomposable and exhaustive extended menus. Indecomposability has been characterized in the mathematical literature.

Theorem (Meyer, 1972; Silverman, 1973). *A convex body $M \subset \mathbb{R}^2$ is indecomposable if and only if it is a point, line segment, or triangle.*

Figure 1 depicts the proof idea for convex polygons. The figure shows a quadrilateral and two deformations of the quadrilateral that translate the right-most, vertical facet-defining line either to the left or to the right. The resulting deformed quadrilaterals yield a non-homothetic decomposition of the original quadrilateral. Similar deformations can be found for any polygon, but triangles are the only polygons for which these deformations yield homotheties of the triangle. Thus, (degenerate) triangles are the only indecomposable convex polygons. The extension to all plane convex bodies requires a more involved argument.

Theorem (Shephard, 1963). *Let $d \geq 3$. The set of indecomposable convex bodies in \mathbb{R}^d is Hausdorff-dense in the set of all convex bodies in \mathbb{R}^d .*

Shephard identifies a large class of indecomposable polytopes, with the simplest being the *simplicial polytopes*, i.e., polytopes of which every proper face is a simplex. Roughly speaking, a simplicial polytope S is indecomposable because each two-dimensional face of S is a triangle and any decomposition of S into non-homothetic polytopes would also have to decompose every face of S individually, which is impossible because triangles are indecomposable. Simplicial polytopes are Hausdorff-dense in the space of all convex bodies.

²³In the absence of feasibility constraints, every convex body trivially has homothetic decompositions, e.g. through translations into opposite directions. This is why homothetic decompositions are ruled out in the definition of indecomposability.

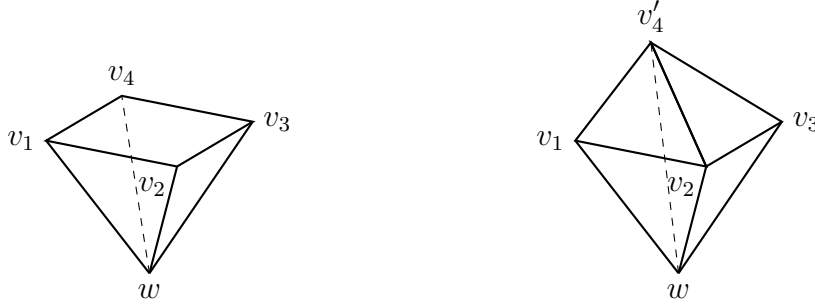

FIGURE 4. Illustration of how to perturb a polytope into a nearby simplicial polytope. Left: a pyramid with apex w and base v_1 - v_2 - v_3 - v_4 . Right: a simplicial polytope obtained from the pyramid by pulling the vertex v_4 to a new vertex v'_4 such that the five vertices are in general position. This procedure can be iteratively applied to the vertices of any polytope to obtain a nearby simplicial polytope. (Incidentally, a pyramid is already indecomposable.)

First, every convex body is arbitrarily close to a polytope. (Take the convex hull of a finite set of points on the body's boundary that is ε -dense in the boundary.) Second, every polytope can be transformed into a simplicial polytope by perturbing its vertices into general position; Figure 4 illustrates.

Exhaustiveness admits a simple economic characterization in the linear delegation problem, which follows immediately from Theorem 5.3 (recall Example 5.4). We state the characterization in terms of mechanisms, but it can equivalently be stated in terms of the associated extended menus:

- A constant mechanism x is exhaustive if and only if it **dictates an alternative**: there exists $a \in \text{ext } A$ such that $\text{menu}(x) = \{a\}$.
- A non-constant mechanism $x \in X$ is exhaustive if and only if it **grants a strike**: for every alternative $k = 1, \dots, m$ there exists a lottery $a \in \text{menu}(x)$ in which alternative k is chosen with probability 0. That is, the agent is given the option to strike out any one of the alternatives. Geometrically speaking, this means that $\text{menu}(x)$ touches all facets of the allocation simplex.

The following characterization result follows at once from the previous arguments and the bijection between the set of mechanisms \mathcal{X} and the set of extended menus \mathcal{M} .

Theorem 7.2. *Consider the linear delegation problem:*

- (1) *With $m = 3$ alternatives, $x \in \mathcal{X}$ is in $\text{ext } \mathcal{X}$ if and only if one of the following holds:*
 - (a) *x dictates an alternative;*
 - (b) *x grants a strike and has menu size at most three.*
- (2) *With $m \geq 4$ alternatives, $\text{ext } \mathcal{X}$ is dense in the set of mechanisms that grant a strike.*

Thus, the theory predicts simple solutions for linear delegation problems with three alternatives, but with four or more alternatives and up to approximation, the only distinguishing property of extreme points is that they dictate or grant a strike.

We remark that optimality in the linear delegation problem, even when there are only three alternatives, may require the use of stochastic mechanisms that offer the agent lotteries

over the alternatives.²⁴ Lotteries can be interpreted as risky courses of action or as budget or time shares. Optimality may even require lotteries with full support, i.e., interior points of the simplex. Intuitively, lotteries give the principal more leeway in screening the agent and make it more difficult for the agent to align the allocation with their own preferences.

7.5. General Linear Screening Problems. We finally discuss the necessary adjustments to our approach when considering (IR) constraints, allocation spaces different from the simplex, and restricted type spaces.

In the context of the linear delegation problem, IR would mean that the menu of a mechanism must contain the veto alternative $\underline{a} \in \text{ext } A$. Any decomposition of a given convex body that contains \underline{a} must also contain \underline{a} . Thus, introducing IR constraints simply amounts to considering extreme points of the set of IC mechanisms that also satisfy IR. The same conclusion obtains in other linear screening problems; see Appendix A.3.

Suppose the allocation space A differs from the simplex. If an extended menu $M \in \mathcal{M}$ is indecomposable, then it does not admit a non-homothetic decomposition. However, the converse is no longer true. This is inconsequential for the denseness results for multi-dimensional problems since we only get additional, extremal but decomposable extended menus. For one-dimensional type spaces, these additional extreme points drive the bound on the menu size from three up to the number of feasibility constraints of the allocation space (Theorem 6.1). We provide a complete characterization of extremal extended menus for one-dimensional type spaces and arbitrary allocation spaces A (Theorem C.1 in Appendix C). This characterization builds on a mathematical result due to Mielczarek (1998).

Suppose the type space is restricted, i.e. $\text{cone } \Theta \neq \mathbb{R}^d$. Extending a menu now entails more than taking the convex hull because there are certain directions in the allocation space along which all types are worse off. Geometrically speaking, these directions form the polar cone of the type space. To prove our result, it is a technical convenience to extend menus beyond the boundaries of the allocation space and work with closed convex sets that share the polar cone as a common recession cone. Indecomposability for closed convex sets with a common recession cone is analogous to indecomposability for convex bodies and has been discussed in Smilansky (1987).

8. SPECIFIC OBJECTIVES: MULTI-GOOD MONOPOLY AND LINEAR VETO BARGAINING

Our previous analysis considered candidates for optimality that the principal must a priori consider when uncertain about both their objective function and the distribution of the agent's types; we now fix the principal's objective, e.g., revenue maximization, and characterize the mechanisms that remain relevant for optimality as the type distribution varies.

In applications to the multi-good monopoly problem and the linear veto bargaining problem, to be defined below, we show that the set of mechanisms that are uniquely optimal for some type distribution is dense in the set of *undominated mechanisms*. A mechanism is undominated if there is no other mechanism that yields the principal an unambiguously higher utility. We provide characterizations of undominated mechanisms, showing that they are almost as rich as the set of all (IC) and (IR) mechanisms. Thus, the gist of our main results holds when

²⁴See Kováč and Mylovanov (2009) and Kleiner et al. (2021) for a discussion about the optimality of stochastic mechanisms in the classical one-dimensional delegation model.

restricting attention to extreme points that are unique maximizers for specific objectives of the principal. We discuss the two applications after introducing undominated mechanisms.

8.1. Undominated Mechanisms. For multi-dimensional problems, we have identified exhaustive mechanisms as a reference set in which the extreme points lie dense. However, with a fixed objective v , not every extreme point remains relevant for optimality. For example, an extreme point might minimize expected revenue for some type distribution μ . The appropriate reference set now becomes the set of undominated mechanisms, originally defined for the multi-good monopoly problem by Manelli and Vincent (2007).

Definition 8.1. A mechanism $x \in \mathcal{X}$ is **dominated** by another mechanism $x' \in \mathcal{X}$ if $x'(\theta) \cdot v(\theta) \geq x(\theta) \cdot v(\theta)$ for almost all $\theta \in \Theta$, with strict inequality on a set of types of positive measure. A mechanism $x \in \mathcal{X}$ is **undominated** if it is not dominated by any other mechanism $x' \in \mathcal{X}$.

Manelli and Vincent (2007) show for the monopoly problem that every undominated mechanism is optimal for some belief about the agent's type. Their benchmark result can be extended from revenue maximization to arbitrary objectives:

Theorem 8.2. For every undominated mechanism $x \in \mathcal{X}$, there exists a type distribution $\mu \in \Delta(\Theta)$ such that x is an optimal mechanism for a principal with belief μ .

Proof. See Appendix D.5. □

Conversely, every mechanism that is optimal for some fully supported type distribution $\mu \in \Delta(\Theta)$ must clearly be undominated.

A priori, *not* every undominated mechanism is a necessary candidate for optimality. (Undominated mechanisms need not be extreme or exposed points). However, in the following applications and as long as types are multi-dimensional, we show that every undominated mechanism is arbitrarily close to a mechanism that is uniquely optimal for some type distribution, i.e., arbitrarily close to a mechanism that is a necessary candidate for optimality.

8.2. Multi-Good Monopoly. The **multi-good monopoly problem** is the following linear screening problem:

- $A = [0, 1]^m \times [0, \kappa]$, where the first m allocation dimensions are the probabilities with which good $i = 1, \dots, m$ is sold to the agent, and the last allocation dimension is the payment by the agent (and κ is some sufficiently large constant, which is without loss of generality whenever valuations are bounded);
- $\Theta = [0, 1]^m \times \{-1\}$, i.e., the consumer has valuations in $[0, 1]$ for each good $i = 1, \dots, m$ and money is the numeraire;²⁵
- $\underline{a} = (0, \dots, 0, 0)$, i.e., the consumer can leave without paying anything;

²⁵Due to linear utility, we implicitly assume that the goods are neither substitutes nor complements for the agent. This assumption is made in most papers on the multi-good monopoly problem. We could incorporate substitutes and complements by allowing the agent to have one valuation for each possible bundle $B \subseteq \{1, \dots, m\}$. The allocation space is then the unit simplex over 2^m deterministic allocations, i.e., all possible bundles, plus an extra dimension representing money as before. Free disposal, i.e., the agent being willing to pay weakly more for inclusion-wise larger bundles, and a fixed marginal utility for money can be modeled as a family of affine restrictions on the type space.

- $v(\theta) = \bar{v} = \{0, \dots, 0, 1\}$ for all $\theta \in \Theta$, i.e., the principal maximizes expected revenue (and goods can be produced at zero cost).²⁶

In line with standard terminology in mechanism design with transfers, we abuse our language by referring to $a \in [0, 1]^m$ as an allocation and $t \in [0, \kappa]$ as the transfer. Instead of probabilities, allocations can also be interpreted as quantities or as quality-differentiated goods with multiple attributes (for which the consumer has unit demand).

We next show that a large class of mechanisms in the monopoly problem is undominated. A **pricing function** is a continuous convex function $p : [0, 1]^m \rightarrow \mathbb{R}_+$ such that $p(0) = 0$ that assigns a price to each possible allocation.²⁷ The **marginal price** for good $i = 1, \dots, d$ at allocation $a \in [0, 1]^m$ with $a_i < 1$ is the directional derivative $\nabla_{e_i} p(a)$ of p at a in the coordinate direction e_i (which exists by the convexity and continuity of p). The mechanism $x \in \mathcal{X}$ obtained from a pricing function is the agent’s choice function from the menu $M = \{(a, p(a)) \mid a \in [0, 1]^m\}$.

Lemma 8.3. *In the multi-good monopoly problem, every mechanism $x \in \mathcal{X}$ can be obtained from a pricing function p with marginal prices in $[0, 1]$. If a mechanism $x \in \mathcal{X}$ can be obtained from a pricing function p with marginal prices $\nabla_{e_i} p$ uniformly bounded away from 0 and 1 for every good $i = 1, \dots, d$, then it is undominated.*

Proof. See Appendix D.5. □

In plain words, a mechanism that, on the margin, prevents low-valuation types from buying additional quantity while enabling high-valuation types to buy additional quantity is undominated. Such a mechanism features “no-distortion at the top” (the highest type receives the efficient allocation) and “exclusion at the bottom” (the lowest type receives nothing), which are well-known properties of optimal mechanisms in screening problems with transfers. In particular, such a mechanism features these two properties *separately* in each allocation dimension. Not all undominated mechanisms have marginal prices bounded away from zero and one, but the gap to the mechanisms that do admit this bound is negligible.²⁸

Corollary 8.4. *In the multi-good monopoly problem, the set of undominated mechanisms is dense in the set of all (IC) and (IR) mechanisms.*

Proof. See Appendix D.5. □

For a rough intuition for the richness of undominated mechanisms, consider the following trade-off. When the principal increases the price for some allocations, revenue increases from those types who continue to choose these allocations. However, some types that have previously chosen an allocation at the lower price may now opt for a cheaper allocation, decreasing revenue from the types that switch. This trade-off rules out a dominance relationship between many mechanisms.

²⁶The literature makes the zero-cost assumption for simplicity. It can easily be relaxed to a constant marginal cost for each good. With decreasing marginal costs, extreme points also remain the relevant candidates for optimality (see the discussion in Manelli and Vincent (2007)). With increasing marginal costs, one has to follow the approach taken by Rochet and Choné (1998).

²⁷Convexity and continuity are without loss of generality because the agent has linear utility. $p(0) = 0$ reflects the (IR) constraint. See also Hart and Reny (2015, Appendix A.2).

²⁸For an example, see the mechanism depicted in Figure 2 in Manelli and Vincent (2007). In the bottom-right “market segment,” the marginal price for good one is 1.

Given the characterization of undominated mechanisms, the same arguments as in Section 7 can be applied to conclude that extreme points are dense in the set of undominated mechanisms and, therefore, in the set of all mechanisms by Corollary 8.4. In the following result, the first part is well-known (see, for example, Manelli and Vincent (2007, Lemma 4)).

Theorem 8.5. *Consider the multi-good monopoly problem:*

- (1) *With $m = 1$ good, a mechanism $x \in \mathcal{X}$ is in $\text{ext } \mathcal{X}$ and undominated if and only if x is a posted-price mechanism with price $p \in (0, 1)$, i.e.,*

$$x(\theta) = \begin{cases} (1, p) & \text{if } \theta_1 \geq p \\ (0, 0) & \text{otherwise.} \end{cases}$$

- (2) *With $m \geq 2$ goods, the set of mechanisms $x \in \mathcal{X}$ that are uniquely optimal for some belief $\mu \in \Delta(\Theta)$ is dense in \mathcal{X} .*

Proof. See Appendix D.5. □

Remark. The proof shows that statement (2) remains true if the belief μ is required to have full support on Θ .

The second part says that any incentive-compatible and individually rational mechanism can be turned into a mechanism that is uniquely optimal for some belief of the seller by applying an arbitrarily small perturbation. The claim about uniquely optimal mechanisms is not an application of Straszewicz' theorem upon showing denseness of the extreme points in the set of undominated mechanisms. While Straszewicz' theorem guarantees that exposed points are arbitrarily close to extreme points, these points may be exposed by linear functionals unrelated to revenue maximization. Our proof modifies the theorem to obtain the desired result.

8.3. Linear Veto Bargaining. We now discuss the following **linear veto bargaining problem**:

- $A = \{a \in \mathbb{R}_+^d \mid \sum_{i=1}^d a_i \leq 1\}$ is the unit simplex, i.e., the allocation space when considering lotteries over $m = d + 1$ alternatives or when dividing time or a budget across the alternatives (a lists the probabilities or shares of the first d alternatives);
- $\Theta = \mathbb{S}^{d-1}$ is the unrestricted domain, i.e., the agent can have all possible von Neumann-Morgenstern preferences over A ;
- there is a veto alternative $\underline{a} \in \text{ext } A$ for the agent (e.g., the status quo in a political context), and we set $\underline{a} = (0, \dots, 0)$ without loss of generality;
- the principal's preferences are given by a Bernoulli utility vector \bar{v} independently of the agent's information, i.e., $v(\theta) = \bar{v}$ for all $\theta \in \Theta$, and we assume for simplicity that
 - (1) $\bar{v} \in \mathbb{R}_{++}$, i.e., the veto alternative is the principal's least preferred alternative, and
 - (2) $\arg \max_i \bar{v}_i$ is a singleton, i.e., the principal has a unique favorite alternative.

The problem can be seen as a delegation problem with a state-independent objective and an IR constraint. Therefore, the extreme points of linear veto bargaining are exactly the extreme points of linear delegation that satisfy IR (Lemma A.9). Linear veto bargaining can also be seen as a no-transfers analogue of the monopoly problem since both problems feature state-independent objectives with an IR constraint.

Lemma 8.6. *In the linear veto bargaining problem, a mechanism $x \in \mathcal{X}$ is undominated if and only if $\text{menu}(x)$ contains the veto alternative and the principal's most preferred alternative.*

Proof. See Appendix D.5. □

The richness of undominated mechanisms in the veto bargaining problem comes from a trade-off similar to that in the monopoly problem. By adding an alternative to the menu of a mechanism, some types prefer the new alternative over their previous choice. Among those who switch, some types will do so in the principal's favor, i.e., switch away from alternatives that the principal likes less than the new alternative. Other types will not switch in the principal's favor, i.e., switch away from alternatives that the principal likes more than the new alternative. A similar trade-off arises when removing an alternative from the menu. These trade-offs prevent a dominance relationship between mechanisms that allocate the principal's most preferred alternative.

As before, given the characterization of undominated mechanism above, the same arguments as in Section 7 can be applied to conclude that the extreme points are dense in the set of undominated mechanisms whenever there are four or more alternatives. The claim about uniquely optimal mechanisms again requires additional arguments.

Theorem 8.7. *Consider the linear veto bargaining problem:*

- (1) *With $m = 3$ alternatives, a mechanism $x \in \mathcal{X}$ is undominated and in $\text{ext } \mathcal{X}$ if and only if $\text{menu}(x)$ contains the veto alternative, the principal's most preferred alternative, and at most one other lottery over the alternatives.*
- (2) *With $m \geq 4$ alternatives, the set of mechanisms $x \in \mathcal{X}$ that are uniquely optimal for some belief $\mu \in \Delta(\Theta)$ is dense in the set of undominated mechanisms.*

Proof. See Appendix D.5. □

9. RELATED LITERATURE

This paper relates to several areas of research, including multi-dimensional screening, extreme points in mechanism design, delegation and veto bargaining, and the mathematical literature on indecomposability. We will explain the relation to these four areas after first discussing Manelli and Vincent (2007), whose work most closely relates to ours.

9.1. Manelli and Vincent (2007) (MV). In the context of the multi-good monopoly problem, MV provide the first—and, prior to this paper, only—analysis of extreme points in multi-dimensional mechanism design, with two main contributions. First, they provide an algebraic characterization of finite-menu extreme points in terms of whether or not a certain linear system associated with a given mechanism has a unique solution. This characterization is based on auxiliary results about the facial structure of the set of incentive-compatible mechanisms. Second, they define the notion of undominated mechanisms and show that every undominated mechanism maximizes expected revenue for some distribution of types.

In comparison to MV, we consider arbitrary linear screening problems with or without transfers and subsume the multi-good monopoly problem as a special case. We contribute explicit, non-algebraic extreme-point characterizations (Section 6). These characterizations reveal the precise structure of the set of extreme points and, therefore, the structure of the possible solutions to linear screening problems. Along the way, we obtain generalizations of MV's results in our more general framework; see Appendix B and Theorem 8.2.

In comparison to MV, we also characterize undominated extreme points and uniquely optimal mechanisms. While MV show for the monopoly problem that all undominated

mechanisms are potentially optimal, it has not been known which undominated mechanisms are necessary candidates for optimality, i.e., which extreme points are undominated and uniquely optimal for some type distribution. A priori, one might conjecture that parsimonious candidate sets are significantly smaller than the set of undominated mechanisms. We show that this is not the case: the relevant exposed points are dense in the set of undominated mechanisms. Moreover, we provide new results about undominated mechanisms, showing that these mechanisms are themselves virtually as rich as the set of all IC and IR mechanisms.

Finally, we note that MV have shown for the monopoly problem, modulo minor details, that the extreme points of menu size $k \in \mathbb{N}$ are relatively open and dense in the IC mechanisms of menu size k , provided k is smaller than the number of goods for sale plus one (their Remark 25). We show that this substantial qualifier on k is not necessary and that the result holds for arbitrary multi-dimensional screening problems with linear utility (Theorem 6.4).

9.2. Multi-dimensional Screening and Mechanism Design. The literature on multi-dimensional screening—and on the multi-good monopoly problem in particular—is much too large to be summarized here in detail. We focus on recent developments and point to a survey by Rochet and Stole (2003) for work up to the early 2000s.²⁹

Recent work focuses mostly on the multi-good monopoly problem and can be classified into several approaches for gaining insights into multi-dimensional screening problems or for circumventing the severe difficulties associated with their classical formulations:

- provide conditions for the optimality of common mechanisms such as separate sales or bundling (McAfee et al., 1989; Manelli and Vincent, 2006; Fang and Norman, 2006; Pavlov, 2011; Daskalakis et al., 2017; Menicucci et al., 2015; Bergemann et al., 2021; Haghpanah and Hartline, 2021; Ghili, 2023; Yang, 2023);
- provide duality results that can be used to certify the optimality of a given mechanism (Daskalakis et al., 2017; Kleiner and Manelli, 2019; Cai et al., 2019; Kolesnikov et al., 2022; Kleiner, 2022);
- identify specific structural properties of optimal mechanisms (e.g., subadditive pricing, monotonicity, no randomization) and show when such structure arises (McAfee et al., 1989; Manelli and Vincent, 2006; Hart and Reny, 2015; Babaioff et al., 2018; Ben-Moshe et al., 2022; Bikhchandani and Mishra, 2022);
- quantify the worst-case performance (approximation ratio) of common mechanisms or classes of mechanisms (Hart and Nisan, 2017; Hart and Nisan, 2019; Li and Yao, 2013; Babaioff et al., 2017; Rubinstein and Weinberg, 2018; Hart and Reny, 2019; Babaioff et al., 2020; Ben-Moshe et al., 2022);
- identify mechanisms with the optimal worst-case performance for a mechanism designer with Knightian uncertainty over the set of type distributions (Carroll, 2017; Deb and Roesler, 2023; Che and Zhong, 2023);
- derive asymptotic optimality results for a large number of i.i.d. goods (Armstrong, 1999; Bakos and Brynjolfsson, 1999) or for the speed of convergence to first-best as the principal gains increasingly precise information about the agent’s type (Frick et al., 2024).

Our paper is orthogonal to these developments. We do not focus on specific properties and classes of mechanisms or attempt to escape intractabilities. Instead, we shed light on

²⁹A sample of important early work includes Adams and Yellen (1976), Schmalensee (1984), McAfee et al. (1989), Wilson (1993), Armstrong (1996), and Rochet and Choné (1998).

where these intractabilities originate and identify the limits of the qualitative predictions that can be drawn within the standard Bayesian framework. Moreover, to the best of our knowledge, *multi-dimensional screening without transfers* has not been studied, with the exception of Kleiner (2022), whose duality approach to a multi-dimensional delegation problem is complementary to our extreme points approach.

Besides the implications for optimal mechanism design, we contribute to the literature on implementability with multi-dimensional type spaces (e.g., Rochet, 1987; Saks and Yu, 2005; Bikhchandani et al., 2006) by characterizing extreme points of the set of incentive-compatible mechanisms. By Choquet’s theorem, every non-extreme point can be represented as a mixture over extreme points.

In general, little is known about optimal multi-dimensional mechanism design with multiple agents (Palfrey, 1983; Jehiel et al., 1999; Chakraborty, 1999; Jehiel et al., 2007; Kolesnikov et al., 2022); see the conclusion for further discussion.

9.3. Extreme Points in Mechanism Design. A number of papers have approached mechanism design problems by studying the extreme points of the set of incentive-compatible mechanisms. However, aside from the previously discussed work by Manelli and Vincent (2007), this approach has only been applied to one-dimensional problems. For instance, Border (1991) uses extreme points—hierarchical allocations—in a characterization of the set of feasible interim allocation rules. Building on Border’s insights, Manelli and Vincent (2010) demonstrate the equivalence of Bayesian and dominant strategy incentive-compatibility in standard auction problems. A similar approach is discussed in Vohra (2011, Chapter 6).

Kleiner et al. (2021) present characterizations of the extreme points of certain majorization sets and show how these majorization sets naturally arise as feasible sets in many economic design problems. In the context of mechanism design, their results immediately imply a characterization of the extreme points of the set of feasible and incentive-compatible interim allocation rules in one-dimensional symmetric allocation problems, providing a new perspective on Border’s theorem as well as BIC-DIC equivalence. Their approach is tailored to one-dimensional problems, elegantly handling both the IC constraints (monotonicity for one-dimensional types) and the Maskin-Riley-Matthews-Border feasibility constraints (majorization with respect to the efficient allocation rule).

In subsequent work, Kleiner et al. (2024) characterize certain extreme points of the set of measures defined on a compact convex subset of \mathbb{R}^d that are dominated in the convex order by a given measure. Their result is a multi-dimensional analogue of results obtained in Kleiner et al. (2021) about the set of monotone functions that majorize a given monotone function (see also Arieli et al., 2023). These results apply to information design but have no obvious applications to mechanism design.

Nikzad (2022, 2024) builds on the majorization approach, allowing for additional constraints on the majorization sets. These constraints may, for example, correspond to fairness or efficiency constraints in a revenue-maximization problem. Yang and Zentefis (2024) provide a complementary analysis to Kleiner et al. (2021) based on characterizations of extreme points of sets of distributions characterized by first-order stochastic dominance conditions rather than second-order stochastic dominance conditions (majorization).

Extreme point approaches have also been used in mechanism design without transfers (e.g., Ben-Porath et al., 2014; Niemeier and Preusser, 2024), and several other mechanism design papers use extreme points as a technical tool (e.g., Chen et al., 2019).

9.4. Delegation and Veto Bargaining. Much of the literature on optimal delegation has focused on one-dimensional allocation (action) and type spaces with single-peaked preferences; see Holmström (1977, 1984), Melumad and Shibano (1991), Martimort and Semenov (2006), Alonso and Matouschek (2008), Amador and Bagwell (2013), Kolotilin and Zapechelnuyk (2019), and Kleiner et al. (2021).

The applications of our results to delegation differ from the classical literature in two ways. First, allocations in our delegation problem are lotteries over finitely many alternatives.³⁰ Second, both the principal and agent have arbitrary vNM preferences over these alternatives; that is, our problem features an unrestricted rather than single-peaked preference domain and therefore multi-dimensional types (and allocations). We can allow more general allocation spaces, provided the agent’s utility remains linear.

A small number of papers consider multi-dimensional type or allocation spaces. Koessler and Martimort (2012) study optimal delegation in a setting with a one-dimensional type space and two allocation dimensions across which the principal and the agent have separable quadratic preferences. Frankel (2016) links multiple independent, one-dimensional delegation problems. Frankel shows that “halfspace delegation,” i.e., imposing a quota on the weighted average of actions across problems, is optimal for normally distributed states and approximately optimal for general distributions as the number of linked problems goes to infinity. See also Frankel (2014) for a robust mechanism design approach. Kleiner (2022) studies optimal delegation with both multi-dimensional type and allocation spaces. Kleiner’s duality-based approach is complementary to our extreme-point approach.

Veto bargaining is a classical problem in political science, originally studied in Romer and Rosenthal (1978). The case with incomplete information about the agent’s (vetoer’s) preferences has only recently been studied using a mechanism design approach by Kartik et al. (2021).³¹ Their model features one-dimensional private information. Amador and Bagwell (2022) and Saran (2022) study related one-dimensional delegation problems with IR constraints where the principal does not necessarily have state-independent preferences.³² Similarly, our model can nest linear delegation problems with IR constraints.

9.5. Mathematical Foundations. Gale (1954) introduced the notion of an indecomposable convex body and announced the first results about indecomposability. Gale’s results were later proven and published in Shephard (1963), Meyer (1972)/Silverman (1973), and Sallee (1972). These and other papers have provided many novel results that go beyond Gale’s original presentation. McMullen (1973), Meyer (1974), and Smilansky (1987) provide algebraic characterizations of indecomposable polytopes. Smilansky (1987) discusses indecomposable polyhedra. Related results characterize extremal convex bodies within a given compact convex set in the plane (Grzaślewicz, 1984; Mielczarek, 1998); see Theorems 6.1 and C.1 for the application in our paper. Decomposability is related to *deformations* of polytopes, which we briefly use in Appendix B; Castillo and Liu (2022, Section 2) provide a concise treatment. Textbook references on indecomposability include Schneider (2014, Chapter 3.2), Pineda Villavicencio (2024, Chapter 6), and Grünbaum et al. (1967, Chapter 15).

³⁰Delegation over a finite set of alternatives is also studied in the project selection literature; see Armstrong and Vickers (2010), Nocke and Whinston (2013), Che et al. (2013a), and Guo and Shmaya (2023).

³¹See also Ali et al. (2023).

³²See also the “balanced” delegation problem in Kolotilin and Zapechelnuyk (2019).

Characterizations of indecomposable convex bodies can alternatively be seen, via support function duality, as characterizations of the extremal rays of the cone of sublinear (i.e. convex and homogeneous) functions. A subset of the results known in the literature on indecomposable convex bodies have been independently obtained in studies of the extremal rays of the cone of convex functions by Johansen (1974) (for two-dimensional domains) and Bronshtein (1978) (for d -dimensional domains).³³

We finally mention a result due to Klee (1959, Proposition 2.1, Theorem 2.2), which shows that for most (in the sense of topological genericity) compact convex subsets of an infinite-dimensional Banach space, the extreme points of the set are dense in the set itself. This follows since such sets have an empty interior, support points are dense in the boundary, hence in the set itself, and since most such sets are strictly convex, so that every support point is an extreme point. However, the set of IC mechanisms is a *specific* compact convex subset of an infinite-dimensional Banach space, which, in particular, is *not* strictly convex. The content of our results is that whenever the type space is multi-dimensional, the extreme points are nevertheless dense *in a certain part* of the set.

10. CONCLUSION

We have characterized extreme points of the set of incentive-compatible (IC) mechanisms for screening problems with linear utility. For every problem with one-dimensional types, extreme points admit a simple characterization with a tight upper bound on their menu size. In contrast, for every problem with multi-dimensional types, we have identified a large set of IC mechanisms—exhaustive mechanisms—in which the extreme and exposed points lie dense. Consequently, one-dimensional problems allow us to make predictions that are independent of the precise details of the environment, whereas such predictions are largely unattainable for multi-dimensional problems.

One might hope that restricting attention to specific instances of a given multi-dimensional screening problem allows more robust predictions regarding optimality. We have shown that such predictions remain elusive in applications to monopoly and veto bargaining problems, where the principal’s objective is fixed and state-independent and only the principal’s belief about the agent’s type is considered a free parameter.

While our focus has been on screening problems, where there is only a single (representative) agent, one should expect implications of our results for multi-agent settings. In multi-agent settings, Bayesian incentive compatibility of a given multi-agent mechanism is the same as separately requiring incentive compatibility with respect to each agent’s interim-expected mechanism (see, e.g., Börgers, 2015, Chapter 6). These interim-expected mechanisms, one for each agent, must then be linked towards an ex-post feasible mechanism via an appropriate analogue of the Maskin-Riley-Matthews-Border conditions.³⁴ Thus, if the extreme points in a multi-agent problem were simpler than the extreme points characterized here for the one-agent case, then this reduction in complexity would have to come from these additional conditions. This is not the case for problems with one-dimensional types (see, e.g., Kleiner et al., 2021) and is not to be expected for problems with multi-dimensional types.

³³We thank Andreas Kleiner for pointing us to these references.

³⁴Maskin and Riley (1984), Matthews (1984), Border (1991). Recent treatments include Che et al. (2013b), Gopalan et al. (2018), and Valenzuela-Stookey (2023); see these papers for further references and discussions of potential limitations of the reduced-form approach.

Our main methodological contribution is to link extreme points of the set of incentive-compatible mechanisms to indecomposable convex bodies studied in convex geometry. This methodology, where we study incentive-compatible mechanisms by analyzing the space of all menus from which the agent could choose, is potentially useful in other areas of economic theory. Examples that come to mind are menu choice à la Dekel et al. (2001) and the random expected utility (REU) model of Gul and Pesendorfer (2006).

APPENDIX A. PRELIMINARIES & AUXILIARY RESULTS

This appendix gathers general tools we use throughout the proofs of our results from the main text. Appendix A.1 shows that there are bijections between mechanisms, menus, and indirect utility functions that commute with convex combinations (in the sense of Minkowski). The commutativity with convex combinations is essential for our subsequent analysis because we will study extremal menus and then translate back to extremal mechanisms, as explained in Section 7. Appendix A.2 introduces the relevant topological structure for the three sets of objects. Appendix A.3 discusses how individual rationality (IR) constraints are incorporated into our analysis.

A.1. Mechanisms, Menus, and Indirect Utility Functions. Recall that we have identified payoff-equivalent mechanisms and that \mathcal{X} is the set of payoff-equivalence classes of (IC) and (IR) mechanisms.

Let

$$\mathcal{U} = \{U : \theta \mapsto x(\theta) \cdot \theta \mid x \in \mathcal{X}\}$$

denote the set of all indirect utility functions induced by the mechanisms in \mathcal{X} . It is a direct consequence of (IC) that an indirect utility function is HD1 (homogeneous of degree 1) on cone Θ because types on the same ray from the origin have the same ordinal preferences. Thus, we extend indirect utility functions $U \in \mathcal{U}$ to \mathbb{R}^d by setting $U(\lambda\theta) = \lambda U(\theta)$ for all $\theta \in \Theta$ and $\lambda \geq 0$ and $U(z) = \infty$ for all $z \notin \text{cone } \Theta$.

A menu is simply a subset $M \subset A$ that the principal offers the agent and from which the agent chooses their favorite allocation. However, different menus can induce payoff-equivalent choice functions, i.e., payoff-equivalent IC mechanisms, for the agent. Thus, we define the notion of an *extended menu*, which is the inclusion-wise largest representative of a payoff-equivalence class of menus.

To define extended menus, let

$$\Theta^\circ = \{y \in \mathbb{R}^d \mid \forall \theta \in \Theta, y \cdot \theta \leq 0\} \tag{5}$$

denote the **polar cone** of Θ . The polar cone of type space is the set of all directions in allocation space A along which *no* type's utility ever strictly improves. If $\text{cone } \Theta = \mathbb{R}^d$, then the only such direction is the trivial direction 0. By definition, we may add to every menu $M \subset A$ the polar cone Θ° and instead offer the agent the Minkowski sum $M + \Theta^\circ$ without affecting the agent's indirect utility. We may also take the closed convex hull of M , which does not affect indirect utility either since utility is linear. By requiring $\underline{a} \in M$, i.e., the veto allocation is in M , we ensure that the agent does not veto the menu.

Definition A.1. *An **extended menu** is a closed convex set $M \subset \mathbb{R}^d$ such that $M = \text{conv ext } M + \Theta^\circ$, $\text{ext } M \subset A$, and $\underline{a} \in M$. The set of all extended menus is denoted by \mathcal{M} .*

If the type space is unrestricted, i.e., $\text{cone } \Theta = \mathbb{R}^d$, then extended menus are convex bodies in A ; otherwise, they are unbounded closed convex sets. That extended menus offer infeasible allocations when the type space is restricted has no physical meaning and is merely a convenient way to identify payoff-equivalent menus. We note that extended menus are uniquely pinned down by their extreme points.

Figure 5 illustrates the construction of extended menus. The depicted allocation and type spaces fit a one-good monopoly problem. The horizontal allocation dimension a_1 is the probability of sale, and the vertical allocation dimension a_2 is the payment. The type space

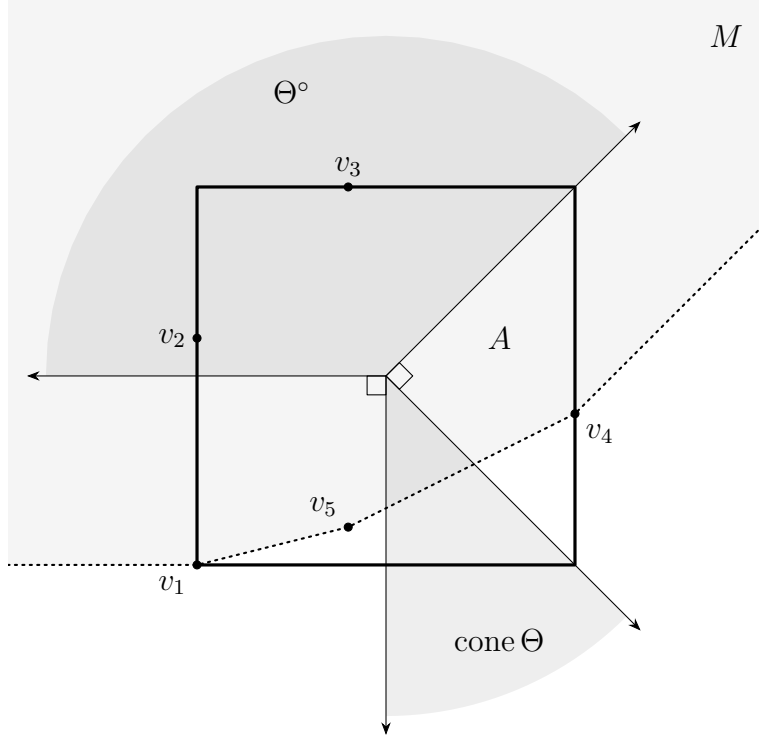

FIGURE 5. An example of an extended menu for a restricted type space. The type cone, $\text{cone } \Theta$, is the 45° cone, shaded in dark gray. The polar cone Θ° is the 135° cone, also shaded in dark gray and with extremal rays that are orthogonal to the extremal rays of cone Θ . The allocation space A is the square. An exemplary menu $\{v_1, v_2, v_3, v_4, v_5\}$ is depicted using dots. Its extension is the polyhedron M shaded in light gray and with boundary given by the dotted lines. M is obtained by taking the convex hull of $\{v_1, v_2, v_3, v_4, v_5\}$ and adding the polar cone Θ° . Here, v_2 and v_3 “vanish” in the polar cone because v_2 and v_3 are dominated by the other three allocations for every type in Θ .

is $\Theta = [0, 1] \times \{-1\}$, where the first component is the agent’s valuation for the good. The extremal rays of the polar cone Θ° are allocation directions in which (1) the agent gets the good with lower probability for the same payment, and (2) the agent gets the good with higher probability but for a marginal price that makes the type $(1, -1)$, who is willing to pay most, just indifferent. The extended menu M corresponds to a mechanism where some types never transact (v_1), some types buy a cheap lottery that sometimes allocates the good (v_5), and all other types buy the good with probability 1 at a more expensive price (v_4).

As in Section 7, we equip \mathcal{M} with the operations of Minkowski addition and positive scalar multiplication.

Theorem A.2. *The following functions are bijections that commute with convex combinations:*

- $\Phi_1 : \mathcal{X} \rightarrow \mathcal{M}$ where $x \mapsto (\text{conv menu}(x) + \Theta^\circ)$;
- $\Phi_2 : \mathcal{M} \rightarrow \mathcal{U}$ where $M \mapsto (\theta \mapsto \sup_{y \in M} y \cdot \theta)$;

- $\Phi_3 : \mathcal{U} \rightarrow \mathcal{X}$ where $U \mapsto \prod_{\theta \in \Theta} (\partial U(\theta) \cap A)$.³⁵

That is, Φ_1 maps (payoff-equivalence classes of) IC and IR mechanisms to the extension of their menus; Φ_2 maps extended menus to their support functions; Φ_3 maps indirect utility functions to their subdifferential.

Proof. Define an auxiliary map $\Phi'_1 : x \mapsto (\text{cl conv } x(\Theta) + \Theta^\circ)$, where $x : \Theta \rightarrow A$ is an IC and IR mechanism, and claim that $\Phi'_1(x) = M \in \mathcal{M}$. We have $\underline{a} \in M$ for otherwise there would exist a type that strictly prefers \underline{a} to $x(\Theta)$ by the linearity of utility and the definitions of the closed convex hull and the polar, which contradicts that x satisfies (IR). We also have

$$\text{ext } M = \text{ext}(\text{cl conv } x(\Theta) + \Theta^\circ) \subseteq \text{ext}(\text{cl conv } x(\Theta)) \subset A,$$

where the first inclusion follows since Θ° is a cone and the second inclusion follows since $x(\Theta) \subseteq A$ and A is compact and convex. Finally, M is closed and convex because it is a sum of a compact convex set and a closed convex set.

The map $\Phi_2 : \mathcal{M} \rightarrow \mathcal{U}$ is well-defined: for each $M \in \mathcal{M}$, its support function $\sup_{a \in M} a \cdot \theta$ is an indirect utility function in \mathcal{U} because $\arg \max_{a \in M} a \cdot \theta$ is non-empty for all $\theta \in \Theta$ and every selection from the argmax is an IC and IR mechanism.

We next show that $\Phi_2 \circ \Phi'_1$ is the map that assigns to each IC and IR mechanism x its indirect utility function $U \in \mathcal{U}$. Let $U \in \mathcal{U}$ be the indirect utility function associated with $x \in \mathcal{X}$. As desired, we have

$$U(\theta) = \begin{cases} \sup_{a \in x(\Theta)} a \cdot \theta = \sup_{y \in \text{cl conv } x(\Theta) + \Theta^\circ} y \cdot \theta = \sup_{y \in M} y \cdot \theta & \text{if } \theta \in \text{cone } \Theta \\ \infty = \sup_{y \in M} y \cdot \theta & \text{otherwise.} \end{cases}$$

In the first case, the first equality is (IC) and the second equality follows from the definitions of the closed convex hull and the polar cone. The second case also follows by definition of the polar cone.

The map $\Phi_2 : \mathcal{M} \rightarrow \mathcal{U}$ is injective because support functions uniquely determine closed convex sets (Hiriart-Urruty and Lemaréchal, 1996, Theorem V.2.2.2).

Thus, if x and x' are payoff-equivalent IC and IR mechanisms, then $\Phi'_1(x) = \Phi'_1(x')$ because Φ_2 is injective and $(\Phi_2 \circ \Phi'_1)(x) = (\Phi_2 \circ \Phi'_1)(x')$ (by the definition of payoff-equivalence). Thus, Φ'_1 can be defined on the set of payoff-equivalence classes \mathcal{X} in the obvious way.

$\Phi'_1 : \mathcal{X} \rightarrow \mathcal{M}$ and $\Phi_2 : \mathcal{M} \rightarrow \mathcal{U}$ are bijective because $\Phi_2 \circ \Phi'_1$ is bijective and Φ_2 is injective.

We next show that $\Phi_1 = \Phi'_1$. Let $x = (\Phi'_1)^{-1}(M) \in \mathcal{X}$ be any representative mechanism from the payoff-equivalence class associated with $M \in \mathcal{M}$. Then, $\text{exp } M \subseteq \text{menu}(x)$ since every mechanism x' that is payoff-equivalent to x must necessarily allocate to each type $\theta \in \Theta$ with a uniquely preferred option $a \in \text{exp } M$ that option. Moreover, $\text{menu}(x) \subseteq \text{cl ext } M$ because every type can find a favorite allocation in $\text{ext } M$. By Theorem 2.3 in Klee (1959), $\text{ext } M \subseteq \text{cl exp } M \subseteq \text{menu}(x)$ since $\text{menu}(x)$ is compact. Thus, $\text{menu}(x) = \text{cl ext } M$. Consequently, $M = \text{conv menu}(x) + \Theta^\circ$ since M is closed, as desired.

We next verify that the inverse of the composition $\Phi_2 \circ \Phi_1 : \mathcal{X} \rightarrow \mathcal{U}$ is given by $\Phi_3 : \mathcal{U} \rightarrow \mathcal{X}$. Take any (IC) and (IR) mechanism x with associated extended menu $M \in \mathcal{M}$ and associated

³⁵ $\partial U(\theta)$ denotes the subdifferential of U at $\theta \in \Theta$. The proof and Corollary A.4 below confirm that the subdifferential of an indirect utility function $U \in \mathcal{U}$ is well-defined because U is convex.

indirect utility function $U \in \mathcal{U}$. For all $\theta \in \Theta$, we have

$$x(\theta) \in \arg \max_{a \in x(\Theta)} a \cdot \theta \subseteq \arg \max_{a \in M} a \cdot \theta = \partial U(\theta),$$

where the first step is (IC), the second step is immediate from the definition of M , and the third step is a property of support functions (Rockafellar and Wets, 2009, Corollary 8.2.5).

It remains to show commutativity with convex combinations. That $\Phi_2 : \mathcal{M} \rightarrow \mathcal{U}$ commutes with convex combinations is a property of support functions (Hiriart-Urruty and Lemaréchal, 1996, Theorem V.3.3.3).³⁶ That $\Phi_3 : \mathcal{U} \rightarrow \mathcal{X}$ commutes with convex combinations follows from the linearity of the gradient map, which is almost everywhere well-defined. Thus, $\Phi_1 : \mathcal{X} \rightarrow \mathcal{M}$ must also commute with convex combinations. \square

Theorem A.2 is fundamental to our approach because the bijections between \mathcal{X} , \mathcal{U} , and \mathcal{M} map extreme points to extreme points.³⁷ We prove our main results by investigating the extreme points of \mathcal{M} . Occasionally, however, we shall work with mechanisms or indirect utility functions, if this simplifies our arguments.

We say that (x, M, U) are **associated** if they are isomorphic in the sense of Theorem A.2.

Given Theorem A.2, the definitions of (positive) homothety and exhaustiveness straightforwardly extend from \mathcal{X} to \mathcal{M} and \mathcal{U} . For example, if $x \in \mathcal{X}$ with associated $M \in \mathcal{M}$, then

$$\mathcal{F}(M) := \mathcal{F}(x) = \{H \in \mathcal{F} \mid H \cap \text{ext } M \neq \emptyset\}. \quad (6)$$

We note a few corollaries of Theorem A.2.

Corollary A.3. *Let $x \in \mathcal{X}$ and $M \in \mathcal{M}$ be associated. Then, $\text{menu}(x) = \text{cl ext } M$.*

We have proven this claim as part of the proof of Theorem A.2. Note that $\text{ext } M$ is closed if $\text{ext } M$ is finite or $d = 2$.

The following characterization of indirect utility functions is analogous to the one by Rochet (1987, Proposition 2) for settings with transfers.

Corollary A.4. *$U \in \mathcal{U}$ if and only if the following conditions are satisfied:*

- (1) U is sublinear (i.e., convex and HD1).
- (2) U is continuous on its effective domain $\text{cone } \Theta = \{z \in \mathbb{R}^n : U(z) < \infty\}$.
- (3) For all $\theta \in \text{cone } \Theta$, $U(\theta) \geq \underline{a} \cdot \theta$.
- (4) For all $\theta \in \text{cone } \Theta$, $\text{ext } \partial U(\theta) \subset A$.

Proof. By the previous result, $U \in \mathcal{U}$ is the support function of an extended menu $M \in \mathcal{M}$. Conversely, every closed sublinear function $\mathbb{R}^d \rightarrow \mathbb{R} \cup \{\infty\}$ is the support function of a closed convex set. (A sublinear function that is continuous on a closed effective domain is closed.)

It remains to show that the remaining properties hold if and only if $M \in \mathcal{M}$. The effective domain of a sublinear function (in our case: $\text{cone } \Theta$) and the recession cone of the associated closed convex set (in our case: Θ°) are mutually polar cones (Hiriart-Urruty and Lemaréchal, 1996, Proposition V.2.2.4). Continuity comes for free since $\text{cone } \Theta$ is polyhedral (Rockafellar, 1997, Theorem 10.2). It is easy to see that (3) holds if and only if $\underline{a} \in M$ (Hiriart-Urruty

³⁶Remark on the cited theorem: in general, the sum of two closed convex sets need not be closed, but it is always closed if the two sets have the same recession cone, which is here Θ° .

³⁷Extreme points are usually only defined for convex subsets of vector spaces, which \mathcal{M} is not. However, we can embed \mathcal{M} into a vector space by Theorem A.2, which justifies the use of the term “extreme point.”

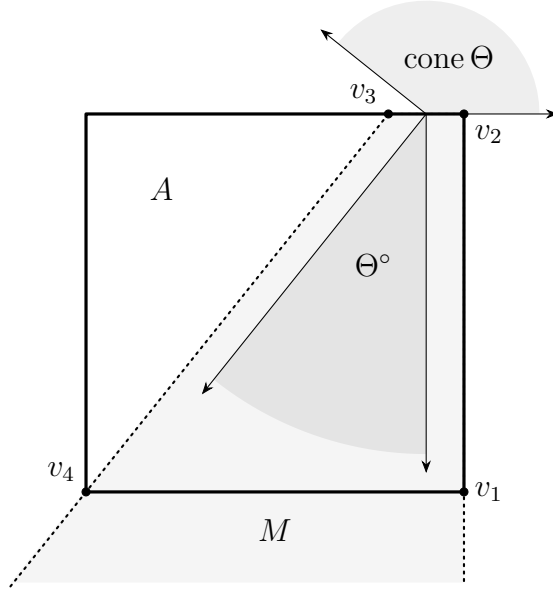

FIGURE 6. The extended menu $M = \text{conv}\{v_2, v_3\} + \Theta^\circ$ of a mechanism x that can be decomposed pointwise almost everywhere, i.e., up to payoff-equivalence, but not pointwise everywhere. Define x as follows: assign to each type in the interior of cone Θ their favorite allocation between v_2 and v_3 and to the types on the extremal rays of cone Θ the allocations v_1 and v_4 . M can be decomposed by translating the vertex v_3 horizontally; thus x can be decomposed up to payoff-equivalence, i.e., pointwise almost everywhere. However, x cannot be decomposed pointwise everywhere.

and Lemaréchal, 1996, Proposition V.2.2.4). Finally, $\text{ext } M \subset A$ if and only if $\text{ext } \partial U(\theta) \subset A$ for all $\theta \in \Theta$ follows from Corollary 8.2.5 in Rockafellar and Wets (2009). \square

We also note the following sanity check that almost everywhere equivalence indeed coincides with payoff-equivalence for (IC) and (IR) mechanisms. This justifies modeling the set \mathcal{X} of payoff-equivalence classes of mechanisms in L^1 .

Corollary A.5. *Let x and x' be mechanisms that satisfy (IC) and (IR). Then, x and x' are payoff-equivalent if and only if $x = x'$ almost everywhere.*

Proof. If x and x' are payoff-equivalent, then there exists an indirect utility function $U \in \mathcal{U}$ such that $x, x' \in \partial U$ by Theorem A.2. Thus, $x = x'$ almost everywhere since the subdifferential of a convex function is almost everywhere a singleton. Conversely, suppose $x = x'$ almost everywhere. Let $x \in \partial U$ and $x' \in \partial U'$. Then, $\nabla U = \nabla U'$ almost everywhere. Thus, $U = U' + c$ for $c \in \mathbb{R}$, and $c = 0$ because U and U' are sublinear. Thus, x and x' are payoff-equivalent. \square

Remark. We briefly comment on a subtle difference between extreme points of the set of *payoff-equivalence classes* of IC and IR mechanisms, i.e., $\text{ext } \mathcal{X}$, versus extreme points of the set of IC and IR *mechanisms* themselves. For the former, a mechanism is an extreme point if it does not coincide with a convex combination of two other mechanisms up to payoff-equivalence, i.e., for *almost every* type. For the latter, a mechanism is an extreme point if it does not coincide with a convex combination of two other mechanisms for *every* type. For an extremal equivalence class with associated indirect utility function $U \in \text{ext } \mathcal{U}$, every element of $\prod_{\theta \in \Theta} \text{ext}(\partial U(\theta) \cap A)$ is an extreme point of the set of (IC) and (IR) mechanisms.

There can exist additional extreme points of the set of (IC) and (IR) mechanisms such that their payoff-equivalence classes are not extreme points of the set of payoff-equivalence classes \mathcal{X} . These additional extreme points can only exist if the type space Θ is restricted and only if types on the boundary of cone Θ break ties to the boundary of A ; see Figure 6 for an example. Since we assume that the prior distribution μ is absolutely continuous, these additional extreme points are irrelevant for optimality.

A.2. Topologies and Compactness. We now define topologies on the three sets, \mathcal{X} , \mathcal{M} , and \mathcal{U} , discuss the relation between these topologies, and show that the three sets are compact under their respective topologies.

We equip the set \mathcal{X} of payoff-equivalence classes of mechanisms with the L_1 -norm

$$\|x\| = \int_{\Theta} \|x(\theta)\| d\theta. \quad (7)$$

We equip the set \mathcal{U} of indirect utility functions with the sup-norm

$$\|U\| = \sup_{\theta \in \text{cone } \Theta: \|\theta\| \leq 1} U(\theta). \quad (8)$$

We equip the set \mathcal{M} of extended menus with the Hausdorff distance

$$d(M, M') = \inf \{ \varepsilon > 0 : M \subseteq M' + \varepsilon B \text{ and } M' \subseteq M + \varepsilon B \}, \quad (9)$$

where $B = \{z \in \mathbb{R}^d : \|z\| \leq 1\}$ is the unit ball in \mathbb{R}^d .

Thus, $(\mathcal{X}, \|\cdot\|)$ and $(\mathcal{U}, \|\cdot\|)$ are normed spaces.³⁸ We also have:

Lemma A.6. *(\mathcal{M}, d) is a metric space and $d(M, M') \leq d(\text{conv ext } M, \text{conv ext } M')$.*

Proof. We have

$$\begin{aligned} d(M, M') &= \inf \{ \varepsilon > 0 : M \subseteq M' + \varepsilon B \text{ and } M' \subseteq M + \varepsilon B \} \\ &= \inf \left\{ \varepsilon > 0 : \begin{array}{l} \text{conv ext } M + \Theta^\circ \subseteq \text{conv ext } M' + \Theta^\circ + \varepsilon B \text{ and} \\ \text{conv ext } M' + \Theta^\circ \subseteq \text{conv ext } M + \Theta^\circ + \varepsilon B \end{array} \right\} \\ &\leq \inf \left\{ \varepsilon > 0 : \begin{array}{l} \text{conv ext } M \subseteq \text{conv ext } M' + \varepsilon B \text{ and} \\ \text{conv ext } M' \subseteq \text{conv ext } M + \varepsilon B \end{array} \right\} \\ &= d(\text{conv ext } M, \text{conv ext } M'), \end{aligned}$$

where the inequality is because $Z_1 \subseteq Z_2$ implies $Z_1 + Z_3 \subseteq Z_2 + Z_3$ for $Z_1, Z_2, Z_3 \subset \mathbb{R}^d$.

It remains to show that (\mathcal{M}, d) is a metric space. Since $\text{conv ext } M, \text{conv ext } M' \subseteq A$, we have $d(M, M') \leq d(\text{conv ext } M, \text{conv ext } M') < \infty$. Thus, d is a metric on \mathcal{M} since extended

³⁸For $(\mathcal{X}, \|\cdot\|)$, recall that payoff-equivalent mechanisms are almost everywhere equal by Corollary A.5.

menus are closed and since the Hausdorff distance is an extended metric on the space of all closed subsets of \mathbb{R}^n . \square

The topologies on \mathcal{U} and \mathcal{M} are equivalent and finer than the topology on \mathcal{X} .

Lemma A.7. *Consider sequences $(x_n)_{n \in \mathbb{N}} \subset \mathcal{X}$, and $(M_n)_{n \in \mathbb{N}} \subset \mathcal{M}$, $(U_n)_{n \in \mathbb{N}} \subset \mathcal{U}$ such that (x_n, M_n, U_n) are associated for all $n \in \mathbb{N}$. Then, the following hold:*

- (1) $M_n \rightarrow M$ if and only if $U_n \rightarrow U$.
- (2) If $U_n \rightarrow U$, then $x_n \rightarrow x$.

Proof. Claim (1) is Theorem 6 in Salinetti and Wets (1979). For claim (2), let $D_n \subset \text{cone } \Theta$ be the set of points where U_n is differentiable and let $D \subset \text{cone } \Theta$ be the set of points where U is differentiable. Let $D^* = D \cap \bigcap_{n \in \mathbb{N}} D_n$. Indirect utility functions are convex and therefore almost everywhere differentiable. Moreover, the countable union of nullsets is null; thus $\text{cone } \Theta \setminus D^*$ is null. Theorem VI.6.2.7 in Hiriart-Urruty and Lemaréchal (1996) implies that $\nabla U_n(\theta) \rightarrow \nabla U(\theta)$ for all $\theta \in \text{cone } \Theta \setminus D^*$. Moreover, by Theorem A.2, $x_n \rightarrow x$ pointwise almost everywhere. The Dominated Convergence Theorem implies convergence in L^1 . \square

The following lemma is crucial to apply Bauer's maximum theorem, Choquet's theorem, and the Straszewicz-Klee theorem, and hence for the interpretation of our results about extreme points.

Lemma A.8. *\mathcal{X} , \mathcal{M} , and \mathcal{U} are compact and convex.*

Proof. Convexity of \mathcal{X} is immediate because (IC) and (IR) are linear constraints and because A is convex. By Theorem A.2, \mathcal{M} and \mathcal{U} are also convex.

For compactness, consider any sequence $\{M_n\}_{n \in \mathbb{N}} \subset \mathcal{M}$. By Blaschke's selection theorem, $\{\text{cl conv ext } M_n\}_{n \in \mathbb{N}}$ has a convergent subsequence $\{\text{cl conv ext } M_{n_k}\}_{k \in \mathbb{N}}$ with compact convex limit $K \subseteq A$. Let $M = K + \Theta^\circ$. It is readily verified that $M \in \mathcal{M}$. By Lemma A.6, the subsequence $\{M_{n_k}\}_{k \in \mathbb{N}}$ converges to $M \in \mathcal{M}$. Thus, \mathcal{M} is compact. By Lemma A.7, \mathcal{X} and \mathcal{U} are also compact. \square

A.3. Individual Rationality (IR). The following result is an analogue of the familiar observation in mechanism design with transfers that if IR holds for "the lowest type," then IR holds for every type. In our setting, however, a "lowest type" need not exist and is instead a type $\underline{\theta} \in \Theta$ who likes the veto allocation most, i.e., $\underline{a} \in \arg \max_{a \in A} a \cdot \underline{\theta}$.

Lemma A.9. *Suppose $x = \lambda x' + (1 - \lambda)x''$ almost everywhere, where x, x', x'' are (IC) mechanisms and $\lambda \in (0, 1)$. If x satisfies (IR), then x' and x'' satisfy (IR).*

Thus, the extreme points of the set of (IC) and (IR) mechanisms are simply the extreme points of the set of (IC) mechanisms that satisfy (IR).

Proof. Let

$$\Theta^* = \{\theta \in \Theta \mid \underline{a} \in \arg \max_{a \in A} a \cdot \theta\}$$

be the set of types who like the veto allocation most. We have assumed in Section 3 that Θ^* is non-empty.

Let

$$f^* = \bigcap_{\theta \in \Theta^*} \arg \max_{a \in A} a \cdot \theta.$$

Since A is a polytope, f^* is a face of A . If x is an (IC) and (IR) mechanism, then $x(\Theta) \cap f^* \neq \emptyset$.

Since f^* is a face of A , if $x = \lambda x' + (1 - \lambda)x''$ for (IC) mechanisms x', x'' and $\lambda \in (0, 1)$, then $x'(\Theta) \cap f^* \neq \emptyset$ and $x''(\Theta) \cap f^* \neq \emptyset$.

For the sake of contradiction, suppose x' does not satisfy (IR). Then, $\underline{a} \cdot \theta > x'(\theta) \cdot \theta$ for some $\theta \in \Theta$. By (IC), $x'(\theta) \cdot \theta \geq a^* \cdot \theta$ for $a^* \in x'(\Theta) \cap f^*$. Thus, $\underline{a} \cdot \theta > a^* \cdot \theta$, which contradicts the definition of f^* . Thus, x' satisfies (IR). Analogously, x'' satisfies (IR). \square

APPENDIX B. EXTREME POINTS OF FINITE-MENU MECHANISMS AND DEFORMATIONS

This appendix characterizes for any given IC mechanism with finite menu size the set of all IC mechanisms that make an inclusion-wise larger set of IC constraints binding. This set is important in our analysis: whenever an IC mechanism can be written as a convex combination of two other IC mechanisms, then these two mechanisms must make at least the same incentive constraints binding as the given mechanism.

We use this characterization to prove Theorem 4.1 and Theorem C.1. Moreover, we can use the characterization to generalize results by Manelli and Vincent (2007, Theorems 17, 19, 20, and 24) (MV) to arbitrary linear screening problems. In particular, we get an algebraic characterization of finite-menu extreme points (Theorem B.6). We discuss the exact relation to MV at the end of this section.

Throughout this section, we restrict attention to extended menus $M \in \mathcal{M}$ of finite size, i.e., $|\text{ext } M| < \infty$. Let $\mathcal{M}^{\text{Fin}} \subset \mathcal{M}$ denote the set of all extended menus of finite size. These are polyhedra since they can be written as the convex hull of their extreme points plus the polar of the type space (which is a polyhedral cone). In light of Lemma A.9, we can ignore IR constraints. We make two closely connected definitions.

Definition B.1. *The **normal fan** \mathcal{N}_M of an extended menu $M \in \mathcal{M}^{\text{Fin}}$ is the collection $\{NC_f\}$ of the normal cones*

$$NC_f = \{\theta \in \text{cone } \Theta \mid f \subseteq \arg \max_{a \in M} a \cdot \theta\}$$

*to the faces f of M . The normal fan $\mathcal{N}_{M'}$ is **coarser** than the normal fan \mathcal{N}_M , denoted $\mathcal{N}_{M'} \preceq \mathcal{N}_M$, if each normal cone in $\mathcal{N}_{M'}$ is a union of some set of normal cones in \mathcal{N}_M .*

Since the agent has linear utility, the set of each type's most preferred alternatives is a face of M . The normal fan hence summarizes which types' most preferred alternatives lie on which faces of the extended menu. The normal fan yields a polyhedral subdivision of the type space; the cells of maximal dimension have been called *market segments* by MV in the context of the monopoly problem.³⁹

For the next definition, we define the set of facet-defining hyperplanes of an extended menu $M \in \mathcal{M}^{\text{Fin}}$, which requires some care when M is not d -dimensional. For each facet F_i of M , there is a unique outer normal vector $n_i \in (\text{aff } M - a)^\circ$, where $a \in M$ is arbitrary, and a constant $c_i \in \mathbb{R}$ such that $F_i = M \cap H_i$ and $M \subseteq H_{i,-}$, where $H_i = \{z \in \mathbb{R}^d : z \cdot n_i = c_i\}$ is the facet-defining hyperplane and $H_{i,-} = \{z \in \mathbb{R}^d : z \cdot n_i \leq c_i\}$ is the facet-defining halfspace.

³⁹Subdivisions obtained from normal fans of polyhedra have appeared elsewhere in economic design as power diagrams (Frongillo and Kash, 2021; Kleiner et al., 2024) and as regular polyhedral complexes (Baldwin and Klemperer, 2019; Tran and Yu, 2019; Bedard and Goeree, 2023). They are also relevant in the context of the random expected utility model (Gul and Pesendorfer, 2006). See Doval et al. (2024) for another recent application.

Let \mathcal{H}_M be the union of the set of facet-defining hyperplanes of M with an arbitrary finite set of hyperplanes with corresponding halfspaces whose intersection is aff M . For brevity, we refer to \mathcal{H}_M as the set of facet-defining hyperplanes of M (although some of these define the improper face M).

Definition B.2. An extended menu $M' \in \mathcal{M}$ is a **deformation** of $M \in \mathcal{M}^{Fin}$ with $\mathcal{H}_M = \{H_1, \dots, H_k\}$ if there exist a **deformation vector** $c' = (c'_1, \dots, c'_k) \in \mathbb{R}^k$ such that the following two conditions are satisfied:

- (1) $M' = \cap_{i=1}^k H'_{i,-}$, where $H'_{i,-} = \{z \in \mathbb{R}^d : z \cdot n_i \leq c'_i\}$.
- (2) If $\cap_{i \in I} H_i = \{a\}$ for $I \subseteq \{1, \dots, k\}$ and $a \in \text{ext } M$, then there exists $a' \in \text{ext } M'$ such that $\cap_{i \in I} H'_i = \{a'\}$.

Let $\text{Def}(M) \subset \mathcal{M}$ denote the set of deformations of M .

That is, (1) M' can be defined by translates of the facet-defining halfspaces of M , not all of which necessarily remain facet-defining, and (2) if some subset of the facet-defining hyperplanes of M defines a vertex of M , then the translated hyperplanes also define a vertex of M' . See Figure 1 for an illustration, where the right-most facet-defining hyperplane of the menu is translated horizontally, yielding two deformations. (The left panel of Figure 7 in Appendix D.3 is another illustration). This definition of deformations is due to Castillo and Liu (2022, Definition 2.2), except here adapted to polyhedra rather than polytopes.

Remark. There is a bijection between deformations $M' \in \text{Def}(M)$ and deformation vectors c' given by

$$c'_i = \max_{a \in M'} n_i \cdot a, \quad \forall i = 1, \dots, k$$

since every hyperplane H'_i in the definition of M' must support M' by condition (2). By condition (1), this bijection commutes with convex combinations.

Lemma B.3. Let $x, x' \in \mathcal{X}$ be finite menu mechanisms with associated extended menus $M, M' \in \mathcal{M}^{Fin}$. The following are equivalent:

- (1) $\mathcal{IC}(x) \subseteq \mathcal{IC}(x')$.
- (2) $\mathcal{N}_{M'} \preceq \mathcal{N}_M$.
- (3) M' is a deformation of M .
- (4) There exists a surjective map $\varphi : \text{ext } M \rightarrow \text{ext } M'$ such that for every edge⁴⁰ \overline{ab} of M there exists $\lambda_{ab} \in \mathbb{R}_+$ such that $\lambda_{ab}(a - b) = \varphi(a) - \varphi(b)$.

The lemma says that coarsening the normal fan is the geometric analogue of making inclusion-wise more incentive constraints binding. Deformations are exactly the operations on extended menus that coarsen the normal fan. The fourth condition is an equivalent formulation of deformations in terms of parallel edges and more readily reveals the algebraic nature of deformations.

Proof. For the proof, we will need the following basic observation about normal cones. For an extended menu $M \in \mathcal{M}^{Fin}$ with $\mathcal{H}_M = \{H_1, \dots, H_k\}$ and a face f of M , let $I_f = \{1 \leq i \leq k \mid f \subseteq H_i\}$ denote the set of facet-defining hyperplanes of M containing the face f . For every face f of M , we have:

$$NC_f = \text{cone}\{n_i\}_{i \in I_f}. \tag{10}$$

In particular, $\dim NC_f = d - \dim f$.

⁴⁰One-dimensional face. $\overline{ab} = \text{conv}\{a, b\}$.

We define

$$\begin{aligned} NC_\theta &:= NC_{\arg \max_{a \in M} a \cdot \theta} \\ NC'_\theta &:= NC_{\arg \max_{a \in M'} a \cdot \theta}. \end{aligned}$$

NC_θ and NC'_θ are the inclusion-wise smallest normal cones of M and M' , respectively, to which θ belongs. By definition, $\mathcal{N}_M = \{NC_\theta\}_{\theta \in \Theta}$ and $\mathcal{N}_{M'} = \{NC'_\theta\}_{\theta \in \Theta}$.

We also make the following preliminary observation: for all $\theta, \tilde{\theta} \in \text{int cone } \Theta$,

$$(\theta, \tilde{\theta}) \in \mathcal{IC}(x) \iff \arg \max_{a \in M} a \cdot \theta \supseteq \arg \max_{a \in M'} a \cdot \theta \iff NC_\theta \subseteq NC_{\tilde{\theta}} \quad (11)$$

because $\text{menu}(x) = \text{ext } M$ and $\text{menu}(x') = \text{ext } M'$ (Corollary A.3), a bounded face of polyhedron is the convex hull of some set of its extreme points, every type $\theta \in \text{int cone } \Theta$ is normal to a bounded face of M and M' , and normal cones are dual to faces and, therefore, reverse the inclusion.

(1) \implies (2). By (10), if $\mathcal{IC}(x) \subseteq \mathcal{IC}(x')$ and $\theta, \tilde{\theta} \in \text{int cone } \Theta$, then $NC_\theta \subseteq NC_{\tilde{\theta}}$ implies $NC'_\theta \subseteq NC'_{\tilde{\theta}}$. In particular, $\theta \in NC_{\tilde{\theta}}$ implies $\theta \in NC'_{\tilde{\theta}}$. Thus, every cone in \mathcal{N}_M that meets $\text{int cone } \Theta$ is a subset of a cone in $\mathcal{N}_{M'}$. Every cone in \mathcal{N}_M that is contained in the boundary of cone Θ is also a subset of a cone in $\mathcal{N}_{M'}$ because it is a subset of a full-dimensional cone in \mathcal{N}_M , which meets $\text{int cone } \Theta$. That the cones in \mathcal{N}_M are subsets of the cones in $\mathcal{N}_{M'}$ implies $\mathcal{N}_{M'} \preceq \mathcal{N}_M$ (Lu and Robinson, 2008, Proposition 2).

(2) \implies (3). We first show condition (1) in the definition of a deformation, i.e., M' can be defined using translates of the facet-defining halfspaces of M . First, since every cone in \mathcal{N}_M contains the orthogonal complement of $\text{aff } M - a$, where $a \in M$ is arbitrary, the same must be true for the cones in $\mathcal{N}_{M'}$. Thus, $\text{aff } M'$ must be contained in a translate of $\text{aff } M$ and therefore the same normal vectors used to define $\text{aff } M$ can be used to define $\text{aff } M'$. Second, $\mathcal{N}_{M'} \preceq \mathcal{N}_M$ implies that the cones in $\mathcal{N}_{M'}$ corresponding to the facets of M' are also cones in \mathcal{N}_M because these cones can only be written as the trivial union of themselves. Every such cone contains a unique normal vector in $\text{aff } M - a$, for arbitrary $a \in M$. Thus, the same normal vectors used to define M can be used to define M' , as desired.

We now show condition (2) in the definition of a deformation. Suppose $\bigcap_{i \in I} H_i = \{a\}$ for $I \subseteq \{1, \dots, k\}$ and $a \in \text{ext } M$. By (10), $\text{cone}\{n_i\}_{i \in I} \subseteq NC_{\{a\}}$. Since $NC_{\{a\}}$ is full-dimensional and $\mathcal{N}_{M'} \preceq \mathcal{N}_M$, there exists $a' \in \text{ext } M'$ such that $NC_{\{a\}} \subseteq NC_{\{a'\}}$. Thus, $\text{cone}\{n_i\}_{i \in I} \subseteq NC_{\{a'\}}$. Consequently, for all $i \in I$, there exists $c'_i = \max_{a \in M'} n_i \cdot a$ such that the hyperplane H'_i with normal n_i and constant c'_i supports M' at a' . In particular, $\bigcap_{i \in I} H'_i = \{a'\}$, as desired.

(3) \implies (4). It is immediate from condition (2) in the definition of deformations that there is a surjective map $\varphi : \text{ext } M \rightarrow \text{ext } M'$. Moreover, by condition (2), φ must map each edge e of M either to an edge e' of M' that is parallel to e or to a vertex of M' . This is because the hyperplanes of M defining e must intersect for M' in a translate of the line containing e .

(4) \implies (1). Suppose $M, M' \in \mathcal{M}^{\text{Fin}}$ have the properties stated in (4). Recall that $\text{menu}(x) = \text{ext } M$ and $\text{menu}(x') = \text{ext } M'$ by Corollary A.3. To show that $(\theta, \tilde{\theta}) \in \mathcal{IC}(x)$ implies $(\theta, \tilde{\theta}) \in \mathcal{IC}(x')$, it suffices to show that

$$\arg \max_{a \in \text{ext } M'} a \cdot \theta = \varphi \left(\arg \max_{a \in \text{ext } M} a \cdot \theta \right) \quad (12)$$

for all $\theta \in \Theta$.

Suppose $\tilde{a} \in \arg \max_{a \in \text{ext } M} a \cdot \theta$. Fix any $\hat{a} \in \text{ext } M$. By the simplex algorithm, there exists a sequence $(a_0, a_1, \dots, a_{n-1}, a_n)$ such that $a_0 = \hat{a}$, $a_n = \tilde{a}$, $\overline{a_i a_{i-1}}$ is an edge of M for all $i = 1, \dots, n$, and $(a_i - a_{i-1}) \cdot \theta \geq 0$ for all $i = 1, \dots, n$. Condition (4) implies that $(\varphi(a_i) - \varphi(a_{i-1})) \cdot \theta \geq 0$ for all $i = 1, \dots, n$. Since $\hat{a} \in \text{ext } M$ was arbitrary, $\varphi(\tilde{a}) \cdot \theta \geq \varphi(a) \cdot \theta$ for all $a \in A$. That is, $\varphi(\tilde{a}) \in \arg \max_{a \in \text{ext } M'} a \cdot \theta$.

Suppose $\tilde{a} \notin \arg \max_{a \in \text{ext } M} a \cdot \theta$. By the simplex algorithm, there exists a sequence $(a_0, a_1, \dots, a_{n-1}, a_n)$ such that $a_0 = \tilde{a}$, $a_n \in \arg \max_{a \in \text{ext } M} a \cdot \theta$, $\overline{a_i a_{i-1}}$ is an edge of M for all $i = 1, \dots, n$, and $(a_i - a_{i-1}) \cdot \theta > 0$ for all $i = 1, \dots, n$. Condition (4) implies that either $\varphi(\tilde{a}) \cdot \theta < \varphi(a_n) \cdot \theta$ or $\varphi(\tilde{a}) = \varphi(a_n)$. In the first case, $\varphi(\tilde{a}) \notin \arg \max_{a \in \text{ext } M'} a \cdot \theta$. In the second case, repeat the argument with a_n in place of \tilde{a} . Since $|\text{ext } M| < \infty$, either the procedure terminates and $\varphi(\tilde{a}) \notin \arg \max_{a \in \text{ext } M'} a \cdot \theta$ or $|\text{ext } M'| = 1$, in which case (12) holds trivially. \square

We note (12) as a separate corollary for later use.

Corollary B.4. *Suppose $M' \in \text{Def}(M)$. Then, there exists a surjective function $\varphi : \text{ext } M \rightarrow \text{ext } M'$ such that*

$$\arg \max_{a \in \text{ext } M'} a \cdot \theta = \varphi \left(\arg \max_{a \in \text{ext } M} a \cdot \theta \right) \quad (13)$$

for all $\theta \in \Theta$.

We can translate the definition of deformations into a polyhedral characterization of $\text{Def}(M)$. For each vertex $a \in \text{ext } M$, let $I_a = \{1 \leq i \leq l \mid a \in H_i\}$ denote the set of indices of facet-defining hyperplanes in $\mathcal{H}_M = \{H_1, \dots, H_k\}$ intersecting a . Under any feasible deformation and for each $a \in \text{ext } M$, the hyperplanes in I_a still need to intersect in a single point $\varphi_a \in A$. Thus, we have the following linear system with variables $(\varphi_a)_{a \in \text{ext } M} \in \mathbb{R}^{d \times |\text{ext } M|}$ corresponding to the points in $\text{ext } M'$ and variables $c' \in \mathbb{R}^k$ corresponding to the deformation vector of M' :

$$\varphi_a \cdot n_i = c'_i \quad \forall a \in \text{ext } M, \forall i \in I_a \quad (14)$$

$$\varphi_a \cdot n_i \leq c'_i \quad \forall a \in \text{ext } M, \forall i \in \{1, \dots, k\} \setminus I_a \quad (15)$$

$$\varphi_a \cdot n_H \leq c_H \quad \forall a \in \text{ext } M, \forall H \in \mathcal{F}. \quad (16)$$

Let us parse these (in)equalities. The inequalities in (16) capture the requirement that M' is a feasible extended menu, i.e., $\text{ext } M' \subset A$. (Recall that \mathcal{F} is the set of facet-defining hyperplanes of A .) The (in)equalities in (14) and (15) are jointly equivalent to condition (2) in the definition of a deformation. (Condition (1) is satisfied by construction: we use the facet-defining hyperplanes of M to define M' .) (14) ensures that the facet-defining hyperplanes of M intersecting $a \in \text{ext } M$ still intersect in a single point $\varphi_a \in \text{ext } M$ under the deformation vector c' . (15) ensures that $\varphi_a \in \text{ext } M'$, i.e., the facet-defining halfspaces of M still contain φ_a under the deformation vector c' . In economic terms, recalling the equivalence between $M' \in \text{Def}(M)$ and the corresponding mechanisms x and x' satisfying $\mathcal{IC}(x) \subseteq \mathcal{IC}(x')$ (Lemma B.3), (14) and (15) are tantamount to $\mathcal{IC}(x) \subseteq \mathcal{IC}(x')$. If none of the constraints in (15) are binding for M' (which is the case for M by definition of the index sets I_a), then $\mathcal{IC}(x) = \mathcal{IC}(x')$.

Lemma B.5. *$\text{Def}(M)$ is a polytope and a face of \mathcal{M} . In particular, $M \in \text{ext } \mathcal{M}$ if and only if $M \in \text{ext } \text{Def}(M)$.*

Proof. Note that (14) to (16) define a polytope in $\mathbb{R}^{d \times |\text{ext } M|} \times \mathbb{R}^k$: (14) to (16) is a linear system with bounded solutions since A is bounded. The projection onto the second factor $c' \in \mathbb{R}^k$ is also a polytope. By construction, there is an affine bijection between the projected polytope and $\text{Def}(M)$ given by the deformation vectors $c' \in \mathbb{R}^k$. Thus, $\text{Def}(M)$ is a polytope, i.e., the convex hull of finitely many extended menus.

To show that $\text{Def}(M)$ is a face of \mathcal{M} , first observe that if $M \in \mathcal{M}^{\text{Fin}}$, $M', M'' \in \mathcal{M}$ and $M = \lambda M' + (1 - \lambda)M''$ for some $\lambda \in (0, 1)$, then $M', M'' \in \text{Def}(M)$. This is because the normal fan of the Minkowski sum of polyhedra is finer than the normal fans of each summand.⁴¹ It is immediate that $M \in \text{ext } \mathcal{M}$ if and only if $M \in \text{ext } \text{Def}(M)$.

To complete the proof that $\text{Def}(M)$ is a face of \mathcal{M} , consider any $\tilde{M} \in \text{Def}(M)$. If $\tilde{M} = \lambda M' + (1 - \lambda)M''$ for $M', M'' \in \mathcal{M}$, then $M', M'' \in \text{Def}(\tilde{M})$ by the previous paragraph. Observe that “deformation of” is a transitive relation, hence $M', M'' \in \text{Def}(M)$, as desired. \square

The polyhedral characterization of $\text{Def}(M)$ immediately translates into an algebraic characterization of finite-menu extreme points: by Lemma B.5, $M \in \text{ext } \mathcal{M}$ if and only if there is a non-zero direction $(t, s) \in \mathbb{R}^{d \times |\text{ext } M|} \times \mathbb{R}^k$ such that the two candidate solutions $((a \pm t_a)_{a \in \text{ext } M}, (c \pm s))$ solve the linear system (14) to (16).

Using condition (4) in Lemma B.3, we can state an equivalent algebraic characterization of finite-menu extreme points that needs only minimal information about the underlying mechanism. For a mechanism $x \in \mathcal{X}$, let

$$E = \left\{ (a, b) \in \text{menu}(x) \times \text{menu}(x) \mid \exists \theta \in \Theta : \{a, b\} = \arg \max_{\tilde{a} \in \text{menu}(x)} \tilde{a} \cdot \theta \right\} \quad (17)$$

denote the set of pairs (a, b) of menu items for which there exists a type whose favorite allocations are $\{a, b\}$. These are exactly the edges of the extended menu associated with x . For an allocation $a \in \text{menu}(x)$, also define

$$\mathcal{F}(a) = \{H \in \mathcal{F} \mid a \in H\}. \quad (18)$$

Theorem B.6. *Let $x \in \mathcal{X}$ have finite menu size. Then $x \in \text{ext } \mathcal{X}$ if and only if all solutions $((\varphi_a)_{a \in \text{menu}(x)}, (\lambda_{ab})_{(a,b) \in E}) \in \mathbb{R}^{d \times |\text{menu}(x)|} \times \mathbb{R}_+^{|E|}$ to*

$$\lambda_{ab}(a - b) = \varphi_a - \varphi_b \quad \forall (a, b) \in E \quad (19)$$

$$\varphi_a \cdot n_H = c_H \quad \forall a \in \text{menu}(x), H \in \mathcal{F}(a) \quad (20)$$

$$\varphi_a \cdot n_H \leq c_H \quad \forall a \in \text{menu}(x), H \notin \mathcal{F}(a) \quad (21)$$

are the trivial solutions where $\{\varphi_a\}_{a \in \text{menu}(x)} = \text{ext } M$ and $\lambda_{ab} = 1$ for all $(a, b) \in E$.

Remark. If \overline{ab} and $\overline{a'b'}$ are not parallel for all $(a, b), (a', b') \in E$, then the trivial solution is unique.

Proof. Let $M \in \mathcal{M}^{\text{Fin}}$ be the extended menu associated with the finite-menu extreme point $x \in \text{ext } \mathcal{X}$. By Corollary A.3, $\text{menu}(x) = \text{ext } M$. By Lemma B.5, $M \in \text{ext } \text{Def}(M)$. An extreme point of a polytope in Euclidean space is uniquely determined from its incident facets, i.e., binding constraints. If $\varphi_a = a$ for all $a \in \text{ext } M$ and $c' = c$, then the constraints (15) are all slack by the definition of the index sets I_a . Thus, $((a)_{a \in \text{ext } M}, c)$ must be the unique solution to (14), (15), (20) and (21). By Lemma B.3, there exist $(\lambda_{ab})_{(a,b) \in E} \in \mathbb{R}^{|E|}$ such that

⁴¹An explicit reference for polyhedra is Maclagan and Sturmfels (2021, Equation 2.3.1).

$((\varphi_a)_{a \in \text{ext } M}, (\lambda_{ab})_{(a,b) \in E})$ solve (19) if and only if there exists a permutation $\xi : \text{ext } M \rightarrow \text{ext } M$ and $c' \in \mathbb{R}^k$ such that $((\varphi_{\xi(a)})_{a \in \text{ext } M}, c')$ solve (14) and (15). \square

B.1. Relation to MV. We summarize here, for readers of MV, how our results generalize their findings about the facial structure of IC mechanisms and their algebraic characterization of finite-menu extreme points to arbitrary linear screening problems.

Our Lemmas B.3 and B.5 generalize Theorems 17, 19, and 20 in MV. MV show for the multi-good monopoly problem that the decomposing summands of a finite-menu IC mechanism must have a coarser market segmentation (in our language: normal fan) than the mechanism itself (Theorem 17). In their Definition 18, MV then define the set of all IC mechanisms with a coarser market segmentation than a given IC mechanism that also satisfy an analogue of (20), i.e., have at least the same binding feasibility constraints as the given mechanism. This set is the analogue of our deformation polytope $\text{Def}(M)$, modulo (20). MV show that the set is a face of the set of IC mechanisms (Theorem 19). We further show that the set is a polytope, which immediately gives us MV’s key technical result (Theorem 20): a finite-menu IC mechanism is an extreme point if and only if it is the singleton element of their set (i.e., $\text{Def}(M)$ plus (20)).

Our polyhedral characterization (14) to (16) of $\text{Def}(M)$ immediately translates into the algebraic characterization of finite-menu extreme points given in Theorem B.6, generalizing Theorem 24 in MV. In our result, (19) generalizes condition (13) in MV; (20) generalizes condition (14) in MV; (21) generalizes the condition “ $\mathbf{0} \leq z^a \leq \mathbf{1}$ ” in MV (which is feasibility for the monopoly problem); in our model, $z^a = \varphi_a$. Theorem B.6 amends a minor oversight in MV in that multiple solutions of (19) to (21) can correspond to the same extreme point $x \in \text{ext } \mathcal{X}$ because there need not be a unique assignment of the variables $(\varphi_a)_{a \in \text{menu}(x)}$ to the menu items whenever the menu has parallel edges.

APPENDIX C. EXTREME POINTS FOR ONE-DIMENSIONAL TYPE SPACES

We deduce Theorem 6.1 from a general characterization of the extreme points for one-dimensional linear screening problems. We state the characterization in terms of extended menus. By Theorem A.2, we could equivalently state it in terms of menus of mechanisms. The key concept in the characterization—a *flexible chain*—requires some notation to be defined. Let us first state the result, then define the concept, and then give the proof.

Theorem C.1. *Let $d = 2$ and $M \in \mathcal{M}$. Then $M \in \text{ext } \mathcal{M}$ if and only if*

- (1) $|\text{ext } M| \leq 2$ and M is exhaustive, or
- (2) $3 \leq |\text{ext } M| < \infty$ and M has no flexible chain.

Remark. The theorem is an extension of a result due to Mielczarek (1998, Theorem 3.1). The result characterizes extremal convex bodies ($\text{ext } \mathcal{M}$) contained in a given convex body in the plane (A). If cone $\Theta = \mathbb{R}^2$ is unrestricted, then we can use Mielczarek’s Theorem.⁴² Otherwise, if cone $\Theta \neq \mathbb{R}^2$ is restricted, we have to make a minor modification to the result because we consider closed convex sets $M \in \mathcal{M}$ with extreme points in A . In any case, the

⁴²Specifically, in Mielczarek’s theorem,

- condition 1° is equivalent to condition (1) above;
- if $V(M) \neq \emptyset$, then conditions 2° and (i) are equivalent to the absence of a flexible chain;
- if $V(M) = \emptyset$, then conditions 2° and (ii) are equivalent to the absence of a flexible chain.

Condition (iii) in Mielczarek’s theorem never applies if A (Q in the statement) is a polytope.

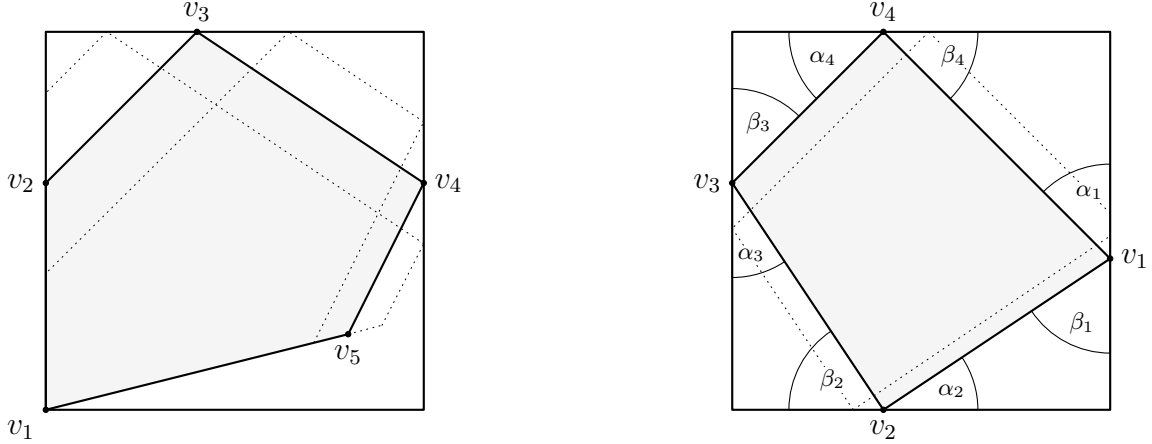

FIGURE 7. An illustration of flexible chains and their connection to extreme points. Left: an extended menu M , depicted as the shaded area, with a flexible chain $S = (v_2, v_3, v_4, v_5)$ and two deformations of M , depicted with dotted lines, that decompose M . Right: an extended menu M , depicted as the shaded area, with a chain $S = (v_1, v_2, v_3, v_4)$ that is not flexible because it violates the symmetry condition (23) on the angles $(\alpha_k)_k$ and $(\beta_k)_k$. Intuitively, the start- and endpoints of a candidate deformation coincide only under the symmetry condition.

original presentation of the result and its proof are notationally tedious, so we have restated and shall reprove most of the result for the reader's convenience.

To get a first sense of a flexible chain, recall Figure 1 (Section 4). This figure illustrates a non-extreme point that can be deformed by horizontally translating the right-most vertical edge in its menu. The two vertices of this edge form a flexible chain in the sense of Theorem C.1. However, a menu may lack an edge that can be flexibly translated in both normal directions, yet the corresponding mechanism may still not be an extreme point. This is because multiple edges could potentially be translated jointly, which is the idea captured by a flexible chain. The formal definition of a flexible chain requires some new notation.

For the following definitions, let $d = 2$ and fix an extended menu $M \in \mathcal{M}$ of finite menu size $|\text{ext } M| < \infty$. Recall that M is a polyhedron that satisfies $M = \text{conv ext } M + \Theta^\circ$. The vertices of any polyhedron in the plane can be ordered clockwise and adjacent vertices in the ordering are connected by an edge. If $M \in \mathcal{M}$ is unbounded, i.e., $\text{cone } \Theta \neq \mathbb{R}^2$, we designate a placeholder $*$ as the first and last vertex in the ordering (which can be thought of as a vertex at infinity).

We define four disjoint subsets $V(M), I(M), B_1(M), B_2(M) \subseteq \text{ext } M$ such that

$$\text{ext } M = V(M) \cup I(M) \cup B_1(M) \cup B_2(M). \quad (22)$$

$V(M) = \text{ext } M \cap \text{ext } A$. $I(M) = \text{ext } M \cap \text{int } A$. $B_1(M)$ is the set of vertices $a \in \text{ext } M \cap (\text{bndr } A \setminus \text{ext } A)$ such that there is no other vertex $b \in \text{ext } M$ for which $\overline{ab} \subset \text{bndr } A$. $B_2(M) = (\text{bndr } A \setminus \text{ext } A) \setminus B_1(M)$ is the set of vertices $a \in \text{ext } M \cap (\text{bndr } A \setminus \text{ext } M)$ for which such a vertex $b \in \text{ext } M$ does exist.

Example C.2. We illustrate the definition of these subsets with several examples. In the left panel of Figure 7, $v_1 \in V(M)$, $v_2 \in B_2(M)$, $v_3, v_4 \in B_1(M)$, and $v_5 \in I(M)$. In the right panel of Figure 7, all vertices are in $B_1(M)$. In Figure 5, $v_1 \in V(M)$, $v_5 \in I(M)$, and $v_4 \in B_1(M)$.

We define the following *angles* formed by the edges of M with the edges of the allocation polytope A . Let $v \in B_1(M)$. Let u and w be the vertices preceding and succeeding v in the clock-wise ordering, respectively. Let \overline{ab} be the edge of A on which v lies, where a precedes b in the clock-wise ordering. Let α_k be the measure of the angle $\angle uva$, and let β_k be the measure of the angle $\angle wvb$; see the right panel in Figure 7 for an illustration.⁴³

Definition C.3. A sequence $S = (v_1, \dots, v_n)$ of vertices of M that are adjacent in the clock-wise ordering is a **flexible chain** if $S \cap V(M) = \emptyset$ and one of the following holds:

- (1) $v_1, v_n \in I(M) \cup B_2(M) \cup \{*\}$, and if $n = 2$, then $\overline{v_1 v_n} \not\subset \text{bndr } A$;
- (2) $S = \text{ext } M = B_1(M)$, $\text{cone } \Theta = \mathbb{R}^2$, n is even, and

$$\prod_{k=1}^n \sin \alpha_k = \prod_{k=1}^n \sin \beta_k. \quad (23)$$

Example C.4. We illustrate the definition of a flexible chain with several examples. In the left panel of Figure 7, $S = (v_2, v_3, v_4, v_5)$ forms a flexible chain. In the right panel of Figure 7, $S = (v_1, v_2, v_3, v_4)$ does *not* form a flexible chain because the symmetry condition (23) is violated. In contrast, the vertices of a 45° rotation of the allocation square would form a flexible chain. In Figure 5, $(*, v_4, v_5)$ forms a flexible chain. Indeed, the extended menu depicted there for the one-good monopoly problem has menu size 3. It is well-known that the corresponding mechanism cannot be an extreme point, i.e., the extended menu must have deformations that decompose it. This observation is generalized in Theorem C.1.

Proof of Theorem C.1. Suppose $|\text{ext } M| \leq 2$. If $\text{ext } M$ is a singleton, then $M \in \text{ext } \mathcal{M}$ if and only if M is exhaustive. Suppose $\text{conv ext } M$ is a line segment and $M = \lambda M' + (1 - \lambda)M''$ for $M', M'' \in \mathcal{M}$ and $\lambda \in (0, 1)$. Then, M' and M'' are homothetic to M because they must be deformations of M by Lemma B.5. Using Theorem 5.2, $M \in \text{ext } \mathcal{M}$ if and only if M is exhaustive.

Thus, suppose $|\text{ext } M| \geq 3$. We first show that if $M \in \text{ext } \mathcal{M}$, then $|\text{ext } M| < \infty$. Let $U \in \mathcal{U}$ be the indirect utility function associated with M (i.e., the support function of M).

For the sake of contradiction, suppose $|\text{ext } M| = \infty$. Since A has only finitely many edges and on each edge of A there can be at most two vertices of M , $|\text{ext } M \cap \text{int } A| = \infty$. In particular, there must exist an open cone $C \subseteq \text{cone } \Theta$ such that $\text{ext } M \cap C \subset \text{int } A$ and $|\text{ext } M \cap C| = \infty$. Let L be an open line segment such that $\text{cone } L = C$. Let $\gamma : (0, 1) \rightarrow L$ be a bijective isometry. Consider the convex function $U \circ \gamma : (0, 1) \rightarrow \mathbb{R}$, which completely determines U on C by 1-homogeneity.

Suppose there exist convex functions $U_1, U_2 : (0, 1) \rightarrow \mathbb{R}$ such that $U \circ \gamma = \frac{1}{2}U_1 + \frac{1}{2}U_2$, $U_1(t) = U_2(t) = U(t)$ for all $t \notin [\varepsilon, 1 - \varepsilon]$, where $\varepsilon > 0$ is sufficiently small, and the right-derivatives of $U \circ \gamma, U_1$, and U_2 , respectively, are the same at ε , and the left-derivatives of $U \circ \gamma, U_1$, and U_2 , respectively, are the same at $1 - \varepsilon$. Then, U_1 and U_2 can be extended to sublinear functions on cone Θ such that $U = \frac{1}{2}U_1 + \frac{1}{2}U_2$ by first extending the functions to C

⁴³That is, $\alpha_k = \cos^{-1} \left(\frac{(u-v) \cdot (a-v)}{\|u-v\| \|a-v\|} \right)$ and $\beta_k = \cos^{-1} \left(\frac{(w-v) \cdot (b-v)}{\|w-v\| \|b-v\|} \right)$.

by 1-homogeneity and then to $\text{cone } \Theta$ by setting $U|_{\text{cone } \Theta \setminus C} = U_1|_{\text{cone } \Theta \setminus C} = U_2|_{\text{cone } \Theta \setminus C}$. If U_1 and U_2 are sufficiently close to $U \circ \gamma$, then their extensions are in \mathcal{U} because $\partial U(L) \subset \text{int } A$.

We now show that the convex functions $U_1, U_2 : (0, 1) \rightarrow \mathbb{R}$ from the previous paragraph exist, contradicting that $U \in \text{ext } \mathcal{U}$. Consider the set \mathcal{G} of convex functions $g : [\varepsilon, 1 - \varepsilon] \rightarrow \mathbb{R}$ such that (1) $g(\varepsilon) = (U \circ \gamma)(\varepsilon)$, (2) $g(1 - \varepsilon) = (U \circ \gamma)(1 - \varepsilon)$, (3) $g'_+(\varepsilon) = (U \circ \gamma)'_+(\varepsilon)$, where g'_+ is the right-derivative, and (4) $g'_-(1 - \varepsilon) = (U \circ \gamma)'_-(1 - \varepsilon)$, where g'_- is the left-derivative. By combining a well-known result due to Blaschke and Pick (1916) about extremal convex functions on \mathbb{R} and a result due to Winkler (1988) about the extreme points of convex sets obtained from a given convex set by imposing finitely many affine restrictions, one can show the the extreme points of \mathcal{G} are piecewise-affine with at most three pieces. Thus, $U \notin \text{ext } \mathcal{U}$ and $M \notin \text{ext } \mathcal{M}$ since $|\text{ext } M \cap \text{cone}(\gamma([\varepsilon, 1 - \varepsilon]))|$ can be made arbitrarily large by choosing $\varepsilon > 0$ small enough.

Suppose $\text{cone } \Theta \neq \mathbb{R}^2$ or $\text{ext } M \neq B_1$. By Theorem 4.1 and Lemma B.5, $M \notin \text{ext } \mathcal{M}$ and $|\text{ext } M| < \infty$ if and only if M has a deformation $M' \in \text{Def}(M)$ such that $\mathcal{F}(M) = \mathcal{F}(M')$. Thus, it suffices to show that M has a deformation $M' \in \text{Def}(M)$ such that $\mathcal{F}(M) = \mathcal{F}(M')$ if and only if M has a flexible chain.

By Lemma B.5, $M' \in \text{Def}(M)$ if and only if the facet-defining hyperplanes (lines) of M' are parallel translates of the facet-defining hyperplanes of M and there is a surjective map $\varphi : \text{ext } M \rightarrow \text{ext } M'$. By taking a convex combination $\varepsilon M' + (1 - \varepsilon)M$ for $\varepsilon > 0$ sufficiently small, we may assume that $\varphi : \text{ext } M \rightarrow \text{ext } M'$ is bijective.

For $\mathcal{F}(M) = \mathcal{F}(M')$ to hold, $(v, \varphi(v))$ must lie on the same face of A . In particular, $\varphi(a) = a$ for all $a \in V(M)$, $\varphi(I(M)) = I(M')$, $\varphi(B_1(M)) = B_1(M')$, and $\varphi(B_2(M)) = B_2(M')$.

We observe that if $v \in B_1(M)$ and $v \neq \varphi(v)$, then the two facet-defining hyperplanes of M intersecting in v must *both* be translated in M' for otherwise $(v, \varphi(v))$ cannot lie on a common edge of A .

Consider a deformation $M' \in \text{Def}(M)$ such that $\mathcal{F}(M) = \mathcal{F}(M')$; we construct a flexible chain of M . Find a sequence $S = (v_1, \dots, v_n)$ of vertices in $\text{ext } M \setminus \varphi(\text{ext } M)$ that are adjacent in the clock-wise ordering and such that no other vertex in $\text{ext } M \setminus \varphi(\text{ext } M)$ is adjacent to a vertex in S . $S \cap V(M) = \emptyset$ follows since $\varphi(a) = a$ for all $a \in V(M)$. If $n = 2$, then $\overline{v_1 v_n} \not\subset \text{bndr } A$ for otherwise the edge $\overline{\varphi(v_1)\varphi(v_n)}$ is not in $\text{bndr } A$, contradicting $\mathcal{F}(M) = \mathcal{F}(M')$. If $v_1, v_n \in B_1(M)$, then, by the previous paragraph, v_1 and v_n cannot be the first or last vertex in the sequence, contradicting the construction of S .

Conversely, suppose $M \in \mathcal{M}$ has a flexible chain (v_1, \dots, v_n) . We carry out the construction illustrated in Figure 7. Without loss of generality, we may assume $v_2, \dots, v_{n-1} \in B_1(M)$ for otherwise, (v_1, \dots, v_n) has a subsequence of adjacent vertices that is a flexible chain with the desired property. Let (H_1, \dots, H_{n-1}) be the hyperplanes such that H_i defines the facet $\overline{v_i v_{i+1}}$ for all $i = 1, \dots, n - 1$.

Suppose $v_1 \neq *$. Let H_0 be the other hyperplane of M intersecting v_1 . Translate H_1 by a sufficiently small amount, and let φ_1 be the intersection of H'_1 and H_0 . Since $v_1 \in \text{int } A \cup B_2$, φ_1 lies on the same face of A as v_1 . If $v_1 = *$, translate H_1 by a sufficiently small amount to obtain H'_1 .

Let φ_2 be the intersection of H'_1 with the edge of A on which v_2 lies. (This intersection is non-empty as long as all translations are sufficiently small.) Let H'_2 be the translate of H_2 that intersects φ_2 .

Iterate the construction in the previous paragraphs to obtain a sequence of points $(\varphi_1, \dots, \varphi_n)$ and hyperplanes (H'_1, \dots, H'_{n-1}) . Since $v_n \in \text{int } A \cup B_2 \cup \{*\}$, the hyperplane $H_n \neq H_{n-1}$ intersecting v_n need not be translated to meet φ_n . Define M' as the polyhedron whose edges are defined by (H'_1, \dots, H'_{n-1}) and by the facet-defining hyperplanes of M different from (H_1, \dots, H_{n-1}) . By construction, $M' \in \text{Def}(M)$ and $\mathcal{F}(M) = \mathcal{F}(M')$.

It remains to consider the case where $\text{ext } M = B_1(M)$ and $\text{cone } \Theta = \mathbb{R}^2$. We refer the reader to Lemmas 9, 17, and 18 in Mielczarek (1998) for the formal proof that $M \notin \text{ext } \mathcal{M}$ if and only if the symmetry condition (23) holds. We illustrate the idea in the right panel of Figure 7: if (23) were to hold, then the dotted chain of line segments would have the same start- and endpoints, i.e., would become a deformation of the depicted extended menu. \square

APPENDIX D. PROOFS

This appendix gathers the proofs for the results in the main text in the order of appearance. By Theorem A.2, we may prove all results either for the set of IC and IR mechanisms \mathcal{X} , the set of extended menus \mathcal{M} , or the set of indirect utility functions \mathcal{U} .

D.1. Proofs for Section 4. We note the following observation.

Lemma D.1. *Suppose $x = \lambda x' + (1 - \lambda)x''$ for $x, x', x'' \in \mathcal{X}$ of finite menu size and $\lambda \in (0, 1)$. Then, $\mathcal{IC}(x) = \mathcal{IC}(x') \cap \mathcal{IC}(x'')$ and $\mathcal{F}(x) = \mathcal{F}(x') \cap \mathcal{F}(x'')$.*

Proof. Let $M, M', M'' \in \mathcal{M}$ be the extended menus associated with $x, x',$ and x'' , respectively. $M = \lambda M' + (1 - \lambda)M''$ by Theorem A.2. For $Z \subset \mathbb{R}^d$, let $\text{Top}(Z, \theta) = \arg \max_{a \in Z} a \cdot \theta$.

By Corollary A.3, $\text{menu}(x) = \text{ext } M$. Thus, $(\theta, \theta') \in \mathcal{IC}(x)$, i.e., $\text{Top}(\text{menu}(x), \theta') \subseteq \text{Top}(\text{menu}(x), \theta)$, if and only if $\text{Top}(\text{ext } M, \theta') \subseteq \text{Top}(\text{ext } M, \theta)$.

We first show $\mathcal{IC}(x) \supseteq \mathcal{IC}(x') \cap \mathcal{IC}(x'')$. Suppose $(\theta, \theta') \in \mathcal{IC}(x') \cap \mathcal{IC}(x'')$. Then,

$$\begin{aligned} \text{Top}(\text{ext } M', \theta') &\subseteq \text{Top}(\text{ext } M', \theta) \\ \text{Top}(\text{ext } M'', \theta') &\subseteq \text{Top}(\text{ext } M'', \theta). \end{aligned}$$

Thus,

$$\text{Top}(\lambda \text{ext } M' + (1 - \lambda) \text{ext } M'', \theta') \subseteq \text{Top}(\lambda \text{ext } M' + (1 - \lambda) \text{ext } M'', \theta).$$

Since $\text{ext } M \subseteq \lambda \text{ext } M' + (1 - \lambda) \text{ext } M''$, we conclude

$$\text{Top}(\text{ext } M, \theta') \subseteq \text{Top}(\text{ext } M, \theta)$$

or, equivalently, $(\theta, \theta') \in \mathcal{IC}(x)$.

We next show $\mathcal{IC}(x) \subseteq \mathcal{IC}(x') \cap \mathcal{IC}(x'')$. By interchanging the roles of x' and x'' , it suffices to show that $(\theta, \theta') \notin \mathcal{IC}(x')$ implies $(\theta, \theta') \notin \mathcal{IC}(x)$. Assume $\text{Top}(\text{ext } M', \theta') \setminus \text{Top}(\text{ext } M', \theta) \neq \emptyset$, i.e., $(\theta, \theta') \notin \mathcal{IC}(x')$. Then,

$$\text{Top}(\lambda \text{ext } M' + (1 - \lambda) \text{ext } M'', \theta') \setminus \text{Top}(\lambda \text{ext } M' + (1 - \lambda) \text{ext } M'', \theta) \neq \emptyset.$$

Since $\text{conv } \text{ext } M = \text{conv}(\lambda \text{ext } M' + (1 - \lambda) \text{ext } M'')$ and utility is linear, we conclude

$$\text{Top}(\text{ext } M, \theta') \setminus \text{Top}(\text{ext } M, \theta) \neq \emptyset$$

or, equivalently, $(\theta, \theta') \notin \mathcal{IC}(x)$.

$\mathcal{F}(x) = \mathcal{F}(x') \cap \mathcal{F}(x'')$ is immediate. If one summand is bounded away from a hyperplane, then the the convex combination must also be bounded away from the hyperplane. Conversely, if both summands make allocations on the same hyperplane, then so does their convex combination. \square

The following proof uses the polyhedral characterization of $\text{Def}(M)$ given by (14), (15), and (16) in Appendix B. The proof idea is described right after the statement in the main text.

Proof of Theorem 4.1. The remark following Theorem 4.1 is immediate from Lemma D.1: for $x \in \mathcal{X}$, if another $x' \in \mathcal{X}$ satisfies $\mathcal{IC}(x) \subseteq \mathcal{IC}(x')$ and $\mathcal{F}(x) \subseteq \mathcal{F}(x')$, then $x'' = \varepsilon x' + (1 - \varepsilon)x$ for $0 < \varepsilon < 1$ satisfies $\mathcal{IC}(x) = \mathcal{IC}(x'')$ and $\mathcal{F}(x) = \mathcal{F}(x'')$.

Necessity is also immediate from Lemma D.1: if $x \notin \text{ext } \mathcal{X}$, then the summands in the decomposition make weakly more constraints binding.

For sufficiency, suppose $\mathcal{IC}(x) = \mathcal{IC}(x')$ for $x, x' \in \mathcal{X}$ of finite menu size. Let $M, M' \in \mathcal{M}$ be the associated extended menus. By Lemma B.3, M and M' are mutual deformations. In particular, there is a bijection $\varphi : \text{ext } M \rightarrow \text{ext } M'$.

As an intermediate observation, we claim that $\mathcal{F}(x) = \mathcal{F}(x')$ implies, for all $a \in \text{menu}(x)$ and $H \in \mathcal{F}$, $a \in H$ if and only if $\varphi(a) \in H$. In words, each menu item of x makes the same feasibility constraints binding as the corresponding menu item in x' . We have $H \in \mathcal{F}(M) = \mathcal{F}(x)$ if and only if $\max_{a \in \text{ext } M} a \cdot n_H = c_H$, where n_H is the normal vector and c_H the right-hand side constant of the hyperplane $H \in \mathcal{F}$. Analogously, $H \in \mathcal{F}(M') = \mathcal{F}(x')$ if and only if $\max_{a \in \text{ext } M'} a \cdot n_H = c_H$. The proof of the claim is completed using Corollary B.4, which gives

$$\arg \max_{a \in \text{ext } M'} a \cdot n_H = \varphi(\arg \max_{a \in \text{ext } M} a \cdot n_H). \quad (24)$$

We complete the proof of Theorem 4.1 using the polyhedral characterization of $\text{Def}(M)$ given by (14), (15), and (16). Let c and c' denote the deformation vectors associated with M and M' , respectively. By the previous paragraph, $\mathcal{F}(x) = \mathcal{F}(x')$ if and only if the variables $(\varphi_a = \varphi(a))_{a \in \text{ext } A}$ make the same constraints in (16) binding as the variables $(a)_{a \in \text{ext } A}$. $\mathcal{IC}(x) = \mathcal{IC}(x')$ if and only if the variables $(c, (a)_{a \in \text{ext } M})$ and $(c', (\varphi_a)_{a \in \text{ext } M})$ both satisfy the constraints in (14) and make none of the constraints in (15) binding. (See the explanation of the constraints in Appendix B.) Thus, $\mathcal{F}(x) = \mathcal{F}(x')$ and $\mathcal{IC}(x) = \mathcal{IC}(x')$ if and only if $(c, (a)_{a \in \text{ext } M})$ and $(c', (\varphi_a)_{a \in \text{ext } M})$ make the same constraints of $\text{Def}(M)$ binding. The latter is equivalent to $M, M' \notin \text{ext } \text{Def}(M)$ because $\text{Def}(M)$ is a polytope by Lemma B.5. Finally, $M, M' \notin \text{ext } \text{Def}(M)$ if and only if $x, x' \notin \text{ext } \mathcal{X}$. \square

D.2. Proofs for Section 5. Recall that by Theorem A.2, the definitions of homothety and exhaustiveness translate straightforwardly to extended menus $M \in \mathcal{M}$, where $\mathcal{F}(M) \subseteq \mathcal{F}$ was defined to be the set of facet-defining hyperplanes of A intersected by $\text{ext } M$. Also recall that $M = \lambda M' + (1 - \lambda)M''$ is a **homothetic decomposition** of M if $\lambda \in (0, 1)$ and $M', M'' \in \mathcal{M}$ are homothetic to but distinct from M .

Lemma D.2. *$M \in \mathcal{M}$ is exhaustive if and only if M has no homothetic decomposition.*

Proof. Suppose $\text{ext } M = \{a\}$ is a singleton. If $a \notin \text{ext } A$, then there exists $a' \in A$ on the same faces of A as a . Thus, $\mathcal{F}(a' + \Theta^\circ) = \mathcal{F}(M)$ and $a' + \Theta^\circ$ is homothetic to M . Thus, M is not exhaustive. Conversely, if M is not exhaustive, then there exists M' homothetic to M , i.e., $M' = t + \lambda(M + \Theta^\circ) = t + \lambda a + \Theta^\circ$, such that $t + \lambda a$ meets an inclusion-wise larger set of hyperplanes in \mathcal{F} than a , which implies $a \notin \text{ext } A$.

Suppose $\text{ext } M = \{a\}$ is not a singleton. As an intermediate step, we will show that the set

$$\text{HC}(M) = \{(\lambda, t) \in \mathbb{R}_+ \times \mathbb{R}^d \mid \text{ext}(\lambda M + t) \subset A\}$$

of all (parameters of) homotheties of M is a polytope. $\text{HC}(M)$ is bounded because A is bounded. Therefore, we show that $\text{HC}(M)$ is the intersection of finitely many halfspaces. For this, let

$$\text{HC}_-(M, H) = \{(\lambda, t) \in \mathbb{R}_+ \times \mathbb{R}^d \mid \text{ext}(\lambda M + t) \subset H_-\},$$

where $H_- = \{z \in \mathbb{R}^d : z \cdot n_H \leq c_H\}$ is the halfspace that contains A and is bounded by the facet-defining hyperplane $H \in \mathcal{F}$ of A . Let $\text{HC}(M, H)$ denote the associated hyperplane. Equivalently,

$$\text{HC}_-(M, H) = \left\{ (\lambda, t) \in \mathbb{R} \times \mathbb{R}^d \mid \lambda \max_{a \in \text{ext } M} a \cdot n_H + t \cdot n_H \leq c_H \right\}.$$

That is, $\text{HC}_-(M, H)$ is a halfspace in \mathbb{R}^{d+1} with normal $(\max_{a \in \text{ext } M} a \cdot n_H, n_H)$. Thus,

$$\text{HC}(M) = \text{HC}_+ \cap \bigcap_{H \in \mathcal{F}} \text{HC}_-(M, H)$$

is a polytope, where $\text{HC}_+ = \mathbb{R}_+ \times \mathbb{R}^d$.

We complete the proof by showing that M is exhaustive if and only if $(\lambda, t) = (1, 0) \in \text{ext } \text{HC}(M)$. Note that $(1, 0)$ does not lie on the boundary of HC_+ . Every other halfspace $\text{HC}_-(M, H)$ of $\text{HC}(M)$ corresponds to a facet-defining hyperplane H of A . Thus, M is determined by its binding feasibility constraints $\mathcal{F}(M)$ up to homothety, i.e., exhaustive, if and only if $(1, 0)$ lies on an inclusion-wise maximal set of facet-defining hyperplanes of $\text{HC}(M)$. The latter condition is what it means for a point to be an extreme point of a polytope. \square

Proof of Theorem 5.2. Immediate from Lemma D.2. \square

Proof of Theorem 5.3. By Lemma D.2, $M \in \mathcal{M}$ is not exhaustive if and only if M has a homothetic decomposition, i.e., there exist $M', M'' \in \mathcal{M}$ homothetic to M such that $M = \frac{1}{2}M' + \frac{1}{2}M''$.

Suppose $\text{ext } M = \{a\}$ is a singleton. Then M has a homothetic decomposition if and only if $a \notin \text{ext } A$. Thus, for the remainder of the proof, assume that $\text{ext } M$ is not a singleton.

M has a homothetic decomposition if and only if one of the following holds:

- (1) There exists a point $z \in \mathbb{R}^n$ and $\varepsilon > 0$ such that $z + (1 + \varepsilon)(\text{ext } M - z)$ and $z + (1 - \varepsilon)(\text{ext } M - z)$ are both subsets of A (dilation with center z).
- (2) There exists a direction $t \in \mathbb{R}^n \setminus \{0\}$ such that $\text{ext } M + t$ and $\text{ext } M - t$ are both subsets of A (translation).

The reason is that any homothety is itself either a dilation or translation.⁴⁴

If (1) is true and $a \in H \cap \text{ext } M$ for some $H \in \mathcal{F}(M)$, then $z \in H$, for otherwise $z + (1 + \varepsilon)(a - z)$ or $z + (1 - \varepsilon)(a - z)$ is not in A . Thus, if (1) is true, $\bigcap_{H \in \mathcal{F}(M)} H \neq \emptyset$. Conversely, if $\bigcap_{H \in \mathcal{F}(M)} H \neq \emptyset$, choose any $z \in \bigcap_{H \in \mathcal{F}(M)} H$. For $\varepsilon > 0$ sufficiently small, $z + (1 + \varepsilon)(\text{ext } M - z)$ and $z + (1 - \varepsilon)(\text{ext } M - z)$ are both subsets of A . This is because $\text{ext } M$ is uniformly bounded away from facet-defining hyperplanes $H \notin \mathcal{F}(M)$ and because $a \in H \in \mathcal{F}(M)$ implies $(z + (1 \pm \varepsilon)(a - z)) \in H$ by the definition of z , i.e., all facet-defining inequalities of A remain satisfied.

If (2) is true, then t is orthogonal to all the normals of the hyperplanes in $\mathcal{F}(M)$ for otherwise there is a point $a \in \text{ext } M \cap H$, for some $H \in \mathcal{F}(M)$, such that $a + t \notin H$ or

⁴⁴Specifically, suppose $M = \frac{1}{2}M' + \frac{1}{2}M''$ and $M' = z + (1 + \varepsilon)(M - z)$. Plugging in and rearranging for M'' yields $M'' = z + (1 - \varepsilon)(M - z)$.

$a-t \notin H$, which contradicts that $\text{ext } M+t$ and $\text{ext } M-t$ are subsets of A . Hence the spanning condition $\text{span}\{n_H\}_{H \in \mathcal{F}(M)} = \mathbb{R}^d$ is violated. Conversely, if the spanning condition is violated, there is a direction $t \in \mathbb{R}^d \setminus \{0\}$ such that t is orthogonal to all the facet normals in $\mathcal{F}(M)$. As in the previous paragraph, $\text{ext } M+t$ and $\text{ext } M-t$ will still satisfy the facet-defining inequalities of A for $\|t\|$ sufficiently small, i.e. $\text{ext } M+t, \text{ext } M-t \subset A$.

The statement of the of Theorem 5.3 is the contraposition of what we have shown. \square

D.3. Proofs for Section 6. We use Theorem C.1 in Appendix C and the notation introduced for this result in the following proof.

Proof of Theorem 6.1. Let $M \in \text{ext } \mathcal{M}$ be the extended menu associated with a mechanism $x \in \text{ext } \mathcal{X}$. Recall that $\text{menu}(x) = \text{ext } M$ by Corollary A.3 (since $d = 2$); thus, we show $|\text{ext } M| \leq |\mathcal{F}|$.

If $\text{cone } \Theta \neq \mathbb{R}^2$, then $V(M) \neq \emptyset$ for otherwise $M \in \text{ext } \mathcal{M}$ has a flexible chain. If $\text{cone } \Theta = \mathbb{R}^2$ and $V(M) = \emptyset$, then M can only not have a flexible chain if $\text{ext } M = B_1(M)$. In this case, $|\text{ext } M| \leq |\mathcal{F}|$. Thus, we assume $V(M) \neq \emptyset$ going forward.

Consider any vertex $v \in V(M)$ such that the sequence of subsequent vertices $S = (v_1, \dots, v_n)$ in the clockwise ordering of $\text{ext } M$ satisfies $S \cap V(M) = \emptyset$ and such that v_n is adjacent to a vertex $v' \in V(M)$. Since $v, v' \in \text{ext } A$, let (e_1, \dots, e_k) be the sequence of edges traversed when moving from v to v' clockwise on the boundary of A . (If $v = v'$, then all edges are traversed.)

We show that $n \leq k - 1$. Since $M \in \text{ext } \mathcal{M}$, S does not contain a flexible chain. Thus, $|(B_2(M) \cup I(M)) \cap S| = 1$. On every edge $i = 2, \dots, k - 1$, there lies at most one vertex in $\text{ext } M$, for otherwise $|B_2(M)| \geq 2$. Moreover, since v and v' lie on e_1 and e_k , respectively, there can be at most one vertex in $\text{ext } M \setminus \{v, v'\}$ on $e_1 \cup e_n$. (This vertex would have to be in $B_2(M)$). Thus, $n \leq k - 1$.

By applying the previous argument to every $v \in V(M)$, we conclude that $|\text{ext } M| \leq |\mathcal{F}|$. \square

Proof of Theorem 6.2. Immediate from Theorem 6.6 below. \square

Proof of Theorem 6.3. Let $x \in \mathcal{X}$ be exhaustive and such that $\text{menu}(x)$ is finite and in general position. Let $M \in \mathcal{M}$ be the associated extended menu. By Corollary A.3, $\text{ext } M = \text{menu}(x)$. $M = \text{conv } \text{ext } M + \Theta^\circ$ is a polyhedron because $\text{ext } M$ is finite and Θ° is a polyhedral cone. Since $\text{ext } M$ is in general position, all proper bounded faces of M are simplices. Smilansky (1987, Theorem 5.1) shows that a polyhedron M of which every bounded face is a simplex cannot be represented as a convex combination of polyhedra with the same recession cone as M that are not homothetic to M . Therefore, M has no non-homothetic decomposition. By Lemma D.2, M has no homothetic decomposition because M is exhaustive. Thus $M \in \text{ext } \mathcal{M}$, and $x \in \text{ext } \mathcal{X}$ by Theorem A.2. \square

We may define exhaustiveness for arbitrary subsets S of A : $\mathcal{F}(S) \subseteq \mathcal{F}$ are the facets of A intersected by S , and S is **exhaustive** if there is no $S' \subset A$ positively homothetic to S such that $\mathcal{F}(S) \subseteq \mathcal{F}(S')$. Theorem 5.3 applies as before. Recall that an extended menu $M \in \mathcal{M}$ is exhaustive if $\text{ext } M$ is exhaustive.

We use the following simple consequence of Theorem 5.3 in the proof of Theorem 6.4.

Corollary D.3. *If $S \subset A$ is exhaustive, then there exists an exhaustive $S' \subset S$ such that $|\mathcal{F}(S')| \leq d + 1$.*

Proof. By Theorem 5.3, $\text{span}\{n_H\}_{H \in \mathcal{F}(S)} = \mathbb{R}^d$. Thus, there exists a subset $\mathcal{F}' \subset \mathcal{F}(S)$ with $|\mathcal{F}'| = d$ such that $\text{span}\{n_H\}_{H \in \mathcal{F}'} = \mathbb{R}^d$. Moreover, by Theorem 5.3, there must exist a hyperplane $H' \in \mathcal{F}(S) \setminus \mathcal{F}'$ such that $\bigcap_{H \in \mathcal{F}(S)} H \cap H' \neq \emptyset$. Select $S' \subset S$ such that $\mathcal{F}(S') = \mathcal{F}' \cup \{H'\}$. (Clearly, at most $d + 1$ points in S suffice.) Theorem 5.3 completes the proof. \square

Proof of Theorem 6.4. Let $x \in \mathcal{X}$ be exhaustive with associated extended menu $M \in \mathcal{M}$ and such that $\text{menu}(x) = \text{ext } M$ is finite. We first construct a menu $\tilde{M} \in \text{ext } \mathcal{M}$ of finite menu size that is arbitrarily close to M in the Hausdorff distance and satisfies $|\text{ext } M| = |\text{ext } \tilde{M}|$. This suffices to show the denseness claim in the statement of Theorem 6.4 by Lemma A.7.

Select an inclusion-wise minimal subset $V \subseteq \text{ext } M$ such that V is exhaustive and $\underline{a} \in V$. By Corollary D.3, $|V| \leq d + 1$. (If $\underline{a} \in V$, then $|V| = 2$ suffices.) If $|V| \leq d$, then V is trivially in general position (i.e., no more than d points lie on any hyperplane in \mathbb{R}^d). Suppose $|V| = d + 1$. Then every vertex in V touches exactly one of the $d + 1$ facets in $\mathcal{F}(V)$ by construction of V . Select an arbitrary vertex $v \in V$ and move v to a nearby point v' in the same facet of A touched by v that is not in the affine hull of $V \setminus \{v\}$ (which meets the facet of A touched by v in a $(d - 2)$ -dimensional convex set). Let $W = V \setminus \{v\} \cup \{v'\}$.

Now consider one-by-one $v \in \text{ext } M \setminus V$. Perturb v to a point $v' \in A$ arbitrarily close to v such that v does not lie in any hyperplane spanned by any subset of d points in W . (This is possible since there are only finitely many such hyperplanes.) Update $W = W \cup \{v'\}$ and $V = V \cup \{v\}$. Proceed iteratively until $V = \text{ext } M$. The resulting set of points W is in general position and exhaustive by construction.

Define $\tilde{M} = \text{conv } W + \Theta^\circ$. By construction, \tilde{M} is a polyhedron in \mathcal{M} . As long as all of the finitely many perturbations carried out are sufficiently small, W is in convex position, i.e., no point in W is in the convex hull of the other points, because $\text{ext } M$ was in convex position. Moreover, for all $v, v' \in W$, $v \notin v' + \Theta^\circ$ because Θ° is closed and the same holds for all $v, v' \in \text{ext } M$. Thus, $\text{ext } \tilde{M} = W$ and \tilde{M} is exhaustive because W is exhaustive.

$\tilde{M} \in \text{ext } \mathcal{M}$ by Theorem 6.3 and $|\text{ext } \tilde{M}| = |W| = |\text{ext } M|$ by construction, proving denseness.

For openness, every polytope in a sufficiently small Hausdorff-ball around a simplicial polytope $\text{conv } \text{ext } M$ is simplicial since the vertices remain in general position (see e.g. Grünbaum et al., 1967, Theorems 5.3.1 and 10.1.1). By Lemmas A.6 and A.7, the claim follows. \square

Remark. An alternative statement of Theorem 6.4 is that the set of extreme points of menu size k is relatively open and dense in the set of exhaustive mechanisms of menu size $\leq k$. This is because the set of exhaustive extended menus of menu size k is relatively open and dense in the set of exhaustive extended menus of menu size $\leq k$.

Proof of Corollary 6.5. Take an arbitrary exhaustive extended menu $M \in \mathcal{M}$. Select a finite set of vertices $V \subseteq \text{ext } M$, including \underline{a} (if \underline{a} exists) as well as points on the same facets of A as $\text{ext } M$, such that for every point of $\text{ext } M$ there is a selected point in V at most $\varepsilon > 0$ away. By construction, V is an exhaustive set and $\underline{a} \in V$. Thus, $\tilde{M} = \text{conv } V + \Theta^\circ \in \mathcal{M}$ is exhaustive, has finite menu size, and is arbitrarily close to M for ε sufficiently small. By Theorem 6.4, \tilde{M} is arbitrarily close to an element of $\text{ext } M$ with finite menu size, which completes the proof. \square

The proof of Theorem 6.6 proceeds with Baire-category type arguments, for which we need a few definitions:

- $\text{exh } \mathcal{M} \subset \mathcal{M}$ is the set of exhaustive extended menus;
- $\mathcal{A}_k \subset \text{exh } \mathcal{M}$ is the set of exhaustive extended menus M such that $M = \frac{1}{2}M' + \frac{1}{2}M''$ for $M', M'' \in \mathcal{M}$ with $d(M', M'') \geq \frac{1}{k}$;
- $\mathcal{B}_k \subset \text{exh } \mathcal{M}$ is the set of exhaustive extended menus M that have a bounded face f with $\text{diam}(f) \geq \frac{1}{k}$ and outer unit normal vector $n_f \in \Theta$ such that $d(n_f, \text{bndr cone } \Theta) \geq 1/k$ (which is satisfied by convention if $\text{bndr cone } \Theta = \emptyset$, i.e., $\text{cone } \Theta = \mathbb{R}^d$).⁴⁵

We note that $\text{ext } \mathcal{M} = \text{exh } \mathcal{M} \setminus \bigcup_{k=1}^{\infty} \mathcal{A}_k$. Moreover, define $\text{exh } \mathcal{M}^{sc} := \text{exh } \mathcal{M} \setminus \bigcup_{k=1}^{\infty} \mathcal{B}_k$.

Lemma D.4. *Let $x \in \mathcal{X}$ be a mechanism associated with an extended menu $M \in \text{exh } \mathcal{M}^{sc}$. Then, $x : \Theta \rightarrow A$ is continuous on $\text{int cone } \Theta$. In particular, $\text{menu}(x)$ is uncountable whenever it is not a singleton.*

Proof. For any $M \in \text{exh } \mathcal{M}^{sc}$ and $\theta \in \text{int cone } \Theta$, $\arg \max_{a \in M} \theta \cdot a$ is a singleton for otherwise the boundary of M would contain a line segment connecting two extreme points of M . In particular, $x(\theta)$ is uniquely determined by M on $\text{int cone } \Theta$. Therefore, the associated indirect utility function U is differentiable on $\text{int cone } \Theta$. By Rockafellar (1997, Corollary 25.5.1), U is continuously differentiable and therefore $x = \nabla U$ is continuous on $\text{int cone } \Theta$. \square

Lemma D.5. *\mathcal{A}_k and \mathcal{B}_k are closed subsets of $\text{exh } \mathcal{M}$ for all $k \in \mathbb{N}$.*

Proof. Consider any convergent sequence $\{M_i\}_{i \in \mathbb{N}} \subset \mathcal{A}_k$ with limit $M \in \text{exh } \mathcal{M}$. We show $M \in \mathcal{A}_k$. Selecting a subsequence, if necessary, we may assume that the associated sequences $\{M'_i\}_{i \in \mathbb{N}} \subset \mathcal{M}$ and $\{M''_i\}_{i \in \mathbb{N}} \subset \mathcal{M}$, where $M_i = \frac{1}{2}M'_i + \frac{1}{2}M''_i$, converge in \mathcal{M} by Blaschke's selection theorem and Lemma A.6. Let M' and M'' denote the respective limits. We have $d(M', M'') \geq \frac{1}{k}$ since $d(M'_i, M''_i) \geq \frac{1}{k}$ for all $i \in \mathbb{N}$. Moreover, $M = \frac{1}{2}M' + \frac{1}{2}M''$ since $M_i = \frac{1}{2}M'_i + \frac{1}{2}M''_i$ for all $i \in \mathbb{N}$ and \mathcal{M} is convex, so $\frac{1}{2}M' + \frac{1}{2}M'' \in \mathcal{M}$. Thus, $M \in \mathcal{A}_k$.

Consider any convergent sequence $\{M_i\}_{i \in \mathbb{N}} \subset \mathcal{B}_k$ with limit $M \in \text{exh } \mathcal{M}$. We show $M \in \mathcal{B}_k$. By definition, for each $i \in \mathbb{N}$, there exists a line segment $L_i \subseteq \text{bndr } M_i$ of length $\geq \frac{1}{k}$ with normal vector $n_i \in \Theta$ such that $d(n_i, \text{bndr cone } \Theta) \geq \frac{1}{k}$. Selecting a subsequence, if necessary, we may assume that the line segments $\{L_i\}_{i \in \mathbb{N}}$ and the normal vectors $\{n_i\}_{i \in \mathbb{N}}$ converge to limits $L^* \subset A$ and $n^* \in \Theta$, respectively, because $\Theta \subseteq \mathbb{S}^{d-1}$ and A are compact. It is routine to verify that $L^* \subseteq \text{bndr } M$, L^* has length $\geq \frac{1}{k}$, n^* is normal to L^* on $\text{bndr } M$, and $d(n^*, \text{bndr cone } \Theta) \geq \frac{1}{k}$. Thus, $M \in \mathcal{B}_k$. \square

Proof of Theorem 6.6. We show that $\text{ext } \mathcal{M} \cap \text{exh } \mathcal{M}^{sc}$ is a dense G_δ in $\text{exh } \mathcal{M}$. This implies the statement by Lemma D.4.

The proof uses the Baire category theorem. For this, note that $\text{exh } \mathcal{M}$ is a compact metric space, hence a Baire space, because $\text{exh } \mathcal{M}$ is a closed subset of the compact metric space \mathcal{M} (Lemmas A.6 and A.7). The set $\text{ext } \mathcal{M}$ is closed because every extended menu in a sufficiently small neighborhood of a non-exhaustive extended menu $M \in \mathcal{M}$ intersects a weakly smaller set of facets of A than M and is hence also non-exhaustive by Theorem 5.3. Thus, it suffices

⁴⁵The **diameter** of a set $S \subseteq \mathbb{R}^n$, denoted $\text{diam}(S)$, is defined as:

$$\text{diam}(S) = \sup\{\|a - b\| : a, b \in S\}.$$

to show that $\text{ext } \mathcal{M}$ and $\text{exh } \mathcal{M}^{sc}$ are each a dense G_δ in $\text{exh } \mathcal{M}$. For $\text{ext } \mathcal{M}$, this follows immediately from Corollary 6.5 and Lemma D.5.

We complete the proof by showing that $\text{exh } \mathcal{M}^{sc}$ is a dense G_δ in $\text{exh } \mathcal{M}$. By Lemma D.5, $\text{exh } \mathcal{M}^{sc}$ is a G_δ in $\text{exh } \mathcal{M}$. To show denseness, consider the set $\text{exh } \mathcal{M} \setminus \mathcal{B}_k$ for some arbitrary $k \in \mathbb{N}$. By Lemma D.5, $\text{exh } \mathcal{M} \setminus \mathcal{B}_k$ is relatively open in $\text{exh } \mathcal{M}$. Moreover, $\text{exh } \mathcal{M} \setminus \mathcal{B}_k$ is dense in $\text{exh } \mathcal{M}$ because every extended menu $M \in \text{exh } \mathcal{M}$ can be approximated by a polyhedron in $\text{exh } \mathcal{M}$ whose bounded faces have diameter $< \frac{1}{k}$. We have that $\text{exh } \mathcal{M}^{sc} = \bigcap_{k=1}^{\infty} (\text{exh } \mathcal{M} \setminus \mathcal{B}_k)$ is a countable intersection of relatively open and dense sets in a Baire space. Thus, by the Baire category theorem, $\text{exh } \mathcal{M}^{sc}$ is dense in $\text{exh } \mathcal{M}$. \square

Proof of Corollary 6.7. Corollary 6.5 shows that the extreme points of \mathcal{X} are dense in the set of exhaustive mechanisms. The Straszewicz-Klee theorem (Klee Jr, 1957, Theorem 2.1) implies that the exposed points of \mathcal{X} are also dense in the set of exhaustive mechanisms. The Riesz representation theorem (Diestel and Uhl, 1977, Theorem IV.1) implies that, for every exposed point $x \in \text{exp } \mathcal{X}$, there exists an objective v and prior μ such that x is uniquely optimal. \square

D.4. Proofs for Section 7.

Proof of Lemma 7.1. It remains to show that in the linear delegation problem, the indecomposability of an extended menu $M \in \mathcal{M}$ is necessary for the non-existence of a non-homothetic decomposition. We show the converse. Assume that there exists an extended menu $M \in \mathcal{M}$ that is decomposable; that is, there exist convex bodies $K', K'' \subset \mathbb{R}^d$, not homothetic to M , such that $M = K' + K''$.

We aim to construct from these summands K' and K'' a non-homothetic decomposition of M into extended menus. To achieve this, we will identify $\lambda \in (0, 1)$ and $t \in \mathbb{R}^d$ such that the scaled and translated sets $M' = \frac{1}{\lambda}(K' + t)$ and $M'' = \frac{1}{1-\lambda}(K'' - t)$ are extended menus, i.e., subsets of the unit simplex $A = \Delta$. This will complete the proof since $M = \lambda M' + (1 - \lambda)M''$.

Since $M \subseteq A = \Delta$, M satisfies the following constraints:

- (1) Positivity: $\min_{a \in M} a_i \geq 0$ for all $i \in \{1, \dots, d\}$;
- (2) Size: $\max_{a \in M} \sum_{i=1}^d a_i \leq 1$.

We will now define t and λ such that the above constraints are binding for M' . This ensures that the constraints are satisfied by M'' because they are satisfied by M and M is a convex combination of M' and M'' . We set

$$t_i = - \min_{a \in K'} a_i.$$

This ensures $\min_{a \in K'+t} a_i = 0$ for all $i \in \{1, \dots, d\}$; hence M' satisfies the positivity constraint with equality, irrespective of our choice of λ .

Next, for any convex body $K \subset \mathbb{R}^d$, define:

$$|K|_\Delta = \max_{a \in K} \sum_{i=1}^d a_i - \sum_{i=1}^d \min_{a \in K} a_i.$$

Note that $|\cdot|_\Delta$ commutes with positive scalar multiplication and Minkowski addition; that is, $|\alpha K|_\Delta = \alpha |K|_\Delta$ and $|K_1 + K_2|_\Delta = |K_1|_\Delta + |K_2|_\Delta$.

Set

$$\lambda = |K'|_\Delta.$$

Since K' and K'' are not singletons (otherwise, the decomposition would be homothetic), we have $|K'|_\Delta, |K''|_\Delta > 0$, hence $\lambda > 0$. Since $|M|_\Delta \leq 1$, we have $|K'|_\Delta < 1$ and $|K''|_\Delta < 1$, hence $\lambda \in (0, 1)$.

We can now compute

$$\max_{a \in M'} \sum_{i=1}^d a_i = |M'|_\Delta = \frac{1}{\lambda} |K' + t|_\Delta = \frac{1}{\lambda} |K'|_\Delta = 1$$

and hence M' satisfies the size constraint with equality. Hence, $M'' \subseteq A$ by the earlier argument, which completes the proof. \square

D.5. Proofs for Section 8.

D.5.1. *Undominated Mechanisms.* We begin by establishing an important result for the proofs of Theorems 8.5 and 8.7, namely that uniquely optimal mechanisms are dense in the undominated extreme points when considering two mechanisms as being “close” when they are “close” with respect to the induced principal’s utility functions. Theorem 8.2 will be proved along the way.

To state the result, let

$$\mathcal{V} = \{\theta \mapsto x(\theta) \cdot v(\theta) \mid x \in X\}$$

denote the set of the principal’s utility functions induced by the set of (IC) and (IR) mechanisms. This set of functions $\Theta \rightarrow \mathbb{R}$ is convex and L^1 -compact because it is a continuous image of the compact convex set \mathcal{X} .

We say that a principal utility function $V \in \mathcal{V}$ is **undominated** if there exists an undominated mechanism $x \in \mathcal{X}$ such that $V(\theta) = x(\theta) \cdot v(\theta)$.

We also define the following subsets of \mathcal{V} :

- $\text{und } \mathcal{V} \subset \mathcal{V}$ is the set of undominated principal utility functions;
- $\underline{\text{und}} \mathcal{V} \subset \text{und } \mathcal{V}$ is the set of undominated principal utility functions that are strictly suboptimal for every probability density $f \in L^\infty(\Theta)$ that is uniformly bounded away from 0;
- $\text{exp}_+ \mathcal{V} \subset \mathcal{V}$ is the set of principal utility functions that are *uniquely* optimal for some probability density $f \in L^\infty(\Theta)$ that is uniformly bounded away from 0. Note $\text{exp}_+ \mathcal{V} \subset \text{und } \mathcal{V} \cap \text{ext } \mathcal{V}$.

As usual, we write $\langle V, f \rangle = \int_\Theta V(\theta) f(\theta) d\theta$.

Proposition D.6. $\text{exp}_+ \mathcal{V}$ is dense in $\text{ext } \mathcal{V} \cap \text{und } \mathcal{V}$.

We proof the result in three steps. The argument for the first Lemma is inspired by the argument for Theorem 9 in Manelli and Vincent (2007); note the correction in Manelli and Vincent (2012).

Lemma D.7. $\underline{\text{und}} \mathcal{V} \subseteq \text{cl conv}(\text{exp}_+ \mathcal{V})$.

Proof. Fix any $V \in \underline{\text{und}} \mathcal{V}$. We show the claim by constructing a convergent sequence of points in \mathcal{V} that are convex combinations of points in $\text{exp}_+ \mathcal{V}$ with limit V .

For $\varepsilon \geq 0$, let

$$F_\varepsilon = \{f \in L^\infty(\Theta) \mid \varepsilon \leq f \leq 1\}.$$

Up to renormalization, these functions are essentially bounded probability densities that are uniformly bounded away from zero. By the Banach-Alaoglu theorem, F_ε is weak*-compact because it is a weak*-closed subset of the dual unit ball.⁴⁶

Recall that $V \in \underline{\text{nd}}\mathcal{V}$, i.e., V is strictly suboptimal for every density $f \in L^\infty(\Theta)$ that is uniformly bounded away from 0. Thus, for every $f \in F_\varepsilon$, there exists $V_f \in \mathcal{V}$ such that

$$\langle V_f, f \rangle > \langle V, f \rangle.$$

By the continuity of the evaluation (see e.g. Aliprantis and Border, 2007, Corollary 6.40), for every $f \in F_\varepsilon$, there exists a weak*-open neighborhood O_f of f such that for all $f' \in O_f$,

$$\langle V_f, f' \rangle > \langle V, f' \rangle.$$

Thus, $\{O_f : f \in F_\varepsilon\}$ is a weak*-open cover of F_ε .

By compactness, the open cover $\{O_f : f \in F_\varepsilon\}$ has a finite subcover $\{O_m : m = 1, \dots, M\}$. The functionals $f \in F_\varepsilon$ that expose a point in \mathcal{V} are norm-dense in F_ε (see e.g. Lau (1976) and note that F_ε has non-empty interior). Thus, for every $m = 1, \dots, M$, there exists $f' \in O_m$ such that $V_m := V_{f'} \in \exp \mathcal{V}$.

Let

$$G = \{(\langle V_1 - V, f \rangle, \dots, \langle V_m - V, f \rangle) \mid f \in F_\varepsilon\} \subset \mathbb{R}^M.$$

The set G is

- convex (because F_ε is convex);
- compact (because it is the continuous image of a weak*-compact set);
- and satisfies $G \cap \mathbb{R}_-^M = \emptyset$ (by construction of the open cover $\{O_m : m = 1, \dots, M\}$), where \mathbb{R}_-^M is the negative orthant.

By the Separating Hyperplane Theorem, there exists a vector $\alpha \in \mathbb{R}_+^M \setminus \{0\}$, such that $\alpha \cdot y > 0$ for all $y \in G$. Renormalize $\sum_{i=1}^M \alpha_i = 1$.

Define

$$\tilde{V}_\varepsilon = \sum_{i=1}^M \alpha_i V_i.$$

Note $\tilde{V}_\varepsilon \in \mathcal{V}$ since \mathcal{V} is convex. For all $f \in F_\varepsilon$,

$$\langle \tilde{V}_\varepsilon, f \rangle - \langle V, f \rangle = \alpha \cdot (\langle V_1 - V, f \rangle, \dots, \langle V_m - V, f \rangle) > 0.$$

Now consider a sequence $\varepsilon_n \rightarrow 0$ and the corresponding sequence of $\tilde{V}_{\varepsilon_n}$ constructed above. Since \mathcal{V} is norm-compact, a subsequence of $(\tilde{V}_{\varepsilon_n})$ converges to some $\tilde{V} \in \mathcal{V}$.

We show $\tilde{V} = V$, which proves the claim. Recall that V is undominated and suppose $\tilde{V} \neq V$. Then there exists a set $\tilde{\Theta} \subset \Theta$ of non-zero (spherical) measure such that $V(\theta) > \tilde{V}(\theta)$ for all $\theta \in \tilde{\Theta}$. Thus, any density f concentrated on $\tilde{\Theta}$ is such that

$$\langle V, f \rangle > \langle \tilde{V}, f \rangle.$$

By norm-norm continuity of the evaluation, there exists a strictly positive density f' and some $\tilde{V}_{\varepsilon_n}$ for n large enough such that

$$\langle V, f' \rangle > \langle \tilde{V}_{\varepsilon_n}, f' \rangle,$$

a contradiction. □

⁴⁶Recall that by the Riesz representation theorem, every continuous linear functional on $L^1(\Theta)$ can be represented by a function in $L^\infty(\Theta)$.

Proof of Theorem 8.2. Follows from the proof for Lemma D.7 with $\varepsilon = 0$. \square

We now extend Lemma D.7 to cover all undominated mechanisms.

Lemma D.8. $\text{und } \mathcal{V} \subseteq \text{cl conv}(\text{exp}_+ \mathcal{V})$.

Proof. Suppose not, i.e., $V \in \text{und } \mathcal{V} \setminus \text{cl conv}(\text{exp}_+ \mathcal{V})$. By Lemma D.7, $V \notin \underline{\text{und}} \mathcal{V}$, i.e., V is optimal for some density $f^* \in L^\infty(\Theta)$ that is uniformly bounded away from 0.

Since $\text{cl conv}(\text{exp}_+ \mathcal{V})$ is a closed subset of the norm-compact set \mathcal{V} , it is norm-compact. By the Hahn-Banach Separation Theorem, there exists $f \in L^\infty(\Theta)$ such that

$$\langle V, f \rangle > \max_{V' \in \text{cl conv}(\text{exp}_+ \mathcal{V})} \langle V', f \rangle.$$

$\tilde{f} = \varepsilon f + (1 - \varepsilon)f^*$ is still uniformly bounded away from 0 for $\varepsilon \in (0, 1)$ small enough and, moreover, for $\varepsilon \in (0, 1)$ small enough

$$\langle V, \tilde{f} \rangle > \max_{V' \in \text{cl conv}(\text{exp}_+ \mathcal{V})} \langle V', \tilde{f} \rangle.$$

by norm-norm continuity of the evaluation and Berge's maximum theorem (for the RHS). By the result of Lau (1976) used in Lemma D.7, there is another density \hat{f} arbitrarily close to \tilde{f} and therefore also uniformly bounded away from ε that exposes a point $\hat{V} \in \mathcal{V}$. Again by continuity and Berge's maximum theorem,

$$\langle V, \hat{f} \rangle > \max_{V' \in \text{cl conv}(\text{exp}_+ \mathcal{V})} \langle V', \hat{f} \rangle.$$

By definition, $\langle \hat{V}, \hat{f} \rangle > \langle V, \hat{f} \rangle$. Thus, the point \hat{V} exposed by \hat{f} cannot be in $\text{exp}_+ \mathcal{V}$, a contradiction. \square

We complete the proof of Proposition D.6.

Proof of Proposition D.6. The claim is a consequence of Milman's theorem (see e.g. Klee Jr, 1957, Theorem 1.1.). The theorem implies that $\text{ext cl conv}(\text{exp}_+ \mathcal{V}) \subseteq \text{cl exp}_+ \mathcal{V}$ since $\text{cl conv}(\text{exp}_+ \mathcal{V})$ is compact and convex. In particular, by Lemma D.8, every undominated extreme point of \mathcal{V} must be in $\text{cl conv}(\text{exp}_+ \mathcal{V})$. But since $\text{cl conv}(\text{exp}_+ \mathcal{V})$ is a convex subset of \mathcal{V} , every undominated extreme point of \mathcal{V} must also be in $\text{ext cl conv}(\text{exp}_+ \mathcal{V})$ and therefore arbitrarily close to a point in $\text{exp}_+ \mathcal{V}$. \square

D.5.2. *Multi-Good Monopoly.* We proceed with the multi-good monopoly problem. To follow the standard terminology in mechanism design with transfers, we abuse language and refer to elements of $[0, 1]^m$ as types and allocations, and consider mechanisms and indirect utility functions as functions defined on $[0, 1]^m$. In line with standard notation, we also write $(x, t) \in \mathcal{X}$ to separate the "allocation component" of a mechanism from the "transfer component."

We use the following lemma about undominated mechanisms in the upcoming arguments.

Lemma D.9 (Manelli and Vincent, 2007, Lemma 11). *Suppose $(x', t') \in \mathcal{X}$ and $(x, t) \in \mathcal{X}$ with indirect utility functions U' and U , respectively, are such that $t' \geq t$ almost everywhere. Then, for all $\theta \in [0, 1]^m$ and $\lambda\theta \in [0, 1]^m$ with $\lambda > 1$,*

- (1) $U'(\theta) > U(\theta) \implies U'(\lambda\theta) > U(\lambda\theta);$
- (2) $U'(\theta) \geq U(\theta) \implies U'(\lambda\theta) \geq U(\lambda\theta).$

Proof of Lemma 8.3. It is without loss of generality to consider only pricing functions with marginal prices in $[0, 1]$ because types are in $[0, 1]^m$.

Now consider a pricing function p with marginal prices in $[\delta, 1 - \delta]$ for some $\delta > 0$. Let $(x, t) \in \mathcal{X}$ be the mechanism obtained from p , and let U be the associated indirect utility function. For the sake of contradiction, suppose $(x', t') \in \mathcal{X}$ dominates (x, t) , and let U' be the associated indirect utility function.

Since marginal prices are in $[\delta, 1 - \delta]$, we have $U'(\theta) \geq U(\theta) = 0$ for all $\theta \leq (\delta, \dots, \delta)$. By Lemma D.9, we have $U' \geq U$. Thus, there is a type $\theta \in [0, 1]^m$ such that $U'(\theta) > U(\theta)$ (otherwise x and x' are payoff-equivalent). By the continuity of indirect utility functions, we may assume $\theta \in (0, 1)^m$.

Let $\lambda^1 > 1$ be the largest scalar such that $\theta^1 = \lambda^1 \theta \in [0, 1 - \frac{\delta}{2}]^m$, and let $i = 1, \dots, m$ be such that $\theta_i^1 = 1 - \frac{\delta}{2}$. Without loss of generality, suppose $i = 1$. By Lemma D.9, we have $U'(\theta^1) > U(\theta^1)$.

Consider the subspace $H^1 = \{\theta \in [0, 1]^m \mid \theta_1 = 1 - \frac{\delta}{2}\}$. Up to an arbitrarily small translation of H^1 in coordinate direction $\pm e_1$, we may assume by Fubini's Theorem that $x'(\theta) \cdot \theta \geq x(\theta) \cdot \theta$ for almost every $\theta \in H^1$ (with respect to $m - 1$ -dimensional Lebesgue measure) because $U' \geq U$ and $t' \geq t$ almost everywhere. For all $\theta \in H^1$, we have $x_i(\theta) = 1$ since $\theta_i > 1 - \delta$ and marginal prices are in $[\delta, 1 - \delta]$. Together with dominance, we have $x'(\theta) \cdot (0, \theta_{-1}) \geq x(\theta) \cdot (0, \theta_{-1})$ for almost every $\theta \in H^1$.

Now let $\lambda^2 > 1$ be the largest scalar such that $\theta^2 = (\theta_1^1, \lambda^2 \theta_{-1}^1) \in [0, 1 - \frac{\delta}{2}]^m$, and let $i = 2, \dots, m$ be such that $\theta_i^2 = 1 - \frac{\delta}{2}$. Without loss of generality, suppose $i = 2$. By the same arguments as for the proof of Lemma D.9, we have $U'(\theta^2) > U(\theta^2)$.

Iteratively proceed with this argument, constructing a sequence of affine subspaces (H^1, \dots, H^m) and types $(\theta^1, \dots, \theta^m)$, where $\theta_k^i = 1 - \frac{\delta}{2}$ for all $i = 1, \dots, m$ and $k \leq i$, such that $U'(\theta^i) > U(\theta^i)$ for all $i = 1, \dots, m$ and $x_k^i = 1$ for all $i = 1, \dots, m$ and $k \leq i$.

Finally, $U'(\theta^m) > U(\theta^m)$ implies $U'(\theta) = x'(\theta) \cdot \theta - t'(\theta) > x(\theta) \cdot \theta - t(\theta) = U(\theta)$ for all $\theta \in B(\theta^m)$ by continuity, where $B(\theta^m)$ is a sufficiently small ball around θ^m . We also have $x(\theta) = (1, \dots, 1)$ for all $\theta > (1 - \delta, \dots, 1 - \delta)$ since marginal prices are in $[\delta, 1 - \delta]$. Thus, $t'(\theta) < t(\theta)$ for all $\theta \in B(\theta^m)$, a contradiction with dominance. \square

Proof of Corollary 8.4. Take any pricing function p with marginal prices in $[0, 1]$. Then, for $\varepsilon > \delta > 0$ small enough, the pricing function $p'(a) = (1 - \varepsilon)p(a) + \delta a$ has marginal prices uniformly bounded away from 0 and 1. Moreover, the epigraphs $\text{epi } p$ and $\text{epi } p'$ of p and p' , respectively, are arbitrarily close in the Hausdorff distance. Thus, the extended menus $M = \text{epi } p + \Theta^\circ$ and $M' = \text{epi } p' + \Theta^\circ$ are arbitrarily close in the Hausdorff distance (Lemma A.6). By Lemma A.7, the associated mechanisms x and x' , respectively, are arbitrarily close in L^1 . By Lemma 8.3, x' is undominated. \square

Proof of Theorem 8.5. The argument for why the undominated extreme points are dense in the set of (IC) and (IR) mechanisms when $m \geq 2$ is analogous to the arguments in the proofs for Section 6 in Appendix D.3. By Corollary 8.4, for every $(x, t) \in \mathcal{X}$, find $(x', t') \in \mathcal{X}$ arbitrarily close to (x, t) with marginal prices bounded away from 0 and 1. Then follow the construction for Corollary 6.5 and then the construction for Theorem 6.4. As long as all perturbations are small enough, the constructed extreme point still has marginal prices bounded away from 0 and 1 and is hence undominated.

We complete the the proof by showing that the mechanisms that are uniquely optimal for some type distribution are dense in the undominated mechanisms.

We first show that if $(x, t), (x', t') \in \mathcal{X}$ are undominated and $t = t'$ almost everywhere, then $x = x'$ almost everywhere. It is easy to show (e.g., using Euler's homogenous function theorem) that $x - x'$ is constant on almost every ray from the origin, i.e., HD0 up to tie-breaking. It therefore suffices to show that for every undominated mechanism $(x, t) \in \mathcal{X}$, $\lim_{\theta \rightarrow 0} x(\theta) = 0$ (independently of the choice of sequence). Let p denote the pricing function associated with x and assume, for the sake of contradiction, that $\lim_{\theta \rightarrow 0} x(\theta) = a^* \neq 0$. Then, $p(a) = 0$ for all $a \leq a^*$. Define a mechanism $(x', t') \in \mathcal{X}$ by letting the agent buy from another pricing schedule

$$p'(a) = \begin{cases} p(a + a^*) & \text{if } a + a^* \in [0, 1]^m; \\ \max_{a \in \text{menu}(x)} p(a) + \varepsilon & \text{otherwise,} \end{cases}$$

where $\varepsilon > 0$. By construction, $p'(0) = 0$; thus, (x', t') is IC and IR. Since p' is obtained from p by translation of the graph of p in direction $-a^*$ with a new price $\max_{a \in [0, 1]^m} p(a) + \varepsilon$ for the grand bundle $a = 1$, almost every type either buys the same allocation as under p translated by $-a^*$ or the grand bundle. Thus, $t' \geq t$ almost everywhere. For all sufficiently small $\varepsilon > 0$, a positive measure of types will buy the grand bundle. Thus, (x', t') dominates (x, t) , a contradiction.

We next claim that $\text{ext } \mathcal{V} \cap \text{und } \mathcal{V}$ is dense in $\text{und } \mathcal{V}$, where \mathcal{V} is the set of IC transfer functions. If $(x, t) \in \text{ext } \mathcal{X}$ is undominated, then $t \in \text{ext } \mathcal{V}$. To see this, suppose $t = \frac{1}{2}t' + \frac{1}{2}t'' \notin \text{ext } \mathcal{V}$ for $t', t'' \in \mathcal{V}$. Define $\tilde{x} = \frac{1}{2}x' + \frac{1}{2}x'' \in \mathcal{X}$, where $x', x'' \in \mathcal{X}$ induce transfer t' and t'' , respectively. By definition, x and \tilde{x} both induce t . Thus, $x = \tilde{x}$ by the previous paragraph, so $x \notin \text{ext } \mathcal{X}$. The claim now follows because the undominated mechanisms in $\text{ext } \mathcal{X}$ are dense in the undominated mechanisms in \mathcal{X} .

Fix any undominated mechanism $(x, t) \in \mathcal{X}$. By Proposition D.6 and the previous paragraph, there exists a sequence of transfer functions $(t_n)_{n \in \mathbb{N}} \subset \text{exp}_+ \mathcal{V}$, each uniquely optimal for some type distribution μ , converging to t in L^1 . We have shown above that the associated sequence of allocation rules $(x_n)_{n \in \mathbb{N}}$ is uniquely determined. Since \mathcal{X} is compact, up to taking a subsequence, $(x_n, t_n)_{n \in \mathbb{N}}$ converges in L^1 to some $(x', t) \in \mathcal{X}$. But (x, t) is undominated, hence $x = x'$, as desired. \square

D.5.3. *Linear Veto Bargaining.* We proceed with the linear veto bargaining problem.

Proof of Lemma 8.6. We first show that the conditions given in the statement are necessary. For this, fix any mechanism $x \in \mathcal{X}$. It is clear that $a \in \text{menu}(x)$ for otherwise x does not satisfy (IR) since there is a type θ for which a is their (unique) most preferred alternative in A . Next suppose $\text{menu}(x)$ does not contain the principal's (unique) favorite alternative $a^* \in \text{ext } A$. Obtain a new mechanism $x' \in \mathcal{X}$ by letting the agent choose from $\text{menu}(x) \cup \{a^*\}$. Thus, for all $\theta \in \Theta$, either $x'(\theta) = x(\theta)$ or $x'(\theta) = a^*$. Since $a^* \in \text{ext } A$, there is a positive measure of types for which a^* is their most preferred allocation in A . Thus, x' dominates x .

For sufficiency, let $a^* \in \text{ext } A$ be the principal's favorite alternative and suppose $x, x' \in \mathcal{X}$ are such that $a^* \in \text{menu}(x), \text{menu}(x')$ and $x(\theta) \cdot \bar{v} \geq x'(\theta) \cdot \bar{v}$ for almost all $\theta \in \Theta$. We show that $x = x'$ almost everywhere. We extend both mechanisms to $\text{cone } \Theta = \mathbb{R}^d$ by letting each type chose their favorite allocation in $\text{menu}(x)$ and $\text{menu}(x')$ (x and x' are constant along

almost every ray from the origin). Let U and U' be the agent's indirect utility functions associated with x and x' , respectively.

We claim that for all $\theta \in \text{cone } \Theta$ and $\lambda \in \mathbb{R}$,

$$\phi_\theta(\lambda) := U(\theta + \lambda\bar{v}) = U(\theta) + \int_0^\lambda \langle x(\theta + z\bar{v}), \bar{v} \rangle dz$$

and analogously for ϕ'_θ , x' , and U' . Recall that $x(\theta) = \partial U(\theta)$ and $x'(\theta) = \partial U'(\theta)$ (Theorem A.2). $\phi_\theta(\lambda)$ is the restriction of a continuous convex function to a line, hence continuous and convex. It is easy to verify that $\langle x(\theta + \lambda\bar{v}), \bar{v} \rangle$ as a function of λ is a subgradient of $\phi_\theta(\lambda)$. Hence the envelope formula follows (Rockafellar, 1997, Theorem 24.2).

By Fubini's theorem, $\phi_\theta(\lambda) - \phi'_\theta(\lambda)$ is non-decreasing for almost all $\theta \in \text{cone } \Theta$ because $x(\theta + \lambda\bar{v}) \cdot \bar{v} \geq x'(\theta + \lambda\bar{v}) \cdot \bar{v}$ for almost all $\theta \in \text{cone } \Theta$ and all $\lambda \in \mathbb{R}$.

For all sufficiently large $\lambda > 0$, we have $x(\theta + \lambda\bar{v}) = x'(\theta + \lambda\bar{v}) = a^*$ since $a^* \in \text{ext } A$ is the principal's, i.e., type \bar{v} 's, (unique) favorite alternative in A and thus the favorite alternative of type $\theta + \lambda\bar{v}$. Thus, $\phi_\theta(\lambda) - \phi'_\theta(\lambda) = 0$ for all sufficiently large $\lambda > 0$.

Similarly, for all sufficiently small $\lambda < 0$, we have $x(\theta + \lambda\bar{v}) = x'(\theta + \lambda\bar{v}) = \underline{a}$ since \underline{a} is, by assumption, the principal's (unique) least preferred alternative and the principal's and agent's preferences are sufficiently aligned.

Thus, for almost every $\theta \in \text{cone } \Theta$ and every $\lambda \in \mathbb{R}$, we have $\phi_\theta(\lambda) = \phi'_\theta(\lambda)$ since $\phi_\theta(\lambda) - \phi'_\theta(\lambda)$ is non-decreasing. Put differently, $U = U'$ almost everywhere. By continuity, $U = U'$. Consequently, $x = x'$ almost everywhere. \square

Proof of Theorem 8.7. The argument for statement (1) is immediate from Theorem 7.2 and Lemma 8.6. We proceed with statement (2).

The argument for why the undominated extreme points are dense in the undominated mechanisms when $m \geq 4$ is completely analogous to the proofs of Corollary 6.5 and Theorem 6.4 when making sure that $\underline{a}, a^* \in V$, where a^* is the principal's favorite alternative and V is the set of vertices constructed in the proof of Theorem 6.4.

We complete the the proof by showing that the mechanisms that are uniquely optimal for some type distribution are dense in the undominated mechanisms.

The proof of Lemma 8.6 shows that if $x, x' \in \mathcal{X}$ are undominated and such that $x(\theta) \cdot \bar{v} = x'(\theta) \cdot \bar{v}$ for almost every $\theta \in \Theta$, then $x = x'$ almost everywhere. Thus, an undominated principal utility function uniquely determines an undominated mechanism.

We claim that $\text{ext } \mathcal{V} \cap \text{und } \mathcal{V}$ is dense in $\text{und } \mathcal{V}$. If $x \in \text{ext } \mathcal{X}$ is undominated, then the induced principal utility function $V \in \mathcal{V}$ is in $\text{ext } \mathcal{V}$. To see this, suppose $V = \frac{1}{2}V' + \frac{1}{2}V'' \notin \text{ext } \mathcal{V}$ for $V', V'' \in \mathcal{V}$. Define $\tilde{x} = \frac{1}{2}x' + \frac{1}{2}x'' \in \mathcal{X}$, where $x', x'' \in \mathcal{X}$ induce V' and V'' , respectively. By definition, x and \tilde{x} both induce v . Thus, $x = \tilde{x}$ by the previous paragraph, so $x \notin \text{ext } \mathcal{X}$. The claim now follows because the undominated mechanisms in $\text{ext } \mathcal{X}$ are dense in the undominated mechanisms in \mathcal{X} .

Fix any undominated mechanism $x \in \mathcal{X}$. Let $V \in \mathcal{V}$ be the associated principal utility function. By Proposition D.6 and the previous paragraph, there is a sequence $(V_n)_{n \in \mathbb{N}} \subset \text{exp}_+ \mathcal{V}$ of uniquely optimal undominated principal utility functions converging to V . Let $(x_n)_{n \in \mathbb{N}} \subset \text{ext } \mathcal{X}$ be the sequence of mechanisms that is uniquely determined by $(V_n)_{n \in \mathbb{N}}$. (By definition, each mechanism in the sequence is uniquely optimal for some type distribution.) By compactness of \mathcal{X} , up to taking a subsequence, $x_n \rightarrow x' \in \mathcal{X}$. By continuity of the map that assigns to each mechanism in \mathcal{X} a principal utility function in \mathcal{V} , x' must induce V since

$V_n \rightarrow V$. Therefore, x' is undominated. Thus, $x = x'$ almost everywhere, which completes the proof. \square

REFERENCES

- Adams, William James and Janet L Yellen (1976). “Commodity Bundling and the Burden of Monopoly”. In: *The Quarterly Journal of Economics* 90.3, pp. 475–498.
- Ali, S Nageeb, Navin Kartik, and Andreas Kleiner (2023). “Sequential veto bargaining with incomplete information”. In: *Econometrica* 91.4, pp. 1527–1562.
- Aliprantis, Charalambos D and Kim C Border (2007). *Infinite Dimensional Analysis: A Hitchhiker’s Guide*. Springer Science & Business Media.
- Alonso, Ricardo and Niko Matouschek (2008). “Optimal delegation”. In: *The Review of Economic Studies* 75.1, pp. 259–293.
- Amador, Manuel and Kyle Bagwell (2013). “The theory of optimal delegation with an application to tariff caps”. In: *Econometrica* 81.4, pp. 1541–1599.
- (2022). “Regulating a monopolist with uncertain costs without transfers”. In: *Theoretical Economics* 17.4, pp. 1719–1760.
- Arieli, Itai, Yakov Babichenko, Rann Smorodinsky, and Takuro Yamashita (2023). “Optimal persuasion via bi-pooling”. In: *Theoretical Economics* 18.1, pp. 15–36.
- Armstrong, Mark (1996). “Multiproduct nonlinear pricing”. In: *Econometrica: Journal of the Econometric Society*, pp. 51–75.
- (1999). “Price discrimination by a many-product firm”. In: *The Review of Economic Studies* 66.1, pp. 151–168.
- Armstrong, Mark and John Vickers (2010). “A model of delegated project choice”. In: *Econometrica* 78.1, pp. 213–244.
- Babaioff, Moshe, Yannai A Gonczarowski, and Noam Nisan (2017). “The menu-size complexity of revenue approximation”. In: *Proceedings of the 49th Annual ACM SIGACT Symposium on Theory of Computing*, pp. 869–877.
- Babaioff, Moshe, Nicole Immorlica, Brendan Lucier, and S Matthew Weinberg (2020). “A simple and approximately optimal mechanism for an additive buyer”. In: *Journal of the ACM (JACM)* 67.4, pp. 1–40.
- Babaioff, Moshe, Noam Nisan, and Aviad Rubinstein (2018). “Optimal Deterministic Mechanisms for an Additive Buyer”. In: *arXiv preprint arXiv:1804.06867*. URL: <https://arxiv.org/abs/1804.06867>.
- Bakos, Yannis and Erik Brynjolfsson (1999). “Bundling information goods: Pricing, profits, and efficiency”. In: *Management Science* 45.12, pp. 1613–1630.
- Baldwin, Elizabeth and Paul Klemperer (2019). “Understanding Preferences: “Demand Types”, and the Existence of Equilibrium with Indivisibilities”. In: *Econometrica* 87.3, pp. 867–932.
- Bedard, Nicholas C. and Jacob K. Goeree (2023). “Tropical Analysis: With an Application to Indivisible Goods”. In: *arXiv preprint arXiv:2308.04593*. URL: <https://arxiv.org/abs/2308.04593>.
- Ben-Moshe, Ran, Sergiu Hart, and Noam Nisan (2022). “Monotonic Mechanisms for Selling Multiple Goods”. In: *arXiv preprint arXiv:2210.17150*.
- Ben-Porath, Elchanan, Eddie Dekel, and Barton L Lipman (2014). “Optimal Allocation with Costly Verification”. In: *American Economic Review* 104.12, pp. 3779–3813.
- Bergemann, Dirk, Alessandro Bonatti, Andreas Haupt, and Alex Smolin (2021). “The optimality of upgrade pricing”. In: *International Conference on Web and Internet Economics*. Springer, pp. 41–58.

- Bikhchandani, Sushil, Shurojit Chatterji, Ron Lavi, Ahuva Mu'alem, Noam Nisan, and Arunava Sen (2006). “Weak monotonicity characterizes deterministic dominant-strategy implementation”. In: *Econometrica* 74.4, pp. 1109–1132.
- Bikhchandani, Sushil and Debasis Mishra (2022). “Selling two identical objects”. In: *Journal of Economic Theory* 200, p. 105397.
- Blaschke, Wilhelm and Georg Pick (1916). “Distanzschätzungen im Funktionenraum II”. In: *Mathematische Annalen* 77.2, pp. 277–300.
- Border, Kim C. (1991). “Implementation of reduced form auctions: A geometric approach”. In: *Econometrica: Journal of the Econometric Society*, pp. 1175–1187.
- Börgers, Tilman (2015). *An Introduction to the Theory of Mechanism Design*. Oxford University Press, USA.
- Börgers, Tilman and Peter Postl (2009). “Efficient compromising”. In: *Journal of Economic Theory* 144.5, pp. 2057–2076.
- Bronshtein, Efim Mikhailovich (1978). “Extremal convex functions”. In: *Siberian Mathematical Journal* 19.1, pp. 6–12.
- Cai, Yang, Nikhil R Devanur, and S Matthew Weinberg (2019). “A duality-based unified approach to bayesian mechanism design”. In: *SIAM Journal on Computing* 50.3, STOC16–160.
- Carroll, Gabriel (2017). “Robustness and separation in multidimensional screening”. In: *Econometrica* 85.2, pp. 453–488.
- Castillo, Federico and Fu Liu (2022). “Deformation cones of nested braid fans”. In: *International Mathematics Research Notices* 2022.3, pp. 1973–2026.
- Chakraborty, Indranil (1999). “Bundling decisions for selling multiple objects”. In: *Economic Theory* 13.3, pp. 723–733.
- Che, Yeon-Koo, Wouter Dessein, and Navin Kartik (2013a). “Pandering to persuade”. In: *American Economic Review* 103.1, pp. 47–79.
- Che, Yeon-Koo, Jinwoo Kim, and Konrad Mierendorff (2013b). “Generalized Reduced-Form Auctions: A Network-Flow Approach”. In: *Econometrica* 81.6, pp. 2487–2520.
- Che, Yeon-Koo and Weijie Zhong (2023). “Robustly Optimal Mechanisms for Selling Multiple Goods”. In: *arXiv preprint*.
- Chen, Yi-Chun, Wei He, Jiangtao Li, and Yeneng Sun (2019). “Equivalence of stochastic and deterministic mechanisms”. In: *Econometrica* 87.4, pp. 1367–1390.
- Daskalakis, Constantinos, Alan Deckelbaum, and Christos Tzamos (2014). “The complexity of optimal mechanism design”. In: *Proceedings of the twenty-fifth annual ACM-SIAM symposium on Discrete algorithms*. SIAM, pp. 1302–1318.
- (2017). “Strong Duality for a Multiple-Good Monopolist”. In: *Econometrica* 85, pp. 735–767.
- Deb, Rahul and Anne-Katrin Roesler (2023). “Multi-Dimensional Screening: Buyer-Optimal Learning and Informational Robustness”. In: *The Review of Economic Studies*, rdad100.
- Dekel, Eddie, Barton L Lipman, and Aldo Rustichini (2001). “Representing preferences with a unique subjective state space”. In: *Econometrica* 69.4, pp. 891–934.
- Diestel, J. and J. J. Jr. Uhl (1977). *Vector Measures*. Math. Surveys 15. Providence, R.I.: American Mathematical Society.
- Doval, Laura, Ran Eilat, Tianhao Liu, and Yangfan Zhou (2024). “Revealed Information”. In: *arXiv preprint arXiv:2411.13293*.
- Fang, Hanming and Peter Norman (2006). “To bundle or not to bundle”. In: *The RAND Journal of Economics* 37.4, pp. 946–963.
- Frankel, Alex (2016). “Delegating multiple decisions”. In: *American Economic Journal: Microeconomics* 8.4, pp. 16–53.
- Frankel, Alexander (2014). “Aligned delegation”. In: *American Economic Review* 104.1, pp. 66–83.

- Frick, Mira, Ryota Iijima, and Yuhta Ishii (2024). “Multidimensional Screening with Rich Consumer Data”. In.
- Frongillo, Rafael M and Ian A Kash (2021). “General truthfulness characterizations via convex analysis”. In: *Games and Economic Behavior* 130, pp. 636–662.
- Gale, David (1954). “Irreducible convex sets”. In: *Proceedings of the International Congress of Mathematicians, Amsterdam 2*, pp. 217–218.
- Ghili, Soheil (2023). “A Characterization for Optimal Bundling of Products with Nonadditive Values”. In: *American Economic Review: Insights* 5.3, pp. 311–326.
- Gopalan, Parikshit, Noam Nisan, and Tim Roughgarden (2018). “Public projects, Boolean functions, and the borders of Border’s theorem”. In: *ACM Transactions on Economics and Computation (TEAC)* 6.3-4, pp. 1–21.
- Grünbaum, Branko, Victor Klee, Micha A Perles, and Geoffrey Colin Shephard (1967). *Convex polytopes*. Vol. 16. Springer.
- Grzaślewicz, Ryszard (1984). “Extreme convex sets in \mathbb{R}^2 ”. In: *Archiv der Mathematik* 43, pp. 377–380.
- Gul, Faruk and Wolfgang Pesendorfer (2006). “Random expected utility”. In: *Econometrica* 74.1, pp. 121–146.
- Guo, Yingni and Eran Shmaya (2023). “Regret-Minimizing Project Choice”. In: *Econometrica* 91.5, pp. 1567–1593.
- Haghpanah, Nima and Jason Hartline (2021). “When is pure bundling optimal?” In: *The Review of Economic Studies* 88.3, pp. 1127–1156.
- Hart, Sergiu and Noam Nisan (2017). “Approximate revenue maximization with multiple items”. In: *Journal of Economic Theory* 172, pp. 313–347.
- (2019). “Selling multiple correlated goods: Revenue maximization and menu-size complexity”. In: *Journal of Economic Theory* 183, pp. 991–1029.
- Hart, Sergiu and Philip J Reny (2015). “Maximal revenue with multiple goods: Nonmonotonicity and other observations”. In: *Theoretical Economics* 10.3, pp. 893–922.
- (2019). “The better half of selling separately”. In: *ACM Transactions on Economics and Computation (TEAC)* 7.4, pp. 1–18.
- Hiriart-Urruty, Jean-Baptiste and Claude Lemaréchal (1996). *Convex Analysis and Minimization Algorithms I: Fundamentals*. Vol. 305. Springer Science & Business Media.
- Holmström, Bengt (1977). *On Incentives and Control in Organizations*. Stanford University.
- (1984). “On the theory of delegation”. In: *Bayesian Models in Economic Theory*. Ed. by B. Boyer and R. Kihlstrom. New York: North-Holland.
- Jehiel, Philippe, Moritz Meyer-Ter-Vehn, and Benny Moldovanu (2007). “Mixed bundling auctions”. In: *Journal of Economic Theory* 134.1, pp. 494–512.
- Jehiel, Philippe, Benny Moldovanu, and Ennio Stacchetti (1999). “Multidimensional mechanism design for auctions with externalities”. In: *Journal of economic theory* 85.2, pp. 258–293.
- Johansen, Søren (1974). “The extremal convex functions”. In: *Mathematica Scandinavica* 34.1, pp. 61–68.
- Kartik, Navin, Andreas Kleiner, and Richard Van Weelden (2021). “Delegation in veto bargaining”. In: *American Economic Review* 111.12, pp. 4046–4087.
- Klee, Victor (1959). “Some new results on smoothness and rotundity in normed linear spaces”. In: *Mathematische Annalen* 139.1, pp. 51–63.
- Klee Jr, Victor L (1957). “Extremal structure of convex sets”. In: *Archiv der Mathematik* 8.3, pp. 234–240.
- (1958). “Extremal structure of convex sets. II”. In: *Mathematische Zeitschrift* 69.1, pp. 90–104.
- Kleiner, Andreas (2022). “Optimal Delegation in a Multidimensional World”. In: *arXiv preprint arXiv:2208.11835*.

- Kleiner, Andreas and Alejandro Manelli (2019). “Strong Duality in Monopoly Pricing”. In: *Econometrica* 87.4, pp. 1391–1396.
- Kleiner, Andreas, Benny Moldovanu, and Philipp Strack (2021). “Extreme points and majorization: Economic applications”. In: *Econometrica* 89.4, pp. 1557–1593.
- Kleiner, Andreas, Benny Moldovanu, Philipp Strack, and Mark Whitmeyer (2024). “The Extreme Points of Fusions”. In: *arXiv preprint* arXiv:2409.10779. URL: <https://arxiv.org/abs/2409.10779>.
- Koessler, Frédéric and David Martimort (2012). “Optimal delegation with multi-dimensional decisions”. In: *Journal of Economic Theory* 147.5, pp. 1850–1881.
- Kolesnikov, Alexander V., Fedor Sandomirskiy, Aleh Tsyvinski, and Alexander P. Zimin (2022). “Beckmann’s Approach to Multi-Item Multi-Bidder Auctions”. In: *arXiv preprint* arXiv:2203.06837. URL: <https://arxiv.org/abs/2203.06837>.
- Kolotilin, Anton and Andriy Zapechelyuk (2019). “Persuasion Meets Delegation”. In: *arXiv preprint* arXiv:1902.02628. URL: <https://arxiv.org/abs/1902.02628>.
- Kováč, Eugen and Tymofiy Mylovanov (2009). “Stochastic mechanisms in settings without monetary transfers: The regular case”. In: *Journal of Economic Theory* 144.4, pp. 1373–1395.
- Lau, Ka-Sing (1976). “On strongly exposing functionals”. In: *Journal of the Australian Mathematical Society* 21.3, pp. 362–367.
- Li, Xinye and Andrew Chi-Chih Yao (2013). “On revenue maximization for selling multiple independently distributed items”. In: *Proceedings of the National Academy of Sciences* 110.28, pp. 11232–11237.
- Lu, Shu and Stephen M Robinson (2008). “Normal fans of polyhedral convex sets: Structures and connections”. In: *Set-Valued Analysis* 16.2, pp. 281–305.
- Maclagan, Diane and Bernd Sturmfels (2021). *Introduction to tropical geometry*. Vol. 161. American Mathematical Society.
- Manelli, Alejandro M and Daniel R Vincent (2006). “Bundling as an Optimal Selling Mechanism for a Multiple-Good Monopolist”. In: *Journal of Economic Theory* 127.1, pp. 1–35.
- (2007). “Multidimensional mechanism design: Revenue maximization and the multiple-good monopoly”. In: *Journal of Economic Theory* 137.1, pp. 153–185.
- (2010). “Bayesian and Dominant-Strategy Implementation in the Independent Private-Values Model”. In: *Econometrica* 78.6, pp. 1905–1938.
- (2012). “Multidimensional Mechanism Design: Revenue Maximization and the Multiple-Good Monopoly. A Corrigendum”. In: *Journal of Economic Theory* 148.6, pp. 2492–2493.
- Martimort, David and Aggey Semenov (2006). “Continuity in mechanism design without transfers”. In: *Economics Letters* 93.2, pp. 182–189.
- Maskin, Eric and John Riley (1984). “Optimal auctions with risk averse buyers”. In: *Econometrica: Journal of the Econometric Society*, pp. 1473–1518.
- Matthews, Steven A (1984). “On the implementability of reduced form auctions”. In: *Econometrica: Journal of the Econometric Society*, pp. 1519–1522.
- McAfee, R Preston, John McMillan, and Michael D Whinston (1989). “Multiproduct monopoly, commodity bundling, and correlation of values”. In: *The Quarterly Journal of Economics* 104.2, pp. 371–383.
- McMullen, Peter (1973). “Representations of polytopes and polyhedral sets”. In: *Geometriae dedicata* 2.1, pp. 83–99.
- Melumad, Nahum D and Toshiyuki Shibano (1991). “Communication in settings with no transfers”. In: *The RAND Journal of Economics*, pp. 173–198.
- Menicucci, Domenico, Sjaak Hurkens, and Doh-Shin Jeon (2015). “On the optimality of pure bundling for a monopolist”. In: *Journal of Mathematical Economics* 60, pp. 33–42.

- Meyer, Walter (1972). “Decomposing plane convex bodies”. In: *Archiv der Mathematik* 23.1, pp. 534–536.
- (1974). “Indecomposable Polytopes”. In: *Transactions of the American Mathematical Society* 190, pp. 77–86.
- Mielczarek, G (1998). “On extreme convex subsets of the plane”. In: *Acta Mathematica Hungarica* 78.3, pp. 213–226.
- Myerson, Roger B (1981). “Optimal Auction Design”. In: *Mathematics of Operations Research* 6.1, pp. 58–73.
- Niemeyer, Axel and Justus Preusser (2024). “Optimal Allocation with Peer Information”. In: *arXiv preprint arXiv:2410.08954*. URL: <https://arxiv.org/abs/2410.08954>.
- Nikzad, Afshin (2022). “Constrained majorization: Applications in mechanism design”. In: *Proceedings of the 23rd ACM Conference on Economics and Computation*, pp. 330–331.
- (2024). “Multi-Criteria Allocation Mechanisms: Constraints and Comparative Statics”. In: *Available at SSRN*. URL: https://papers.ssrn.com/sol3/papers.cfm?abstract_id=4695785.
- Nocke, Volker and Michael D. Whinston (2013). “Merger policy with merger choice”. In: *American Economic Review* 103.2, pp. 1006–1033.
- Palfrey, Thomas R (1983). “Bundling decisions by a multiproduct monopolist with incomplete information”. In: *Econometrica: Journal of the Econometric Society*, pp. 463–483.
- Pavlov, Gregory (2011). “Optimal mechanism for selling two goods”. In: *The BE Journal of Theoretical Economics* 11.1.
- Pineda Villavicencio, Guillermo (2024). *Polytopes and Graphs*. Cambridge Studies in Advanced Mathematics. Cambridge University Press.
- Riley, John and Richard Zeckhauser (1983). “Optimal selling strategies: When to haggle, when to hold firm”. In: *The Quarterly Journal of Economics* 98.2, pp. 267–289.
- Rochet, Jean-Charles (1987). “A necessary and sufficient condition for rationalizability in a quasi-linear context”. In: *Journal of Mathematical Economics* 16.2, pp. 191–200.
- Rochet, Jean-Charles and Philippe Choné (1998). “Ironing, sweeping, and multidimensional screening”. In: *Econometrica*, pp. 783–826.
- Rochet, Jean-Charles and Lars A Stole (2003). “The economics of multidimensional screening”. In: *Econometric Society Monographs* 35, pp. 150–197.
- Rockafellar, R Tyrrell and Roger J-B Wets (2009). *Variational Analysis*. Vol. 317. Springer Science & Business Media.
- Rockafellar, R. Tyrrell (1997). *Convex Analysis*. Vol. 1. Princeton University Press.
- Romer, Thomas and Howard Rosenthal (1978). “Political Resource Allocation, Controlled Agendas, and the Status Quo”. In: *Public Choice*, pp. 27–43.
- Rubinstein, Aviad and S Matthew Weinberg (2018). “Simple Mechanisms for a Subadditive Buyer and Applications to Revenue Monotonicity”. In: *ACM Transactions on Economics and Computation (TEAC)* 6.3-4, pp. 1–25.
- Saks, Michael and Lan Yu (2005). “Weak monotonicity suffices for truthfulness on convex domains”. In: *Proceedings of the 6th ACM Conference on Electronic Commerce*, pp. 286–293.
- Salinetti, Gabriella and Roger J-B Wets (1979). “On the convergence of sequences of convex sets in finite dimensions”. In: *SIAM Review* 21.1, pp. 18–33.
- Sallee, GT (1972). “Minkowski decomposition of convex sets”. In: *Israel Journal of Mathematics* 12, pp. 266–276.
- Saran, Rene (2022). “A Dynamic Optimization Approach to Delegation with an Application to Volunteer Contracts”. In: *Available at SSRN*. URL: https://papers.ssrn.com/sol3/papers.cfm?abstract_id=4703145.
- Schmalensee, Richard (1984). “Gaussian demand and commodity bundling”. In: *Journal of Business*, S211–S230.

- Schneider, Rolf (2014). *Convex Bodies: The Brunn–Minkowski Theory*. Vol. 151. Cambridge University Press.
- Shephard, Geoffrey C. (1963). “Decomposable convex polyhedra”. In: *Mathematika* 10.2, pp. 89–95.
- Silverman, Ruth (1973). “Decomposition of plane convex sets I”. In: *Pacific Journal of Mathematics* 47.2, pp. 521–530.
- Smilansky, Zeev (1987). “Decomposability of polytopes and polyhedra”. In: *Geometriae dedicata* 24.1, pp. 29–49.
- Tran, Ngoc Mai and Josephine Yu (2019). “Product-mix auctions and tropical geometry”. In: *Mathematics of Operations Research* 44.4, pp. 1396–1411.
- Valenzuela-Stookey, Quitzé (2023). “Interim Allocations and Greedy Algorithms”. Unpublished manuscript.
- Vohra, Rakesh V (2011). *Mechanism Design: A Linear Programming Approach*. Vol. 47. Cambridge University Press.
- Wilson, Robert B (1993). *Nonlinear Pricing*. Oxford University Press, USA.
- Winkler, Gerhard (1988). “Extreme points of moment sets”. In: *Mathematics of Operations Research* 13.4, pp. 581–587.
- Yang, Frank (2023). *Nested bundling*. <https://web.stanford.edu/~shuny/papers/bundling.pdf>.
- Yang, Kai Hao and Alexander K Zentefis (2024). “Monotone Function Intervals: Theory and Applications”. In: *American Economic Review* 114.8, pp. 2239–2270.