QLBM – A QUANTUM LATTICE BOLTZMANN SOFTWARE FRAMEWORK

A PREPRINT

✉ **Călin A. Georgescu**
Delft University of Technology
Mekelweg 4, 2628CD, Delft
c.a.georgescu@tudelft.nl

✉ **Merel A. Schalkers**
Delft University of Technology
Mekelweg 4, 2628CD, Delft
m.a.schalkers@tudelft.nl

✉ **Matthias Möller**
Delft University of Technology
Mekelweg 4, 2628CD, Delft
m.moller@tudelft.nl

December 2, 2024

ABSTRACT

We present QLBM, a Python software package designed to facilitate the development, simulation, and analysis of Quantum Lattice Boltzmann Methods (QBM). QLBM is a modular framework that introduces a quantum component abstraction hierarchy tailored to the implementation of novel QBMs. The framework interfaces with state-of-the-art quantum software infrastructure to enable efficient simulation and validation pipelines, and leverages novel execution and pre-processing techniques that significantly reduce the computational resources required to develop quantum circuits. We demonstrate the versatility of the software by showcasing multiple QBMs in 2D and 3D with complex boundary conditions, integrated within automated benchmarking utilities. Accompanying the source code are extensive test suites, thorough online documentation resources, analysis tools, visualization methods, and demos that aim to increase the accessibility of QBMs while encouraging reproducibility and collaboration. The source code of QLBM is publicly available under a permissive MPL 2.0 license at <https://github.com/QCFD-Lab/qlbm>.

Keywords Quantum computing · Lattice Boltzmann method · Quantum software · Computational fluid dynamics

1 Introduction

The field of Quantum Computing (QC) [50] has received a staggering amount of attention in recent decades from researchers and practitioners alike. Ever since the formulation of the first quantum algorithms in the early 1990s, quantum computing captured the interest and attention of scientists attempting to accelerate solvers for high impact, real-life problems. It was algorithms like those of Deutsch and Jozsa [23], Bernstein and Vazirani [9], Grover [30], and Shor [69] that initiated a wave of research aiming to understand how QC can revolutionize the status quo. Two properties make the quantum computing paradigm especially attractive for the increasingly demanding large-scale computational demands of today – exponential information compression and quantum parallelism. The former is a core property of the basic unit of quantum information: the quantum bit or qubit. Unlike classical bits, n qubits encode a superposition that can be represented through a 2^n -dimensional vector belonging to a complex Hilbert space. The latter, quantum parallelism, refers to the ability of quantum computers to simultaneously encode and update multiple results in a single computational step. Thanks to these two properties, QC carries the potential to augment the current computational landscape with a drastically different yet complementary archetype.

The drive to accelerate classical solvers by means of quantum computing has led to novel quantum algorithms that target nearly every branch of computational science. From quantum chemistry [53, 34, 16] to deep learning [67, 38], data mining [59, 46], and finance [52], quantum algorithms promise to augment or improve upon classical methods. One field where quantum computing advantages are particularly appealing is that of computational fluid dynamics (CFD). State-of-the-art CFD simulations are extremely memory- and compute-intensive applications that require tremendous amounts of resources to tackle modern engineering tasks. It is this computational capacity bottleneck, together with

growing concerns about Moore’s law’s [64] future viability that have attracted many researchers’ attention towards the potentially disruptive effect that QC could have for CFD simulations [28].

In recent years, several quantum methods for CFD applications have emerged. Here, we consider three standout directions for quantum CFD (QCFD) research. The first two largely center around the Navier-Stokes (NS) governing equations for large-scale, turbulence-minded applications. Techniques that attempt to directly (approximately) solve the NS equations with quantum computers are typically aimed at solving general linear systems of equations (LSE) under specific assumptions. In particular, the Harrow–Hassidim–Lloyd (HHL) [33] algorithm and its subsequent improvements [3, 21, 20] stand out, as they provide theoretical speedups over classical counterparts. However, in addition to the linearization of the NS equations, the viability of the HHL further hinges on state preparation and amplitude approximation techniques [1] which may not be practically feasible for CFD applications.

A second way in which quantum computers can solve LSEs consists of so-called variational quantum algorithms. Variational Quantum Linear Solvers (VQLS) such as those put forward by Bravo-Prieto et al. [11] and Patil et al. [55] attempt a task similar to that of HHL, but instead rely on parameterized quantum circuits, the parameters of which are iteratively improved. Recently, research has shown that such techniques could be used to solve Stokes flow [45] and the heat conduction equation [44]. Kyriienko et al. [41] also introduce a framework of differentiable quantum circuits and feature maps-based encodings and use it solve the quasi-1D NS equations, while Paine et al. [54] extend VQAs to support *kernel methods*, a technique of embedding data into higher-dimensional spaces [66], and demonstrate the ability to solve ordinary differential equations. An advantage of VQAs is their relatively shallow circuits, which makes them suitable candidates for the quantum hardware available today. However, they too suffer from several important limitations. Optimizing the parameters of VQAs is a computationally intensive task, that is delegated to classical computers. This introduces significant overhead not only in the classical optimization procedure of the parameters, but also in the the quantum-classical communication channel. Moreover, optimizing VQA circuits might not be computationally feasible, due to the barren plateau problem in quantum computing [48, 42].

The third way in which QCFD problems can be approached is through the quantum implementation of *Lattice Boltzmann Methods* (LBMs). This avenue presents modelling opportunities for exploiting the mathematical structure of the Boltzmann Equation and is entirely independent from classical optimization requirements. It is this direction that we seek to advance through this work. In what follows, we describe the current landscape of quantum LBM research before highlighting the challenges currently facing this field and how this work seeks to address them in Section 1.1. Section 1.2 describes the steps and the mathematical structure of the classical LBM.

Recently, quantum lattice Boltzmann methods (QBM) have emerged as promising candidates for the future direction of QCFD. The linearity of the streaming step and the locality of collision are two of the reasons why the LBM lends itself particularly well to native quantum implementations. Despite this, there are several inherent caveats that quantum implementations must address to simulate physically correct behavior. Most notably, these include the nonlinearity of the collision operator and the nonlocality of the streaming operator. These challenges stem from the fundamental properties of physical mesoscopic and macroscopic fluids, and are ubiquitous across many governing equations in science and engineering. One additional benefit of the LBM is that unlike in the Navier-Stokes equations, the nonlinearity and nonlocality are not directly coupled, which provides promising modelling opportunities. Supplementary to equation-specific nuances, effectively encoding information into and extracting it out of the quantum state are two universal hurdles of quantum algorithms. In an effort to overcome these challenges, research surrounding QBMs has largely focused on the development of quantum primitives that implement (parts of) the LBM time-marching loop. These initiatives have given rise to several techniques that accommodate specific subroutines of the LBM, imposing trade-offs between scalability and versatility. One way to categorize existing QBMs is by how they address the inherent nonlinearity of collision.

The initial wave of research into QCFD occurred between 2001 and 2003 and largely focused on extending the lattice-gas model to distributed quantum devices [81, 83, 82, 56]. This work tailors quantum lattice-gas solvers to a decentralized system of quantum computers with limited number of qubits per device, linked together through classical communication channels. Though this approach enables the balancing of the computational workload through horizontal scaling, it requires a number of qubits that grows linearly with the number of grid points of the lattice.

Todorova and Steijl [76] and Schalkers and Möller [61] propose *collisionless* methods that include primitives for particle streaming and boundary conditions, but omit the collision operator entirely. Steijl [72] and Moawad et al. [49] alternatively propose a method in which quantum primitives that implement floating point arithmetic can compute nonlinear terms, but require a reversible conversion between the encoding of the quantum state used to perform streaming and the encoding that enables the computation of the nonlinear velocity terms at each time step. Itani and Succi [36] and Sanavio and Succi [60] adopt an approach based on truncated Carleman linearization, that approximates the non-linear LBE by a finite-dimensional linear system of equations that can be expressed in terms of (unitary) quantum operators. However, these approaches require a large number of additional variables that detract from scalability and

which do not naturally decompose into quantum circuits. Budinski [13, 14] further developed an approach that enables both streaming and collision but that incurs a probability of measuring an orthogonal (irrelevant) quantum state after each time-step. Dinesh Kumar and Frankel [25] propose a similar approach, which, similar to Budinski’s methods, requires the costly decomposition of unitary matrices into quantum gates for compatibility with quantum hardware. More recently, Wawrzyniak et al. [79] introduced a novel method based on the same linear combination of unitaries (LCU) [19] approach tailored to the advection-diffusion equation, but which also requires full state measurement and reinitialization after each time step. Finally, Schalkers and Möller [62] extended a previously developed encoding and equipped it with a collision operator inspired by lattice gas automata at the cost of requiring a number of qubits that scales with the number of simulated time steps up to grid size.

The current state of QBMs is fragmented between several approaches that each present different strengths and weaknesses. This poses several challenges for researchers seeking to advance the field. In what follows, we highlight three significant challenges that face the development of QBMs, draw parallels to their classical counterparts, and explain how software can help mitigate these issues.

1.1 Software and QBM Research

To advance the theory of QBMs researchers require infrastructure that enables the implementation and experimentation of their algorithms. We address these concerns by drawing parallels to the more mature classical LBM field, and the methods that have emerged to facilitate its practical success. We then discuss the absence of such methods from the QBM field, and the drawbacks that researchers face because of this. Finally, we address how the current work seeks to mitigate these shortcomings.

Classical LBMs owe their popularity to several factors. From a theoretical standpoint, LBMs allow for the computation of macroscopic quantities such as mass and momentum density [40], and can be used as (approximate) solvers for Navier-Stokes applications, among other target equations [17, 78, 18]. From a practical standpoint, the LBM lends itself well to massively parallel computing paradigms [73, 40]. Over the years, several parallel software implementations of the LBM have emerged, including HEMELB [47] OPENLB [39], PALABOS [43], WALBERLA [5], LBMPY [6], and PYLBM [58], which are able to carry out distributed simulations on hundreds of heterogeneous compute nodes. In addition to practical applications, open-source LBM software implementations have another significant merit – they facilitate the development of further research by establishing a foundation for both theory and infrastructure [39].

Such foundations are almost entirely absent in the realm of QBMs. Because of this, the field faces three distinct hurdles. First, the many nuances of present QBM techniques make the comparison of the performance and scalability difficult. From various quantum state encodings [62] to the decomposition of exponentially sized matrices into quantum gates, QBMs build on top of extensive knowledge and technology stacks that make implementation a daunting challenge. Second, the fractured nature of the field poses challenges for techniques that augment existing work, such as the effective extraction of quantities of interest from the quantum state [63]. Third, due to the scarce availability of QBM implementations, researchers face the additional obstacle of verifying and comparing methods from the literature. This significantly detracts from the reproducibility of the field. Before addressing how software can help ameliorate these three challenges, we first introduce the current state of *quantum software* and its relation to present day quantum computer hardware.

The current state of QC hardware has been undergoing rapid development and is currently in the so-called *Noisy Intermediate-Scale Quantum* phase [57]. While quantum computers available today showcase some of the core advantages that theoretical physics promises, they are limited in both the number of qubits available and the time span that qubits can retain coherent states. These constraints greatly impede on the applications that quantum computers can presently carry out. To facilitate the research of quantum algorithms in an era without *Fault-Tolerant* Quantum Computers, scientists have turned to simulation methods instead. Recently, an increasing number software frameworks have emerged to bridge the gap between theoretical advances in algorithmics and hardware availability. These range from general purpose simulation tools [37, 75, 70] to specialized packages aimed at machine learning [8, 12] and material simulation [4]. The current state of *quantum software* intersects QC theory and available hardware, such that researchers can leverage classical hardware to verify large-scale algorithmic prototypes while quantum counterparts edge closer to fault-tolerance.

In this work, we seek to address the three challenges facing QBM research by introducing the QLBM software framework. With QLBM, we aim to bring the same advantages that classical LBM software has proven to offer to researchers and practitioners alike. We design the QLBM software around the current paradigm of simulation, with the goal of accelerating QCFD research in the absence of fault-tolerant quantum computers. Achieving this requires addressing several challenges, including integration with available software and hardware infrastructure, establishing suitable data structures and design patterns for the development of QBMs, and providing this functionality in a package that is

flexible enough to conduct research, yet accessible enough for new users. To the best of our knowledge, QLBM is only the second effort to generalize the software development process of QBMs. Recently, Shinde et al. [68] introduced a software tool aimed at developing and simulating QBMs using the Intel Quantum SDK and quantum hardware. However, their work focuses on hybrid quantum-classical QBM algorithms such as [13] and [14] and is specifically targeted towards a single vendor, and not openly available. By contrast, QLBM focuses on fully quantum approaches, provides a more flexible set of tools from multiple vendors, is readily available on GitHub under a permissive license, and pursues the broader goal of providing an end-to-end development environment. We describe the internal design of QLBM and the simulations it enables in Section 2. Section 3 provides results that showcase the capabilities of QLBM, both in terms of the QBMs that it can simulate, as well as the performance improvements it provides.

1.2 Lattice Boltzmann Methods

To provide additional background for QBMs, this section briefly introduces the classical formulation of the Lattice Boltzmann Method (LBM) and components. For a more wholistic overview of the LBM, we refer the reader to the works of Succi et al. [74] and Krüger et al. [40]. The Boltzmann Equation (BE) describes the kinetic behavior of fluid at the mesoscopic scale, nestled between microscopic Newtonian dynamics and macroscopic Navier-Stokes continua. The BE models the state of populations of fluid particles as a statistical distribution function over physical space, velocity, and time. Equation (1) gives the form of the BE we consider throughout this work, where the left hand-side terms model the advection of particles over the phase space, and the $\Omega(f)$ term represents the change in state as a result of particle collisions, often referred to as the *collision operator*.

$$\frac{\partial f}{\partial t} + \mathbf{u} \frac{\partial f}{\partial \mathbf{x}} = \Omega(f) \quad (1)$$

Though several collision operators have been developed over the decades, the Bhatnagar-Gross-Kook (BGK) formulation [10] remains one of the more popular and widely implemented options thanks to its theoretical and computational simplicity and its ability to recover the same bulk properties as Navier-Stokes simulations [40]. The BGK collision operator is defined by $\Omega(f) = -\frac{1}{\tau}(f - f^{eq})$ and models the relaxation of the particle distribution f towards the equilibrium function f^{eq} , where τ is referred to as the *relaxation time*, and directly influences the computation of transport coefficients. The discretization of the BE along phase space and time yields the Lattice Boltzmann Equation (LBE), which can in turn be solved numerically by the Lattice Boltzmann Method. Equipping the BE with the BGK collision operator and discretizing in terms of physical space, velocity space, and time yields the most widely-used form of the LBE [40], as described in Equation (2).

$$f_i(\mathbf{x} + \mathbf{v}_i \Delta t, t + \Delta t) = f_i(\mathbf{x}, t) - \frac{\Delta t}{\tau} (f_i(\mathbf{x}, t) - f_i^{eq}(\mathbf{x}, t)) \quad (2)$$

The subscript i of the f_i and v_i variables stems from the velocity space discretization, which spans a small set of discrete velocity channels that particles can travel across. Including the velocity variable in the subscript rather than a parameter to the function is a notational convention. The f_i terms are terms referred to as particle *populations*, and \mathbf{v}_i terms model velocity coefficient vectors according to the discretization scheme. Equation (3) gives typical choice of equilibrium function for Navier-Stokes simulations of isothermal models, where $c_s = \Delta x / \Delta t$ is the lattice speed, w_i are pre-determined weights, ρ is the fluid density, and \mathbf{u} corresponds to the flow velocity.

$$f_i^{eq}(\mathbf{x}, t) = w_i \rho \left(1 + \frac{\mathbf{u} \cdot \mathbf{v}_i}{c_s^2} + \frac{(\mathbf{u} \cdot \mathbf{v}_i)^2}{2c_s^4} - \frac{\mathbf{u} \cdot \mathbf{u}}{2c_s^2} \right) \quad (3)$$

The LBM describes a class of time step algorithms that iterate through repeated steps. Each time step can be conceptually broken down into three subroutines: streaming through physical space, reflection at the boundaries of the fluid domain, and (non-linear) particle collision. First, the particles *stream* (or *propagate*) through space in directions prescribed by the discretized velocities to neighbouring lattice points. Then, boundary conditions are applied to ensure particles adhere to the fluid domain. Finally, the populations undergo collision (or relaxation) before the computation of macroscopic forces. In addition to Navier-Stokes applications, the different building blocks of the LBM lend themselves well to a broad range of other use cases. Among others, researchers have proposed LBM-based models for acoustics [15], electro-osmotic flows [31], as well as the Poisson [17], shallower water [84], and advection-diffusion [18] equations.

High-Level Specification

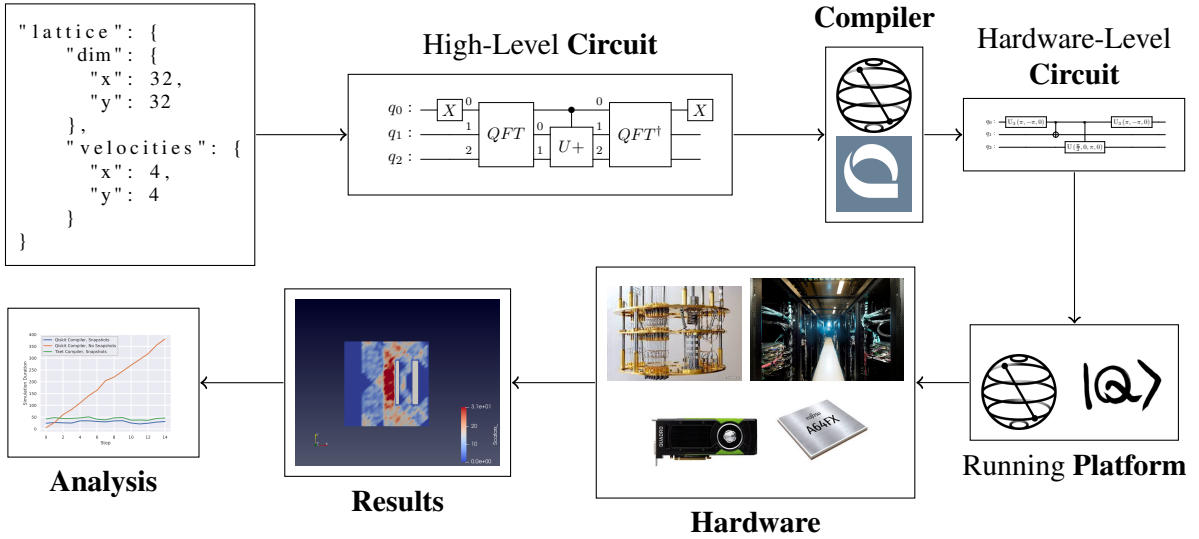

Figure 1: Overview of end-to-end QLBM workflow.

2 QLBM Overview

This section introduces the cornerstone features of QLBM. Before addressing these features, however, we first highlight the end-to-end workflow we designed QLBM around. The primary goal of QLBM is to provide an end-to-end environment for the development, simulation, and analysis of QBM algorithms. Figure 1 provides a visualization of the workflow that accommodates all of these steps. The process can be broadly broken up into three substeps: quantum circuit generation, simulation, and analysis. In the current implementation of QLBM, the pipeline supports two algorithms: the Quantum Transport Method (QTM) [61] and the Space-Time Quantum Boltzmann Method (STQBM) [62].

The workflow begins with a user-friendly specification of the system to simulate. The goal of this interface to increase the accessibility of QBM algorithms for users with limited experience in the field, while simultaneously enriching the experience of more mature practitioners. User-specified data includes information about the lattice discretization, as well as geometry and boundary conditions. QLBM parses this configuration and extracts algorithm-specific information that is then used to generate high-level quantum circuits. This method of deriving circuit properties from high-level specification bridges the gap between the expectations of end-users who are looking to perform CFD simulations and the complexity of specifying physically accurate quantum algorithms. We address the internal design choices that facilitate this process in more detail in Section 2.1.

Once the high-level quantum circuit has been assembled, users are generally interested in simulating the algorithm to verify its correctness and to analyze results. To make the best use of available resources, software should exploit techniques that quantum simulators allow for that would otherwise not be available on quantum hardware. To this end, QLBM implements methods that lessen the computational burden on both the algorithmic and the computational fronts. We describe such techniques and how QLBM leverages them to exploit the time-marching nature of LBMs in more detail in Section 2.2.

Finally, after simulations have concluded, researchers are typically interested in the performance and scalability of the methods they are developing. To accommodate this need, we integrate QLBM with a set of tools that enable the analysis of quantum circuits and their performance. These tools include means for visualizing QBM algorithms and their building blocks, exporting simulation results to external visualization engines, and scripts that give insight into the scalability of the methods. We delve into more details on how QLBM integrates with surrounding quantum software infrastructure in Section 2.3.

2.1 Internal Architecture

The internal architecture of QLBM primarily targets two goals with regard to quantum circuits. First, the quantum circuit components of QLBM should be easy to extend and verify, as to facilitate the design of novel QBM algorithms. Second, the internal composition of the framework should be modular, as to enable testability on individual methods through

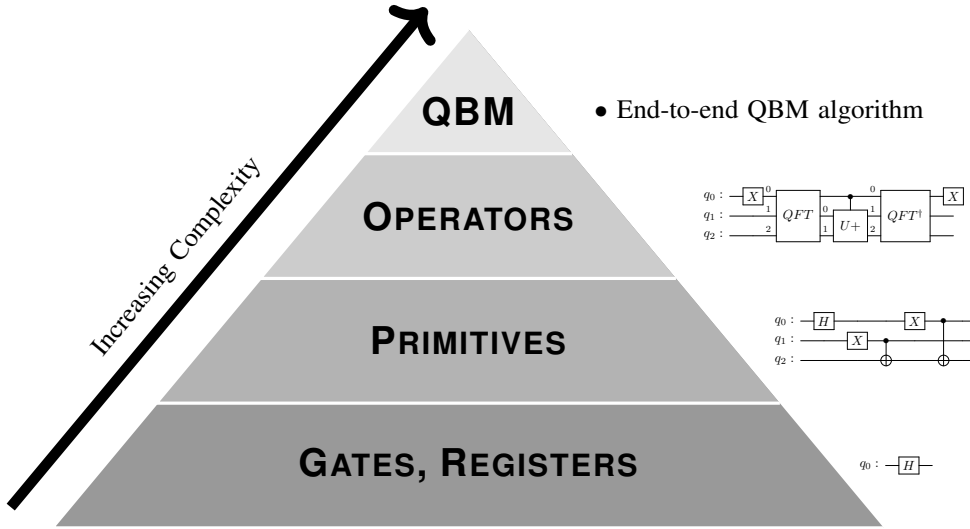

Figure 2: Representation of internal quantum circuit abstraction hierarchy.

isolation. In addition to quantum circuit design, the architecture of the software should minimize the effort required to integrate with external quantum software libraries.

We address the two design directions of QLBM – quantum components and overall system design – in Section 2.1.1 and Section 2.1.2 respectively, zooming out from individual quantum circuit abstractions to a holistic overview of the framework.

2.1.1 Quantum Component Architecture

To realize a modular and extendable quantum circuit library, we implement a system of circuit abstractions based around a complexity hierarchy with respect to the steps of the LBM. Figure 2 provides a graphical depiction of this hierarchy. We organize components in three broad categories: primitives, operators, and algorithms. Primitives are the least complex elements of the taxonomy, and they implement small-scale, isolated blocks within QBM algorithms. Isolating parameterized implementations of such circuits enables developers to verify their behavior in isolation and reuse them seamlessly. This in turn accelerates the implementation of novel algorithms.

Figure 3 contains an example of how programmatic quantum circuit construction helps simplify the algorithmic development process. Both circuits in the figure were constructed with simple calls to a `ControlledIncrementer` primitive that is used repeatedly to move particles during the streaming and reflection steps of the QTM algorithm. The circuits share the same structure: they begin by mapping the grid qubits to the Fourier basis by performing a Quantum Fourier Transform (QFT) and conclude by returning them to the computational basis. Between the two QFT blocks is a series of controlled phase shifts that performs the incrementation of the appropriate populations. In Figure 3a, the controls reside on the ancilla velocity qubits, which determine whether particles move within one CFL substep. In Figure 3b, the phase shift controls are instead placed on the ancillary qubit that determine whether particles have virtually streamed inside of an obstacle. This sole discrepancy determines which populations are streamed and differentiates two distinct phases of the algorithm. The QLBM implementation of this primitive allows the same piece of code to construct both circuits with a single parameter switch between `reflection=None` and `reflection="bounceback"`.

A step above primitives are so-called operators. The goal of operators is to encompass quantum circuits that implement one specific physical operation of the LBM – streaming, reflection, or collision. This layer of abstractions seeks to address the fragmented formulations that have emerged from recent QBM literature. For instance, circuits that perform streaming in basis-state encodings are not directly applicable to amplitude-based encodings, and vice-versa. Despite this fundamental incompatibility, a clear separation between operator-level circuits in different encodings serves two purposes. First, operators enable targeted experimentation with competing implementations such as different boundary

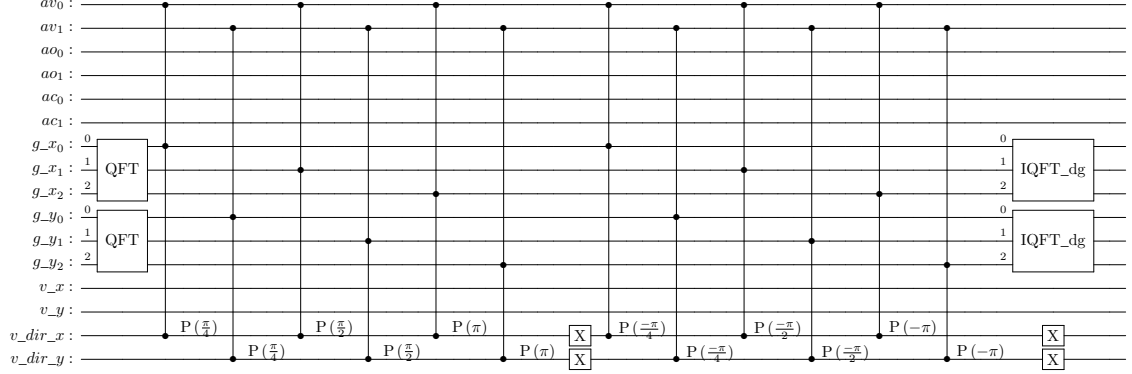

(a) Standard controlled incremter circuit.

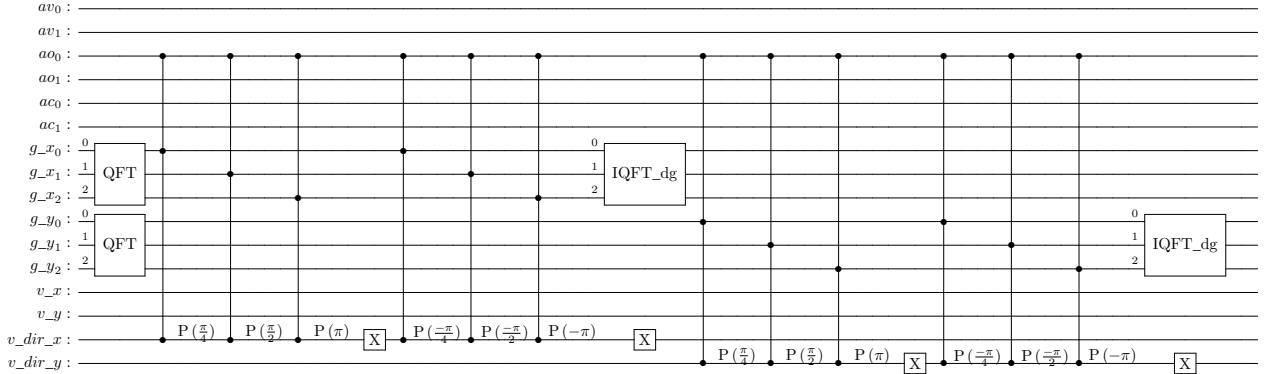

(b) Bounceback reflection controlled incremter.

Figure 3: Comparison of QLBM primitive quantum circuits.

condition circuits within a single encoding. Second, this design allows for a broader range of algorithmic combinations, which may target different solvers or equations.

The highest level of abstraction within the component taxonomy is the end-to-end QBM algorithm. These structures are crucial for tying together lower level abstractions. Algorithm-level components follow naturally from the chaining of operators in a way that resembles LBM pseudocode. Figure 4 depicts an example of how the QTM algorithm [61] can be expressed as a series of four operator-level components. The `CollisionlessStreamingOperator` first prepares the correct ancilla qubit state based on the current state of a CFL counter, before performing a controlled incrementation on populations of particles within one substep (line 5). Following streaming, the `SpecularReflectionOperator` (line 12) and `BounceBackReflectionOperator` (line 19) append the circuit with logic that detects whether particles have streamed outside the fluid domain, before inverting the appropriate velocities and placing the populations back in the fluid domain. Finally, the `StreamingAncillaPreparation` operator (line 27) prepares the quantum state for the next iteration of the CFL counter. A simple call to the built-in class, *i.e.* `CQLBM(lattice)`¹, is all that users need to do to build end-to-end quantum circuits.

This internal architecture of quantum components enables the development of new QBM circuits in two ways. First, the quantum circuits already implemented within QLBM are trivially reusable for new methods, provided that encodings are compatible. Second, this hierarchy facilitates the development of entirely novel algorithms by additionally separating quantum circuit logic and quantum register setup. We achieve this by isolating the quantum register logic within implementations of the `Lattice` class, which are algorithm- and implementation-specific. Consider again the chaining of operators depicted in Figure 4. The only information required to construct the quantum operators already resides in the `lattice` attribute of the `CQLBM` object, which gets propagated down the abstraction chain. To increase the accessibility of this architecture, we additionally provide each `Lattice` class with methods that allow for human-readable indexing

¹In the software, we denote algorithms by their interpretation of the LBM. For this reason, the QTM algorithm [61] is available as `CQLBM`, short for *Collisionless* Quantum LBM, as it models $\Omega(f) = 0$. The STQBM [62] is available as `SpaceTimeQLBM`.

```

1 circuit = QuantumCircuit(*self.lattice.registers,)
2
3 for velocities_to_increment in get_time_series(2 ** self.lattice.
4   velocities[0].bit_length()):
5     circuit.compose(
6         CollisionlessStreamingOperator(
7             self.lattice,
8             velocities_to_increment,
9         ).circuit,
10        inplace=True,
11    )
12    circuit.compose(
13        SpecularReflectionOperator(
14            self.lattice,
15            self.lattice.blocks["specular"],
16        ).circuit,
17        inplace=True,
18    )
19    circuit.compose(
20        BounceBackReflectionOperator(
21            self.lattice,
22            self.lattice.blocks["bounceback"],
23        ).circuit,
24        inplace=True,
25    )
26    for dim in range(self.lattice.num_dimensions):
27        circuit.compose(
28            StreamingAncillaPreparation(
29                self.lattice,
30                velocities_to_increment,
31                dim,
32            ).circuit,
33            inplace=True,
34        )

```

Figure 4: Sample QLBM operator code.

operations by assigning each register an intuitive naming scheme, and automatically adjusting its size. This alleviates the burden of manually indexing individual qubits and addressing multiple logically connected indices. In addition to the QTM algorithm, QLBM also fully supports the STQBM [62], which uses a different, extended computational basis state encoding, which highlights the versatility of this design.

Figure 5 depicts the entire architecture of the quantum components of QLBM. At the top, three base classes that adhere to the primitive, operator, QBM model provide interfaces that ease the development of novel circuits by providing appropriate interfaces through inheritance. On the vertical axis, classes become increasingly specific and complex from top to bottom. Within one "branch" of the inheritance hierarchy, component reuse is still possible, *i.e.* by utilizing simpler primitives to build more complex ones. On the horizontal axis, components again range from simple to complex with respect to the task they fulfill within the QBM. That is, incrementers and comparators serve as the building blocks for streaming and reflection operators, which then assemble the end-to-end QBM. Researchers can develop novel QBMs along this axis, in parallel to existing implementations. In practice, this leads to a system in which previous contributions are available for novel developments, but do not hinder them. The following subsection describes how quantum component module fits within the broader scope of the framework.

2.1.2 System Architecture

Integrating QBM circuits into broader quantum software stacks is crucial for increasing the accessibility of QBMs, as well as for expediting novel research in the NISQ era. We design the architecture of the QLBM framework around

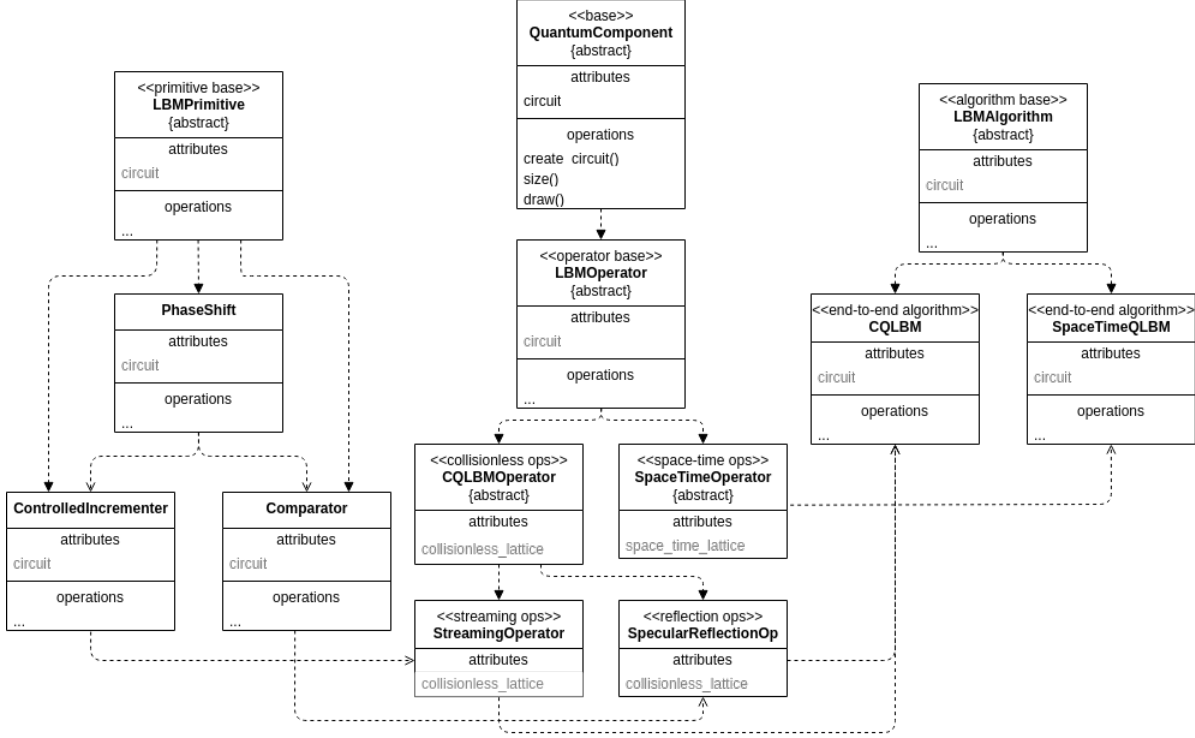

Figure 5: Class diagram representation of the QLBM quantum component architecture.

facilitating the use of the quantum components described in the previous subsection. Figure 6 gives an overview of the three main components of QLBM, as well as how they come together to enable seamless user interaction.

At the bottom of the figure, the quantum components of the QBM are mostly isolated from the remainder of the framework. To further decouple the quantum circuit logic from the surrounding utilities, we introduce a `Lattice` component which handles specification parsing and preprocessing. This module is depicted on the right hand-side of Figure 6 and is tasked with the conversion of high-level specification into information that can parameterize the construction of quantum circuits. This includes parsing geometry specification in the `Block` class for the application of boundary condition and determining the appropriate (minimal) register setup for simulating the system in the `Lattice` class. Quantum components use this information to construct appropriate circuits on a per-algorithm basis.

External infrastructure is again handled in isolation to encourage modularity and extendibility. The `Infrastructure` component contains both `Compiler` and `Runner` classes that wrap the circuit transpilation utilities available in Qiskit [37] and Tket [70]. These utilities enable resource estimation experiments for different hardware specifications, including variable gate sets and qubit connectivities. Uniform interfaces make it easy for the user to access those services without requiring low-level tuning of the underlying libraries.

Finally, the detached components are brought together in an interface called a `SimulationConfig`. This class ties together the algorithmic components that make up a QBM, as well as additional simulation options the user can configure. Such items include the preferred compiler and simulator, as well as their specific parameters. The appeal of this highly coupled interface is that it automates the process of preparing the high-level quantum circuits generated in the component module for execution on a specific quantum or classical hardware platform. This allows the entire bundle of quantum circuits simulation parameters to be forwarded to the `Runner` in one go. Section 2.3 provides an example of how the entire end-to-end simulation workflow can be performed in just a few lines of code.

To complement modularity and isolation, the architecture of QLBM promotes a high standard of code quality and reproducibility. In addition to the open-source access, QLBM contains an extensive suite of over 200 unit, integration, and end-to-end tests, which target both low-level implementation details (such as geometry parsing), as well as high-level features such as compatibility with several Qiskit simulators. Supplementary to unit tests, QLBM hosts a comprehensive documentation website with dozens of examples, thousands of lines of in-code comments, and additional tutorials that delve into advanced applications of the software aimed at developing novel algorithms.

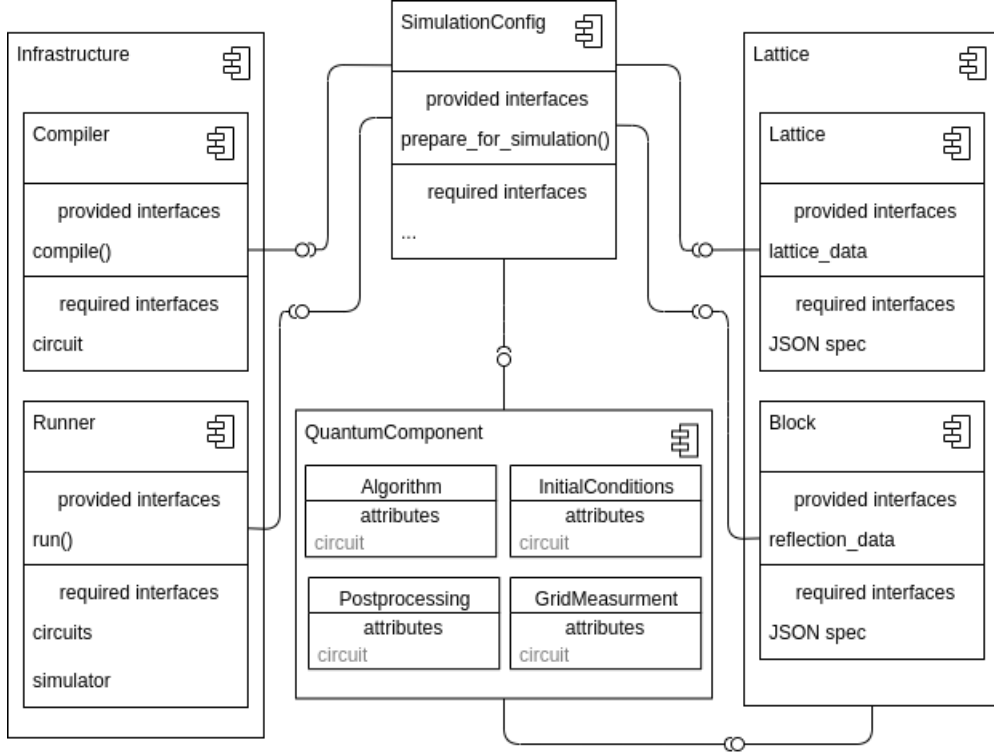

Figure 6: Representation of the system-wide QLBM architecture.

2.2 Performance Enhancements

In an era without fault-tolerant quantum hardware, classical hardware plays a crucial role in accelerating quantum algorithm research. To do this effectively, we require simulation software that enables classical hardware to emulate quantum computers in the first place. In this section, we highlight two directions that can enhance the performance of QBM algorithms in an environment dominated by quantum simulation. The first direction is algorithmic. This includes any improvements that can be made to quantum circuit design, as well as any computations that can be delegated to classical information processing instead of relying on the exponentially more expensive computation of a quantum state. The second direction is computational. This direction consists of exploits that classical hardware allows, which would otherwise be physically impossible on quantum computers. Efficient statevector manipulations are an example of such an optimization. In quantum computing, the no-cloning theorem prohibits exact copies of statevectors and measurement often requires exponentially many shots of a circuit. Such limitations can be circumvented in simulations. Effective implementations of such techniques are crucial for accelerating research into QBMs, as they save researchers invaluable time and computational resources. We first describe examples of algorithmic improvements in Section 2.2.1 before addressing their computational counterparts in Section 2.2.2.

2.2.1 Algorithmic Improvements

Algorithmic improvements concern techniques that reduce the complexity of quantum circuits in either depth, number of qubits, or total number of gates. Here, we refer again to the QTM algorithm developed by Schalkers and Möller [61] as an example, and highlight two techniques that help reduce circuit complexity, while focusing on how QLBM facilitates such improvements.

Ancilla qubit reuse. Effectively leveraging the state of ancilla qubits can help reduce both the number of gates and qubits required to perform certain computations. Here, we give two examples that curtail gate and qubit requirements, respectively. We first consider the depth of QTM algorithm’s streaming operator. The algorithm leverages an ancilla system that determines whether populations of particles stream in a given timestep subdivision, as computed by a CFL counter. Discrete velocities that should stream in a substep are identified in the quantum state through ancilla qubits $a_{v,i}$ that pertain to whether particles with a specific discrete velocity v are streamed in dimension i . A naive implementation would first perform the streaming operation, reset the state of the ancilla qubits, and then compute the boundary

condition operator on the resulting state. However, since populations that have not streamed in the CFL substep are not affected by boundary conditions, the same ancilla state can be re-used to control which velocity directional qubits are inverted by boundary conditions. Figure 4 exemplifies this optimization, where the `StreamingAncillaPreparation` operator is only used at the end of the CFL iteration, and not between each streaming and boundary condition routine. The indexing methods of QLBM’s `Lattice` classes allow for the seamless utilization of qubits without manually performing the tedious indexing operations that change with each system and lattice discretization.

Ancilla qubits can also be effectively reused to reduce the memory requirements of heterogeneous boundary conditions. Consider again Figure 4 and the application of both specular and bounceback boundary conditions. Specular reflection entails the reversal of the velocity normal to the reflection surface, whereas bounceback reflection requires that all directions are inverted, irrespective of the contact surface. To practically realize specular reflection, we use d ancilla qubits to determine which dimensions a population has reached an object in, which enables the computation of the velocity components to invert. For bounceback reflection, a single ancilla qubit suffices to determine whether particles have exited the fluid domain, which triggers the reversal of all directional velocity qubits [63].

A straightforward implementation of a system that supports geometry with heterogeneous boundary conditions would therefore utilize $d + 1$ ancilla qubits. In the QLBM implementation of the QTM algorithm, we only require the d ancilla qubits that specular reflection necessitates. This is made possible by imposing the restriction that the domains of specular reflection and bounceback objects are separated by at least two grid points. If this constraint is satisfied, multiple obstacles with either reflection method can leverage the same qubits without causing any interference within the quantum state. Though marginal for ideal fault-tolerant computers, such improvements prove significant for classical emulation. The `Lattice` class registers again make such optimizations trivial to implement by allowing shared access to all qubit registers from inside primitives and operators. Moreover, the straightforward chaining of operators makes it easy to compose circuits based on intermediate states, and each `Lattice` class can incorporate specification parsers that warn users if constraints are violated.

Adaptable register setup. To further exploit the properties of specific QBM setups, QLBM allows for a flexible register setup that minimizes resource requirements. The same observation that allows ancilla qubits to be reused also leads to the simulation requiring fewer qubits for the simulation of the end-to-end QTM algorithm. As the `Lattice` object parses the input specification, it tracks the different kinds of boundary conditions present in the system. If the system only contains bounce-back boundaries, the register is automatically shrunk to only require one ancilla qubit that suffices to perform reflection. The relative indices of the remainder qubits are automatically adjusted such that the users does not need to manually adjust the circuits not affected by this change. If, however, the system contains mixed boundary conditions, the register is widened to accommodate the d ancillae that specular reflection utilizes, and the mechanism described previously commences to effectively reuse the available qubits for both boundary conditions.

Classical logic computation. We again use the same specular reflection operator of the QTM to highlight how the delegation of logic to classical preprocessing can effectively speed up simulation. We give two examples of preprocessing techniques that simplify both the quantum circuits and their simulation.

First, we consider specular reflection against a wall in the nominal case, where particles do not encounter a corner of the object. To reflect particles in a way that is physically correct, the quantum circuits needs to determine which of the velocity directions to invert. While this is simple to do in classical LBMs, the quantum circuit additionally requires the information to persist within the state *after* particles have been removed from the non-fluid domain, as to reset the state of any ancilla qubits that would otherwise later interfere with the computation. There are multiple ways to implement this logic. Detecting and resetting such states can be achieved both in the quantum circuit by means of extra ancilla qubits, as well classically by manually defining which velocity directions each wall surface affects. However, the former requires significant quantum resources and expensive additional logic, while the latter is error-prone and difficult to debug.

In QLBM, we provide an alternative implementation that performs this computation in terms of automated boolean logic operations in a step that precedes the assembly of the quantum circuit. Specifically, we take advantage of the encoding of velocities in the QTM algorithm. We leverage this encoding by formulating a boolean function over spacial properties of the object’s edges, that provides the information required to invert and reset the appropriate velocity qubits. To achieve this, we define near-corner points as $2d$ -dimensional boolean vectors in the cartesian product space described by Equation (4).

$$\mathbf{point} = \mathbf{bound} \times \mathbf{outside} \tag{4}$$

Here, $\mathbf{bound}, \mathbf{outside} \in \{\top, \perp\}^d$ are d -bit structures that encode the position of near-corner points per dimension. The \mathbf{bound} property encodes whether the point belongs to a surface that is a lower (\perp) or an upper (\top) bound of

the object. The **outside** values denote whether the point is outside (\top) or inside (\perp) the object bounds. Since both variables are dimension- and position-agnostic, their cross product produces a data structure that encodes the position of *each* near-corner point of any cuboid-shaped object. To determine whether an ancillary qubit is to be inverted after performing the reflection step, QLBM simply queries a single boolean value per dimension. This value is computed as given in Equation (5).

$$\text{inversion} = \text{bound} \otimes \text{outside} \quad (5)$$

Where \otimes corresponds to the point-wise XOR function. That is, each ancillary qubit state is reset controlled on (1) the position of the gridpoint within the lattice and (2) the inversion boolean value associated with its relative position with respect to the object. This technique is powerful for two reasons. First, it saves d qubits that would be required to implement a quantum counterpart to this computation without altering the other components of the quantum state. Second, since all classical computations required for this purpose are trivial object-agnostic boolean operations, the cost associated with this method is negligible with respect to the rest of the algorithm. QLBM enables such computations to be carried out entirely independently from the quantum circuit generation details, and implements them in a separate `Block` class, which interfaces with the `Lattice` counterpart. In practice, this means users can choose to tune the reliance of their methods on classical computation without necessitating any change to previously implemented circuits. We note that QLBM uses the same mechanism to generate the reflection circuits for both 2D and 3D reflection circuits, including all edge cases around cuboid objects. The cartesian product of Equation (4) generalizes to both points and edges (in 3D), and while the specific function used to assign inversion boolean values differs per case, its implementation remains straight-forward and efficient.

2.2.2 Computational Improvements

Computational improvements involve techniques that leverage current classical hardware to simulate QBM circuits efficiently. In this section, we outline three kinds of techniques tailored to exploit the structure of QBM algorithms.

Statevector snapshots. Lattice Boltzmann Methods are inherently time-dependent algorithms. In both classical and quantum LBMs, computations occur in a temporal loop that consists of repeated steps. This means that the circuits that implement QBMs may be similar or even identical for each individual time step. On real quantum hardware, this observation is of lesser importance. While circuits can be reused, the statevector produced by a QBM circuit after one step cannot be cloned as input for the next. However, quantum simulators available today do offer this option. In this subsection, we show how taking advantage of the availability of the entire statevector can drastically decrease the time required to simulate QBMs.

To showcase this improvement, we consider a scenario in which the goal of the simulation is to perform n time steps of the QTM algorithm, and visualize the entire flow field encoded in the quantum state *after each step*. This is a common method that helps researchers verify whether the implementation of the circuit produces physically consistent behavior. Figure 7a depicts what an implementation of this workflow might look like on quantum hardware. Each time step requires a different quantum circuit, that is made up of k repetitions of the same circuit nestled between state preparation and post-processing primitives. Following each execution, measurements collapse the quantum state onto basis states that can reconstruct the flow field. In total, the QTM single-time step quantum circuit is executed $\mathcal{O}(n^2)$ times, not accounting for the multiple shots required for each step. This is a general requirement of the task, rather than a consequence of the specific algorithmic implementation.

Fortunately, quantum simulators afford the extraction of additional information from their representation of quantum states without requiring multiple shots. Figure 7b depicts an efficient implementation of the same workflow on quantum simulators. Though the same structure is preserved, the transfer of information from one time step to another is fundamentally different in QLBM’s implementation. While iterating through the (identical) time-step circuits, each statevector ψ_k produced by the circuit undergoes the following process. If post-processing is required, QLBM first creates a copy of the statevector, which it then passes on to a sampling subroutine. Otherwise, a single instance of the data suffices. Afterwards, QLBM produces samples of this statevector *without* changing it. This enables the extraction of information required for visualization while maintaining the statevector intact. After the information has been extracted, the same statevector is fed back into the same time step circuit, which updates it with one more iteration.

The core difference between the two approaches is that the latter effectively takes *snapshots* of the statevector as the n timestep circuits iteratively evolve it. This enables a drastic increase in performance, as only $\mathcal{O}(n)$ simulations of the single step algorithm are required. In QLBM, we additionally increase the efficiency of this method by only constructing and transpiling the time step circuit once and re-using it for each iteration. In practice, using this method to simulate novel developments of circuits massively decreases the time researchers spend verifying their implementations.

(a) Standard simulation of an n -step QBM algorithm.(b) Snapshot simulation of an n -step QBM algorithm.

Figure 7: Comparison of simulation strategies for multistep QBM algorithms.

Statevector sampling. Quantum simulation is an area of active research that continuously improves the performance of quantum emulation through new methods and software. Emerging methods all have different strengths and weaknesses, which depend on the underlying hardware and the simulated quantum circuits. To take advantage of the plethora of simulation paradigms, we split the simulation procedure into two distinct phases, as illustrated in Figure 7b.

The first phase consists of the simulation of the quantum circuit up to but not including the post-processing step. To enable the snapshot-driven execution that reduces the complexity order, the simulator that performs this routine must be able to retrieve the entire statevector at the end of each time step. The second phase of the procedure involves postprocessing and measurement. Unlike the time step circuit(s), post-processing and measurement circuits are generally shallow and simple. In addition to this, the state that emerges as a result of the post-processing circuit is not of any importance to the next iteration of the algorithm, and instead serves visualization and verification purposes. Because the two phases are constrained by significantly different requirements, QLBM allows for the specification of different simulators for each phase.

The goal of this distinction is to take advantage of simulation technology that favors the simulation of shallow circuits in the latter stages of each time step. In the general case, this requires two copies of the statevector to be kept in memory at the same time – one that serves as input to the following time step iteration, and one that serves as input to the post-processing and measurement stage. Fortunately, in the nominal scenario where researchers are interested in visualizing the entire flow field evolved by the circuits, post-processing is circumvented. In practice, this means that the quantum state computed by the time step circuit can effectively be *sampled* by a different, more suitable simulator with no additional copy required.

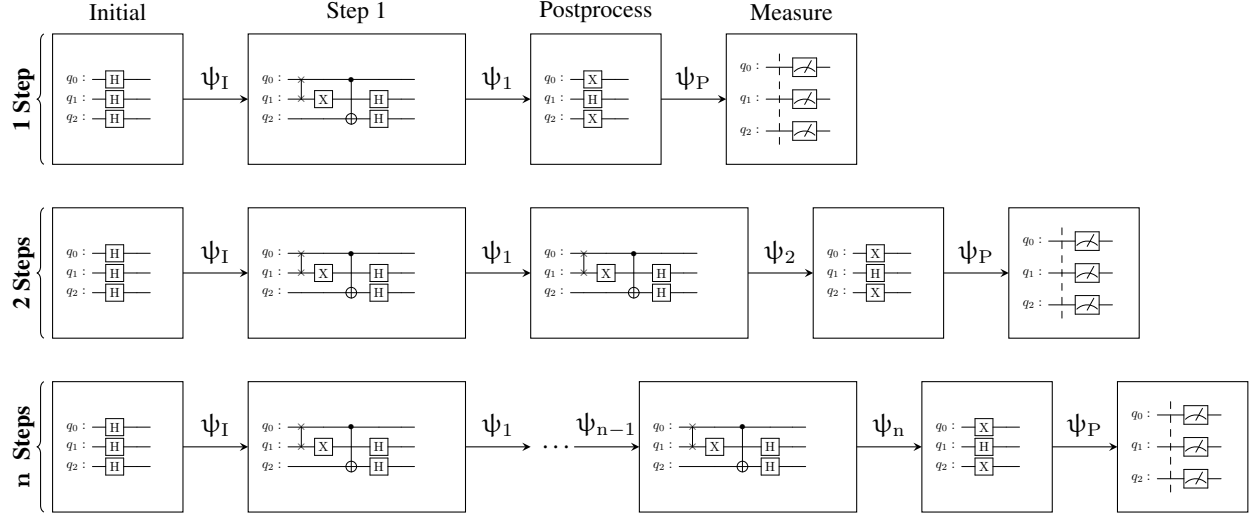
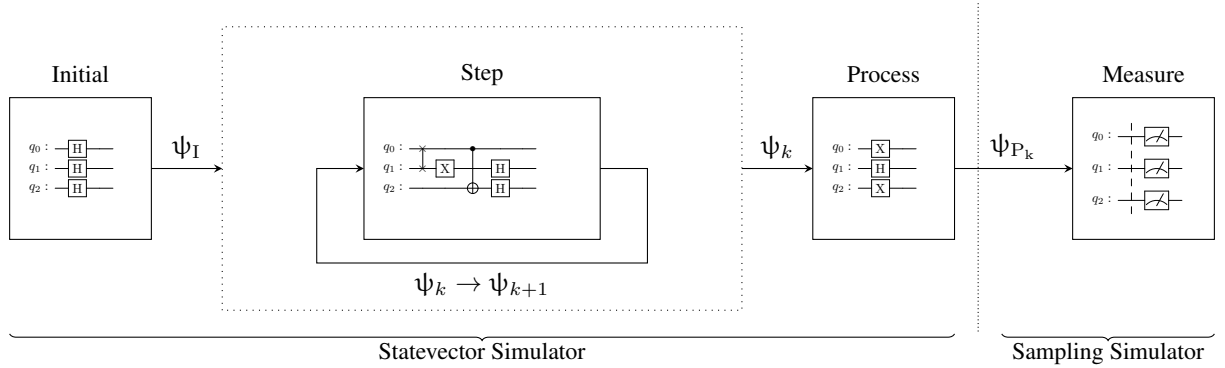
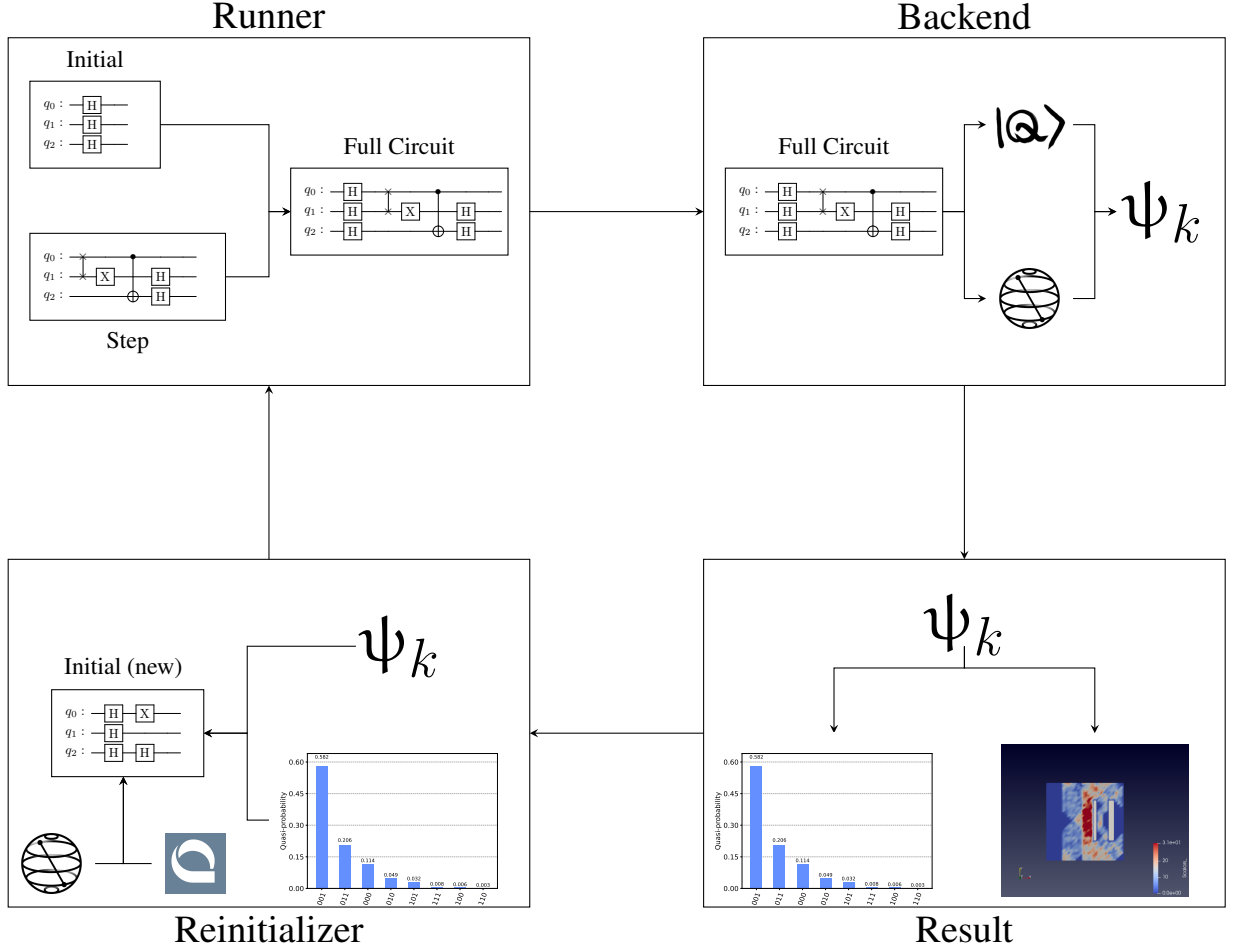

Figure 8: QLBM reinitialization loop.

Reinitialization. Simulating QBM algorithms on classical hardware comes with inherent limitations. Clearly, the exponential memory advantage that quantum computing promises is not achievable through classical emulation. With this fundamental limitation come several practical challenges. One such challenge facing the snapshot and sampling techniques stems from the transition between time steps. For algorithms like QTM, the time step transition on quantum simulator consists of a single straightforward transfer of the statevector from one circuit to the next. However, this is not the case for most QBM algorithms.

We consider the STQBM algorithm [62] as an example. To circumvent the non-unitarity of streaming in the computational basis state encoding, the STQBM algorithm uses velocity information from neighboring gridpoints. In the general case, this utilizes $\mathcal{O}(N_t^d)$ additional qubits to propagate spacial information in time, with N_t the number of time steps to simulate and d the number of dimensions of the problem. Due to memory limitations, the direct simulation of more than a few time steps of this algorithm is infeasible for most classical hardware available today. To circumvent this constraint, an effective *reinitialization* mechanism is required. Such a mechanism converts information encoded in the quantum state at the end of a simulation into a quantum circuit that prepares the state for following time step(s).

We emphasize that this use of reinitialization is not exclusive to the STQBM. Though the underlying reasons differ, other approaches may require similar mechanisms. We consider the LCU-based paradigm [13, 14] as an additional example. Due to how LCU-based methods perform collision, the quantum state contains an additional component, which is orthogonal to the component encoding the state of the flow field. In practice, this makes many measurements obtained from the quantum state produced by LCU time step circuits irrelevant for the flow field computation. This makes reinitialization techniques valuable, as they segregate the algorithm into smaller restart-driven blocks that prevent the orthogonal state component from propagating.

To facilitate the development of all three kinds of QBMs, we equip QLBM with a uniform reinitialization interface. Figure 8 depicts how reinitialization integrates into the efficient QBM simulation loop. After a circuit implementing one or more time steps has been assembled (upper, left-hand quadrant), simulation can commence. A simulator backend of the user’s choice, such as Qiskit or Qulacs then evolves the quantum state by the full time step circuit from $|0\rangle^{\otimes n}$ into ψ_k (upper right-hand quadrant). The nominal QLBM flow then directs the quantum state towards the sampling backend. At this stage, information is extracted from the state in the form of *counts*, which include the measured basis states and their relative frequency with respect to a pre-determined number of shots. It is this information that enables QLBM’s integration with external visualization techniques.

After extracting the samples from the quantum state, the statevector and the counts are fed to an instance of the `Reinitializer` class. This class provides restart methods that are tailored to the algorithm being simulated. The `Reinitializer` object performs the appropriate processing of the input data to obtain the initial conditions of the next time step circuit. For the QTM algorithm, this only involves wrapping the statevector in an appropriate interface – counts are disregarded. For STQBM, the process involves parsing the counts information and constructing a new quantum circuit that propagates the velocity information to neighboring grid points. In this case, the statevector object is discarded. Following the reinitialization step, the novel initial conditions circuit is automatically compiled to the appropriate target platform. To enable seamless interaction between the reinitializer and the rest of the simulation infrastructure, QLBM’s base `Reinitializer` provides a stable and uniform interface that requires no modification for the implementation of novel algorithms. Together with the flexible component interface described in Section 2.1, this enables the on-the-fly composition of the newly derived circuit with the unchanged time step circuit from the previous iteration. We note that next to developing the quantum circuits, implementing (or reusing) a `Reinitializer` class and adjacent `Result` class (for parsing and visualizing samples) are the only other step researchers need to take to fully implement a QBM algorithm in QLBM, while retaining all performance enhancements.

2.3 Interfacing and Integration

Providing intuitive interfaces is crucial for making software accessible to both researchers and practitioners. In this section, we describe how users can interact with QLBM as a QBM simulation tool, before addressing QLBM’s integration with external software.

2.3.1 Interfacing

One of the advantages of QLBM’s internal component representation is that it enables automatic circuit construction. This shifts the burden of realizing system-specific circuits from the user to the logic inside the software. In turn, this means users should have access to a seamless way of specifying complex quantum circuits. To address this need, QLBM provides the option for users to specify system properties in an implementation-agnostic way through a JSON interface.

Figure 9 contains an example of such a specification. When parsing this specification, QLBM uses the lattice properties to determine the appropriate qubit register setup, as well as the structure, position, and order of quantum components that compose the algorithm. Next to discretization details such as the number of gridpoints in each dimension (lines 3-6) and number of discrete velocities (lines 7-10), users can additionally specify properties of the geometry within the system (lines 12-23). Each geometric object is composed of a lower and an upper bound in each dimension (lines 14, 15), together with the object’s boundary conditions (line 16). In the current version of QLBM, only cuboid-shaped geometries are supported for the QTM algorithm, with either specular or bounce-back boundary conditions. To accommodate the development of novel algorithms, QLBM parses the exact same specification file to derive multiple QBMs. Internally, the `Lattice` class provides a base that includes a parser, which specialized implementations can leverage. In practice, this means utilities that warn users of ill-formed specifications can be shared between algorithms, and excessive information (i.e., boundary conditions that are not yet supported by some QBMs) can be discarded.

QLBM offers several alternatives that bridge the gap between the high-level JSON specification and nuanced details of the simulation. Figure 10 depicts the most user-friendly interface available in QLBM, based around the `SimulationConfig` wrapper. First, users choose a lattice file to simulate, written in the same format as Figure 9 (line 12). Next, the `SimulationConfig` class (lines 13-23) defines a convenient container that bundles together all required simulation data. This includes the specific components that make up the quantum algorithm (lines 14-17), the platforms that run and compile the quantum circuits (lines 18-20), and explicit simulator choices (lines 21-23). The components and simulator choices correspond exactly to the workflow described in Section 2.2.2 and Figure 7. At this stage, no additional user configuration is required, as QLBM infers all quantum registers and circuits based on the parsed lattice data alone.

```

1 {
2   "lattice": {
3     "dim": {
4       "x": 16,
5       "y": 16
6     },
7     "velocities": {
8       "x": 4,
9       "y": 4
10    }
11  },
12  "geometry": [
13    {
14      "x": [9, 12],
15      "y": [3, 6],
16      "boundary": "specular"
17    },
18    {
19      "x": [9, 12],
20      "y": [9, 12],
21      "boundary": "bounceback"
22    }
23  ]
24 }

```

Figure 9: Sample QLBM lattice configuration.

Following configuration, a single call to the `prepare_for_simulation()` method of the configuration object determines whether the user-supplied configuration is valid and compiles all circuits to the appropriate simulator format. Next, users need only make a call to the `run()` method of a `Runner` object, specifying the number of time steps to simulate, the number of shots to sample from the statevector, and whether to use the snapshot mechanism. We note that the distinction between where the sampling and snapshot mechanisms are specified stems from the fact that sampling requires a different compilation pipeline if enabled, and as such needs to be specified at circuit assembly time. We discuss the different available options for both compilers and runners in the following subsection.

2.3.2 Infrastructure and Integration

The field of quantum software is rapidly evolving. The quality, scope, and variety of available software are continuously increasing as researchers develop new methods to bridge the gap between the current-day hardware and fault tolerance. Such improvements are evident at multiple stages of the quantum software pipeline, and taking advantage of them is crucial for increasing the pace and quality of related research. In this section, we elaborate how advances in quantum software technology affect QLBM, and how its integration with external software infrastructure can accelerate QCFD research. We begin by addressing how QLBM assembles quantum circuits before focusing on simulation, compilation, and visualization, respectively.

Circuit specification. Over the years, many quantum programming frameworks and languages have emerged for various platforms and specifications. Popular general-purpose quantum programming frameworks include the Open Quantum Assembly Language (OpenQASM) [22] Quipper [29], ProjectQ [71], Cirq [24], and Qiskit [37]. QLBM builds its internal representation of quantum circuits on top of Qiskit’s `QuantumCircuit` class. Specifically, each QLBM primitive, operator, and algorithm holds an internal Qiskit quantum circuit that is built from either a small set of parameters or from a `Lattice` specification. We select Qiskit for three main reasons. First, its large ecosystem encompasses many useful pieces of adjacent infrastructure, including analysis and visualization tools. Second, Qiskit’s popularity increase the accessibility and reach of QLBM with a broader user base. Finally, its rich toolkit of circuits makes the specification of elaborate quantum circuits seamless. It is especially this feature that enables QLBM’s modular component architecture and circuit composition capabilities.

Simulation. Using classical hardware to simulate the exponentially large space that logical qubits reside in is an inherently limiting task. In the case of arbitrary random circuits, the amount of classical memory required to simulate a

```

1 from qiskit_aer import AerSimulator
2
3 from qlbm.components import (
4     CQLBM,
5     CollisionlessInitialConditions,
6     EmptyPrimitive,
7     GridMeasurement,
8 )
9 from qlbm.infra import QiskitRunner, SimulationConfig
10 from qlbm.lattice import CollisionlessLattice
11
12 lattice = CollisionlessLattice("lattice.json")
13 cfg = SimulationConfig(
14     initial_conditions=CollisionlessInitialConditions(lattice),
15     algorithm=CQLBM(lattice),
16     postprocessing=EmptyPrimitive(lattice),
17     measurement=GridMeasurement(lattice),
18     target_platform="QISKIT",
19     compiler_platform="QISKIT",
20     optimization_level=0,
21     statevector_sampling=True,
22     execution_backend=AerSimulator(method="statevector"),
23     sampling_backend=AerSimulator(method="statevector"),
24 )
25
26 cfg.prepare_for_simulation()
27 runner = QiskitRunner(cfg, lattice)
28 runner.run(
29     20, # Number of time steps
30     4096, # Number of shots per time step
31     "qlbm-output", # Output directory
32     statevector_snapshots=True,
33 )

```

Figure 10: Sample QLBM usage.

quantum algorithm doubles with every qubit. In spite of this fundamental limitation, researchers and engineers have been developing tools that can significantly accelerate quantum simulation and increase the domain of algorithms that classical hardware can meaningfully emulate. When considering the advancements that quantum simulation technology has undergone in recent years, one can distinguish between two main directions. The first direction concerns the simulation method. Quantum states can be represented directly as numerical instances of statevectors and density matrices, but also symbolically through graphs [77], tensor networks [51], and decision diagrams [80]. Though none of these methods fully overcome the exponential disadvantage that classical hardware faces, each of them may provide practically meaningful advantages for particular classes of problems. Second, improvements in simulation performance can also come from how the simulation method integrates with hardware. To this end, engineers have developed simulators for different platforms, including general purpose CPUs, as well as ARM-based clusters [35] and GPUs [32, 26].

Selecting suitable simulation methods for the hardware at hand is pivotal for speeding up the simulation and development of QBM algorithms. To reduce the friction between the zoo of available simulator implementations and the researchers looking to exploit them, QLBM provides several built-in presets. The simulation modules of QLBM rely on two external libraries: Qiskit [37] and Qulacs [75]. Qiskit provides a plethora of simulator options through its `qiskit-aer` package, which include nine different simulation techniques for heterogeneous computer hardware. Qulacs provides a competing implementation of a statevector simulator that has been shown to outperform Qiskit in several benchmarks [75]. Both Qiskit and Qulacs provide CPU and GPU implementations of their methods under similar interfaces, which QLBM inherits and provides different installations for. A third option natively supported in QLBM is MPIQulacs [35], a multi-node alternative of Qulacs designed for ARM-based compute clusters, that enables the distributed simulation of quantum algorithms.

The implementations that link QLBM to each simulator reside under specialized implementations of a base `Runner` class. Any of the three implementations can be swapped into the same workflow that Figure 10 shows (*i.e.* by swapping the `QiskitRunner` instruction in line 27). Moreover, users can decide which of the three (CPU, GPU, or MPIQulacs) options they want to use at install time by specifying a single installation parameter. To further boost the reproducibility of research carried out with QLBM, we provide versioned installation options for python environments, as well as Docker containers. For the latter, we bundle QLBM with custom container images that build on top of lightweight Python images and the NVIDIA cuQuantum Appliance for GPU simulation.

Circuit compilation. Much like classical software, high-level descriptions of quantum circuits undergo a compilation process that translates the circuits to an instruction set that is compatible with a specific piece of hardware or simulator. To complement the modularity of QLBM’s circuit specification and simulation options, a similarly versatile compilation system is required. Compilers with configurable platforms are called *retargettable*. We integrate QLBM with two such retargettable compilers: Qiskit [37] and Tket [70]. Both frameworks offer a broad range of compilation targets and optimization techniques that can target both quantum simulators, as well as quantum hardware. Providing both options by default inside QLBM allows researchers to experiment with competing compilation options that may be favorable for different scenarios. For this purpose, we additionally build logging and analysis tools within QLBM, that allow users to automate the exploration and benchmarking of available options.

From an implementation standpoint, QLBM simplifies the interaction between the framework and available compilers by providing a single entry point through a `CircuitCompiler` class. Through a single call to the object constructor, users can specify the compiler platform (Qiskit or Tket) and its target (Qiskit or Qulacs) without any additional complications (*i.e.* `CircuitCompiler("TKET", "QISKIT")`). Additional options are available through the single `.compile()` method that allows users to select different backends and optimization levels. Currently, QLBM makes all cross-combinations of compiler platforms and targets available. This includes all extensions of Qiskit and Tket Backends, both simulator and hardware-specific emulators, as well as the Qulacs and MPIQulacs. To further simplify the interaction between the QLBM users and the vast number of viable combinations, we implement compilers in such a way that QLBM components can be directly input into the compiler, without requiring any processing or decomposition of the circuit (*i.e.* `CircuitCompiler("QISKIT", "QULACS").compile(CQLBM(lattice), ...)`).

Visualization. Visualization serves two main purposes in QLBM. The first is to convert the information extracted from the quantum state at the end of the computation into a visual interpretation of the flow field. Developers can use this feature to verify the correctness of an implementation and the evolution of the flow field over time. For debugging purposes, we additionally allow users to save the statevector and counts to disk alongside the flow field visualization. The second goal of QLBM visualization tools is to provide a means for quickly assessing the difference in the performance and scaling of QBM algorithms and their adjacent infrastructure. To achieve this, QLBM provides scripts that automate both the parsing of log information into common data formats and the conversion of the extracted data into plots.

Implementation-wise, flow field visualization relies on the Visual Toolkit (VTK) [65] software package to efficiently encode flow field count data into standard formats. For geometry data, QLBM converts the cuboid bounds into triangulated surfaces in the commonplace `stl` format. Both flow field and geometry visualization conversions take place into specialized implementations of the base `QLBMResult` class that is specific to each QBM and integrates with the rest of the infrastructure. We select these formats specifically such that each artifact generated by QLBM can be visualized in Paraview [2] without any additional user intervention. Finally, performance logs are parsed by scripts bundled in Jupyter Notebooks for easy editing and plotting within the QLBM environment.

3 Results

This section demonstrates the experimental capabilities of QLBM. We highlight the computational and analysis tools of QLBM in order of the workflow depicted in Figure 1. Section 3.1 showcases how the properties of quantum circuits can be analyzed by parameterizing the high-level JSON configuration files. In Section 3.2, we address the next step in the QLBM workflow – compilation. We specifically analyze the performance of different compilers and the trade-offs they present. Section 3.3 covers simulation performance in detail. We begin by comparing the performance of different simulation platforms, before considering GPU compatibility. We also highlight how the computational improvements of concerning statevector processing significantly speed up simulation. Finally, Section 3.4 displays the visualization options that QLBM supports. All experiments were performed on a machine equipped with an AMD Ryzen 7 5800H CPU, 16 GB of RAM, and an NVIDIA 3050Ti GPU with 4GB of VRAM.

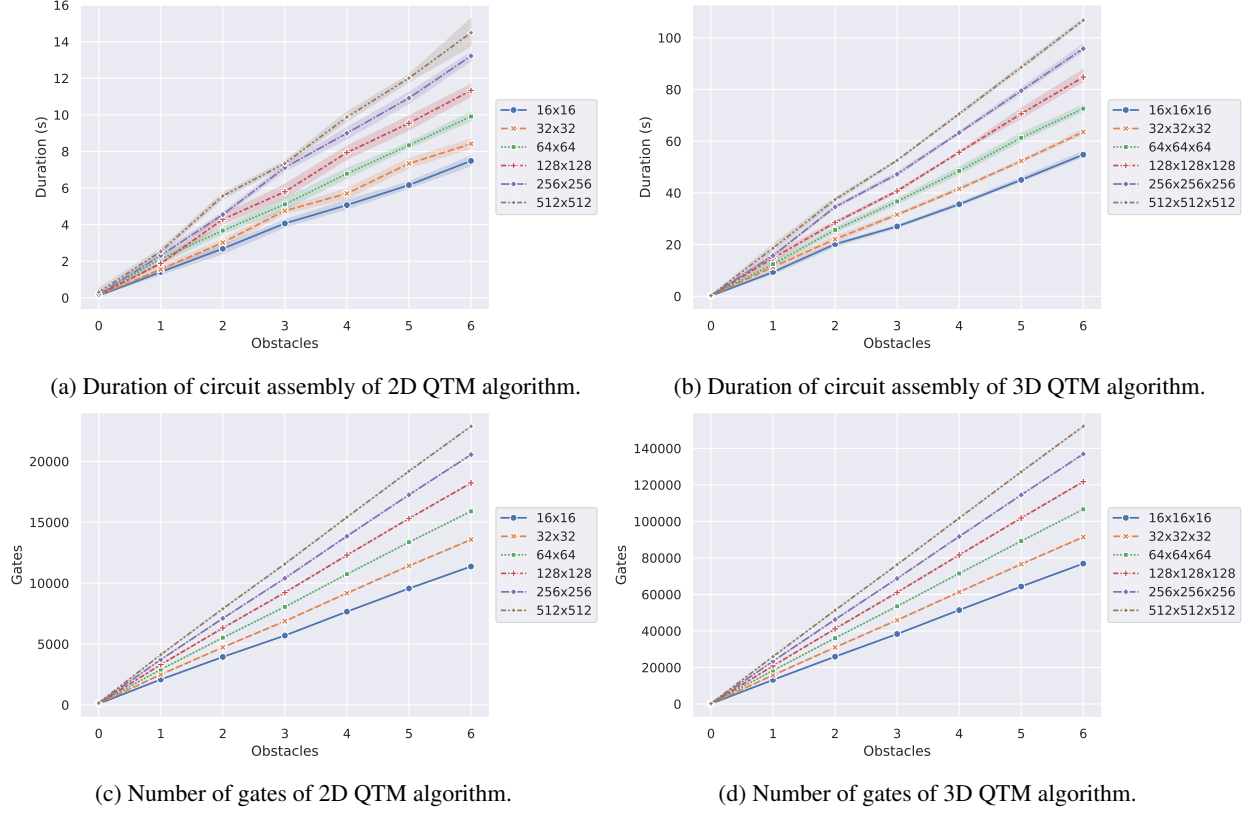

Figure 11: Comparison of QTM algorithm properties for uniform lattices between 16×16 and $512 \times 512 \times 512$ grid points and between 0 and 6 obstacles with bounce-back boundary conditions.

3.1 Algorithmic scalability

We begin analyzing the scalability of the QTM algorithm [61] expressed as the high-level circuit that QLBM generates as a platform-agnostic quantum circuit. The simple specifications through which users configure QLBM makes it such that many different parameters can be isolated and analyzed independently. For the purposes of this experiment, we select the number of objects within the fluid domain and the number of grid points in each dimension as the subjects of the analysis, because of their impact on the structure and depth of the quantum circuit. We consider the depth of the circuit and the time it takes QLBM to assemble it. To mitigate the effects of noise, we execute each experiment 5 times. The aim of this analysis is to highlight how QLBM facilitates the experimental analysis of quantum circuit implementation. For an in-depth complexity analysis of the complexity of the algorithm, we point the reader to Section 7 of [61]. Figure 11 displays the experimental results.

Figure 11a and Figure 11b show the how dimensionality, grid refinement, and geometry affect the time it takes for QLBM to assemble the quantum circuits. Dimensionality and grid refinement both affect the number of qubits required to simulate the system, and as such they introduce additional linear complexity in the circuit. The number of (cuboid) obstacles has a similarly significant and linear on the assembly duration. This behavior is expected, as the implementation of QTM algorithm reuses structurally identical comparator operators to determine which populations to stream, for each edge and surface of an object. Of note is that the majority of the complexity of the QTM algorithm stems from reflection. Increasing the number of obstacles from 1 (median assembly time 5.35s) to 5 (median assembly time 34.8s) causes a similar proportional increase in assembly time (6.50) as increasing the dimensionality of the system from 2D (median assembly time 5.38) to 3D (median assembly time 37.4) while keeping the number of obstacles fixed (proportional increase 6.96). The assembly duration increases are consistent with the number of gates of the algorithm shown in Figure 11c and Figure 11d. Both geometry complexity and grid refinement affect the scaling of the number of gates linearly.

The increase in both gate count and assembly time originates from two sources. First, operations on individual lattice locations require controlled operations based on the entire grid register. These operations primarily occur around the corner points of objects, and they make the distinction between which populations are subject to boundary condition

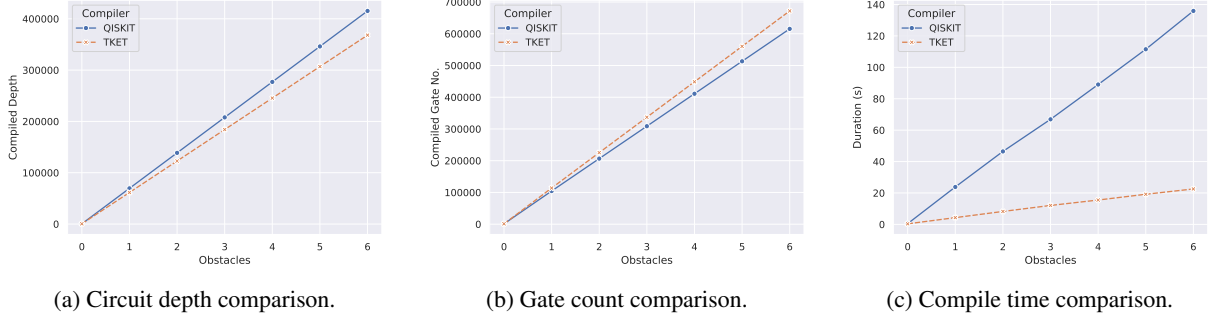

Figure 12: Compiler comparison for 2D QTM algorithm for a 16×16 grid with 4 discrete velocities per dimension and between 0 and 6 obstacles in the domain.

treatment. As the size of grid register scales with the refinement of the underpinning lattice, so does the number of gates required to set and reset the quantum state for each point. The second reason for the grid point-driven scaling has to do with the controlled incrementation operation that both streaming and reflection utilize. These circuits rely on a QFT operation followed by a controlled phase shift that increments the position of particles in physical space by one grid point. Each of these operations too scale with the size of the grid register, as incrementation has to take place uniformly. Geometry-based scaling stems from the fact that the QLBM implementation of QTM boundary conditions iterates through each surface of each obstacle in the lattice, which adds a number of gates that scales linearly with the number of obstacles. Finally, we emphasize that QLBM enables the analysis of such algorithmic properties for all quantum components (*i.e.* primitives, operators, algorithms), which in turn facilitates resource estimation for different implementations. In Section 3.2, we extend this analysis to low-level circuits targeted towards specific gate sets.

3.2 Compiler comparison

We shift focus towards analyzing the QBM circuits after transpiling them to lower-level gate sets. Here, we consider the performance of the Qiskit and Tket compilers and their trade-offs. We again use the end-to-end QTM algorithm [61] as a benchmark, and analyze three metrics for each compiler – compilation time, circuit depth, and gate count. Together, these three metrics give an indication of the trade-offs that users face when choosing between transpilation times and performance. For the compiler platform, we select the Qulacs gate set available both in Qiskit and Tket through the `qiskit-qulacs` and `pytket-qulacs` packages, respectively. Qulacs has a significantly more restricted gate set than the one that QLBM uses to construct quantum circuits, which makes it a suitable candidate for such a benchmark because of its likeness to real quantum hardware constraints. We select a 17 qubit quantum circuit simulating one time step of a 16×16 grid with 4 discrete velocities in each dimensions and between 0 and 6 obstacles with bounce-back boundary conditions placed at different positions on the grid. We specifically select the number of obstacles as the parameter to be varied as it only influences the depth and number of gates of the circuit, rather than the number of qubits. This factor also has the largest impact on algorithm complexity, after dimensionality.

Figure 12 displays the results. When assessing compiler performance in terms of the conciseness of the generated circuit, Figure 12a and Figure 12b show that the Tket and Qiskit compilers have different strengths. While Qiskit generates circuits that contain up to 50,000 fewer gates than their Tket counterparts, the Tket circuits have a depth that is up to 20,000 gates shallower. For both compilers, the depth and the gate count scale linearly with the number of obstacles in the grid, which is in line with the scalability analysis. A third natural consideration when assessing compilers is computation time. While the scaling is again linear for both candidates, Tket is significantly faster than Qiskit, and is able to transpile the most complex circuit in under one sixth of the time that Qiskit requires. The QLBM analysis and benchmark suite makes such experiments easy to execute and replicate, which in turn helps practitioners make informed decisions that can significantly accelerate their workflows. We next extend this analysis to the performance of different simulators under nominal use cases on different hardware platforms.

3.3 Performance comparison

Selecting the appropriate simulation technology for the hardware available at hand is a necessity for optimizing the development process of novel QBMs. Performance is sensitive to many factors, including the simulation paradigm, its compatibility with available hardware, and its suitability for the structure of the circuits being simulated. Constructing QBM implementations that are versatile enough to allow for experimentation with all of these parameters is a time-consuming ordeal that QLBM seeks to relieve researchers of. In this subsection, we demonstrate automated experiments

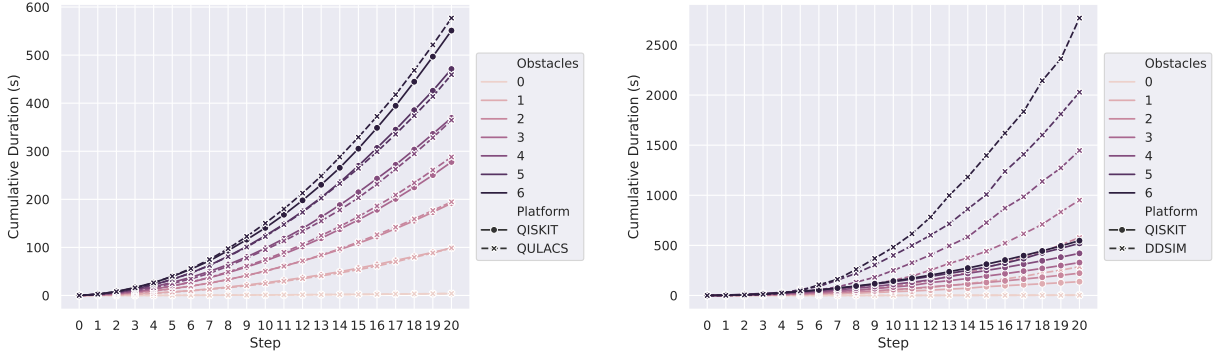

(a) Comparison of Qiskit and Qulacs simulation performance. (b) Comparison of Qiskit and DDSIM simulation performance.

Figure 13: Simulator comparison for 2D QTM algorithm for a 16×16 grid with 4 discrete velocities per dimension and between 0 and 6 obstacles in the domain, for up to 20 time steps.

that users of QLBM can easily carry out to assess the performance of simulation software for their specific needs. We begin with assessing different simulators with out-of-the-box settings before assessing the statevector snapshot technique described in Section 2.2.2 and showing its integration with GPUs.

Simulator comparison. Perhaps the most important choice when it comes to assessing simulation performance is choosing the appropriate software library. This poses a challenge for developers, as differences in library APIs, software dependencies, and circuit assumptions can all hamper the simulation of QBMs. To alleviate these burdens, QLBM provides two features. First, the modular design of the `Runner` module allows for easy extensibility to novel simulators. Second, the built-in `SimulationConfig` class automatically parses all components that make up the QBM into the appropriate format for simulation, for any provided simulator. We demonstrate such experiments by comparing the baseline Qiskit `AerSimulator` with two alternatives: Qulacs [75] and DDSIM.² To ensure fairness, we compare each simulator against the baseline in independent Python virtual environments because of dependency discrepancies. Statevector snapshots and sampling are both turned off in this experiment.

Figure 13 displays the results. Figure 13a indicates that Qiskit and Qulacs perform similarly well for all 7 instances. For lattices with up to 3 obstacles, the performance of the two simulators is almost indistinguishable. For the instance with 4 obstacles, Qulacs slightly outperforms Qiskit, while the instances 3, 5, and 6 obstacles slightly favor Qiskit. Figure 13b shows the comparison between the same Qiskit simulator and DDSIM. Here, all instances show a significant difference between the simulators, in favor of Qiskit. As the circuits grow more complex (*i.e.* more obstacles), the difference becomes practically more relevant. While this in no way implies the general superiority of the Qiskit simulator, it hints at the fact that the circuits that implement the QTM algorithm in QLBM may be structurally a poor fit for the decision diagram decomposition that DDSIM relies on. This kind of analysis can point researchers towards the simulator that best fits the kind of algorithm they are working on extending or implementing. In what follows, we analyze how the statevector snapshot technique can significantly increase the performance of any simulator capable of capturing entire statevectors.

Statevector snapshots. Figure 14 shows the scalability of the statevector snapshot and sampling techniques described in Section 2.2.2. Dashed lines indicate configurations that were simulated with both techniques enabled, whereas solid lines indicate regular simulations. Both sets of experiments were repeated 5 times, and the figures illustrate the mean and standard deviation of the simulation time, respectively. For consistency, we consider the same benchmark example as in the previous experiments. Both the generation of the circuits, as well as the compilation (through Qiskit) were handled through the standard QLBM workflow. All simulations were carried out on Qiskit’s `AerSimulator` with the statevector method, which has shown the best performance in previous instances.

The results confirm the complexity analysis provided in Section 2.2.2. Focusing on Figure 14a, the results show how when combined, the snapshot and sampling techniques can decrease the time required to perform a 20-step simulation by up to a factor of 6. The deviation in performance is increasingly visible as the complexity of the circuit scales with the number of obstacles in the fluid domain. Concretely, simulations that use both of our computational improvement techniques scale linearly in the number of steps simulated, while the standard simulation method scales quadratically. In the practical development cycle, this drastically accelerates the pace at which researchers can verify and debug their

²DDSIM is available at <https://github.com/cda-tum/mqt-ddsim>.



(a) Comparison of statevector snapshot performance for up to 20 time steps of the QTM algorithm.

(b) Comparison of statevector snapshot performance for up to 5 time steps of the QTM algorithm.

Figure 14: Comparison of statevector snapshot performance for a 16×16 grid with 4 discrete velocities per dimension and between 0 and 6 obstacles in the domain, for up to 20 time steps.

implementations. Since the difference between statevector snapshots and regular simulations scales linearly with the complexity of a single time step circuit, the number of time steps that snapshots save is always higher for more complex systems. This is a valuable improvement in practice, as more complex systems generally require more runs to verify and debug.

We also note that the transfer of statevectors between simulators, despite not requiring a deep copy, still introduces overhead that is meaningful in some instances. This is especially visible for shorter circuits, where statevector transfer between simulators takes up a higher percentage of the computational time. For simpler circuits, such as the instances with 1 and 2 objects, the scaling advantage only overtakes this overhead after 4 and 3 steps, respectively. As the complexity of the simulated circuits increases however, the number of steps required for the statevector snapshots to become advantageous decreases. For the instance with 3 obstacles, the overhead is only unfavorable for the first time step, following which the scaling factor becomes dominant. To better highlight this downside of snapshots, we zoom in in Figure 14b. Averaging over all lattice configurations, it takes 3 time steps to gain a practical advantage from the snapshot mechanism, which also proved advantageous for all runs after 5 time steps (or more). As researchers are typically interested in simulating tens or hundreds of time steps for algorithmic verification purposes, this overhead is rarely a downside in practice. In the next paragraphs, we show the versatility of the snapshot mechanism by performing simulations on a GPU.

GPU integration. All QLBM performance improvements can leverage multiple compute architectures, including GPUs and ARM-based CPUs. We demonstrate this by showing the applicability of the statevector snapshot mechanism when applied to GPU simulation. We use the same benchmark as in the previous two example and compare the Qiskit AerSimulator running CPU and GPU devices with both snapshots and sampling optimizations enabled. The GPU simulator leverages the cuQuantum SDK [7] and runs in a modified Docker container, based on the NVIDIA cuQuantum Appliance. As with all examples used throughout this manuscript, we make the container used in this benchmark available with the rest of code base.

Figure 15 shows the results. Both the CPU and GPU simulator display the same linear scaling as Figure 14. The CPU version slightly edges its GPU counterpart in 4 of 7 instances, but no significant difference occurs between the two. As in the Qulacs and DDSIM example, these experiments are meant to highlight the ease with which practitioners can test different simulator options that pertain to heterogeneous hardware platforms, within the QLBM workflow. Furthermore, the results demonstrate the versatility of the snapshot and sampling techniques, which nets users significant improvements when compared to naive implementations. In what follows, we feature how QLBM makes use of these effective simulation techniques to create detailed and useful visualizations of the system under simulation, concluding the workflow.

3.4 Visualization integration

Visualization serves two important purposes in the QLBM pipeline. First, it allows researchers to verify the correctness of their implementation. This is especially important when addressing end-to-end algorithms. Complete circuits may

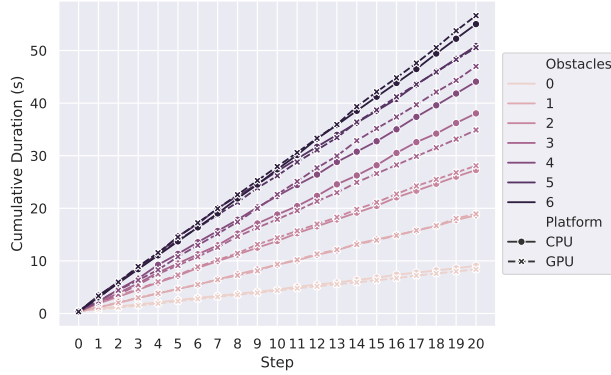

Figure 15: CPU and GPU performance comparison using statevector snapshots for a 16×16 grid with 4 discrete velocities per dimension and between 0 and 6 obstacles in the domain, for up to 20 time steps.

be hundreds of thousands of gates deep and simultaneously address dozens of boundary condition edge cases, and visualization provides a means of assuring that end-to-end integration of the quantum components is sound in relation to the physical system being simulated. The second grounds for visualization is accessibility. For users familiar with classical CFD workflows, integration with established visualization software bridges the gap between the novelty of the quantum methods and standard practices. In this subsection, we demonstrate the built-in PARAVIEW [2] integration of QLBM for both the QTM [61] and STQBM [62] algorithms.

Figure 16 depicts the evolution of a 2D system with 64 grid points in each dimension and seven obstacles placed in close proximity to one another. Each dimension has 4 discrete velocities, and the entire circuit is comprised of only 22 qubits. Obstacles depicted in grey are imposed bounce-back boundary conditions, while black objects implement specular reflection. The edges of the domain implement periodic boundary conditions. Figure 16a shows the initial conditions of the system, with particles distributed uniformly throughout the left half of the domain. Darker shades of red indicate the presence of a higher concentration of particles. Any irregularities in the density stem from the stochasticity of the counts extracted from the quantum state at the end of each time step. While inexact, this is the same process that one would follow on actual quantum hardware. The initial conditions are set up with native quantum gates, and are such that all particles in the systems have velocities pointing in the positive directions in both the x and the y axes. Intuitively, particles are moving towards the upper right-hand corner of the domain. Figure 16b, Figure 16c, and Figure 16d show the evolution of the system after 16, 32, and 64 steps. Higher particle densities emerge naturally at the boundaries of objects, as well as in areas where particles meet as a result of the change in direction caused by the different boundary conditions of the objects. Figure 16c showcases the difference between the two types of boundary conditions: the particles interacting with the obstacles in the upper half of the domain get reflected along their previous trajectory, while their counterparts in the lower half of the domain interact differently with the obstacle walls.

Figure 17 highlights an example of a 3D flow in a $16 \times 16 \times 16$ system with 2 bounce-back boundary conditioned obstacles of different shapes. As in the previous example, each dimension has 4 discrete velocities. With QLBM’s adaptive register setup, the entire quantum circuit only requires 28 qubits. Each discrete grid point is represented by a sphere, the color of which denotes the relative density of particles at that physical location. As in the 2D example, darker shades of red indicate higher densities, and dark blue spheres indicate the absence of particles. Figure 17a again shows the initial conditions, which are the 3D equivalent of the previous example. We choose this specific visualization integration as it allows for the examination of individual grid locations that correspond to specific edge cases in the underlying quantum algorithm, which makes verification significantly less tedious than otherwise parsing information from the computed quantum state. We also highlight the fact that in the QLBM implementation of the QTM algorithm, there are no additional constraints on 3D systems: the same boundary conditions, simulation techniques, and visualization media are supported.

Figure 18 illustrates the evolution of a 8×8 system simulated with the STQBM algorithm. In addition to streaming, the STQBM also performs collision at the cost of including neighboring velocity information for each grid point. In practice this limits the size of systems that classical hardware can emulate for practical development and research purposes. For the 5 steps in Figure 18, 1024 qubits would have been required to simulate the end-to-end system, which is infeasible for any classical hardware available today. The simulation was instead performed using QLBM’s automated reinitialization mechanism described in Section 2.2.2, which can function with circuits as small as one time step. While this does inherently introduce inaccuracies in the quantum computation, the space-time encoding is less susceptible to this than amplitude-based methods, and the performance advantage gained from reinitialization is substantial – the

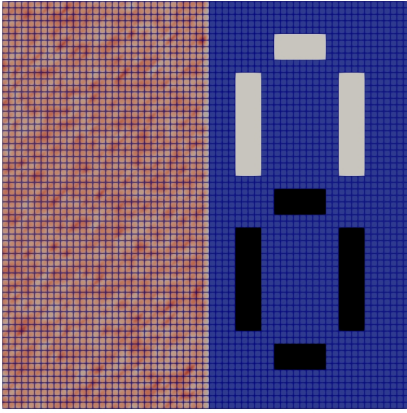

(a) The initial conditions of the particle distribution.

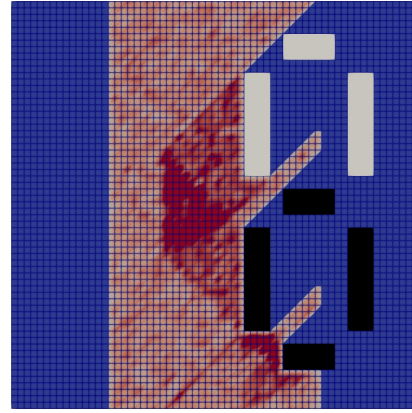

(b) The system after 16 time steps.

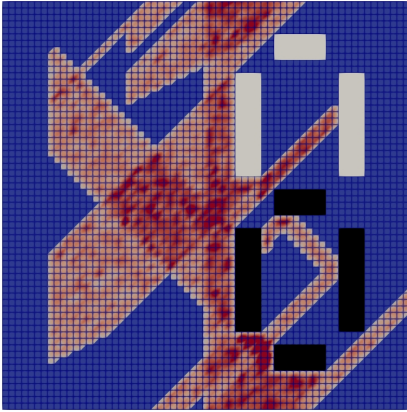

(c) The system after 32 time steps.

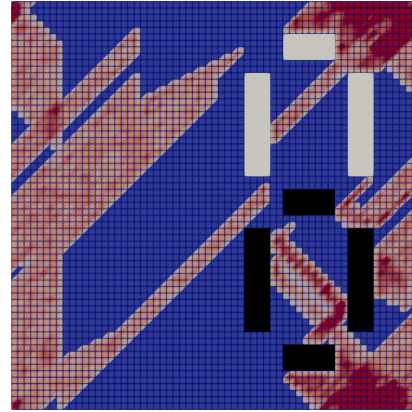

(d) The system after 64 time steps.

Figure 16: Simulation of the QTM algorithm [61] on a 64×64 grid for with 7 solid obstacles for 64 time steps.

entire simulation, including parsing the results into the visualization format takes seconds on commodity hardware. The only precision lost through reinitialization is in the relative density of particles at specific grid locations – basic constraint such as conservation of mass are not violated. We again stress that reinitialization is a feature of QLBM and not a requirement of the underlying algorithms, which can be executed entirely on quantum hardware, provided a sufficient number qubits.

Figure 18a shows the initial state of the system, where 4 particles are concentrated in one grid point, under the D_2Q_4 lattice discretization. The 4 particles are each travelling along one of each of the 4 discrete velocity channels. Following one time step, particles stream to neighboring grid points (Figure 18b). Since collision only affects instances where particles reach the same grid point and have a velocity profile that can be mapped onto an equivalence class, the 3 following time steps are unaffected by it and only practically consist of streaming, with the added complexity of periodicity. In Figure 18e, two particles reach the same grid point in two different instances, both with velocity profiles that collision affects. As a result, collision redistributes the particles such that mass and momentum are conserved, as described in [62]. This simulation was carried out using a circuit that only performs the computation of one time step, shown in Figure 19. Reinitialization automatically computes the initial conditions that allow the transition between steps be carried between time steps. This is assumed to prepare the state of grid qubits prior to simulation.

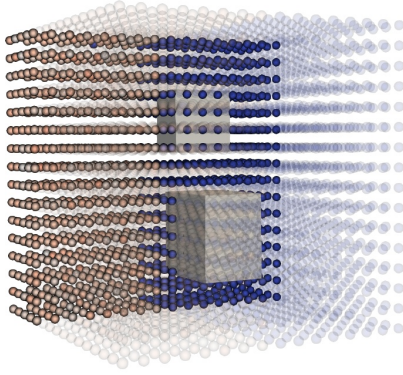

(a) The initial conditions of the particle distribution.

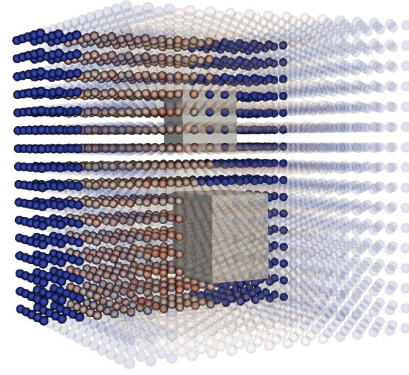

(b) The system after 3 time steps.

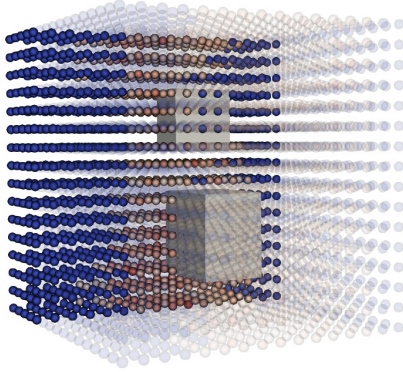

(c) The system after 6 time steps.

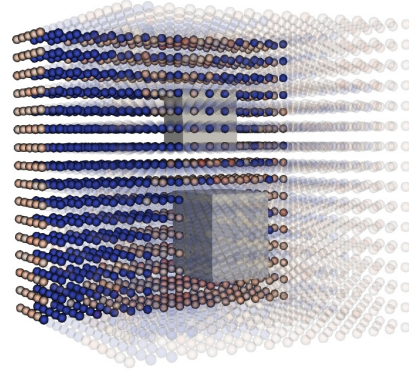

(d) The system after 9 time steps.

Figure 17: Simulation of the QTM algorithm [61] on a $16 \times 16 \times 16$ grid for with 2 solid obstacles for 9 time steps.

4 Conclusion

We introduced QLBM, a Python software framework that aims to accelerate the development, simulation, and analysis of Quantum Lattice Boltzmann Methods. We designed QLBM as an end-to-end development environment that caters to every step of the research process, from assembling proof-of-concept quantum circuits to analyzing their performance within different simulation platforms. The modular architecture of QLBM decouples the hierarchically arranged quantum component module from external infrastructure, which promotes testability through isolation. Additional modules interface with state-of-the-art quantum simulators and compilers, which allows users to seamlessly tune their setup according to their goals and resources.

To increase the accessibility of QBMs to researchers and practitioners with various backgrounds, we implemented convenient interfaces that bridge the gap between the delicate quantum circuit assembly process and the high-level interfaces that users have come to expect from more mature classical software frameworks. We introduced novel simulation techniques in the form of statevector snapshots, statevector sampling, and reinitialization, which massively increase the performance of simulations and in turn hasten future research. Finally, we demonstrated the versatility of these techniques by incorporating them within 2D and 3D simulations on CPUs and GPUs and showed the practical benefit of built-in experimentation pipelines and visualization techniques. To encourage collaboration and reproducibility

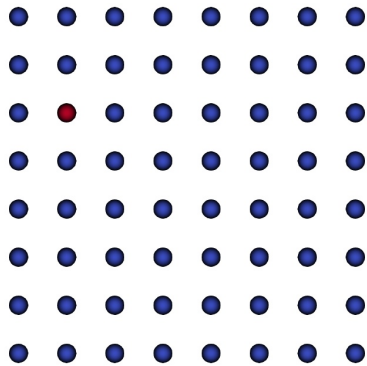

(a) The initial conditions of the particle distribution.

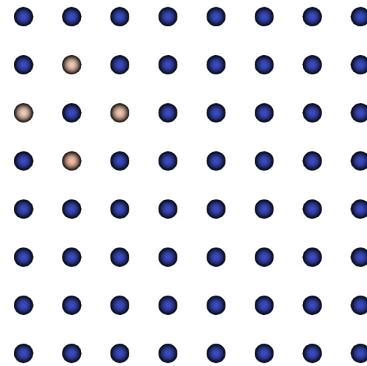

(b) The system after 1 time step.

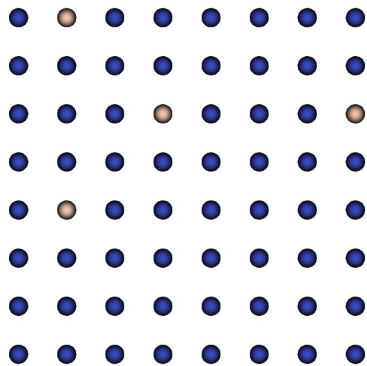

(c) The system after 2 time steps.

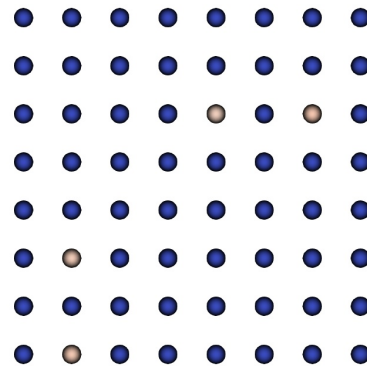

(d) The system after 3 time steps.

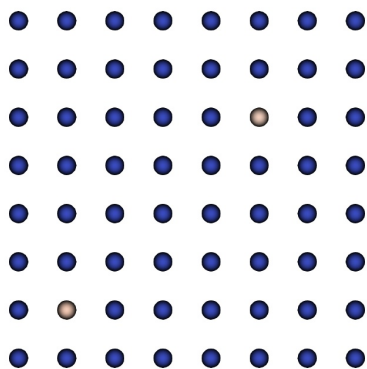

(e) The system after 4 time steps.

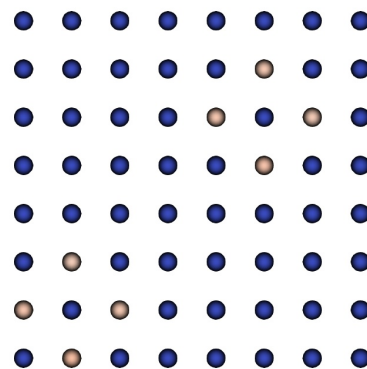

(f) The system after 5 time steps.

Figure 18: Simulation of the STQBM algorithm [62] on a $16 \times 16 \times 16$ grid for with 2 solid obstacles for 64 time steps.

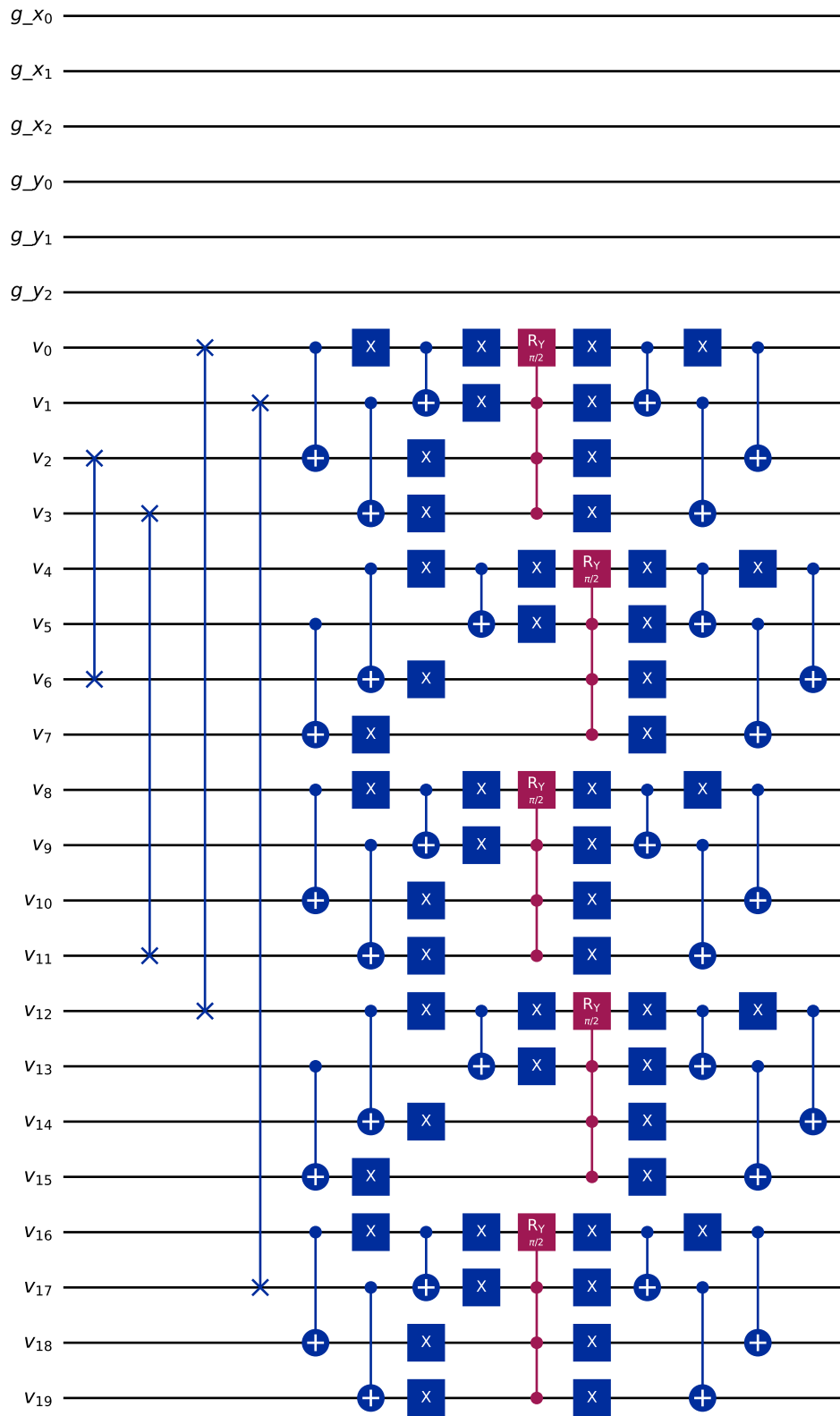

Figure 19: One time step STQBM [62] circuit.

in the field of quantum computational fluid dynamics, we make both the source code of QLBM and a replication package of this study available at <https://github.com/QCFD-Lab/q1bm> and [27], respectively.

We envisage two future directions for QLBM. Primarily, the purpose of this framework is to be of service the broader QCFD research community and assist in QBM development. This includes both the implementation of novel algorithms in the future, as well as the generalization of past and present techniques from the literature. Secondly, QLBM will remain up-to-date with the rapid developments occurring in the quantum software field. Novel simulation and transpiler technologies, and access to increasingly robust quantum hardware are developments which we aim to continue to integrate within QLBM, while retaining its high code quality and reproducibility standards.

5 Acknowledgements

We gratefully acknowledge support from the joint research program *Quantum Computational Fluid Dynamics* by Fujitsu Limited and Delft University of Technology, co-funded by the Netherlands Enterprise Agency under project number PPS23-3-03596728.

References

- [1] Scott Aaronson. Read the fine print. *Nature Physics*, 11(4):291–293, 2015.
- [2] James Ahrens, Berk Geveci, Charles Law, C Hansen, and C Johnson. 36-paraview: An end-user tool for large-data visualization. *The visualization handbook*, 717:50038–1, 2005.
- [3] Andris Ambainis. Variable time amplitude amplification and a faster quantum algorithm for solving systems of linear equations. *arXiv preprint arXiv:1010.4458*, 2010.
- [4] Lindsay Bassman Oftelie, Connor Powers, and Wibe A De Jong. Arqtic: A full-stack software package for simulating materials on quantum computers. *ACM Transactions on Quantum Computing*, 3(3):1–17, 2022.
- [5] Martin Bauer, Sebastian Eibl, Christian Godenschwager, Nils Kohl, Michael Kuron, Christoph Rettinger, Florian Schornbaum, Christoph Schwarzmeier, Dominik Thönnies, Harald Köstler, et al. walberla: A block-structured high-performance framework for multiphysics simulations. *Computers & Mathematics with Applications*, 81: 478–501, 2021.
- [6] Martin Bauer, Harald Köstler, and Ulrich Rüde. lbmpy: Automatic code generation for efficient parallel lattice boltzmann methods. *Journal of Computational Science*, 49:101269, 2021.
- [7] Harun Bayraktar, Ali Charara, David Clark, Saul Cohen, Timothy Costa, Yao-Lung L Fang, Yang Gao, Jack Guan, John Gunnels, Azzam Haidar, et al. cuquantum sdk: A high-performance library for accelerating quantum science. In *2023 IEEE International Conference on Quantum Computing and Engineering (QCE)*, volume 1, pages 1050–1061. IEEE, 2023.
- [8] Ville Bergholm, Josh Izaac, Maria Schuld, Christian Gogolin, Shahnawaz Ahmed, Vishnu Ajith, M Sohaib Alam, Guillermo Alonso-Linaje, B AkashNarayanan, Ali Asadi, et al. PennyLane: Automatic differentiation of hybrid quantum-classical computations. *arXiv preprint arXiv:1811.04968*, 2018.
- [9] Ethan Bernstein and Umesh Vazirani. Quantum complexity theory. In *Proceedings of the twenty-fifth annual ACM symposium on Theory of computing*, pages 11–20, 1993.
- [10] Prabhu Lal Bhatnagar, Eugene P Gross, and Max Krook. A model for collision processes in gases. i. small amplitude processes in charged and neutral one-component systems. *Physical review*, 94(3):511, 1954.
- [11] Carlos Bravo-Prieto, Ryan LaRose, Marco Cerezo, Yigit Subasi, Lukasz Cincio, and Patrick J Coles. Variational quantum linear solver. *Quantum*, 7:1188, 2023.
- [12] Michael Broughton, Guillaume Verdon, Trevor McCourt, Antonio J Martinez, Jae Hyeon Yoo, Sergei V Isakov, Philip Massey, Ramin Halavati, Murphy Yuezhen Niu, Alexander Zlokapa, et al. Tensorflow quantum: A software framework for quantum machine learning. *arXiv preprint arXiv:2003.02989*, 2020.
- [13] Ljubomir Budinski. Quantum algorithm for the advection–diffusion equation simulated with the lattice boltzmann method. *Quantum Information Processing*, 20(2):57, 2021.
- [14] Ljubomir Budinski. Quantum algorithm for the navier–stokes equations by using the streamfunction-vorticity formulation and the lattice boltzmann method. *International Journal of Quantum Information*, 20(02):2150039, 2022.
- [15] JM Buick, CA Greated, and DM Campbell. Lattice bgk simulation of sound waves. *Europhysics Letters*, 43(3): 235, 1998.

- [16] Yudong Cao, Jonathan Romero, Jonathan P Olson, Matthias Degroote, Peter D Johnson, Mária Kieferová, Ian D Kivlichan, Tim Menke, Borja Peropadre, Nicolas PD Sawaya, et al. Quantum chemistry in the age of quantum computing. *Chemical reviews*, 119(19):10856–10915, 2019.
- [17] Zhenhua Chai and Baochang Shi. A novel lattice boltzmann model for the poisson equation. *Applied mathematical modelling*, 32(10):2050–2058, 2008.
- [18] Zhenhua Chai and TS Zhao. Lattice boltzmann model for the convection-diffusion equation. *Physical Review E—Statistical, Nonlinear, and Soft Matter Physics*, 87(6):063309, 2013.
- [19] Andrew M Childs and Nathan Wiebe. Hamiltonian simulation using linear combinations of unitary operations. *arXiv preprint arXiv:1202.5822*, 2012.
- [20] Andrew M Childs, Robin Kothari, and Rolando D Somma. Quantum algorithm for systems of linear equations with exponentially improved dependence on precision. *SIAM Journal on Computing*, 46(6):1920–1950, 2017.
- [21] B David Clader, Bryan C Jacobs, and Chad R Sprouse. Preconditioned quantum linear system algorithm. *Physical review letters*, 110(25):250504, 2013.
- [22] Andrew Cross, Ali Javadi-Abhari, Thomas Alexander, Niel De Beaudrap, Lev S Bishop, Steven Heidel, Colm A Ryan, Prasahnt Sivarajah, John Smolin, Jay M Gambetta, et al. Openqasm 3: A broader and deeper quantum assembly language. *ACM Transactions on Quantum Computing*, 3(3):1–50, 2022.
- [23] David Deutsch and Richard Jozsa. Rapid solution of problems by quantum computation. *Proceedings of the Royal Society of London. Series A: Mathematical and Physical Sciences*, 439(1907):553–558, 1992.
- [24] Cirq Developers. Cirq. *Zenodo*, May 2024. doi:10.5281/zenodo.11398048.
- [25] E Dinesh Kumar and Steven H Frankel. Quantum circuit model for lattice boltzmann fluid flow simulations. *arXiv preprint arXiv:2405.08669*, 2024.
- [26] Stavros Efthymiou, Sergi Ramos-Calderer, Carlos Bravo-Prieto, Adrián Pérez-Salinas, Diego García-Martín, Artur Garcia-Saez, José Ignacio Latorre, and Stefano Carrazza. Qibo: a framework for quantum simulation with hardware acceleration. *Quantum Science and Technology*, 7(1):015018, 2021.
- [27] Calin Georgescu, Merel Annelise Schalkers, and Matthias Möller. Replication Package for QLBM – A Quantum Lattice Boltzmann Software Framework. *Zenodo*, November 2024. doi:10.5281/zenodo.14231193. URL <https://doi.org/10.5281/zenodo.14231193>.
- [28] Peyman Givi, Andrew J Daley, Dimitri Mavriplis, and Mujeeb Malik. Quantum speedup for aerospace and engineering. *AIAA Journal*, 58(8):3715–3727, 2020.
- [29] Alexander S Green, Peter LeFanu Lumsdaine, Neil J Ross, Peter Selinger, and Benoît Valiron. Quipper: a scalable quantum programming language. In *Proceedings of the 34th ACM SIGPLAN conference on Programming language design and implementation*, pages 333–342, 2013.
- [30] Lov K Grover. A fast quantum mechanical algorithm for database search. In *Proceedings of the twenty-eighth annual ACM symposium on Theory of computing*, pages 212–219, 1996.
- [31] Zhaoli Guo, TS Zhao, and Yong Shi. A lattice boltzmann algorithm for electro-osmotic flows in microfluidic devices. *The Journal of chemical physics*, 122(14), 2005.
- [32] Eladio Gutierrez, Sergio Romero, Maria A Trenas, and Emilio L Zapata. Simulation of quantum gates on a novel gpu architecture. In *International Conference on Systems Theory and Scientific Computation*, 2007.
- [33] Aram W Harrow, Avinatan Hassidim, and Seth Lloyd. Quantum algorithm for linear systems of equations. *Physical review letters*, 103(15):150502, 2009.
- [34] Cornelius Hempel, Christine Maier, Jonathan Romero, Jarrod McClean, Thomas Monz, Heng Shen, Petar Jurcevic, Ben P Lanyon, Peter Love, Ryan Babbush, et al. Quantum chemistry calculations on a trapped-ion quantum simulator. *Physical Review X*, 8(3):031022, 2018.
- [35] Satoshi Imamura, Masafumi Yamazaki, Takumi Honda, Akihiko Kasagi, Akihiro Tabuchi, Hiroshi Nakao, Naoto Fukumoto, and Kohta Nakashima. mpiqulacs: a distributed quantum computer simulator for a64fx-based cluster systems. *arXiv preprint arXiv:2203.16044*, 2022.
- [36] Wael Itani and Sauro Succi. Analysis of carleman linearization of lattice boltzmann. *Fluids*, 7(1):24, 2022.
- [37] Ali Javadi-Abhari, Matthew Treinish, Kevin Krsulich, Christopher J. Wood, Jake Lishman, Julien Gacon, Simon Martiel, Paul D. Nation, Lev S. Bishop, Andrew W. Cross, Blake R. Johnson, and Jay M. Gambetta. Quantum computing with Qiskit, 2024.
- [38] SK Jeswal and S Chakraverty. Recent developments and applications in quantum neural network: A review. *Archives of Computational Methods in Engineering*, 26(4):793–807, 2019.

- [39] Mathias J Krause, Adrian Kummerländer, Samuel J Avis, Halim Kusumaatmaja, Davide Dapelo, Fabian Klemens, Maximilian Gaedtke, Nicolas Hafen, Albert Mink, Robin Trunk, et al. Openlb—open source lattice boltzmann code. *Computers & Mathematics with Applications*, 81:258–288, 2021.
- [40] Timm Krüger, Halim Kusumaatmaja, Alexandr Kuzmin, Orest Shardt, Goncalo Silva, and Erlend Magnus Viggen. The lattice boltzmann method. *Springer International Publishing*, 10(978-3):4–15, 2017.
- [41] Oleksandr Kyriienko, Annie E Paine, and Vincent E Elfving. Solving nonlinear differential equations with differentiable quantum circuits. *Physical Review A*, 103(5):052416, 2021.
- [42] Martin Larocca, Supanut Thanasilp, Samson Wang, Kunal Sharma, Jacob Biamonte, Patrick J Coles, Lukasz Cincio, Jarrod R McClean, Zoë Holmes, and M Cerezo. A review of barren plateaus in variational quantum computing. *arXiv preprint arXiv:2405.00781*, 2024.
- [43] Jonas Latt, Orestis Malaspinas, Dimitrios Kontaxakis, Andrea Parmigiani, Daniel Lagrava, Federico Brogi, Mohamed Ben Belgacem, Yann Thorimbert, Sébastien Leclaire, Sha Li, et al. Palabos: parallel lattice boltzmann solver. *Computers & Mathematics with Applications*, 81:334–350, 2021.
- [44] YY Liu, Zhen Chen, Chang Shu, Siou Chye Chew, Boo Cheong Khoo, Xiang Zhao, and YD Cui. Application of a variational hybrid quantum-classical algorithm to heat conduction equation and analysis of time complexity. *Physics of Fluids*, 34(11), 2022.
- [45] YY Liu, Zhen Chen, Chang Shu, Patrick Rebstrost, YG Liu, SC Chew, BC Khoo, and YD Cui. A variational quantum algorithm-based numerical method for solving potential and stokes flows. *Ocean Engineering*, 292: 116494, 2024.
- [46] Seth Lloyd, Masoud Mohseni, and Patrick Rebstrost. Quantum principal component analysis. *Nature physics*, 10(9):631–633, 2014.
- [47] Marco D Mazzeo and Peter V Coveney. Hemelb: A high performance parallel lattice-boltzmann code for large scale fluid flow in complex geometries. *Computer Physics Communications*, 178(12):894–914, 2008.
- [48] Jarrod R McClean, Sergio Boixo, Vadim N Smelyanskiy, Ryan Babbush, and Hartmut Neven. Barren plateaus in quantum neural network training landscapes. *Nature communications*, 9(1):4812, 2018.
- [49] Youssef Moawad, Wim Vanderbauwhede, and René Steijl. Investigating hardware acceleration for simulation of cfd quantum circuits. *Frontiers in Mechanical Engineering*, 8:925637, 2022.
- [50] Michael A Nielsen and Isaac L Chuang. *Quantum computation and quantum information*. Cambridge university press, 2010.
- [51] Román Orús. Tensor networks for complex quantum systems. *Nature Reviews Physics*, 1(9):538–550, 2019.
- [52] Román Orús, Samuel Mugel, and Enrique Lizaso. Quantum computing for finance: Overview and prospects. *Reviews in Physics*, 4:100028, 2019.
- [53] Peter JJ O’Malley, Ryan Babbush, Ian D Kivlichan, Jonathan Romero, Jarrod R McClean, Rami Barends, Julian Kelly, Pedram Roushan, Andrew Tranter, Nan Ding, et al. Scalable quantum simulation of molecular energies. *Physical Review X*, 6(3):031007, 2016.
- [54] Annie E Paine, Vincent E Elfving, and Oleksandr Kyriienko. Quantum kernel methods for solving regression problems and differential equations. *Physical Review A*, 107(3):032428, 2023.
- [55] Hrushikesh Patil, Yulun Wang, and Predrag S Krstić. Variational quantum linear solver with a dynamic ansatz. *Physical Review A*, 105(1):012423, 2022.
- [56] Marco A Pravia, Zhiying Chen, Jeffrey Yezpez, and David G Cory. Experimental demonstration of quantum lattice gas computation. *Quantum Information Processing*, 2:97–116, 2003.
- [57] John Preskill. Quantum computing in the nisq era and beyond. *Quantum*, 2:79, 2018.
- [58] Pylbm contributors. Pylbm: an all-in-one package for numerical simulations using lattice boltzmann solvers., 2023. URL <https://github.com/pylbm/pylbm>.
- [59] Patrick Rebstrost, Masoud Mohseni, and Seth Lloyd. Quantum support vector machine for big data classification. *Physical review letters*, 113(13):130503, 2014.
- [60] Claudio Sanavio and Sauro Succi. Lattice boltzmann–carleman quantum algorithm and circuit for fluid flows at moderate reynolds number. *AVS Quantum Science*, 6(2), 2024.
- [61] Merel A Schalkers and Matthias Möller. Efficient and fail-safe quantum algorithm for the transport equation. *Journal of Computational Physics*, 502:112816, 2024.

- [62] Merel A Schalkers and Matthias Möller. On the importance of data encoding in quantum boltzmann methods. *Quantum Information Processing*, 23(1):20, 2024.
- [63] Merel A Schalkers and Matthias Möller. Momentum exchange method for quantum boltzmann methods. *arXiv preprint arXiv:2404.17618*, 2024.
- [64] Robert R Schaller. Moore’s law: past, present and future. *IEEE spectrum*, 34(6):52–59, 1997.
- [65] William J Schroeder, Lisa Sobierajski Avila, and William Hoffman. Visualizing with vtk: a tutorial. *IEEE Computer graphics and applications*, 20(5):20–27, 2000.
- [66] Maria Schuld and Nathan Killoran. Quantum machine learning in feature hilbert spaces. *Physical review letters*, 122(4):040504, 2019.
- [67] Maria Schuld, Ilya Sinayskiy, and Francesco Petruccione. The quest for a quantum neural network. *Quantum Information Processing*, 13:2567–2586, 2014.
- [68] Tejas Shinde, Ljubomir Budinski, Ossi Niemimäki, Valtteri Lahtinen, Helena Liebelt, and Rui Li. Utilizing classical programming principles in the intel quantum sdk: implementation of quantum lattice boltzmann method. *ACM Transactions on Quantum Computing*, 2024.
- [69] Peter W Shor. Polynomial-time algorithms for prime factorization and discrete logarithms on a quantum computer. *SIAM review*, 41(2):303–332, 1999.
- [70] Seyon Sivarajah, Silas Dilkes, Alexander Cowtan, Will Simmons, Alec Edgington, and Ross Duncan. tket: a retargetable compiler for nisq devices. *Quantum Science and Technology*, 6(1):014003, 2020.
- [71] Damian S Steiger, Thomas Häner, and Matthias Troyer. Projectq: an open source software framework for quantum computing. *Quantum*, 2:49, 2018.
- [72] Rene Steijl. Quantum algorithms for nonlinear equations in fluid mechanics. *Quantum computing and communications*, 2020.
- [73] Sauro Succi. *The lattice Boltzmann equation: for fluid dynamics and beyond*. Oxford university press, 2001.
- [74] Sauro Succi, Mauro Sbragaglia, and Stefano Ubertini. Lattice boltzmann method. *Scholarpedia*, 5(5):9507, 2010.
- [75] Yasunari Suzuki, Yoshiaki Kawase, Yuya Masumura, Yuria Hiraga, Masahiro Nakadai, Jiabao Chen, Ken M Nakanishi, Kosuke Mitarai, Ryosuke Imai, Shiro Tamiya, et al. Qulacs: a fast and versatile quantum circuit simulator for research purpose. *Quantum*, 5:559, 2021.
- [76] Blaga N Todorova and René Steijl. Quantum algorithm for the collisionless boltzmann equation. *Journal of Computational Physics*, 409:109347, 2020.
- [77] George F Viamontes, Igor L Markov, and John P Hayes. Graph-based simulation of quantum computation in the density matrix representation. *Quantum Inf. Comput.*, 5(2):113–130, 2005.
- [78] Huimin Wang, Guangwu Yan, and Bo Yan. Lattice boltzmann model based on the rebuilding-divergency method for the laplace equation and the poisson equation. *Journal of Scientific Computing*, 46(3):470–484, 2011.
- [79] David Wawrzyniak, Josef Winter, Steffen Schmidt, Thomas Indinger, Christian F Janßen, Uwe Schramm, and Nikolaus A Adams. A quantum algorithm for the lattice-boltzmann method advection-diffusion equation. *Computer Physics Communications*, page 109373, 2024.
- [80] Dave Wecker and Krysta M Svore. Liquil>: A software design architecture and domain-specific language for quantum computing. *arXiv preprint arXiv:1402.4467*, 2014.
- [81] Jeffrey Yepez. Quantum lattice-gas model for computational fluid dynamics. *Physical Review E*, 63(4):046702, 2001.
- [82] Jeffrey Yepez. Quantum lattice-gas model for the burgers equation. *Journal of Statistical Physics*, 107:203–224, 2002.
- [83] Jeffrey Yepez and Bruce Boghosian. An efficient and accurate quantum lattice-gas model for the many-body schrödinger wave equation. *Computer Physics Communications*, 146(3):280–294, 2002.
- [84] Jian Guo Zhou. *Lattice Boltzmann methods for shallow water flows*, volume 4. Springer, 2004.