

Sound Value Iteration for Simple Stochastic Games *

Muqsit Azeem ✉ 

Technical University of Munich, Germany

Jan Křetínský ✉ 

Technical University of Munich, Germany

Maximilian Weininger ✉ 

Institute of Science and Technology, Austria

Abstract

Algorithmic analysis of Markov decision processes (MDP) and stochastic games (SG) in practice relies on value-iteration (VI) algorithms. Since the basic version of VI does not provide guarantees on the precision of the result, variants of VI have been proposed that offer such guarantees. In particular, sound value iteration (SVI) not only provides precise lower and upper bounds on the result, but also converges faster in the presence of probabilistic cycles. Unfortunately, it is neither applicable to SG, nor to MDP with end components. In this paper, we extend SVI and cover both cases. The technical challenge consists mainly in proper treatment of end components, which require different handling than in the literature. Moreover, we provide several optimizations of SVI. Finally, we also evaluate our prototype implementation experimentally to confirm its advantages on systems with probabilistic cycles.

2012 ACM Subject Classification

Keywords and phrases Verification, Stochastic Games, Value Iteration

Digital Object Identifier 10.4230/LIPIcs.CVIT.2016.23

* This research was funded in part by the German Research Foundation (DFG) project 427755713 GPro.



© M. Azeem, J. Křetínský, M. Weininger;
licensed under Creative Commons License CC-BY 4.0

42nd Conference on Very Important Topics (CVIT 2016).

Editors: John Q. Open and Joan R. Access; Article No. 23; pp. 23:1–23:45

Leibniz International Proceedings in Informatics



LIPICs Schloss Dagstuhl – Leibniz-Zentrum für Informatik, Dagstuhl Publishing, Germany

1 Introduction

Value iteration (VI) [2] is the practically most used method for reliable analysis of probabilistic systems, in particular Markov decision processes (MDP) [22] and stochastic games (SG) [6]. It is used in the state-of-the-art model checkers such as Prism [18] and Storm [10] as the default method due to its better practical scalability, compared to strategy iteration or linear/quadratic programming [13, 20]. The price to pay are issues with precision. Firstly, while other methods yield precise results, VI converges to the exact result only in the limit. Secondly, the precision of the intermediate iterations was until recently an open question. Given the importance of reliable precision in verification, many recent works focused on modifying VI so that the imprecision can be bounded, yielding a stopping criterion. Consequently, (i) the computed result is reliable, and (ii) the procedure can even terminate earlier whenever the desired precision is achieved.

Focusing on the reachability probabilities here, the methods for computing lower and upper bounds on this value include analysing *end-components (ECs)* in graphs (*interval iteration* [12], *bounded real-time dynamic programming* [4]), finding augmenting-like paths (*widest path* [21]), guessing the upper bound from the lower one (*optimistic VI* [14]), or *sound VI (SVI)* [23].

The main idea of SVI is to estimate the value by a geometric series describing the probabilities to (i) reach the target in a given number of steps and (ii) to remain undetermined in that number of steps. For instance, in the system depicted in Fig. 1, SVI essentially computes that within n steps, the probability to reach the target is $\text{reach}_n = r + pr + p^2r + \dots + p^{n-1}r$. Moreover, since the probability to stay in undetermined states (neither target, nor sink) is $\text{stay}_n = p^n$, it deduces that the infinite-horizon reachability probability is in the interval $[\text{reach}_n, \text{reach}_n + \text{stay}_n]$. Not only does the method provide such valid lower and upper bounds, but it also terminates (bounds are close enough to each other) comparatively faster when such probabilistic cycles are present, rendering the usual VI very slow [23].

Unfortunately, SVI is only applicable to MDP without *end components (ECs)*. While this is a common simplifying restriction (stochastic shortest path in MDP [3], stopping games [24]), it is also very severe. In this paper, **we extend SVI (i) to SG and (ii) to systems (both MDP and SG) with end-components (ECs)**.

First, we extend SVI to SG without ECs. While the algorithm is similar with analogously dual steps for the other player, the correctness is surprisingly not immediate. Indeed, the underlying optimization objective in SVI is not simple reachability but a non-trivial combination of step-bounded reachability of targets and of undetermined states. This in turns makes these strategies require memory; the interaction of two memory-dependent strategies then convolutes constraints on the upper bound.

Second, we extend the approach to handle ECs. A major portion of the literature on guaranteed-precision VI, i.e. with lower and upper bounds, typically considers only the case without ECs [23]; for MDP, the ECs can be *collapsed* before the analysis, avoiding the issue, but *not so for SG*. The main approach to treat ECs is *deflating* [11], which adjusts the upper bound of each state to reflect the true probability of reaching the target *outside* of the EC. Since SVI does not work with the explicit upper bound, but rather with an implicit version given by other values (such as reach_n and stay_n), deflating cannot be performed directly.

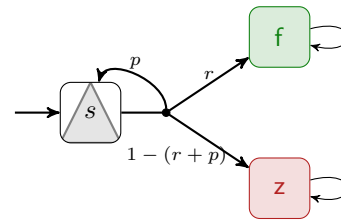

■ **Figure 1** A Markov chain with an initial state s , a target state f , and a sink/zero state z

Consequently, (i) instead of a single (S)VI update, we shall have four different cases to handle; (ii) the fundamental notion of the *simple end component* (EC states with the same value), instrumental for other VI extensions, is too coarse; instead, we have to consider their yet smaller parts; (iii) the convergence of the bounds does not follow directly from the literature. In particular, instead of the easy, standard convergence of the lower bound as seen in all other VI variants, we need properties of the upper bound to argue about the convergence of the lower bound. This constitutes the technically most involved part of the paper.

Our contribution can be summarized as follows:

- After providing an instructive description of SVI (in particular adding some aspects lacking in the original [23]), we extend SVI to (i) SG and then (ii) to handle ECs.
- Besides, we apply the classical topological optimization to our approach, and we further improve it based on the performed in-depth analysis. Our prototypical implementation and experimental analysis illustrate that our extension preserves the main advantage of SVI (see Sec. 4.4 for a concrete example)—fewer iterations are needed for systems with probabilistic cycles.

It should be emphasized that our main contribution is **not** showing that the implemented tool is more efficient than other ones in the literature, but rather the theoretically involved **proof and way how** SVI can be extended to handle end components. Specifically, our contribution lies in highlighting the inductive, attractor-like structure of MECs, which provides a theoretical foundation for addressing cycles, the primary challenge with VI. While this work does not aim to replace BVI, it offers critical insights into the inherent drawbacks of VI, paving the way for potential future enhancements to BVI with efficient cycle handling of SVI. This foundational step, though part of a longer-term effort, is pivotal for enabling subsequent advancements.

2 Preliminaries

We briefly recall stochastic games and introduce our notation. For an extensive introduction, we refer the interested reader to [25, Chap. 2].

► **Definition 1** (Stochastic Game (SG) [7]). *A (turn-based simple) stochastic game is $\mathcal{G} = \langle S, S_\Delta, S_\nabla, A, Av, \delta, F \rangle$ where $S = S_\Delta \uplus S_\nabla$ is a finite set of states partitioned into Maximizer (S_Δ) and Minimizer (S_∇) states, A is a finite set of actions, the function $Av : S \rightarrow 2^A \setminus \{\emptyset\}$ assigns available actions to each state, $\delta : S \times A \rightarrow \text{Dist}(S)$ is the transition function mapping state-action pairs to probability distributions over S , and $F \subseteq S$ is the target set.*

An SG with $S_\nabla = \emptyset$ or $S_\Delta = \emptyset$ is called a *Markov decision process (MDP)*. For $s \in S, a \in Av(s)$, the set of *successors* is $\text{Post}(s, a) := \{s' \mid \delta(s, a, s') > 0\}$. For a set of states $T \subseteq S$, we use $T_\Delta = T \cap S_\Delta$ to denote all Maximizer states in T , and similarly T_∇ for Minimizer.

The semantics is defined as usual by means of paths and strategies. An infinite path is a sequence $s_0 a_0 s_1 a_1 \dots \in (S \times A)^\omega$ that is consistent with the SG, i.e. for each $i \in \mathbb{N}_0$ we have $a_i \in Av(s_i)$ and $s_{i+1} \in \text{Post}(s_i, a_i)$. A history (also called finite path) is a finite prefix of such an infinite path, i.e. an element of $(S \times A)^* \times S$ that is consistent with the SG. For a history $\rho = s_0 a_0 s_1 a_1 \dots s_k$, let $\rho_i := s_i$ denote the i -th state in a path and $|\rho| = k$ denote the length of the history (only counting actions; intuitively: the number of steps taken).

A strategy is a (partial) function $\pi : (S \times A)^* \times S \rightarrow A$ mapping histories to actions. A Maximizer strategy is only defined for histories that end in a Maximizer state $s \in S_\Delta$, and dually for Minimizer. We denote by Σ_Δ and Σ_∇ the sets of all Maximizer and Minimizer strategies and use the convention that $\sigma \in \Sigma_\Delta$ and $\tau \in \Sigma_\nabla$. Complementing an SG \mathcal{G} with a

pair of strategies (essentially resolving all non-determinism) induces a Markov chain $\mathcal{G}^{\sigma,\tau}$ with the standard probability space $\mathcal{P}_{s,\mathcal{G}}^{\sigma,\tau}$ in state s , see [25, Sec. 2.2].

The *reachability objective* $\diamond F$ is the set of all infinite paths containing a state in F .¹ The *value* of a state s is the probability that from s the target is reached under an optimal play by both players: $V(s) = \sup_{\sigma \in \Sigma_\Delta} \inf_{\tau \in \Sigma_\nabla} \mathcal{P}_s^{\sigma,\tau}(\diamond F) = \inf_{\tau \in \Sigma_\nabla} \sup_{\sigma \in \Sigma_\Delta} \mathcal{P}_s^{\sigma,\tau}(\diamond F)$; the order of choosing the strategies does not matter [6]. The function $V : S \rightarrow \mathbb{R}$ maps every state to its value. Functions $f_1, f_2 : S \rightarrow \mathbb{R}$ are compared point-wise, i.e. $f_1 \leq f_2$ if for all $s \in S$, $f_1(s) \leq f_2(s)$. In this paper, we denote $f(s, a) = \sum_{s' \in S} \delta(s, a, s') \cdot f(s')$ for any $f : S \rightarrow \mathbb{R}$, using notation overloading.

2.1 Value iteration and bounded value iteration

Before we define the algorithm of value iteration, we recall a useful partitioning of the state space [23]. We know F is the set of target states; w.l.o.g., every target state is absorbing. Similarly, we can identify by simple graph search the set Z of *sink states* from which there is no path to F . The values of states in these sets are trivially 1 or 0, respectively. Our algorithm focuses on computing the values of the remaining states in $S^? = S \setminus (F \cup Z)$.

Classical value iteration (VI, see [5]) computes the following sequence $L_i : S \rightarrow \mathbb{R}$ under-approximating the values.

$$L_0(s) = \begin{cases} 1 & \text{if } s \in F \\ 0 & \text{otherwise} \end{cases} \quad (1)$$

$$L_{i+1}(s) = \begin{cases} \max_{a \in \text{Av}(s)} \sum_{s' \in S} \delta(s, a, s') \cdot L_i(s') & \text{if } s \in S_\Delta \\ \min_{a \in \text{Av}(s)} \sum_{s' \in S} \delta(s, a, s') \cdot L_i(s') & \text{if } s \in S_\nabla \end{cases} \quad (2)$$

These under-approximations converge (in the limit) to the value V , which also is the *least* fixpoint of Eq. (2). While this approach is often fast in practice, it has the drawback that the imprecision $V - L_i$ is unknown. To address this, one can employ *bounded value iteration* (BVI, also known as interval iteration [4, 12, 11]). It additionally computes an over-approximating sequence U_i which allows to estimate the imprecision as $U_i(s) - L_i(s)$. Naively, the sequence is initialized as $U_0(s) = 0$ for all $s \in Z$ and $U_0(s) = 1$ for all other states, and then updated using Eq. (2) again. However, then U_i converges to the *greatest* fixpoint of Eq. (2) which can differ from the least fixpoint V ; this happens if and only if *end components* are present.

► **Definition 2** (End component (EC) [9]). *A set of states T with $\emptyset \neq T \subseteq S$ is an end component if there exists a set of actions $\emptyset \neq B \subseteq \bigcup_{s \in T} \text{Av}(s)$ such that:*

1. *for each $s \in T$, $a \in B \cap \text{Av}(s)$ we have $\text{Post}(s, a) \subseteq T$,*
2. *for each $s, s' \in T$ there exists a path from s to s' using only actions in B .*

An end component T is a maximal end component (MEC) if there is no other EC T' such that $T \subset T'$. Furthermore, a MEC T is bottom if for all $s \in T, a \in A, s' \in S \setminus T$ we have $\delta(s, a, s') = 0$.

As an example, consider the MDP in Fig. 2. Here, any U with $U(s_0) = U(s_1)$ and $U(z) = 0$ is a fixpoint of Eq. (2). More generally, on an EC in a maximizing MDP, one can create

¹ Formally, let Paths be the set of all infinite paths. Then $\diamond F = \{\rho \in \text{Paths} \mid \exists i \in \mathbb{N}. \rho_i \in F\}$. Later, we also use the step-bounded variant $\diamond^{\leq k} F = \{\rho \in \text{Paths} \mid \exists i \in \mathbb{N}. \rho_i \in F \wedge i \leq k\}$ and the dual step-bounded staying objective $\square^{\leq k} S^? = \text{Paths} \setminus \left(\diamond^{\leq k} (S \setminus S^?) \right)$.

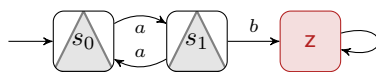

■ **Figure 2** An SG with an EC $\{s_0, s_1\}$ and a sink z

a fixpoint by assigning any number larger than the actual value to all states of the EC (and dually, a smaller number in a minimizing MDP). In MDP, there is a rather simple solution: the entire EC can be collapsed into a single state, keeping all the actions, but then removing all self-loops. This ensures a single fixpoint and, since all states in an EC have the same value as the collapsed state, it allows to obtain the values for the original MDP [4, 12]. For SG, this solution is not applicable because states in an EC can have different values, see [11, Sec. 3]. The solution of [11] is to repeatedly identify subsets of ECs that possibly, given the current estimates, have the property that all states have the same value; then, the over-approximation in these subsets is conservatively lowered (“deflated”) to the over-approximation of the best action *exiting* the subset. Relevant for our work is the fact that we need to decrease the over-approximation inside ECs to the estimate of the *best exit*. Thus, we repeat here a (slightly adjusted) definition of best exit.

► **Definition 3** (Best exit [11]). *Given a set of states $T \subseteq S$ and a function $f : S \rightarrow \mathbb{Q}$, the best exit according to f from T is defined as:*

$$\text{bexit}_f^\Delta(T) = \arg \max_{\substack{(s,a) \in T_\Delta \times \text{Av}(s) \\ \text{Post}(s,a) \not\subseteq T}} \sum_{s' \in S} \delta(s, a, s') \cdot f(s')$$

2.2 Sound value iteration in Markov chains

Sound value iteration (SVI, [23]) was introduced as an alternative to BVI that is faster while still providing guarantees on its precision. It computes for increasing k the probability of reaching the target set F within k steps, denoted $\mathcal{P}(\diamond^{\leq k} F)$, and the probability to stay within the unknown set $S^?$ during the first k steps, denoted $\mathcal{P}(\square^{\leq k} S^?)$ — see Footnote 1 for the formal definitions of the operators $\diamond^{\leq k}$ and $\square^{\leq k}$. From these two sequences, it computes under- and over-approximations of the value utilizing three core ideas.

- The value can be split into the probability to reach the target set *within k steps* plus the probability to reach the target set *in strictly more than k steps* [23, Lem. 1]. The former $\mathcal{P}(\diamond^{\leq k} F)$ is directly computed by the algorithm; the latter is approximated using the next two ideas.
- Reaching the target set in strictly more than k steps can be decomposed as follows: first a path has to stay in $S^?$ for k steps and afterwards reach the target. As we do not know which state in $S^?$ is reached after the k steps, we estimate its value using a lower bound l_k or an upper bound u_k on the value over *all states in $S^?$* . Formally, given such a bound l_k , the probability to reach in strictly more than k steps can be under-approximated as $\mathcal{P}(\square^{\leq k} S^?) \cdot l_k$; dually, it can be over-approximated as $\mathcal{P}(\square^{\leq k} S^?) \cdot u_k$ [23, Prop. 1].
- Such bounds l_k and u_k can be obtained from the k -step bounded probabilities $\mathcal{P}(\diamond^{\leq k} F)$ and $\mathcal{P}(\square^{\leq k} S^?)$ [23, Prop. 2]. Intuitively, the highest possible value would be obtained if the state $\hat{s} \in S^?$ with the highest value always reached itself after k steps — getting another try to obtain the highest possible value. The resulting value can be computed as $\sum_{i=0}^{\infty} \mathcal{P}_{\hat{s}}(\square^{\leq k} S^?)^i \cdot \mathcal{P}_{\hat{s}}(\diamond^{\leq k} F)$. Writing this geometric series in closed form (assuming

$\mathcal{P}_s(\square^{\leq k} \mathcal{S}^?) < 1$), we obtain

$$\sum_{i=0}^{\infty} \mathcal{P}_s(\square^{\leq k} \mathcal{S}^?)^i \cdot \mathcal{P}_s(\diamond^{\leq k} \mathbf{F}) = \frac{\mathcal{P}_s(\diamond^{\leq k} \mathbf{F})}{1 - \mathcal{P}_s(\square^{\leq k} \mathcal{S}^?)^i} \leq \max_{s \in \mathcal{S}^?} \frac{\mathcal{P}_s(\diamond^{\leq k} \mathbf{F})}{1 - \mathcal{P}_s(\square^{\leq k} \mathcal{S}^?)^i} =: \mathbf{u}_k$$

Dually, we can compute a lower bound \mathbf{l}_k by picking the state in $\mathcal{S}^?$ that minimizes the closed form of the geometric series. The following example illustrates the power of this way of choosing the lower and upper bound. Consider again the Markov chain of Fig. 1 and set $p = 0.98$ and $r = 0.01$. Then, while BVI requires 682 iterations to achieve a precision of 10^{-6} , SVI takes precisely 1 iteration. SVI's behaviour is in fact independent of p and r , whereas increasing p also increases the number of iterations that BVI requires.

We restate [23, Thm. 1], which summarizes the above insights and proves the correctness of the approach.

► **Theorem 4.** *Let \mathcal{M} be a Markov chain with probability measure \mathcal{P} whose state space is partitioned into \mathbf{F} , $\mathcal{S}^?$ and \mathbf{Z} as described above. Let $k \geq 0$ such that $\mathcal{P}(\square^{\leq k} \mathcal{S}^?) < 1$ for all $s \in \mathcal{S}^?$. Then, for every state $s \in \mathcal{S}^?$, its value $\mathbf{V}(s) = \mathcal{P}_s(\diamond \mathbf{F})$ satisfies the following:*

$$\mathcal{P}_s(\diamond^{\leq k} \mathbf{F}) + \mathcal{P}_s(\square^{\leq k} \mathcal{S}^?) \cdot \mathbf{l}_k \leq \mathbf{V}(s) \leq \mathcal{P}_s(\diamond^{\leq k} \mathbf{F}) + \mathcal{P}_s(\square^{\leq k} \mathcal{S}^?) \cdot \mathbf{u}_k$$

$$\text{where } \mathbf{l}_k = \min_{s' \in \mathcal{S}^?} \frac{\mathcal{P}_{s'}(\diamond^{\leq k} \mathbf{F})}{1 - \mathcal{P}_{s'}(\square^{\leq k} \mathcal{S}^?)^i} \text{ and dually } \mathbf{u}_k = \max_{s' \in \mathcal{S}^?} \frac{\mathcal{P}_{s'}(\diamond^{\leq k} \mathbf{F})}{1 - \mathcal{P}_{s'}(\square^{\leq k} \mathcal{S}^?)^i}.$$

The termination of the algorithm relies on the assumption that the system is contracting towards $\mathbf{F} \cup \mathbf{Z}$; intuitively, this means that there are no sure cycles in $\mathcal{S}^?$ and thus a path has to leave $\mathcal{S}^?$ almost surely. However, in MDP and SG there can be sure cycles, namely the ECs, which also hinder the convergence of BVI. In Sec. 4, we provide a way to deal with the presence of ECs when using SVI; note that neither the previous solution of collapsing [4, 12] nor of deflating [11] suffice.

However, before we resolve the problems caused by ECs, we first turn to a different complication in Sec. 3. Our reasoning so far was limited to Markov chains with no non-determinism. It is non-trivial to extend it to MDP (and even more so to SG here) because there the computations additionally depend on the choice of strategy (strategies). In particular, to ensure correctness, the probability to reach within k steps depends on the chosen strategies and need not be the optimal k -step value; moreover, the bounds cannot be computed using only the closed form of the geometric series.

3 Sound value iteration for stochastic games without end components

In this section, we provide the extension of SVI from MDP to SG without ECs. We extend it for the second player, building upon previous work [23] by performing necessary dual operations. This section serves as an introduction to the basic algorithm, revisiting SVI concepts with additional examples, improved notation, and the part of the correctness proof that was missing in [23]. Additionally, this section prepares the reader for the more technical discussion on algorithms involving ECs in Sec. 4.

In order to lift Thm. 4 from Markov chains to SG, we have to answer the following two questions: 1. How do we pick the strategies σ_k and τ_k that Maximizer and Minimizer use in the k -th iteration? (Sec. 3.1) 2. How do we pick the lower bound \mathbf{l}_k and the upper bound \mathbf{u}_k on the value of all states in $\mathcal{S}^?$? (Sec. 3.2) Finally, Sec. 3.3 combines the insights into the full algorithm.

3.1 Computing the strategies

Following the idea of [23, Sec. 4.1], we observe that for an optimal Maximizer strategy σ^{\max} and for all Minimizer strategies τ^{arb} and a bound $\mathbf{u}_k \geq \max_{s \in S^?} \mathcal{P}_s^{\sigma^{\max}, \tau^{\text{arb}}}(\diamond F)$, we get the following chain of inequations:

$$\begin{aligned} V &= \sup_{\sigma \in \Sigma_{\Delta}} \inf_{\tau \in \Sigma_{\nabla}} \mathcal{P}^{\sigma, \tau}(\diamond F) = \inf_{\tau \in \Sigma_{\nabla}} \mathcal{P}^{\sigma^{\max}, \tau}(\diamond F) \leq \mathcal{P}^{\sigma^{\max}, \tau^{\text{arb}}}(\diamond F) \\ &\leq \mathcal{P}^{\sigma^{\max}, \tau^{\text{arb}}}(\diamond \leq^k F) + \mathcal{P}^{\sigma^{\max}, \tau^{\text{arb}}}(\square \leq^k S^?) \cdot \mathbf{u}_k \\ &\leq \sup_{\sigma} \left(\mathcal{P}^{\sigma, \tau^{\text{arb}}}(\diamond \leq^k F) + \mathcal{P}^{\sigma, \tau^{\text{arb}}}(\square \leq^k S^?) \cdot \mathbf{u}_k \right) \quad (3) \end{aligned}$$

We can use the dual argument for a lower bound l_k , an arbitrary Maximizer strategy σ^{arb} and an optimal Minimizer strategy to obtain:

$$V \geq \inf_{\tau} \left(\mathcal{P}^{\sigma^{\text{arb}}, \tau}(\diamond \leq^k F) + \mathcal{P}^{\sigma^{\text{arb}}, \tau}(\square \leq^k S^?) \cdot l_k \right) \quad (4)$$

Based on these inequalities, we can inductively construct strategies σ_k, τ_k . In order to highlight the symmetry of the players, our formal definition uses a strategy π of either Maximizer or Minimizer. There are two differences between the players: the operator **opt** is max if $\pi \in \Sigma_{\Delta}$ and dually min if $\pi \in \Sigma_{\nabla}$ (with $\overline{\text{opt}} = \min$ if **opt** = max and vice versa) and the bound \mathbf{b}_k is either \mathbf{u}_k or l_k , respectively.

Importantly, the strategies should not optimize (k -step) reachability, but the k -step objective $\mathcal{P}^{\sigma_k, \tau_k}(\diamond \leq^k F) + \mathcal{P}^{\sigma_k, \tau_k}(\square \leq^k S^?) \cdot \mathbf{b}_k$, as suggested by Eqs. (3) and (4).

We construct the strategies recursively, building on the correctness of the strategies with shorter horizon. To achieve this, the $(k+1)$ st strategy makes one optimal choice in the first step and then mimics the k th strategy, i.e. for a path $sa\rho$ starting with state s and chosen action a , afterwards we have $\pi_{k+1}((sa)\rho) = \pi_k(\rho)$. As base case, when $k=0$ we choose an arbitrary action, because all actions are 0-step optimal. Formally,

“ k -STEP” STRATEGIES:

$$\begin{aligned} \pi_0(\rho) &\in \text{Av}(\rho_0) \\ \pi_{k+1}(\rho) &\leftarrow \begin{cases} \in \arg \text{opt}_{a \in \text{Av}(s)} \sum_{s' \in S} \delta(s, a, s') \cdot \left(\mathcal{P}_{s'}^{\sigma_k, \tau_k}(\diamond \leq^k F) + \mathcal{P}_{s'}^{\sigma_k, \tau_k}(\square \leq^k S^?) \cdot \mathbf{b}_k \right) & \text{if } \rho = s \in S \\ \pi_k(\rho') & \text{if } \rho = sa\rho' \end{cases} \end{aligned} \quad (5)$$

For histories longer than $k+1$, the definition is irrelevant and can be arbitrary as we shall only consider $(k+1)$ -step optimality. These strategies yield correct over-/under-approximations in the sense of Thm. 5 below, lifting Thm. 4. Formally, this is stated as Lem. 18 in App. A.3, with constant bounds l, u , as opposed to the generally variable bounds of Thm. 5.

To make the notation more readable, from now on we omit the specific strategies σ_k, τ_k and the objectives when possible. Assuming the players use strategies σ_k and τ_k as defined by Eq. (5), we use $\text{reach}_s^k := \mathcal{P}_s^{\sigma_k, \tau_k}(\diamond \leq^k F)$ for the probability to reach the targets in k steps from s and $\text{stay}_s^k := \mathcal{P}_s^{\sigma_k, \tau_k}(\square \leq^k S^?)$ for the probability to stay in $S^?$ for k steps from s .

3.2 Computing bounds

Now that we have answered the first question—how to compute the strategies—we turn to the second question: obtaining good bounds l_k, u_k . While trivial bounds $l=0$ and

$u = 1$ are sufficient for a correct and convergent algorithm, using good bounds is the key to the good practical performance of SVI, as illustrated in Fig. 1. They enable a practically tight extrapolation from the step-bounded information accumulated so far. To this end, $l_k = \min_{s \in \mathcal{S}^?} \frac{\text{reach}_s^k}{1 - \text{stay}_s^k}$ seems a natural choice, dually for u . However, as observed in [23], the non-determinism in MDP makes this incorrect. Instead, the updates have to proceed more carefully, not overshooting the interval of values for which the currently considered action is relevant. This safety cap is called the *decision value*. We refer the reader to App. A.1 for an extensive derivation and explanation, in particular Ex. 14 for the intuition. Apart from dualization and adjusted notation, the definition is as in [23]. Let $\Delta_{\text{stay}}(\alpha, \beta) := \sum_{s' \in \mathcal{S}} (\delta(s, \alpha, s') - \delta(s, \beta, s')) \cdot \text{stay}_{s'}^k$ be the difference in the staying probabilities of actions α and β .

$$\text{decval}_b^k(s, \alpha) := \text{opt}_{\beta \in \text{Av}(s) \cdot \Delta_{\text{stay}}(\alpha, \beta) > 0} \frac{\sum_{s' \in \mathcal{S}} (\delta(s, \beta, s') - \delta(s, \alpha, s')) \cdot \text{reach}_{s'}^k}{\sum_{s' \in \mathcal{S}} (\delta(s, \alpha, s') - \delta(s, \beta, s')) \cdot \text{stay}_{s'}^k}$$

$$\text{decval}_b^k := \text{opt}(\text{decval}_b^{k-1}, \text{opt}_{s \in \mathcal{S}^?} \text{decval}_b^k(s, \alpha))$$

where the second line sets the global decision value as the optimum over all states, reflecting also previous decision values. Finally, we can pick the best possible bound using the geometric series, but capping it at the decision value. The outer $\overline{\text{opt}}$ ensures monotonicity of the bounds:

(DYNAMIC) BOUNDS:

$$b_k := \overline{\text{opt}} \left(b_{k-1}, \text{opt} \left(\text{opt}_{s \in \mathcal{S}^?} \frac{\text{reach}_s^k}{1 - \text{stay}_s^k}, \text{decval}_b^k \right) \right) \quad (6)$$

Next, we use the following condition denoted ‘UPDATEGLOBALBOUNDS?’ to update the global bounds. This intuitively means the we can only update the global bounds when all the states in $\mathcal{S}^?$ have stay strictly less than 1, otherwise $\frac{\text{reach}_s^k}{1 - \text{stay}_s^k}$ would be undefined.

$$\text{UPDATEGLOBALBOUNDS?} := \forall s \in \mathcal{S}^? . \text{stay}_s^k < 1 \quad (7)$$

Now we can state the correctness of the bounds and of the estimates computed based on the “ k -step” strategies and these dynamically changing bounds:

► Theorem 5. *Fix an SG \mathcal{G} with its state space partitioned in F , Z and $\mathcal{S}^?$. Let $l_k, u_k \in \mathbb{R}$ be bounds as defined by Eq. (6). For $\sigma_k \in \Sigma_\Delta, \tau_k \in \Sigma_\nabla$ defined by Eq. (5), the following inequality holds:*

$$\mathcal{P}_s^{\sigma_k, \tau_k}(\diamond^{\leq k} F) + \mathcal{P}_s^{\sigma_k, \tau_k}(\square^{\leq k} \mathcal{S}^?) \cdot l_k \leq V(s) \leq \mathcal{P}_s^{\sigma_k, \tau_k}(\diamond^{\leq k} F) + \mathcal{P}_s^{\sigma_k, \tau_k}(\square^{\leq k} \mathcal{S}^?) \cdot u_k$$

Proof sketch. First, we fix an arbitrary $k \in \mathbb{N}$ and argue using the technical Lem. 15 that we have $V(s) \leq u_k$. Second, we instantiate the arbitrary Minimizer strategy with τ_k and from Ineq. (3) obtain the following:

$$V(s) \leq \sup_{\sigma \in \Sigma_\Delta} (\mathcal{P}_s^{\sigma, \tau_k}(\diamond^{\leq k} F) + \mathcal{P}_s^{\sigma, \tau_k}(\square^{\leq k} \mathcal{S}^?) \cdot u_k) \quad (8)$$

Finally, we use induction and an argument using the decision value to prove that σ_k is among the optimal strategies for the modified objective. ◀

► Remark 6. The final statement (σ_k being an optimal strategy) was not proven in the original paper [23]. It only stated its necessity and described how to construct σ_k . We provide the (2-pages long) proof in App. A.1, including the induction that proves the optimality of σ_k and utilizes the decision value.

3.3 Algorithm

We summarize the SVI algorithm for SG without ECs in Alg. 1.

■ **Algorithm 1** Sound value iteration for stochastic games without end components

Input: SG \mathcal{G} (partitioned into $S^?$, F , Z) and precision $\varepsilon > 0$
Output: $V' : S \rightarrow \mathbb{R}$ such that $|V'(s) - V(s)| \leq \varepsilon$ for all $s \in S$

- 1: For $s \in F$ and all $k \in \mathbb{N}_0$, $\text{reach}_s^k \leftarrow 1$ and $\text{stay}_s^k \leftarrow 0$
- 2: For $s \in Z$ and all $k \in \mathbb{N}_0$, $\text{reach}_s^k \leftarrow 0$ and $\text{stay}_s^k \leftarrow 0$
- 3: For $s \in S^?$, $\text{reach}_s^0 \leftarrow 0$ and $\text{stay}_s^0 \leftarrow 1$
- 4: $l_0 \leftarrow 0$ and $u_0 \leftarrow 1$
- 5: $k \leftarrow 0$
- 6: **repeat**
- 7: Use “ k -STEP” STRATEGIES to choose σ_{k+1} and τ_{k+1} – see Eq. (5)
- 8: **for** all $s \in S^?$ **do**
- 9: **if** UPDATEGLOBALBOUNDS? – see condition (7) **then**
- 10: Compute reach_s^{k+1} and stay_s^{k+1} by BELLMAN-UPDATE – see Eq. (9)
- 11: Compute l_{k+1} and u_{k+1} by (DYNAMIC) BOUNDS – see Eq. (6)
- 12: $k \leftarrow k + 1$
- 13: **until** $\text{stay}_s^k \cdot (u_k - l_k) < 2 \cdot \varepsilon$ for all $s \in S^?$
- 14: **return** $\text{reach}_s^k + \text{stay}_s^k \cdot \frac{l_k + u_k}{2}$ for all $s \in S^?$

We start by initializing the 0-step bounded probabilities and upper and lower bounds using the trivial under- and over-approximations of 0 and 1 (Lines 1-4). Note that for targets and sinks, this trivial initialization is done for all step bounds. Afterwards, we enter the main loop of the algorithm which repeats the following steps: firstly, as discussed in Sec. 3.1, in Line 7 we choose the strategies optimizing the k -step objective $\mathcal{P}^{\sigma_k, \tau_k}(\diamond^{\leq k} F) + \mathcal{P}^{\sigma_k, \tau_k}(\square^{\leq k} S^?) \cdot \mathbf{b}_k$. Note that this only relies on k -step values which have been computed in the previous iteration. Secondly, in Line 10 we compute the $(k + 1)$ -step bounded probabilities for all the states according to our strategies, again building on the k -step values:

BELLMAN-UPDATE:

$$\text{reach}_s^{k+1} \leftarrow \sum_{s' \in S} \delta(s, \pi_{k+1}(s), s') \cdot \text{reach}_{s'}^k; \quad \text{stay}_s^{k+1} \leftarrow \sum_{s' \in S} \delta(s, \pi_{k+1}(s), s') \cdot \text{stay}_{s'}^k \quad (9)$$

Finally, in Line 11, if the condition UPDATEGLOBALBOUNDS? evaluates to true, we update the global bounds as specified in Eq. (6). The steps are repeated for increasing k until the approximations of lower and upper bounds are close enough (Line 13). Intuitively, this amounts to checking whether stay is close to 0 or the global lower and upper bound are close to each other. One can also use relative difference by replacing stay_s^k by $\frac{\text{stay}_s^k}{\text{reach}_s^k + \text{stay}_s^k \cdot u}$ which could be useful in various applications. In App. A.3 we prove the following:

► **Theorem 7.** Fix an SG \mathcal{G} that contains no ECs, with its state space partitioned in F , Z and $S^?$, and fix a precision $\varepsilon > 0$. Alg. 1 is correct and terminates with an ε -close approximation to the value V' , i.e. for all $s \in S^?$, $|V'(s) - V(s)| \leq \varepsilon$.

4 Extending sound value iteration to systems with end components

In this section, we first present an example demonstrating that Alg. 1 does not converge in the presence of ECs. Second, we demonstrate that while the natural extensions of the

deflate solution from the literature [11] address the issue for BVI, they are no solution to SVI. Third, we introduce new notions of *best-exit set (BES)* and *delay* action, based on which we design and prove a valid solution. Finally, we provide an example to showcase that the main advantage of SVI are preserved even in SG.

4.1 Approximations do not converge in presence of ECs

The termination proof of Thm. 7 crucially relies on the absence of ECs. Consider, for instance, the example of Fig. 3 with $S^? = \{s\}$. We apply Alg. 1 to this example. For $k = 0$, the initialization $l = 0$ and $u = 1$ correctly define the lower and upper bounds on optimal probability. Additionally, $\mathcal{P}_s^{\sigma, \tau}(\diamond \leq^k F) = 0$ and $\mathcal{P}_s^{\sigma, \tau}(\square \leq^k S^?) = 1$. For $k = 1$, the algorithm picks $\sigma(s) := a$, resulting in no change to the approximations. This is true for all the subsequent iterations ($k = 2, 3, \dots$) as well. In particular, the over-approximation is always 1 and does not converge to the true $1/2$. The key element of any solution to the EC issue is to identify where to best *exit* the EC, which provides realistic information on the value compared to non-informative cyclic dependencies within the EC.

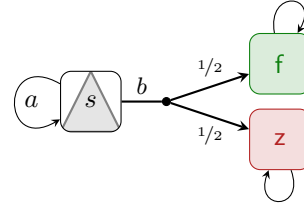

■ **Figure 3** A game with trivial Maximizer EC

4.2 A sequence of difficulties: Why the natural solutions do not work

ECs were previously handled for *BVI*, using so-called *deflating* [11]. This approach finds *simple end components (SEC)*, which are ECs with all states having the same value. In each SEC, deflating reduces the individual over-approximations for each state in the SEC to the value of Maximizer’s *best exit* from the SEC (see Def. 3), since none of these states can possibly get any higher value. In contrast, the difficulty with *SVI* is that it does not maintain explicit over-approximations for each state which could be reduced; instead, it computes over-approximations from the k -step values *reach*, *stay* and u . Consequently, combining SVI with deflating is surprisingly involved.

In the following we list the issues and have moved the detailed descriptions of the respective examples in App. B.1 in the interest of space.

- (1) Although SVI maintains an over-approximation u , it is a global bound for all states and thus cannot be used to locally deflate the value of some states.
- (2) SVI maintains *reach* and *stay*, from which the local over-approximation for each state is derived. However, since the over-approximation depends on both variables, the same over-approximation can correspond to different pairs of these values. Consequently, when deflating a state, it is unclear whether to deflate *reach* or *stay*; moreover, there may not even exist any choice that works correctly for the whole EC (or SEC).
- (3) Deflating only the best exit states of a SEC may result in non-convergence of the other states within the SEC.
- (4) Even more complex is the difficulty with *reach* and *stay* being defined for a number k of steps. While collapsing ECs results in not counting steps within ECs at all, the more complex handling of the inside of the EC results in a specific form of counting the steps. As a result, we shall introduce a “delay” action (see Sec. 4.2.1), which does not move us from the current state, yet it counts as making a step.

To summarize, we cannot deflate the entire SEC to the best exit of SEC because we might wrongly increase the *reach* of a Minimizer state that may lead to incorrect results;

and, we cannot only deflate the best exiting state bexit_f^Δ as it may lead to non-termination. Note that the difficulties (1) and (3) highlighted in this subsection already arise in MDP. Our solution will have to decompose the ECs in even a finer way, into a bijection of the parts to the set of “best exits”.

4.2.1 Why do we need the *delay* action?

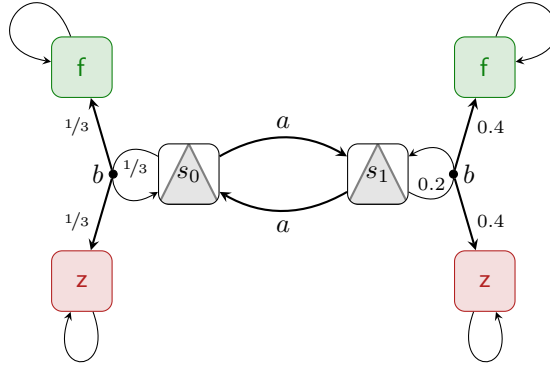

■ **Figure 4** Game graph with two maximizer nodes and self-loops

► **Example 8.** Consider the SG in Fig. 4. It has two non-trivial states s_0 and s_1 , both controlled by the Maximizer. These states form a MEC, denoted as T and have a value of $1/2$. If Maximizer plays one of the exits forever, the optimal value of $1/2$ can be achieved. As this SG is not EC-free, let us explore the concept of best-exit set to tackle the issue of non-convergence. Upon applying Alg. 1 to this SG, the initial approximations are as follows.

$\text{reach}_0(s_0) = 0, \text{stay}_0(s_0) = 1, \text{reach}_0(s_1) = 0, \text{stay}_0(s_1) = 1$ and $l_0 = 0, u_0 = 1$. In the first iteration, $\text{bexit}^\Delta(T) = \{(s_0, b)\}$ since $\text{reach} + \text{stay} \cdot u$ evaluates to $1/3 + 1/3 \cdot 1 = 2/3$ there, which is less than $0.4 + 0.2 \cdot 1 = 0.6$ of (s_0, b) . Therefore, forcing Maximizer to play the best exit updates the vectors as follows:

$\text{reach}_1(s_0) = 1/3, \text{stay}_1(s_0) = 1/3, \text{reach}_1(s_1) = 0, \text{stay}_1(s_1) = 1$ and $l_1 = 0, u_1 = 1$. In the second iteration, however, the best exit is changed to $\text{bexit}^\Delta(T) = \{(s_1, b)\}$. Indeed, taking (s_0, b) would decrease $\text{stay}_2(s_0)$ to $1/3 \cdot 1/3 = 1/9$ while keeping $\text{reach}_2(s_0)$ the same; consequently, the one-step $0.4 + 0.2 \cdot 1 = 0.6$ of (s_1, b) becomes seemingly more advantageous than the two-step $1/3 + 1/9 \cdot 1$ of (s_0, b) . The progress of considering more steps is thus ignored and we start “from scratch”. Now, forcing Maximizer to take the new best exit, updates the vectors as follows:

$\text{reach}_2(s_0) = 0, \text{stay}_2(s_0) = 1, \text{reach}_2(s_1) = 0.4, \text{stay}_2(s_1) = 0.2$ and $l_2 = 0, u_2 = 1$. In third iteration the values are the same as in the first iteration. And, then this vicious cycle repeats. The values of l, u do not improve, i.e. $l_i = 0, u_i = 1$ for all the subsequent iterations and Alg. 1 does not terminate.

The non-termination arises because the algorithm does not ensure monotonicity and becomes mired in cyclic dependencies with the “missing” probability oscillating between states (as observed between states s_0 and s_1 in this example). To address this, enforcing monotonicity proves effective as it guarantees that at least one state progresses according to the best-exit set, called \mathfrak{B} in Sec. 4.3.1. To facilitate monotonicity, we introduce ‘delay’ actions in Sec. 4.3.2.

4.3 Our solution

We propose a new approach that updates the vectors based on best exits of ECs using MEC decomposition and the idea of recursive deflate with a condition to enforce monotonicity of upper bounds. This method is also within the spirit of SVI, i.e. does not require to maintain local \mathbf{u} for every state. Our solution can be seen as Alg. 1, where the computation of the strategies and bounds are adjusted by the re-defined procedures described in the following subsections.

4.3.1 Best exit set (BES)

As discussed in the previous section, it is crucial to determine the best exit from ECs. However, in different parts of the EC, there may be different answers to that question. Our approach is to identify a comprehensive set of the different best exits, each corresponding to some EC. Note that ECs that cannot be exited at all will not correspond to any best exit.

■ **Algorithm 2** Compute best exit set for the sound value iteration

Input: an SG \mathcal{G} , over-approximation $f \geq \mathbf{V}$, an EC \mathbf{Y}
Output: Set of correct exiting state-action pairs of ECs in \mathbf{Y} wrt f

```

1: procedure BESTEXITSET( $\mathcal{G}, f, \mathbf{Y}$ )
2:   BES  $\leftarrow$   $\emptyset$  ▷ Initialization
3:   if  $\text{bexit}_f^\Delta(\mathbf{Y})$  is empty then ▷ Base case
4:     Include all the states of  $\mathbf{Y}$  into  $\mathbf{Z}$  and exclude them from  $\mathbf{S}^?$ 
5:     return BES
6:   else ▷ Recursive step:  $\text{bexit}_f^\Delta(\mathbf{Y})$  is non-empty
7:     Include all the best-exits of  $\mathbf{Y}$  to BES
8:     Find MECs in the induced graph after removing all the states of the best-exits
9:     Recursively compute the best-exit set for all MECs obtained in the previous step
       and include them in BES
10:  return BES ▷ Set of correct exits wrt  $f$  for all EC within  $\mathbf{Y}$ 

```

Alg. 2 shows the procedure BESTEXITSET that computes the *best exit set (BES)* in a given EC \mathbf{Y} relative to a function $f \geq \mathbf{V}$, which gives us the current estimates of values of the (exiting) actions. (We provide an equivalent, fully formal description of the algorithm in App. B.2.) If there is no Maximizer exit (Lines 3-5), this implies that if the play is in any of the states in this EC, then the Minimizer can force the play to remain there forever; we call such ECs a *trap ECs*. We denote the set of all such ECs as **trap**. Therefore, all the states can be included in the sink states set \mathbf{Z} and removed from the unknown states set $\mathbf{S}^?$ (Line 4). Otherwise, all the best exit pairs are added to a set BES (Line 7).

After removing all the states of BES, the procedure is recursively called on all the MECs of induced graph (Lines 8, 9). Finally, Line 10 returns exits for all the relevant subECs of \mathbf{Y} .

We can prove that all the “exitable” ECs have a corresponding exit state and the action played there is the best one given the information from the current approximation:

► **Lemma 9.** *Algorithm 2 BESTEXITSET on all MECs with respect to $f \geq \mathbf{V}$ terminates and returns a set BES that has the following two properties.*

1. for all $(s, a) \in \text{BES}$: $f(s, a) \geq \mathbf{V}(s)$
2. for all EC T :
 - $T \notin \text{trap} \Rightarrow \exists (s, a) \in \text{BES}: (s, a) \text{ exits } T$

- $(T \in \text{trap} \wedge s \in T) \Rightarrow s \in Z \wedge s \notin S^?$

(Writing (s, a) exits T to denote that $\text{Post}(s, a) \not\subseteq T$)

At each point of time, we can compute the overall set \mathfrak{B} consisting of unions of all the best-exit sets for all ECs, given the current over-approximation:

$$\mathfrak{B}^k \leftarrow \bigcup_{\substack{Y \subseteq S^? \\ Y \text{ is an MEC}}} \text{BESTEXITSET}(\mathcal{G}, \text{reach}_s^k + \text{stay}_s^k \cdot \mathbf{u}_k, Y) \quad (10)$$

4.3.2 Delays and strategies

The *delay* action helps to ensure monotonic progress. We refer the reader to Ex. 8 for an explanation of non-termination and cyclic behaviour without the delay action. To find out in which state we need to play a delay action, we first introduce a condition ‘IMPROVEDUB?(s)’ that prevents the Maximizer state to update the approximation to worse values than those of current estimates (monotonicity):

$$\text{IMPROVEDUB?}(s) := \text{reach}_s^{k+1} + \text{stay}_s^{k+1} \cdot \mathbf{u}_k \leq \text{reach}_s^k + \text{stay}_s^k \cdot \mathbf{u}_k \quad (11)$$

The following condition then captures when to delay rather than to play another action.

$$\text{DELAYACTION?}(s) := s \in S_{\Delta}^? \wedge \neg \text{IMPROVEDUB?}(s) \quad (12)$$

Intuitively, if a Maximizer state s is not a best exit of an EC and the upper bound for s does not improve, we play a delay action which we denote as d . In particular, under the condition $\text{DELAYACTION?}(s)$, the approximations for state s at iteration $k + 1$ are restored to the values from the k th iteration as detailed in the new part of Eq. (13):

$$\begin{array}{l} \text{BELLMAN-UPDATE } (\mathcal{B}): \\ \text{if } \text{DELAYACTION?}(s) \qquad \qquad \qquad \triangleright \text{New part to handle ECs} \\ \quad \text{reach}_s^{k+1} \leftarrow \text{reach}_s^k; \quad \text{stay}_s^{k+1} \leftarrow \text{stay}_s^k \\ \text{else} \qquad \qquad \qquad \qquad \qquad \qquad \qquad \qquad \qquad \triangleright \text{Same as before} \\ \quad \text{reach}_s^{k+1} \leftarrow \sum_{s' \in S} \delta(s, \pi_{k+1}(s), s') \cdot \text{reach}_{s'}^k; \quad \text{stay}_s^{k+1} \leftarrow \sum_{s' \in S} \delta(s, \pi_{k+1}(s), s') \cdot \text{stay}_{s'}^k \end{array} \quad (13)$$

Finally, we can re-define the strategies σ_k , reflecting the two new cases of exits and delays (while τ_k stays the same):

$$\begin{array}{l} \text{"k-STEP" MAXIMIZER'S CONTRACTING STRATEGIES:} \\ \sigma_0(\rho) \in \text{Av}(\rho_0) \\ \sigma_{k+1}(\rho) \leftarrow \begin{cases} \sigma_k(\rho') & \text{if } \rho = sa\rho' \\ d & \text{if } \rho = s \wedge \text{DELAYACTION?}(s) \\ b & \text{if } \rho = s \wedge (s, b) \in \mathfrak{B}^k \\ \in \arg \max_{a \in \text{Av}(s)} \sum_{s' \in S} \delta(s, a, s') \cdot \left(\mathcal{P}_{s'}^{\sigma_k, \tau_k}(\diamond^{\leq k} \mathbf{F}) + \mathcal{P}_{s'}^{\sigma_k, \tau_k}(\square^{\leq k} \mathbf{F}) \cdot \mathbf{u}_k \right) & \text{otherwise} \end{cases} \end{array} \quad (14)$$

4.3.3 SVI algorithm for SG with ECs

First, we prove correctness of the approximations and the strategies in the general case with ECs, considering the two additional “cases”. The proof can be found in App. B.3.

► **Theorem 10.** *Fix an SG \mathcal{G} with its state space partitioned in F , Z and $S^?$. Let $l_k, u_k \in \mathbb{R}$ be bounds as defined by Eq. (6), i.e. for all $k \geq 0$, $l_k \leq V(s) \leq u_k$ for all $s \in S^?$. For $\sigma_k \in \Sigma_\Delta$ and $\tau_k \in \Sigma_\nabla$ defined as in equations (14) and (5), respectively, the following inequality holds:*

$$\mathcal{P}_s^{\sigma_k, \tau_k}(\diamond^{\leq k} F) + \mathcal{P}_s^{\sigma_k, \tau_k}(\square^{\leq k} S^?) \cdot l_k \leq V(s) \leq \mathcal{P}_s^{\sigma_k, \tau_k}(\diamond^{\leq k} F) + \mathcal{P}_s^{\sigma_k, \tau_k}(\square^{\leq k} S^?) \cdot u_k$$

► **Remark 11.** Introducing delay action changes the semantic of $\mathcal{P}_s^{\sigma_k, \tau_k}(\diamond^{\leq k} F)$ and $\mathcal{P}_s^{\sigma_k, \tau_k}(\square^{\leq k} S^?)$ in a way that it is now optimal reach and stay probability for an $m \leq k$, i.e., at most k . We prove that this does not hurt the correctness.

Now we show how to modify Alg. 1 to obtain an algorithm that works for SG with ECs. First, we instantiate the Maximizer strategy σ by Eq. (14). Second, we use the new update BELLMAN-UPDATE as in Eq. (13). Finally, we use the following condition UPDATEGLOBALBOUNDS?:

$$\boxed{\text{UPDATEGLOBALBOUNDS?} := \forall s \in S^?. \text{stay}_s < 1 \wedge \neg \text{DELAYACTION?}(s)} \quad (15)$$

Intuitively, whenever we play a delaying action, we conservatively do not improve the global bounds l, u . A key property for proving termination is the following monotonicity of the over-approximation, proven in App. B.3

► **Lemma 12.** *Fix u, l such that $l \leq V(s) \leq u$. Alg. 1 instantiated with Maximizer’s strategy using Eq. (14), and UPDATEGLOBALBOUNDS? in (15) computes a monotonically non-increasing sequence of $\mathcal{P}_s^{\sigma_k, \tau_k}(\diamond^{\leq k} F) + \mathcal{P}_s^{\sigma_k, \tau_k}(\square^{\leq k} S^?) \cdot u$, i.e.*

$$\mathcal{P}_s^{\sigma_{k+1}, \tau_{k+1}}(\diamond^{\leq k+1} F) + \mathcal{P}_s^{\sigma_{k+1}, \tau_{k+1}}(\square^{\leq k+1} S^?) \cdot u \leq \mathcal{P}_s^{\sigma_k, \tau_k}(\diamond^{\leq k} F) + \mathcal{P}_s^{\sigma_k, \tau_k}(\square^{\leq k} S^?) \cdot u$$

► **Theorem 13.** *Fix an SG \mathcal{G} with its state space partitioned in F , Z and $S^?$ and precision $\varepsilon > 0$. Alg. 1 with sub-procedures in Sec. 4 (Maximizer strategy (14), new BELLMAN-UPDATE (13) and isUPDATEGLOBALBOUNDS? (15)) is correct and terminates with an ε -close approximation to the value V' , i.e. for all $s \in S^?$, $|V'(s) - V(s)| \leq \varepsilon$.*

Proof Sketch.

Correctness. For correctness, we argue of reach_s^k and stay_s^k are computing $\mathcal{P}_s^{\sigma_k, \tau_k}(\diamond^{\leq k} F)$ and $\mathcal{P}_s^{\sigma_k, \tau_k}(\square^{\leq k} S^?)$ (Lem. 29 in App. B.3) which is aligned with Thm. 10. We ensure that l_k and u_k are updated correctly in each iteration (Lem. 15). Then, correctness follows from Thm. 10.

Termination. We give a proof by contradiction of the algorithm termination even in the presence of ECs. Here, we present a high level idea of the proof in five steps. For a detailed proof, we refer to Lem. 27 in App. B.3.

1. Firstly, using Lem. 12 and the property that $u_{k+1} \leq u_k$, we show that the function U_k , defined as $\forall s \in S : U_k(s) := \text{reach}_s^k + \text{stay}_s^k \cdot u_k$ is well defined and has a fixpoint, i.e. $U^* := \lim_{k \rightarrow \infty} U_k$.
2. Secondly, we assume for contradiction that Alg. 1 does not terminate even when the fixpoint in Step 1 is reached.
3. Using this assumption, we define a subsystem X of \mathcal{G} , where the difference between U^* and V is maximum, and show the existence of an EC within X .

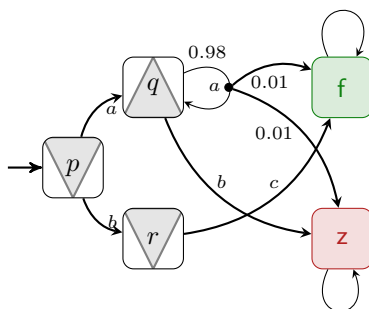

■ **Figure 5** An SG with $S^? = \{p, q, r\}$

4. Next, we show that applying another iteration of Alg. 1 leads to a contradiction to Step 2 by using Lem. 24. In particular, we refute the assumption that $U^* > V$. Thus, we can conclude $U^* = V$.
5. Finally, using $U^* = V$ and a similar contradiction argument, we prove that in the limit $\forall s \in S^? . \text{stay}_s^k = 0$. Therefore, the function L_k , defined as $\forall s \in S : L_k(s) = \text{reach}_s^k + \text{stay}_s^k \cdot l_k$ equals to reach_s^k , which implies that under and over-approximations converges to the same fixpoint.

4.4 A prototypical example to show how SVI solves SG faster

In Fig. 5, for the Minimizer in state p , playing a is optimal as b would give a value of 1. In state q , for the Maximizer playing a is better because b would give value of 0.

To solve this small example, BVI needs 685 iterations. Our new version of SVI is now applicable, even though the example is an SG. It solves it in just 2 iterations because it can deal with the probabilistic loop on state q in just one iteration. For more experimental analysis of the algorithm, see App. C.

5 Topological variants of sound value iteration

The core idea of topological value iteration [8] is to exploit the fact that there is an ordering among states, and certain states can never be reached again. More formally, a transition system can be decomposed into a directed acyclic graph of strongly connected components (SCC); the topological variant of a solution algorithm proceeds backwards through this graph, solving it component by component, see [16, Sec. 4.4] for more details. Also, we note that using the standard topological approach can in practice lead to non-termination [1, Sec. 4].

We propose a new approach of exploiting the topology of the transition system, specialized for SVI. The strength of SVI is in picking good bounds l and u quickly. However, the bounds are picked as the minimum/maximum over all states in $S^?$; thus, as long as there is one state that does not yet have a lot of information, it worsens the bounds for all others. In particular, if there is one state with a staying probability of 1, the bounds cannot be updated at all. These bad bounds additionally slow down convergence because the choice of strategies depends on the bounds.

To address this problem, we propose to modify the definition of the bounds, in particular the term $\text{opt}_{s \in S^?} \frac{\text{reach}_s^k}{1 - \text{stay}_s^k}$ in Eq (6), as follows: instead of globally defining the bounds by picking the optimum among all unknown states, we define a bound for each state s which

only picks among those states that are reachable from s .² This is correct because the bound represents the lowest/highest possible value the state s can achieve after staying for k steps; and, naturally, from s , the play can only reach a state that is reachable from s . In practice, we do not need to store a bound for every state, but instead one per SCC, because all states in the same SCC can reach each other, and thus also share their set of reachable states.

This improvement allows for more informed choices in parts of the state space where [reach](#) and [stay](#) already suffice to derive good bounds, without being hampered by other slow or uninformed parts of the state space. Moreover, we can stop updating an SCC when its lower and upper bound are equal, saving some resources.

6 Conclusion

We have extended the sound value iteration from Markov decision processes to stochastic games. In order to achieve that we had to lift the key assumption requiring that there are no end components. While the literature already suggests approaches to do so for other variants of value iteration, we have shown that they do not apply to sound value iteration. Instead we had to design a new dedicated solution. Besides, we have proposed improvements exploiting the topological properties of the models. While the approach is mostly on par with other value iteration approaches providing guarantees on precision, there are some examples where significant speed ups can be achieved. Yet, the point here was not a faster tool, but understanding the structure, in particular principles of evaluating cycles in SG. The inductive, attractor-like structure of MECs provides a key theoretical foundation for handling cycles. Furthermore, it addresses a critical drawback of VI and opens the path for potential future enhancements to BVI through efficient probabilistic cycle handling. Besides optimized implementation, the future work could include the theoretically interesting extension to concurrent stochastic games.

References

- 1 Muq̄sit Azeem, Alexandros Evangelidis, Jan Křetínský, Alexander Slivinskiy, and Maximilian Weininger. Optimistic and topological value iteration for simple stochastic games. In Ahmed Bouajjani, Lukáš Holík, and Zhilin Wu, editors, *Automated Technology for Verification and Analysis*, pages 285–302, Cham, 2022. Springer International Publishing.
- 2 Richard Bellman. A Markovian decision process. *Journal of Mathematics and Mechanics*, 6(5):679–684, 1957.
- 3 Dimitri P. Bertsekas and John N. Tsitsiklis. An analysis of stochastic shortest path problems. *Math. Oper. Res.*, 16(3):580–595, 1991.
- 4 Tomáš Brázdil, Krishnendu Chatterjee, Martin Chmelik, Vojtech Forejt, Jan Křetínský, Marta Z. Kwiatkowska, David Parker, and Mateusz Ujma. Verification of markov decision processes using learning algorithms. In *ATVA*, volume 8837 of *Lecture Notes in Computer Science*, pages 98–114. Springer, 2014. doi:10.1007/978-3-319-11936-6_8.
- 5 Krishnendu Chatterjee and Thomas A. Henzinger. Value iteration. In *25 Years of Model Checking*, volume 5000 of *Lecture Notes in Computer Science*, pages 107–138. Springer, 2008. doi:10.1007/978-3-540-69850-0_7.
- 6 Anne Condon. The complexity of stochastic games. *Inf. Comput.*, 96(2):203–224, 1992. doi:10.1016/0890-5401(92)90048-K.

² Formally, let $\text{All_reachable_states}(s)$ be the set of states reachable from s . Then the bounds for s use the term $\text{opt}_{s \in S^2 \cap \text{All_reachable_states}(s)} \frac{\text{reach}_s^k}{1 - \text{stay}_s^k}$

- 7 Anne Condon. On algorithms for simple stochastic games. In *Advances In Computational Complexity Theory*, volume 13 of *DIMACS Series in Discrete Mathematics and Theoretical Computer Science*, pages 51–71. DIMACS/AMS, 1993. doi:10.1090/dimacs/013/04.
- 8 Peng Dai, Mausam, Daniel S. Weld, and Judy Goldsmith. Topological value iteration algorithms. *J. Artif. Intell. Res.*, 42:181–209, 2011. URL: <http://jair.org/papers/paper3390.html>.
- 9 L. de Alfaro. *Formal Verification of Probabilistic Systems*. PhD thesis, Stanford University, 1997.
- 10 Christian Dehnert, Sebastian Junges, Joost-Pieter Katoen, and Matthias Volk. A storm is coming: A modern probabilistic model checker. In Rupak Majumdar and Viktor Kuncak, editors, *Computer Aided Verification - 29th International Conference, CAV 2017, Heidelberg, Germany, July 24-28, 2017, Proceedings, Part II*, volume 10427 of *Lecture Notes in Computer Science*, pages 592–600. Springer, 2017. doi:10.1007/978-3-319-63390-9_31.
- 11 Julia Eisentraut, Edon Kelmendi, Jan Křetínský, and Maximilian Weininger. Value iteration for simple stochastic games: Stopping criterion and learning algorithm. *Inf. Comput.*, 285(Part):104886, 2022. doi:10.1016/j.ic.2022.104886.
- 12 Serge Haddad and Benjamin Monmege. Interval iteration algorithm for mdps and imdps. *Theor. Comput. Sci.*, 735:111–131, 2018. doi:10.1016/j.tcs.2016.12.003.
- 13 Arnd Hartmanns, Sebastian Junges, Tim Quatmann, and Maximilian Weininger. A practitioner’s guide to mdp model checking algorithms. In Sriram Sankaranarayanan and Natasha Sharygina, editors, *Tools and Algorithms for the Construction and Analysis of Systems*, pages 469–488, Cham, 2023. Springer Nature Switzerland.
- 14 Arnd Hartmanns and Benjamin Lucien Kaminski. Optimistic value iteration. In *CAV (2)*, volume 12225 of *Lecture Notes in Computer Science*, pages 488–511. Springer, 2020. doi:10.1007/978-3-030-53291-8_26.
- 15 Arnd Hartmanns, Michaela Klauck, David Parker, Tim Quatmann, and Enno Ruijters. The quantitative verification benchmark set. In *TACAS (1)*, volume 11427 of *Lecture Notes in Computer Science*, pages 344–350. Springer, 2019. doi:10.1007/978-3-030-17462-0_20.
- 16 Jan Křetínský, Emanuel Ramneantu, Alexander Slivinskiy, and Maximilian Weininger. Comparison of algorithms for simple stochastic games. *Inf. Comput.*, 289(Part):104885, 2022. doi:10.1016/j.ic.2022.104885.
- 17 Marta Kwiatkowska, Gethin Norman, David Parker, and Gabriel Santos. Prism-games 3.0: Stochastic game verification with concurrency, equilibria and time. In *CAV (2)*, volume 12225 of *Lecture Notes in Computer Science*, pages 475–487. Springer, 2020. doi:10.1007/978-3-030-53291-8_25.
- 18 Marta Z. Kwiatkowska, Gethin Norman, and David Parker. PRISM 4.0: Verification of probabilistic real-time systems. In *CAV*, volume 6806 of *Lecture Notes in Computer Science*, pages 585–591. Springer, 2011.
- 19 Marta Z. Kwiatkowska, Gethin Norman, and David Parker. The PRISM benchmark suite. In *Ninth International Conference on Quantitative Evaluation of Systems, QEST 2012, London, United Kingdom, September 17-20, 2012*, pages 203–204. IEEE Computer Society, 2012. doi:10.1109/QEST.2012.14.
- 20 Jan Křetínský, Emanuel Ramneantu, Alexander Slivinskiy, and Maximilian Weininger. Comparison of algorithms for simple stochastic games. *Electronic Proceedings in Theoretical Computer Science*, 326:131–148, Sep 2020. URL: <http://dx.doi.org/10.4204/EPTCS.326.9>, doi:10.4204/eptcs.326.9.
- 21 Kittiphon Phalakarn, Toru Takisaka, Thomas Haas, and Ichiro Hasuo. Widest paths and global propagation in bounded value iteration for stochastic games. In *CAV (2)*, volume 12225 of *Lecture Notes in Computer Science*, pages 349–371. Springer, 2020. doi:10.1007/978-3-030-53291-8_19.
- 22 Martin L. Puterman. *Markov Decision Processes: Discrete Stochastic Dynamic Programming*. Wiley Series in Probability and Statistics. Wiley, 1994. doi:10.1002/9780470316887.

23:18 Sound Value Iteration for Simple Stochastic Games

- 23 Tim Quatmann and Joost-Pieter Katoen. Sound value iteration. In *CAV (1)*, volume 10981 of *Lecture Notes in Computer Science*, pages 643–661. Springer, 2018. doi:10.1007/978-3-319-96145-3_37.
- 24 Lloyd S Shapley. Stochastic games. *Proceedings of the national academy of sciences*, 39(10):1095–1100, 1953.
- 25 Maximilian Weininger. *Solving Stochastic Games Reliably*. PhD thesis, Technical University of Munich, Germany, 2022. URL: <https://nbn-resolving.org/urn:nbn:de:bvb:91-diss-20221118-1661588-1-0>.

A Additional details for Section 3

A.1 Computing bounds

Now that we have answered the first question—how to compute the strategies—we turn to the second question: obtaining good bounds l_k, u_k . We first note that using trivial bounds of $l = 0$ and $u = 1$ is sufficient for a correct and convergent algorithm, since (i) Theorem 5 proves that correctness of the bounds implies correctness of the approximations and (ii) the termination proof does not depend on the bounds, but rather uses the argument that the staying probability converges to 0. Still, using good bounds is the key to the good practical performance of SVI, as illustrated in Fig. 1. They enable a practically tight extrapolation from the step-bounded information accumulated so far.

Essentially, we want to utilize the same trick as described in Sec. 2.2: use the closed form of the geometric series and find the states that minimize and maximize it. So the naive idea is to set $l_k = \min_{s \in S} \frac{\text{reach}_s^k}{1 - \text{stay}_s^k}$ and dually for u with taking the maximum. However, in systems with non-determinism, i.e. MDP or SG, doing this is incorrect, as observed in [23] and concisely illustrated by the following example.

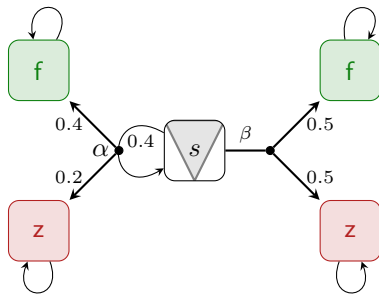

Figure 6 A Minimizer MDP with $S^? = \{s\}$

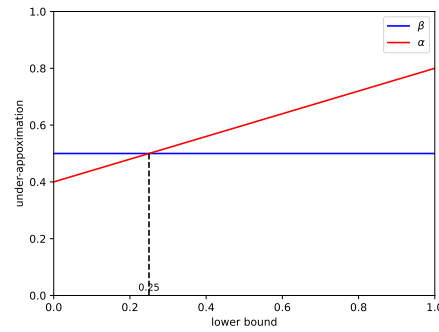

Figure 7 Comparison of actions α and β for the MDP in Fig. 6

Example 14. Always playing action α yields $\frac{2}{3}$ and always playing β yields 0.5. Thus, picking the action with the smaller value, the Minimizer state s has a value of 0.5.

When using the SVI approach to compute this, we choose the action according to Eq. (5). Since the initial lower bound is $l_0 = 0$, our choice intuitively only depends on the 1-step reachability probability, which is 0.4 for action α and 0.5 for action β . Being a Minimizer state, s prefers α and we have $\tau_1(s) = \alpha$.

Computing l_1 using the naive method (just using the closed form of the geometric series) yields $l_1 = \frac{\text{reach}_s^1}{1 - \text{stay}_s^1} = \frac{0.4}{1 - 0.4} = \frac{2}{3}$.

This is incorrect! Using action β , we get $V(s) = 0.5$, so $\frac{2}{3}$ is not a lower bound on the value. Intuitively, the problem is that action α was chosen based on l_0 , where it is optimal. But fully committing to it when computing l_1 ignores the fact that the better action β is available. When computing the bound, we have to take the other actions into account and not increase the bound to a number where actually a different action would be better.

We illustrate this in Fig. 7 where we depict the estimates for action α and β depending on the lower bound l . We see that up until $l < 0.25$, action α is preferred; for $l > 0.25$, action β yields the smaller estimate. Thus, we must not increase l to more than 0.25, because

otherwise the choice of α becomes suboptimal and we lose the correctness guarantees. In [23], this number was called *decision value*, as the decision of the strategy changes there.

More generally, in order to ensure the correctness of the bounds, the strategies σ_{k+1}, τ_{k+1} have to be optimal not only according to Eq. (5), but also for the same equation with \mathbf{b}_k replaced by \mathbf{b}_{k+1} . Thus, when computing \mathbf{b}_{k+1} , we cannot only use the closed form of the geometric series, but we have to pose additional constraints: for every action β other than the chosen action α , we have to ensure that \mathbf{b}_{k+1} is such that we still prefer α . Intuitively, we want to compute the intersection of the lines in Fig. 7 (the decision value) for every pair of actions and enforce that \mathbf{b}_{k+1} cannot cross such a decision value.

Given a state s and a pair of actions α, β , the decision value is exactly the point where their estimates are equal; the estimate for an action α is defined as $\sum_{s' \in \mathcal{S}} \delta(s, \alpha, s') \cdot (\text{reach}_{s'}^k + \text{stay}_{s'}^k \cdot \mathbf{b}_k)$. Rewriting the equality of the estimates by solving for \mathbf{b}_k yields the decision value:

$$\text{decval}_{\mathbf{b}}^k(s, \alpha, \beta) := \frac{\sum_{s' \in \mathcal{S}} (\delta(s, \beta, s') - \delta(s, \alpha, s')) \cdot \text{reach}_{s'}^k}{\sum_{s' \in \mathcal{S}} (\delta(s, \alpha, s') - \delta(s, \beta, s')) \cdot \text{stay}_{s'}^k} =: \frac{\Delta_{\text{reach}}(\beta, \alpha)}{\Delta_{\text{stay}}(\alpha, \beta)} \quad (16)$$

Now we can compute the decision value for a pair of actions. We want to ensure that the lower bound l is smaller than the least decision value over all states and actions — the minimum bound where any state would change its decision. Dually, we pick the largest decision value when computing u . However, not every decision value is relevant. For example, if in Ex. 14 the current lower bound is already larger than 0.25, we correctly pick action β , increasing the lower bound will not change our decision and no special precautions have to be taken. Intuitively, we are on the right of the intersection of the lines in Fig. 7.

Generally, if the slope of the chosen action α is smaller than the slope of the other action β , i.e. $\Delta_{\text{stay}}(\alpha, \beta) < 0$, then the current lower bound is larger than the decision value of these two actions; otherwise α would not have been picked. Dually, the current upper bound is already smaller than the decision value if $\Delta_{\text{stay}}(\alpha, \beta) < 0$ with chosen action α and other action β . Thus, we define the decision value of a state and chosen action which only considers the relevant pairs of actions, i.e. only other actions that can become better than the chosen one. Note that the conditions for both lower and upper bound are the same as for the minimizer state, the action with the least slope would be the best.

$$\boxed{\begin{aligned} \text{decval}_{\mathbf{b}}^k(s, \alpha) &:= \text{opt}_{\beta \in \text{Av}(s), \Delta_{\text{stay}}(\alpha, \beta) > 0} \text{decval}_{\mathbf{b}}^k(s, \alpha, \beta) \\ \text{decval}_{\mathbf{b}}^k &:= \text{opt}(\text{decval}^{k-1}, \text{opt}_{s \in \mathcal{S}} \text{decval}_{\mathbf{b}}^k(s, \alpha)) \end{aligned}} \quad (17)$$

For our final definition of the bounds, we utilize a shorthand for the action chosen for state s in the $(k+1)$ -st step according to Eq. (5) as $\text{chosen}^k(s) := \arg \text{opt}_{a \in \text{Av}(s)} \sum_{s' \in \mathcal{S}} \delta(s, a, s') \cdot (\text{reach}_{s'}^{k-1} + \text{stay}_{s'}^{k-1} \cdot \mathbf{b}_{k-1})$. Then, as soon as $\text{stay}_s^k < 1$ for all $s \in \mathcal{S}$, we can improve our trivial bounds as follows:

$$\boxed{\begin{aligned} &(\text{DYNAMIC}) \text{ BOUNDS:} \\ \mathbf{b}_k &:= \overline{\text{opt}} \left(\mathbf{b}_{k-1}, \text{opt} \left(\text{opt}_{s \in \mathcal{S}} \frac{\text{reach}_s^k}{1 - \text{stay}_s^k}, \text{decval}_{\mathbf{b}}^k \right) \right) \end{aligned}} \quad (6)$$

► **Lemma 15.** *Let l_k and u_k be defined according to Eq. (6), then $\forall s \in \mathcal{S}$ the following holds:*

1. $l_k \leq V(s) \leq u_k$
2. $l_k \leq \mathcal{P}_s^{\sigma_k, \tau_k}(\diamond F) \leq u_k$

Proof. To prove 1, we extend the proof of [23] to SG and also provide technical details that we found necessary to understand but implicit in that paper.

Assume $s_{\max} \in \mathcal{S}^?$ is a state achieving the maximal optimal reachability probability, say u^* , and $s_{\min} \in \mathcal{S}^?$ is a state that achieves the minimal optimal reachability probability, say l^* .

Formally, let $s_{\max} \in \arg \max_{s \in \mathcal{S}^?} V(s)$ and $V(s_{\max}) = u^*$, and let $s_{\min} \in \min_{s \in \mathcal{S}^?} V(s)$ and $V(s_{\min}) = l^*$.

We show that the u_k and l_k are indeed global upper and lower bounds respectively, i.e. for all $k \geq 0$, $u_k \geq u^*$ and $l_k \leq l^*$. We prove it for upper bound using induction on the number of iterations, the proof for the lower bound is dual.

Base case: By construction, for $k = 0$, $u_k = 1$.

Induction hypothesis: $u_{k-1} \geq u^*$, i.e. u_{k-1} is a correct upper bound which is computed according to the Eq. (6) and, therefore, depends on the strategies σ_{k-1} and τ_{k-1} as reach_s^{k-1} and stay_s^{k-1} depends on the same pair of strategies.

Induction step: We instantiate Eq. (6) for the global upper bound u_k with the respective decision value d_u to argue that the assignment $u_k = \min(u_{k-1}, \max(\max_{s \in \mathcal{S}^?} \frac{\text{reach}_s^k}{1 - \text{stay}_s^k}, d_u))$ gives a valid global u_k , we consider three cases:

Case 1:

If $u_k = u_{k-1}$, we need to prove $u_k \geq u^*$. By induction hypothesis, $u_{k-1} \geq u^*$, so $u_k \geq u^*$.

Further, we prepare the foundation which is needed for the proof of the next two cases.

For the state s_{\max} and a given pair of strategies σ_k and τ_k , we have the following:

$$\mathcal{P}_{s_{\max}}^{\sigma_k, \tau_k}(\diamond^{\leq k} \mathbf{F}) + \mathcal{P}_{s_{\max}}^{\sigma_k, \tau_k}(\square^{\leq k} \mathcal{S}^?) \cdot u_{k-1} \geq u^* \quad (\text{By Thm. 4})$$

This is correct because σ_k is optimal u_{k-1} is more conservative upper bound than u_k . By substitution using Lem. 19 this reduces to the following:

$$\text{reach}_{s_{\max}}^k + \text{stay}_{s_{\max}}^k \cdot u_{k-1} \geq u^* \quad (18)$$

Let's assume the following:

$$\begin{aligned} v_0 &= u_{k-1} \\ v_{i+1} &= f(v_i) = \text{reach}_{s_{\max}}^k + \text{stay}_{s_{\max}}^k \cdot v_i \end{aligned}$$

Given that the values of $\text{reach}_{s_{\max}}^k, \text{stay}_{s_{\max}}^k$ are fixed, f is an affine linear endofunction in $[0, 1]$. The fact that $\text{stay}_s^k < 1$ for all $s \in \mathcal{S}^?$ (from Alg. 1) implies that f has a unique fix-point. Therefore, we obtain:

$$v_\infty := \lim_{i \rightarrow \infty} v_i = \frac{\text{reach}_{s_{\max}}^k}{1 - \text{stay}_{s_{\max}}^k} \quad (19)$$

Moreover, we have the following:

▷ **Claim 16.**

$$\forall i \geq 0 : v_{i+1} \leq v_i$$

23:22 Sound Value Iteration for Simple Stochastic Games

The following chain of equations prove Claim 16.

$$\begin{aligned}
v_{i+1} &= f(v_i) \\
&= f(v_\infty + v_i - v_\infty) && \text{(Adding and subtracting } v_\infty.) \\
&= \text{reach}_{s_{\max}} + \text{stay}_{s_{\max}} \cdot (v_\infty + v_i - v_\infty) && \text{(By definition of } f.) \\
&= \text{reach}_{s_{\max}} + \text{stay}_{s_{\max}} \cdot v_\infty + \text{stay}_{s_{\max}} \cdot (v_i - v_\infty) \\
&= f(v_\infty) + \text{stay}_{s_{\max}} \cdot (v_i - v_\infty) && \text{(By definition of } f.) \\
&= v_\infty + \text{stay}_{s_{\max}} \cdot (v_i - v_\infty) && (v_\infty \text{ is a fix point of } f.) \\
&\leq v_\infty + v_i - v_\infty \\
&= v_i && (20)
\end{aligned}$$

▷ Claim 17.

$$v_i \in [d_u, u_{k-1}] \Rightarrow v_{i+1} \geq u^*$$

The proof of this claim follows from Ineq. (18) and the definition of decision value. If we replace u_{k-1} by d_u in Ineq. (18), then also the inequality holds.

Case 2:

If $u_k = d_u$, we need to prove that $d_u \geq u^*$.

We know the following:

$$\begin{aligned}
d_u &> \max_{s \in \mathcal{S}^?} \frac{\text{reach}_s^k}{1 - \text{stay}_s^k} && \text{(By Eq. (6))} \\
&\geq \frac{\text{reach}_{s_{\max}}^k}{1 - \text{stay}_{s_{\max}}^k} && (s_{\max} \in \mathcal{S}^?) \\
&= v_\infty
\end{aligned}$$

We know that

$$v_0 \in [d_u, u_{k-1}] \quad (v_0 = u_{k-1})$$

Also,

$$v_i \in [d_u, u_{k-1}] \Rightarrow v_{i+1} \geq u^* \quad \text{(By Claim 17)}$$

There exists i such that, $v_i \geq d_u$ and $v_{i+1} < d_u$.

Combining the above, we get: $u^* \leq v_{i+1} < d_u$.

Case 3:

If $u_k = \max_{s \in \mathcal{S}^?} \frac{\text{reach}_s^k}{1 - \text{stay}_s^k}$, then, we need to prove that $\max_{s \in \mathcal{S}^?} \frac{\text{reach}_s^k}{1 - \text{stay}_s^k} \geq u^*$.

From the upper bound assignment in Eq. (6), we can deduce the following:

■

$$\max_{s \in \mathcal{S}^?} \frac{\text{reach}_s^k}{1 - \text{stay}_s^k} \geq d_u \quad \text{(By Eq. (6))}$$

■

$$\begin{aligned}
u_{k-1} &\geq \max_{s \in \mathcal{S}^?} \frac{\text{reach}_s^k}{1 - \text{stay}_s^k} && \text{(By Eq. (6))} \\
&\geq \frac{\text{reach}_{s_{\max}}^k}{1 - \text{stay}_{s_{\max}}^k} && (s_{\max} \in \mathcal{S}^?) \\
&= v_\infty && \text{(By definition of } v_\infty.)
\end{aligned}$$

It is sufficient to prove that $v_\infty \geq \mathbf{u}^*$.

We first show that if $\mathbf{u}_{k-1} \geq v_\infty$, then for all i , $v_{i+1} \leq v_i$.

a) We prove by induction that for all i , $v_i \geq v_\infty$.

Base case:

We know that $u_{k-1} \geq v_\infty$ and by assumption, we have that $v_0 = \mathbf{u}_{k-1}$. This implies $v_0 \geq v_\infty$.

Induction hypothesis: $v_i \geq v_\infty$

Induction step:

$$\begin{aligned} v_i &\geq v_\infty && \text{(By induction hypothesis.)} \\ \Rightarrow f(v_i) &\geq f(v_\infty) && \text{(Applying } f \text{ both sides, we know the function } f \text{ and only var part is } v_i) \\ \Rightarrow v_{i+1} &\geq v_\infty && (v_\infty \text{ is a fix point.)} \\ \Rightarrow \forall i, v_i &\geq v_\infty \end{aligned}$$

b) From Claim 16, we have: $v_{i+1} \leq v_i$ for all $i \geq 0$.

Also, from Claim 17, we have $v_i \in [d_u, \mathbf{u}_{k-1}]$. Combining the two implies $v_{i+1} \geq \mathbf{u}^*$, implies $v_\infty \geq \mathbf{u}^*$.

To prove 2, we again consider the three cases based on the respective assignment and prove it for the upper bound. The case of lower bound is dual.

Case 1: $u_k = \mathbf{u}_{k-1}$.

We need to prove: $\mathbf{u}_{k-1} \geq \max_{s \in \mathcal{S}^?} \mathcal{P}_s^{\sigma_k, \tau_k}(\diamond F)$.

We know that for all $s \in \mathcal{S}^?$:

$$\begin{aligned} \mathbf{u}_{k-1} &\geq \mathcal{P}_s^{\sigma_k, \tau_k}(\diamond^{\leq k} F) + \mathcal{P}_s^{\sigma_k, \tau_k}(\square^{\leq k} \mathcal{S}^?) \cdot \mathbf{u}_{k-1} && \text{(By Argument 1.)} \\ &\geq \mathcal{P}_s^{\sigma_k, \tau_k}(\diamond F) && \text{(By Thm. 4)} \\ &\geq \max_{s \in \mathcal{S}^?} \mathcal{P}_s^{\sigma_k, \tau_k}(\diamond F) && \text{(By pushing universal quantification.)} \end{aligned}$$

Argument 1: First inequality holds because \mathbf{u}_{k-1} is correct upperbound on the value of all states of the underlying Markov chain under the strategies σ_k and τ_k .

Case 2: $u_k = \max_{s \in \mathcal{S}^?} \frac{\text{reach}_s^k}{1 - \text{stay}_s^k}$.

We need to prove:

$$\max_{s \in \mathcal{S}^?} \frac{\text{reach}_s^k}{1 - \text{stay}_s^k} \geq \max_{s \in \mathcal{S}^?} \mathcal{P}_s^{\sigma_k, \tau_k}(\diamond F)$$

Let $s_{k_{\max}} \in \arg \max_{s \in \mathcal{S}^?} \mathcal{P}_s^{\sigma_k, \tau_k}(\diamond F)$.

This implies that our goal is to achieve:

$$\max_{s \in \mathcal{S}^?} \frac{\text{reach}_s^k}{1 - \text{stay}_s^k} \geq \mathcal{P}_{s_{k_{\max}}}^{\sigma_k, \tau_k}(\diamond F)$$

Using Thm. 4, we obtain the following instantiation of the inequality.

$$\mathcal{P}_{s_{k_{\max}}}^{\sigma_k, \tau_k}(\diamond F) \leq \mathcal{P}_{s_{k_{\max}}}^{\sigma_k, \tau_k}(\diamond^{\leq k} F) + \mathcal{P}_{s_{k_{\max}}}^{\sigma_k, \tau_k}(\square^{\leq k} \mathcal{S}^?) \cdot \mathcal{P}_{s_{k_{\max}}}^{\sigma_k, \tau_k}(\diamond F)$$

Solving this inequality, we obtain:

$$\begin{aligned} \mathcal{P}_{s_{k\max}}^{\sigma_k, \tau_k}(\diamond F) &\leq \frac{\mathcal{P}_{s_{k\max}}^{\sigma_k, \tau_k}(\diamond \leq^k F)}{1 - \mathcal{P}_{s_{k\max}}^{\sigma_k, \tau_k}(\square \leq^k S^?) } \\ &\leq \max_{s \in S^?} \frac{\mathcal{P}_s^{\sigma_k, \tau_k}(\diamond \leq^k F)}{1 - \mathcal{P}_s^{\sigma_k, \tau_k}(\square \leq^k S^?) } \end{aligned}$$

This implies:

$$\max_{s' \in S^?} \mathcal{P}_{s'}^{\sigma_k, \tau_k}(\diamond F) \leq \max_{s \in S^?} \frac{\text{reach}_s^k}{1 - \text{stay}_s^k}$$

Case 3: $u_k = d_u$.

We need to prove that $d_u \geq \max_{s' \in S^?} \mathcal{P}_{s'}^{\sigma_k, \tau_k}(\diamond F)$.

From the assignment, we have: $d_u \geq \max_{s \in S^?} \frac{\text{reach}_s^k}{1 - \text{stay}_s^k}$

Following the reasoning in the **Case 2**, we obtain:

$$\max_{s' \in S^?} \mathcal{P}_{s'}^{\sigma_k, \tau_k}(\diamond F) \leq \max_{s \in S^?} \frac{\text{reach}_s^k}{1 - \text{stay}_s^k}$$

Combining these inequalities gives: $d_u \geq \max_{s' \in S^?} \mathcal{P}_{s'}^{\sigma_k, \tau_k}(\diamond F)$ This concludes the last case.

Summary: These proofs conclude that u_k is always a correct upper bound and decision value plays an important role for establishing the invariant that it is correct with respect to the strategies σ_k and τ_k . The proofs for l_k is completely dual to u_k which proves that the assignment for l_k in Alg. 1 is always updates to a valid global lower bound with respect to the player's strategy. ◀

Now we can state the correctness of the estimates computed based on these “ k -step strategies.”

► **Theorem 5.** *Fix an SG \mathcal{G} with its state space partitioned in F , Z and $S^?$. Let $l_k, u_k \in \mathbb{R}$ be bounds as defined by Eq. (6). For $\sigma_k \in \Sigma_\Delta, \tau_k \in \Sigma_\nabla$ defined by Eq. (5), the following inequality holds:*

$$\mathcal{P}_s^{\sigma_k, \tau_k}(\diamond \leq^k F) + \mathcal{P}_s^{\sigma_k, \tau_k}(\square \leq^k S^?) \cdot l_k \leq V(s) \leq \mathcal{P}_s^{\sigma_k, \tau_k}(\diamond \leq^k F) + \mathcal{P}_s^{\sigma_k, \tau_k}(\square \leq^k S^?) \cdot u_k$$

Proof. We first prove the upper inequality. The lower is dual and we mention all differences at the end of this proof.

Fix an arbitrary $k \in \mathbb{N}_0$. By Lem. 15 we have $V(s) \leq u_k$. This allows us to utilize Ineq. 3. Instantiating the arbitrary Minimizer strategy with τ_k we obtain

$$V(s) \leq \sup_{\sigma \in \Sigma_\Delta} (\mathcal{P}_s^{\sigma, \tau_k}(\diamond \leq^k F) + \mathcal{P}_s^{\sigma, \tau_k}(\square \leq^k S^?) \cdot u_k) \quad (21)$$

It remains to prove that σ_k is among the optimal strategies for the modified objective on the right side of Ineq 21. This part of the proof was omitted in the original paper [23], just stating that it is necessary but not explicitly proving it.

Remaining proof goal:

For all states $s \in S$, we have

$$\sup_{\sigma \in \Sigma_\Delta} (\mathcal{P}_s^{\sigma, \tau_k}(\diamond \leq^k F) + \mathcal{P}_s^{\sigma, \tau_k}(\square \leq^k S^?) \cdot u_k) = \mathcal{P}_s^{\sigma_k, \tau_k}(\diamond \leq^k F) + \mathcal{P}_s^{\sigma_k, \tau_k}(\square \leq^k S^?) \cdot u_k$$

We proceed by performing an induction on the number of steps remaining in the objective. Before that, we formally define the one step unfolding of the objective. This is necessary for the induction step and instructive for understanding the idea of the proof.

In the following, $s \in \mathcal{S}$ always denotes an arbitrary state and $i \in \mathbb{N}_0$ with $0 < i < k$ denotes a number of steps. We highlight that k is an arbitrary but fixed number (thus also fixing σ_k, τ_k and l_k, u_k) and we argue about the step-bounded probabilities used when considering this particular objective.

Unfolding one step:

Recall that we use π to denote σ if it is applied to a state $s \in \mathcal{S}_\Delta$; and to denote τ otherwise. By standard results, e.g. [22, Chapter 4], we can unfold the definition of the probabilities. Formally, for all strategy pairs (σ, τ) , we have:

$$\mathcal{P}_s^{\sigma, \tau}(\diamond^{\leq i} \mathbf{F}) = \sum_{s' \in \mathcal{S}} \delta(s, \pi(s), s') \cdot \mathcal{P}_s^{\sigma', \tau'}(\diamond^{\leq i-1} \mathbf{F})$$

where the updated strategies σ', τ' are defined by prepending $s\pi(s)$ to the history, i.e. for every history ρ we have $\pi'(\rho) := \pi(s\pi(s)\rho)$. Note that in particular $\pi'_k = \pi_{k-1}$ because by definition (the second case of the recursion in Eq. (5)) π_k mimics the previous strategies.

By analogously unfolding $\mathcal{P}_s^{\sigma, \tau}(\square^{\leq i} \mathbf{S}^?)$ and using distributivity, we obtain that for strategies σ_i, τ_i defined by Eq. (5) the following holds:

$$\begin{aligned} & \mathcal{P}_s^{\sigma_i, \tau_i}(\diamond^{\leq i} \mathbf{F}) + \mathcal{P}_s^{\sigma_i, \tau_i}(\square^{\leq i} \mathbf{S}^?) \cdot u_k \\ &= \sum_{s' \in \mathcal{S}} \delta(s, \pi(s), s') \cdot (\mathcal{P}_s^{\sigma_{i-1}, \tau_{i-1}}(\diamond^{\leq i-1} \mathbf{F}) + \mathcal{P}_s^{\sigma_{i-1}, \tau_{i-1}}(\square^{\leq i-1} \mathbf{S}^?) \cdot u_k) \end{aligned}$$

Base case:

$$\sup_{\sigma \in \Sigma_\Delta} (\mathcal{P}_s^{\sigma, \tau_0}(\diamond^{\leq 0} \mathbf{F}) + \mathcal{P}_s^{\sigma, \tau_0}(\square^{\leq 0} \mathbf{S}^?) \cdot u_k) = \mathcal{P}_s^{\sigma_0, \tau_0}(\diamond^{\leq 0} \mathbf{F}) + \mathcal{P}_s^{\sigma_0, \tau_0}(\square^{\leq 0} \mathbf{S}^?) \cdot u_k$$

This is true because if there are 0 steps remaining, the choice of strategy is irrelevant. Intuitively, this is also why π_0 picks an arbitrary action in the base case in Eq. (5).

Induction hypothesis:

$$\sup_{\sigma \in \Sigma_\Delta} (\mathcal{P}_s^{\sigma, \tau_i}(\diamond^{\leq i} \mathbf{F}) + \mathcal{P}_s^{\sigma, \tau_i}(\square^{\leq i} \mathbf{S}^?) \cdot u_k) = \mathcal{P}_s^{\sigma_i, \tau_i}(\diamond^{\leq i} \mathbf{F}) + \mathcal{P}_s^{\sigma_i, \tau_i}(\square^{\leq i} \mathbf{S}^?) \cdot u_k$$

Recall that $s \in \mathcal{S}$ always denotes an arbitrary state and $i \in \mathbb{N}$ with $0 < i < k$ denotes a number of steps. We do not care about numbers $j > k$ for our overall goal.

Induction step:

We make a case distinction on the owner of the arbitrary state s . We start with the easier case $s \in \mathcal{S}_\nabla$. The following chain of equations proves our goal.

$$\begin{aligned} & \sup_{\sigma \in \Sigma_\Delta} (\mathcal{P}_s^{\sigma, \tau_{i+1}}(\diamond^{\leq i+1} \mathbf{F}) + \mathcal{P}_s^{\sigma, \tau_{i+1}}(\square^{\leq i+1} \mathbf{S}^?) \cdot u_k) \\ &= \sum_{s' \in \mathcal{S}} \delta(s, \tau_{i+1}(s), s') \cdot \sup_{\sigma \in \Sigma_\Delta} (\mathcal{P}_s^{\sigma, \tau_i}(\diamond^{\leq i} \mathbf{F}) + \mathcal{P}_s^{\sigma, \tau_i}(\square^{\leq i} \mathbf{S}^?) \cdot u_k) \quad (\text{By unfolding one step.}) \\ &= \sum_{s' \in \mathcal{S}} \delta(s, \tau_{i+1}(s), s') \cdot \mathcal{P}_s^{\sigma_i, \tau_i}(\diamond^{\leq i} \mathbf{F}) + \mathcal{P}_s^{\sigma_i, \tau_i}(\square^{\leq i} \mathbf{S}^?) \cdot u_k \quad (\text{By induction hypothesis.}) \\ &= \mathcal{P}_s^{\sigma_{i+1}, \tau_{i+1}}(\diamond^{\leq i+1} \mathbf{F}) + \mathcal{P}_s^{\sigma_{i+1}, \tau_{i+1}}(\square^{\leq i+1} \mathbf{S}^?) \cdot u_k \quad (\text{By reversing the unfolding.}) \end{aligned}$$

For reversing the unfolding, note that $s \in S_\nabla$ implies that σ_{i+1} is not applied to s , so we can just add it to the history. This is the added difficulty of the second case where $s \in S_\Delta$: proving that the first choice of σ_{i+1} is optimal. We first provide the chain of equations and then separately provide arguments for the more involved steps.

$$\begin{aligned}
 & \sup_{\sigma \in \Sigma_\Delta} (\mathcal{P}_s^{\sigma, \tau_{i+1}}(\diamond^{\leq i+1} \mathbf{F}) + \mathcal{P}_s^{\sigma, \tau_{i+1}}(\square^{\leq i+1} \mathbf{S}^?) \cdot \mathbf{u}_k) \\
 &= \sup_{\sigma \in \Sigma_\Delta} \left(\sum_{s' \in S} \delta(s, \sigma(s), s') \cdot \sup_{\sigma' \in \Sigma_\Delta} (\mathcal{P}_{s'}^{\sigma', \tau_i}(\diamond^{\leq i} \mathbf{F}) + \mathcal{P}_{s'}^{\sigma', \tau_i}(\square^{\leq i} \mathbf{S}^?) \cdot \mathbf{u}_k) \right) \\
 & \hspace{15em} \text{(By unfolding one step and Argument 1.)} \\
 &= \sup_{\sigma \in \Sigma_\Delta} \left(\sum_{s' \in S} \delta(s, \sigma(s), s') \cdot \mathcal{P}_{s'}^{\sigma_{i+1}, \tau_i}(\diamond^{\leq i} \mathbf{F}) + \mathcal{P}_{s'}^{\sigma_{i+1}, \tau_i}(\square^{\leq i} \mathbf{S}^?) \cdot \mathbf{u}_k \right) \\
 & \hspace{15em} \text{(By induction hypothesis.)} \\
 &= \sum_{s' \in S} \delta(s, \sigma_{i+1}(s), s') \cdot \mathcal{P}_{s'}^{\sigma_{i+1}, \tau_i}(\diamond^{\leq i} \mathbf{F}) + \mathcal{P}_{s'}^{\sigma_{i+1}, \tau_i}(\square^{\leq i} \mathbf{S}^?) \cdot \mathbf{u}_k \hspace{5em} \text{(By Argument 2.)} \\
 &= \mathcal{P}_s^{\sigma_{i+1}, \tau_{i+1}}(\diamond^{\leq i+1} \mathbf{F}) + \mathcal{P}_s^{\sigma_{i+1}, \tau_{i+1}}(\square^{\leq i+1} \mathbf{S}^?) \cdot \mathbf{u}_k \hspace{5em} \text{(By reversing the unfolding.)}
 \end{aligned}$$

Argument 1: By unfolding, the strategy for the remaining i steps is $\sigma'(\rho) := \sigma(\sigma(s)\rho)$. However, since σ is the optimal strategy for $i+1$ steps, we know that σ' is the optimal strategy for i steps and can write it as the supremum over all strategies. This allows us to immediately apply our induction hypothesis.

Argument 2: By definition of the strategies (Eq. (5)), $\sigma_{i+1}(s) = \arg \max_{a \in Av(s)} \sum_{s' \in S} \delta(s, a, s') \cdot (\mathcal{P}_{s'}^{\sigma_{i+1}, \tau_i}(\diamond^{\leq i} \mathbf{F}) + \mathcal{P}_{s'}^{\sigma_{i+1}, \tau_i}(\square^{\leq i} \mathbf{S}^?) \cdot \mathbf{u}_k)$. The only difference to what we need to prove the equality is that σ_{i+1} picks according to \mathbf{u}_i , while the optimal strategy picks according to \mathbf{u}_k . This is the reason we have the decision value, and the reason for it being a bound for all iterations to come.

Let α be the action picked by σ_{i+1} and β the action picked by the optimal strategy.

By definition of the bounds (Eq. (6), namely the third item taking the maximum with the previous decision value), we have $\mathbf{u}_k \geq \text{decval}_{\mathbf{u}}^i$, and this decision value (by Eq. (17)) certainly is greater than $\text{decval}_{\mathbf{u}}^i(s, \alpha, \beta)$. (Side argument: What if $\Delta_{\text{stay}}(\alpha, \beta) \leq 0$? If it is equal to 0, then by changing the bound the actions still have the same estimate and we know that α is optimal, too. If it is less than 0, decreasing the upper bound will decrease the estimate of β by more than α , and since $\mathbf{u}_k \leq \mathbf{u}_i$ and β is optimal, this means α has to be optimal, too, and $\mathbf{u}_k = \mathbf{u}_i$.) By definition (Eq. (16)), $\text{decval}_{\mathbf{u}}^i(s, \alpha, \beta)$ is the number where the estimates of α and β are equal; for all greater numbers, α has an estimate that is greater or equal to that of β . Since \mathbf{u}_k is greater than $\text{decval}_{\mathbf{u}}^i(s, \alpha, \beta)$, we know that α still is optimal.

Thus, we conclude that picking $\alpha = \sigma_{i+1}(s)$ is also optimal when considering \mathbf{u}_k and our chain of equations is correct.

Summary and the dual case of the lower bound The proof for the lower bound is dual. First, we utilize Ineq. (4) to reduce our proof goal to showing that τ_k is an optimal strategy for the step-bounded objective, i.e.

$$\tau_k \in \arg \inf_{\tau \in \Sigma_\nabla} (\mathcal{P}_s^{\sigma_k, \tau}(\diamond^{\leq k} \mathbf{F}) + \mathcal{P}_s^{\sigma_k, \tau}(\square^{\leq k} \mathbf{S}^?) \cdot \mathbf{l}_k)$$

Then we perform the same induction on the number of remaining steps, basically always replacing max with min, sup with inf and \geq with \leq . We mention that Argument 2 of the induction step utilizes the newly introduced lower decision value; still, the argument remains

the same. Thus, we conclude that the bounds computed by Alg. 1 are correct in every iteration. ◀

A.2 Algorithms of Section 3

In this section we give more detailed “program-type” version of Alg. 1 which is shown in Alg. 3.

■ **Algorithm 3** Sound value iteration for SG

Input: SG \mathcal{G} and naive precision ε

Output: V' such that $\text{diff}(V'(s), V(s)) \leq \varepsilon$ for all $s \in S$

```

1: procedure SVI( $\mathcal{G}, \varepsilon$ )
2:   ▷ Initialization of  $\text{reach}, \text{stay}, l, u, d_l, d_u$ 
3:   repeat
4:      $\mathfrak{B} = \text{HANDLEECs}(\mathcal{G}, \text{reach}, \text{stay}, u)$ 
5:     for  $s \in S^?$  do
6:        $\alpha \in \text{FINDACTION}(\text{reach}, \text{stay}, l, u, s, \mathfrak{B})$  ▷ pick arbitrarily among best actions
7:        $d \leftarrow \text{DECISIONVALUE}(\text{reach}, \text{stay}, s, \alpha)$ 
8:       if  $s \in S_\Delta$  then ▷ state belongs to Maximizer
9:          $d_u \leftarrow \max(d_u, d)$ 
10:      else ▷ state belongs to Minimizer
11:         $d_l \leftarrow \min(d_l, d)$ 
12:       $\text{BELLMAN-UPDATE}(s, \alpha, \text{reach}, \text{stay})$  ▷ batch update using old values
13:      if  $\text{UPDATEGLOBALBOUNDS?}$  then ▷ depends on the presence of ECs and  $\text{stay}$ 
14:         $l \leftarrow \max\left(l, \min\left(d_l, \min_{s \in S^?} \frac{\text{reach}_s}{1 - \text{stay}_s}\right)\right)$ 
15:         $u \leftarrow \min\left(u, \max\left(d_u, \max_{s \in S^?} \frac{\text{reach}_s}{1 - \text{stay}_s}\right)\right)$ 
16:      until  $[\text{stay}_s \cdot (u - l)] < 2 \cdot \varepsilon$  for all  $s \in S^?$ 
17:      return  $\text{reach}_s + \text{stay}_s \cdot \frac{l+u}{2}$  for all  $s \in S^?$ 

```

Line 2 refer to the several initializations which take place. For reach and stay the initializations are as follows.

$$\text{reach}_s \leftarrow \begin{cases} 1, & \text{if } s \in F, \\ 0, & \text{if } s \in S \setminus F \end{cases}$$

$$\text{stay}_s \leftarrow \begin{cases} 1, & \text{if } s \in S^?, \\ 0, & \text{if } s \in S \setminus S^? \end{cases}$$

Moreover, initially, $l := 0$, $u := 1$, $d_u := 0$ and $d_l := 1$. As there are no ECs, Line 4 does not have any effect and returns an empty set, i.e. $\mathfrak{B} = \emptyset$. For all states where the values are not known, the FINDACTION (Line 6) picks an action according to Eq. (5). The states of Minimizer influences the value of d_l as the actions for these states are picked according to a function that is dependent on l . Dually, updates of the states of Maximizer influences the value of d_u . Computation of Decision Value is given in 5. Lines 7-11 updates the decision values depending on which player the state belongs to. Line 12 updates the reach and stay according to the picked action. UPDATE procedure for EC free games is given in Alg. 9. In the absence of ECs Line 13 checks if the condition $\text{stay}_s < 1$ for all $s \in S^?$. If the condition is true, Lines 14-15, updates global lower and upper bound if the condition holds. The approximations $\min_{s \in S^?} \frac{\text{reach}_s}{1 - \text{stay}_s}$ and $\max_{s \in S^?} \frac{\text{reach}_s}{1 - \text{stay}_s}$, are used to compute lower and

upper bound. This example uses the decision value for the lower bound. For an example where we need the decision value for the upper bound, we refer the reader to [23, Ex. 6].

A.2.1 Pseudocode for FindAction and DecisionValue

■ **Algorithm 4** Find action computation for SG

```

1: procedure FINDACTION(reach, stay, l, u, s)
2:   if  $s \in S_\Delta$  then
3:     return  $\arg \max_{\alpha \in Act(s)} \sum_{s' \in S} \delta(s, \alpha, s') \cdot (\text{reach}_{s'}^k + \text{stay}_{s'}^k \cdot u)$ 
4:   else
5:     return  $\arg \min_{\alpha \in Act(s)} \sum_{s' \in S} \delta(s, \alpha, s') \cdot (\text{reach}_{s'}^k + \text{stay}_{s'}^k \cdot l)$ 

```

■ **Algorithm 5** Decision value computation for SG

```

1: procedure DECISIONVALUE(reach, stay, s,  $\alpha$ )
2:    $d \leftarrow \begin{cases} 0, & \text{if } s \in S_\Delta \\ 1, & \text{if } s \in S_\nabla \end{cases}$ 
3:   for  $\beta \in Act(s) \setminus \{\alpha\}$  do
4:      $\Delta_{\text{stay}} \leftarrow \sum_{s' \in S} (\delta(s, \alpha, s') - \delta(s, \beta, s')) \cdot \text{stay}_{s'}$ 
5:     if  $\Delta_{\text{stay}}$  is positive then
6:        $\Delta_{\text{reach}} \leftarrow \sum_{s' \in S} (\delta(s, \beta, s') - \delta(s, \alpha, s')) \cdot \text{reach}_{s'}$ 
7:        $d \leftarrow \begin{cases} \max(d, \Delta_{\text{reach}}/\Delta_{\text{stay}}), & \text{if } s \in S_\Delta \\ \min(d, \Delta_{\text{reach}}/\Delta_{\text{stay}}), & \text{if } s \in S_\nabla \end{cases}$ 
8:   return d

```

A.3 Proofs of Section 3

► **Lemma 18.** *Fix an SG \mathcal{G} with its state space partitioned in F , Z and $S^?$. Let $l, u \in \mathbb{R} \cap [0, 1]$ with $l \leq V(s) \leq u$ for all $s \in S^?$ and $\sigma_k \in \Sigma_{\Delta}^{\max}, \tau_k \in \Sigma_{\Delta}^{\min}$ be defined by Eq. (5). Then, the following inequality holds for all $k \in \mathbb{N}$:*

$$\mathcal{P}_s^{\sigma_k, \tau_k}(\diamond^{\leq k} F) + \mathcal{P}_s^{\sigma_k, \tau_k}(\square^{\leq k} S^?) \cdot l \leq V(s) \leq \mathcal{P}_s^{\sigma_k, \tau_k}(\diamond^{\leq k} F) + \mathcal{P}_s^{\sigma_k, \tau_k}(\square^{\leq k} S^?) \cdot u$$

Proof. We prove by induction the following inequality to provide an upper bound on the value of $s, V(s)$ for all $s \in S^?$:

$$V(s) \leq \mathcal{P}_s^{\sigma_k, \tau_k}(\diamond^{\leq k} F) + \mathcal{P}_s^{\sigma_k, \tau_k}(\square^{\leq k} S^?) \cdot u$$

Base Case: For $k = 0$:

$$\begin{aligned} & \mathcal{P}_s^{\sigma_0, \tau_0}(\diamond^{\leq 0} F) + \mathcal{P}_s^{\sigma_0, \tau_0}(\square^{\leq 0} S^?) \cdot u \\ & \geq V(s) \end{aligned}$$

This inequality holds because for $s \in F$, $\mathcal{P}_s^{\sigma_0, \tau_0}(\diamond^{\leq 0} F) = 1$, and for $s \in S \setminus F$, $\mathcal{P}_s^{\sigma_0, \tau_0}(\square^{\leq 0} S^?) = 1$ and $1 \geq u \geq V(s)$.

Induction hypothesis:

$$\mathcal{P}_s^{\sigma_k, \tau_k}(\diamond^{\leq k} F) + \mathcal{P}_s^{\sigma_k, \tau_k}(\square^{\leq k} S^?) \cdot u \geq V(s)$$

Induction step: We use case split on type of state to prove the induction step.

Case 1. $s \in S_{\Delta}$:

$$\begin{aligned} & \mathcal{P}_s^{\sigma_{k+1}, \tau_{k+1}}(\diamond^{\leq k+1} F) + \mathcal{P}_s^{\sigma_{k+1}, \tau_{k+1}}(\square^{\leq k+1} S^?) \cdot u \\ & = \sum_{s' \in S} \delta(s, a, s') \cdot (\mathcal{P}_{s'}^{\sigma_k, \tau_k}(\diamond^{\leq k} F) + \mathcal{P}_{s'}^{\sigma_k, \tau_k}(\square^{\leq k} S^?) \cdot u) \\ & \quad (\text{By definition of } \mathcal{P}_s^{\sigma_{k+1}, \tau_{k+1}}(\diamond^{\leq k+1} F), \mathcal{P}_s^{\sigma_{k+1}, \tau_{k+1}}(\square^{\leq k+1} S^?), \text{ and given } \sigma_{k+1}(s) := a) \\ & = \max_{a \in \text{Av}(s)} \sum_{s' \in S} \delta(s, a, s') \cdot (\mathcal{P}_{s'}^{\sigma_k, \tau_k}(\diamond^{\leq k} F) + \mathcal{P}_{s'}^{\sigma_k, \tau_k}(\square^{\leq k} S^?) \cdot u) \\ & \quad (\text{By definition of } \sigma_{k+1}(s).) \\ & \geq \max_{a \in \text{Av}(s)} \sum_{s' \in S} \delta(s, a, s') \cdot V(s') \\ & \quad (\text{By induction hypothesis.}) \\ & = V(s) \\ & \quad (\text{By definition of } V.) \end{aligned}$$

Note that the unfolding of $\mathcal{P}_s^{\sigma_{k+1}, \tau_{k+1}}(\diamond^{\leq k+1} F)$ and $\mathcal{P}_s^{\sigma_{k+1}, \tau_{k+1}}(\square^{\leq k+1} S^?)$ follow from the standard definition of probability space.

Case 2. $s \in S_{\nabla}$:

$$\begin{aligned} & \mathcal{P}_s^{\sigma_{k+1}, \tau_{k+1}}(\diamond^{\leq k+1} F) + \mathcal{P}_s^{\sigma_{k+1}, \tau_{k+1}}(\square^{\leq k+1} S^?) \cdot u \\ & = \sum_{s' \in S} \delta(s, a, s') \cdot (\mathcal{P}_{s'}^{\sigma_k, \tau_k}(\diamond^{\leq k} F) + \mathcal{P}_{s'}^{\sigma_k, \tau_k}(\square^{\leq k} S^?) \cdot u) \\ & \quad (\text{By definition of } \mathcal{P}_s^{\sigma_{k+1}, \tau_{k+1}}(\diamond^{\leq k+1} F), \mathcal{P}_s^{\sigma_{k+1}, \tau_{k+1}}(\square^{\leq k+1} S^?), \text{ and given } \tau_{k+1}(s) := a) \\ & \geq \sum_{s' \in S} \delta(s, a, s') \cdot V(s') \\ & \quad (\text{By induction hypothesis.}) \\ & \geq \min_{a \in \text{Av}(s)} \sum_{s' \in S} \delta(s, a, s') \cdot V(s') \\ & = V(s) \\ & \quad (\text{By definition of } V.) \end{aligned}$$

The other inequality for the lower bound on the value $V(s)$ can be obtained dually. Therefore, we get the following inequality, for all $k \in \mathbb{N}$:

$$\mathcal{P}_s^{\sigma_k, \tau_k}(\diamond^{\leq k} \mathbf{F}) + \mathcal{P}_s^{\sigma_k, \tau_k}(\square^{\leq k} \mathbf{S}^?) \cdot \mathbf{l} \leq \mathbf{V}(s) \leq \mathcal{P}_s^{\sigma_k, \tau_k}(\diamond^{\leq k} \mathbf{F}) + \mathcal{P}_s^{\sigma_k, \tau_k}(\square^{\leq k} \mathbf{S}^?) \cdot \mathbf{u}$$

◀

► **Lemma 19.** *After executing $k \in \mathbb{N}_0$ iterations of Alg. 1, the following holds for all $s \in \mathbf{S}^?$:*

1. $\text{reach}_s^k = \mathcal{P}_s^{\sigma_k, \tau_k}(\diamond^{\leq k} \mathbf{F})$
2. $\text{stay}_s^k = \mathcal{P}_s^{\sigma_k, \tau_k}(\square^{\leq k} \mathbf{S}^?)$
3. $\mathbf{l}_k \leq \mathbf{V}(s) \leq \mathbf{u}_k$ and $\mathbf{l}_k \leq \mathcal{P}_s^{\sigma_k, \tau_k}(\diamond \mathbf{F}) \leq \mathbf{u}_k$

Proof. We prove it by the induction on the number of iterations, k and the case distinction on the type of the states.

Base case: When $k = 0$, σ_0, τ_0 are arbitrary. The claim holds as per our initializations:

$$\begin{aligned} \text{reach}_s^0 &= 1, \forall s \in \mathbf{F} \\ \text{stay}_s^0 &= 1, \forall s \in \mathbf{S}^? \\ \text{reach}_s^0 &= 0, \forall s \in \mathbf{S} \setminus \mathbf{F} \\ \text{stay}_s^0 &= 1, \forall s \in \mathbf{S} \setminus \mathbf{S}^? \end{aligned}$$

Induction hypothesis: We assume that the claim holds after k iterations, and the strategies for Maximizer and Minimizer are σ_k, τ_k at this point. Formally,

$$\begin{aligned} \text{reach}_s^k &= \mathcal{P}_s^{\sigma_k, \tau_k}(\diamond^{\leq k} \mathbf{F}) \\ \text{stay}_s^k &= \mathcal{P}_s^{\sigma_k, \tau_k}(\square^{\leq k} \mathbf{F}) \end{aligned}$$

Inductive step: In iteration $k + 1$, the strategies σ_{k+1}, τ_{k+1} for every state, are updated based on the $\text{reach}_s^k, \text{stay}_s^k, \mathbf{l}_k, \mathbf{u}_k$. Let's assume that the optimal strategy for state s is to play the action α , according to the current values. After playing α in state s , it mimics the strategy σ_k, τ_k from the successor states. Formally,

$$\begin{aligned} \text{reach}_s^{k+1} &= \delta(s, \alpha, s') \cdot \sum \text{reach}_{s'}^k && \text{(Line 10 of Alg. 1 and Eq. (9).)} \\ &= \delta(s, \alpha, s') \cdot \sum \mathcal{P}_{s'}^{\sigma_k, \tau_k}(\diamond^{\leq k} \mathbf{F}) && \text{(By induction hypothesis.)} \\ &= \mathcal{P}_s^{\sigma_{k+1}, \tau_{k+1}}(\diamond^{\leq k+1} \mathbf{F}) && \text{(By assumption that playing } \alpha \text{ is correct)} \end{aligned}$$

The proof for stay_s^k is dual. Now, we prove that playing α is an optimal choice by case distinction on the type of states. Note that we are in the assumption that there is no ECs in \mathcal{G} . Let $f(s) = \text{reach}_s + \text{stay}_s \cdot \mathbf{u}$.

■ $s \in \mathbf{S}_\Delta$,

$$\begin{aligned} f(s, \alpha) &\geq f(s, \beta), \forall \beta \in \text{Av}(s) \setminus \{\alpha\} \\ &\Rightarrow \alpha \text{ is a optimal action to play according to } f \end{aligned}$$

An optimal action α based on the current upper bounds \mathbf{u}_k (see Eq. (5)).

■ $s \in \mathbf{S}_\nabla$,

$$\begin{aligned} f(s, \alpha) &\leq f(s, \beta), \forall \beta \in \text{Av}(s) \setminus \{\alpha\} \\ &\Rightarrow \alpha \text{ is a optimal action to play according to } f \end{aligned}$$

An optimal action α based on the current lower bounds \mathbf{l}_k (see Eq. (5)).

23:32 Sound Value Iteration for Simple Stochastic Games

These cases prove that α is an optimal action to play. Therefore, for all $k \in \mathbb{N}$ and for all states in $S^?$, reach_s^k is the k -step probability to reach the targets and stay_s^k is the probability to stay in $S^?$. This concludes the proof of 1, 2.

It remains to prove that u_k, l_k are correct. We proved that separately in Lem. 15. ◀

► **Theorem 7.** Fix an SG \mathcal{G} that contains no ECs, with its state space partitioned in F , Z and $S^?$, and fix a precision $\varepsilon > 0$. Alg. 1 is correct and terminates with an ε -close approximation to the value V' , i.e. for all $s \in S^?$, $|V'(s) - V(s)| \leq \varepsilon$.

Proof. Correctness. In Lem. 19, we prove that Alg. 1 computes the stepbounds $\mathcal{P}_s^{\sigma_k, \tau_k}(\diamond^{\leq k} F)$ and $\mathcal{P}_s^{\sigma_k, \tau_k}(\square^{\leq k} S^?)$, as well as bounds l_k and u_k that are aligned with Lem. 18 and 15. Then, correctness directly follows from Thm. 5.

► **Remark 20.** Note that we also give a simpler proof of this theorem with static l and u in Lem. 18 which shows that core of the difficulty is in updating the bounds which make this proof much more involved.

Termination. Any play of an MDP or SG, independent of the strategies, eventually remains inside a single MEC with probability one [9]. Under the assumption that SG does not contain an EC in $S^?$, we have $\lim_{k \rightarrow \infty} \mathcal{P}_s^{\sigma_k, \tau_k}(\square^{\leq k} S^?) = 0$. This implies that $V(s) = \lim_{k \rightarrow \infty} \mathcal{P}_s^{\sigma_k, \tau_k}(\diamond^{\leq k} F)$. ◀

B Additional details for Section 4

B.1 Examples of Section 4

- Although SVI maintains an over-approximation u , it is a global bound for all states and thus cannot be used to locally deflate the value of some states.
 - ▶ **Example 21.** Consider the SG in Fig. 8. We have $S^? = \{s_0, s_1, s_2\}$. s_2 is an initial state. The set of states $X = \{s_0, s_1\}$ form a simple end-component (SEC). We analyze the best exit $\text{bexit}^\Delta(T) = \{(s_0, b), (s_1, b)\}$ and find out that the possible global upper bound u for the SEC X is 0.5. However, as s_2 is not part of the SEC X , we can not reduce the upper bound of s_2 (because in general s_2 might have another action which could result in a better value). This implies that deflating the global upper bound is not enough.

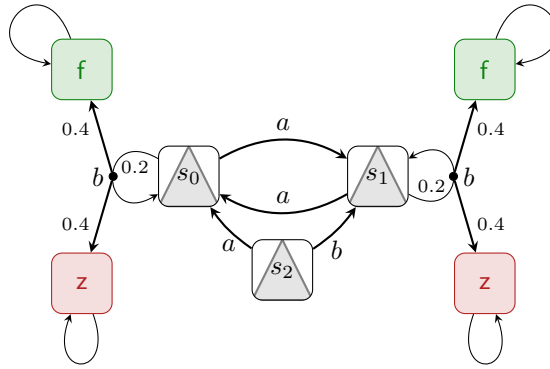

■ **Figure 8** SG with 3 maximizer nodes, self-loops, and a 2-state SEC

This brings us to the next natural fix, where we also update the values of **reach** and **stay**. In the subsequent point, we show that deflating the whole SEC by updating the values of **reach** and **stay** is also problematic.

- SVI maintains **reach** and **stay**, from which over-approximation is derived. However, since the over-approximation depends on both variables, the same over-approximation can correspond to different pairs of these values. Consequently, when deflating a state, it is unclear to which pair of values to deflate; moreover, there may not even exist any choice that works correctly for the whole EC (or SEC).
 - ▶ **Example 22.** Consider the SG of Fig. 9 (left). For all states s in $S^? = \{s_0, s_1, s_2\}$, Algorithm 1 is stuck with $\text{reach}_s = 0$, $\text{stay}_s = 1$, and $l = 0$, $u = 1$, yielding an over-approximation $\text{reach}_s + \text{stay}_s \cdot u = 1$. As the SECs based on the under-approximations $(\text{reach}_s + \text{stay}_s \cdot u)$, the entire set $S^?$ is identified as a SEC candidate which is correct wrt to initial approximations but not an actual SEC wrt the correct values. Let's call this set T . Observe that the best exit $\text{bexit}^\Delta(T) = \{(s_2, c')\}$ gives **reach** of 0.6 and **stay** of 0 and the true value of s_2 being 0.6. Deflating the over-approximation in all the three states s_0, s_1, s_2 in the EC to 0.6 would be correct; however, achieving that via setting reach_{s_1} to 0.6 would be incorrect since **reach** must be an under-approximation of the reachability probability, hence at most 0.4 for s_1 . Therefore, we proceed to the next intuitive solution where we update only the best exit. In what follows, we show that deflating only the best exist is also problematic.

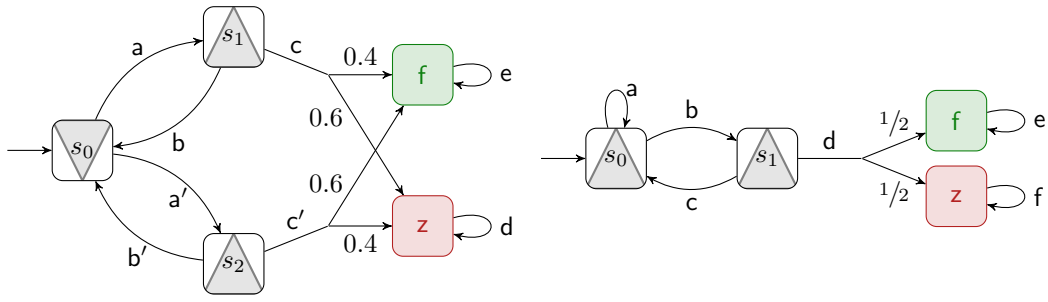

■ **Figure 9** SG where deflating cannot be easily applied to fix SVI

- Deflating only the best exit states of a SEC may result in non-convergence of the other states within the SEC.

► **Example 23.** Consider the SG of Fig. 9 (right). The SEC $\{s_0, s_1\}$ has the best exit (s_1, d) . Deflating the over-approximation of state s_1 (to the value 0.5) sets reach_{s_1} to 0.5 and stay_{s_1} to 0. However, in this case, the same deflating should also be applied to s_0 ! Otherwise, due to a , we are left with $\text{reach}_{s_0} = 0$, $\text{stay}_{s_0} = 1$ and an over-approximation 1, not converging to the true $1/2$.

To summarize, we can not deflate the entire SEC to the best exit of SEC because we might wrongly increase the reach of a Minimizer state that may lead to incorrect results; and, we can not only deflate the bexit_f^Δ as it may lead to non-termination. Note that last examples used in this subsection are in fact MDP, showing that the problem is not because of games, but end components.

B.2 Detailed Algorithm of Section 4

■ **Algorithm 6** Compute best exit set for the sound value iteration

Input: SG \mathcal{G} , reach , stay , f , EC Y

Output: Set of pairs of best exit states and actions of ECs

```

1: procedure BESTEXITSET( $\mathcal{G}, f, Y$ )
2:    $BES \leftarrow \emptyset$ 
3:   if  $\text{bexit}_f^\Delta(Y) = \emptyset$  then                                     ▷  $\text{bexit}_f^\Delta(Y)$  is empty
4:      $Z = Z \cup Y$                                                  ▷ Add all the states of  $Y$  to  $Z$ 
5:      $S^? = S^? \setminus Y$                                            ▷ Remove all the states of  $Y$  from  $S^?$ 
6:     return  $BES$ 
7:   else                                                         ▷  $\text{bexit}_f^\Delta(Y)$  is non-empty
8:      $BES = BES \cup \text{bexit}_f^\Delta(Y)$                                    ▷ Add all best exits to  $BES$ 
9:      $E = \{s \mid (s, a) \in \text{bexit}_f^\Delta(Y)\}$ 
10:    for  $M \in \text{FINDMECS}(\mathcal{G}, Y \setminus E)$  do
11:       $BES = BES \cup \text{BESTEXITSET}(\mathcal{G}, f, M)$ 
12:    return  $BES$                                                  ▷ Set with best exits wrt  $f$  for all the relevant ECs
    
```

The procedure `BESTEXITSET` is shown in Alg. 6. It takes three inputs, an SG \mathcal{G} , a function $f \geq V$, and an EC Y . It first finds the set of best exits of the input EC. If there is no Maximizer exit (Lines 3-6), this implies that all the states in this EC are **trap** for Maximizer as minimizer can force the play in this EC forever, therefore, all the states can be included

to sink states set Z and removed from unknown states set $S^?$ (Lines 4, 5). Otherwise, all the best exit pairs are added to a set BES (Line 8). In Line 9, computes the set E of states the corresponds to $\text{bexit}_f^\Delta(Y)$. After removing all the states of E from EC Y , the procedure is recursively called on all the MECs of induced graph (Lines 10, 11). Finally, Line 12, returns exits for all the relevant ECs that are correct over-approximation of the value V . This procedure is called as a subroutine for HANDLEECs in Line 4 of Alg. 3.

In particular, HANDLEECs computes exits of ECs \mathcal{G} by considering all of its MECs as shown in Eq. (22) below.

$$\text{HANDLEECs}(\mathcal{G}, \text{reach}, \text{stay}, u) = \bigcup_{\substack{Y \subseteq S^? \\ Y \text{ is an MEC}}} \text{BESTEXITSET}(\mathcal{G}, \text{reach}_s^k + \text{stay}_s^k \cdot u_k, Y) \quad (22)$$

■ **Algorithm 7** Find action computation for SG

```

1: procedure FINDACTION( $\text{reach}^k, \text{stay}^k, l, u, s, \mathfrak{B}^k$ )
2:    $E_a = \{b \mid (s, b) \in \mathfrak{B}^k\}$ 
3:   if  $E_a \neq \emptyset$  then
4:     return  $E_a$ 
5:   if  $s \in S_\Delta$  then
6:     return  $\arg \max_{\alpha \in \text{Act}(s)} \sum_{s' \in S} \delta(s, \alpha, s') \cdot (\text{reach}_{s'}^k + \text{stay}_{s'}^k \cdot u)$ 
7:   else
8:     return  $\arg \min_{\alpha \in \text{Act}(s)} \sum_{s' \in S} \delta(s, \alpha, s') \cdot (\text{reach}_{s'}^k + \text{stay}_{s'}^k \cdot l)$ 

```

B.3 Proofs of Section 4

► **Lemma 24.** *Given an SG \mathcal{G} , an EC $Y \subset S^?$, and any $f : S \rightarrow [0, 1]$ with $f \geq V$. If $\text{bexit}_V^\Delta(Y) = (s_V, a_V)$ and $\text{bexit}_f^\Delta(Y) = (s_f, a_f)$, then for all $s \in Y : V(s) \leq f(s_f, a_f)$.*

Proof. We prove it following three steps:

1. $\forall s \in Y : V(s) \leq V(s_V, a_V)$
2. $V(s_V, a_V) \leq f(s_V, a_V)$
3. $f(s_V, a_V) \leq f(s_f, a_f)$

1. To prove 1, we do case split on the Maximizer and Minimizer states.

- a. $s \in Y_\nabla$: Let's assume a Minimizer state with the maximum value in EC is $s_V^{\nabla \max}$.
 - $(s_V^{\nabla \max}, a_{\text{opt}})$ leaves EC: This implies that staying gives higher value. The path that leads to the target via EC can either exit the EC by Minimizer states or Maximizer states. If all of the states are Minimizer states, they can't achieve a higher value than the leaving action as we assumed that this Minimizer state has maximum value in the EC. Therefore, atleast one state has to be Maximizer state to have an increase in the summand. However, as (s_V, a_V) is a $\text{bexit}_V^\Delta(Y)$, the value of $(s_V^{\nabla \max}, a)$ for any staying action can not achieve higher than $V(s_V, a_V)$. As leaving gives even smaller value, it's concluded that $(s_V^{\nabla \max}, a_{\text{opt}}) < V(s_V, a_V)$.
 - $(s_V^{\nabla \max}, a_{\text{opt}})$ stays in EC: this is included in the previous case.

This implies that $\forall s \in Y_\nabla : V(s) \leq V(s_V, a_V)$.

- b. $s \in Y_\Delta$: To reach the target, this state must follow a path that leaves EC. However, any path that leads to EC can not achieve higher value than the $\text{bexit}_V^\Delta(Y)$. This implies that $\forall s \in Y_\Delta : V(s) \leq V(s_V, a_V)$.

23:36 Sound Value Iteration for Simple Stochastic Games

Combining (a) and (b), we get that $\forall s \in Y : V(s) \leq V(s_V, a_V)$, which concludes the step 1.

2. Step 2 holds because $f \geq V$.
3. Step 3 holds because $(s_f, a_f) \in \text{bexit}_f^\Delta(Y)$. If $f(s_V, a_V) > f(s_f, a_f)$ then $(s_f, a_f) \notin \text{bexit}_f^\Delta(Y)$.

Combining 1, 2, and 3 we get $\forall s \in Y : V(s) \leq f(s_f, a_f)$. ◀

► **Lemma 9.** *Algorithm 2 BESTEXITSET on all MECs with respect to $f \geq V$ terminates and returns a set BES that has the following two properties.*

1. for all $(s, a) \in \text{BES} : f(s, a) \geq V(s)$
2. for all EC T :
 - $T \notin \text{trap} \Rightarrow \exists (s, a) \in \text{BES} : (s, a) \text{ exits } T$
 - $(T \in \text{trap} \wedge s \in T) \Rightarrow s \in Z \wedge s \notin S^?$

(Writing $(s, a) \text{ exits } T$ to denote that $\text{Post}(s, a) \not\subseteq T$)

Proof. Correctness. The procedure BESTEXITSET initially takes a MEC Y as argument and then recursively being called on all the MECs of induced subgraph contained in $Y \setminus \text{bexit}_f^\Delta(Y)$.

1. To prove 1, we use the arguments on the structure of the game graph for every (s, a) pair in BES.
 - Any pair (s, a) is only inserted in Line 8. For (s, a) inserted in BES there exists an EC Y , such that $(s, a) \in \text{bexit}_f^\Delta(Y)$ (Lines 7-8). This implies that $\forall s_y \in Y : f(s, a) \geq V(s_y)$ (by Lem. 24). This further implies that $f(s, a) \geq V(s)$ (because $s \in Y$).

2. We prove the first point of 2 by contradiction.

For the sake of contradiction, we assume that there is no exit of T that belongs to the set BES. Formally, $\exists \text{EC } T : \forall (s, a) \in \text{BES}, s \notin T$. Let's assume that the procedure initially was called on a MEC $Y \supset T$ and before the termination there were p number of procedure calls. Then there exists $1 \leq i \leq p$ and an EC Z such that $T \subset Z$ and $(s, a) \in \text{bexit}_f^\Delta(Z)$ and $T \not\subseteq Z \setminus \{s\}$. This implies that (s, a) also exits T i.e. $\text{Post}(s, a) \not\subseteq T$. Which is a contradiction to our assumption that no exit of EC T belongs to BES. This implies that during i -th procedure call the state s was removed, which implies that the EC could not be considered because of the removal of the best exit of the EC Z .

The second point of 2, directly follows from the the Lines 3-5 of Alg. 2 where we define *trap* in the description of Alg. 2

Termination. After every procedure call, the total of states being considered strictly less than the previous call (atleast one state is removed, see Line 8 of Alg. 6). As the number of states in $S^?$ is finite, say n , there will atmost n procedure calls to the BESTEXITSET. ◀

► **Theorem 10.** *Fix an SG \mathcal{G} with its state space partitioned in F, Z and $S^?$. Let $l_k, u_k \in \mathbb{R}$ be bounds as defined by Eq. (6), i.e. for all $k \geq 0, l_k \leq V(s) \leq u_k$ for all $s \in S^?$. For $\sigma_k \in \Sigma_\Delta$ and $\tau_k \in \Sigma_\nabla$ defined as in equations (14) and (5), respectively, the following inequality holds:*

$$\mathcal{P}_s^{\sigma_k, \tau_k}(\diamond^{\leq k} F) + \mathcal{P}_s^{\sigma_k, \tau_k}(\square^{\leq k} S^?) \cdot l_k \leq V(s) \leq \mathcal{P}_s^{\sigma_k, \tau_k}(\diamond^{\leq k} F) + \mathcal{P}_s^{\sigma_k, \tau_k}(\square^{\leq k} S^?) \cdot u_k$$

Proof. We need to extend the proof of Thm. 5 by considering two additional cases for the “special” Maximizer-states defined in Eq. (14) for which the actions are played accordingly.

We need to argue the following two cases:

- $\sigma_{k+1}(s) := b$ is still optimal if $(s, b) \in \mathfrak{B}^{k+1}$
- $\sigma_{k+1}(s) := d$ does not hurt the correctness and is optimal to play according to the current approximations.

In particular, Arg. 1 in Lem. 18 will need to include the above two additional cases regarding the optimality of $\sigma_{k+1}(s)$.

Case 1. This case works directly using the definition of best exit as it is an optimal leaving action.

Case 2. This case is more involved. $\sigma_{k+1}(s) = d$ means that now we are constructing from SG \mathcal{G} a new SG \mathcal{G}' with self loop added to some of the Maximizer states where a delay action was recommended. It is easy to prove that the value of an SG \mathcal{G}' with added self-loops in Maximizer states is same as the value in \mathcal{G} .

The rest of the proof is same as the proof of Thm. 5. ◀

► **Remark 25.** In iterations $k + 1$, where case $\sigma_{k+1}(s) := b$ satisfies, we update the global bound as $\mathbf{u}_{k+1} := \text{reach}_s^k + \text{stay}_s^k \cdot \mathbf{u}_k$ under the condition 15. This conservative update is correct as none of the states can achieve an upper bound higher than \mathbf{u}_{k+1}

► **Lemma 12.** Fix \mathbf{u}, \mathbf{l} such that $\mathbf{l} \leq \mathbf{V}(s) \leq \mathbf{u}$. Alg. 1 instantiated with Maximizer's strategy using Eq. (14), and UPDATEGLOBALBOUNDS? in (15) computes a monotonically non-increasing sequence of $\mathcal{P}_s^{\sigma_k, \tau_k}(\diamond^{\leq k} \mathbf{F}) + \mathcal{P}_s^{\sigma_k, \tau_k}(\square^{\leq k} \mathbf{S}^?) \cdot \mathbf{u}$, i.e.

$$\mathcal{P}_s^{\sigma_{k+1}, \tau_{k+1}}(\diamond^{\leq k+1} \mathbf{F}) + \mathcal{P}_s^{\sigma_{k+1}, \tau_{k+1}}(\square^{\leq k+1} \mathbf{S}^?) \cdot \mathbf{u} \leq \mathcal{P}_s^{\sigma_k, \tau_k}(\diamond^{\leq k} \mathbf{F}) + \mathcal{P}_s^{\sigma_k, \tau_k}(\square^{\leq k} \mathbf{S}^?) \cdot \mathbf{u}$$

Proof. We prove it by case split and use induction.

Base case: For $k = 0$, the inequality holds trivially, because

$$\mathcal{P}_s^{\sigma_0, \tau_0}(\diamond^{\leq 0} \mathbf{F}) + \mathcal{P}_s^{\sigma_0, \tau_0}(\square^{\leq 0} \mathbf{S}^?) \cdot \mathbf{u} = 1$$

Induction hypothesis:

$$\mathcal{P}_s^{\sigma_k, \tau_k}(\diamond^{\leq k} \mathbf{F}) + \mathcal{P}_s^{\sigma_k, \tau_k}(\square^{\leq k} \mathbf{S}^?) \cdot \mathbf{u} \leq \mathcal{P}_s^{\sigma_{k-1}, \tau_{k-1}}(\diamond^{\leq k-1} \mathbf{F}) + \mathcal{P}_s^{\sigma_{k-1}, \tau_{k-1}}(\square^{\leq k-1} \mathbf{S}^?) \cdot \mathbf{u}$$

Induction step:

Case 1: Actions do not change. This case is easy. Using simple induction works for both Minimizer and Maximizer states.

$$\begin{aligned} & \mathcal{P}_s^{\sigma_{k+1}, \tau_{k+1}}(\diamond^{\leq k+1} \mathbf{F}) + \mathcal{P}_s^{\sigma_{k+1}, \tau_{k+1}}(\square^{\leq k+1} \mathbf{S}^?) \cdot \mathbf{u} \\ &= \sum_{s' \in \mathcal{S}} \delta(s, a, s') \cdot [\mathcal{P}_{s'}^{\sigma_k, \tau_k}(\diamond^{\leq k} \mathbf{F}) + \mathcal{P}_{s'}^{\sigma_k, \tau_k}(\square^{\leq k} \mathbf{S}^?) \cdot \mathbf{u}] && \text{(By unfolding one step.)} \\ &\leq \sum_{s' \in \mathcal{S}} \delta(s, a, s') \cdot [\mathcal{P}_{s'}^{\sigma_{k-1}, \tau_{k-1}}(\diamond^{\leq k-1} \mathbf{F}) + \mathcal{P}_{s'}^{\sigma_{k-1}, \tau_{k-1}}(\square^{\leq k-1} \mathbf{S}^?) \cdot \mathbf{u}] && \text{(By induction hypothesis.)} \\ &\leq \mathcal{P}_s^{\sigma_k, \tau_k}(\diamond^{\leq k} \mathbf{F}) + \mathcal{P}_s^{\sigma_k, \tau_k}(\square^{\leq k} \mathbf{S}^?) \cdot \mathbf{u} && \text{(By reversing the unfolding.)} \end{aligned}$$

Case 2: Actions do change. This is the interesting case.

1. $s \in \mathcal{S}_\Delta$: The following three cases are possible as per Maximizer's strategy.

- a. Best exit state, i.e. $(s, b) \in \mathfrak{B}^{k+1}$. This implies that s is part of an end component. There are two possible cases.
 - i. $(s, a_{old}) \in \mathfrak{B}^k$.

- $\text{DELAYACTION?}(s)$.

$$\begin{aligned}
 & \mathcal{P}_s^{\sigma_{k+1}, \tau_{k+1}}(\diamond^{\leq k+1} \mathbf{F}) + \mathcal{P}_s^{\sigma_{k+1}, \tau_{k+1}}(\square^{\leq k+1} \mathbf{S}^?) \cdot \mathbf{u} \\
 = & \delta(s, d, s) \cdot [\mathcal{P}_s^{\sigma_k, \tau_k}(\diamond^{\leq k} \mathbf{F}) + \mathcal{P}_s^{\sigma_k, \tau_k}(\square^{\leq k} \mathbf{S}^?) \cdot \mathbf{u}] \\
 & \hspace{10em} (\text{By unfolding one step for delay self-loop.}) \\
 \leq & \mathcal{P}_s^{\sigma_k, \tau_k}(\diamond^{\leq k} \mathbf{F}) + \mathcal{P}_s^{\sigma_k, \tau_k}(\square^{\leq k} \mathbf{S}^?) \cdot \mathbf{u} \quad (\delta(s, d, s) = 1)
 \end{aligned}$$

- $\neg \text{DELAYACTION?}(s)$. This implies that there exists an EC T such that $\text{bexit}_{f_k}^\Delta(T) = (s, a_{old})$ and $\forall a \in \text{Av}(s) \setminus \{a_{old}\} : f_k(s, a) \leq f_k(s, a_{old})$

$$\begin{aligned}
 & \mathcal{P}_s^{\sigma_{k+1}, \tau_{k+1}}(\diamond^{\leq k+1} \mathbf{F}) + \mathcal{P}_s^{\sigma_{k+1}, \tau_{k+1}}(\square^{\leq k+1} \mathbf{S}^?) \cdot \mathbf{u} \\
 = & \delta(s, b, s') \cdot [\mathcal{P}_{s'}^{\sigma_k, \tau_k}(\diamond^{\leq k} \mathbf{F}) + \mathcal{P}_{s'}^{\sigma_k, \tau_k}(\square^{\leq k} \mathbf{S}^?) \cdot \mathbf{u}] \quad (\text{By unfolding one step.}) \\
 \leq & \delta(s, b, s') \cdot [\mathcal{P}_{s'}^{\sigma_{k-1}, \tau_{k-1}}(\diamond^{\leq k-1} \mathbf{F}) + \mathcal{P}_{s'}^{\sigma_{k-1}, \tau_{k-1}}(\square^{\leq k-1} \mathbf{S}^?) \cdot \mathbf{u}] \\
 & \hspace{10em} (\text{By induction hypothesis.}) \\
 \leq & \delta(s, a_{old}, s') \cdot [\mathcal{P}_{s'}^{\sigma_{k-1}, \tau_{k-1}}(\diamond^{\leq k-1} \mathbf{F}) + \mathcal{P}_{s'}^{\sigma_{k-1}, \tau_{k-1}}(\square^{\leq k-1} \mathbf{S}^?) \cdot \mathbf{u}] \\
 & \hspace{10em} (\text{By assumption}) \\
 \leq & \mathcal{P}_s^{\sigma_k, \tau_k}(\diamond^{\leq k} \mathbf{F}) + \mathcal{P}_s^{\sigma_k, \tau_k}(\square^{\leq k} \mathbf{S}^?) \cdot \mathbf{u} \quad (\text{By reversing the unfolding.})
 \end{aligned}$$

- ii. $(s, a_{old}) \notin \mathfrak{B}^k$.

- a_{old} was not the delay action, i.e. $a_{old} \neq d$. This implies the a_{old} was best as per **reach** + **stay** · \mathbf{u} in k steps.

$$\begin{aligned}
 & \mathcal{P}_s^{\sigma_{k+1}, \tau_{k+1}}(\diamond^{\leq k+1} \mathbf{F}) + \mathcal{P}_s^{\sigma_{k+1}, \tau_{k+1}}(\square^{\leq k+1} \mathbf{S}^?) \cdot \mathbf{u} \\
 = & \delta(s, b, s') \cdot [\mathcal{P}_{s'}^{\sigma_k, \tau_k}(\diamond^{\leq k} \mathbf{F}) + \mathcal{P}_{s'}^{\sigma_k, \tau_k}(\square^{\leq k} \mathbf{S}^?) \cdot \mathbf{u}] \\
 & \hspace{10em} (\text{By definition and if } (s, b) \in \mathfrak{B}^{k+1}.) \\
 \leq & \delta(s, b, s') \cdot [\mathcal{P}_{s'}^{\sigma_{k-1}, \tau_{k-1}}(\diamond^{\leq k-1} \mathbf{F}) + \mathcal{P}_{s'}^{\sigma_{k-1}, \tau_{k-1}}(\square^{\leq k-1} \mathbf{S}^?) \cdot \mathbf{u}] \\
 & \hspace{10em} (\text{By induction hypothesis.}) \\
 \leq & \delta(s, a_{old}, s') \cdot [\mathcal{P}_{s'}^{\sigma_{k-1}, \tau_{k-1}}(\diamond^{\leq k-1} \mathbf{F}) + \mathcal{P}_{s'}^{\sigma_{k-1}, \tau_{k-1}}(\square^{\leq k-1} \mathbf{S}^?) \cdot \mathbf{u}] \\
 & \hspace{10em} (a_{old} \text{ was the best action.}) \\
 \leq & \mathcal{P}_s^{\sigma_k, \tau_k}(\diamond^{\leq k} \mathbf{F}) + \mathcal{P}_s^{\sigma_k, \tau_k}(\square^{\leq k} \mathbf{S}^?) \cdot \mathbf{u} \quad (\text{By definition.})
 \end{aligned}$$

- a_{old} was the delay action. This implies that it's a Maximizer state. This means that the condition of $\text{IMPROVEDUB}(s)^\text{?}$ is satisfied as the actions are changed.

- b. \mathbf{Y} is a MEC with $s \in \mathbf{Y}$ and $s \notin \mathfrak{B}$. This means that either it will play delay self-loop or it will decrease the value (condition of $\text{IMPROVEDUB}(s)^\text{?}$).
- c. Action picked according to **reach** $_s^k$ + **stay** $_s^k$ · \mathbf{u}
 - If s is in an EC. This implies that it is also in a MEC. Then it will either be in \mathfrak{B} or not. This is covered in the above two cases.
 - If s is not in an EC. In this case, if switching to a new action gives a higher value, the old action would not have been picked in the last iteration.

- 2. $s \in \mathbf{S}_\nabla$: Picking action by minimising **reach** $_s^k$ + **stay** $_s^k$ · \mathbf{l} . By induction hypothesis, every action has reduced its value. Picking minimum implies that the approximation will either become lower or stays the same.



► **Lemma 26.** (*Upper bound converges to a fixpoint*). Let $U_i(s) = \text{reach}_s^i + \text{stay}_s^i \cdot u$. The limit of repeatedly applying the modified Bellman operator \mathcal{B} to the initial upper bound U_0 exists and is a fixpoint of the operator \mathcal{B} , i.e.,

$$\lim_{i \rightarrow \infty} \mathcal{B}^i U_0 = \mathcal{B} \left(\lim_{i \rightarrow \infty} \mathcal{B}^i U_0 \right).$$

Proof. We aim to show that repeatedly applying the modified Bellman operator \mathcal{B} to the initial upper bound U_0 converges to a fixpoint, i.e.,

$$\lim_{i \rightarrow \infty} \mathcal{B}^i U_0 = \mathcal{B} \left(\lim_{i \rightarrow \infty} \mathcal{B}^i U_0 \right).$$

Step 1: Monotonicity of the modified Bellman operator.

The modified Bellman operator \mathcal{B} inherits the monotonicity property of standard Bellman operators. Please refer to Lemma 12 for a proof of monotonic sequence of upperbounds U_i . Formally, if $U_1 \leq U_2$, then:

$$\mathcal{B}(U_1) \leq \mathcal{B}(U_2).$$

In this case, starting from an initial over-approximation U_0 , the sequence of iterates $\{\mathcal{B}^i U_0\}_{i=0}^{\infty}$ is monotonically non-increasing:

$$U_0 \geq \mathcal{B}U_0 \geq \mathcal{B}^2 U_0 \geq \dots$$

Since this sequence is bounded in the interval $[V(s), 1]$, it converges to a limit U^* , where:

$$U^* = \lim_{i \rightarrow \infty} \mathcal{B}^i U_0.$$

Step 2: Continuity of the modified Bellman operator.

We now address the potential sources of discontinuity in the modified Bellman operator \mathcal{B} , specifically related to the choices of strategy σ_{k+1} .

Case (a): Strategy Chooses the Best Exit.

When the strategy σ_{k+1} chooses the best exit action b (as defined in Eq. (14)), there is no discontinuity. This is because the value function at the current state now depends on the values outside the EC, and these values evolve continuously. Hence, the update made by \mathcal{B} respects the continuity of the Bellman update.

Case (b): Strategy Chooses the Delay Action.

If the strategy σ_{k+1} chooses the delay action d , then the estimate U remains unchanged. Since there is no modification to the estimate, the operator \mathcal{B} does not introduce any discontinuity. The Bellman operator in this case remains stable, as it does not alter the values.

Thus, in both cases, the modified Bellman operator preserves continuity. This continuity ensures that for any convergent sequence $\{U_i\}$, we have:

$$\lim_{i \rightarrow \infty} \mathcal{B}(U_i) = \mathcal{B} \left(\lim_{i \rightarrow \infty} U_i \right).$$

Applying this to the sequence $\{\mathcal{B}^i U_0\}$, we get:

$$\lim_{i \rightarrow \infty} \mathcal{B}^{i+1} U_0 = \mathcal{B} \left(\lim_{i \rightarrow \infty} \mathcal{B}^i U_0 \right).$$

Since the limit of $\{\mathcal{B}^i U_0\}$ is U^* , this equation becomes:

$$U^* = \mathcal{B}(U^*),$$

which shows that U^* is a fixpoint of the modified Bellman operator.

Step 3: Convergence to the greatest fixpoint.

The sequence $\{\mathcal{B}^i U_0\}$ is non-increasing and bounded below. Since we are starting from an initial upper bound U_0 , repeated applications of the modified Bellman operator converge to the greatest fixpoint U^* , i.e., the largest value satisfying:

$$U^* = \mathcal{B}(U^*).$$

This occurs because \mathcal{B} monotonically reduces the approximations until the sequence eventually reaches the greatest fixpoint, at which further applications of \mathcal{B} leave the value unchanged. Therefore, the limit U^* is the greatest fixpoint of the modified Bellman operator.

Summary: 1) The sequence $\{\mathcal{B}^i U_0\}$ is monotonic and bounded below. 2) The modified Bellman operator \mathcal{B} is continuous, even with the choice of strategies, and the sequence converges to a fixpoint. 3) The limit of the sequence is the greatest fixpoint U^* .

Thus, we conclude that:

$$\lim_{i \rightarrow \infty} \mathcal{B}^i U_0 = \mathcal{B} \left(\lim_{i \rightarrow \infty} \mathcal{B}^i U_0 \right),$$

which completes the proof. \blacktriangleleft

► **Lemma 27.** Fix an SG \mathcal{G} with its state space partitioned in F , Z and $S^?$ and precision $\varepsilon > 0$. Alg. 1 with sub-procedures in Sec. 4 (Maximizer strategy (14), new BELLMAN-UPDATE (13) and ISUPDATEGLOBALBOUNDS? (15)) terminates and returns a vector V' that is ε -close to the value V of \mathcal{G} , i.e. for all $s \in S$: $V'(s) - V(s) \leq \varepsilon$.

Proof. The sequence $\text{reach}_s^k + \text{stay}_s^k \cdot u$ is monotonically non-increasing by Lemma 12, i.e.,

$$\text{reach}_s^{k+1} + \text{stay}_s^{k+1} \cdot u \leq \text{reach}_s^k + \text{stay}_s^k \cdot u. \quad (23)$$

Now, consider the sequence $U_k(s) := \text{reach}_s^k + \text{stay}_s^k \cdot u_k$. We have

$$\begin{aligned} U_{k+1}(s) &= \text{reach}_s^{k+1} + \text{stay}_s^{k+1} \cdot u_{k+1} \leq \text{reach}_s^{k+1} + \text{stay}_s^{k+1} \cdot u_k && \text{(Since } u_{k+1} \leq u_k) \\ &\leq \text{reach}_s^k + \text{stay}_s^k \cdot u_k && \text{(Using Eq. (23))} \\ &= U_k(s) && \text{(By definition of } U_k(s)) \\ U_{k+1}(s) &\leq U_k(s) \end{aligned}$$

Therefore, the sequence $U_k(s)$ is monotonically non-increasing.

Furthermore, $U_k(s)$ bounded in the interval $[V(s), 1]$. Therefore, $U_k(s)$ converges to a limit as $k \rightarrow \infty$. We denote this limit by $U^*(s)$, i.e. $U^*(s) := \lim_{k \rightarrow \infty} U_k(s)$ is well defined. Also, by Lemma 26, $U^*(s)$ is a fixpoint. We give a proof by contradiction that $U^* = V$.

Let us assume that $\exists s : U^*(s) - V(s) > 0$. With this assumption we define that there exists a set X of states where the difference between the value V and the fixpoint U^* is maximum. Formally, if $\Delta(s) = U^*(s) - V(s)$ and $m = \max_{s \in S} \Delta(s)$, then X is defined as follows.

$$X = \{s \mid U^*(s) - V(s) = m\}$$

Now, we argue that all the actions that have successors outside the set X have lower value. We overload the notation of $f(s)$ by $f(s, a)$ (e.g. $V(s)$ by $V(s, a)$ and stay_s by $\text{stay}(s, a)$). Formally, we give the following claim:

▷ Claim 28.

$$\forall s \in X \forall a \in \text{Av}(s) : \left(\text{Post}(s, a) \not\subseteq X \Rightarrow \Delta(s, a) < \Delta(s) \right)$$

The following chain of equations prove Claim 28.

$$\begin{aligned} \Delta(s, a) &= U^*(s, a) - V(s, a) && \text{(By definition of } \Delta.) \\ &= \sum_{s' \in S} \delta(s, a, s') \cdot \left(U^*(s') - V(s') \right) \\ &= \sum_{s' \in S} \delta(s, a, s') \cdot \Delta(s') && \text{(By definition.)} \\ &< \Delta(s) && (\exists \hat{s} \in \text{Post}(s, a) : \hat{s} \notin X, \text{ therefore, } \delta(\hat{s}) < m) \end{aligned}$$

As U^* is a fix-point, we have the following.

$$\begin{aligned} &\forall s \in S, \exists a \in \text{Av}(s) : U^*(s) = U^*(s, a) \\ \Rightarrow &\forall s \in X, \exists a \in \text{Av}(s) : U^*(s) = U^*(s, a) \\ \Rightarrow &\forall s \in X, \exists a : \text{Post}(s, a) \subseteq X && \text{(By Claim 28.)} \end{aligned}$$

Last implication shows that there exists a pair of strategies π of Maximizer and Minimizer, such that X is closed under probabilistic transitions in the Markov chain induced by π .

Now, we need to define the notion of *bottom MEC* in X which we adapted from [11]. In particular, it is an EC in X such that every successor of an action leaving the bottom MEC reaches a state outside of X with positive probability under all pairs of strategies. Using similar arguments as in Theorem 1 of [11], we can show that there exists an EC Y that is a bottom MEC in X .

As Y is a bottom MEC in X . There are two cases possible.

1. For all EC Z such that $Z \supseteq Y$ with $\text{bexit}_0^\Delta(Z) \neq \emptyset$. This implies that $\exists s \in Y : (s, a) \in \mathfrak{B} \wedge \text{Post}(s, a) \not\subseteq X$ (because Y is a bottom MEC in X).

We know that $\forall s \in S^?$, the actions in Alg. 1 are chosen according to Eq. (14) and (5).

This further implies that in the next iteration $U(s)$ will strictly decrease, which is a contradiction to the assumption that we have reached a fixpoint.

2. There exists an EC X such that $X \supseteq Y$ with $\text{bexit}_0^\Delta(X) = \emptyset$, i.e. X is **trap**. This implies that all the states of X are added to sinks Z (Line 4 of Alg. 2). This implies that for all states s in Z we $\text{reach}_s = 0$ and $\text{stay}_s = 0$. Which implies that $U^*(s) = 0$. This is contradiction to the assumption that $m > 0$.

This proves that the over-approximations converge to the value V .

We are not done yet; we also need to prove that the under-approximations converge to the value V .

For this we prove that when upper bound converges to the value, stay_s becomes 0 for all states s in S . Assume for contradiction that there exist a state p with $\text{stay}_p > 0$. Consider the set of all states Z , where the value of stay is maximum, i.e., $\forall s \in Z : \text{stay}_s = m$. For all (s, a) with $\text{Post}(s, a) \not\subseteq Z$, $\text{stay}(s, a) < m$. Therefore, Z is a closed subsystem, which again means we can find a bottom MEC using the same reasoning that we used before. As we know that a fixed point is reached for the over-approximation, and there is a closed subsystem without any target or sink state ($m = 0$ in this case). The value for all the state of this subsystem would be 0. This is a contradiction to the assumption that $m > 0$.

This implies that both lower and upper bound converges to the **reach** in the limit. ◀

23:42 Sound Value Iteration for Simple Stochastic Games

► **Lemma 29.** *After executing $k \in \mathbb{N}_0$ iterations of Alg. 1 instantiated with sub-procedures in Sec. 4 (Maximizer strategy (14), new BELLMAN-UPDATE (13) and ISUPDATEGLOBAL-BOUNDS? (15)), the following holds for all $s \in \mathcal{S}^?$:*

1. $\text{reach}_s^k = \mathcal{P}_s^{\sigma_k, \tau_k}(\diamond^{\leq k} \mathbf{F})$
2. $\text{stay}_s^k = \mathcal{P}_s^{\sigma_k, \tau_k}(\square^{\leq k} \mathcal{S}^?)$
3. $l_k \leq V(s) \leq u_k$ and $l_k \leq \mathcal{P}_s^{\sigma_k, \tau_k}(\diamond \mathbf{F}) \leq u_k$

Proof. We prove this lemma by induction. The case of $s \in \mathcal{S}_\nabla$ and $s \in \mathcal{S}_\Delta$ where actions being picked as in Eq. (5) is same as Lem. 19. We prove the remaining two cases of Maximizer here.

Let's assume that the set $X = \{s \mid (s, a) \in \mathfrak{B}\}$.

- $\text{DELAYACTION?}(s)$: This implies $\alpha := d$. If the algorithm plays the delay action for finitely many steps (say i times) and then leaves with an optimal action to play according to f , then, reach_s^k would be m (with $m \leq k$) steps optimal (see the proof of Thm. 10 in App. B.3 for details).
- $s \in X \wedge \neg \text{DELAYACTION?}(s)$: This implies that

$$\begin{aligned} & s \in \mathcal{S}_\Delta \text{ and } \exists \text{ an EC } T : \text{bexit}_f^\Delta(T) = (s, \alpha) && \text{(where } f = \text{reach} + \text{stay} \cdot \mathbf{u}) \\ \Rightarrow & \alpha \text{ is an optimal action to play according to } f && \text{(by Def. (3))} \end{aligned}$$

i.e., according to the current values of the approximations, playing the action α in state s is the best choice that leaves the EC (By definition of $\text{bexit}_f^\Delta(T)$).

The proof of point 3 comes directly from Lem. 15 as the updates to l_k and u_k now are more conservative. ◀

C Evaluation of prototype implementation of SVI

We extended PRISM-games [17] with our prototype implementation of SVI for SG. Our code is available at <https://anonymous.4open.science/r/Algorithms-For-Stochastic-Games-0140/>. For comparison we used the implementation of standard bounded value iteration (BVI) with deflating [11] in PRISM-games. For detailed comparison of algorithms for solving stochastic games such as value iteration (VI), optimistic VI (VI), quadric programming (QP), and strategy iteration (SI), please see a recent work [1].

C.1 Technical details

We ran our experiment on a Linux machine with 32GB RAM and Intel(R) Core(TM) i7-10750H 2.60GHz CPU with a timeout of 15 minutes and a memory limit of 5 GB. For all the experiments, we used a precision of $\varepsilon = 10^{-6}$.

C.2 Benchmarks

For our experiments, we included the following case-studies:

- All real benchmarks from [1] which subsumes case studies from [19].
- Along with the handcrafted models used in [20], we also included three examples that we used to get in-depth understanding of SVI.
- We picked all MDP benchmarks with a reachability objective from the quantitative verification benchmark set (QVBS) [15].

C.3 Algorithm comparison

We compare the number of iterations for statistics, as the strength of SVI lies in obtaining good global bounds and resolving probabilistic loops faster. It is crucial to note that our evaluation does not prioritize time comparison. This is because of the preliminary nature of our prototype implementation, which does not emphasize a well-engineered BES computation. While BVI needs to identify the complex structure within ECs, SVI requires involved MEC decompositions. Therefore, we anticipate that the overhead would be negligible for a well engineered implementation.

How to read our results? We use scatter plots for comparison of SVI with BVI [11]. A point on a scatter plot shows comparison of two algorithms shown on X- and Y-axis. A point above the diagonal indicates that the algorithm on X-axis is faster, a point below the diagonal shows that the algorithm on Y-axis is faster, and a point on the diagonal means both algorithms take the same number of iterations.

Fig. 10 presents scatter plots that compare the number of iterations required by SVI and BVI for real and hand crafted models. The X-axis represents SVI, and the Y-axis represents BVI. The iteration ranges shown on the plots indicate that all the benchmarks represented comparison points for all benchmarks with iterations within the indicated range.

- *How does SVI compare to BVI on SG benchmarks?* - We experimented on 40 instances of real and handcrafted models. The plots reveal that for some benchmarks, SVI requires fewer iterations than BVI. However, in other cases, BVI takes fewer iterations.
 - On 10 out of 40 instances SVI outperforms BVI, 10 out of 40 instances BVI is better than SVI, and on 20 instances, both the algorithms are equally good.

23:44 Sound Value Iteration for Simple Stochastic Games

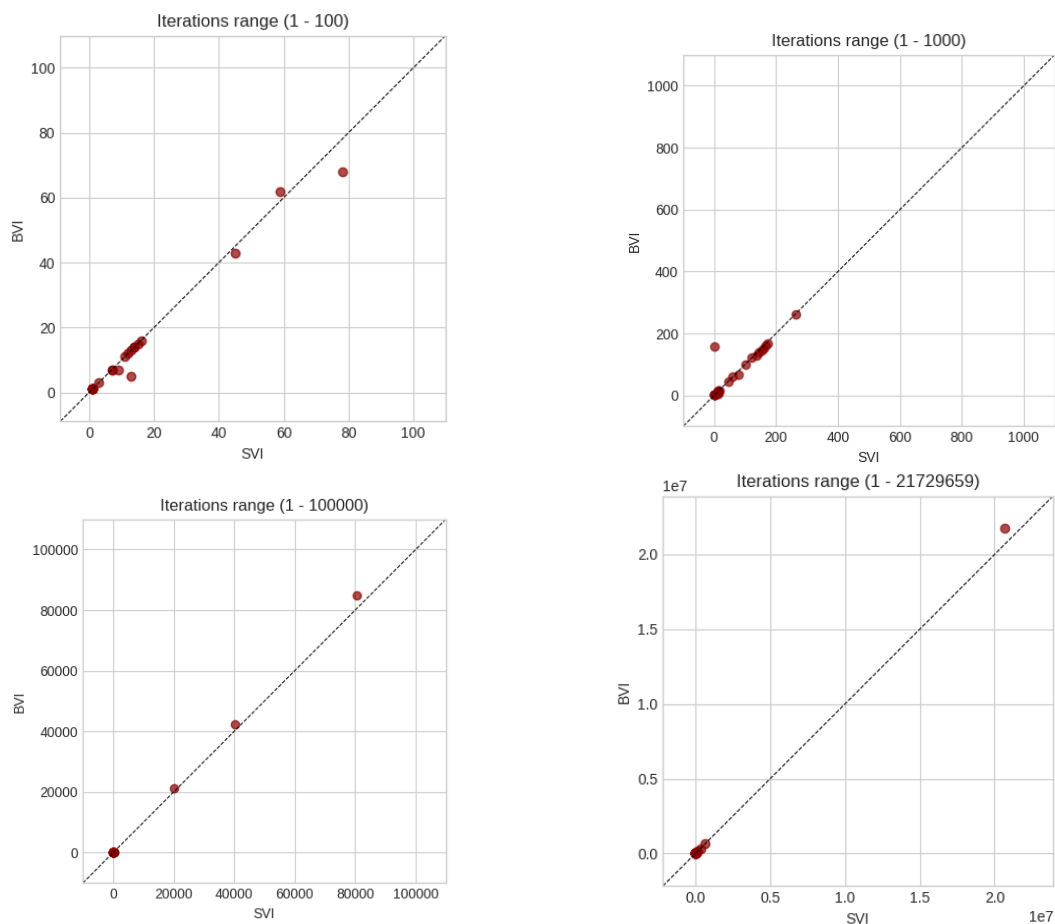

■ **Figure 10** Comparison of SVI with BVI on real and handcrafted SG benchmarks

- SVI excels on the haddad-monmege [12], resolving probabilistic loops faster and showing an exponentially growing difference in iteration numbers ($1000 \rightarrow 2000 \rightarrow 4000 \rightarrow \dots$) with an increase in the size of instance.
- BVI performs good on the cloud benchmark, due to the simultaneous state updates in deflating SECs, leading to a higher iteration count for SVI, however, the difference in iterations remain constant even with increase in the instance's size.
- *How does SVI performs on MDP benchmarks?* SVI now works directly on MDP with end components. We reproduced the results on MDP: SVI consistently requires fewer iterations than BVI in all non-trivial cases, see Table 1 in App. C.4, with the exception of the wlan_dl benchmark. While SVI takes 348 iterations, BVI needs 333 iterations, however, this particular benchmark is identified as challenging in the literature [13]. The issue with wlan_dl is that the lower decision value is set to 0 in iteration 79, preventing further improvement in the global lower bound, which remains at 0. Moreover, the final value of this benchmark is 0.999804. The inability to update global bounds renders SVI less effective than BVI in the cases where decision value is hit very early.

C.4 Algorithm comparison on MDP benchmarks

■ **Table 1** Comparison of SVI and BVI on MDP benchmarks where *Reach* denotes that the benchmark is solved by simple graph reachability algorithm

Model	#States	BVI (#Iterations)	SVI (#Iterations)
consensus_c1	528	Reach	Reach
consensus_c2	1040	9452	8723
consensus_disagree	1040	10910	8746
csma_all_before_max	1038	16	16
csma_all_before_min	1038	16	16
csma_some_before	1038	6	6
firewire_abst	611	Reach	Reach
firewire_dl	14824	5	5
firewire_false_elected	4093	Reach	Reach
ij	7	Reach	Reach
pacman	498	2	2
philosophers		Reach	Reach
pnueli-zuck	2701	Reach	Reach
rabin	27766	Reach	Reach
wlan	14883	275	271
wlan_collisions	2954	Reach	Reach
wlan_dl	542503	333	348
wlan_sent	2954	Reach	Reach
zeroconf_correct_max	670	136	37
zeroconf_correct_min	670	215	22
zeroconf_dl_deadline_mn	3835	44	28
zeroconf_dl_deadline_mx	3835	5	1