

Are the flows of complex-valued Laplacians and their pseudoinverses related?

Aditi Saxena¹

Twinkle Tripathy²

Rajasekhar Anguluri³

Abstract—Laplacian flows model the rate of change of each node’s state as being proportional to the difference between its value and that of its neighbors. Typically, these flows capture diffusion or synchronization dynamics and are well-studied. Expanding on these classical flows, we introduce a *pseudoinverse Laplacian flow system*, substituting the Laplacian with its pseudoinverse within complex-valued networks. Interestingly, for undirected graphs and unsigned weight-balanced digraphs, Laplacian and the pseudoinverse Laplacian flows exhibit an interdependence in terms of consensus. To show this relation, we first present the conditions for achieving consensus in the *pseudoinverse Laplacian flow system* using the property of real eventually exponentially positivity. Thereafter, we show that the pseudoinverse Laplacian flow system converges to consensus if and only if the Laplacian flow system achieves consensus in the above-mentioned networks. However, these are only the sufficient conditions for digraphs. Further, we illustrate the efficacy of the proposed approach through examples, focusing primarily on power networks.

I. INTRODUCTION

Network science examines interconnected systems, where nodes represent entities and edges represent interactions. A key focus is on complex networks, which find applications in areas such as social, biological, and technological domains. In these applications, one is often interested in understanding the behavior of nodes (or agents) over time. This behavior is captured by Laplacian flows, where the evolution of node’s state is influenced by its interactions with neighboring nodes, providing insights into dynamics like diffusion, synchronization, and influence propagation [1]–[3].

On the other hand, consensus algorithms focus on enabling a group of agents to reach agreement on a common value or state. Thus, these algorithms can be viewed as a specific case of Laplacian flows, where the Laplacian matrix governs the state evolution attains consensus. Over the last two decades, many important results for consensus algorithms were established by exploring algebraic, spectral, and combinatorial properties of the Laplacian matrices. For studies in this direction and beyond, see [4]–[10]. Despite the extensive research on Laplacian flows and their key role in consensus studies, most existing work focuses on “real-valued” Laplacian matrices. While effective in many

applications, such assumption can be restrictive for emergin fields like distribution power networks, quantum dynamics, electrodynamics, and machine learning [11]–[14]. As highlighted in [14], the Laplacian matrix in these contexts is complex-valued. We refer to such systems as complex-valued networks to distinguish them from complex networks. The dedicated session on complex-valued networks at SIAM’s 2024 Mathematics of Data Science conference underscores the growing importance of this emerging field.

Distributed control algorithms for complex networks often employ Laplacian dynamics to study consensus in social networks [3]. Some works exploring Laplacian dynamics in complex-valued networks include [14]–[18]. In [15], the authors discuss modulus consensus using the concept of structural balance under the assumption of Hermitian adjacency matrices. Further, a spectral clustering algorithm in signed networks is proposed in [17] employing structural balance and anti-balance notions for Hermitian weight matrices. Few works employing eventually exponentially positivity property in the analysis of real-valued Laplacian flows are [19]–[21].

In contrast to the existing literature, we study the relationship between complex-valued Laplacians and their pseudoinverses in various types of network, such as signed and directed networks. We compute the Moore-Penrose pseudoinverse of the Laplacian matrix, corresponding to the network, to obtain the pseudoinverse Laplacian flows. We consider unsigned networks which find applications in power networks and non-uniform Kuramoto oscillators. To the best of our knowledge, we are the first to introduce and study pseudoinverse flow systems. Below, we summarize our key contributions:

- 1) Using the real eventually exponentially positivity property (rEEP) introduced in [18], we establish the necessary and sufficient conditions for achieving consensus in both complex-valued Laplacian and pseudoinverse Laplacian flows. We focus on cooperative and antagonistic (i.e., symmetric) complex-valued networks and weight-balanced digraphs.
- 2) We establish that the property of rEEP is equivalent to the marginal stability or semi-convergence of the Laplacian, as well as the pseudoinverse Laplacian flows. We use complex Perron-Frobenius theory to establish the real eventually exponential positivity of the matrices.

Finally, we validate our mathematical findings on synthetic and IEEE benchmark power networks. In addition, throughout the paper we demonstrate our theoretical results using several toy network systems.

¹Aditi Saxena is a research scholar with the Department of Electrical Engineering, Indian Institute of Technology Kanpur, India. (email: saditi23@iitk.ac.in)

²Twinkle Tripathy is with the Department of Electrical Engineering, Indian Institute of Technology Kanpur, India. (email: ttripathy@iitk.ac.in).

³Rajasekhar Anguluri is with the Department of Computer Science and Electrical Engineering, University of Maryland, Baltimore County, MD 85281, USA. (e-mail: rajangul@umbc.edu).

II. PRELIMINARIES

A. Matrix Algebra

We denote the space of $n \times n$ complex-valued matrices by $\mathbb{C}^{n \times n}$. For any m (scalar or matrix), $\Re(m)$ and $\Im(m)$ indicates the real and imaginary part of m respectively. A matrix $M := [m_{ij}] \in \mathbb{C}^{n \times n}$ is non-negative (positive) if $\Re(m_{ij}) \geq 0$ and $\Im(m_{ij}) \geq 0$ (respectively $\Re(m_{ij}) > 0$ and $\Im(m_{ij}) > 0$) $\forall i, j \in \{1, 2, \dots, n\}$. A matrix is real non-negative (positive), that is, $\Re(M) \geq 0$ ($\Re(M) > 0$) if $\Re(m_{ij}) \geq 0$. M is real eventually non-negative (positive) if $\Re(M^k) \geq 0$ ($\Re(M^k) > 0$) holds for some $k \geq k_0$. M^H is the conjugate transpose or adjoint of M . M is self-adjoint if $M = M^H$ holds. The spectrum of M is denoted by $\text{spec}(M) = \{\lambda_1, \lambda_2, \dots, \lambda_n\}$, where λ_i is the i^{th} eigenvalue of M . The symmetric part of M is denoted as M_s . Any symmetric matrix M is positive semi-definite (psd) if all eigenvalues are in the closed right-half plane (RHP). The spectral radius of a matrix M is the smallest non-negative real number $\rho(M) \geq |\lambda_j(M)|$ for all $\lambda_j \in \text{spec}(M)$. Corank of M is defined as the dimension of its null space [22].

B. Graph Theory

Consider the weighted directed graph $\mathcal{G}(A) = (\mathcal{V}, \mathcal{E}, A)$, where \mathcal{V} is the set of vertices, \mathcal{E} is the set of edges, and $A = [a_{ij}] \in \mathbb{C}^{n \times n}$ is the adjacency matrix. If $a_{ij} \geq 0$, then $\mathcal{G}(A)$ corresponds to an unsigned network. Otherwise, it is a signed network. In mathematical sociology, the positive edges in a network represent friendship, while the negative edges indicate enmity between individuals. Degree matrices are diagonal matrices where each diagonal entry represents the degree of a corresponding node. For digraphs, the out-degree of a node is the sum of the weights of all its outgoing edges. Out-degree matrix is given by $D_{out} = \text{diag}(A\mathbf{1}_n)$. The Laplacian matrix L is defined by $L = D_{out} - A$. The Moore-Penrose pseudoinverse (hereafter Laplacian pseudoinverse) of L is denoted by L^\dagger . A digraph (or undirected graph) $\mathcal{G}(A)$ is said to be strongly connected (or connected), if any node can be reached from any other node. A digraph is weight-balanced if each node's in-degree equals its out-degree. $\mathcal{G}(A)$ is said to be unsigned when all its edge-weights are non-negative.

Definition 1. (strong complex PF property [23]) A matrix $M \in \mathbb{C}^{n \times n}$ follows the strong complex Perron-Frobenius (PF) property if its dominant eigenvalue λ_1 is positive, simple, and satisfies $\lambda_1 > |\lambda_j|$ for all $j \in \{2, 3, \dots, n\}$. Additionally, the corresponding right eigenvector satisfies $\Re(\mathbf{x}) > \mathbf{0}$.

Definition 2. (real eventually exponentially positive matrix [18]) A matrix $M \in \mathbb{C}^{n \times n}$ is real eventually exponentially positive (rEEP) if there exists t_0 such that $\Re(e^{Mt}) > 0$ for all time $t \geq t_0$.

Definition 3. The pseudoinverse (in the sense of Moore-Penrose) of $M \in \mathbb{C}^{n \times m}$ is denoted by M^\dagger and it satisfies [24]:

- (i) $MM^\dagger M = M$,
- (ii) $M^\dagger MM^\dagger = M^\dagger$,
- (iii) $MM^\dagger \in \mathbb{C}^{m \times m}$ and $M^\dagger M \in \mathbb{C}^{n \times n}$ are self-adjoint.

We cull some important results (without proof) from our prior work [18]. First, consider the set of matrices

$$\mathcal{O} := \{O \in \mathbb{C}^{n \times n}; \Re(\mathbf{x}) \geq |\Im(\mathbf{x})|, \Re(\mathbf{z}) \geq |\Im(\mathbf{z})|\} \quad (1)$$

and every $O \in \mathcal{O}$ follows strong complex PF Property.

Theorem 1. Consider M and $M^H \in \mathbb{C}^{n \times n}$ such that $\Re(\mathbf{x}) \geq |\Im(\mathbf{x})|, \Re(\mathbf{z}) \geq |\Im(\mathbf{z})|$ holds where \mathbf{x} and \mathbf{z} are the dominant right and left eigenvectors of M , respectively. Then, the following statements are equivalent for some scalar $d \geq 0$:

- (i) $(M + dI)$ and $(M + dI)^H \in \mathcal{O}$,
- (ii) $(M + dI)$ is real eventually positive for all $k \geq k_0$,
- (iii) M is rEEP.

where \mathcal{O} is as defined in Eqn.(1).

Lemma 1. Consider an undirected unsigned graph such that $L \in \mathbb{C}^{n \times n}$. Then, the following statements are equivalent:

- (i) $-L$ is rEEP,
- (ii) $-L$ has '0' as a simple eigenvalue.

Lemma 2. Consider an unsigned digraph such that $L \in \mathbb{C}^{n \times n}$ corresponds to a weight-balanced and strongly connected graph. Then, the following statements are equivalent:

- (i) $-L$ is rEEP,
- (ii) $-L$ has '0' as a simple eigenvalue.

III. PSEUDOINVERSE LAPLACIAN FLOWS

Consider the following continuous-time consensus dynamics for the i -th agent, for all $i = \{1, 2, \dots, N\}$:

$$\dot{x}_i(t) = -\frac{x_i(t)}{N_i} + \dot{x}_j(t), \quad (2)$$

where $N_i \leq N$ is the number of neighbors of the i -th agent. Aggregating the dynamics in Eqn.(2) across the index j and rearrangement leads to

$$\sum_{j \sim i} (\dot{x}_i(t) - \dot{x}_j(t)) = -x_i(t). \quad (3)$$

Let $x(t) = [x_1(t), \dots, x_N(t)]^\top$. Then the consensus dynamics for all agents are governed by $L\dot{x}(t) = -x(t)$, which, through the Moore-Penrose pseudoinverse formalism introduced earlier, results in the pseudoinverse Laplacian flow system:

$$\dot{x}(t) = -L^\dagger x(t). \quad (4)$$

We discuss how pseudoinverse flow systems arise naturally in electrical networks. Consider the impedance network in Fig.3 with branch (or series) resistances and capacitance and shunt inductance (\mathcal{L}_{ind}). Employing Kirchhoff's circuit laws, we have the balance equation as: [5]

$$I(t) = Lv(t), \quad (5)$$

where $I(t)$ and $v(t)$ are the instantaneous nodal currents and voltages vectors, and L is the complex-valued Laplacian arising from the impedance elements. On the other hand, Eqn.6

$$v(t) = -\mathcal{L}_{ind} \frac{dI}{dt} \quad (6)$$

establishes the relationship between nodal voltages and voltage drops across the shunt inductances (see Fig.3). Combining Eqns.(5)-(6), we get the pseudoinverse flow system as

$$\dot{I}(t) = \frac{1}{\mathcal{L}_{ind}}(-L^\dagger)I(t). \quad (7)$$

Laplacian pseudoinverses have notable applications in social and power networks [8], [20], [25], [26]. With their potential in different areas, they present an intriguing avenue for research. Hence, we discuss some results on pseudoinverses in the following section.

We commence with some general results that hold regardless of whether the graph is signed or unsigned. The only condition here is that the Laplacian matrix should have zero row and column sums along with a simple ‘0’ eigenvalue.

Lemma 3. *The set of eigenvectors corresponding to the zero eigenvalue of the Laplacian matrix remains same as of the Laplacian pseudoinverse matrix.*

Proof. For undirected graphs and weight-balanced digraphs, we have $L\mathbb{1}_n = \mathbb{0}_n$ and $\mathbb{1}_n^T L = \mathbb{0}_n^T$. Further, from Def.3,

$$(L^\dagger L)^H = L^\dagger L, \quad (8)$$

$$(LL^\dagger)^H = LL^\dagger, \quad (9)$$

Using Eqn.(8), $\mathbb{1}_n^T L^\dagger = \mathbb{1}_n^T L^\dagger LL^\dagger = \mathbb{1}_n^T (L^\dagger L)^H L^\dagger$,

$$\mathbb{0}_n^T (L^\dagger)^H L^\dagger = \mathbb{0}_n^T,$$

Similarly using Eqn.(9), $L^\dagger \mathbb{1}_n = \mathbb{0}_n$. \square

Thus, if the eigenvectors of L corresponding to the zero eigenvalue lie in $\text{span}\{\mathbb{1}_n\}$, then the same holds true for the eigenvectors of L^\dagger . Next, we derive the following result to state the relation between the Laplacian and pseudoinverse Laplacian flows in reaching consensus. Further, we show in Ex.3, that the current flowing in an impedance circuit stabilizes to a steady-state value following a transient phase as an application of Laplacian pseudoinverse flows.

Theorem 2. *In undirected graphs and weight-balanced digraphs, the Laplacian flows achieve consensus if and only if the pseudoinverse Laplacian flows achieve consensus.*

Proof. The Laplacian flows are given as $\dot{x} = -Lx$ for all $L \in \mathbb{C}^{n \times n}$ [18]. Thus, the solution for Laplacian flows is given by $x(t) = e^{-Lt}x_0$, where x_0 is the initial condition. If the Laplacian flow achieves consensus, then at $t \rightarrow \infty$, the following holds from [18],

$$x(t) = \mathbb{1}_n z^H x_0, \quad (10)$$

where $z^H x_0$ is constant, and hence $x(t)$ is constant. Now, let us consider the pseudoinverse Laplacian flows in Eqn.(4): $\dot{x} = -L^\dagger x$. From Corollary 1 and Eqn.(10), we conclude that as $t \rightarrow \infty$, the state $x(t) = e^{-L^\dagger t}x_0$ achieves consensus. The reverse direction can also be proved on the same lines. \square

Thm.2 shows that, in a certain class of networks, it is enough to check for consensus in either one of the flows: the Laplacian flow or its pseudoinverse; the other one follows

from it. But, does the Laplacian (or the pseudoinverse Laplacian) flow achieve consensus for every network in this class? The answer to this question lies in the rEEP property as discussed next.

IV. PSEUDOINVERSES OF REAL EVENTUALLY EXPONENTIALLY POSITIVE LAPLACIANS

A. Undirected networks

In social networks, signed networks are more realistic than unsigned networks. We consider a set of signed graphs where the real part is non-negative and the imaginary part can be negative or non-negative. In this case, we evaluate the Laplacian matrix in an analogous way to unsigned networks (given in Sec.II). The motivation for leveraging this set of signed graphs stems from power system networks where the Laplacian matrix corresponds to the network’s admittance matrix. The corresponding signed Laplacian retains the fundamental properties of the former. The eigenvalues of both Laplacian and signed Laplacian matrices lie in the closed RHP. This can be proved using the *Geršgorin Disk Theorem* [5]. Additionally, the signed Laplacian exhibits zero row and column sums as it is a complex symmetric matrix.

We explore the rEEP property of Laplacian pseudoinverse matrices for the above-mentioned set of signed graphs.

Theorem 3. *Consider an undirected graph $\mathcal{G}(A)$ which is signed and connected such that L and $L^\dagger \in \mathbb{C}^{n \times n}$ is complex symmetric, then the following statements are equivalent:*

- (i) L is psd of corank 1,
- (ii) $-L$ is rEEP,
- (iii) L^\dagger is psd of corank 1,
- (iv) $-L^\dagger$ is rEEP.

Proof. (i) \implies (ii): We have, L is psd of corank 1 which implies $\lambda_1 = 0 < \lambda_2 \leq \lambda_3 \dots \leq \lambda_n$ are the eigenvalues of L . We choose a value of $d \in \mathbb{R}_{>0}$ such that $\rho(B) = d$ and the corresponding right eigenvector lies in the $\text{span}\{\mathbb{1}_n\}$. Then, we consider $B = dI - L$ which implies $B\mathbb{1}_n = d\mathbb{1}_n - L\mathbb{1}_n$. Therefore, B has a dominant eigenvalue d with $x \in \text{span}\{\mathbb{1}_n\}$. Hence, B follows strong complex PF property and is real eventually positive (rEP). Using Thm.1, $\Re(B^k) > 0$ implies that $-L$ is rEEP.

(ii) \implies (i): Conversely, $-L$ is rEEP. From the previous part, we consider $B = dI - L$. Further, using Thm.1, we know that B is rEP, which is equivalent to B having a simple dominant eigenvalue, $\rho(B) = d$ and $x \in \text{span}\{\mathbb{1}_n\}$. Reversing the construction of L , it must have a simple ‘0’ eigenvalue and the remaining eigenvalues lie in the open RHP. Hence, L is psd of corank 1.

(ii) \implies (iii): We have already shown that if $-L$ is rEEP, it has a simple ‘0’ eigenvalue equivalently. Then, we have the spectrum of L^\dagger given in Eqn.(11),

$$\text{spec}(-L^\dagger) = \{0, -1/\lambda_2, -1/\lambda_3, \dots, -1/\lambda_n\}, \quad (11)$$

where $\lambda_1, \lambda_2, \dots, \lambda_n$ are the eigenvalues of L [20]. Using Lemma 3, $x, y^H \in \text{span}\{\mathbb{1}_n\}$. By the inherent properties of L , we know that all the eigenvalues lie in the closed RHP. Let

λ_j be a non-zero eigenvalue which belongs to the $\text{spec}(L)$. Then, all the non-zero eigenvalues of L^\dagger have positive real parts. Therefore, L^\dagger has all the eigenvalues in the closed RHP. Hence, L^\dagger is *psd* of corank 1.

(iii) \implies (iv): We have, L^\dagger is *psd* of corank 1. Using the Jordan canonical form of L^\dagger ,

$$-L^\dagger = [x^{(1)} | X_{n,n-1}] \begin{bmatrix} -\lambda_1 & 0 \\ 0 & -D_{n-1,n-1}^{-1} \end{bmatrix} \begin{bmatrix} y^{(1)H} \\ Y_{n-1,n} \end{bmatrix}, \quad (12)$$

Substituting $\lambda_1 = 0$, we get

$$-L^\dagger = [x^{(1)} | X_{n,n-1}] \begin{bmatrix} 0 & 0 \\ 0 & -D^{-1} \end{bmatrix} \begin{bmatrix} y^{(1)H} \\ Y_{n-1,n} \end{bmatrix},$$

where D is the diagonal matrix containing eigenvalues of L except '0' eigenvalue. Then, taking exponential of the negated Laplacian matrix, at a larger time instant, we have the final expression for matrix exponential as: $\lim_{t \rightarrow \infty} e^{-L^\dagger t} = \alpha x^{(1)} y^{(1)H}$. Since $x^{(1)}$ and $y^{(1)H} \in \text{span}\{\mathbf{1}_n\}$, the product of the eigenvectors is always real and positive. Hence, $-L^\dagger$ is rEEP.

(iv) \implies (iii): The Laplacian pseudoinverse matrix satisfies the two inherent properties of L . The first property is given in Lemma 3, and the second one states that all eigenvalues, excluding the zero eigenvalue, lie in open RHP (shown in (ii) \implies (iii)). Hence, it can be proven on the same lines as proved in (ii) \implies (i) direction. \square

Corollary 1. Consider an undirected graph which is unsigned and connected such that L and $L^\dagger \in \mathbb{C}^{n \times n}$. Then, the following statements are equivalent:

- (i) $-L$ is rEEP,
- (ii) $-L^\dagger$ is *psd* of corank 1,
- (iii) $-L^\dagger$ is rEEP.

Proof. Using Lemma 1, $-L$ being rEEP is equivalent to L having a simple '0' eigenvalue. Since the spectrum of Laplacian pseudoinverse matrix is given in Eqn.(11) and Thm.3 already proves that the property of rEEP is conserved under the operation of pseudoinverse. Thus, the inherent properties of L and L^\dagger remain same as in Thm.3. Hence, this can be proved on the same lines as in Thm.3. \square

B. Unsigned directed networks

We assume the digraph $\mathcal{G}(A)$ to be strongly connected and weight-balanced. The rEEP property, which enables consensus, is a consequence of the network's connectivity. The assumption of weight-balance aids in proving the rEEP property, as the left eigenvector corresponding to the '0' eigenvalue in a non weight-balanced digraph is indeterminate in the case of a complex-valued digraph.

Theorem 4. Consider an unsigned digraph $\mathcal{G}(A)$ such that L and $L^\dagger \in \mathbb{C}^{n \times n}$ corresponds to a strongly connected and weight-balanced digraph. Then, the following statements are equivalent:

- (i) $-L$ is rEEP.
- (ii) $-L^\dagger$ has a simple '0' eigenvalue.
- (iii) $-L^\dagger$ is rEEP.

(iv) $(L^\dagger)_s$ is *psd* of corank 1.

Proof. (i) \implies (ii): From Lemma 2, if $-L$ is rEEP, then it equivalently has a simple '0' eigenvalue. Hence, we have the spectrum of L^\dagger given in Eqn.(11). Consequently, L^\dagger has a simple '0' eigenvalue.

(ii) \implies (i): We have, L^\dagger with a simple '0' eigenvalue. Following Eqn.(11), L has a simple '0' eigenvalue. Applying Lemma 2, $-L$ is rEEP.

(ii) \implies (iii): This can be proved using Jordan canonical form. Substituting $\lambda_1 = 0$ in Eqn.(12), we obtain $\lim_{t \rightarrow \infty} e^{-L^\dagger t} = \alpha x^{(1)} y^{(1)H}$. The eigenvectors corresponding to zero eigenvalue are same (using Lemma 3). Hence, $-L^\dagger$ is rEEP. The reverse direction can also be proved as in Thm.3.

(ii) \implies (iv): The symmetric part of L^\dagger , $(L^\dagger)_s$ follows $\Re(\lambda_i(L^\dagger)) = \lambda_i((L^\dagger)_s)$ which implies L_s^\dagger is *psd* of corank 1.

(iv) \implies (ii): Since L_s^\dagger is *psd* of corank 1 and it follows $\Re(\lambda_i(L^\dagger)) = \lambda_j((L^\dagger)_s)$, it implies that all the eigenvalues of L^\dagger lie in open RHP. Hence, $-L^\dagger$ has a simple '0' eigenvalue. \square

Moreover, the assumption of weight-balance guarantees average consensus, where the final convergence value is achieved exactly as an average of all initial opinions. Additionally, the property of rEEP implies that all agents in a network have equal importance in the network. Next, we provide a consequence of rEEP property.

Corollary 2. Through the results presented in this section, it follows that if $-L$ is rEEP, then the Laplacian and the pseudoinverse Laplacian flows achieve consensus for every undirected graphs and weight-balanced unsigned digraphs.

It follows from Corollary 2 that in general, rEEP is only a sufficient condition for consensus. A network of agents may converge to consensus even when $-L$ is not rEEP (an example is shown in Fig.1). These cases may be explored in the future.

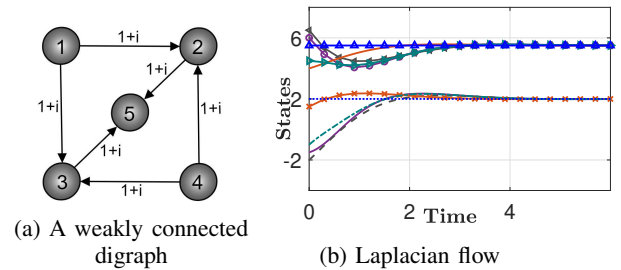

Fig. 1: For the given network, $-L$ is not rEEP, yet consensus is achieved. The trajectories above and below in Fig.1b denote the real and imaginary parts of the states, respectively.

Now, we present the following numerical examples to validate the aforementioned results. Note that, for brevity, all matrices in the examples have been rounded to two decimal places.

Example 1. (Synthetic network) Here, the given unsigned digraph is strongly connected and weight-balanced.

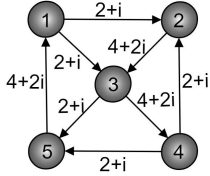

Fig. 2: Strongly connected weight-balanced digraph

The matrix exponential of the negated Laplacian matrix is

$$e^{-L_1 t} = \begin{bmatrix} 0.2+0.01i & 0.2 & 0.19 & 0.21 & 0.2-0.01i \\ 0.22 & 0.2 & 0.2+0.01i & 0.2-0.01i & 0.19-0.01i \\ 0.2-0.01i & 0.2 & 0.21 & 0.19 & 0.2+0.01i \\ 0.18 & 0.2 & 0.2-0.01i & 0.2+0.01i & 0.22 \\ 0.2 & 0.2 & 0.2 & 0.2 & 0.2 \end{bmatrix}$$

Here, $\text{spec}(L_1) = \{0, 3.67 + 5.14i, 5 + 5i, 6.32 - 0.14i, 7 + i\}$. For $d \geq 6$, we note that $B = dI - L$ is rEEP and $B \in \mathcal{O}$. So, $-L_1$ has a simple '0' eigenvalue. Further, $-L_1$ is equivalently rEEP. The eigenvalues of the Laplacian pseudoinverse lie in the closed RHP as $\text{spec}(L_1^\dagger) = \{0, 0.091 - 0.128i, 0.1 - 0.1i, 0.16 + 0.003i, 0.14 - 0.02i\}$. Then, the matrix exponential for the Laplacian pseudoinverse at $t = 13$ is given as:

$$\begin{bmatrix} 0.23+0.11i & 0.13-0.05i & 0.13-0.07i & 0.25+0.01i & 0.26-0.01i \\ 0.24+0.04i & 0.25+0.1i & 0.01-0.08i & 0.26-0.01i & 0.25-0.05i \\ 0.26-0.01i & 0.24-0.01i & 0.36+0.16i & 0.13-0.07i & 0.01-0.08i \\ 0.02-0.13i & 0.24-0.01i & 0.26-0.01i & 0.23+0.11i & 0.24+0.04i \\ 0.24-0.01i & 0.13-0.05i & 0.24-0.01i & 0.13-0.05i & 0.25+0.1i \end{bmatrix}$$

Thus, we observe that both the negated Laplacian and Laplacian pseudoinverse matrices are rEEP (as proved in Thm.4).

Example 2. (Real-world power system network) We consider signed Laplacian matrix corresponding to a case 10ba network imported from MATPOWER software.

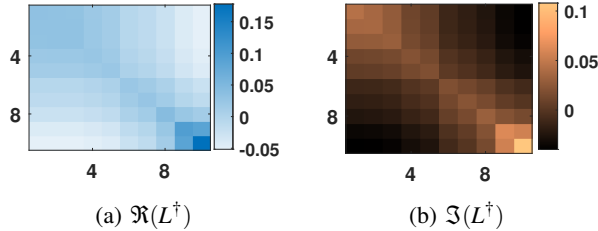

Fig. 3: Heatmaps showing the matrix structure of L^\dagger for real and imaginary parts respectively in an IEEE 10 bus network (the number here denotes the total nodes)

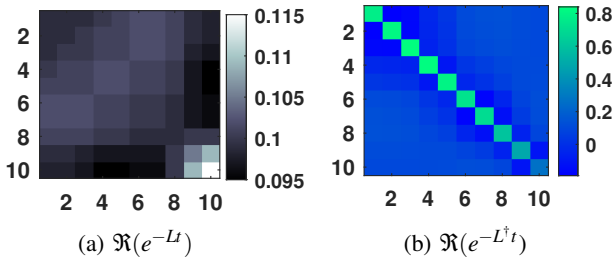
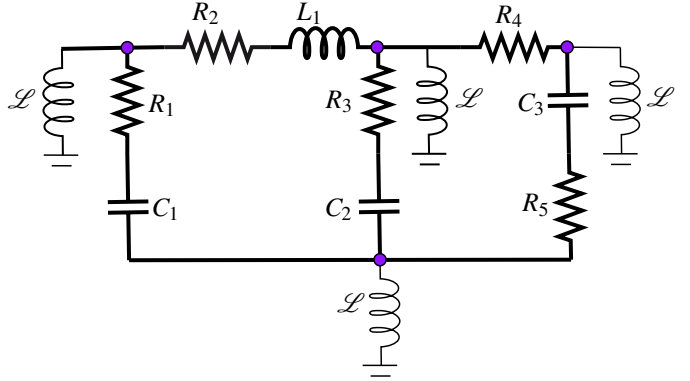

Fig. 4: The matrix structure of $\Re(e^{-L_1 t})$ and $\Re(e^{-L_1^\dagger t})$ at $t = 1$ and $t = 15$ respectively. Values on the colorbar represent the entire range that encompasses all the values of a matrix, and all of these values are positive implying rEEP property.

The matrix structure of L corresponding to the 10-bus network closely resembles to that of the L^\dagger . The exact heat maps have been omitted for brevity.

Since the spectrum of the Laplacian matrix corresponding to the 10-bus network has a simple zero eigenvalue, the negated Laplacian matrix as well as negated Laplacian pseudoinverse is rEEP. Fig.4 illustrates the approximated values of the matrix exponential of the negated Laplacian matrices, as well as their Laplacian pseudoinverses. Thus, it is evident from Fig.4 that the rEEP property is preserved under the operation of pseudoinverse for Laplacian matrices, as proved in Thm.3.

Example 3. (Impedance network) Here, we consider an impedance network with shunt inductors connecting each node to ground in Fig.3. The following network is connected, and the spectrum of corresponding L contains a simple '0' eigenvalue. This network corresponds to a signed Laplacian matrix.



V. SIMULATIONS

We now validate our theoretical findings on synthetic and a standard IEEE benchmark power networks. We examine the dynamical behavior (state evolution) of pseudoinverse Laplacian flows for various network assumptions. It is worth noting that the magnitude of the smallest eigenvalues of the Laplacian and pseudoinverse Laplacian matrix determine the rate of convergence in the corresponding flows respectively. Our first set of experiments concerns the unsigned network in Ex.1 satisfying the assumptions in Thm.2,4. As expected, states of both Laplacian and pseudoinverse Laplacian flows attain consensus (Fig.5). Since the state is complex-valued, we plot the real and imaginary state trajectories separately.

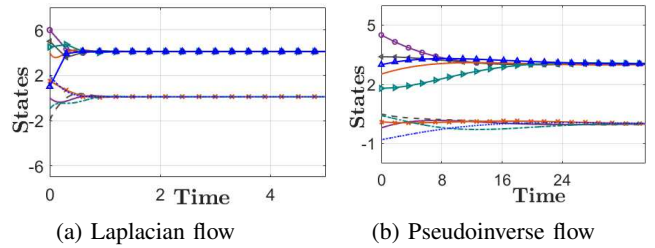

Fig. 5: Consensus achieved by flow systems for the unsigned digraph in Ex. 1. We plot the real and imaginary state trajectories. Observe that the real (upper) and imaginary (lower) states converge to different values.

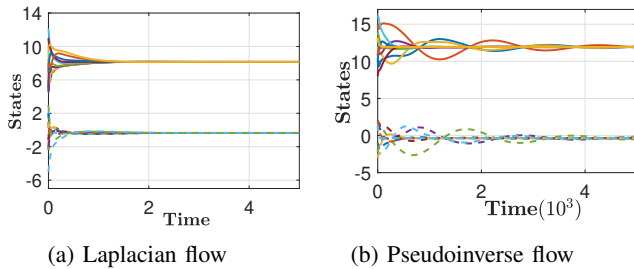

Fig. 6: Consensus achieved by flow systems for the IEEE 10 node network in [27]. Solid and dashed lines denote real and imaginary trajectories, respectively. The notation 10^3 in (b) represents the time-scale.

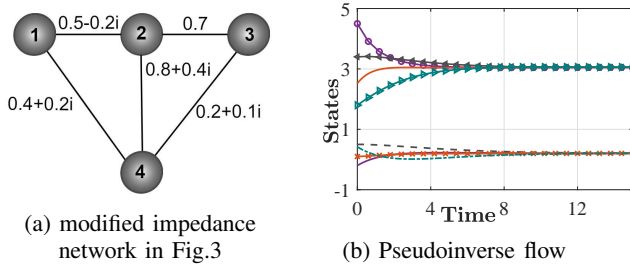

Fig. 7: Consensus achieved by the pseudoinverse Laplacian flow system indicating equal values of current after a transient period in a power network. The exact values of e^{-L^t} are omitted for brevity.

Second, we consider the benchmark IEEE power network described in Ex.2 and an impedance network in Ex.3. We already show that the Laplacian and its pseudoinverse follow rEEP property in Fig.4. This implies consensus in both the flows shown in Fig.6 which validates our result in the given real-world power network (as proven in Thm.2). Further, Fig.7a presents the graph of the impedance network in Fig.3. The corresponding pseudoinverse Laplacian flow is simulated in Fig.7b which converges to consensus.

VI. CONCLUSIONS AND FUTURE WORK

We introduce the pseudoinverse Laplacian flows and extend the concept of *real eventually exponential positivity* (rEEP) to the pseudoinverses of Laplacians in complex-valued networks. Surprisingly, for both undirected and weight-balanced directed graphs, we show that a Laplacian satisfies rEEP if and only if its pseudoinverse does. As a consequence of the rEEP property, both Laplacian and the pseudoinverse Laplacian flows achieve consensus. However, the converge properties of the Laplacian and the pseudoinverse Laplacian flows need further investigation outside of the class of non weight-balanced digraphs. In future work, we plan to investigate whether these assertions apply to all signed digraphs.

REFERENCES

- [1] Alexander J Gates, Qing Ke, Onur Varol, and Albert-László Barabási. Nature's reach: narrow work has broad impact. *Nature*, 575(7781):32–34, 2019.
- [2] Florian Dorfler and Francesco Bullo. Synchronization and transient stability in power networks and nonuniform kuramoto oscillators. *SIAM Journal on Control and Optimization*, 50(3):1616–1642, 2012.

- [3] Reza Olfati-Saber, J Alex Fax, and Richard M Murray. Consensus and cooperation in networked multi-agent systems. *Proceedings of the IEEE*, 95(1):215–233, 2007.
- [4] Morris H DeGroot. Reaching a consensus. *Journal of the American Statistical association*, 69(345):118–121, 1974.
- [5] Francesco Bullo. *Lectures on network systems*, volume 1. CreateSpace, 2018.
- [6] Shuyue Hu, Harold Soh, and Georgios Piliouras. The best of both worlds in network population games: Reaching consensus and convergence to equilibrium. *Advances in Neural Information Processing Systems*, 36, 2024.
- [7] Bowen Zhang, Yucheng Dong, Hengjie Zhang, and Witold Pedrycz. Consensus mechanism with maximum-return modifications and minimum-cost feedback: A perspective of game theory. *European Journal of Operational Research*, 287(2):546–559, 2020.
- [8] Hale Cetinay, Fernando A Kuipers, and Piet Van Mieghem. A topological investigation of power flow. *IEEE Systems Journal*, 12(3):2524–2532, 2016.
- [9] Diego Romeres, Florian Dörfler, and Francesco Bullo. Novel results on slow coherency in consensus and power networks. In *2013 European Control Conference (ECC)*, pages 742–747. IEEE, 2013.
- [10] Claudio De Persis, Erik RA Weitenberg, and Florian Dörfler. A power consensus algorithm for DC microgrids. *Automatica*, 89:364–375, 2018.
- [11] Anna Muranova and Robert Schippa. Eigenvalues of the normalized complex Laplacian on finite electrical networks. *arXiv preprint arXiv:2012.12759*, 2020.
- [12] Yue Song, David J Hill, and Tao Liu. On extension of effective resistance with application to graph Laplacian definiteness and power network stability. *IEEE Transactions on Circuits and Systems I: Regular Papers*, 66(11):4415–4428, 2019.
- [13] Jianxi Liu and Xueliang Li. Hermitian-adjacency matrices and hermitian energies of mixed graphs. *Linear Algebra and its Applications*, 466:182–207, 2015.
- [14] Lucas Böttcher and Mason A Porter. Complex networks with complex weights. *Physical Review E*, 109(2):024314, 2024.
- [15] Jiu-Gang Dong and Li Qiu. Complex Laplacians and applications in multi-agent systems. *arXiv preprint arXiv:1406.1862*, 2014.
- [16] Jiu-Gang Dong and Lin Lin. Laplacian matrices of general complex weighted directed graphs. *Linear Algebra and its Applications*, 510:1–9, 2016.
- [17] Yu Tian and Renaud Lambiotte. Spreading and structural balance on signed networks. *SIAM Journal on Applied Dynamical Systems*, 23(1):50–80, 2024.
- [18] Aditi Saxena, Twinkle Tripathy, and Rajasekhar Anguluri. Real eventual exponential positivity of complex-valued laplacians: Applications to consensus in multi-agent systems. *arXiv:2410.13700*, 2024.
- [19] Angela Fontan and Claudio Altafini. On the properties of Laplacian pseudoinverses. In *2021 60th IEEE Conference on Decision and Control (CDC)*, pages 5538–5543. IEEE, 2021.
- [20] Angela Fontan and Claudio Altafini. Pseudoinverses of signed Laplacian matrices. *SIAM Journal on Matrix Analysis and Applications*, 44(2):622–647, 2023.
- [21] Claudio Altafini. Investigating stability of Laplacians on signed digraphs via eventual positivity. In *2019 IEEE 58th Conference on Decision and Control (CDC)*, pages 5044–5049. IEEE, 2019.
- [22] Roger A Horn and Charles R Johnson. *Matrix analysis*. Cambridge university press, 2012.
- [23] Dimitrios Noutsos and Richard S Varga. On the Perron–Frobenius theory for complex matrices. *Linear algebra and its applications*, 437(4):1071–1088, 2012.
- [24] João Carlos Alves Barata and Mahir Saleh Hussein. The Moore–Penrose pseudoinverse: A tutorial review of the theory. *Brazilian Journal of Physics*, 42:146–165, 2012.
- [25] Qiao Li, David Wenzhong Gao, Huaiguang Zhang, Ziping Wu, and Fei-yue Wang. Consensus-based distributed economic dispatch control method in power systems. *IEEE Transactions on Smart Grid*, 10(1):941–954, 2017.
- [26] Piet Van Mieghem, Karel Devriendt, and H Cetinay. Pseudoinverse of the laplacian and best spreader node in a network. *Physical Review E*, 96(3):032311, 2017.
- [27] Ray Daniel Zimmerman, Carlos Edmundo Murillo-Sánchez, and Robert John Thomas. Matpower: Steady-state operations, planning, and analysis tools for power systems research and education. *IEEE Transactions on Power Systems*, 26(1):12–19, 2010.