

# On modeling fracture of soft polymers

Aditya Konale<sup>a</sup>, Vikas Srivastava<sup>a,b,\*</sup>

<sup>a</sup>*School of Engineering, Brown University, Providence, RI 02912, USA*

<sup>b</sup>*Institute for Biology, Engineering and Medicine, Brown University, Providence, RI 02912, USA*

---

## Abstract

Soft polymers are ubiquitous materials in nature and as engineering materials with properties varying from rate-independent to rate-dependent depending on the crosslinking mechanisms. Current fracture toughness measures are non-unique for rate-dependent soft materials for varying loading profiles and specimen geometries. Works on modeling fracture in rate-dependent soft polymers are limited to specific pre-cracked geometries. There is no generally agreed-upon model for the fracture of soft polymers. We propose and show that a critical value of stress work  $W_{cr}$  obtained from simple homogeneous deformation experiments can be used as a simple experimental scalar measure of fracture resistance in soft polymers. We also develop a damage model to predict fracture in soft polymers through a generalized gradient damage framework based on the method of virtual power. The energetic part of the critical stress work is proposed as a damage initiation criterion. In the model, material strength, which is an important component of phase field damage models, is explicitly accounted for. The fracture model is validated and demonstrated to work well for both elastomers and viscous soft polymers by comparing model predictions against experimental results for different materials (ethylene propylene diene monomer - EPDM, EPS25 vitrimer, styrene butadiene rubber - SBR, and polyborosiloxane - PBS), a variety of specimen geometries, and loading conditions. The model is able to predict key physical phenomena and microstructural physical quantities, such as subchain dissociation energy during the fracture of soft polymers.

*Keywords:* Soft polymers; Gradient damage; Fracture; Rate-dependent; Constitutive model; Elastomers; Viscous polymers

---

---

\*Corresponding author

*Email address:* vikas\_srivastava@brown.edu (Vikas Srivastava)

## 1. Introduction

Soft polymers are defined as a broad class of polymers with chain networks formed through permanent or dynamic chemical or mechanical crosslinks leading to elastic modulus in the range of a few kilopascals to tens of megapascals. This class encompasses elastomers, viscoelastic and elastic-viscoplastic polymers, polymer gels<sup>1</sup>, and biological tissues. Their physical forms can vary from very viscous, slowly flowing soft solids (Konale et al., 2023) to elastomeric rubber-like materials (Steck et al., 2019).

Such polymers form a key class of engineering materials with a broad range of applications varying from biomedical drug delivery (Shukla et al., 2020, Huebsch et al., 2014, Alkhoury et al., 2024, Li et al., 2014b) and health monitoring (Amjadi et al., 2015, Miranda et al., 2022, Hwang et al., 2022) to impact protection (Zong et al., 2021, Tang et al., 2022), actuation (Yuk et al., 2017, Narumi et al., 2019, Brighenti et al., 2020), and adhesives (Yuk et al., 2016, 2019). These polymers possess significant variations in mechanical properties due to their underlying crosslinking mechanisms. Permanent crosslinks result in rate-independent behavior with high elasticity like elastomers (Nunes, 2011, Steck et al., 2019, Upadhyay et al., 2021). On the other hand, dynamic, reversible crosslinks lead to significantly rate-dependent mechanical behavior (Hu et al., 2017, Kurkin et al., 2021). In the case of dynamically crosslinked polymers, longer loading timescales lead to highly viscous fluid-like behavior, while shorter loading timescales result in elastomer-like behavior (Konale et al., 2023, Lai et al., 2019). The dynamic crosslinks can provide autonomous self-healing of small fractures (Lai et al., 2019, Shen et al., 2021b). Hence, depending on the nature of crosslinks in a soft polymer, its behavior can vary between the extremes of purely elastic to highly viscous response. Current fracture toughness measures based on energy release rate or crack tip stress intensity are non-unique when evaluated for rate-dependent soft materials. They vary with the loading profile and specimen geometry under consideration (Song et al., 2021, Long and Hui, 2016, Long et al., 2021, Yin et al., 2021). Material points around stress concentrators like a notch experience multi-axial non-homogeneous strain rate and stress states. Therefore, the evaluation of energy release rate or crack tip stress field-based measures will require a three-dimensional constitutive model that captures the nonlinear, rate-dependent mechanical response.

Accurate energy or field calculations for these fracture toughness measures necessitate the use of precise computational methods like the finite element method (Long and Hui, 2016, Liu et al., 2019b, Shen et al., 2021a, Cao et al., 2024, Mousavi et al., 2024, Bouklas et al.,

---

<sup>1</sup>The polymer gels here are restricted to those where loading timescales are significantly faster than the solvent diffusion timescale.

2015, Yu et al., 2019) due to the complexities of the non-linear large strain material response, geometries, and boundary conditions (Fakhouri et al., 2015, Jiang et al., 2019, Duncan et al., 2020, Montanari et al., 2023). Significant experimental studies have focused on the fracture of elastomers and polymer gels (Lake et al., 1967b, Lake, 1995, Chen et al., 2017, Creton, 2017, Long et al., 2021, Kim et al., 2021, Tang et al., 2017, Shrivastava and Gundiah, 2023). Recent modeling efforts, which are limited only to elastomers based on the gradient damage framework, can be broadly separated into four approaches. First considers a variational approach by minimizing a nonlinear energy function to predict crack nucleation without ad-hoc criteria (Bourdin et al., 2000, 2008). The drawback of the variational approach of being unable to capture experimentally observed failure surfaces has been noted in (Lopez-Pamies et al., 2025). The second approach for elastomers directly considers the underlying Euler-Lagrange equations and uses independent stress-based criteria for damage nucleation from the bulk (Kumar and Lopez-Pamies, 2020, Kumar et al., 2020, Lopez-Pamies et al., 2025). It uses the Griffith energy competition as a descriptor of nucleation from a large pre-existing crack. The third and fourth approaches are based on the method of virtual power. In the third approach, the free energy density function and driving force for damage initiation and evolution are considered entirely entropic following the ideal chain assumption (Miehe and Schänzel, 2014, Raina and Miehe, 2016, Gültekin et al., 2016, Wu et al., 2016). The fourth approach incorporates an energetic contribution to the free energy density function due to backbone bond or crosslink stretching (whichever is weaker) along with the conventional entropic part (Mao et al., 2017, Talamini et al., 2018, Mao and Anand, 2018a,b, Li and Bouklas, 2020). This is motivated by the scaling law for elastomers proposed by Lake and Thomas (Lake et al., 1967a) relating the Griffith energy release rate to the binding energy between monomer units (or of crosslinks (Mao and Anand, 2018a)) among other microscopic parameters. However, all these models are limited to elastomers only, while the focus of the paper is to develop a general, unified damage and fracture model for rate-dependent, viscous polymers that is also applicable to elastomers.

Rate-dependent and dynamic failures in various polymers have been experimentally studied (Rosakis and Ravichandran, 2000, Shukla et al., 2010, Mac Donald and Ravichandran, 2020, LeBlanc et al., 2020, 2018, Srivastava et al., 2000, 2002, Subhash et al., 2006, Subhash and Liu, 2009, Zheng et al., 2022, Malhotra et al., 2021, Brown et al., 2002, Malito et al., 2019, Burla et al., 2020, Liu et al., 2023, Cox et al., 2005, Guzek et al., 1997, Xu and Wang, 2006). The rate-dependent fracture of soft polymers with dynamic crosslinks has been experimentally studied (Luo et al., 2014, Liu et al., 2019b, Song et al., 2021, Zhao et al., 2022, Chen and Ravi-Chandar, 2023, Bai et al., 2018, Liu et al., 2021). Mayumi and co-workers (Mayumi et al., 2016) conducted notched tension tests on Polyvinyl alcohol gels and noticed

a significant decrease in failure stretch with increasing loading rates. Shen and co-workers (Shen et al., 2021a) performed notched pure shear tests on EPS25 vitrimer with multi-step loading profiles. The authors observed loading rate-dependent flow-fracture (crack blunting-advancing) transitions. Qi and co-workers (Qi et al., 2024) presented a method to map the dissipation field during crack propagation in viscous soft polymers and enable individual evaluation of the intrinsic and dissipative components of fracture toughness. A nonlinear constitutive model was used by the authors to evaluate the stress field and, hence, the total energy density supplied through mechanical work at each material point. The dissipation field was then obtained by subtracting the free energy density field evaluated using the constitutive model from the total energy density field.

Modeling of the rate-dependent fracture in dynamically crosslinked soft polymers and viscous polymers is limited and has been restricted to crack tip stress field analyses (Guo et al., 2018, 2019, Hui et al., 2019, Liu et al., 2019b) or crack tip driving force based approach (Shen and Vernerey, 2020, Shen et al., 2021a, Ciavarella, 2024) for specific pre-cracked geometries. The crack tip stress field asymptotic analyses use the deformation and stress fields near the crack tip to predict fracture. The crack tip driving force approach relates crack propagation velocity to the energy release rate. Models with the ability to predict crack nucleation, propagation, and coalescence in arbitrary, complex geometries are lacking and are necessary for solving a general class of problems. The gradient damage approach used for modeling mechanical damage and complete failure in a broad range of materials is a suitable choice for this purpose (Miehe et al., 2010b, Narayan and Anand, 2019, 2021, Kuhl et al., 2000, Konica and Sain, 2021, Yang et al., 2024, Hu et al., 2020, Behera et al., 2022, Du et al., 2024).

Critical gaps in modeling and predicting damage initiation, growth, and fracture of soft polymers are (i) the establishment of a unique physical parameter to quantify fracture resistance of soft polymers and (ii) the development of a unified model to predict damage initiation and growth using the gradient damage approach which is generally applicable for soft polymers that range from viscous polymers to elastomers and is independent of loading history and specimen geometry.

For rate-dependent soft polymers, we considered Polyborosiloxane (PBS). PBS is a dynamically crosslinked, rate-stiffening soft polymer that is highly viscous at long timescales with a significantly rate-dependent mechanical response (Li et al., 2014a, Tang et al., 2016, Zhao et al., 2021, 2020a, Kim et al., 2022). PBS flows under its weight in long timescales (minutes) and exhibits a rubber-like response with a significant shape recovery upon deformation when subjected to high loading rates. The rate-dependent fracture response of PBS has not been experimentally studied and corresponding models have not been developed,



which are critical given viscous polymers such as PBS’s broad applications, which include self-healing sensing and actuation (Narumi et al., 2019, Wang et al., 2018, Liu et al., 2019a) and flexible impact mitigation (Tu et al., 2023, Myronidis et al., 2022).

Below are the main contributions of this paper:

- (i) We have proposed and shown that a critical value of stress work  $W_{cr}$  can be an approximately unique measure for experimental assessment of fracture resistance of soft polymers. It quantifies the total energy dissipation per unit volume for the complete failure of a material point under a loading mode when it is subjected to loading rates sufficient to cause damage initiation. Complete failure refers to the inability to support any mechanical stress.  $W_{cr}$  can be evaluated using simple experiments involving homogeneous deformation and without a need for constitutive models.
- (ii) We have developed a model to predict damage initiation, damage growth, and complete failure in soft polymers using a multi-mechanism generalized gradient damage framework based on the method of virtual power where the material strength is accounted for<sup>2</sup>. The free energy density contribution from network resistance is formulated considering crosslink relaxation and formation. In our formulation, the number of chain segments that contribute to the free energy and their individual stretches since the time of formation varies with time. This form of free energy reflects microstructural physics and is thermodynamically consistent. The free energy density functions with direct rate dependence proposed in some of the literature are thermodynamically inconsistent. Damage initiation criterion  $\psi_{cr}^+$  (energetic contribution to  $W_{cr}$ ) in the model can be evaluated using a one-dimensional numerical implementation of deformation-only constitutive model and homogeneous deformation experiment (e.g., simple tension test) results.
- (iii) We validated the predictive capabilities of the fracture model for two elastomers (EPDM, SBR), a viscous soft polymer (EPS25 vitrimer), and PBS.

## 2. Fracture in soft polymers

Notches and cracks in soft polymers undergo a significant amount of blunting before fracture initiation (Miehe and Schänzel, 2014, Luo et al., 2014). Hence, geometric non-linearity due to the large deformation corresponding to blunting has to be accounted for along with material non-linearity. Figure 1 depicts key observations during the deformation

---

<sup>2</sup>This method uses explicit criteria for damage initiation in contrast to the variational phase field method which minimizes an energy function to predict damage initiation. The limitations of the variational phase field method have recently been discussed in (Lopez-Pamies et al., 2025)

and fracture of PBS. To fabricate PBS, hydroxy-terminated Polydimethylsiloxane (PDMS, Sigma Aldrich 481963, 750 cSt) and Boric Acid (BA, Sigma Aldrich B0394, ACS reagent,  $\geq 99.5\%$ ) were mixed in the ratio 160:1 by weight. The mixture was stirred and then heated at  $120^\circ\text{C}$  for 72 hrs to obtain PBS (Konale et al., 2023). The mass density of PBS was measured to be  $1100 \text{ kg m}^{-3}$ . A notched PBS specimen in Figure 1A was stretched at slow (6 mm/s) and fast (60 mm/s) rates. All tension tests on PBS in this work were conducted using the UniVert Mechanical Test System (CellScale) and at  $23^\circ\text{C}$ . Three replicates were performed for each experimental result reported. We applied 3D-printed Poly(lactic acid) (PLA) custom fixtures to avoid creeping of PBS under the clamping pressure of conventional spring-loaded grips. In the custom fixtures shown in Figure 1A, parts of the specimen outside the gauge length are glued to the fixture’s interior faces using a cyanoacrylate adhesive. PBS’s rate-dependent fracture response is highlighted in Figure 1B through a transition from high extensibility at a slow deformation rate without fracture to fracture with low extensibility at a fast loading rate. Figure 1C shows the specimen geometry evolution with stretching load through damage evolution and complete failure at the 60 mm/s loading rate. The high extent of notch blunting before notch propagation can be observed in Figure 1C. The presence of viscous effects in soft polymers results in a trumpet-like early fracture profile (formation of second local notch ahead of the original blunted notch) (de Gennes, 1996, Hui et al., 2022). Figure 1D shows deformation profiles prior to complete fracture in notched PBS and notched Polydimethylsiloxane (PDMS) elastomer (Lee et al., 2024) specimens. Compared to the trumpet profile for PBS, the elastomer exhibits a single parabola-like fracture profile. The single parabola-like fracture profile for elastomers has been well documented in literature (Qi et al., 2019, Shrivastava et al., 2023). A fracture model for soft polymers such as the one proposed in this work, in addition to accurately predicting the failure loads, should predict these significantly varying physical phenomena observed in experiments.

### 3. A fracture resistance measure for soft polymers

In permanently crosslinked soft polymers that fracture by crosslink failure, i.e., polymer chain backbone bonds are stronger than crosslinks, it can be assumed that all crosslinks at a material point fail simultaneously (Mao and Anand, 2018a). The weak crosslinks in dynamically crosslinked soft polymers are constantly breaking and reforming, even in an undeformed state. This dissociation rate is amplified by stretching of the corresponding subchains with respect to the stress-free subchain formation configuration (Song et al., 2021, Venkata et al., 2021). Subchains denote parts of chain molecules between two crosslinks connected to the elastically active network. All subchains in a volume element in a dynamically crosslinked soft polymer can be broken simultaneously only when they are stretched equally to the level

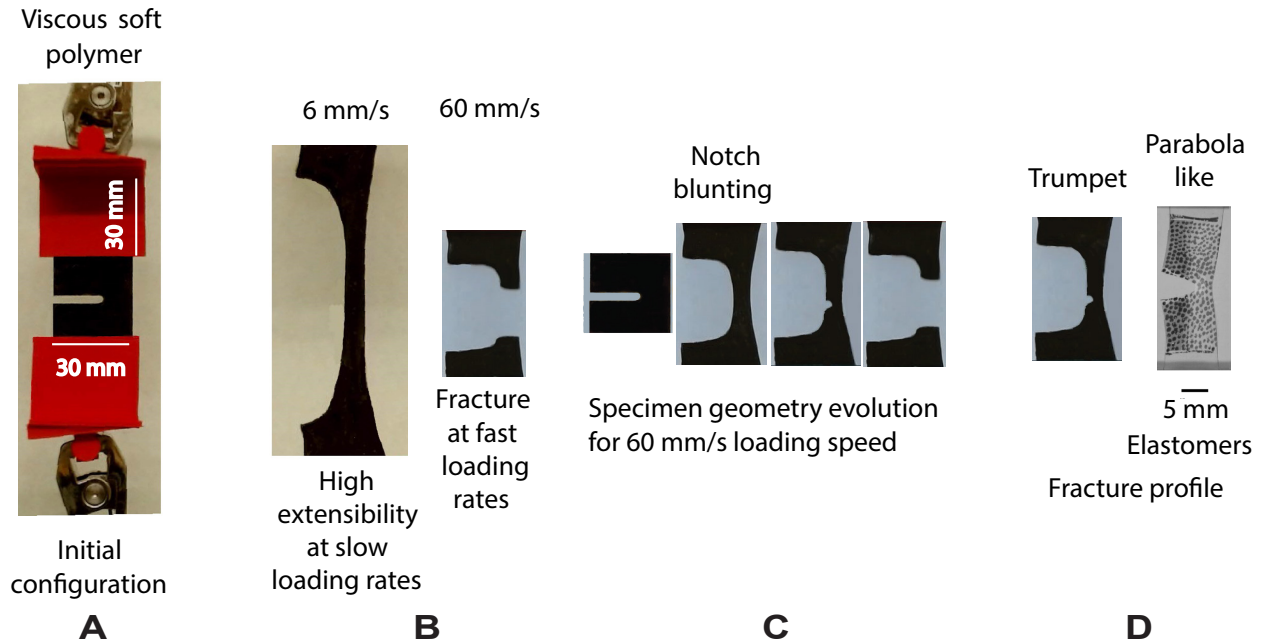

Figure 1: **Fracture phenomenon in soft polymers.** (A) Geometry of a notched PBS specimen and experiment schematic. The thickness of the specimen is 3.2 mm. PBS was colored for visualization. (B) High extensibility of the notched PBS specimen when stretched at a slow loading speed (6 mm/s). Fracture of the specimen at a fast loading speed (60 mm/s). (C) Specimen geometry evolution till complete failure for the 60 mm/s loading speed. Significant notch blunting occurs before notch propagation. (D) Trumpet fracture profile (formation of second local notch ahead of the original blunted notch) in the rapidly stretched notched PBS specimen. A single parabola-like fracture profile experimentally observed in PDMS elastomer (image from J. Lee and co-workers (2024) (Lee et al., 2024) reproduced with Creative Commons [CC BY-NC-ND 4.0 - <https://creativecommons.org/licenses/by-nc-nd/4.0/>] copyright license).

corresponding to stretch-induced dissociation. This scenario, however, can occur only at infinitely fast rates, which is not practically feasible. At adequate fast rates, a sufficient number of subchains surviving from close to time  $t = 0$  will dissociate from the elastically active network, creating voids. These voids will coalesce and lead to the complete failure of a volume element (Shen et al., 2021a). A measure of fracture resistance here can thus be thought of as a critical value of input energy density beyond which network stretching and subsequent damage in the form of stress-accelerated subchain dissociation becomes more dominant than network reconfiguration.

Stress work defined as

$$W(X_i, t) = \int_0^t \frac{1}{2} S_{ij} \dot{C}_{ij} dt, \quad (3.1)$$

quantifies the total energy density per unit referential volume supplied to a material point  $X_i$

due to the work done by external macroscopic forces in the scenarios where kinetic energy is negligible.  $S_{ij}$ ,  $C_{ij} = F_{ki}F_{kj}$  are the second Piola-Kirchoff stress and the right Cauchy-Green deformation tensors, respectively, with  $F_{ij}$  being the deformation gradient tensor.  $W_{cr}$  is defined as the value of  $W$ , i.e., the total energy per unit referential volume that needs to be supplied for the complete failure of a material point subjected to sufficiently fast loading rates for damage initiation. Irrespective of the strain rate value under consideration, the same number of bonds have to be broken for the complete failure of a material point. A common loading mode-based response asymmetry observed in soft polymers is tension-compression asymmetry (Drozdov and deC. Christiansen, 2020, Huang et al., 2016).  $W_{cr}$ 's value can then be different in tension and compression for these soft polymers. However, for a given loading mode, i.e., tension, compression, etc., the hypothesis is that  $W_{cr}$  is a unique value with respect to loading rates and specimen geometries<sup>3</sup>.  $W_{cr}$  can be evaluated using relatively simple experiments involving homogeneous deformation and without constitutive models. For a uniaxial tensile loading,  $W_{cr}$  is equivalent to the standard modulus of toughness, which is defined as the area under engineering stress-strain curve in a uniaxial tensile test till complete specimen failure (Roylance, 2001, Brostow et al., 2015). The unit of  $W_{cr}$  is  $\text{J}/\text{m}^3$  in contrast to  $\text{J}/\text{m}^2$  for the conventional fracture toughness measures (Yin et al., 2021, Mai and Powell, 1991). The standard energy release rate is the measure of loss of energy per unit area of crack growth (Li et al., 1985, Budiansky and Rice, 1973). It is usually dependent on the constraints created at the crack tip by the amount of material, i.e., specimen dimensions considered (Kang et al., 2005, Zhu and Joyce, 2012). On the contrary,  $W_{cr}$  considers the energy density associated with the complete failure of an arbitrary material point. Hence, the value of  $W_{cr}$  should be independent of specimen dimensions.

We now utilize experimental stress-strain curves for a few soft polymers to demonstrate the negligible dependence of  $W_{cr}$  on strain rate. Zhao and co-workers (Zhao et al., 2020b) synthesized a rate-dependent soft polymer with dynamic crosslinks [TFPM-PDMS-25000:

---

<sup>3</sup>Soft polymers including elastomers can exhibit near incompressibility (Barney et al., 2022, Gurvich and Fleischman, 2003, Kadapa and Hossain, 2022). For the case of pure hydrostatic tension, as incompressibility is approached, the deformation until fracture will be small. But  $W_{cr}$  will not be zero under this loading as the ground-state bulk modulus ( $K$ ) of a nearly incompressible polymer is quite large, resulting in finite  $W_{cr}$ . For the volumetric part of free energy density ( $\psi$ ), if the simple functional form of  $\frac{1}{2}K (J - 1)^2$  is considered, then under purely dilatational deformation,  $\psi = \frac{1}{2}K (J - 1)^2$ , with  $J = \det F_{ij}$ . For a purely elastic polymer,  $W = \psi$ . As an example, if the ground state Young's modulus and Poisson's ratio of such a nearly incompressible polymer are taken as 2 MP and 0.4999, respectively,  $K$  will be 3.3 GPa. Further, if  $J_{cr}$  under purely tensile dilatational deformation is arbitrarily considered to have a very low value of 1.001, then we get  $W_{cr} = 1.6 \text{ kPa}$ , *which is a significant non-zero value*. This can also be attributed to the non-zero energy density needed for the dissociation of a finite number of bonds leading to the failure of a material point.

4-[tris(4-formylphenyl)methyl]benzaldehyde (TFPM) used as a tetratopic linker to crosslink PDMS]. The mechanical response of TFPM-PDMS-25000 under uniaxial tensile loading at different stretching speeds was also characterized in the paper. Results are shown in Figure 2A. We calculated  $W_{cr}$  for each loading rate by evaluating the area under the corresponding engineering stress-strain curve.  $W_{cr}$  values as a function of strain rate are shown in Figure 2B.  $W_{cr}$  is approximately constant over one decade of strain rate considered. Polyurethane’s (2% w/w of Polyethylene glycol with respect to Palm-based polyol content) rate-dependent mechanical response reported by Somarathna and co-workers (Somarathna et al., 2020) is shown in Figure 2C with uniaxial tensile engineering stress-strain curves over a range of strain rates. We calculated  $W_{cr}$  for each strain rate from the corresponding engineering stress-strain curve. We show that  $W_{cr}$  is roughly constant over two decades of strain rate through Figure 2D. Over this range of strain rate, energy release rate, and crack tip field measures for rate-dependent soft polymers can vary by an order of magnitude or more (Song et al., 2021, Long and Hui, 2016). We also show a negligible variation in  $W_{cr}$  value for different loading modes by evaluating  $W_{cr}$  from the stress-strain data for Ecoflex elastomer (material has no loading mode-based response asymmetries) reported by Ahmad and co-workers (Ahmad et al., 2019). Results of homogeneous uniaxial tension (UX), pure shear (PS), and equibiaxial tension (EB) tests performed by the authors at a constant engineering strain rate of  $0.3 \text{ s}^{-1}$  are shown in Figure 2E. We evaluated  $W_{cr}$  for each loading mode from the corresponding engineering stress-strain curves.  $W_{cr}$  is approximately constant for the three loading modes considered: 2 MPa (UX), 1.6 MPa (PS), and 1.7 MPa (EB), as shown in Figure 2F. These examples further support our hypothesis that within a reasonable approximation,  $W_{cr}$  can be used as a scalar measure of fracture resistance of soft polymers.

#### 4. Multi-mechanism fracture modeling framework

We follow the Kroner-Lee (Kröner, 1959, Lee, 1969, Kothari et al., 2019, Niu et al., 2023) multiplicative decomposition of the deformation gradient tensor  $F_{ij}$  into elastic and plastic parts  $F_{ij}^e$  and  $F_{ij}^p$ , respectively and the parallel multi-mechanism generalization of the multiplicative decomposition used in elastic-viscoplastic and viscoelastic constitutive theories for polymers (Boyce et al., 1988, 1989, Vogel et al., 2014, de Rooij and Kuhl, 2016, Bergström and Boyce, 1998, Anand et al., 2009, Ames et al., 2009, Srivastava et al., 2010a,b). We consider an isothermal framework for materials that can be idealized as isotropic. For the general framework,  $M$  parallel mechanisms of deformation are considered. Damage variables  $d^{(q)}(X_i, t) \in [0, 1]$ ,  $q \in [1, M]$  corresponding to each micro-mechanism are introduced to model damage and subsequent fracture. We set the general criteria to be  $d^{(q)}(X_i, t) = 0$  for undamaged and  $d^{(q)}(X_i, t) = 1$  for completely damaged mechanism  $q$  at a material point  $X_i$ .

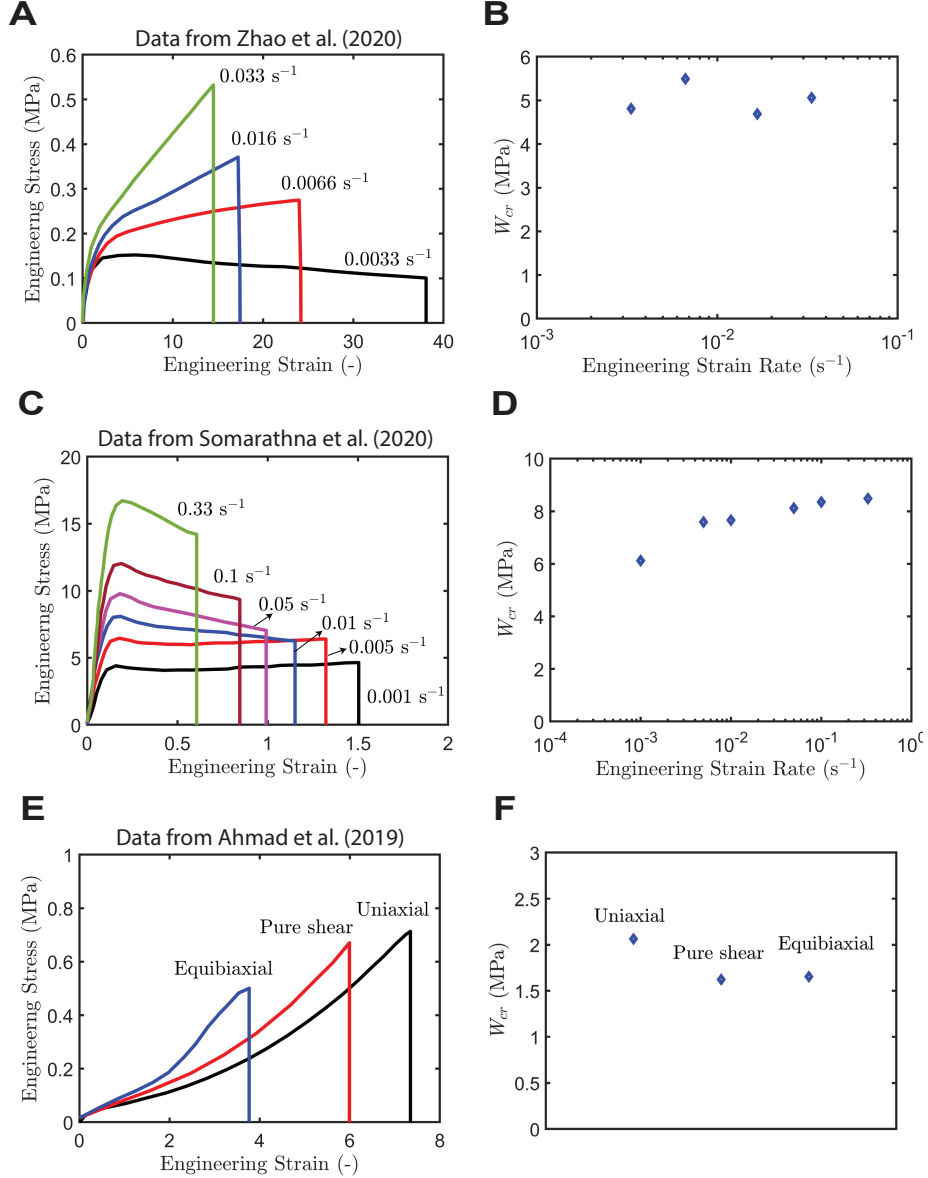

Figure 2: **Approximately constant  $W_{cr}$  for broad loading rates and loading modes.** (A) Engineering stress-strain curves at different strain rates for a rate-dependent viscous soft polymer with dynamic crosslinks (TFPM-PDMS-25000) from (Zhao et al., 2020b). (B)  $W_{cr}$  evaluated as the area under the stress-strain curve is approximately constant over the decade of strain rate considered. (C), (D) Engineering stress-strain curves for polyurethane from (Somarathna et al., 2020) and roughly constant  $W_{cr}$  evaluated over two decades of strain rates, respectively. (E) Uniaxial tension, Pure shear, and Equibiaxial tension engineering stress-strain curves for Ecoflex elastomer at a stretch rate of 0.3 s<sup>-1</sup> from (Ahmad et al., 2019). (F) Ecoflex’s approximately constant  $W_{cr}$  evaluated for three different loading modes considered.

$W_{cr}$  in a multi-mechanism sense can be interpreted as the value of  $W$  when the damage fields

for all mechanisms  $(d^{(1)}, d^{(2)}, \dots, d^{(M)})$  reach the value of 1 at a material point subjected to loading rates sufficiently fast to cause damage initiation in each mechanism. The method of virtual power is now used to derive the macroscopic and microscopic force balances.

#### 4.1. Method of virtual power for multi-mechanism deformation and damage

The kinematic rate-like descriptors in the framework, while considering  $M$  parallel mechanisms of deformation that capture the mechanical response of a material, are taken as

$$\dot{\chi}_i, \dot{F}_{ij}^{e(1)}, \dot{F}_{ij}^{e(2)}, \dots, \dot{F}_{ij}^{e(M)}, \dot{\epsilon}^{p(1)}, \dot{\epsilon}^{p(2)}, \dots, \dot{\epsilon}^{p(M)}, \dot{d}^{(1)}, \dot{d}^{(2)}, \dots, \dot{d}^{(M)}, \frac{\partial \dot{d}^{(1)}}{\partial X_i}, \frac{\partial \dot{d}^{(2)}}{\partial X_i}, \dots, \frac{\partial \dot{d}^{(M)}}{\partial X_i}. \quad (4.1)$$

$\chi_i$  is a smooth one-to-one mapping of a material point  $X_i$  to its position in the deformed configuration  $x_i$  as  $x_i = \chi_i(X_1, X_2, X_3, t)$ .  $F_{ij} = \frac{\partial \chi_i}{\partial X_j}$  is the deformation gradient tensor.  $F_{ij}^{e(q)}$  and  $F_{ij}^{p(q)}$  are the elastic and plastic parts of  $F_{ij}$  in mechanism  $q \in [1, M]$  following the multiplicative decomposition  $F_{ij} = F_{ik}^{e(q)} F_{kj}^{p(q)}$ .

$$\dot{\epsilon}^{p(q)} \stackrel{\text{def}}{=} \sqrt{D_{ij}^{p(q)} D_{ij}^{p(q)}}, \quad D_{ij}^{p(q)} = \frac{1}{2} \left( \dot{F}_{ik}^{p(q)} F_{kj}^{p(q)-1} + F_{ki}^{p(q)-1} \dot{F}_{jk}^{p(q)} \right), \quad \epsilon^{p(q)} \stackrel{\text{def}}{=} \int_0^t \dot{\epsilon}^{p(q)} dt, \quad (4.2)$$

$$d^{(q)} \in [0, 1] \quad : \quad q \in [1, M],$$

are a measure of plastic strain rate, plastic stretching tensor corresponding to  $F_{ij}^{p(q)}$ , a measure of plastic strain, and damage variable respectively for mechanism  $q$ . The model is developed for isotropic materials, and consequently, the assumption of plastic irrotationality is valid. The definition of velocity gradient  $L_{ij} (= \dot{F}_{ik} F_{kj}^{-1})$  and the multiplicative decomposition of  $F_{ij}$  result in the following constraints

$$\frac{\partial \dot{\chi}_i}{\partial X_k} F_{kj}^{-1} = \dot{F}_{ik}^{e(q)} F_{kj}^{e(q)-1} + \dot{\epsilon}^{p(q)} F_{ik}^{e(q)} N_{kl}^{p(q)} F_{lj}^{e(q)-1}, \quad N_{ij}^{p(q)} = \frac{D_{ij}^{p(q)}}{\left( \sqrt{D_{kl}^{p(q)} D_{kl}^{p(q)}} \right)} : \forall q \in [1, M], \quad (4.3)$$

where  $N_{ij}^{p(q)}$  is the plastic flow direction for mechanism  $q$ . Evolution of a reference body  $B$  and an arbitrary part of it denoted by  $P$  with outward unit normal  $n_i^R$  on its boundary  $\partial P$  is associated with macroscopic and microscopic force systems. The macroscopic system is defined by (i) traction  $t_i^R$  corresponding to  $n_i^R$  and generalized body force per unit referential volume  $b_i^R$  expending power on  $\dot{\chi}_i$ . Specifically,  $b_i^R = b_i^{0R} - \rho_R \ddot{\chi}_i$ , with  $b_i^{0R}$  being the conventional body force per unit referential volume,  $-\rho_R \ddot{\chi}_i$  representing the inertial body force per unit referential volume,  $\rho_R$  denoting the referential mass density and (ii) elastic stress  $P_{ij}^{e(q)}$  expending power over the elastic distortion rate  $\dot{F}_{ij}^{e(q)}$ .

The microscopic system is defined with: (i) scalar microscopic stresses  $\pi^{(q)}$  expending power over  $\dot{\epsilon}^{p(q)}$ , (ii) scalar microscopic stresses  $\bar{\omega}^{(q)}$  expending power over  $\dot{d}^{(q)}$ , (iii) vector microscopic stresses  $\xi_i^{(q)}$  expending power over  $\frac{\partial \dot{d}^{(q)}}{\partial X_i}$  and (iv) scalar microscopic tractions  $\Upsilon^{(q)}(n_i^R)$  expending power over  $\dot{d}^{(q)}$  on the part's boundary. For a given P, the power expended on P by the material external to it ( $\mathcal{W}_{ext}(P)$ ) and the power expenditure within P ( $\mathcal{W}_{int}(P)$ ) respectively, can be expressed as

$$\begin{aligned}\mathcal{W}_{ext}(P) &= \int_{\partial P} t_i^R \dot{\chi}_i da_R + \int_P b_i^R \dot{\chi}_i dv_R + \int_{\partial P} \sum_{q=1}^M \left( \Upsilon^{(q)} \dot{d}^{(q)} \right) da_R, \\ \mathcal{W}_{int}(P) &= \int_P \left( \sum_{q=1}^M \left[ J^{p(q)} P_{ij}^{e(q)} \dot{F}_{ij}^{e(q)} + J^{p(q)} \pi^{(q)} \dot{\epsilon}^{p(q)} + \bar{\omega}^{(q)} \dot{d}^{(q)} + \xi_i^{(q)} \frac{\partial \dot{d}^{(q)}}{\partial X_i} \right] \right) dv_R.\end{aligned}\tag{4.4}$$

Note that the stress powers  $P_{ij}^{e(q)} \dot{F}_{ij}^{e(q)}$ ,  $\pi^{(q)} \dot{\epsilon}^{p(q)}$  in (4.4) are per unit volume ( $J^{p(q)}$ ) of the intermediate space corresponding to  $F_{ij}^{p(q)}$ . Assuming that the fields  $\chi_i, F_{ij}^{e(1)}, F_{ij}^{e(2)}, \dots, F_{ij}^{e(M)}, \epsilon^{p(1)}, \epsilon^{p(2)}, \dots, \epsilon^{p(M)}, d^{(1)}, d^{(2)}, \dots, d^{(M)}$  are known at an arbitrarily chosen time instant, the fields  $\dot{\chi}_i, \dot{F}_{ij}^{e(1)}, \dot{F}_{ij}^{e(2)}, \dots, \dot{F}_{ij}^{e(M)}, \dot{\epsilon}^{p(1)}, \dot{\epsilon}^{p(2)}, \dots, \dot{\epsilon}^{p(M)}, \dot{d}^{(1)}, \dot{d}^{(2)}, \dots, \dot{d}^{(M)}$  need to be specified independently while satisfying the constraints in (4.3). The generalized virtual velocity can be written as

$$\mathcal{V} = (\tilde{\chi}_i, \tilde{F}_{ij}^{e(1)}, \tilde{F}_{ij}^{e(2)}, \dots, \tilde{F}_{ij}^{e(M)}, \tilde{\epsilon}^{p(1)}, \tilde{\epsilon}^{p(2)}, \dots, \tilde{\epsilon}^{p(M)}, \tilde{d}^{(1)}, \tilde{d}^{(2)}, \dots, \tilde{d}^{(M)}).\tag{4.5}$$

The virtual field  $\mathcal{V}$  is rigid if it satisfies

$$(\nabla \tilde{\chi}_i) = \tilde{F}_{ij} = \Omega_{ik} F_{kj}, \quad \tilde{F}_{ij}^{e(q)} = \Omega_{ik} F_{kj}^{e(q)}, \quad \tilde{\epsilon}^{p(q)} = 0, \quad \tilde{d}^{(q)} = 0 : \forall q \in [1, M],\tag{4.6}$$

where  $\Omega_{ij}$  is a spatially constant skew tensor. Here,  $(\tilde{\cdot})$  denotes virtual field quantities. The principle of virtual power requires that

$$\mathcal{W}_{int}(P, \mathcal{V}) = \mathcal{W}_{ext}(P, \mathcal{V}) : \forall \mathcal{V} \text{ and } \mathcal{W}_{int}(P, \mathcal{V}) = 0 : \forall \text{ rigid } \mathcal{V}.\tag{4.7}$$

The total free energy density per unit referential volume  $\psi_R$  can be additively decomposed into contributions from each mechanism of deformation and energetic parts accounting for the effects of gradients in the damage fields  $\psi^{d(q)}$ :  $q \in [1, M]$  as

$$\psi_R = \sum_{q=1}^M \left( J^{p(q)} \psi^{(q)} + \psi^{d(q)} \right), \quad T_{ij} = \sum_{q=1}^M T_{ij}^{(q)},\tag{4.8}$$

where  $\psi^{(q)}$  is the contribution from mechanism  $q$  per unit volume of the corresponding intermediate space ( $J^{p(q)}$ ).  $T_{ij}, T_{ij}^{(q)}$  are the total Cauchy stress and total Cauchy stress



contribution from mechanism  $q$ , respectively.  $\psi^{d^{(q)}}$  can be interpreted as defect energy due to local elastic incompatibilities caused by gradients in the damage field variable  $d^{(q)}$ . This is similar to the interpretation of the free energy contributions due to plastic strain gradients in standard strain-gradient plasticity theories (Lele and Anand, 2009, Reddy, 2011, Gao et al., 1999). The total first Piola-Kirchoff stress  $P_{ij}$ , the total second Piola-Kirchoff stress  $S_{ij}$  and  $T_{ij}$  are related through the following relations

$$P_{ij} = JT_{ik}F_{jk}^{-1} = J\left(\sum_{q=1}^M T_{ik}^{(q)}\right)F_{jk}^{-1} = \sum_{q=1}^M JT_{ik}^{(q)}F_{jk}^{-1} = \sum_{q=1}^M P_{ij}^{(q)}, \quad P_{ij} = F_{ik}S_{kj}, \quad (4.9)$$

$$S_{ij} = JF_{ik}^{-1}T_{kl}F_{jl}^{-1},$$

where  $P_{ij}^{(q)}$  is the total first Piola-Kirchoff stress contribution from mechanism  $q$ .

#### 4.2. Consequences of the method of virtual power: Macroscopic and microscopic stresses for multi-mechanism deformation and damage

The principle of virtual power necessitates that (4.7) is satisfied. To deduce the consequences, any generalized virtual velocity  $\mathcal{V}$  consistent with (4.3) can be chosen. Standard procedure and variational arguments to obtain macroscopic and microscopic force balances (Germain, 1973, Gurtin, 1996, 2002, Gurtin et al., 2010, Narayan and Anand, 2019) are followed, and the results are summarized.

##### 4.2.1 Macroscopic stresses

A  $\mathcal{V}$  with  $\tilde{\epsilon}^{p^{(q)}} \equiv 0$ ,  $\tilde{d}^{(q)} \equiv 0 : \forall q \in [1, M]$  is considered, so that  $\frac{\partial \tilde{\chi}_i}{\partial X_j} = \tilde{F}_{ik}^{e^{(q)}} F_{kj}^{p^{(q)}}$ . Using (4.9) and standard arguments, (4.7) results in

$$t_i^R = P_{ij}n_j^R, \quad \frac{\partial P_{ij}}{\partial X_j} + b_i^{0R} = \rho_R \ddot{\chi}_i : P_{ij}^{(q)} \stackrel{\text{def}}{=} J^{p^{(q)}} P_{ik}^{e^{(q)}} F_{jk}^{p^{(q)-1}} \quad \forall q \in [1, M]. \quad (4.10)$$

(4.10) represents the standard referential forms of macroscopic traction condition and force balance, respectively. The second requirement of the principle of virtual power as given in (4.7) leads to

$$P_{ik}F_{jk} = F_{ik}P_{jk}, \quad (4.11)$$

which is the standard result obtained from macroscopic moment balance.

### 4.2.2 Microscopic stresses

(i) Scalar microstresses  $\pi^{(q)}$

Next we consider a  $\mathcal{V}$  with  $\tilde{\chi}_i \equiv 0_i$ ,  $\tilde{d}^{(q)} \equiv 0 : \forall q \in [1, M]$  and arbitrarily chosen  $\tilde{e}^{p(q)} : q \in [1, M]$ . Two additional stress measures are defined, (i) Symmetric elastic second Piola-Kirchoff stress and (ii) Mandel stress, respectively, as

$$S_{ij}^{e(q)} \stackrel{\text{def}}{=} J^{e(q)} F_{ik}^{e(q)-1} T_{kl}^{(q)} F_{jl}^{e(q)-1}, \quad M_{ij}^{e(q)} \stackrel{\text{def}}{=} C_{ik}^{e(q)} S_{kj}^{e(q)} = J^{e(q)} F_{ki}^{e(q)} T_{kl}^{(q)} F_{jl}^{e(q)-1} : \forall q \in [1, M]. \quad (4.12)$$

$C_{ij}^{e(q)} = F_{ki}^{e(q)} F_{kj}^{e(q)}$  is the elastic right Cauchy-Green deformation tensor for mechanism  $q$ . The first requirement of the principle of virtual power given in (4.7) results in the microscopic force balance

$$\pi^{(q)} = \left( M_{ij}^{e(q)} + M_{ji}^{e(q)} \right) N_{ij}^{p(q)} \quad \forall q \in [1, M]. \quad (4.13)$$

(ii) Scalar microstresses  $\bar{\omega}^{(q)}$  and vector microstresses  $\xi_i^{(q)}$

To obtain  $\bar{\omega}^{(q)}$  and  $\xi_i^{(q)}$ , a  $\mathcal{V}$  with  $\tilde{e}^{p(q)} \equiv 0 : \forall q \in [1, M]$  and  $\tilde{\chi}_i \equiv 0_i$  is considered. Choosing  $\tilde{d}^{(q)} : q \in [1, M]$  arbitrarily, (4.7) yields the microscopic traction conditions and force balances respectively as

$$\Upsilon^{(q)} = \xi_i^{(q)} n_i^R, \quad \frac{\partial \xi_i^{(q)}}{\partial X_i} - \bar{\omega}^{(q)} = 0 : \forall q \in [1, M]. \quad (4.14)$$

A set of thermodynamically consistent constitutive equations along with the above macroscopic and microscopic force balances give the complete set of governing mechanical equations for the model. The internal power expenditure in (4.4) can now be rewritten using (4.12) as

$$\mathcal{W}_{int}(\mathbf{P}) = \int_{\mathbf{P}} \left( \sum_{q=1}^M \left[ \frac{1}{2} J^{p(q)} S_{ij}^{e(q)} \dot{C}_{ij}^{e(q)} + J^{p(q)} \pi^{(q)} \dot{e}^{p(q)} + \bar{\omega}^{(q)} \dot{d}^{(q)} + \xi_i^{(q)} \frac{\partial \dot{d}^{(q)}}{\partial X_i} \right] \right) dv_R. \quad (4.15)$$

### 4.3. Free energy imbalance

Under isothermal conditions, the local form of free energy imbalance can be finally expressed as

$$\dot{\psi}_R - \sum_{q=1}^M \left( \frac{1}{2} J^{p(q)} S_{ij}^{e(q)} \dot{C}_{ij}^{e(q)} + J^{p(q)} \pi^{(q)} \dot{e}^{p(q)} + \bar{\omega}^{(q)} \dot{d}^{(q)} + \xi_i^{(q)} \frac{\partial \dot{d}^{(q)}}{\partial X_i} \right) \leq 0. \quad (4.16)$$

We note here that all the terms involved in (4.16) are frame invariant.

#### 4.4. Constitutive equations for deformation and damage

Using (4.8), the free energy imbalance in (4.16) can be written as

$$\begin{aligned} & \sum_{q=1}^M \left( J^{p(q)} \left( \frac{\partial \hat{\psi}^{(q)}(\Lambda^{(q)})}{\partial C_{ij}^{e(q)}} - \frac{1}{2} S_{ij}^{e(q)} \right) \dot{C}_{ij}^{e(q)} - J^{p(q)} \left( \pi^{(q)} - \frac{\partial \hat{\psi}^{(q)}(\Lambda^{(q)})}{\partial \epsilon^{p(q)}} \right) \dot{\epsilon}^{p(q)} - \left( \bar{\omega}^{(q)} - \frac{\partial \tilde{\psi}_R(\Lambda)}{\partial d^{(q)}} \right) \dot{d}^{(q)} \right. \\ & \left. - \left( \xi_i^{(q)} - \frac{\partial \tilde{\psi}_R(\Lambda)}{\partial \left( \frac{\partial \dot{d}^{(q)}}{\partial X_i} \right)} \right) \frac{\partial \dot{d}^{(q)}}{\partial X_i} \right) \leq 0. \end{aligned} \quad (4.17)$$

where

$$\Lambda^{(q)} = \left( C_{ij}^{e(q)}, \epsilon^{p(q)}, d^{(q)}, \frac{\partial \dot{d}^{(q)}}{\partial X_i} \right) \quad q \in [1, M], \quad \Lambda = (\Lambda^{(1)}, \Lambda^{(2)}, \dots, \Lambda^{(M)}), \quad (4.18)$$

are generalized lists of variables.  $\psi^{d(q)}$  is taken to be dependent on  $d^{(q)}, \frac{\partial \dot{d}^{(q)}}{\partial X_i}$ . The following state relations are assumed

$$S_{ij}^{e(q)} = 2 \frac{\partial \hat{\psi}^{(q)}(\Lambda^{(q)})}{\partial C_{ij}^{e(i)}}, \quad \xi_i^{(q)} = \frac{\partial \tilde{\psi}_R(\Lambda)}{\partial \left( \frac{\partial \dot{d}^{(q)}}{\partial X_i} \right)}, \quad \pi_{en}^{(q)} = \frac{\partial \hat{\psi}^{(q)}(\Lambda^{(q)})}{\partial \epsilon^{p(q)}}, \quad \bar{\omega}_{en}^{(q)} = \frac{\partial \tilde{\psi}_R(\Lambda)}{\partial d^{(q)}} : \forall q \in [1, M], \quad (4.19)$$

with  $\pi^{(q)} = \pi_{en}^{(q)} + \pi_{dis}^{(q)}$ ,  $\bar{\omega}^{(q)} = \bar{\omega}_{en}^{(q)} + \bar{\omega}_{dis}^{(q)}$ . The subscripts *en* and *dis* denote energetic and dissipative parts, respectively. To satisfy the dissipation inequality in (4.17), it is assumed that

$$\pi_{dis}^{(q)} \dot{\epsilon}^{p(q)} \geq 0, \quad \bar{\omega}_{dis}^{(q)} \dot{d}^{(q)} \geq 0 \quad \forall q \in [1, M]. \quad (4.20)$$

The constitutive dependence of  $\psi_R, \psi^{(q)}$ , and  $\psi^{d(q)}$  on the generalized lists of variables in (4.18) can be simplified without significant loss of generality. Specifically,

$$\psi_R = \sum_{q=1}^M \left[ g^{(q)}(d^{(q)}) \psi_o^{(q)+} + \psi_o^{(q)-} + \underbrace{\psi_*^{(q)} [l^{(q)}]^2 \left( \frac{\partial^2 d^{(q)}}{\partial X_i \partial X_i} \right)^2}_{\psi^{d(q)}} \right], \quad \psi_o = \sum_{q=1}^M \psi_o^{(q)}(C_{ij}^{e(q)}), \quad (4.21)$$

where  $0 \leq g^{(q)}(d^{(q)}) \leq 1$  are monotonically decreasing functions which degrade the energy storage with damage growth at a material point.  $\psi_*^{(q)} > 0$  and  $l^{(q)} > 0$  are coefficients with units of energy per unit volume and length scale parameters that control the spread

of the diffuse damage zone corresponding to  $d^{(q)}$ , respectively.  $\psi_o$  is the total undamaged elastic free energy, which is the additive decomposition of contributions ( $\psi_o^{(q)}$ ) from the  $M$  mechanisms of deformation.  $\psi_o^{(q)-}$  is the part of  $\psi_o^{(q)}$  which is dilatational and compressive.  $\psi_o^{(q)+} = \psi_o^{(q)} - \psi_o^{(q)-}$  is the damage driving part of  $\psi_o^{(q)}$ . This split accounts for damage growth being driven only by distortional and tensile dilatational deformation (Amor et al., 2009, Hesammokri et al., 2023).

Further, using (4.21) and (4.19), we get

$$\pi_{en}^{(q)} = 0, \quad \bar{\omega}_{en}^{(q)} = \frac{\partial g^{(q)}(d^{(q)})}{\partial d^{(q)}} \psi_o^{(q)}, \quad \xi_i^{(q)} = 2\psi_*^{(q)} [l^{(q)}]^2 \frac{\partial^2 d^{(q)}}{\partial X_i \partial X_i}. \quad (4.22)$$

Also,  $\pi_{dis}^{(q)}, \bar{\omega}_{dis}^{(q)}$  can be taken in their simplified general forms as

$$\pi_{dis}^{(q)} = g^{(q)}(d^{(q)}) \mathcal{S}^{(q)}(C_{ij}^{e(q)}, \epsilon^{p(q)}) \quad \text{when } \epsilon^{p(q)} > 0, \quad \bar{\omega}_{dis}^{(q)} = \hat{\bar{\omega}}_{dis}^{(q)}(d^{(q)}, \dot{d}^{(q)}), \quad (4.23)$$

with  $\mathcal{S}^{(q)}(C_{ij}^{e(q)}, \epsilon^{p(q)})$ ,  $\hat{\bar{\omega}}_{dis}^{(q)}(d^{(q)}, \dot{d}^{(q)})$  being non-negative so that the reduced dissipation inequalities in (4.20) are satisfied.

## 5. Framework specialization to model soft polymers

### 5.1. Free energy and Cauchy stress

To specialize the fracture modeling framework for soft polymers, we restrict the number of micromechanisms  $M$  to 2 in (4.21). As an approximation, only one damage variable is used. This reflects the commonly observed single load drop corresponding to fracture in experiments for a broad class of soft polymers. The single load drop is also shown in our experiments on PBS notched tension tests (Figure 4B). In the case of multiple load drops observation (King, 2022, Imaoka et al., 2023), different damage variables for each mechanism need to be used. Some works on fracture modeling of composites have incorporated multiple damage variables to account for matrix and filler damage separately (Zhang et al., 2022, Jihai Yuan and Chen, 2022, Li et al., 2024).

#### 5.1.1 Constitutive model for viscous soft polymer PBS

For PBS, the two mechanisms of deformation are taken as: (a) **Intermolecular Resistance (A)**: Elastic and dissipative resistance due to intermolecular interactions between neighboring molecules. (b) **Network Resistance (B)**: stretching of constituent subchains within Boron(B):Oxygen(O) coordinate-bond dynamic crosslinks (Konale et al., 2023).

Specifically,  $\psi_o$  is taken as

$$\begin{aligned}
\psi_o &= \underbrace{\psi_o^{(A)}}_{\text{Intermolecular resistance}} + \underbrace{\psi_o^{(B)}}_{\text{Network resistance}}, \\
&= \underbrace{G \left( E_{ij}^{e(A)\prime} E_{ij}^{e(A)\prime} \right) + \frac{1}{2} K \left( E_{kk}^{e(A)} \right)^2}_{\psi_o^{(A)}} \\
&\quad + \underbrace{\mu \bar{\lambda}_L^2 \left( e^{-k_{ns}t} \zeta(t/0) + \int_0^t \frac{n_{ns}}{n_s} k_s e^{-k_{ns}(t-t')} \zeta(t/t') dt' \right)}_{\psi_o^{(B)}}, \tag{5.1}
\end{aligned}$$

$$\begin{aligned}
\text{with } \zeta(t/t') &= \left[ \left( \frac{\bar{\lambda}(t/t')}{\bar{\lambda}_L} \right) \beta(t/t') + \ln \left( \frac{\beta(t/t')}{\sinh \beta(t/t')} \right) \right]. \\
\text{if } E_{kk}^{e(A)} < 0 : \psi_o^{(A)+} &= G \left( E_{ij}^{e(A)\prime} E_{ij}^{e(A)\prime} \right), \quad \psi_o^{(A)-} = \frac{1}{2} K \left( E_{kk}^{e(A)} \right)^2, \\
\text{else : } \psi_o^{(A)+} &= \psi_o^{(A)}, \quad \psi_o^{(A)-} = 0.
\end{aligned}$$

We note that  $\psi_o^{(B)}$  is purely deviatoric. Any suitable free energy density base function of choice can be used in (5.1) for a specific soft polymer under consideration.  $G > 0$ ,  $K > 0$  are the shear and bulk moduli respectively.  $E_{ij}^{e(A)} = \ln U_{ij}^{e(A)}$  is an elastic logarithmic strain measure, where  $U_{ij}^{e(A)}$  is the right elastic stretch tensor following the polar decomposition of  $F_{ij}^{e(A)}$ .  $A_{ij}^{\prime}$  denotes the deviatoric part of a tensor  $A_{ij}$ . Plastic incompressibility is assumed for mechanism A.  $\bar{\lambda}_L$  is the network locking stretch parameter accounting for finite chain extensibility.  $\bar{\lambda} \stackrel{\text{def}}{=} \sqrt{\frac{C_{kk}^*}{3}}$  is the effective total distortional stretch with  $C_{ij}^*$  being the distortional part of  $C_{ij}$ .  $\mathcal{L}(\cdot) = \coth(\cdot) - \frac{1}{(\cdot)}$  denotes the Langevin function and  $\beta = \mathcal{L}^{-1} \left( \frac{\bar{\lambda}}{\bar{\lambda}_L} \right)$ . The referential number density of chain segments currently in their subchain state (S) and that of chain segments that can be in the subchain state but are not currently (NS) are denoted by  $n_s$  and  $n_{ns}$ , respectively. The underlying dynamic, reversible reactions can be represented as



where  $k_s$  and  $k_{ns}$  are the forward and backward reaction rate parameters, respectively.  $\mu = n_s k_B \theta$  denotes the ground state shear modulus with  $k_B$ ,  $\theta$  denoting the Boltzmann constant and temperature respectively. Kinematic quantities with notation  $(t/t')$  use the relative deformation gradient:  $F_{ij}(t/t') = F_{ik}(t) F_{kj}^{-1}(t')$ , a temporal decomposition of  $F_{ij}$ , which maps the deformed configuration at  $t'$  to the deformed configuration at  $t$  as the input. This accounts for subchains formed at  $t'$  ( $0 < t' < t$ ) and surviving till the current time  $t$  being stretched with respect to their stress-free, relaxed configurations corresponding to  $t'$ .

$\psi_o^{(B)}$  in (5.1) is the summation of the stretching energies of these subchains with different stretch levels corresponding to their formation time instants. This proposed free energy formulation avoids having a thermodynamically inconsistent, explicitly rate-dependent free energy density function that is sometimes proposed in the literature. The degradation function  $g(d)$  is taken as (Miehe et al., 2010a, Mao et al., 2017, Anand et al., 2019, Konica and Sain, 2021, Narayan and Anand, 2021)

$$g(d) = (1 - d)^2. \quad (5.3)$$

The total Cauchy stress is given as

$$\begin{aligned} T_{ij} &= g(d) \left[ \underbrace{T_{ij}^{(A)o+} + T_{ij}^{(B)o}}_{T_{ij}^{o+}} \right] + \underbrace{T_{ij}^{(A)o-}}_{T_{ij}^{o-}}, \\ \text{if } E_{mm}^{e(A)} < 0 : T_{ij}^{(A)o+} &= J^{-1} R_{ik}^{e(A)} \left( 2G E_{kl}^{e(A)\prime} \right) R_{jl}^{e(A)}, \\ T_{ij}^{(A)o-} &= J^{-1} R_{ik}^{e(A)} \left( K E_{mm}^{e(A)} \delta_{kl} \right) R_{jl}^{e(A)}, \\ \text{else : } T_{ij}^{(A)o+} &= J^{-1} R_{ik}^{e(A)} \left( 2G E_{kl}^{e(A)\prime} + K E_{mm}^{e(A)} \delta_{kl} \right) R_{jl}^{e(A)}, \\ T_{ij}^{(A)o-} &= 0, \\ T_{ij}^{(B)o} &= e^{-k_{ns}t} \mu \Gamma_{ij}(t/0) + \int_0^t \frac{n_{ns}}{n_s} k_s e^{-k_{ns}(t-t')} \mu \Gamma_{ij}(t/t') dt', \\ \Gamma_{ij}(t/t') &= J^{-1}(t/t') \frac{\bar{\lambda}_L}{\bar{\lambda}(t/t')} \mathcal{L}^{-1} \left[ \frac{\bar{\lambda}(t/t')}{\bar{\lambda}_L} \right] B_{ij}^{*'}(t/t'). \end{aligned} \quad (5.4)$$

$T_{ij}^o = T_{ij}^{o+} + T_{ij}^{o-}$  is the undamaged total Cauchy stress.  $T_{ij}^{o+}$ ,  $T_{ij}^{o-}$  are the undamaged total Cauchy stress contributions corresponding to  $\psi_o^+$ ,  $\psi_o^-$  respectively.  $T_{ij}^{(A)o} = T_{ij}^{(A)o+} + T_{ij}^{(A)o-}$  and  $T_{ij}^{(B)o}$  are the undamaged total Cauchy stress contributions from mechanisms  $A$  ( $\psi_o^{(A)} = \psi_o^{(A)+} + \psi_o^{(A)-}$ ) and  $B$  ( $\psi_o^{(B)}$ ) respectively (Konale et al., 2023).  $B_{ij} = F_{ik} F_{jk}$  is the total left Cauchy-Green deformation tensor.

### 5.1.2 Broader applicability of the general constitutive model for PBS

Setting  $G = k_{ns} = k_s = 0$  in (5.1) results in  $\psi_o = \mu \bar{\lambda}_L^{-2} \zeta(t/0)$ , which is the eight-chain free energy density function (Arruda and Boyce, 1993) used for elastomers. The effect of  $k_{ns}$ 's value on the mechanical response can be understood easily by setting  $G = 0$  in (5.1) to get  $\psi_o = \psi_o^{(B)}$ . At any given time instant, smaller values of  $k_{ns}$  will result in  $\psi_o$  tending to the eight-chain form  $\mu \bar{\lambda}_L^{-2} \zeta(t/0)$ , i.e., elastomer-like behavior with insignificant network reconfiguration. On the other hand, higher values of  $k_{ns}$  will lead to the departure of  $\psi_o$  from the elastic behavior to significantly viscous behavior with appreciable network

reconfiguration. Hence, *the proposed constitutive model can be used as a general model for a broad class of soft polymers with response varying from elastic to significantly viscous.*

## 5.2. Viscous flow rule for Mechanism A

Assuming plastic irrotationality, plastic incompressibility, and co-directionality of plastic flow, the plastic stretching tensor  $D_{ij}^{p(A)}$  can be expressed as

$$D_{ij}^{p(A)} = \nu^{p(A)} \left( \frac{M_{ij}^{e(A)'}}{2\bar{\tau}^{(A)}} \right), \quad \nu^{p(A)} \stackrel{\text{def}}{=} \sqrt{2} \sqrt{D_{ij}^{p(A)} D_{ij}^{p(A)}}, \quad \bar{\tau}^{(A)} \stackrel{\text{def}}{=} \frac{1}{\sqrt{2}} \sqrt{M_{ij}^{e(A)'}} \sqrt{M_{ij}^{e(A)'}}, \quad (5.5)$$

where  $\nu^{p(A)}$ ,  $\bar{\tau}^{(A)}$  are the equivalent plastic shear strain rate and the equivalent shear stress, respectively. With  $\gamma^{p(A)} \stackrel{\text{def}}{=} \int_0^t \nu^{p(A)} dt$  being an equivalent plastic shear strain rate, we have  $\nu^{p(A)} = \sqrt{2} \dot{\epsilon}^{p(A)}$ ,  $\gamma^{p(A)} = \sqrt{2} \epsilon^{p(A)}$ . Instead of  $\dot{\epsilon}^{p(A)}$ , we use  $\nu^{p(A)}$  as the rate-like kinematic descriptor. The expression for  $\pi^{(A)}$  in (4.13) will have to be divided by  $\sqrt{2}$  to account for the change of  $\dot{\epsilon}^{p(A)}$  to  $\nu^{p(A)}$  as the kinematic descriptor. Using (4.13), (4.22) and (5.5), we have  $\bar{\tau}^{(A)} = \pi^{(A)} = \pi_{en}^{(A)}$ .

Further, it is assumed that  $\mathcal{S}^{(A)}$  in (4.23) depends on  $C_{ij}^{e(A)}$  only through  $\hat{p}^{(A)} = -K E_{kk}^{e(A)} = -K \left( \frac{1}{2} \text{trace}(\ln C_{ij}^{e(A)}) \right)$ . Also,  $\hat{p}^{(A)} = \frac{\bar{p}^{(A)}}{g(d)}$  with  $\bar{p}^{(A)} \stackrel{\text{def}}{=} -\frac{1}{3} M_{kk}^{e(A)}$ .  $\mathcal{S}^{(A)}(C_{ij}^{e(A)}, \nu^{p(A)})$  is chosen to follow a specific form as

$$\mathcal{S}^{(A)}(C_{ij}^{e(A)}, \nu^{p(A)}) = \alpha_p \hat{p}^{(A)} + \mathbf{S} \sinh^{-1} \left[ \left( \frac{\nu^{p(A)}}{\nu_0} \right)^m \right], \quad (5.6)$$

where  $\alpha_p \geq 0$  is a pressure sensitivity parameter. The last term in (5.6) represents a rate-dependent resistance to plastic flow.  $\mathbf{S}$  is an internal variable that models the dissipative friction-like resistance due to the sliding chains.  $\nu_0 > 0$  is a reference strain rate and  $m \in (0, 1]$  is a strain rate sensitivity parameter. The evolution equation for  $\mathbf{S}$  is taken as  $\dot{\mathbf{S}} = h(\bar{\lambda} - 1) \nu$  with initial value  $\mathbf{S}(X_i, 0) = \mathbf{S}_0 > 0$ .  $h$  is a stress-dimensioned material parameter and  $\nu \stackrel{\text{def}}{=} \sqrt{2} \sqrt{D_{ij}^i D_{ij}^i}$  is the total equivalent shear strain rate. The strength relation in (4.23) for mechanism A can now be concisely expressed as

$$\nu^{p(A)} = \begin{cases} 0 & \text{if } \bar{\tau}_e^{(A)} \leq 0, \\ \nu_0 \left[ \sinh \left( \frac{\bar{\tau}_e^{(A)}}{g(d)\mathbf{S}} \right) \right]^{1/m} & \text{if } \bar{\tau}_e^{(A)} > 0, \end{cases} \quad (5.7)$$

where  $\bar{\tau}_e^{(A)} \stackrel{\text{def}}{=} \bar{\tau}^{(A)} - \alpha_p \bar{p}^{(A)}$  denotes a net equivalent shear stress for plastic flow.

### 5.3. Evolution equation for damage variable $d$

The microstructural changes leading to damage in soft polymers like PBS that exhibit dynamic crosslinking are thought to be reversible, i.e., failure of weak dynamic, reversible crosslinks (Song et al., 2021, Shen et al., 2021a, Shen and Vernerey, 2020). However, *short timescales for complete damage growth* with respect to the dynamic crosslink macroscopic formation timescale ( $\tau_f$ ) would suggest that damage, if initiated, will grow monotonically. Specimen geometry and experiment schematic for a notched tension test performed at 60 mm/s loading speed are shown in Figure 4(b). The sharp load drop corresponding to fracture in Figure 4(b) for the notched PBS specimen ( $\tau_f$  is in the order of seconds for PBS (Konale et al., 2023)) highlights the rapid damage growth in PBS. Therefore, we adhere to the modeling approach used for irreversible damage growth (Narayan and Anand, 2019, Konica and Sain, 2021).

Following Narayan and Anand (Narayan and Anand, 2019), the scalar microstress  $\bar{\omega}_{dis}$  in (4.23) is taken in the following specific form

$$\bar{\omega}_{dis} = \alpha + \zeta \dot{d} : \alpha = 2(1-d)\psi_{cr}^+ + 2\psi_*d > 0 \text{ with } \psi_{cr}^+ > 0, \psi_* > 0, \quad (5.8)$$

where  $\psi^*$ ,  $\psi_{cr}^+$  are coefficients with units of energy per unit volume, and  $\zeta > 0$  is a constant kinetic modulus so that the dissipation inequality is satisfied when  $\dot{d} > 0$ . The timescale for damage growth is determined by  $\zeta$  with decreasing values of  $\zeta$  leading towards rate-independent damage evolution.  $\psi_{cr}^+ + \psi_*$  represents a part of the energy dissipated per unit volume as  $d$  grows from 0 to 1. The microforce balance in (4.14) along with (4.19) and (5.8) gives the evolution equation for  $d$  as

$$\zeta \dot{d} = 2(1-d)\mathcal{H} - 2\psi_* \left( d - l^2 \frac{\partial^2 d}{\partial X_i \partial X_i} \right), \quad (5.9)$$

where  $\zeta > 0$  is a constant kinetic modulus.  $\zeta$  determines the timescale of damage growth with decreasing values of  $\zeta$  leading towards rate-independent damage evolution.  $\mathcal{H}$  is a monotonically increasing history function expressed as

$$\mathcal{H}(t) \stackrel{\text{def}}{=} \max_{s \in [0, t]} [\langle \psi_o^+(s) - \psi_{cr}^+ \rangle], \quad (5.10)$$

$$\langle \psi_o^+(s) - \psi_{cr}^+ \rangle = \begin{cases} 0 & \text{if } \psi_o^+(s) - \psi_{cr}^+ < 0, \\ \psi_o^+(s) - \psi_{cr}^+ & \text{if } \psi_o^+(s) - \psi_{cr}^+ \geq 0 \text{ and } \psi_o^{(B)} \geq \psi_{cr}^{(B)}. \end{cases}$$

Damage initiates only when  $\psi_o^+$  reaches the critical value  $\psi_{cr}^+$  (the energetic contribution to  $W_{cr}$ ) along with  $\psi_o^{(B)} = \psi_{cr}^{(B)}$ <sup>4</sup>. Here, material strength is explicitly accounted for.

---

<sup>4</sup>A macroscopic stretch measure, e.g.,  $\bar{\lambda}(t/0)$  by itself, cannot be used as a criterion for damage initiation.



$\psi_{cr}^+ + \psi_*$  represents a part of the energy dissipated per unit referential volume as  $d$  grows from 0 to 1.  $\psi_*$  denotes additional referential energy density dissipated as  $d$  increases from 0 to 1. In this paper, we have focused on fracture under an overall tensile loading. For soft polymers with tension-compression response asymmetry, different values for the parameter set  $\{\psi_{cr}^+, \psi_*, l, \zeta\}$  can be used under compressive loading. This change of parameter values can be triggered using the field variable, which governs the tension-compression response asymmetry in the constitutive model.

The complete set of model parameters for deformation, damage initiation and damage growth are

$$\underbrace{\{k_s, k_{ns}, n_s, G, K, \nu_0, m, \alpha_p, S_0, h, \bar{\lambda}_L\}}_{\text{deformation}}, \underbrace{\{\psi_{cr}^+, \psi_*, l, \zeta\}}_{\text{damage}}. \quad (5.11)$$

For incompressible elastomers, the list of model parameters is reduced to

$$\underbrace{\{n_s, \bar{\lambda}_L\}}_{\text{deformation}}, \underbrace{\{\psi_{cr}^+, \psi_*, l, \zeta\}}_{\text{damage}}. \quad (5.12)$$

## 6. Numerical procedure

### 6.1. Finite element implementation of the damage model

The model was implemented in the finite element software ABAQUS which has been acceptably used for engineering simulations involving complex loadings, inhomogeneous deformations, and nonlinear material responses (Konica et al., 2024, Niu and Srivastava, 2022a, Vaishakh et al., 2024, Niu and Srivastava, 2022b, Bai et al., 2021, Zhong and Srivastava, 2021, Srivastava et al., 2011). The damage variable  $d$  is an additional degree of freedom at each node along with displacement. Therefore, implementation in ABAQUS requires the development of user-defined elements. Since the timescales involved are short, explicit formulation was used, and correspondingly, a VUEL (user-defined element with explicit formulation) was developed. Following the recent works outlining the numerical implementation of phase fields models using VUEL (Wang et al., 2020, Yuan et al., 2022, Hai et al., 2024), we split the

---

This can be understood by considering a loading rate much slower than the dynamic crosslink macroscopic relaxation timescale ( $\tau_r$ ). In this case, the polymer network can easily reconfigure. Even when a specimen is subjected to large global deformation, the subchains, due to continuous network reconfigurations, will be stretched by an insignificant amount. For loading rates much faster than  $\tau_r$ , the polymer network will not have sufficient time to reconfigure, and the subchains will undergo a significant amount of stretching upon large specimen deformation. Hence, to capture the extent of subchain stretching,  $\bar{\lambda}(t/0)$  will have to be further supplemented with a measure of loading rate, e.g.,  $\dot{\bar{\lambda}}(t/0)$ .  $\bar{\lambda}(t/0)_{cr}$  will then not be a unique value but dependent on  $\dot{\bar{\lambda}}(t/0)$ . In contrast,  $\psi_{cr}^+$  and  $\psi_{cr}^{(B)}$  are unique values.

problem computationally into (i) a mechanical problem (VUMAT, user-defined mechanical material behavior with inbuilt elements) and (ii) a problem corresponding to the additional degree of freedom  $d$  (VUEL). The evolution of  $d$  at a node is dependent upon quantities evaluated in the mechanical problem (VUMAT), specifically the damage driving history function  $\mathcal{H}$  at the corresponding material (integration) points. Further, to update the total Cauchy stress  $T_{ij}$  at a material point,  $d$  evaluated from the damage problem (VUEL) at the corresponding nodes is required. This information is passed between VUMAT and VUEL using global variables and the VUSDFLD subroutine. The finite element implementation workflow is summarized in Figure 3.

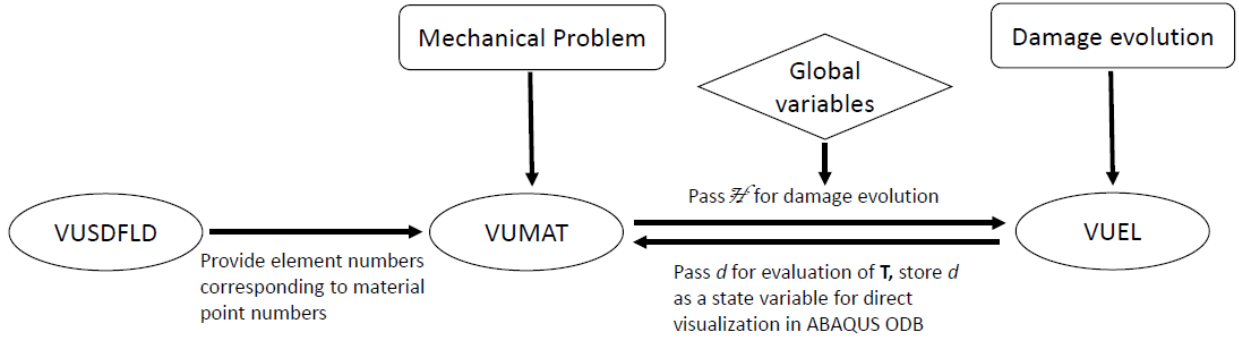

Figure 3: **Summary of the finite element implementation workflow.** The total Cauchy stress tensor  $T_{ij}$  is denoted by  $\mathbf{T}$ .

## 6.2. Numerical update procedure for $T_{ij}^{(B)o}$ and $\psi_o^{(B)}$

The finite element program ABAQUS returns only the deformation gradients from the previous and current time steps at each material point. Direct numerical implementation of the analytical expressions for  $T_{ij}^{(B)o}$  and  $\psi_o^{(B)}$  in ABAQUS will require the storage of the entire deformation gradient history along with many state-dependent variables at each material point. The resulting storage requirement will be huge, making it challenging. A numerical update procedure for  $T_{ij}^{(B)o}$  developed by Konale and co-workers (Konale et al., 2023) is applied, which requires deformation gradients only from the previous and current time steps at each material point. It is summarized as

$$\begin{aligned}
 T_{ij}^{(B)o}(t + \Delta t) &\rightarrow e^{-k_{ns}(t+\Delta t)} \mu \Gamma_{ij}(t + \Delta t/0) + T_{ij}^{(B)o2}(t + \Delta t), \\
 T_{ij}^{(B)o2}(t + \Delta t) &\rightarrow e^{-k_{ns}\Delta t} J^{-5/3}(t + \Delta t/t) F_{ik}(t + \Delta t/t) T_{kl}^{(B)o2}(t) F_{jl}(t + \Delta t/t) \\
 &+ \frac{1}{2} \frac{n_{ns}}{n_s} k_s e^{-k_{ns}\Delta t} \mu \Gamma_{ij}(t + \Delta t/t) \Delta t.
 \end{aligned} \tag{6.1}$$

We apply the procedure to  $\psi_o^{(B)}$  which can be summarized as

$$\begin{aligned}\psi_o^{(B)}(t + \Delta t) &\rightarrow e^{-k_{ns}(t+\Delta t)} \mu [\bar{\lambda}_L]^2 \zeta(t + \Delta t/0) + \psi_{o2}^{(B)}(t + \Delta t) - \mu [\bar{\lambda}_L]^2 \zeta(0), \\ \psi_{o2}^{(B)}(t + \Delta t) &\rightarrow e^{-k_{ns}\Delta t} \psi_{o2}^{(B)}(t) + \frac{1}{2} \left[ \left( \frac{n_{ns}}{n_s} k_s e^{-k_{ns}\Delta t} \mu [\bar{\lambda}_L]^2 \zeta(t + \Delta t/t) \right) \right. \\ &\quad \left. + \left( \frac{n_{ns}}{n_s} k_s \mu [\bar{\lambda}_L]^2 \zeta(t + \Delta t/t + \Delta t) \right) \right] \Delta t.\end{aligned}\tag{6.2}$$

### 6.3. Finite element model reduction using symmetries

For all simulations in this paper, the bottom surface of the specimen is completely fixed, i.e.,  $u_X = u_Y = u_Z = u_X^R = u_Y^R = u_Z^R = 0$ .  $u$ ,  $u_R$  denote the translational and rotational degrees of freedom of a material point about the axis indicated in the subscript. Z and Y axes are parallel to the thickness and height of the specimen, respectively. For quarter block simulations,  $u_X = u_Y^R = u_Z^R = 0$  is prescribed on the symmetry surface with normal along X axis. For both quarter and half block simulations,  $u_Z = u_X^R = u_Y^R = 0$  is prescribed on the symmetry surface with normal along the Z axis. Finally, for all simulations,  $u_Y$  corresponding to the loading profile is prescribed along with  $u_X = u_Z = u_X^R = u_Y^R = u_Z^R = 0$  on the specimen's top surface.

## 7. Model parameter calibration for PBS

Values for all the deformation-associated parameters in (5.11) are taken from Konale and co-workers (Konale et al., 2023). Uniaxial homogeneous tension tests can be used for evaluation of  $W_{cr}$ ,  $\psi_{cr}^+$  and  $\psi_{cr}^{(B)}$ <sup>5</sup>. Dogbone tensile PBS specimens of ASTM D638 Type V standard [gauge dimensions:  $9.5 \pm 1$  mm x  $3.2 \pm 1$  mm x  $3.2 \pm 1$  mm] (International, 2015) were subjected to a stretching speed of 60 mm/s. Displacement was monitored through markers at the two extremes of the gauge length and standard image processing. (3.1) for this loading can be written as

$$W(X_i, t) = \int_0^t s \dot{\lambda} dt \tag{7.1}$$

where  $s$ ,  $\lambda$  are the engineering stress and gauge section stretch in the direction of loading respectively<sup>6</sup>.  $\dot{\lambda}$  was evaluated to be  $4 \text{ s}^{-1}$  and the corresponding  $\sigma$  vs  $t$  curve is shown in

<sup>5</sup>Soft polymers exhibit fast damage evolution through sharp load drops corresponding to fracture (Liu et al., 2019b, Zhao et al., 2020b). Hence,  $W_{cr}$  for soft polymers will be approximately equal to the value of  $W$  at damage initiation ( $\psi_o^+ = \psi_{cr}^+$ ). For hyperelastic materials,  $W_{cr} = \psi_{cr}^+$ , i.e., there are no viscous contributions to  $W$ .  $W_{cr} > \psi_{cr}^+$  for materials with viscous effects.

<sup>6</sup>Analytical expressions for  $W_{cr}$  in the case of uniaxial tension can be obtained for hyperelastic materials using (7.1). E.g., if neo-Hookean model is used:  $W_{cr} = \mu \left( \frac{\lambda_{cr}^2}{2} + \frac{1}{\lambda_{cr}} - \frac{3}{2} \right)$ , if Mooney-Rivlin model is used:

Figure 4A.  $W_{cr} = 0.6$  MPa was calculated using (7.1) with the integration carried till the time instant of complete failure. A one-dimensional version of the model without considering damage was implemented in MATLAB to simulate this experiment and calculate  $\psi_o^+$  and  $\psi_o^{(B)}$ .  $\psi_{cr}^+ = 0.27$  MPa,  $\psi_{cr}^{(B)} = 0.12$  MPa were obtained as the values of  $\psi_o^+$ ,  $\psi_o^{(B)}$  at complete failure.

Although the parameters  $\psi_*$ ,  $l$ ,  $\zeta$  can be fit to the uniaxial tensile test, sensitivity to damage gradients can only be obtained with inhomogeneous deformations, e.g., the notched tension test in Figure 4B. The finite element mesh with a total of 32,468 C3D8R (three-dimensional, reduced integration) stress elements used for simulating the notched tension experiment is shown in Figure 4B. In all the simulations in this work, finer mesh was applied in the regions surrounding the notch to capture the stress and strain gradients. The actual value of the length scale associated with the damage process zone in PBS hasn't been experimentally measured so far. Hence, the length scale parameter  $l$  controlling the spread of the diffuse damage zone is considered to be an adjustable regularization parameter.  $l = 2.5$  mm was chosen to result in a computationally tractable mesh given the specimen dimensions while following the restriction of  $l \gtrsim 5h_e$  (Narayan and Anand, 2021) and being in the range of damage process zone length scales reported for soft polymers (Matsuda et al., 2020, Long et al., 2021, Slotman et al., 2022).  $\psi_*$  and  $\zeta$  were calibrated to fit the load-displacement curve after the load maximum in the notched tension calibration experiment. Model fit to the experimental extension force-displacement curve corresponding to the notched tension test is shown in Figure 4B. Values of the model parameters are listed in Table 1. For PBS, we assume  $k_{ns} = k_s = k$ .

## 8. Model predictions for fracture in a variety of soft polymers

The model is applied to predict fracture in select soft polymers - a permanently crosslinked rubber [ethylene propylene diene monomer (EPDM)], PBS, and dynamically crosslinked EPS25 vitrimer. Also, we show that macroscopic model parameters for PBS can estimate subchain dissociation energy, which is a fracture microstructural process related quantity. Three independent experiments were performed on PBS with different specimen geometries and loading configurations subjected to a range of stretching speeds. The previously calibrated model parameters for PBS obtained using the notched tension experiment in Figure 4B were kept fixed for independent validations. This allowed for an independent true assessment of the model's predictive capabilities for the three validation experiments on PBS.

---

$$W_{cr} = 2C_1\left(\frac{\lambda_{cr}^2}{2} + \frac{1}{\lambda_{cr}} - \frac{3}{2}\right) + 2C_2\left(\lambda_{cr} + \frac{1}{2\lambda_{cr}^2} - \frac{3}{2}\right) \text{ where } C_1, C_2 \text{ are material constants and the ground state shear modulus } \mu = 2(C_1 + C_2).$$

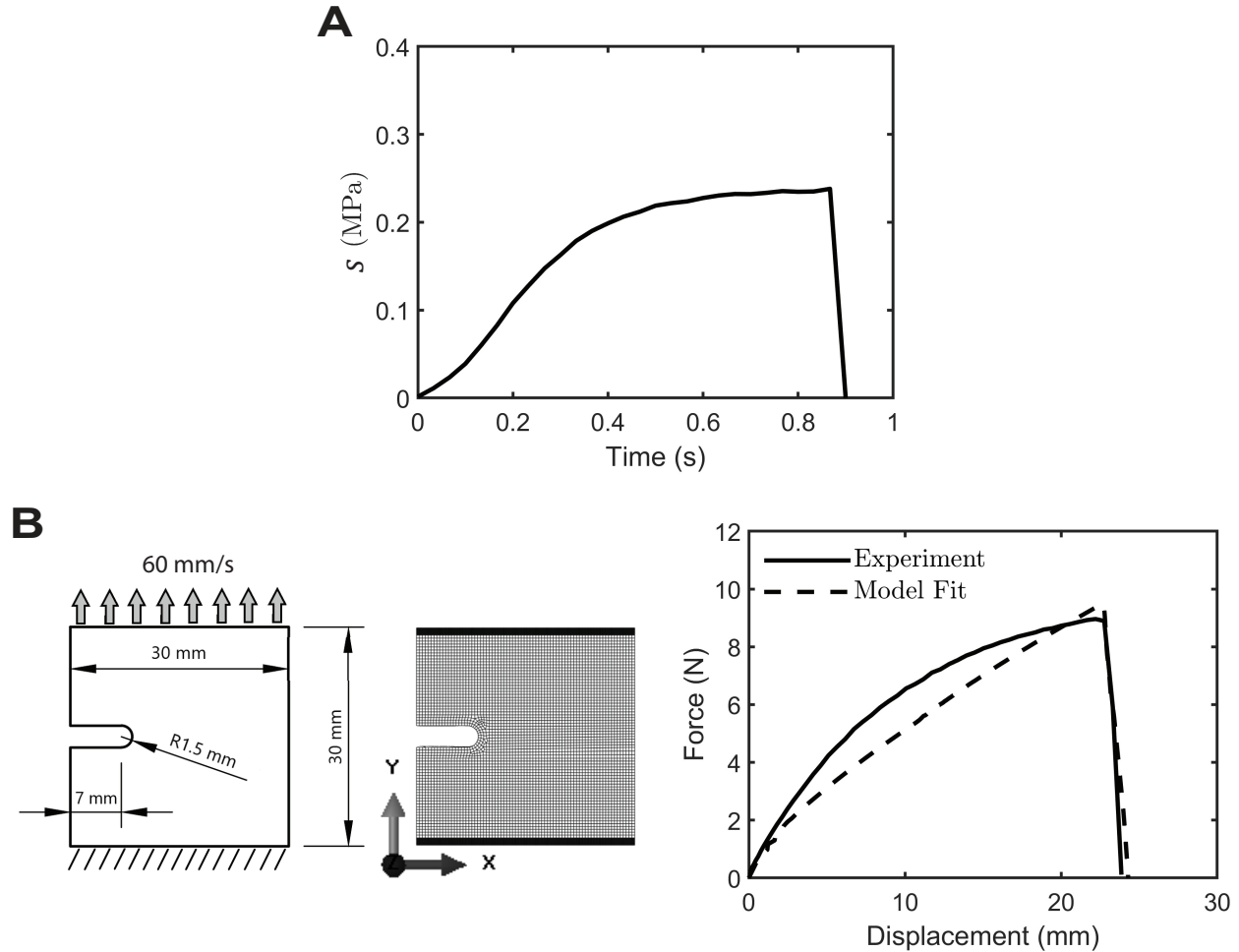

Figure 4: **Fracture model fit to experiments for PBS.** (A) Engineering stress ( $s$ ) vs. time curve for the uniaxial tension experiment on PBS. The gauge section of the specimen undergoes stretching at an engineering strain rate of  $4 \text{ s}^{-1}$ . (B) Schematic for notched PBS tension experiment. The specimen has a thickness of 3.2 mm and was subjected to a loading speed of 60 mm/s. Finite element mesh used for simulation. Fit of the model (dashed lines) to the experimental extension force-displacement curve.

Experimental data reported in (Benvidi et al., 2019) and (Shen et al., 2021a) is used to test the predictive abilities of the proposed model for EPDM rubber and EPS25 vitrimer, respectively. Based on the experimental material response, intermolecular resistance (mechanism A) is neglected for modeling the deformation of EPDM rubber and EPS25 vitrimer in (Benvidi et al., 2019, Shen et al., 2021a), i.e.,  $\psi_o^{(A)} = 0$  and  $\psi_o = \psi_o^{(B)}$ . For the network resistance (mechanism B), the free energy density functions with the dynamic crosslink formulation for the hyperelastic function part were the same as used in (Benvidi et al., 2019, Shen et al., 2021a) for EPDM rubber, EPS25 vitrimer. This also allowed us to test the dynamic crosslink

Deformation		Damage	
Parameter	PBS	Parameter	PBS
$k$ (s <sup>-1</sup> )	0.35	$\psi_{cr}^+$ (MPa)	0.27
$n_s$ (m <sup>-3</sup> )	6.4 x 10 <sup>24</sup>	$\psi_*$ (kPa)	4
$G$ (MPa)	0.4	$l$ (mm)	2.5
$K$ (MPa)	20	$\zeta$ (kPa.s)	1.1
$\nu_0$ (s <sup>-1</sup> )	2 x 10 <sup>-3</sup>		
$m$ (-)	0.95		
$\alpha_p$ (-)	0.11		
$S_0$ (kPa)	0.6		
$h$ (kPa)	37.7		
$\bar{\lambda}_L$ (-)	37.4		

Table 1: **Model parameters for PBS.**

formulation’s predictive capabilities for different hyperelastic free energy density base functions. Deformation-related material parameters for EPDM and EPS25 vitrimer are taken from (Benvidi et al., 2019, Shen et al., 2021a).

### 8.1. PBS: Estimate of subchain dissociation energy using $\psi_{cr}^+$

The referential number density of subchains in PBS surviving from  $t=0$  till any time instant  $t$  ( $n_s(t/0)$ ) can be obtained using the first order kinetics of underlying dynamic reactions (Konale et al., 2023) as equal to  $n_s e^{-k_{ns}t}$ . At the time instant corresponding to the load drop in Figure 4A for the uniaxial tension test, with  $k_{ns} = 0.35$  s<sup>-1</sup> and  $n_s = 6.4$  x 10<sup>24</sup> m<sup>-3</sup>,  $n_s(t/0)$  is equal to 4.7 x 10<sup>24</sup> m<sup>-3</sup>. These subchains experience the highest level of stretch and, hence, will be most likely to undergo stretch-induced dissociation. Hence, it can be assumed that the energy associated with dissociation of 4.7 x 10<sup>24</sup> m<sup>-3</sup> subchains at a material point is  $\psi_{cr}^{(B)}$ . The subchain dissociation energy can then be estimated as 15 kJ/mol. We independently conducted oscillatory rheology experiments on PBS at temperatures of 25 °C, 37 °C and 50 °C shown in Figure 5A till 1 % strain. The experiments were performed using the ARES G2 Rheometer and the cone and plate geometry (40 mm diameter and 0.04 radian cone angle). Three repetitions were performed for each experimental result reported. Konale and co-workers (Konale et al., 2023) established that the crossover frequency in small strain frequency sweep experiments is proportional to the backward reaction rate parameter ( $k_{ns}$ ) for the reversible reaction involving subchain dissociation in (5.2). Assuming Arrhenius temperature dependence of  $k_{ns}$ , the activation energy for the backward reaction, i.e., subchain dissociation, can be obtained by fitting to the crossover frequencies in Figure 5B as 24 kJ/mol, which is in the same order of magnitude as the subchain dissociation

energy (15 kJ/mol). This same order of magnitude similarity between activation energy and subchain dissociation energy is reasonable considering (a) the relative simplicity of the chemical reaction under consideration - only one type of bond (B:O coordinate-bond) is involved and (b) the assumptions made during the estimation analyses. Further, the subchain dissociation energy value lies in the range of weak, non-covalent bond energies reported in the literature (Burley and Petsko, 1988, Wang et al., 2017, Buaksuntear et al., 2022). A physical understanding of the macroscopic fracture model parameters can thus provide reasonable approximations for fracture-related microstructural processes.

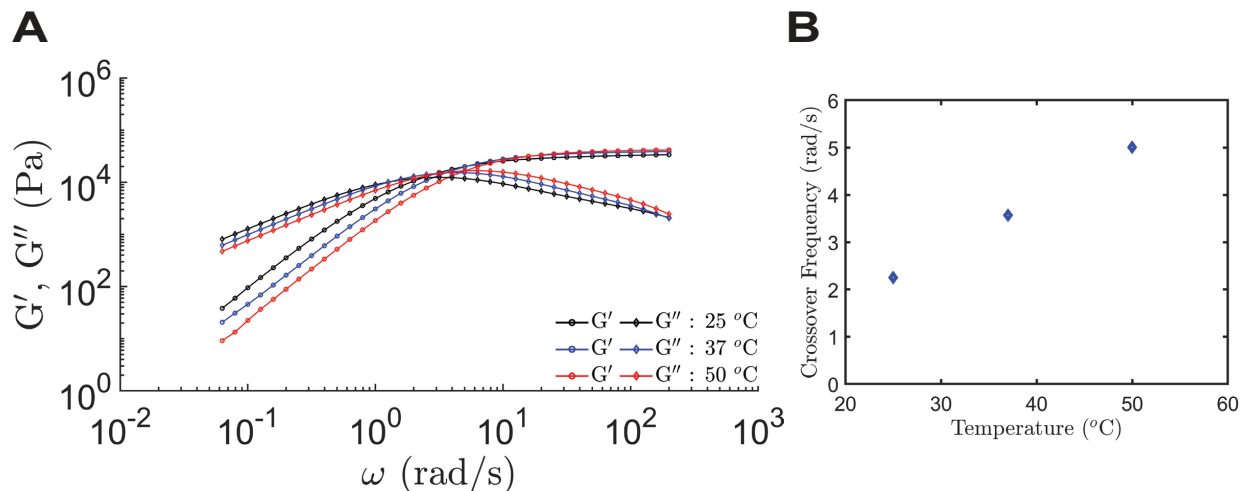

Figure 5: **Oscillatory rheology experiments on PBS to validate subchain dissociation energy estimate obtained using  $\psi_{cr}^+$ .** (A) Oscillatory shear response of PBS (1% shear strain) at 25 °C, 37 °C and 50 °C. (B) Crossover frequency vs. temperature plot for PBS.

### 8.2. PBS: Single edge notch test for validation

A U-shaped edge notch with depth and radius of 18.5 mm and 3 mm, respectively, was created equidistant from the gripping fixtures in the gauge section with dimensions  $30 \pm 2$  mm x  $30 \pm 2$  mm x  $3.2 \pm 1$  mm. This is a much deeper notch than what was used for calibration. The specimen geometry for the experiment schematic shown in Figure 6A was stretched at 60 mm/s. The finite element mesh (31,892 C3D8R elements) used for simulation is shown in Figure 6A. The specimen was stretched until failure. Good agreement between the prediction from simulation and experimental result for the extension force can be seen in Figure 6B. Specimen geometry changes at different displacement levels from the experiment and simulation are shown in Figure 6C, which also shows very good agreement between the experimental and simulation results. Particularly, the trumpet fracture profile (formation of second local notch ahead of the original blunted notch) observed experimentally in Figure

6C[iv] is predicted by the model. Also, the model correctly predicts the transition from rupture with low extensibility at a fast loading rate (60 mm/s) to high extensibility at a slow loading rate (6 mm/s), as shown in Figure 6C. The high extensibility at the relatively slower loading speed of 6 mm/s is due to  $\psi_o^+$ ,  $\psi_o^{(B)}$  at the notch center not being able to exceed  $\psi_{cr}^+$  and  $\psi_{cr}^{(B)}$ , respectively.

### 8.3. PBS: Center notch for validation

To validate the model predictions for PBS in a scenario involving a different notch geometry (same gauge section dimensions and boundary conditions as the single edge notch geometry), a 10 mm x 3 mm slot was created at the center of the gauge section, as shown in Figure 7A. Further, relatively low loading speeds of 2 mm/s and 6 mm/s were used for this geometry. The finite element mesh used for the simulations is shown in Figure 7B. One-quarter of the specimen (25,832 C3D8R elements) was simulated with appropriate boundary conditions considering the symmetries of the problem. For these relatively slower speeds, the experimental results exhibit necking instability in the form of the non-positive slope of force-displacement curves after a certain level of displacement. This can be attributed to significant network reconfiguration occurring over these long timescales (relative to the B:O coordinate bond dynamic crosslink macroscopic relaxation timescale) as a result of dynamic crosslink relaxation and reformation. Model predictions for the force-displacement curves, particularly the displacement levels for the onset of necking instability, agree well with the experimental results as seen in Figure 7C. Fracture doesn't occur for these slow loading speeds which can be attributed to  $\psi_o^+$ ,  $\psi_o^{(B)}$  not being able to exceed  $\psi_{cr}^+$  and  $\psi_{cr}^{(B)}$ , respectively at the notch center. The specimens exhibited high extensibility in the experiments, as shown in Figure 7D through a comparison between the undeformed and deformed shapes.

### 8.4. PBS: Stretching using inserts for validation

The fracture model is now applied to a different loading configuration. The PBS specimen has two 5 mm diameter symmetric holes in the gauge section (same dimensions as the single edge notch geometry) as shown in Figure 8A. 3D-printed hard plastic (PLA) inserts of the same diameter placed in the holes are then used to stretch the specimen. The bottom insert is held fixed while the top insert is displaced at 60 mm/s. Figure 8A shows the experiment schematic. The finite element mesh used for the simulation is shown in Figure 8B. One-quarter of the specimen (29,016 C3D8R elements) was simulated with appropriate boundary conditions considering the symmetries of the problem. The specimen was stretched until failure. The inserts were modeled as rigid analytical surfaces. Contact between the inserts and the specimen was assumed to be frictionless as the interfaces were lubricated in the



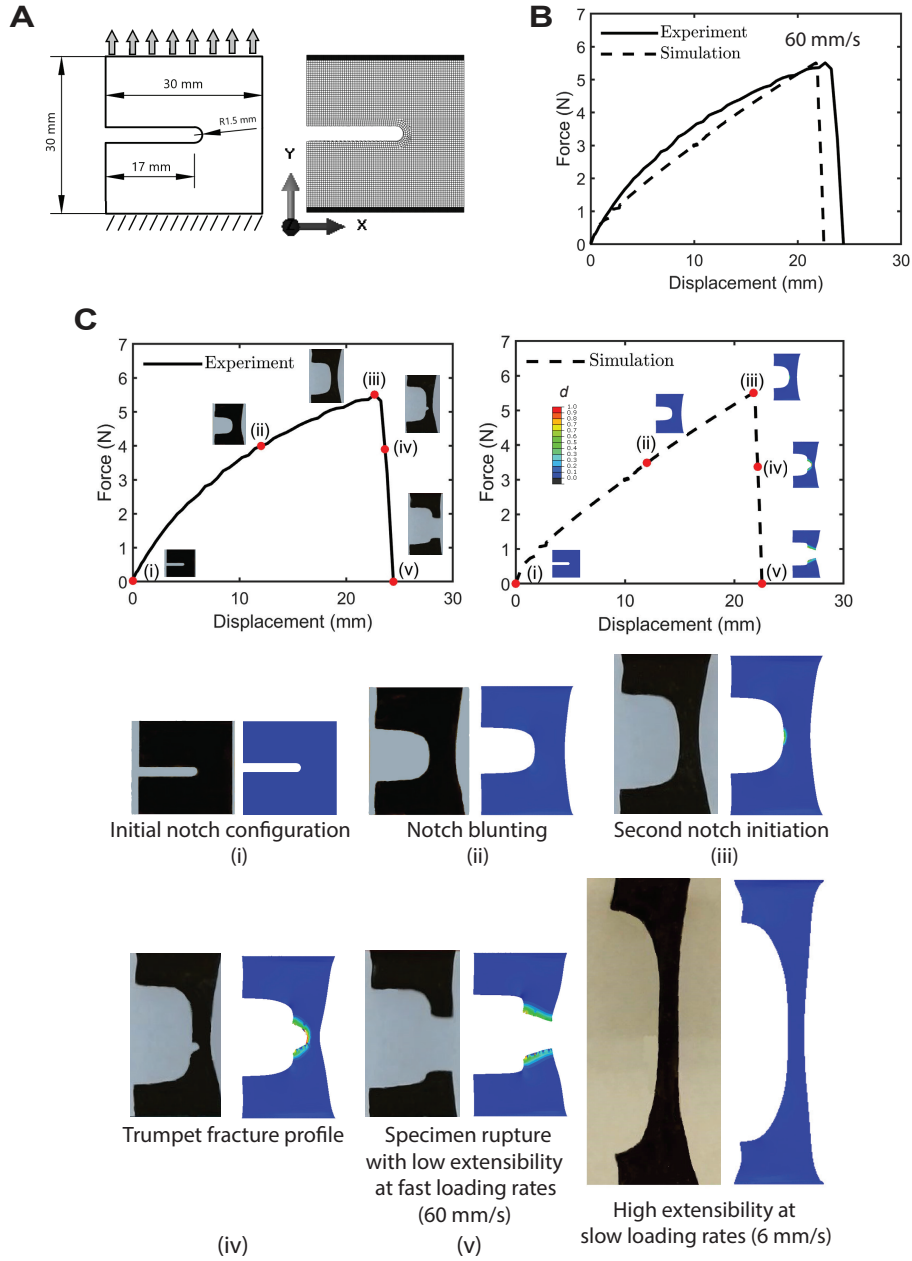

Figure 6: **Predictive ability of the fracture model for PBS (forces and rate-dependent physical response).** (A) Edge notch PBS stretch experiment schematic. Finite element mesh used for simulation. (B) Good agreement between the numerically predicted force-displacement curve and the experimental result for 60 mm/s loading speed. (C) Specimen shapes at different levels of stretch from experiment (left) and simulation (right) show good agreement for the 60 mm/s stretching speed. The model predicts the experimentally observed trumpet fracture profile. Also, the model predicts the transition from rupture with low extensibility at a fast loading rate (60 mm/s) to high extensibility at a slow loading rate (6 mm/s). Elements with  $d > 0.95$  are hidden, and the experimental specimen was colored for visualization.

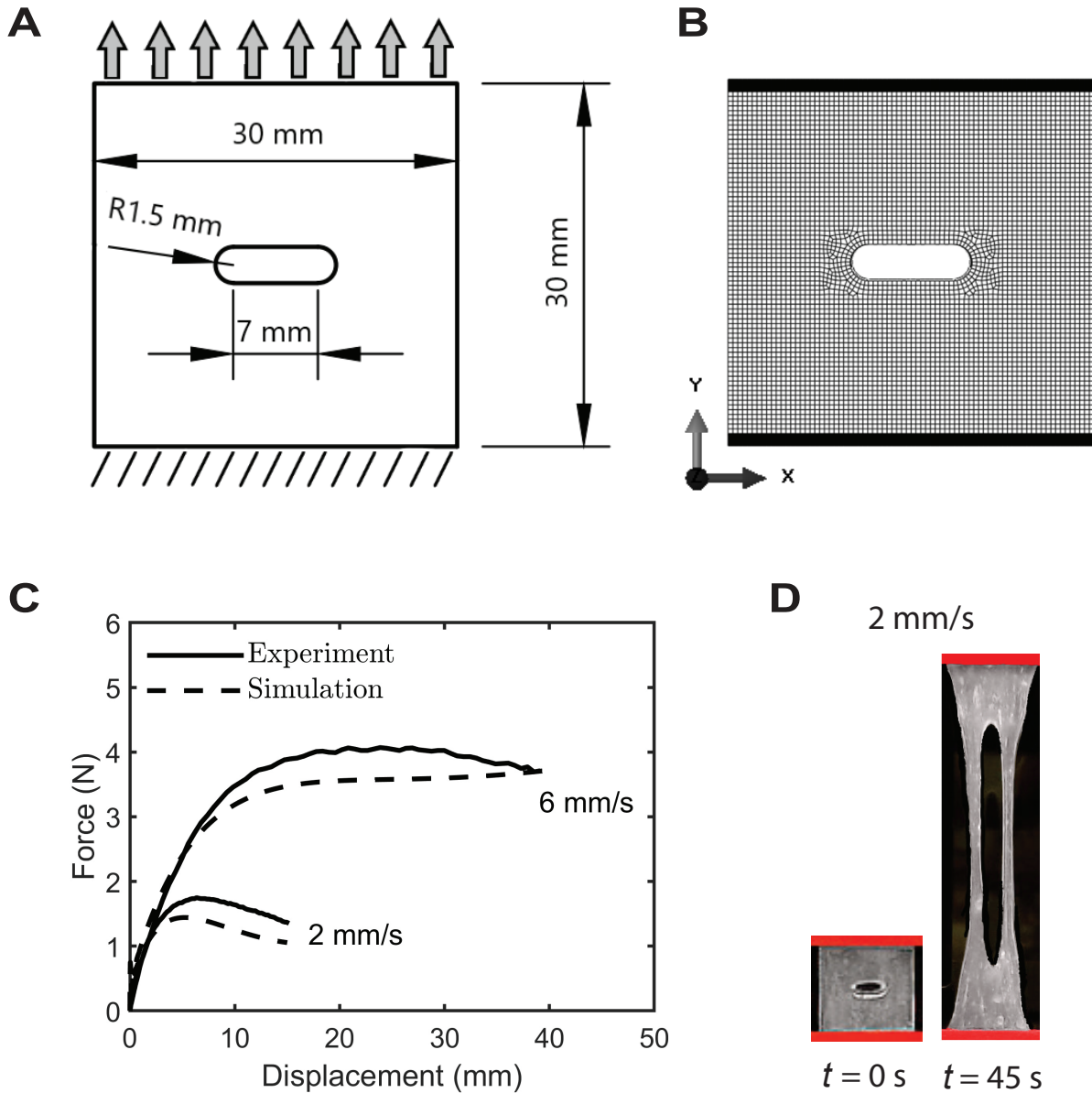

Figure 7: **Model predictions for center notch PBS specimen.** (A) Center notch PBS stretch experiment schematic. (B) Finite element mesh for the simulations. Quarter symmetry with appropriate symmetry boundary conditions was used in the simulations, but for clarity, complete geometry with mesh is shown. (C) Good agreement between the model predictions and the experimental results can be seen for the two loading speeds of 2 mm/s and 6 mm/s. Necking instability seen in the experimental results is predicted by the model and fracture doesn't occur at these slower speeds. (D) High extensibility is shown through the comparison of specimen shapes at  $t = 0$  s and  $t = 45$  s for a 2 mm/s loading speed.

experiments. Model prediction for the extension force agrees well with the experimental result, as shown in Figure 8C.

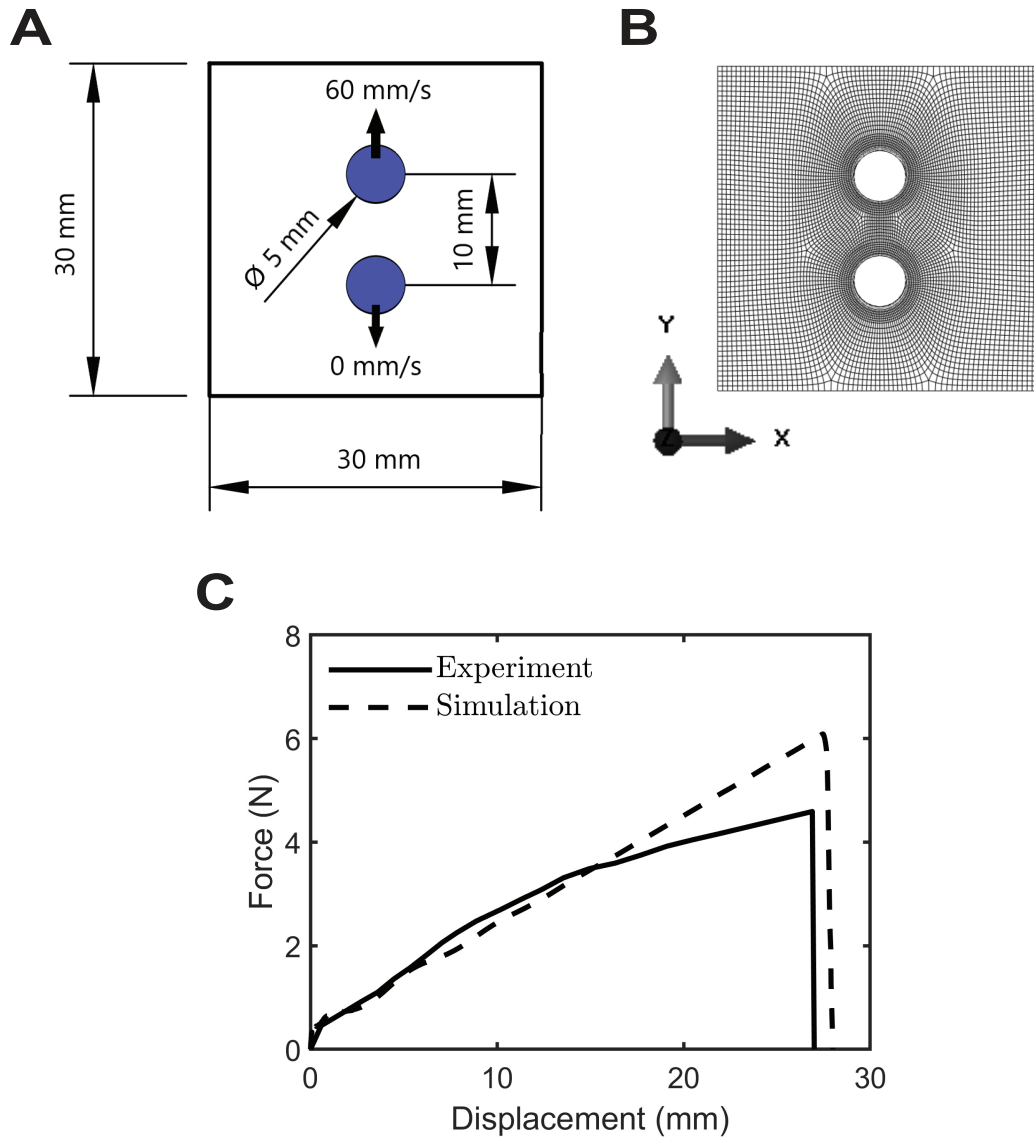

Figure 8: **Model prediction for stretching through internal holes in PBS specimen.** (A) PBS specimen geometry and experiment schematic. The blue regions denote the inserts. The specimen has a thickness of 3.2 mm, and the top insert was displaced at a speed of 60 mm/s. (B) The finite element mesh used for the simulation. A quarter of the block is considered due to the symmetries of the problem with appropriate boundary conditions. For clarity, complete geometry with mesh is shown. (C) The model prediction for the extension force agrees well with the experimental result.

### 8.5. Fracture response considering viscous effects

We performed simulations where the viscous effects in the input material were removed (by suitably prescribing the material parameter values) to study the role of viscosity in the physical fracture phenomenon. These enabled qualitative model predictions for fracture

profiles as the material varies from a viscous soft polymer to an elastomer. The geometry, loading schematic, and finite element mesh for the notched tension test in Figure 4B were considered with a stretching speed of 60 mm/s.  $\zeta$ , which determines the timescale for damage growth, was set equal to 3 kPa.s. All other material parameters for PBS are left unchanged except  $G$ ,  $k_{ns}$  and  $k_s$ . We removed viscous effects by setting  $G = 0$  (removing the elastic-viscoplastic A micro-mechanism) and  $k_{ns} = k_s = 0$  (this provides a model representing permanently crosslinked material) to simulate a hyperelastic material. The computationally obtained fracture profiles in Figure 9 transition correctly from the experimentally observed trumpet profile in viscous soft polymers (de Gennes, 1996, Hui et al., 2022, Shen et al., 2021a) to single parabola-like profile in elastomers (Qi et al., 2019, Shrivastava et al., 2023). The model can predict the significantly varying important physical phenomena observed during the fracture of soft polymers.

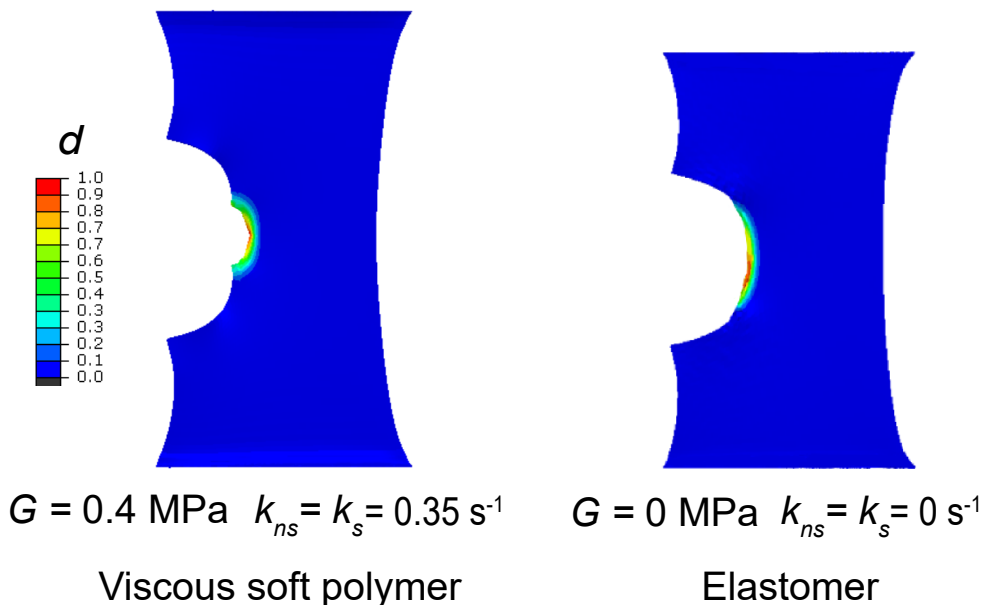

Figure 9: **Comparison of viscous soft polymer and elastomer fracture.** Notch profiles for single notch specimen stretching simulations showing experimentally observed trumpet profile for a viscous soft polymer (PBS) and a single parabola-like profile when viscous effects were removed in the model to simulate elastomeric material response. The profiles are shown just before complete failure. Elements with  $d > 0.95$  are hidden for visualization.

### 8.6. EPDM elastomer with V notch

Benvidi and co-workers (Benvidi et al., 2019) performed tension tests on V-notched EPDM rubber to demonstrate the efficacy of the average strain energy density criterion for fracture analysis of hyperelastic materials. We test our fracture model’s ability to capture the experimental data reported in (Benvidi et al., 2019). The two notch configurations

from (Benvidi et al., 2019) shown in Figure 10A were applied in finite element simulations for our model’s verification. A total of 20,265 and 20,019 C3D8R elements were used in the finite element meshes for notch diameter  $a=2$  mm, notch depth  $d=5$  mm and  $a=2$  mm,  $d=10$  mm cases, respectively, as shown in Figure 10A. Due to the assumed hyperelastic nature of EPDM in (Benvidi et al., 2019),  $W_{cr} = \psi_{cr}^+ = \psi_{cr}^{(B)}$ . The Ogden free energy density function was used in (Benvidi et al., 2019) to model the large deformation response of the EPDM elastomer. Instead of the eight-chain free energy density function with the dynamic crosslink formulation for Mechanism  $B$ , the Ogden function is used with the same dynamic crosslink formulation for our fracture modeling framework. We set  $G=0$  MPa,  $k_{ns} = k_s=0$  s<sup>-1</sup> in our model and used the deformation-related material parameters from (Benvidi et al., 2019). As the force-displacement curves for the V notched tests are not presented in (Benvidi et al., 2019), it was assumed that rupture occurs instantly when  $\psi_o^+ = \psi_o^{(B)} = \psi_{cr}^+$  at the notch center. Independent prediction for the displacement at which rupture occurs for the  $a=2$  mm and  $d=10$  mm notch geometry agrees well with the experimental result as shown in Figure 10B.

### 8.7. EPS25 vitrimer: Notched pure shear

To test the model predictions for a different dynamically crosslinked soft polymer and a loading mode other than tension, we utilize the data reported by Shen and co-workers (Shen et al., 2021a) for the fracture of EPS25 vitrimer. Pure shear tests over a range of loading speeds were performed on EPS25 vitrimer specimens with sharp single edge notches in (Shen et al., 2021a). The specimen geometry is shown in Figure 11A. The finite element mesh used for the simulations is shown in Figure 11B. Crack extension vs stretch ratio ( $\lambda$ ) experimental data for the two loading speeds reported in (Shen et al., 2021a) is shown in 11C. The authors observed a transition from high extensibility, i.e., no crack propagation (0.0225 mm/s) to fracture (0.09 mm/s) with increasing loading rates as shown in Figure 11C. The transient network theory with the neo-Hookean free energy density function is used by the authors to model the large deformation response of EPS25 vitrimer. We used the neo-Hookean function for mechanism  $B$  with our same dynamic crosslink formulation.  $G$  is set equal to 0 MPa in our model, and the deformation-associated material parameters from (Shen et al., 2021a) are used. The authors created a sharp notch in the specimens using a blade. As the exact radius of the notch is not specified in (Shen et al., 2021a), we assumed a very sharp notch radius of 100  $\mu$ m. With the aim of modeling the initiation of crack propagation, only a VUMAT was used. A total of 28,716 C3D8 (three-dimensional, full integration) stress elements were used in the finite element mesh for the problem, as shown in 11B.  $\psi_{cr}^+ = \psi_{cr}^{(B)}$ ,  $W_{cr}$  were evaluated as the values of  $\psi_o^+ = \psi_o^{(B)}$ ,  $W$  at the notch center at the time instant corresponding to the

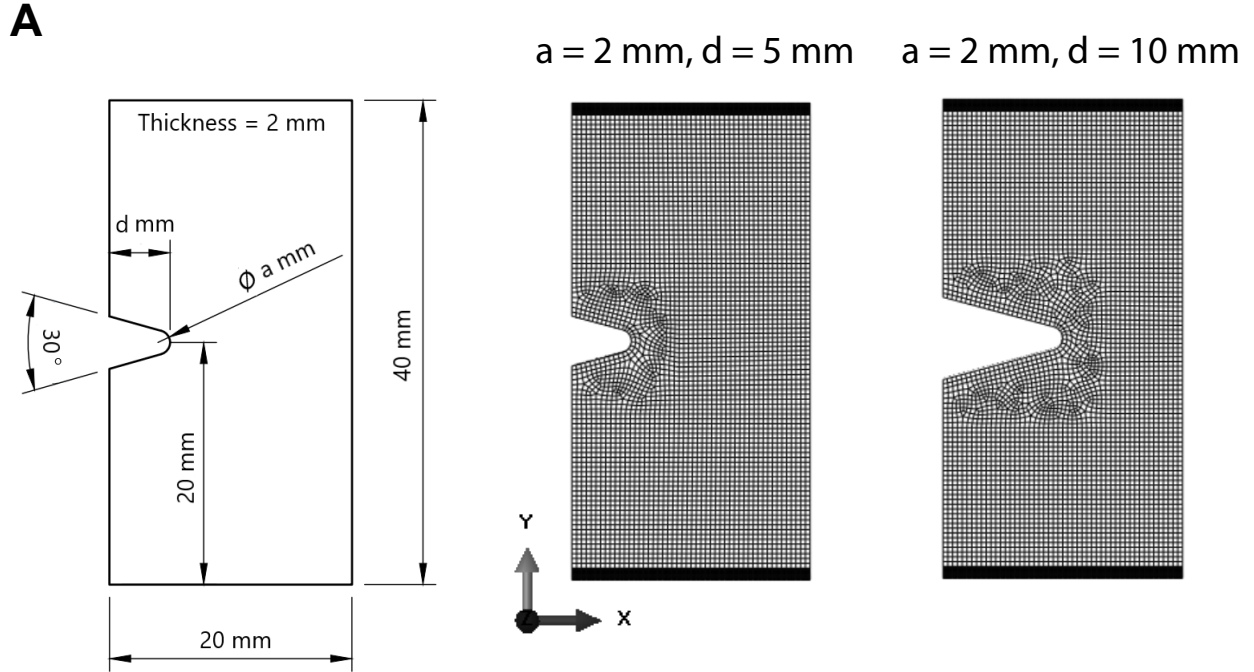

**B**

Notch depth d (mm)	Experimental rupture displacement (mm) data from Benvidi et al. (2019)	Model prediction (mm)
5	28.26	Used for $\psi_{cr}^+$ calibration
10	<b>23.07</b>	<b>22.55</b> (independent prediction)

Figure 10: **Model prediction for fracture of EPDM elastomer.** (A) V-notched specimen geometry for EPDM rubber used in (Benvidi et al., 2019). Finite element meshes used for simulations. (B) Experimental data for a=2 mm, d=5 mm from (Benvidi et al., 2019) was used for  $\psi_{cr}^+ = \psi_{cr}^{(B)} = W_{cr}$  calibration. Independent model prediction for the rupture displacement for a=2 mm, d=10 mm notch geometry shows good agreement with the experimental result in (Benvidi et al., 2019).

initiation of crack propagation for the 0.09 mm/s loading speed. Model predictions for  $\psi_o^+$  at the notch center vs.  $\lambda$  curves for the two loading speeds are shown in 11D. The model predicts no crack propagation for the relatively slow 0.0225 mm/s loading speed due to  $\psi_o^+$  at the notch center not being able to exceed  $\psi_{cr}^+$  as seen in Figure 11D. This agrees with the experimental observation from (Shen et al., 2021a) in Figure 11C.

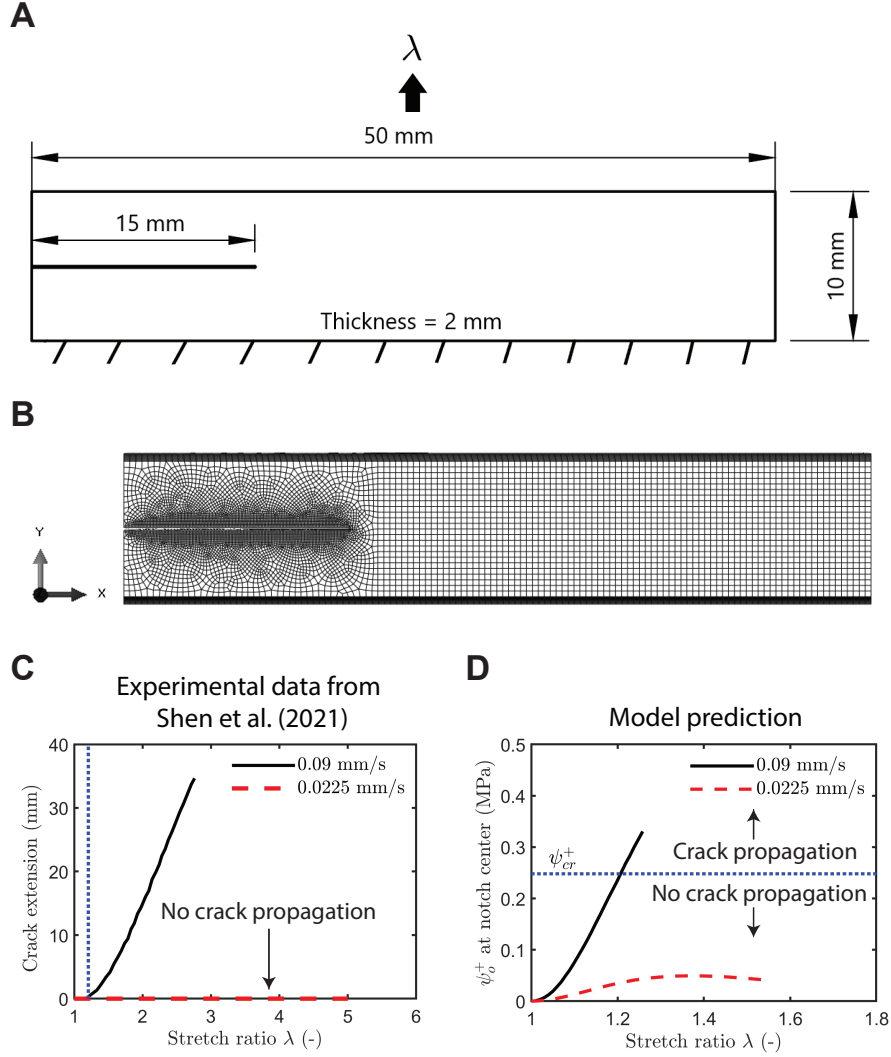

Figure 11: **Model prediction for fracture of EPS25 viscous soft polymer.** (A) Specimen geometry for EPS25 vitrimer pure shear tests with sharp single edge notches from (Shen et al., 2021a). (B) Finite element mesh for simulations. (C) Crack extension vs. stretch ratio ( $\lambda$ ) experimental data from (Shen et al., 2021a) for the loading speeds of 0.09 mm/s and 0.0225 mm/s. There is no crack propagation for 0.0225 mm/s loading speed.  $\psi_{cr}^+ = \psi_{cr}^{(B)}$  and  $W_{cr}$  were calibrated using the  $\lambda$  at initiation of crack propagation for 0.09 mm/s speed. (D) Model predictions for  $\psi_0^+$  at the notch center vs  $\lambda$  curves for the two loading speeds. The model predicts no crack propagation for 0.0225 mm/s speed due to  $\psi_0^+$  at the notch center not being able to exceed  $\psi_{cr}^+$ . This agrees with the experimental observation in (Shen et al., 2021a).

### 8.8. SBR: Failure surface prediction

Variational phase field models have been shown to be unable to capture the experimentally observed failure surfaces of various materials in (Lopez-Pamies et al., 2025). We compare failure surface prediction from our model, which is based on the method of virtual



power with the experimental measurements for SBR<sup>7</sup> from (Hamdi et al., 2006). Specifically, our loading mode insensitive damage initiation criterion in the form of a unique critical free energy density  $\psi_{cr}$  is used and validated. Due to the fast damage evolution of soft polymers, the failure occurs when  $\psi = \psi_{cr}$ . The deformation response of SBR was modeled using the incompressible Ogden (N=2) hyperelastic function fit to the experimental data from (Hamdi et al., 2006). A single  $\psi_{cr}$  was chosen based on the experimental failure data for SBR. Model prediction for the failure surface using the proposed damage initiation criterion shows good agreement with the experimental surface<sup>8</sup> as shown in Figure 12.

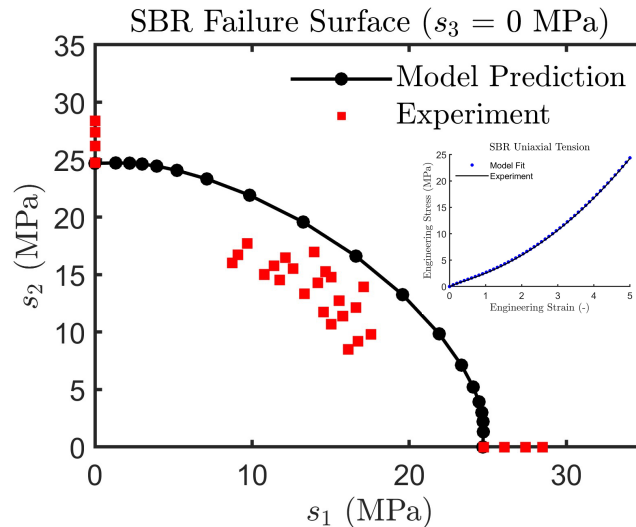

Figure 12: **Failure surface model prediction for SBR.** The model predicts the failure surface for SBR ( $s_3 = 0$  MPa) reasonably well when its predictions are compared with the experimental surface from (Hamdi et al., 2006).  $s_i$  are the nominal principal stresses. Inset (deformation response): Incompressible Ogden (N=2) hyperelastic model fit to the experimental uniaxial stress-strain curve from (Hamdi et al., 2006). A single value of  $\psi_{cr}$  was chosen as model parameter for SBR.

## 9. Conclusions

Soft polymers are found in nature and as engineering materials, including elastomers, viscoelastic polymers, polymer gels, and biological tissues. Their properties vary from rate-independent to rate-dependent. Current fracture toughness measures are non-unique for

<sup>7</sup>A variational phase field model was shown in (Lopez-Pamies et al., 2025) to not be able to correctly predict the experimental data and showed unphysical predictions where it predicted the biaxial failure stress magnitudes to be larger than the uniaxial failure stress.

<sup>8</sup>It is prudent to note that the experimental fracture measurements in elastomers typically have a large variability and uncertainty but the measures are useful to evaluate trends and obtain failure stress approximations within an order of magnitude.



rate-dependent soft polymers for varying loading profiles and specimen geometries. We propose and show that a critical value of stress work  $W_{cr}$  that can be obtained from simple homogeneous deformation experiments without constitutive models can quantify the fracture resistance of different soft polymers.  $W_{cr}$  can be interpreted as the total energy per unit referential volume associated with the complete failure of a material point under a loading mode subjected to sufficiently fast loading rates for damage initiation. We have developed a multi-mechanism, gradient damage framework based model to predict damage initiation, growth, and complete failure in soft polymers. The method of virtual power is used to formulate the gradient damage framework. The energetic contribution to the critical stress work,  $\psi_{cr}^+$  is proposed as a damage initiation criterion which accounts for material strength. The proposed damage model shows successful predictions of Polyborosiloxane’s fracture in several independent experiments involving different specimen geometries and loading conditions. It is also able to predict the fracture of two elastomers EPDM, SBR and another viscous soft polymer, EPS25. A transition in fracture profile from trumpet to single parabola-like was observed in the model predictions as the polymer viscous effects were removed. This is consistent with experimental observations, demonstrating the model’s ability to predict the significantly varying physical phenomena observed during the fracture of soft polymers. The continuum scale model is developed based on microscopic physical insights. We show that macroscopic model parameters can be used to obtain relevant physical quantities at the microstructural process scales. From the macroscopic parameter  $\psi_{cr}^+$ , we estimated the value of subchain dissociation energy, which was verified by a set of independent experiments. In the future, more experiments with complex specimen geometries, loading rates, and loading modes can be performed to further study the approximate independence of  $W_{cr}$  from these variables. The application, adaptation or development of damage models for soft biological tissues would be of value.

## Author Contributions

**Aditya Konale:** Investigation, Methodology, Formal analysis, Data curation, Software, Visualization, Writing – original draft preparation, review & editing. **Vikas Srivastava:** Conceptualization, Investigation, Methodology, Supervision, Funding acquisition, Writing – original draft preparation, review & editing.

## Acknowledgments

The authors would like to acknowledge the support from the Office of Naval Research (ONR), USA to V. Srivastava under grant numbers N00014-21-1-2815 and N00014-21-1-

2670. The authors thank Dr. James LeBlanc from the Naval Underwater Warfare Center for supporting the research.

### Declaration of Interest

The authors declare no competing interests.

### References

- D. Ahmad, S. K. Sahu, and K. Patra. Fracture toughness, hysteresis and stretchability of dielectric elastomers under equibiaxial and biaxial loading. *Polymer Testing*, 79:106038, 2019. ISSN 0142-9418.
- K. Alkhoury, C. Zhang, G. Liu, K. McEnnis, L. Brassart, S. P. Nadimpalli, and S. A. Chester. Investigating the influence of stress on uv-induced degradation in cellulose acetate: A comprehensive experimental characterization. *International Journal of Solids and Structures*, 305:113086, 2024. ISSN 0020-7683.
- N. M. Ames, V. Srivastava, S. A. Chester, and L. Anand. A thermo-mechanically coupled theory for large deformations of amorphous polymers. part ii: Applications. *International Journal of Plasticity*, 25(8):1495–1539, 2009. ISSN 0749-6419. doi: <https://doi.org/10.1016/j.ijplas.2008.11.005>.
- M. Amjadi, Y. J. Yoon, and I. Park. Ultra-stretchable and skin-mountable strain sensors using carbon nanotubes–ecoflex nanocomposites. *Nanotechnology*, 26(37):375501, aug 2015. doi: [10.1088/0957-4484/26/37/375501](https://doi.org/10.1088/0957-4484/26/37/375501).
- H. Amor, J.-J. Marigo, and C. Maurini. Regularized formulation of the variational brittle fracture with unilateral contact: Numerical experiments. *Journal of the Mechanics and Physics of Solids*, 57(8):1209–1229, 2009. ISSN 0022-5096. doi: <https://doi.org/10.1016/j.jmps.2009.04.011>.
- L. Anand, N. M. Ames, V. Srivastava, and S. A. Chester. A thermo-mechanically coupled theory for large deformations of amorphous polymers. part i: Formulation. *International Journal of Plasticity*, 25(8):1474–1494, 2009. ISSN 0749-6419. doi: <https://doi.org/10.1016/j.ijplas.2008.11.004>.
- L. Anand, Y. Mao, and B. Talamini. On modeling fracture of ferritic steels due to hydrogen embrittlement. *Journal of the Mechanics and Physics of Solids*, 122:280–314, 2019. ISSN 0022-5096. doi: <https://doi.org/10.1016/j.jmps.2018.09.012>.

- E. M. Arruda and M. C. Boyce. A three-dimensional constitutive model for the large stretch behavior of rubber elastic materials. *Journal of the Mechanics and Physics of Solids*, 41(2):389–412, 1993. ISSN 0022-5096.
- R. Bai, J. Yang, X. P. Morelle, C. Yang, and Z. Suo. Fatigue fracture of self-recovery hydrogels. *ACS Macro Letters*, 7(3):312–317, 2018. doi: 10.1021/acsmacrolett.8b00045. PMID: 35632906.
- Y. Bai, N. J. Kaiser, K. L. Coulombe, and V. Srivastava. A continuum model and simulations for large deformation of anisotropic fiber–matrix composites for cardiac tissue engineering. *Journal of the Mechanical Behavior of Biomedical Materials*, 121:104627, 9 2021. ISSN 17516161.
- C. W. Barney, M. E. Helgeson, and M. T. Valentine. Network structure influences bulk modulus of nearly incompressible filled silicone elastomers. *Extreme Mechanics Letters*, 52:101616, 2022. ISSN 2352-4316. doi: <https://doi.org/10.1016/j.eml.2022.101616>.
- S. K. Behera, D. Kumar, and S. Sarangi. Constitutive modeling of damage-induced stress softening in electro-magneto-viscoelastic materials. *Mechanics of Materials*, 171:104348, 2022. ISSN 0167-6636. doi: <https://doi.org/10.1016/j.mechmat.2022.104348>.
- A. H. Benvidi, M. R. Ayatollahi, and M. Heydari-Meybodi. Fracture analysis of rounded-tip v-notched components made of rubber-like materials using averaged strain energy density criterion. *Procedia Structural Integrity*, 21:12–20, 2019. ISSN 2452-3216. 1st International Workshop on Plasticity, Damage and Fracture of Engineering Materials, IWPDF 2019, 22-23 August 2019, Ankara, Turkey.
- J. Bergström and M. Boyce. Constitutive modeling of the large strain time-dependent behavior of elastomers. *Journal of the Mechanics and Physics of Solids*, 46(5):931–954, 1998. ISSN 0022-5096. doi: [https://doi.org/10.1016/S0022-5096\(97\)00075-6](https://doi.org/10.1016/S0022-5096(97)00075-6).
- N. Bouklas, C. M. Landis, and R. Huang. Effect of Solvent Diffusion on Crack-Tip Fields and Driving Force for Fracture of Hydrogels. *Journal of Applied Mechanics*, 82(8):081007, 08 2015. ISSN 0021-8936. doi: 10.1115/1.4030587.
- B. Bourdin, G. Francfort, and J.-J. Marigo. Numerical experiments in revisited brittle fracture. *Journal of the Mechanics and Physics of Solids*, 48(4):797–826, 2000. ISSN 0022-5096. doi: [https://doi.org/10.1016/S0022-5096\(99\)00028-9](https://doi.org/10.1016/S0022-5096(99)00028-9).
- B. Bourdin, G. A. Francfort, and J.-J. Marigo. The variational approach to fracture. *Journal of Elasticity*, 91(1):5–148, Apr 2008. ISSN 1573-2681. doi: 10.1007/s10659-007-9107-3.

- M. Boyce, G. Weber, and D. Parks. On the kinematics of finite strain plasticity. *Journal of the Mechanics and Physics of Solids*, 37(5):647–665, 1989. ISSN 0022-5096. doi: [https://doi.org/10.1016/0022-5096\(89\)90033-1](https://doi.org/10.1016/0022-5096(89)90033-1).
- M. C. Boyce, D. M. Parks, and A. S. Argon. Large inelastic deformation of glassy polymers. part i: rate dependent constitutive model. *Mechanics of Materials*, 7(1):15–33, 1988. ISSN 0167-6636. doi: [https://doi.org/10.1016/0167-6636\(88\)90003-8](https://doi.org/10.1016/0167-6636(88)90003-8).
- R. Brighenti, Y. Li, and F. J. Vernerey. Smart polymers for advanced applications: A mechanical perspective review. *Frontiers in Materials*, 7, 2020. ISSN 2296-8016. doi: [10.3389/fmats.2020.00196](https://doi.org/10.3389/fmats.2020.00196).
- W. Brostow, H. E. Hagg Lobland, and S. Khoja. Brittleness and toughness of polymers and other materials. *Materials Letters*, 159:478–480, 2015. ISSN 0167-577X.
- E. N. Brown, N. R. Sottos, and S. R. White. Fracture testing of a self-healing polymer composite. *Experimental Mechanics*, 42(4):372–379, 2002. doi: [10.1007/BF02412141](https://doi.org/10.1007/BF02412141).
- K. Buaksuntear, P. Limarun, S. Suethao, and W. Smitthipong. Non-covalent interaction on the self-healing of mechanical properties in supramolecular polymers. *International Journal of Molecular Sciences*, 23(13), 2022. ISSN 1422-0067. doi: [10.3390/ijms23136902](https://doi.org/10.3390/ijms23136902).
- B. Budiansky and J. R. Rice. Conservation Laws and Energy-Release Rates. *Journal of Applied Mechanics*, 40(1):201–203, 03 1973. ISSN 0021-8936. doi: [10.1115/1.3422926](https://doi.org/10.1115/1.3422926).
- F. Burla, S. Dussi, C. Martinez-Torres, J. Tauber, J. van der Gucht, and G. H. Koenderink. Connectivity and plasticity determine collagen network fracture. *Proceedings of the National Academy of Sciences*, 117(15):8326–8334, 2020. doi: <https://doi.org/10.1073/pnas.1920062117>.
- S. Burley and G. Petsko. Weakly polar interactions in proteins. *Advances in Protein Chemistry*, 39:125–189, 1988. ISSN 0065-3233. doi: [https://doi.org/10.1016/S0065-3233\(08\)60376-9](https://doi.org/10.1016/S0065-3233(08)60376-9).
- P. Cao, B. Chen, Y. Cao, and H. Gao. Micropores can enhance intrinsic fracture energy of hydrogels, 2024.
- C. Chen, Z. Wang, and Z. Suo. Flaw sensitivity of highly stretchable materials. *Extreme Mechanics Letters*, 10:50–57, 2017. ISSN 2352-4316. doi: <https://doi.org/10.1016/j.eml.2016.10.002>. Filling Gaps in Material Property Space: IUTAM Symposium.

- S. Chen and K. Ravi-Chandar. Rate-dependent fracture behavior of gelatin-based hydrogels. *International Journal of Fracture*, 243(2):185–202, Oct 2023.
- M. Ciavarella. A generalized rivlin–thomas theory for nucleation of cracks in viscoelastic materials. *Theoretical and Applied Fracture Mechanics*, 133:104564, 2024. ISSN 0167-8442.
- B. N. Cox, H. Gao, D. Gross, and D. Rittel. Modern topics and challenges in dynamic fracture. *Journal of the Mechanics and Physics of Solids*, 53(3):565–596, 2005. ISSN 0022-5096. doi: <https://doi.org/10.1016/j.jmps.2004.09.002>.
- C. Creton. 50th anniversary perspective: Networks and gels: Soft but dynamic and tough. *Macromolecules*, 50(21):8297–8316, 2017. doi: [10.1021/acs.macromol.7b01698](https://doi.org/10.1021/acs.macromol.7b01698).
- P. G. de Gennes. Soft adhesives. *Langmuir*, 12(19):4497–4500, 1996.
- R. de Rooij and E. Kuhl. Constitutive modeling of brain tissue: Current perspectives. *Applied Mechanics Reviews*, 68:010801, 2016.
- A. Drozdov and J. deC. Christiansen. Tension–compression asymmetry in the mechanical response of hydrogels. *Journal of the Mechanical Behavior of Biomedical Materials*, 110:103851, 2020. ISSN 1751-6161.
- C. Du, H. Cui, H. Zhang, Z. Cai, and W. Zhai. Phase field modeling of thermal fatigue crack growth in elastoplastic solids and experimental verification. *Mechanics of Materials*, 188:104839, 2024. ISSN 0167-6636. doi: <https://doi.org/10.1016/j.mechmat.2023.104839>.
- T. T. Duncan, J. M. Sarapas, A. P. Defante, K. L. Beers, and E. P. Chan. Cutting to measure the elasticity and fracture of soft gels. *Soft Matter*, 16:8826–8831, 2020.
- S. Fakhouri, S. B. Hutchens, and A. J. Crosby. Puncture mechanics of soft solids. *Soft Matter*, 11:4723–4730, 2015. doi: [10.1039/C5SM00230C](https://doi.org/10.1039/C5SM00230C).
- H. Gao, Y. Huang, W. Nix, and J. Hutchinson. Mechanism-based strain gradient plasticity—i. theory. *Journal of the Mechanics and Physics of Solids*, 47(6):1239–1263, 1999. ISSN 0022-5096. doi: [https://doi.org/10.1016/S0022-5096\(98\)00103-3](https://doi.org/10.1016/S0022-5096(98)00103-3).
- P. Germain. The method of virtual power in continuum mechanics. part 2: Microstructure. *SIAM Journal on Applied Mathematics*, 25(3):556–575, 1973.

- J. Guo, M. Liu, A. T. Zehnder, J. Zhao, T. Narita, C. Creton, and C.-Y. Hui. Fracture mechanics of a self-healing hydrogel with covalent and physical crosslinks: A numerical study. *Journal of the Mechanics and Physics of Solids*, 120:79–95, 2018. ISSN 0022-5096. doi: <https://doi.org/10.1016/j.jmps.2018.03.009>. Special issue in honor of Ares J. Rosakis on the occasion of his 60th birthday.
- J. Guo, C.-Y. Hui, M. Liu, and A. T. Zehnder. The stress field near the tip of a plane stress crack in a gel consisting of chemical and physical cross-links. *Proceedings of the Royal Society A: Mathematical, Physical and Engineering Sciences*, 475(2227):20180863, 2019. doi: 10.1098/rspa.2018.0863.
- M. E. Gurtin. Generalized ginzburg-landau and cahn-hilliard equations based on a microforce balance. *Physica D: Nonlinear Phenomena*, 92(3):178–192, 1996. ISSN 0167-2789.
- M. E. Gurtin. A gradient theory of single-crystal viscoplasticity that accounts for geometrically necessary dislocations. *Journal of the Mechanics and Physics of Solids*, 50(1):5–32, 2002. ISSN 0022-5096. doi: [https://doi.org/10.1016/S0022-5096\(01\)00104-1](https://doi.org/10.1016/S0022-5096(01)00104-1).
- M. E. Gurtin, E. Fried, and L. Anand. *The mechanics and thermodynamics of continua*. Cambridge university press, 2010.
- M. R. Gurvich and T. S. Fleischman. A simple approach to characterize finite compressibility of elastomers. *Rubber Chemistry and Technology*, 76(4):912–922, 09 2003. ISSN 0035-9475. doi: 10.5254/1.3547781.
- J. Guzek, H. Azimi, and S. Suresh. Fatigue crack propagation along polymer-metal interfaces in microelectronic packages. *IEEE Transactions on Components, Packaging, and Manufacturing Technology: Part A*, 20(4):496–504, 1997. doi: 10.1109/95.650940.
- O. Gültekin, H. Dal, and G. A. Holzapfel. A phase-field approach to model fracture of arterial walls: Theory and finite element analysis. *Computer Methods in Applied Mechanics and Engineering*, 312:542–566, 2016. ISSN 0045-7825. doi: <https://doi.org/10.1016/j.cma.2016.04.007>. Phase Field Approaches to Fracture.
- L. Hai, P. Wriggers, Y. jie Huang, H. Zhang, and S. lang Xu. Dynamic fracture investigation of concrete by a rate-dependent explicit phase field model integrating viscoelasticity and micro-viscosity. *Computer Methods in Applied Mechanics and Engineering*, 418:116540, 2024. ISSN 0045-7825. doi: <https://doi.org/10.1016/j.cma.2023.116540>.

- A. Hamdi, M. Naït Abdelaziz, N. Aït Hocine, P. Heuillet, and N. Benseddiq. A fracture criterion of rubber-like materials under plane stress conditions. *Polymer Testing*, 25(8): 994–1005, 2006. ISSN 0142-9418. doi: <https://doi.org/10.1016/j.polymertesting.2006.06.005>.
- P. Hesammokri, H. Yu, and P. Isaksson. An extended hydrostatic–deviatoric strain energy density decomposition for phase-field fracture theories. *International Journal of Solids and Structures*, 262-263:112080, 2023. ISSN 0020-7683.
- T. Hu, J. Guilleminot, and J. E. Dolbow. A phase-field model of fracture with frictionless contact and random fracture properties: Application to thin-film fracture and soil desiccation. *Computer Methods in Applied Mechanics and Engineering*, 368:113106, 2020. ISSN 0045-7825. doi: <https://doi.org/10.1016/j.cma.2020.113106>.
- X. Hu, J. Zhou, W. F. M. Daniel, M. Vatankhah-Varnoosfaderani, A. V. Dobrynin, and S. S. Sheiko. Dynamics of dual networks: Strain rate and temperature effects in hydrogels with reversible h-bonds. *Macromolecules*, 50(2):652–659, 2017. doi: [10.1021/acs.macromol.6b02422](https://doi.org/10.1021/acs.macromol.6b02422).
- X. Huang, B. Li, W. Hong, Y.-P. Cao, and X.-Q. Feng. Effects of tension–compression asymmetry on the surface wrinkling of film–substrate systems. *Journal of the Mechanics and Physics of Solids*, 94:88–104, 2016. ISSN 0022-5096. doi: <https://doi.org/10.1016/j.jmps.2016.04.014>.
- N. Huebsch, C. J. Kearney, X. Zhao, J. Kim, C. A. Cezar, Z. Suo, and D. J. Mooney. Ultrasound-triggered disruption and self-healing of reversibly cross-linked hydrogels for drug delivery and enhanced chemotherapy. *Proceedings of the National Academy of Sciences*, 111(27):9762–9767, 2014. doi: <https://doi.org/10.1073/pnas.1405469111>.
- C. Y. Hui, J. Guo, M. Liu, and A. Zehnder. Finite strain theory of a mode iii crack in a rate dependent gel consisting of chemical and physical cross-links. *International Journal of Fracture*, 215(1):77–89, Jan 2019. ISSN 1573-2673. doi: [10.1007/s10704-018-00335-9](https://doi.org/10.1007/s10704-018-00335-9).
- C.-Y. Hui, B. Zhu, and R. Long. Steady state crack growth in viscoelastic solids: A comparative study. *Journal of the Mechanics and Physics of Solids*, 159:104748, 2022. ISSN 0022-5096. doi: <https://doi.org/10.1016/j.jmps.2021.104748>.
- Y. Hwang, M. K. Kim, Z. Zhao, B. Kim, T. Chang, T. F. Fan, M. S. Ibrahim, S. Suresh, C. H. Lee, and N.-J. Cho. Plant-based substrate materials for flexible green electronics. *Advanced Materials Technologies*, 7(12):2200446, 2022.

- C. Imaoka, T. Nakajima, T. Indei, M. Iwata, W. Hong, A. Marcellan, and J. P. Gong. Inverse mechanical-swelling coupling of a highly deformed double-network gel. *Science Advances*, 9(19):eabp8351, 2023.
- A. International. *ASTM D638-14, Standard Test Method for Tensile Properties of Plastics*. ASTM International, 2015.
- M. Jiang, Z. T. Lawson, V. Erel, S. Pervere, T. Nan, A. B. Robbins, A. D. Feed, and M. R. Moreno. Clamping soft biologic tissues for uniaxial tensile testing: A brief survey of current methods and development of a novel clamping mechanism. *J Mech Behav Biomed Mater*, 103:103503, Nov. 2019.
- Y. M. Jihai Yuan and C. Chen. Multiple-phase-field modeling for fracture of composite materials. *Mechanics of Advanced Materials and Structures*, 29(28):7476–7490, 2022. doi: 10.1080/15376494.2021.2000081.
- C. Kadapa and M. Hossain. A unified numerical approach for soft to hard magneto-viscoelastically coupled polymers. *Mechanics of Materials*, 166:104207, 2022. ISSN 0167-6636. doi: <https://doi.org/10.1016/j.mechmat.2021.104207>.
- Y.-L. Kang, Z.-F. Zhang, H.-W. Wang, and Q.-H. Qin. Experimental investigations of the effect of thickness on fracture toughness of metallic foils. *Materials Science and Engineering: A*, 394(1):312–319, 2005. ISSN 0921-5093.
- J. Kim, G. Zhang, M. Shi, and Z. Suo. Fracture, fatigue, and friction of polymers in which entanglements greatly outnumber cross-links. *Science*, 374(6564):212–216, 2021. doi: 10.1126/science.abg6320.
- J. Kim, Y. Kim, H. Shin, and W.-R. Yu. Mechanical modeling of strain rate-dependent behavior of shear-stiffening gel. *International Journal of Mechanics and Materials in Design*, Oct 2022. doi: <https://doi.org/10.1007/s10999-022-09618-5>.
- D. R. King. Macroscale double networks: highly dissipative soft composites. *Polymer Journal*, 54(8):943–955, Aug 2022. ISSN 1349-0540. doi: 10.1038/s41428-022-00646-8.
- A. Konale, Z. Ahmed, P. Wanchoo, and V. Srivastava. A large deformation model for quasi-static to high strain rate response of a rate-stiffening soft polymer. *International Journal of Plasticity*, 168:103701, 2023. ISSN 0749-6419.



- S. Konica and T. Sain. A reaction-driven evolving network theory coupled with phase-field fracture to model polymer oxidative aging. *Journal of the Mechanics and Physics of Solids*, 150:104347, 2021. ISSN 0022-5096.
- S. Konica, B. W. Sheldon, and V. Srivastava. Role of coupled electrochemistry and stress on the li-anode instability: A continuum approach, 2024.
- M. Kothari, S. Niu, and V. Srivastava. A thermo-mechanically coupled finite strain model for phase-transitioning austenitic steels in ambient to cryogenic temperature range. *Journal of the Mechanics and Physics of Solids*, 133:103729, 2019. ISSN 0022-5096.
- E. Kröner. Allgemeine kontinuumstheorie der versetzungen und eigenspannungen. *Archive for Rational Mechanics and Analysis*, 4(1):273–334, Jan 1959. ISSN 1432-0673. doi: <https://doi.org/10.1007/BF00281393>.
- E. Kuhl, E. Ramm, and R. de Borst. An anisotropic gradient damage model for quasi-brittle materials. *Computer Methods in Applied Mechanics and Engineering*, 183(1):87–103, 2000. ISSN 0045-7825. doi: [https://doi.org/10.1016/S0045-7825\(99\)00213-3](https://doi.org/10.1016/S0045-7825(99)00213-3).
- A. Kumar and O. Lopez-Pamies. The phase-field approach to self-healable fracture of elastomers: A model accounting for fracture nucleation at large, with application to a class of conspicuous experiments. *Theoretical and Applied Fracture Mechanics*, 107:102550, 2020. ISSN 0167-8442. doi: <https://doi.org/10.1016/j.tafmec.2020.102550>.
- A. Kumar, B. Bourdin, G. A. Francfort, and O. Lopez-Pamies. Revisiting nucleation in the phase-field approach to brittle fracture. *Journal of the Mechanics and Physics of Solids*, 142:104027, 2020. ISSN 0022-5096. doi: <https://doi.org/10.1016/j.jmps.2020.104027>.
- A. Kurkin, V. Lipik, K. B. L. Tan, G. L. Seah, X. Zhang, and A. I. Y. Tok. Correlations between precursor molecular weight and dynamic mechanical properties of polyborosiloxane (pbs). *Macromolecular Materials and Engineering*, 306(11):2100360, 2021. doi: <https://doi.org/10.1002/mame.202100360>.
- J.-C. Lai, X.-Y. Jia, D.-P. Wang, Y.-B. Deng, P. Zheng, C.-H. Li, J.-L. Zuo, and Z. Bao. Thermodynamically stable whilst kinetically labile coordination bonds lead to strong and tough self-healing polymers. *Nature Communications*, 10(1):1164, Mar 2019. ISSN 2041-1723. doi: [10.1038/s41467-019-09130-z](https://doi.org/10.1038/s41467-019-09130-z).
- G. J. Lake. Fatigue and Fracture of Elastomers. *Rubber Chemistry and Technology*, 68(3): 435–460, 07 1995. ISSN 0035-9475. doi: [10.5254/1.3538750](https://doi.org/10.5254/1.3538750).

- G. J. Lake, A. G. Thomas, and D. Tabor. The strength of highly elastic materials. *Proceedings of the Royal Society of London. Series A. Mathematical and Physical Sciences*, 300(1460): 108–119, 1967a. doi: 10.1098/rspa.1967.0160.
- G. J. Lake, A. G. Thomas, and D. Tabor. The strength of highly elastic materials. *Proceedings of the Royal Society of London. Series A. Mathematical and Physical Sciences*, 300(1460): 108–119, 1967b.
- J. LeBlanc, A. Shukla, and Y. D. S. Rajapakse. Dynamic failure of composite materials. *Journal of Dynamic Behavior of Materials*, 4(3):257–257, 2018. doi: 10.1007/s40870-018-0171-5.
- J. LeBlanc, P. Cavallaro, J. Torres, D. Ponte, E. Warner, R. Saenger, I. N. Mforsoh, and A. Shukla. Low temperature effects on the mechanical, fracture, and dynamic behavior of carbon and e-glass epoxy laminates. *International Journal of Lightweight Materials and Manufacture*, 3(4):344–356, 2020. ISSN 2588-8404.
- E. H. Lee. Elastic-Plastic Deformation at Finite Strains. *Journal of Applied Mechanics*, 36(1):1–6, 03 1969. ISSN 0021-8936. doi: <https://doi.org/10.1115/1.3564580>.
- J. Lee, J. Lee, S. Yun, S. Kim, H. Lee, S. A. Chester, and H. Cho. Size-dependent fracture in elastomers: experiments and continuum modeling. *arXiv*, 2024.
- S. P. Lele and L. Anand. A large-deformation strain-gradient theory for isotropic viscoplastic materials. *International Journal of Plasticity*, 25(3):420–453, 2009. ISSN 0749-6419.
- B. Li and N. Bouklas. A variational phase-field model for brittle fracture in polydisperse elastomer networks. *International Journal of Solids and Structures*, 182-183:193–204, 2020. ISSN 0020-7683. doi: <https://doi.org/10.1016/j.ijsolstr.2019.08.012>.
- F. Li, C. Shih, and A. Needleman. A comparison of methods for calculating energy release rates. *Engineering Fracture Mechanics*, 21(2):405–421, 1985. ISSN 0013-7944.
- W. Li, H. Nguyen, and Y. Bazilevs. Isogeometric multilayer thin-shell analysis of failure in composite structures with hygrothermal effects. *International Journal of Fracture*, 2024.
- X. Li, D. Zhang, K. Xiang, and G. Huang. Synthesis of polyborosiloxane and its reversible physical crosslinks. *RSC Adv.*, 4:32894–32901, 2014a. doi: <http://dx.doi.org/10.1039/C4RA01877J>.

- Y. Li, M. Kröger, and W. K. Liu. Endocytosis of pegylated nanoparticles accompanied by structural and free energy changes of the grafted polyethylene glycol. *Biomaterials*, 35(30): 8467–8478, 2014b. ISSN 0142-9612. doi: <https://doi.org/10.1016/j.biomaterials.2014.06.032>.
- B. Liu, C. Du, and Y. Fu. Factors influencing the rheological properties of mrsp based on the orthogonal experimental design and the impact energy test. *Advances in Materials Science and Engineering*, 2019:2545203, Sep 2019a. ISSN 1687-8434. doi: <https://doi.org/10.1155/2019/2545203>.
- B. Liu, T. Yin, J. Zhu, D. Zhao, H. Yu, and S. Qu. Tough and fatigue-resistant polymer networks by crack tip softening. *Proceedings of the National Academy of Sciences*, 120(6): e2217781120, 2023. doi: <https://doi.org/10.1073/pnas.2217781120>.
- C. Liu, H. Yokoyama, K. Mayumi, and K. Ito. Crack velocity dependent toughness of polyrotaxane networks: The sliding dynamics of rings on polymer under stretching. *Mechanics of Materials*, 156:103784, 2021. ISSN 0167-6636. doi: <https://doi.org/10.1016/j.mechmat.2021.103784>.
- M. Liu, J. Guo, C.-Y. Hui, and A. Zehnder. Crack tip stress based kinetic fracture model of a pva dual-crosslink hydrogel. *Extreme Mechanics Letters*, 29:100457, 2019b. ISSN 2352-4316.
- R. Long and C.-Y. Hui. Fracture toughness of hydrogels: measurement and interpretation. *Soft Matter*, 12:8069–8086, 2016.
- R. Long, C.-Y. Hui, J. P. Gong, and E. Bouchbinder. The fracture of highly deformable soft materials: A tale of two length scales. *Annual Review of Condensed Matter Physics*, 12(1):71–94, 2021.
- O. Lopez-Pamies, J. E. Dolbow, G. A. Francfort, and C. J. Larsen. Classical variational phase-field models cannot predict fracture nucleation. *Computer Methods in Applied Mechanics and Engineering*, 433:117520, 2025. ISSN 0045-7825. doi: <https://doi.org/10.1016/j.cma.2024.117520>.
- F. Luo, T. L. Sun, T. Nakajima, T. Kurokawa, Y. Zhao, A. B. Ihsan, H. L. Guo, X. F. Li, and J. P. Gong. Crack blunting and advancing behaviors of tough and self-healing polyampholyte hydrogel. *Macromolecules*, 47(17):6037–6046, 2014. doi: [10.1021/ma5009447](https://doi.org/10.1021/ma5009447).
- K. A. Mac Donald and G. Ravichandran. Crack propagation and renucleation in soft brittle hydrogels. *International Journal of Fracture*, 222(1):37–52, 2020.

- Y.-W. Mai and P. Powell. Essential work of fracture and j-integral measurements for ductile polymers. *Journal of Polymer Science Part B: Polymer Physics*, 29(7):785–793, 1991. doi: <https://doi.org/10.1002/polb.1991.090290702>.
- P. Malhotra, T. Jiao, D. L. Henann, R. J. Clifton, and P. R. Guduru. Dynamic shearing resistance of hydroxyl-terminated polybutadiene (htpb). *Journal of Applied Physics*, 129(24):245901, 2021.
- L. G. Malito, J. V. Sov, B. Gludovatz, R. O. Ritchie, and L. A. Pruitt. Fracture toughness of ultra-high molecular weight polyethylene: A basis for defining the crack-initiation toughness in polymers. *Journal of the Mechanics and Physics of Solids*, 122:435–449, 2019. ISSN 0022-5096.
- Y. Mao and L. Anand. Fracture of elastomeric materials by crosslink failure. *Journal of Applied Mechanics*, 85(8), 06 2018a. ISSN 0021-8936. 081008.
- Y. Mao and L. Anand. A theory for fracture of polymeric gels. *Journal of the Mechanics and Physics of Solids*, 115:30–53, 2018b. ISSN 0022-5096. doi: <https://doi.org/10.1016/j.jmps.2018.02.008>.
- Y. Mao, B. Talamini, and L. Anand. Rupture of polymers by chain scission. *Extreme Mechanics Letters*, 13:17–24, 2017. ISSN 2352-4316.
- T. Matsuda, R. Kawakami, T. Nakajima, and J. P. Gong. Crack tip field of a double-network gel: Visualization of covalent bond scission through mechanoradical polymerization. *Macromolecules*, 53(20):8787–8795, 2020. doi: 10.1021/acs.macromol.0c01485.
- K. Mayumi, J. Guo, T. Narita, C. Y. Hui, and C. Creton. Fracture of dual crosslink gels with permanent and transient crosslinks. *Extreme Mechanics Letters*, 6:52–59, 2016. ISSN 2352-4316.
- C. Miehe and L.-M. Schänzel. Phase field modeling of fracture in rubbery polymers. part i: Finite elasticity coupled with brittle failure. *Journal of the Mechanics and Physics of Solids*, 65:93–113, 2014. ISSN 0022-5096.
- C. Miehe, M. Hofacker, and F. Welschinger. A phase field model for rate-independent crack propagation: Robust algorithmic implementation based on operator splits. *Computer Methods in Applied Mechanics and Engineering*, 199(45):2765–2778, 2010a. ISSN 0045-7825. doi: <https://doi.org/10.1016/j.cma.2010.04.011>.

- C. Miehe, F. Welschinger, and M. Hofacker. Thermodynamically consistent phase-field models of fracture: Variational principles and multi-field fe implementations. *International Journal for Numerical Methods in Engineering*, 83(10):1273–1311, 2010b.
- I. Miranda, A. Souza, P. Sousa, J. Ribeiro, E. M. S. Castanheira, R. Lima, and G. Minas. Properties and applications of pdms for biomedical engineering: A review. *Journal of Functional Biomaterials*, 13(1), 2022. ISSN 2079-4983. doi: 10.3390/jfb13010002.
- M. Montanari, R. Brighenti, M. Terzano, and A. Spagnoli. Puncturing of soft tissues: experimental and fracture mechanics-based study. *Soft Matter*, 19:3629–3639, 2023. doi: 10.1039/D3SM00011G.
- S. M. Mousavi, I. Ang, J. Mulderrig, and N. Bouklas. Evaluating Fracture Energy Predictions Using Phase-Field and Gradient-Enhanced Damage Models for Elastomers. *Journal of Applied Mechanics*, 91(12):121009, 10 2024. ISSN 0021-8936. doi: 10.1115/1.4066385.
- K. Myronidis, M. Thielke, M. Kopeć, M. Meo, and F. Pinto. Polyborosiloxane-based, dynamic shear stiffening multilayer coating for the protection of composite laminates under low velocity impact. *Composites Science and Technology*, 222:109395, 2022. ISSN 0266-3538. doi: <https://doi.org/10.1016/j.compscitech.2022.109395>.
- S. Narayan and L. Anand. A gradient-damage theory for fracture of quasi-brittle materials. *Journal of the Mechanics and Physics of Solids*, 129:119–146, 2019. ISSN 0022-5096.
- S. Narayan and L. Anand. Fracture of amorphous polymers: A gradient-damage theory. *Journal of the Mechanics and Physics of Solids*, 146:104164, 2021. ISSN 0022-5096.
- K. Narumi, F. Qin, S. Liu, H.-Y. Cheng, J. Gu, Y. Kawahara, M. Islam, and L. Yao. Self-healing ui: Mechanically and electrically self-healing materials for sensing and actuation interfaces. In *Proceedings of the 32nd Annual ACM Symposium on User Interface Software and Technology*, UIST '19, page 293–306, New York, NY, USA, 2019. Association for Computing Machinery. ISBN 9781450368162.
- S. Niu and V. Srivastava. Simulation trained CNN for accurate embedded crack length, location, and orientation prediction from ultrasound measurements. *International Journal of Solids and Structures*, 242:111521, 2022a.
- S. Niu and V. Srivastava. Ultrasound classification of interacting flaws using finite element simulations and convolutional neural network. *Engineering with Computers*, 38(5):4653–4662, Oct 2022b. ISSN 1435-5663.

- S. Niu, E. Zhang, Y. Bazilevs, and V. Srivastava. Modeling finite-strain plasticity using physics-informed neural network and assessment of the network performance. *Journal of the Mechanics and Physics of Solids*, 172:105177, 2023. ISSN 0022-5096.
- L. Nunes. Mechanical characterization of hyperelastic polydimethylsiloxane by simple shear test. *Materials Science and Engineering: A*, 528(3):1799–1804, 2011. ISSN 0921-5093. doi: <https://doi.org/10.1016/j.msea.2010.11.025>.
- Y. Qi, Z. Zou, J. Xiao, and R. Long. Mapping the nonlinear crack tip deformation field in soft elastomer with a particle tracking method. *Journal of the Mechanics and Physics of Solids*, 125:326–346, 2019. ISSN 0022-5096. doi: <https://doi.org/10.1016/j.jmps.2018.12.018>.
- Y. Qi, X. Li, S. P. Venkata, X. Yang, T. L. Sun, C.-Y. Hui, J. P. Gong, and R. Long. Mapping deformation and dissipation during fracture of soft viscoelastic solid. *Journal of the Mechanics and Physics of Solids*, 186:105595, 2024. ISSN 0022-5096.
- A. Raina and C. Miehe. A phase-field model for fracture in biological tissues. *Biomechanics and Modeling in Mechanobiology*, 15(3):479–496, Jun 2016. ISSN 1617-7940. doi: 10.1007/s10237-015-0702-0.
- B. D. Reddy. The role of dissipation and defect energy in variational formulations of problems in strain-gradient plasticity. part 1: polycrystalline plasticity. *Continuum Mechanics and Thermodynamics*, 23(6):527–549, Nov 2011. ISSN 1432-0959. doi: 10.1007/s00161-011-0194-9.
- A. J. Rosakis and G. Ravichandran. Dynamic failure mechanics. *International Journal of Solids and Structures*, 37(1):331–348, 2000. ISSN 0020-7683. doi: [https://doi.org/10.1016/S0020-7683\(99\)00097-9](https://doi.org/10.1016/S0020-7683(99)00097-9).
- D. Roylance. Stress-strain curves. *Massachusetts Institute of Technology study, Cambridge*, 2001.
- T. Shen and F. J. Vernerey. Rate-dependent fracture of transient networks. *Journal of the Mechanics and Physics of Solids*, 143:104028, 2020. ISSN 0022-5096. doi: <https://doi.org/10.1016/j.jmps.2020.104028>.
- T. Shen, Z. Song, S. Cai, and F. J. Vernerey. Nonsteady fracture of transient networks: The case of vitrimer. *Proceedings of the National Academy of Sciences*, 118(29):e2105974118, 2021a.

- Z. Shen, H. Ye, Q. Wang, M. Kröger, and Y. Li. Sticky rouse time features the self-adhesion of supramolecular polymer networks. *Macromolecules*, 54(11):5053–5064, 2021b. doi: 10.1021/acs.macromol.1c00335.
- A. Shrivastava and N. Gundiah. Methylglyoxal crosslinking increases the fracture toughness of gelatin hydrogels. *Mechanics of Materials*, 176:104524, 2023. ISSN 0167-6636.
- A. Shrivastava, S. M., and N. Gundiah. Crack propagation and arrests in gelatin hydrogels are linked to tip curvatures. *Soft Matter*, 19:6911–6919, 2023. doi: 10.1039/D3SM00637A.
- A. Shukla, G. Ravichandran, and Y. Rajapakse. *Dynamic failure of materials and structures*, volume 1. Springer, 2010.
- S. Shukla, J. Favata, V. Srivastava, S. Shahbazmohamadi, A. Tripathi, and A. Shukla. Effect of polymer and ion concentration on mechanical and drug release behavior of gellan hydrogels using factorial design. *Journal of Polymer Science*, 58(10):1365–1379, 2020.
- J. Sloopman, C. J. Yeh, P. Millereau, J. Comtet, and C. Creton. A molecular interpretation of the toughness of multiple network elastomers at high temperature. *Proceedings of the National Academy of Sciences*, 119(13):e2116127119, 2022. doi: 10.1073/pnas.2116127119.
- H. Somarathna, S. Raman, D. Mohotti, A. Mutalib, and K. Badri. Rate dependent tensile behavior of polyurethane under varying strain rates. *Construction and Building Materials*, 254:119203, 2020. ISSN 0950-0618.
- Z. Song, T. Shen, F. J. Vernerey, and S. Cai. Force-dependent bond dissociation explains the rate-dependent fracture of vitrimers. *Soft Matter*, 17:6669–6674, 2021.
- V. Srivastava, A. Shukla, and V. Parameswaran. Experimental evaluation of the dynamic shear strength of adhesive-bonded lap joints. *Journal of Testing and Evaluation - J TEST EVAL*, 28, 11 2000.
- V. Srivastava, V. Parameswaran, A. Shukla, and D. Morgan. *Effect of Loading Rate and Geometry Variation on the Dynamic Shear Strength of Adhesive Lap Joints*, pages 769–780. Springer Netherlands, Dordrecht, 2002. ISBN 978-0-306-48410-0. doi: [https://doi.org/10.1007/0-306-48410-2\\\_71](https://doi.org/10.1007/0-306-48410-2\_71).
- V. Srivastava, S. A. Chester, N. M. Ames, and L. Anand. A thermo-mechanically-coupled large-deformation theory for amorphous polymers in a temperature range which spans their glass transition. *International Journal of Plasticity*, 26(8):1138–1182, 2010a. ISSN 0749-6419. Special Issue In Honor of Lallit Anand.

- V. Srivastava, S. A. Chester, and L. Anand. Thermally actuated shape-memory polymers: Experiments, theory, and numerical simulations. *Journal of the Mechanics and Physics of Solids*, 58(8):1100–1124, 2010b. ISSN 0022-5096.
- V. Srivastava, J. Buitrago, and S. T. Slocum. Stress analysis of a cryogenic corrugated pipe. In *Proceedings of the ASME 2011 30th International Conference on Ocean, Offshore and Arctic Engineering: Volume 3*, pages 411–422. American Society of Mechanical Engineers, 2011.
- D. Steck, J. Qu, S. B. Kordmahale, D. Tscharnuter, A. Muliana, and J. Kameoka. Mechanical responses of ecoflex silicone rubber: Compressible and incompressible behaviors. *Journal of Applied Polymer Science*, 136(5):47025, 2019.
- G. Subhash and Q. Liu. Quasistatic and dynamic crushability of polymeric foams in rigid confinement. *International Journal of Impact Engineering*, 36(10):1303–1311, 2009. ISSN 0734-743X. doi: <https://doi.org/10.1016/j.ijimpeng.2009.03.010>.
- G. Subhash, Q. Liu, and X.-L. Gao. Quasistatic and high strain rate uniaxial compressive response of polymeric structural foams. *International Journal of Impact Engineering*, 32(7):1113–1126, 2006. ISSN 0734-743X. doi: <https://doi.org/10.1016/j.ijimpeng.2004.11.006>.
- B. Talamini, Y. Mao, and L. Anand. Progressive damage and rupture in polymers. *Journal of the Mechanics and Physics of Solids*, 111:434–457, 2018. ISSN 0022-5096. doi: <https://doi.org/10.1016/j.jmps.2017.11.013>.
- F. Tang, C. Dong, Z. Yang, Y. Kang, X. Huang, M. Li, Y. Chen, W. Cao, C. Huang, Y. Guo, and Y. Wei. Protective performance and dynamic behavior of composite body armor with shear stiffening gel as buffer material under ballistic impact. *Composites Science and Technology*, 218:109190, 2022. ISSN 0266-3538.
- J. Tang, J. Li, J. J. Vlassak, and Z. Suo. Fatigue fracture of hydrogels. *Extreme Mechanics Letters*, 10:24–31, 2017. ISSN 2352-4316. doi: <https://doi.org/10.1016/j.eml.2016.09.010>. Filling Gaps in Material Property Space: IUTAM Symposium.
- M. Tang, W. Wang, D. Xu, and Z. Wang. Synthesis of structure-controlled polyborosiloxanes and investigation on their viscoelastic response to molecular mass of polydimethylsiloxane triggered by both chemical and physical interactions. *Industrial & Engineering Chemistry Research*, 55(49):12582–12589, 2016. doi: <https://doi.org/10.1021/acs.iecr.6b03823>.



- H. Tu, P. Xu, Z. Yang, F. Tang, C. Dong, Y. Chen, W. Cao, C. Huang, Y. Guo, and Y. Wei. Effect of shear thickening gel on microstructure and impact resistance of ethylene–vinyl acetate foam. *Composite Structures*, 311:116811, 2023. ISSN 0263-8223.
- K. Upadhyay, D. Spearot, and G. Subhash. Validated tensile characterization of the strain rate dependence in soft materials. *International Journal of Impact Engineering*, 156:103949, 2021. ISSN 0734-743X. doi: <https://doi.org/10.1016/j.ijimpeng.2021.103949>.
- K. Vaishakh, N. Parambil, and V. Srivastava. Hygroscopic damage of fiber–matrix interface in unidirectional composites: A computational approach. *International Journal of Mechanical Sciences*, 279:109460, 2024. ISSN 0020-7403.
- S. P. Venkata, K. Cui, J. Guo, A. T. Zehnder, J. P. Gong, and C.-Y. Hui. Constitutive modeling of bond breaking and healing kinetics of physical polyampholyte (pa) gel. *Extreme Mechanics Letters*, 43:101184, 2021. ISSN 2352-4316.
- F. Vogel, S. Göktepe, P. Steinmann, and E. Kuhl. Modeling and simulation of viscous electroactive polymers. *European Journal of Mechanics / A Solids*, 48(Complete):112–128, 2014. ISSN 09977538. doi: [10.1016/j.euromechsol.2014.02.001](https://doi.org/10.1016/j.euromechsol.2014.02.001).
- T. Wang, X. Ye, Z. Liu, X. Liu, D. Chu, and Z. Zhuang. A phase-field model of thermoelastic coupled brittle fracture with explicit time integration. *Computational Mechanics*, 65(5):1305–1321, May 2020. ISSN 1432-0924.
- W. Wang, Y. Zhang, and W. Liu. Bioinspired fabrication of high strength hydrogels from non-covalent interactions. *Progress in Polymer Science*, 71:1–25, 2017. ISSN 0079-6700. Topical Volume on Polymeric Biomaterials.
- Y. Wang, L. Ding, C. Zhao, S. Wang, S. Xuan, H. Jiang, and X. Gong. A novel magnetorheological shear-stiffening elastomer with self-healing ability. *Composites Science and Technology*, 168:303–311, 2018. ISSN 0266-3538. doi: <https://doi.org/10.1016/j.compscitech.2018.10.019>.
- J. Wu, C. McAuliffe, H. Waisman, and G. Deodatis. Stochastic analysis of polymer composites rupture at large deformations modeled by a phase field method. *Computer Methods in Applied Mechanics and Engineering*, 312:596–634, 2016. ISSN 0045-7825. doi: <https://doi.org/10.1016/j.cma.2016.06.010>. Phase Field Approaches to Fracture.
- M. Xu and L. Wang. A new method for studying the dynamic response and damage evolution of polymers at high strain rates. *Mechanics of Materials*, 38(1):68–75, 2006. ISSN 0167-

6636. doi: <https://doi.org/10.1016/j.mechmat.2005.05.010>. Macro-, Meso-, Micro- and Nano-Mechanics of Materials.
- H. Yang, T. Henzel, E. M. Stewart, and M. Guo. An interpenetrating-network theory of the cytoskeletal networks in living cells. *Journal of the Mechanics and Physics of Solids*, 189: 105688, 2024. ISSN 0022-5096. doi: <https://doi.org/10.1016/j.jmps.2024.105688>.
- T. Yin, T. Wu, J. Liu, S. Qu, and W. Yang. Essential work of fracture of soft elastomers. *Journal of the Mechanics and Physics of Solids*, 156:104616, 2021. ISSN 0022-5096.
- Y. Yu, N. Bouklas, C. M. Landis, and R. Huang. Poroelastic Effects on the Time- and Rate-Dependent Fracture of Polymer Gels. *Journal of Applied Mechanics*, 87(3):031005, 11 2019. ISSN 0021-8936. doi: 10.1115/1.4045004.
- S. Yuan, T. Tong, Z. Liu, and P. Yang. Explicit double-phase-field formulation and implementation for bending behavior of uhpc-nc composite beams. *Journal of Building Engineering*, 57:104802, 2022. ISSN 2352-7102.
- H. Yuk, T. Zhang, S. Lin, G. A. Parada, and X. Zhao. Tough bonding of hydrogels to diverse non-porous surfaces. *Nature Materials*, 15(2):190–196, Feb 2016. ISSN 1476-4660. doi: <https://doi.org/10.1038/nmat4463>.
- H. Yuk, S. Lin, C. Ma, M. Takaffoli, N. X. Fang, and X. Zhao. Hydraulic hydrogel actuators and robots optically and sonically camouflaged in water. *Nature Communications*, 8(1): 14230, Feb 2017. ISSN 2041-1723.
- H. Yuk, C. E. Varela, C. S. Nabzdyk, X. Mao, R. F. Padera, E. T. Roche, and X. Zhao. Dry double-sided tape for adhesion of wet tissues and devices. *Nature*, 575(7781):169–174, Nov 2019. ISSN 1476-4687.
- P. Zhang, S. Tan, X. Hu, W. Yao, and X. Zhuang. A double-phase field model for multiple failures in composites. *Composite Structures*, 293:115730, 2022. ISSN 0263-8223. doi: <https://doi.org/10.1016/j.compstruct.2022.115730>.
- C. Zhao, X. Gong, S. Wang, W. Jiang, and S. Xuan. Shear stiffening gels for intelligent anti-impact applications. *Cell Reports Physical Science*, 1(12):100266, 2020a. ISSN 2666-3864.
- C. Zhao, Y. Wang, M. Ni, X. He, S. Xuan, and X. Gong. Dynamic behavior of impact hardening elastomer: A flexible projectile material with unique rate-dependent performance. *Composites Part A: Applied Science and Manufacturing*, 143:106285, 2021. ISSN 1359-835X. doi: <https://doi.org/10.1016/j.compositesa.2021.106285>.

- J. Zhao, L. Debertrand, T. Narita, and C. Creton. Fracture of dual crosslink gels with permanent and transient crosslinks: Effect of the relaxation time of the transient crosslinks. *Journal of Rheology*, 66(6):1255–1266, 11 2022. ISSN 0148-6055. doi: 10.1122/8.0000460.
- P.-C. Zhao, W. Li, W. Huang, and C.-H. Li. A self-healing polymer with fast elastic recovery upon stretching. *Molecules*, 25(3), 2020b. ISSN 1420-3049.
- D. Zheng, S. Lin, J. Ni, and X. Zhao. Fracture and fatigue of entangled and unentangled polymer networks. *Extreme Mechanics Letters*, 51:101608, 2022. ISSN 2352-4316. doi: <https://doi.org/10.1016/j.eml.2022.101608>.
- J. Zhong and V. Srivastava. A higher-order morphoelastic beam model for tubes and filaments subjected to biological growth. *International Journal of Solids and Structures*, 233:111235, 12 2021. ISSN 00207683.
- X.-K. Zhu and J. A. Joyce. Review of fracture toughness (g, k, j, ctod, ctoa) testing and standardization. *Engineering Fracture Mechanics*, 85:1–46, 2012. ISSN 0013-7944. doi: <https://doi.org/10.1016/j.engfracmech.2012.02.001>.
- H. Zong, Z. Liu, R. Wei, B. Dong, X. Yang, and W. Zhai. Shear thickening and impact resistance properties of stg in flexible protection application. *Journal of Physics: Conference Series*, 1855(1):012022, mar 2021. doi: <https://dx.doi.org/10.1088/1742-6596/1855/1/012022>.