

HPVM-HDC: A Heterogeneous Programming System for Accelerating Hyperdimensional Computing

Russel Arbore*
rarbore2@illinois.edu
University of Illinois
Urbana-Champaign
USA

Xavier Routh*
xrouth2@illinois.edu
University of Illinois
Urbana-Champaign
USA

Abdul Rafae Noor
arnoor2@illinois.edu
University of Illinois
Urbana-Champaign
USA

Akash Kothari
akashk4@illinois.edu
University of Illinois
Urbana-Champaign
USA

Haichao Yang
hcyang@ucsd.edu
University of California San Diego
USA

Weihong Xu
wexu@ucsd.edu
University of California San Diego
USA

Sumukh Pinge
spinge@ucsd.edu
University of California San Diego
USA

Vikram Adve
vadve@illinois.edu
University of Illinois
Urbana-Champaign
USA

Tajana Rosing
tajana@ucsd.edu
University of California San Diego
USA

Minxuan Zhou
mzhou26@iit.edu
Illinois Institute of Technology
USA

Abstract

Hyperdimensional Computing (HDC), a technique inspired by cognitive models of computation, has been proposed as an efficient and robust alternative basis for machine learning. HDC programs are often manually written in low-level and target specific languages targeting CPUs, GPUs, and FPGAs—these codes cannot be easily retargeted onto HDC-specific accelerators. No previous programming system enables productive development of HDC programs and generates efficient code for several hardware targets.

We propose a heterogeneous programming system for HDC: a novel programming language, HDC++, for writing applications using a unified programming model, including HDC-specific primitives to improve programmability, and a heterogeneous compiler, HPVM-HDC, that provides an intermediate representation for compiling HDC programs to many hardware targets. We implement two tuning optimizations, automatic binarization and reduction perforation, that exploit the error resilient nature of HDC. Our evaluation shows that HPVM-HDC generates performance-competitive code for CPUs and GPUs, achieving a geomean speed-up of 1.17x over optimized baseline CUDA implementations with a geomean reduction in total lines of code of 1.6x across CPUs and GPUs. Additionally, HPVM-HDC targets an HDC Digital ASIC and an HDC ReRAM accelerator simulator, enabling the first execution of HDC applications on these devices.

1 Introduction

As machine learning models are hitting the memory and compute limits of modern hardware, they are suffering from low performance and high energy consumption on edge devices. In order to meet the performance, energy, and accuracy demands of modern workloads, a brain-inspired computing paradigm, *Hyperdimensional Computing (HDC)* [28], is gaining traction. It represents data using *hypervectors*, which are high dimensional vectors with thousands of elements. HDC operations are light-weight, highly parallelizable, and robust to noise, so they are well-suited for computations in resource-constrained environments. As a result, HDC has been used in a plethora of applications including natural language processing [49], robotics [39], voice and gesture recognition [21, 48], emotion recognition [8], graph learning [43], DNA sequencing [34], recommender systems [17], and bio-signal processing [5].

HDC algorithms can run on multi-core CPUs [40, 59] and GPUs [29, 30, 56] due to their highly parallel character. In recent years, FPGA-based, ASIC-based, and processing-in-memory (PIM) based HDC accelerators have achieved higher performance and energy efficiency [11, 12, 14, 15, 18, 22, 24, 25, 33, 46, 53, 64–67]. These accelerators have specialized on-chip buffers and pipelined components to maximize parallelism and minimize data movement. Some based on resistive RAM (ReRAM) [64] and phase change memory (PCM) [15] also require hardware-specific optimizations to manage trade-offs between accuracy and energy efficiency / performance.

Custom accelerators will only succeed if they are supported by practical, widely adopted programming models and development tools. In the case of HDC, realistic applications must be able to run on custom accelerators as well as more widely available devices like

*Equally contributing authors.

CPUs and GPUs because suitable accelerators are usually available on some systems and not others. Even when an accelerator is available, in our experience, accelerators only support a proper subset of core HDC operations, forcing some application components to run on other hardware; moreover, this partitioning between accelerator and general purpose hardware is different for different accelerators. To achieve this kind of portability and flexible application partitioning, HDC applications require appropriate high-level abstractions to effectively target accelerators and heterogeneous hardware. Without such abstractions, application developers must write their applications to run well on each specific target because an application parallelized for GPU cannot be recompiled and run for an HDC ASIC or for a PIM-based device. Writing such multi-version code would be impractical for production software.

There are at least three challenges in designing and supporting high-level, easily portable programming abstractions for HDC applications. First, HDC programming requires novel and unusual data encoding schemes, combined with hypervector and hypermatrix operations that depend on those encoding schemes [19]. These custom schemes must be captured in the high-level programming model without putting undue burden on the programmer to implement the encoding-specific details of common operations. Second, to achieve high performance on many targets, including CPUs, GPUs, and others, programs must use hardware-specific optimizations that maximize data locality and leverage different forms of parallelism in HDC algorithms. High-level abstractions cannot expose these kinds of optimization options or hardware primitives. Instead, compilers must automatically achieve such optimization requirements while minimizing the need for hardware-specific tuning and programmer guidance (e.g., using command line options or configuration files). Third, achieving adequate accuracy with HDC algorithms is difficult and hardware-dependent: it requires optimizing different algorithmic choices, including the encoding strategy (data-dependent encoding, random projection, custom implementation, etc.), the similarity search schemes (cosine similarity, Hamming distance, etc.), the number of iterations, hypervector length and element precision, and different approximation choices. The optimal choices often vary between hardware devices, forcing difficult hardware-specific tuning. Again, compilers must automatically perform such tuning with limited programmer guidance.

Prior work in HDC algorithm development use general purpose and target specific languages such as Python [19, 30, 56–58] and MATLAB [16, 37], but rely on CUDA for GPUs [34, 54], and C++ with hardware-specific primitives for FPGAs [24, 52]. HDCC [59] is a HDC-specific compiler that can compile high-level descriptions of HDC algorithms to multi-threaded C code with vector extensions, but it only targets multi-core CPUs. Applications targeting each of the devices previously mentioned are often split into entirely separate programs, possibly in different languages. Programmers must implement and hand-optimize different versions of HDC algorithms using different languages to target various devices, significantly hampering programmer productivity. Moreover, targeting HDC accelerators that support specialized coarse-grained instructions requires writing target-specific code that is very different from the lower-level operations used on CPUs and GPUs.

To address the challenges described above, we propose a C++-based programming language, HDC++ (Section 3), that provides

three major benefits. First, it creates a set of common high-level abstractions specifically for HDC that enable programmers to implement HDC algorithms without worrying about low-level target-specific optimizations. Second, it strikes a balance between the complexity of implementing HDC algorithms and flexibility in exploring different algorithmic and approximation choices by providing high-level abstractions that make tweaking algorithms easier while also allowing programmers to implement custom algorithms for their HDC applications. (Section 5.4). Third, it improves programmer productivity by abstracting away the hardware executing the application—the provided primitives are hardware-independent, so the same HDC++ application can be compiled and executed on CPUs, GPUs, and multiple different HDC accelerators *without code modification*. We have ported five applications to HDC++ and successfully compiled them to suitable hardware targets. We show in Section 5.2 that using a hardware-agnostic language does not have a negative impact on performance.

We also propose HPVM-HDC (Section 4), a compiler based on Heterogeneous Parallel Virtual Machine (HPVM) [13, 35] that compiles hardware agnostic HDC++ applications automatically to several hardware targets, including CPUs, GPUs, and two custom HDC accelerators. HDC++ programs are lowered to a retargetable intermediate representation (IR) with HDC-specific operations. The HPVM-HDC IR structurally captures the parallelism in HDC algorithms, enabling compilation onto hardware targets with coarse-grained instructions such as HDC accelerators as well as targets exposing fine-grained parallelism such as GPUs. Additionally, HPVM-HDC IR supports domain-specific optimizations that exploit the inherent trade-off in HDC between end-to-end quality of service and performance. We implement two such optimizations: automatic binarization, which enables programmers to automatically modify hypervector lengths and precisions to use efficient 1-bit level computations, and reduction perforation, which skips elements in hypervectors when computing reductions. Such approximations lead to significant speedups with little programmer effort and marginal loss in application-level quality of service (Section 5.3). HPVM-HDC lowers HDC-specific operations through target specific backends for a wide variety of hardware targets: CPUs, GPUs, and two custom hardware accelerators: a taped-out digital ASIC and a simulated Resistive RAM (ReRAM) accelerator (Section 4.3). Baseline implementations of our evaluated HDC applications exist only for CPUs and GPUs (and are target-specific)—HPVM-HDC achieves competitive performance with those baseline implementations *using a single retargetable implementation*, achieving a geometric speed-up of 1.17x against optimized baseline CUDA implementations on GPUs. For the accelerators we compile applications to using HPVM-HDC, *no prior evaluation has been performed with a full HDC application*.

Overall, this paper makes the following contributions.

- The first set of high-level and expressive programming abstractions for writing HDC programs easily without the need to specialize them for specific hardware targets and without losing performance or accuracy (Section 3).
- The first retargetable compilation framework for HDC, HPVM-HDC, which compiles HDC++ programs and generates high-performance code for a variety of hardware

targets including CPUs, GPUs, an ASIC-based accelerator, and a ReRAM-based accelerator simulator (Section 4).

- An evaluation of the programming system on multiple HDC applications (HD-Classification, HD-Clustering, HyperOMS, ReHD, and HD-Hashtable). HPVM-HDC achieves competitive performance with existing target-specific baseline implementations, achieving a geomean speed-up of 1.17x against optimized baseline CUDA codes on GPUs. Additionally, we offer the first demonstration of executing certain applications on recent HDC accelerators for which there are no baseline implementations (Section 5.2).
- An evaluation of domain specific approximation-based compiler optimizations with HPVM-HDC that are supported on the CPU and GPU targets. We observe up to 3.4x performance improvement of HDC inference on the GPU with marginal loss in end-to-end accuracy (Section 5.3).
- A thorough analysis of programmability with HDC++. We observe a 1.6x reduction in the total number of lines of codes needed to express HDC applications when using HDC++ over baseline codes. Additionally, common tuning edits take seconds in HDC++, compared to minutes or hours in baseline codes. (Section 5.4).

2 Background

2.1 Hyperdimensional Computing

Hyperdimensional Computing (HDC) is a machine learning paradigm inspired by cognitive models of computation. HDC algorithms operate by encoding input features into a high dimensional representation called hypervectors. In contrast to Deep Neural Networks (DNNs) which rely on expensive feed-forward computations for inference, HDC relies on lightweight search through the class hypervector database representing the model. The most similar class hypervector signifies the predicted label. HDC training uses efficient element-wise addition instead of back-propagation. Fine-tuning HDC hyper-parameters (such as element representation, encoding dimensionality and training iterations) and algorithm choices play a much more important role in practice for achieving good quality with HDC in comparison to DNNs, where back-propagation can compensate for sub-optimal choices during training. HDC algorithms generally vary in the used encoding schemes, search algorithms, and training procedures which are often application specific. These different algorithms can be used to implement many kinds of applications, including classification [68], clustering [20], and GNN learning [32] (see Table 2). The lightweight and parallel nature of HDC enables high performance across hardware targets.

Optimizing HDC operations for specific hardware targets and ensuring parallelization, efficient data reuse, and maintaining cache hierarchies requires low-level adjustments that are difficult to generalize across platforms, especially without domain and hardware expertise. Similarly, choosing the best encoding scheme for an application requires domain expertise.

Adapting HDC applications to new frameworks and accelerators often necessitates redefining encoding schemes and retraining models, which can be both time-consuming and suboptimal. For instance, HyperSpec [63] and HyperOMS [31] are two large-scale data analytics workloads in the domain of proteomics, specifically

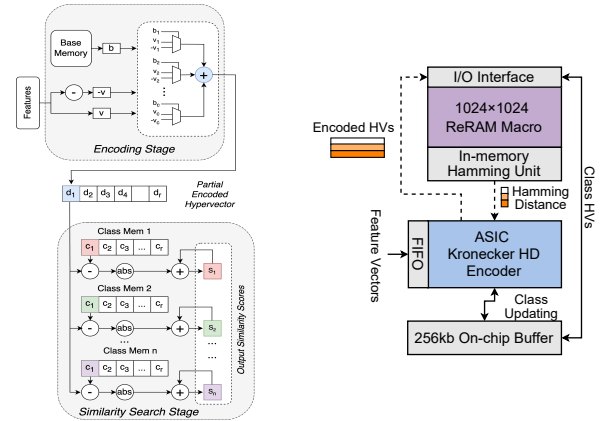

Figure 1: Architecture block diagrams for the HD Digital ASIC (left) and HD ReRAM accelerator (right).

for proteomics data clustering and library searching. The scalability of these two applications are limited due to repeated data movement. Prior works [46, 47] have used near-storage FPGA implementations to address these challenges, however require extensive manual effort in rewriting and verification, optimization of memory access patterns, low-level hardware interfacing, and ensuring computational correctness of algorithms under constrained resources.

2.2 HDC Hardware Accelerators

HPVM-HDC compiles to two custom HDC accelerators. In this section we briefly describe the hardware architectures. Figure 1 shows diagrams for these architectures.

HD Digital ASIC: We run HDC workloads on an ASIC chip fabricated in a 40nm technology. The architecture of the ASIC is described in [65] and uses pipelined encoding and Hamming distance search. The ASIC provides a functional interface for device configuration, data movement, and training and inference operations. Input data points are encoded automatically when moved to the device. See Listing 6 for example code generated by HPVM-HDC targeting this interface. Execution times are measured on the chip.

HD ReRAM: We used a simulator for a resistive RAM (ReRAM) accelerator to emulate the performance of HDC code executing on ReRAM hardware. The design is described in [64], and has a similar programming interface to the digital ASIC chip. The simulator uses extracted timing and energy parameters from commercial SRAM and ReRAM macros in the 40nm technology node provided by a foundry. These parameters are loaded into the HD ReRAM simulator (executed on a host machine) to estimate the runtime.

Although these accelerators use different processing technologies to accelerate HDC workloads, their programming interfaces are similar. They expose high-level operations to the host machine, such as run one iteration of training given a single data point or infer the label for a single hypervector given pre-programmed class hypervectors. Other proposed HDC accelerators [15] expose a similar programming model. These instructions are difficult to generate from existing HDC codes. Monolithic encoding, inference, and training instructions are too high-level to automatically identify in low-level application code commonly found in prior work on

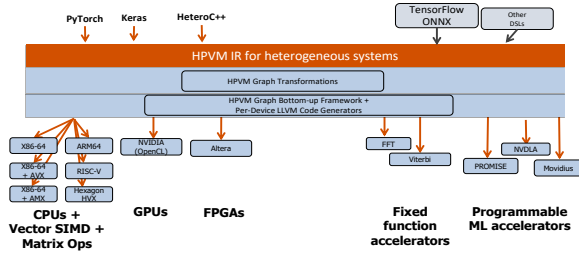

Figure 2: The HPVM Compiler Infrastructure [13].

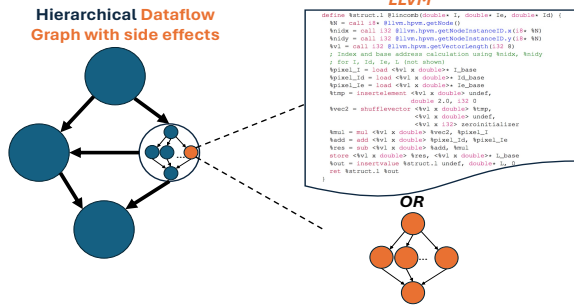

Figure 3: Hierarchical representation of code in HPVM. Each node in the dataflow graph corresponds to either a leaf node performing compute (LLVM function) or a nested sub-graph. Edges between nodes correspond to logical data transfers.

HDC algorithms, as compilers cannot typically reason with enough certainty about the algorithms a user may implement.

2.3 HPVM Compiler Infrastructure

The HPVM Compiler Infrastructure [13] extends the LLVM compiler infrastructure with a retargetable parallel program representation for heterogeneous architectures (as shown in Figure 2). HPVM IR provides constructs for representing various forms of parallelism including task-level, data-level, and streaming parallelism. (shown in Figure 3). Parallel programs are represented using a hierarchical directed acyclic graph (DAG). Nodes in the graph are categorized into two categories: internal nodes, which capture hierarchical parallelism by containing entire sub-graphs, and leaf nodes, which represent individual units of computation. Edges between nodes in the HPVM DAG represent logical data transfers. Additionally, each node is annotated with one or more hardware targets, and code is generated by the appropriate back ends for each of those targets.

2.4 Hetero-C++

Hetero-C++ is a parallel C++ dialect which compiles to HPVM IR [13]. Hetero-C++ provides a high-level, target-agnostic programming interface for capturing the various forms of parallelism in their application. A function in Hetero-C++ may be split into multiple parallel tasks and parallel loops which individually would be lowered to distinct HPVM IR nodes. These distinct components in

a single application are individually compiled to different targets as specified by the user, easing programmability for applications on heterogeneous systems and improving portability across systems. Both HDC++ and Hetero-C++ use marker functions instead of pragmas to retain placement within the emitted LLVM IR.

3 The HDC++ Language

HDC++ is a domain specific language built on top of Hetero-C++, a parallel dialect of C++ [13]. (Note that the choice of this base language is not essential: any widely used compiled language with explicit task and data parallelism would achieve the same purpose.) HDC++ introduces primitives for creating and manipulating hyper-vectors and hypermatrices, allowing developers to easily develop HDC algorithms inside their applications. Listing 1 shows how HDC++ can be used to express classification inference. First, random projection encoding is used to encode input features into a 2048-dimensional representation. Then, Hamming distance is applied between the encoded hypervector and the class hypervectors (represented using a hypermatrix datatype) to produce a vector of dissimilarities. In this example, the result is a 26 dimensional vector, as there are 26 output label classes. Finally, the HDC arg_min operation identifies the corresponding class hypervector which is most similar to the encoded hypervector.

```

1 hypervector <2048> encoded_data = __hetero_hdc_matmul(
    input_features, rp_matrix);
2 hypervector <26> dists = __hetero_hdc_hamming_distance(
    encoded_data, clusters_matrix);
3 int label = __hetero_hdc_arg_min(dists);

```

Listing 1: HDC++ example for random-projection encoding and dis-similarity between query and class hypervectors.

In addition to HDC specific primitives, application developers writing HDC++ can use Hetero-C++ primitives for expressing generic parallel code. HDC applications exhibit parallelism both within the HDC algorithmic primitives (i.e. operator data-level parallelism), as well as across operations (i.e. task-level or outer-loop-level parallelism). By enabling HDC++ to interoperate with Hetero-C++, application developers can compactly describe complex HDC algorithms using HDC primitives while sufficiently describing any other parallelism using Hetero-C++ and keeping the application entirely retargetable. For example, the HyperOMS [31] application uses level ID encoding, which has an outer parallel loop that isn't captured by HDC primitives, but is captured by Hetero-C++'s parallel loop annotation. HDC++ can express all the components of the HyperOMS application in a parallel fashion, providing both programmability and performance.

HDC++ contains 24 HDC primitives for expressing HDC algorithms in a target-agnostic programming interface. The primitives are parameterized by the element type and the dimensionality of the involved hypervectors and hypermatrices. A comprehensive list of the HD primitives is presented in Table 1.

3.1 High-Level Stage Primitives

In addition to describing individual HDC operations, HDC++ enables describing three commonly used HDC algorithmic **stages**: `encoding_loop`, `training_loop`, `inference_loop`. Listing 2 illustrates expressing an HDC inference loop using the corresponding

HDC Algorithmic Primitive	Description
{HV, HM} hyper{vector, matrix} (void)	Initialize an empty hypervector / hypermatrix
{HV, HM} create_hyper{vector, matrix}(Function init)	Initialize a hypervector / hypermatrix with an initialization function
{HV, HM} random_hyper{vector, matrix} (void)	Initialize a hypervector / hypermatrix with random values
{HV, HM} gaussian_hyper{vector, matrix}(void)	Initialize a hypervector / hypermatrix with gaussian distribution.
HV wrap_shift(HV input, int shift_amount)	Rotate with wrap-around elements in hypervector
{HV, HM} sign ({HV, HM} input)	Maps each element to +1, -1 by checking the sign of the element.
{HV, HM} sign_flip ({HV, HM} input)	Flips the sign of each element in a hypervector / hypermatrix
{HV, HM} {add, sub, mul, div} {(HV, HV) lhs, (HM, HM) rhs}	Element-wise binary operators between hypervectors / hypermatrices
{HV, HM} absolute_value ({HV, HM} input)	Element-wise absolute value operation on hypervector / hypermatrix
{HV, HM} cosine ({HV, HM} input)	Element-wise cosine operation on hypervector / hypermatrix
{T, HV} l2norm ({HV, HM} input)	Calculate the L2 Norm for hypervector / hypermatrix.
T get_element ({HV, HM}, int row_idx[, int col_idx])	Indexing into a hypervector / hypermatrix.
{HV, HM} type_cast ({HV, HM} input, T ty)	Type cast hypervector / hypermatrices elements to result type
{T, HV} arg_{min, max}({HV, HM} input)	Return the arg max or min of a hypervector / per row of hypermatrix
void set_matrix_row(HM mat, HV new_row, int row_idx)	Update a specified row in the hypermatrix with a provided hypervector
HV get_matrix_row (HM mat, int row_idx)	Get a specified row in the hypermatrix producing a hypervector
HM matrix_transpose (HM input)	Transpose hypermatrix
{T, HV, HM} cossim({HV, HM} lhs, {HV, HM} rhs)	Perform cosine similarity between hypervectors
{T, HV, HM} hamming_distance({HV, HM} lhs, {HV, HM} rhs)	Perform Hamming distance between hypervectors
{HV, HM} matmul({HV, HM} lhs, HM rhs)	Matrix multiplication between hypervectors and hypermatrices
void red_perf({T, HV, HM} result, int begin, int end, int stride)	Annotates HDC primitive returning result with description of reduction perforation (Section 4.2).
HM encoding_loop(Func encode, HM queries, HM encoder)	Apply HDC encoding over entire dataset
int[] inference_loop(Func infer, HM queries, HM classes)	Apply HDC inference over entire dataset
void training_loop(Func train, HM queries, int[] labels, HM classes, int epochs)	Apply HDC training over entire dataset

Table 1: HDC primitives in HDC++. HV and HM denote the hypervector and hypermatrix types respectively. T denotes an element type, which is a signed scalar type (any of `int8_t`, `int16_t`, `int32_t`, `int64_t`, `float`, or `double`).

primitive. There are two advantages of providing such high-level primitives. First, it enables HPVM-HDC to target HDC accelerators, which provide coarse-grain algorithm acceleration, in contrast to acceleration of finer-grain HDC operations. Second, the use of loop intrinsics for the key algorithmic stages implemented by the HDC accelerators allows HPVM-HDC to elide data movements to and from the accelerators. Section 4.3 describes HPVM-HDC in detail. Crucially, these high-level stage primitives are composable with more granular primitives in HDC++—this allows us to express certain applications that map partially, but not fully to HDC accelerators, such as HD-Clustering. By writing HD-Clustering in HDC++, we are able to map the computationally intensive part of clustering, HDC inference, to HDC accelerators, while performing more ancillary tasks, such as cluster updates and the initial generation of the random projection matrix, on the CPU or GPU.

The algorithmic stage primitives in HDC++ each take as input an "implementation" function. This function implements encoding, training, or inference using more granular HDC primitives, and is executed when targeting CPUs or GPUs, rather than HDC accelerators. This is because while HDC accelerators implement specific encoding, training, and inference algorithms, CPUs and GPUs can be programmed to implement a variety of algorithms—it is up to the application developer to choose concrete versions of these algorithms for these targets. The benefits of this approach are elaborated on in Section 4.3.

```
1 __hetero_hdc_inference_loop(InferenceFunction, QueriesHM,
   ClassHM, InferenceResults);
```

Listing 2: HDC++ example of an inference loop. `QueriesHM` are input vectors to classify, `ClassHM` contains representative hypervectors per class (see Section 2.1), `InferenceResults` is the destination pointer to store the results in, and `InferenceFunction` is a function implementing the inference algorithm using HDC primitives.

4 The HPVM-HDC Compiler

Figure 4 illustrates the compilation workflow for HDC++ applications onto various target architectures. HPVM-HDC compiles HDC++ application code to an intermediate representation for HDC that is extended from the base HPVM IR (Section 4.1). Then, optimizations are optionally performed (Section 4.2). Finally, the program is compiled to the user-specified target, generating the appropriate device and host code (Section 4.3).

4.1 The HPVM-HDC IR

HDC++ application code is compiled into an IR that contains HDC primitives as well as generic parallel task and loop primitives. The HDC primitives are LLVM intrinsics which represent the same operations as the HDC++ primitives listed in Table 1. The generic

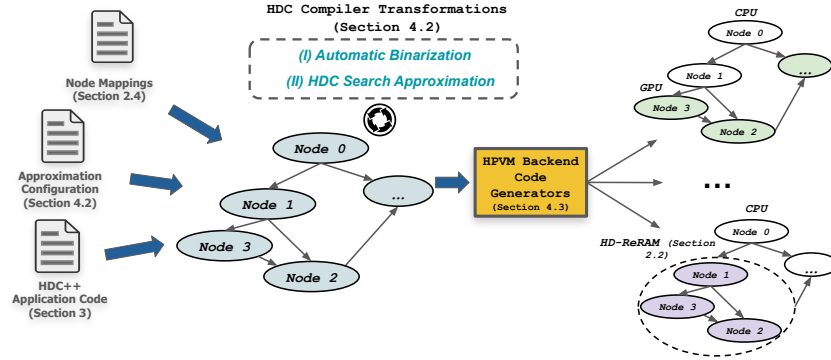

Figure 4: Compilation workflow of an HDC++ application using the HPVM-HDC compiler. First the HDC++ application is compiled to HPVM IR with HDC primitives. Optional HDC optimizations are performed. Finally, the application is compiled to different hardware targets. Different nodes in a DFG may be lowered to different hardware targets.

parallel task and loop primitives come from HPVM IR, which represents code using LLVM IR with additional annotations and an auxiliary hierarchical dataflow graph representing both data and task parallelism. The combination of these two kinds of primitives on top of LLVM IR form HPVM-HDC IR. Lowering HDC++ into HPVM-HDC IR is simple. HPVM already has infrastructure for transforming opaque function calls in Hetero-C++ into LLVM intrinsics; we use this functionality to lower HDC primitives, which are opaque function calls in C++, to LLVM intrinsics. These HDC primitives become intrinsics inline the HPVM IR node functions.

HDC primitive intrinsic functions in HPVM-HDC IR can be lowered in two different ways, depending on the targeted device. They may be lowered by translating intrinsics into HPVM IR subgraphs representing the underlying computation of those HDC operation. As an example, consider compiling a Hamming distance primitive (Listing 3). HPVM-HDC can lower the primitive into a two deep loop nest, where the outer loop iterates over the classes dimension and the inner loop iterates over the hypervector dimension (Listing 4). HPVM represents parallel loop iterations as a set of dynamic instances of a node function, each with a unique ID corresponding to the loop index. In this example, the outer loop is known to be parallel, and is outlined into a separate function. The parallel loop iteration is identified by first obtaining the handle to the node in the DFG (line 6) and then querying the dynamic instance ID (line 7). Additional annotations are emitted on line 5 specifying *data* and *classes* as input edges and *result* as an input and output edge. In this scenario, HDC primitives are lowered into generic HPVM IR before the compiler backends are invoked.

```

1 void get_dissimilarity(hypervector<2048> data,
2   hypermatrix<26, 2048> classes,
3   hypervector<26> result)
4   result = __hetero_hdc_hamming_distance(data, classes);
5 }

```

Listing 3: Hamming Distance calculation in HDC++.

```

1 void get_dissimilarity_parallel_node(
2   hypervector<2048> data,
3   hypermatrix<26, 2048> classes,
4   hypervector<26> result)
5   __hpvm__attributes(3, data, classes, result, 1, result);

```

```

6   void* NodeID = __hpvm__getNode();
7   int i = __hpvm__getNodeInstanceID_x(NodeID);
8   float distance = 0;
9   for(int j = 0; j < 2048; j++)
10    distance += data[j] == classes[i][j] ? 0 : 1;
11   result[i] = distance;
12   __hpvm__return(1, result);
13 }

```

Listing 4: Hamming Distance calculation in HPVM IR.

HDC primitives may instead be lowered by translating the intrinsics into calls to CUDA kernels, cuBLAS [1] calls, Thrust [3] calls, or calls to an accelerators’ functional interface. These primitives are not lowered into generic HPVM IR. Instead, the compiler backends will generate the appropriate code from the HDC primitives directly. HPVM-HDC decides which lowering strategy to take based on which backend is invoked by the user (see Section 4.3).

4.2 HDC Approximation Optimizations

The HDC paradigm is robust to error, both in inputs and in processing [28]—this enables various approximation techniques on HDC applications. We implement two such optimizations in HPVM-HDC for transforming HDC++ applications.

Automatic Binarization Propagation. The HDC paradigm requires exploring different choices for the size of the encoding dimension, element types, and choice of HDC operations. As HDC++ primitives are parameterized by types, the application developer may choose to represent the resultant hypervector using the same element type as the input features (e.g. float) or a different type (e.g. int8_t). The developer may have to manually rewrite many HDC operations to operate on the appropriate types as well as fix allocations of data with the appropriate allocation sizes. An example of such a transformation is to set the element type of some hypervectors to a single bit. This may be beneficial when using the *hdc_sign* HD-primitive in HDC++, which maps elements in hypervectors and hypermatrices to a binary representation in $\{+1, -1\}$.

To reduce the burden on the programmer in performing such rewrites, we implement an automatic binarization inter-procedural analysis and transformation described in Algorithm 1. The algorithm performs a taint-analysis to identify which HD operations and

allocations are tainted by *hdc_sign* and then subsequently rewrites them to operate on the reduced element-bitwidth. The reduced bitwidth representation is a parameter of this transformation. For a single bit-representation, the lowering of HDC primitives are handled using bitvector logical operations. Any HDC primitives requiring additional allocation updates are binarized accordingly. By default, automatic binarization only binarizes the results of reducing operations such as *matmul*, *cosim_similarity*, and *hamming_distance*, and binarizes both the inputs and outputs of element-wise HDC operations. More aggressive binarization can be toggled by specifying another command-line option which reduces precision for the inputs of reducing HDC operations.

Algorithm 1 Algorithm for Automatic Binarization

```

1: procedure HDCBINARIZE(P : Program, BinarizedTy: Type,
   BinarizeReduce? : Bool)
2:   Worklist ← GetHDCSignInsts(P)
3:   // Set of HD operations which directly or indirectly
4:   // interact with a binarized hypervector or hypermatrix
5:   TaintedOpSet ← {}
6:   while WorkList ≠ {} do
7:     I ← Extract(WorkList)
8:     TaintedOpSet ← TaintedOpSet ∪ {I}
9:     if BinarizeReduce? & IsHDCReduceOp(I) then
10:      // Taint both input and output vectors/matrices
11:      Worklist ← TaintInputOutput(I, WorkList)
12:     else if IsHDCReduceOp(I) then
13:      // Taint only output hypervectors/matrices
14:      Worklist ← TaintOutput(I, WorkList)
15:     else
16:      Worklist ← TaintInputOutput(I, WorkList)
17:   for I ∈ TaintedOpSet do
18:     // Replace I with Binarized Primitive
19:     P ← Binarize(I, BinarizedTy, BinarizeReduce?)

```

Reduction Perforation. Reduction operators are common primitives in HDC algorithms—matrix multiplication is used in random projection encoding, and hamming distance and cosine similarity are used in HDC inference algorithms that identify which representative hypervector a query hypervector is most similar to. Due to the error resilience of HDC, it may be sufficient to perform these operations approximately by skipping elements along the reduction axis. We provide application developers a mechanism for controlling such approximations by exposing an HD reduction perforation directive, *red_perf*. The reduction computation may be approximated by performing either a segmented reduction or a strided reduction [55]. In the former, a contiguous sub-range of elements in hypervectors are used to calculate the reduction, whereas in the latter a strided access of elements in hypervectors are used. The parameters for these approximations are exposed to the application developer in their HDC++ source code.

Reduction perforation is specified with the *red_perf* HDC++ primitive. The first argument is the value computed by the reduction primitive the programmer wants to approximate, the second argument is the starting offset into the hypervectors, the third argument is the ending offset into the hypervectors, and the fourth

argument is the stride to sample elements at between this range. *red_perf* acts as a compiler directive, indicating that loops generated for another operation should be modified—it can be applied to *hamming_distance*, *cosim_similarity*, *matmul*, and *l2norm*. For *hamming_distance* and *cosim_similarity*, only the relative magnitude between (dis)similarities matters in every HDC application we know of. Thus, we don’t scale the final (dis)similarity to accommodate for skipping elements. For *matmul* and *l2norm*, we divide accumulated values by the proportion of elements in the original hypervectors that were visited. For these intrinsics, scaling is necessary since their usage is diverse in HDC applications, so their absolute magnitudes matter. Reduction perforation is a specific application of loop perforation [55] to HDC operations. Listing 5 illustrates a strided and segmented Hamming distance calculation.

```

1 hypervector <2048> A, B = ...;
2 // Calculate hamming distance in the sub-range [0, 1024)
3 auto dst_segmented = __hetero_hdc_hamming_distance(A, B);
4 __hetero_hdc_red_perf(dst_segmented, 0, 1024, 1);
5 // Calculate hamming distance for every other element
6 auto dst_strided = __hetero_hdc_hamming_distance(A, B);
7 __hetero_hdc_red_perf(dst_strided, 0, 2048, 2);
8 // Hamming distance for every other element in [0, 1024)
9 auto dst_both = __hetero_hdc_hamming_distance(A, B);
10 __hetero_hdc_red_perf(dst_both, 0, 1024, 2);

```

Listing 5: Simplified HDC++ example describing a segmented and/or strided approximated Hamming distance.

These two optimizations are fundamentally approximate. Automatic binarization reduces element bitwidth which reduces data-movement between the host and device and also improves throughput by using hardware efficient bit-wise operations. Reduction perforation approximates reduction operators between hypervectors which improves performance by reducing the total number of computations which need to be performed. These are optional transformations in HPVM-HDC; we study their implementation and empirical effects, but do not tackle automatic selection of approximations. However, they are easily explorable by an application developer; automatic binarization is exposed as compiler flags and reduction perforation is exposed as an optional HDC++ primitive that doesn’t affect algorithm code. They are applicable on the CPU and GPU, since these devices have the flexibility to execute HDC operations with different element types and loop iteration spaces. However, they are not applicable on the HDC accelerators, since these devices do not support these approximations.

4.3 Back End Code Generation

When targeting the CPU, HPVM-HDC translates HDC primitives into HPVM IR subgraphs containing data-level parallelism. These subgraphs seamlessly interoperate with other Hetero-C++ parallel constructs used by the programmer, for example to express encoding. Once the entire application is lowered into HPVM IR, HPVM-HDC uses HPVM’s CPU backend to generate an executable.

On the GPU, HPVM-HDC takes advantage of optimized routines written in CUDA, cuBLAS [1], and Thrust [3], which are NVIDIA-specific GPU programming interfaces. cuBLAS contains optimized implementations of matrix multiplication, transposition, and normalization, while Thrust contains optimized reduction routines.

When targeting NVIDIA GPUs, HPVM-HDC lowers HDC primitives directly to cuBLAS calls, Thrust calls, or CUDA kernels instead of HPVM IR to take advantage of these optimized GPU routines. Generic parallel code expressed using Hetero-C++ primitives are instead lowered to HPVM-IR and then OpenCL code using HPVM’s generic GPU back end. In Section 5, we compile an application, HyperOMS, that utilizes both of these lowering schemes.

HPVM-HDC targets two HDC accelerators: a digital ASIC and a ReRAM accelerator simulator. These devices provide coarse-grain operations for performing HDC encoding, training, and inference. These operations are impractical to automatically identify in programs expressed with granular HDC primitives. Additionally, we want to minimize data movement costs between the host machine and the devices. HPVM-HDC lowers the *encoding_loop*, *training_loop*, and *inference_loop* primitives to calls to the accelerators’ low-level functional interface. Listing 6 shows an example of lowering *training_loop* and *inference_loop*. Crucially, HPVM-HDC can lift redundant data movements outside of loops, which would be much more difficult with non-loop based HDC primitives.

While these accelerators implement particular algorithms for HDC encoding, training, and inference, this is not reflected in the high-level HDC++ primitives. This is because the encoding, training, and inference algorithms that could be used on CPUs or GPUs are diverse and require user specification. This user specification comes in the form of an implementation function, built using more granular HDC primitives (as shown in Listing 2). The implementation function is used when targeting CPUs or GPUs, while high-level HDC operations are leveraged when targeting HDC accelerators. This has two benefits. First, HDC++ applications can achieve competitive performance on all targets, as HPVM-HDC already compiles the more granular HDC primitives in the implementation function to generate efficient code. Second, the rest of the HDC application can be built irrespective of whether encoding, training, or inference are actually performed on a CPU, GPU, or an HDC accelerator.

```

1 config_t config = ...;
2 initialize_device(&config);
3 allocate_base_mem(random_projection);
4 allocate_class_mem(classes);
5 for (int n = 0; n < EPOCHS; ++n)
6     for (int i = 0; i < N_TRAIN; ++i)
7         allocate_feature_mem(train_inputs[i]);
8         execute_retrain(train_labels[i]);
9 read_class_mem(classes);
10 allocate_base_mem(random_projection);
11 allocate_class_mem(classes);
12 for (int i = 0; i < N_TEST; ++i)
13     allocate_feature_mem(infer_inputs[i]);
14 infer_labels[i] = execute_inference();

```

Listing 6: HPVM-HDC generated code for performing HDC training and inference on the HD Digital ASIC.

5 Evaluation

5.1 Methodology

Hardware targets. The evaluation setup for CPU and GPU consists of an Intel(R) Xeon(R) Silver 4216 CPU with 16 cores, 32 threads, and 192GB of memory and an NVIDIA GeForce RTX 2080 Ti GPU with 11GB of memory. We execute the HD-Digital ASIC as an accelerator attached to an ARM core as the host through a custom FPGA-based

interface. We execute the ReRAM accelerator simulator on the Intel machine—the simulator calculates an estimate of the latency of a taped out ReRAM accelerator. For comparison with the HDC accelerators, we also execute HDC++ applications on an NVIDIA Jetson AGX Orin 64GB board with an Ampere GPU with 2048 CUDA cores and 64 tensor cores—this comparison is meant to be more representative of hardware available at the edge, which is the target use case of these HDC accelerators. Note that the Jetson AGX Orin is a moderately powerful GPU relative to other edge-class GPUs.

Metrics and measurements. We measure the wall clock time as a mean of 3 repeated executions on an otherwise idle system.

Applications: The applications are implemented in HDC++ and summarized in Table 2, along with the computational stages in these applications. HD-Classification and HD-Clustering represent common units of computation in HDC applications, while HyperOMS, RelHD, and HD-Hashtable are three existing HDC applications from prior work. Our evaluated workloads capture most of the core computations present in other HDC applications, such as HyperSpec, SpecHD, HDBind, HyperGen, and RapidOMS [27, 46, 47, 62, 63]. HD-Classification and HD-Clustering codes were developed and tuned as part of [20, 68]. We used the reference implementations available for Rel-HD [32] and HyperOMS [31]. The HD-Hashtable code is a modified version of [69], optimized for using hash tables. All five applications were developed by domain experts in prior work, and were originally hand-tuned for at least one hardware target. We evaluate HD-Classification and HD-Clustering on the Isolet [10] dataset of spoken letters, HyperOMS on the Yeast and Human Spectral Library dataset and the iPRG2012 dataset [7, 61], RelHD on the Cora dataset [38] of categorized scientific papers, and HD-Hashtable on Genomics dataset adapted from [6].

5.2 Performance

To evaluate HPVM-HDC’s performance across architectures, we evaluate the aforementioned applications on the four hardware targets listed above. We evaluate HD-Classification and HD-Clustering on all 4 hardware targets, and HyperOMS and RelHD on the CPU and GPU only. The HDC accelerators expose coarse-grain computations for random projection encoding, training, and inference. HD-Classification maps efficiently to all three of these operations, while HD-Clustering maps to random projection encoding and inference. The other three applications do not map to these particular coarse-grained operations; we are therefore unable to execute those three applications on the HDC custom accelerators.

Figure 5 shows the relative speedup in wall clock time for each application on CPU and GPU when compiled with HPVM-HDC, compared to the baseline device-specific codes for these devices. HyperOMS lacks a CPU version we can use as the baseline—we omit the relative speedup bar in that case. In contrast, all of the applications can be compiled for and run on CPUs and GPUs using HPVM-HDC. HPVM-HDC achieves significant speed-ups over several baseline codes across architectures without using approximation-based optimizations. This advantage is of course a function of the specific implementation and tuning choices of those baselines and not a fundamental advantage of HPVM-HDC. The key contribution of HPVM-HDC is achieving *competitive* performance across

HDC Applications	Workload Significance	HDC Stages Used
HD-Classification [68]	Classification implemented using HDC	Random-Projection Encoding, Inference, Training
HD-Clustering [20, 68]	K-means clustering implemented using HDC	Random-Projection Encoding, Inference
HyperOMS [31]	Open Modification Search for Mass Spectrometry	Level ID Encoding, Inference
RelHD [32]	GNN learning, data relationship analysis	Graph Neighbor Encoding, Inference, Training
HD-Hashtable [69]	Genome Sequence Search for Long Reads Sequencing using HD hashing	K-mer based Encoding, Inference

Table 2: Summary of HDC applications implemented in HDC++ and evaluated using HPVM-HDC. Applications using HDC require similar stages, however the specific algorithms used vary across application domains.

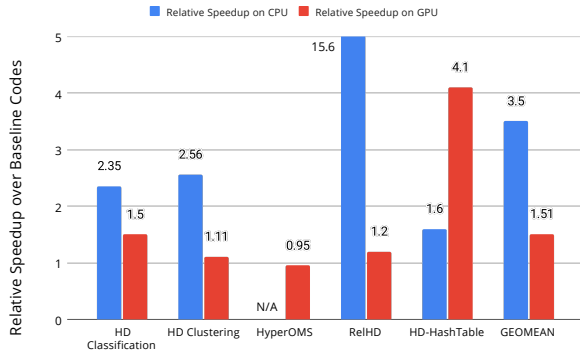

Figure 5: Performance of applications written in HDC++ and compiled with HPVM-HDC for execution on CPU and GPU, compared against hand-written device-specific baseline codes. The relative speed-up of the HDC++ implementation is shown, higher is better.

applications and architectures while presenting a high-level, target-agnostic programming interface in HDC++.

Performance on CPU. HPVM-HDC targets CPUs by lowering HPVM IR into sequential machine code. Each application with a CPU baseline uses Python and NumPy. We do not draw conclusions with regards to performance improvements on the CPU as the reference implementations are interpreted in Python while HPVM-HDC codes are compiled ahead-of-time, which inherently does not suffer from the overheads of the Python interpreter.

Performance on GPU. For GPUs, HPVM-HDC lowers HDC primitives into calls to CUDA kernels, cuBLAS functions, or Thrust functions, and lowers generic parallel HPVM IR to OpenCL using HPVM’s GPU backend. The only application that is slower when written in HDC++ is HyperOMS—the bottleneck portion of HyperOMS in our experiments is level ID encoding. In our HDC++ implementation, this is written using generic Hetero-C++ parallel constructs which generate OpenCL using HPVM’s GPU backend. In contrast, the baseline implementation uses an optimized CUDA kernel, including the use of warp-level primitives that HPVM cannot generate. Similar to the CPU compiled benchmarks, HD-Hashtable’s GPU compilation is interpreted in Python using CuPy, whereas HPVM-HDC generates a compiled executable. HD-Classification, HD-Clustering, HyperOMS and RelHD provide a CUDA C++ baseline implementation which present meaningful

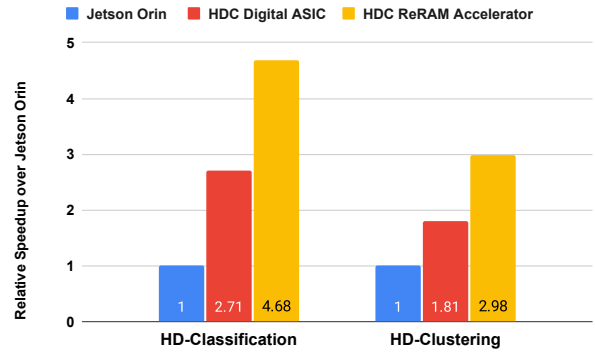

Figure 6: Performance of applications written in HDC++ and compiled with HPVM-HDC for execution on the HDC Digital ASIC and the HDC ReRAM Accelerator simulator, compared against the same code executed on an NVIDIA Jetson Orin board, higher is better.

performance insights. Across the GPU compiled HPVM-HDC applications for which the reference implementation is in comparable CUDA-C++, we observe the largest performance improvements in HD-Classification with an relative improvement of 1.5x. For these 4 benchmarks, HPVM-HDC achieves a geomean 1.17x relative speedup. When including the HD-HashTable GPU performance for HPVM-HDC, we achieve a geomean speedup of 1.5x.

Performance on HDC Accelerators. Figure 6 compares the performance of HD-Classification and HD-Clustering when compiling HDC++ applications for the HDC accelerators and for an NVIDIA Jetson AGX Orin board. Due to fabrication cost constraints, the digital ASIC and its ARM host CPU only communicate at approximately 10 kbps. Additionally, the ReRAM simulator only models the performance of the ReRAM accelerator, and not of a system containing the accelerator and a host. Thus, we measure the “device-only” performance for the accelerators and the Jetson Orin, which corresponds to just the HDC primitive code in the applications.

We compare running HD-Classification and HD-Clustering on HDC accelerators against running on an NVIDIA Jetson AGX Orin board, since there is no baseline implementation targeting the accelerators for comparison—no prior work has run a whole HDC application on either of these accelerators. Additionally, while these accelerators were designed for classification [64, 65], we can accelerate the computationally intensive portions of HD-Clustering by using stage-based HDC++ primitives. The NVIDIA Jetson AGX

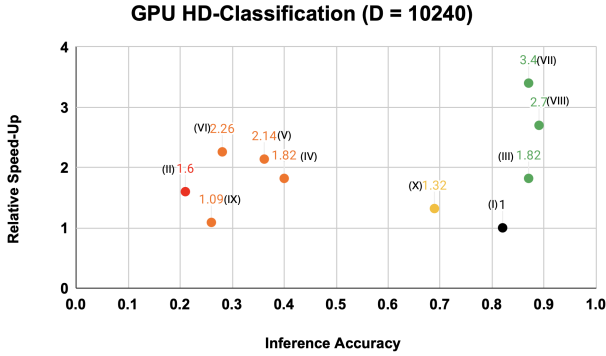

Figure 7: Speedup versus accuracy for HD-Classification inference on the GPU. The black point represents the baseline configuration. All approximation configurations achieve improved performance. Green points denote configurations maintaining high accuracy. Yellow points denote configurations with moderate accuracy loss and red points denote configurations with significant accuracy loss.

Orin board is representative of GPU-based compute available in edge environments—the HDC accelerators are also designed for use at the edge. We see that the accelerators deliver speed-ups for both HD-Classification and HD-Clustering compared against execution on a GPU-based system. The larger speedup in the case of HD-Classification is because this application spends most of its time training a set of representative hypervectors per class, which the HDC devices are specifically designed to accelerate. The ReRAM accelerator is estimated to be faster than the digital ASIC because the underlying processing-in-memory technology, resistive RAM, provides high density on-chip storage with fast read speeds.

5.3 Impact of HDC optimizations

To evaluate the effectiveness of domain specific optimizations in HPVM-HDC, we compile the inference stage of HD-Classification with different optimization settings (Table 3). Note that these optimizations are designed to exploit the error resilience in the HDC paradigm, and thus affect not only performance but also classification accuracy. HD-Classification in particular uses label data to assess the accuracy of a classifier, so it is straight-forward to measure the end-to-end effect of approximating inference. Through the HDC++ programming model and parameterized HDC transformations in HPVM-HDC, application developers can rapidly explore different approximation configurations in their applications with minimal source code changes (1-2 lines of code).

For this evaluation, we set the encoding dimension to 10240 and derived the trained class hypervectors using cosine similarity in a single pass over the training dataset offline. Figure 7 plots the relative speed-up versus inference accuracy for different optimization settings described in Table 3. These configurations are not meant to be exhaustive but merely illustrative of points in the various stages (e.g. encoding and/ or similarity) in an HDC application which can be approximated. The baseline (I) achieves an inference accuracy of 0.82. While all optimization settings achieve a significant performance improvement, the inference accuracy varies drastically

ranging from a low of 0.2 to a high of 0.89. The points in green (III, VII, VIII) result in improved accuracy over the baseline, as well as faster performance. When using the binarization approximation, i.e., projecting the floating point values in the class hypervectors to $\{+1, -1\}$, which are represented using 1-bit elements, and using Hamming distance similarity measure, we observe a negligible change in accuracy. This aligns with observations in [23] regarding the effects of binarized learning on accuracy. Additionally, this reduces the initial data movement necessary as the class hypervectors are represented using fewer bits in total. Reduction perforation adds upon the performance improvements achieved from automatic binarization. However, the downstream effect on accuracy varies significantly depending on which operation is being perforated. Configurations (VII, VIII, X) perforate the inference’s similarity computation and result in at most an approximately 10% drop in accuracy with respect to the baseline in X and no drop in the other two. However, when perforating the encoding stages (V, VI, IX), the inference accuracy drops to 25-35%. This implies that for HD classification, the similarity computation is much more amenable to approximation than the encoding stage.

5.4 Programmability

Source code portability: HPVM-HDC can compile a single HDC++ source program to multiple hardware targets, *with no target-specific tuning or customization*. This is a valuable benefit because adoption of custom hardware accelerators for real-world applications will be far more practical if the applications do not have to be rewritten for each hardware target: in fact, we believe this is a crucial requirement for enabling success for custom hardware, as shown by the widespread success of custom accelerators for machine learning which has been strongly enabled by hardware-independent programming frameworks like PyTorch [45] and TensorFlow [4].

Lines of Code: The high-level HDC operations in HDC++ also enable more concise code. We compare the lines of code required to implement the applications with their respective baselines. Note that for each target architecture, there is a different baseline version, often implemented in a different programming language. Table 4 describes the total lines of code reduction in HDC++ versus the baselines for the applications. HDC++ provides a 1.6x geometric reduction in total lines of code (by combining the lines of codes across all baseline target implementations) for HDC applications while remaining retargetable. For the CPU baselines (except for HyperOMS where no baseline exists) which are implemented in Python, the HDC++ application codes are larger. This is a consequence of HDC++ being embedded in C++ which is inherently more verbose than Python. For the CUDA baselines however, HDC++ code is more compact; HDC++ abstracts away any data-movement and allocation between the device and host-memory. Further, the high-level HDC++ primitives compactly represent the corresponding manually written kernel functions in the GPU baselines, resulting in fewer lines of code. Note that not all baselines provide implementations for all targets. In contrast, HPVM-HDC can compile a single HDC++ application to multiple targets.

Approximation Configuration: The HDC++ programming interface and HPVM-HDC compiler make it easy to fine-tune HDC applications for performance and accuracy because the approximation

ID	Optimization Setting	Required LOC changes	Description
I	Cosine Similarity (Baseline)	0	Inference using 32-bit floats with cosine similarity
II	Hamming Distance	1	Inference using 32-bit floats with Hamming Distance
III	Auto Binarize (Enc + Out)	1	Binarization of Class & Encoded HVs with Hamming Distance
IV	Auto Binarize (Enc + In/Out)	1	III with casting input features to 32-bit Ints before encoding
V	Auto Binarize (Enc + Out + Strided Matmul [2])	2	III with loop perforated matrix multiplication with stride of 2
VI	Auto Binarize (Enc + Out + Strided Matmul [4])	2	III with loop perforated matrix multiplication with stride of 4
VII	Auto Binarize (Enc + Out + Strided Hamming [2])	3	III with loop perforated Hamming Distance with stride of 2
VIII	Auto Binarize (Enc + Out + First Half Hamming)	3	III with Hamming Distance only on first half of hypervectors
IX	Cosine Similarity (Strided Encoding [2])	1	I with encoding loop perforated with stride 2
X	Cosine Similarity (Strided Similarity [2])	1	I with cosine similarity loop perforated with stride 2

Table 3: Descriptions of optimization settings compiled using HPVM-HDC for HD-Classification Inference.

Application	CPU		GPU		HDC++ LOC
	Baseline Lang.	LOC	Baseline Lang.	LOC	
HD-Classification	Python	193 (0.47x)	CUDA	608 (1.48x)	410
HD-Clustering	Python	426 (1.24x)	CUDA	429 (1.25x)	343
HyperOMS	N/A		CUDA	1188 (2.12x)	560
RelHD	Python	740 (1.15x)	CUDA	457 (0.71x)	642
HD-Hashtable	Python	164 (0.58x)	Python (CuPy)	164 (0.58x)	283

Table 4: Lines of code to express each application for each target device. The CPU and GPU counts correspond to separate baseline programs (except for HD-Hashtable, where both versions use the same Python code), while the HDC++ count corresponds to a single implementation targeting CPUs, GPUs, and HDC accelerators. Reduction factors between the baselines and HDC++ are shown in parentheses, higher is better.

configuration can be separately specified with almost no changes to the application source code. This includes experimenting with different similarity metrics, encoding strategies, and transformations implemented in HPVM-HDC evaluated in Section 5.3. To evaluate the improved programmability of approximations in HDC++, we manually implemented three of the automatic transformations described in Table 3 in the GPU baseline code for HD-Classification. For configuration X, only 4 lines of code needed to be modified. Implementing II required 25 lines of code and approximately 30 minutes of work. Finally, implementing III required the most source code modifications—this configuration requires modifying the allocations of the class hypermatrix and encoded hypervectors, implementing packing elements to 1-bit, and implementing Hamming distance on 1-bit elements. 33 lines of code were written requiring approximately 1 hour. In contrast, HPVM-HDC enables exploring these transformations within seconds by modifying 1-2 lines of the application code. Furthermore, these transformations occur at the HPVM-HDC IR representation, allowing for CPU and GPU implementations of the approximations to be automatically generated, whereas the manual modifications are specific to the GPU baseline.

6 Related Work

Languages for HDC. Because Python [58] and MATLAB [37] enable fast prototyping, these languages are used to implement the majority of experimental research HDC algorithms and libraries [59]. Some HDC algorithms are also implemented in C++. HDC algorithms are expressed in these languages as sequential scalar code or using array processing libraries such as NumPy. These languages can be used to target GPUs using language extensions [16, 42, 57]. HDC algorithms are also written in CUDA [54] and OpenCL [41] for GPUs [26, 34], and using C++ with FPGA-specific extensions to

target FPGAs [24, 52]. However, no HDC-specific heterogeneous language or extensions to existing languages exist yet in the literature.

Libraries for HDC. Work on libraries for HDC is relatively extensive. TorchHD [19] is a library implemented using PyTorch [44] and provides interfaces for implementing HDC algorithms on CPUs and GPUs. OpenHD [30] is a library implemented in Python with CUDA extensions to facilitate implementation of HD Classification and Clustering for GPUs. HDTorch [56] is another library implemented in Python with CUDA extensions for hypervector operations for classical and online HDC learning. None of these libraries support nor can be easily extended to target HDC accelerators.

Compilers for HDC. The HDCC compiler [59] is the first and, to date, the only compiler developed for HDC. The primary limitation of HDCC is that it does not support heterogeneous compilation: it only supports one back end that generates C code with POSIX [60] and vector extensions for multi-core CPUs from high-level descriptions of HDC algorithms. Unlike HPVM-HDC, it does not target other hardware architectures, which present more lucrative performance and energy efficiency trade-offs.

Compilers for Deep Learning. Work on compilers for deep learning is extensive [9, 36, 50, 51]. These compilers operate on high-level descriptions of deep learning models, often defined in high-level frameworks such as Tensorflow [4] and PyTorch [45]. Programming HDC algorithms requires tweaking and exploring different algorithmic and approximation choices which can only be facilitated by allowing programmers to express custom algorithms in addition to providing pre-ordained high-level HDC abstractions. This flexibility, however, is not afforded by deep learning frameworks. Moreover, deep learning models are compiled to computational dataflow graphs in XLA [2]; this representation does not

adequately capture all forms of parallelism, unlike HPVM-HDC IR which supports a hierarchical dataflow representation that represents parallelism at different levels of the hierarchy.

7 Conclusion

This paper presents the first heterogeneous programming system for HDC. We introduce a novel programming language, HDC++, for writing HDC applications using a unified programming model with HDC-specific primitives. We also introduce a heterogeneous compiler, HPVM-HDC, that provides a retargetable intermediate representation for compiling HDC programs to many hardware targets. We demonstrate the implementation and evaluate the benefits of two HDC-specific software optimizations that balance end-to-end quality of service and performance. HPVM-HDC achieves better performance than baseline HDC applications on CPUs and GPUs with less engineering effort. Our programming system enables for the first time running HDC applications on two HDC accelerators. HDC++ and HPVM-HDC enable simultaneous and decoupled development of HDC applications and accelerators, allowing for faster development and adoption of both. We anticipate that HPVM-HDC will be straightforward to extend for future developments in HDC accelerators—for example, some proposed devices support hardware-based tuning parameters [15] that HPVM-HDC could support in addition to its software-based optimizations.

References

- [1] [n. d.]. cuBLAS : CUDA Toolkit Documentation. <https://docs.nvidia.com/cuda/archive/10.2/cublas/index.html>. Accessed: 2024-04-16.
- [2] [n. d.]. Operation semantics. https://openxla.org/xla/operation_semantics.
- [3] [n. d.]. Thrust: The C++ Parallel Algorithms Library. <https://nvidia.github.io/ccl/thrust/>. Accessed: 2024-11-15.
- [4] Martín Abadi, Paul Barham, Jianmin Chen, Zhifeng Chen, Andy Davis, Jeffrey Dean, Matthieu Devin, Sanjay Ghemawat, Geoffrey Irving, Michael Isard, Manjunath Kudlur, Josh Levenberg, Rajat Monga, Sherry Moore, Derek G. Murray, Benoit Steiner, Paul Tucker, Vijay Vasudevan, Pete Warden, Martin Wicke, Yuan Yu, and Xiaoqiang Zheng. 2016. TensorFlow: a system for large-scale machine learning. In *Proceedings of the 12th USENIX Conference on Operating Systems Design and Implementation (Savannah, GA, USA) (OSDI'16)*. USENIX Association, USA, 265–283.
- [5] Fatemeh Asgarinejad, Anthony Thomas, and Tajana Rosing. 2020. Detection of epileptic seizures from surface eeg using hyperdimensional computing. In *2020 42nd Annual International Conference of the IEEE Engineering in Medicine & Biology Society (EMBC)*. IEEE, 536–540.
- [6] Anton Bankevich, Andrey V Bzikadze, Mikhail Kolmogorov, Dmitry Antipov, and Pavel A Pevzner. 2022. Multiple de Bruijn graphs enable genome assembly from long, high-fidelity reads. *Nat. Biotechnol.* 40, 7 (July 2022), 1075–1081.
- [7] Robert J. Chalkley, Nuno Bandeira, Matthew C. Chambers, Karl R. Clauser, John S. Cottrell, Eric W. Deutsch, Eugene A. Kapp, Henry H.N. Lam, W. Hayes McDonald, Thomas A. Neubert, and Rui-Xiang Sun. 2014. Proteome Informatics Research Group (iPRG)_2012: A Study on Detecting Modified Peptides in a Complex Mixture*. *Molecular & Cellular Proteomics* 13, 1 (2014), 360–371.
- [8] En-Jui Chang, Abbas Rahimi, Luca Benini, and An-Yeu Andy Wu. 2019. Hyperdimensional computing-based multimodality emotion recognition with physiological signals. In *2019 IEEE International Conference on Artificial Intelligence Circuits and Systems (AICAS)*. IEEE, 137–141.
- [9] Tianqi Chen, Thierry Moreau, Ziheng Jiang, Lianmin Zheng, Eddie Yan, Meghan Cowan, Haichen Shen, Leyuan Wang, Yuwei Hu, Luis Ceze, Carlos Guestrin, and Arvind Krishnamurthy. 2018. TVM: an automated end-to-end optimizing compiler for deep learning. In *Proceedings of the 13th USENIX Conference on Operating Systems Design and Implementation (Carlsbad, CA, USA) (OSDI'18)*. USENIX Association, USA, 579–594.
- [10] Ron Cole and Mark Fanty. 1994. ISOLET. UCI Machine Learning Repository. DOI: <https://doi.org/10.24432/C51G69>.
- [11] Sohum Datta, Ryan AG Antonio, Aldrin RS Ison, and Jan M Rabaey. 2019. A programmable hyper-dimensional processor architecture for human-centric IoT. *IEEE Journal on Emerging and Selected Topics in Circuits and Systems* 9, 3 (2019), 439–452.
- [12] Arpan Dutta, Saransh Gupta, Behnam Khaleghi, Rishikanth Chandrasekaran, Weihong Xu, and Tajana Rosing. 2022. HDnn-PIM: Efficient in Memory Design of Hyperdimensional Computing with Feature Extraction. In *Proceedings of the Great Lakes Symposium on VLSI 2022 (Irvine, CA, USA) (GLSVLSI '22)*. Association for Computing Machinery, New York, NY, USA, 281–286. <https://doi.org/10.1145/3526241.3530331>
- [13] Adel Ejeh, Aaron Councilman, Akash Kothari, Maria Kotsifakou, Leon Medvinsky, Abdul Rafae Noor, Hashim Sharif, Yifan Zhao, Sarita Adve, Sasa Misailovic, et al. 2022. HPVM: Hardware-Agnostic Programming for Heterogeneous Parallel Systems. *IEEE Micro* 42, 5 (2022), 108–117.
- [14] Keming Fan, Wei-Chen Chen, Sumukh Pinge, H.-S. Philip Wong, and Tajana Rosing. 2024. Efficient Open Modification Spectral Library Searching in High-Dimensional Space with Multi-Level-Cell Memory. In *Proceedings of the 61st ACM/IEEE Design Automation Conference (San Francisco, CA, USA) (DAC '24)*. Association for Computing Machinery, New York, NY, USA, Article 316, 6 pages. <https://doi.org/10.1145/3649329.3657341>
- [15] Keming Fan, Ashkan Moradifrouzabadi, Xiangjin Wu, Zheyu Li, Flavio Ponzina, Anton Persson, Eric Pop, Tajana Rosing, and Mingyu Kang. 2024. SpecPCM: A Low-power PCM-based In-Memory Computing Accelerator for Full-stack Mass Spectrometry Analysis. *IEEE Journal on Exploratory Solid-State Computational Devices and Circuits* (2024), 1–1. <https://doi.org/10.1109/JXCDC.2024.3498837>
- [16] Massimiliano Fatica and Won-Ki Jeong. 2007. Accelerating matlab with cuda. In *Proc. of the High Performance Embedded Comput. Workshop*. Citeseer, 18–20.
- [17] Yunhui Guo, Mohsen Imani, Jaeyoung Kang, Sahand Salamat, Justin Morris, Baris Aksanli, Yeseong Kim, and Tajana Rosing. 2021. Hyperrec: Efficient recommender systems with hyperdimensional computing. In *Proceedings of the 26th Asia and South Pacific Design Automation Conference*. 384–389.
- [18] Saransh Gupta, Mohsen Imani, and Tajana Rosing. 2018. Felix: Fast and energy-efficient logic in memory. In *2018 IEEE/ACM International Conference on Computer-Aided Design (ICCAD)*. IEEE, 1–7.
- [19] Mike Heddes, Igor Nunes, Pere Vergés, Dheyay Desai, Tony Givargis, and Alexandru Nicolau. 2022. Torchhd: An open-source python library to support hyperdimensional computing research. *arXiv preprint arXiv:2205.09208* (2022).
- [20] Mohsen Imani, Yeseong Kim, Thomas Worley, Saransh Gupta, and Tajana Rosing. 2019. HDcluster: An Accurate Clustering Using Brain-Inspired High-Dimensional Computing. In *2019 Design, Automation & Test in Europe Conference & Exhibition (DATE)*. 1591–1594. <https://doi.org/10.23919/DATE.2019.8715147>
- [21] Mohsen Imani, Deqian Kong, Abbas Rahimi, and Tajana Rosing. 2017. Voicehd: Hyperdimensional computing for efficient speech recognition. In *2017 IEEE international conference on rebooting computing (ICRC)*. IEEE, 1–8.
- [22] Mohsen Imani, John Messerly, Fan Wu, Wang Pi, and Tajana Rosing. 2019. A binary learning framework for hyperdimensional computing. In *2019 Design, Automation & Test in Europe Conference & Exhibition (DATE)*. IEEE, 126–131.
- [23] Mohsen Imani, John Messerly, Fan Wu, Wang Pi, and Tajana Rosing. 2019. A Binary Learning Framework for Hyperdimensional Computing. In *2019 Design, Automation & Test in Europe Conference & Exhibition (DATE)*. 126–131. <https://doi.org/10.23919/DATE.2019.8714821>
- [24] Mohsen Imani, Sahand Salamat, Saransh Gupta, Jiani Huang, and Tajana Rosing. 2019. Fach: Fpga-based acceleration of hyperdimensional computing by reducing computational complexity. In *Proceedings of the 24th Asia and South Pacific Design Automation Conference*. 493–498.
- [25] Mohsen Imani, Zhuowen Zou, Samuel Bosch, Sanjay Anantha Rao, Sahand Salamat, Venkatesh Kumar, Yeseong Kim, and Tajana Rosing. 2021. Revisiting hyperdimensional learning for fpga and low-power architectures. In *2021 IEEE International Symposium on High-Performance Computer Architecture (HPCA)*. IEEE, 221–234.
- [26] Zheming Jin and Hal Finkel. 2019. Accelerating hyperdimensional classifier on multiple gpus. In *2019 IEEE International Conference on Cluster Computing (CLUSTER)*. IEEE, 1–2.
- [27] Derek Jones, Jonathan E. Allen, Xiaohua Zhang, Behnam Khaleghi, Jaeyoung Kang, Weihong Xu, Niema Moshiri, and Tajana S. Rosing. 2023. HD-Bind: Encoding of Molecular Structure with Low Precision, Hyperdimensional Binary Representations. *arXiv:2303.15604* [q-bio.BM]
- [28] Pentti Kanerva. 2009. Hyperdimensional computing: An introduction to computing in distributed representation with high-dimensional random vectors. *Cognitive computation* 1 (2009), 139–159.
- [29] Jaeyoung Kang, Behnam Khaleghi, Yeseong Kim, and Tajana Rosing. 2022. Xcelhd: An efficient gpu-powered hyperdimensional computing with parallelized training. In *2022 27th Asia and South Pacific Design Automation Conference (ASP-DAC)*. IEEE, 220–225.
- [30] Jaeyoung Kang, Behnam Khaleghi, Tajana Rosing, and Yeseong Kim. 2022. Openhd: A gpu-powered framework for hyperdimensional computing. *IEEE Trans. Comput.* 71, 11 (2022), 2753–2765.
- [31] Jaeyoung Kang, Weihong Xu, Wout Bittremieux, and Tajana Rosing. 2022. Massively Parallel Open Modification Spectral Library Searching with Hyperdimensional Computing. *arXiv:2211.16422* [cs.DC]
- [32] Jaeyoung Kang, Minxuan Zhou, Abhinav Bhansali, Weihong Xu, Anthony Thomas, and Tajana Rosing. 2022. RelHD: A Graph-based Learning on FeFET with

- Hyperdimensional Computing. In *2022 IEEE 40th International Conference on Computer Design (ICCD)*, 553–560. <https://doi.org/10.1109/ICCD56317.2022.00087>
- [33] Behnam Khaleghi, Hanyang Xu, Justin Morris, and Tajana Rosing. 2021. tiny-HD: Ultra-Efficient Hyperdimensional Computing Engine for IoT Applications. In *2021 Design, Automation & Test in Europe Conference & Exhibition (DATE)*, 408–413. <https://doi.org/10.23919/DAT51398.2021.9473920>
- [34] Yeseong Kim, Mohsen Imani, Niema Moshiri, and Tajana Rosing. 2020. Geniehd: Efficient dna pattern matching accelerator using hyperdimensional computing. In *2020 Design, Automation & Test in Europe Conference & Exhibition (DATE)*, IEEE, 115–120.
- [35] Maria Kotsifakou, Prakash Srivastava, Matthew D Sinclair, Rakesh Komuravelli, Vikram Adve, and Sarita Adve. 2018. Hpvmm: Heterogeneous parallel virtual machine. In *Proceedings of the 23rd ACM SIGPLAN Symposium on Principles and Practice of Parallel Programming*, 68–80.
- [36] Mingzhen Li, Yi Liu, Xiaoyan Liu, Qingxiao Sun, Xin You, Hailong Yang, Zhongzhi Luan, Lin Gan, Guangwen Yang, and Depei Qian. 2021. The Deep Learning Compiler: A Comprehensive Survey. *IEEE Transactions on Parallel and Distributed Systems* 32, 3 (2021), 708–727. <https://doi.org/10.1109/TPDS.2020.3030548>
- [37] Starting Matlab. 2012. Matlab. *The MathWorks, Natick, MA* (2012).
- [38] A.K. McCallum. 2000. Automating the construction of internet portals with machine learning. *Information Retrieval* 3 (01 2000), 127–163.
- [39] Anton Mitrokhin, P Sutor, Cornelia Fermüller, and Yiannis Aloimonos. 2019. Learning sensorimotor control with neuromorphic sensors: Toward hyperdimensional active perception. *Science Robotics* 4, 30 (2019), eaaw6736.
- [40] Justin Morris, Mohsen Imani, Samuel Bosch, Anthony Thomas, Helen Shu, and Tajana Rosing. 2019. CompHD: Efficient hyperdimensional computing using model compression. In *2019 IEEE/ACM International Symposium on Low Power Electronics and Design (ISLPED)*, IEEE, 1–6.
- [41] Aaftab Munshi. 2009. The opencl specification. In *2009 IEEE Hot Chips 21 Symposium (HCS)*, IEEE, 1–314.
- [42] Raúl Nozal and Jose Luis Bosque. 2021. Exploiting co-execution with oneAPI: heterogeneity from a modern perspective. In *Euro-Par 2021: Parallel Processing: 27th International Conference on Parallel and Distributed Computing, Lisbon, Portugal, September 1–3, 2021, Proceedings 27*. Springer, 501–516.
- [43] Igor Nunes, Mike Heddes, Tony Givargis, Alexandru Nicolau, and Alex Veidenbaum. 2022. GraphHD: Efficient graph classification using hyperdimensional computing. In *2022 Design, Automation & Test in Europe Conference & Exhibition (DATE)*, IEEE, 1485–1490.
- [44] Adam Paszke, Sam Gross, Francisco Massa, Adam Lerer, James Bradbury, Gregory Chanan, Trevor Killeen, Zeming Lin, Natalia Gimelshein, Luca Antiga, et al. 2019. Pytorch: An imperative style, high-performance deep learning library. *Advances in neural information processing systems* 32 (2019).
- [45] Adam Paszke, Sam Gross, Francisco Massa, Adam Lerer, James Bradbury, Gregory Chanan, Trevor Killeen, Zeming Lin, Natalia Gimelshein, Luca Antiga, Alban Desmaison, Andreas Köpf, Edward Yang, Zach DeVito, Martin Raison, Alykhan Tejani, Sasank Chilamkurthy, Benoit Steiner, Lu Fang, Junjie Bai, and Soumith Chintala. 2019. *PyTorch: an imperative style, high-performance deep learning library*. Curran Associates Inc., Red Hook, NY, USA.
- [46] Sumukh Pingre, Weihong Xu, Wout Bittremieux, Niema Moshiri, Sang-Woo Jun, and Tajana Rosing. 2024. RapidOMS: FPGA-based Open Modification Spectral Library Searching with HD Computing. In *Proceedings of the 2024 IEEE Biomedical Circuits and Systems Conference (BIOCAS)*.
- [47] Sumukh Pingre, Weihong Xu, Jaeyoung Kang, Tianqi Zhang, Neima Moshiri, Wout Bittremieux, and Tajana Rosing. 2023. SpecHD: Hyperdimensional Computing Framework for FPGA-based Mass Spectrometry Clustering. [arXiv:2311.12874](https://arxiv.org/abs/2311.12874) [q-bio.QM]
- [48] Abbas Rahimi, Simone Benatti, Pentti Kanerva, Luca Benini, and Jan M Rabaey. 2016. Hyperdimensional biosignal processing: A case study for EMG-based hand gesture recognition. In *2016 IEEE International Conference on Rebooting Computing (ICRC)*, IEEE, 1–8.
- [49] Abbas Rahimi, Pentti Kanerva, and Jan M Rabaey. 2016. A robust and energy-efficient classifier using brain-inspired hyperdimensional computing. In *Proceedings of the 2016 international symposium on low power electronics and design*, 64–69.
- [50] Nadav Rotem, Jordan Fix, Saleem Abdulrasool, Summer Deng, Roman Dzhabarov, James Hegeman, Roman Levenstein, Bertrand A. Maher, Nadathur Satish, Jakob R. Olesen, Jongsoo Park, Artem Rakhov, and Mikhail Smelyanskiy. 2018. Glow: Graph Lowering Compiler Techniques for Neural Networks. *ArXiv abs/1805.00907* (2018). <https://api.semanticscholar.org/CorpusID:23823854>
- [51] Amit Sabne. 2020. XLA : Compiling Machine Learning for Peak Performance.
- [52] Sahand Salamat, Mohsen Imani, Behnam Khaleghi, and Tajana Rosing. 2019. F5-hd: Fast flexible fpga-based framework for refreshing hyperdimensional computing. In *Proceedings of the 2019 ACM/SIGDA International Symposium on Field-Programmable Gate Arrays*, 53–62.
- [53] Sahand Salamat, Mohsen Imani, and Tajana Rosing. 2020. Accelerating hyperdimensional computing on fpgas by exploiting computational reuse. *IEEE Trans. Comput.* 69, 8 (2020), 1159–1171.
- [54] Jason Sanders and Edward Kandrot. 2010. *CUDA by example: an introduction to general-purpose GPU programming*. Addison-Wesley Professional.
- [55] Stelios Sidiropoulos-Douskos, Sasa Misailovic, Henry Hoffmann, and Martin Rinard. 2011. Managing performance vs. accuracy trade-offs with loop perforation. In *Proceedings of the 19th ACM SIGSOFT Symposium and the 13th European Conference on Foundations of Software Engineering (Szeged, Hungary) (ESEC/FSE '11)*. Association for Computing Machinery, New York, NY, USA, 124–134. <https://doi.org/10.1145/2025113.2025133>
- [56] William Andrew Simon, Una Pale, Tomas Teijeiro, and David Atienza. 2022. HD Torch: Accelerating Hyperdimensional Computing with GP-GPUs for Design Space Exploration. In *Proceedings of the 41st IEEE/ACM International Conference on Computer-Aided Design*, 1–8.
- [57] Brian Tuomanen. 2018. *Hands-On GPU Programming with Python and CUDA: Explore high-performance parallel computing with CUDA*. Packt Publishing Ltd.
- [58] Guido Van Rossum, Fred L Drake, et al. 1995. *Python reference manual*. Vol. 111. Centrum voor Wiskunde en Informatica Amsterdam.
- [59] Pere Vergés, Mike Heddes, Igor Nunes, Tony Givargis, and Alexandru Nicolau. 2023. HDCC: A Hyperdimensional Computing compiler for classification on embedded systems and high-performance computing. *arXiv preprint arXiv:2304.12398* (2023).
- [60] Stephen R Walli. 1995. The POSIX family of standards. *StandardView* 3, 1 (1995), 11–17.
- [61] Mingxun Wang, Jian Wang, Jeremy Carver, Benjamin S. Pullman, Seong Won Cha, and Nuno Bandeira. 2018. Assembling the Community-Scale Discoverable Human Proteome. *Cell Systems* 7, 4 (2018), 412–421.e5.
- [62] Weihong Xu, Po-Kai Hsu, Niema Moshiri, Shimeng Yu, and Tajana Rosing. 2024. HyperGen: Compact and Efficient Genome Sketching using Hyperdimensional Vectors. (March 2024). <https://doi.org/10.1101/2024.03.05.583605>
- [63] Weihong Xu, Jaeyoung Kang, Wout Bittremieux, Niema Moshiri, and Tajana Rosing. 2023. HyperSpec: Ultrafast Mass Spectra Clustering in Hyperdimensional Space. *Journal of Proteome Research* 22, 6 (May 2023), 1639–1648. <https://doi.org/10.1021/acs.jproteome.2c00612>
- [64] Weihong Xu, Jaeyoung Kang, and Tajana Rosing. 2023. FSL-HD: Accelerating Few-Shot Learning on ReRAM using Hyperdimensional Computing. In *2023 Design, Automation & Test in Europe Conference & Exhibition (DATE)*, 1–6. <https://doi.org/10.23919/DAT56975.2023.10136901>
- [65] Haichao Yang, Chang Eun Song, Weihong Xu, Behnam Khaleghi, Uday Mallappa, Monil Shah, Keming Fan, Mingu Kang, and Tajana Simunic. 2024. FSL-HDnn: A 5.7 TOPS/W End-to-end Few-shot Learning Classifier Accelerator with Feature Extraction and Hyperdimensional Computing. *2024 IEEE European Solid-State Electronics Research Conference (ESSERC)* (2024), 33–36. <https://api.semanticscholar.org/CorpusID:272694189>
- [66] Tianyang Yu, Bi Wu, Ke Chen, Gong Zhang, and Weiqiang Liu. 2023. Fully Learnable Hyperdimensional Computing Framework with Ultra-tiny Accelerator for Edge-side Applications. *IEEE Trans. Comput.* (2023).
- [67] Tianqi Zhang, Neha Prakriya, Sumukh Pingre, Jason Cong, and Tajana Rosing. 2024. SpectraFlux: Harnessing the Flow of Multi-FPGA in Mass Spectrometry Clustering. In *Proceedings of the 61st ACM/IEEE Design Automation Conference (San Francisco, CA, USA) (DAC '24)*. Association for Computing Machinery, New York, NY, USA, Article 56, 6 pages. <https://doi.org/10.1145/3649329.3657354>
- [68] Tinaqi Zhang, Sahand Salamat, Behnam Khaleghi, Justin Morris, Baris Aksanli, and Tajana Simunic Rosing. 2023. HD2FPGA: Automated Framework for Accelerating Hyperdimensional Computing on FPGAs. In *2023 24th International Symposium on Quality Electronic Design (ISQED)*, 1–9. <https://doi.org/10.1109/ISQED57927.2023.10129332>
- [69] Zhuowen Zou, Hanning Chen, Prathyush Poduval, Yeseong Kim, Mahdi Imani, Elaheh Sadredini, Rosario Cammarota, and Mohsen Imani. 2022. BioHD: an efficient genome sequence search platform using HyperDimensional memorization. In *Proceedings of the 49th Annual International Symposium on Computer Architecture (New York, New York) (ISCA '22)*. Association for Computing Machinery, New York, NY, USA, 656–669. <https://doi.org/10.1145/3470496.3527422>