

Multi-Source Hard and Soft Information Fusion Approach for Accurate Cryptocurrency Price Movement Prediction

Saeed Mohammadi Dashtaki, Mehdi Hosseini Chagahi, Behzad Moshiri (Senior Member, IEEE), Md. Jalil Piran (Senior Member, IEEE)

arXiv:2409.18895v1 [cs.LG] 27 Sep 2024

Abstract—One of the most important challenges in the financial and cryptocurrency field is accurately predicting cryptocurrency price trends. Leveraging artificial intelligence (AI) is beneficial in addressing this challenge. Cryptocurrency markets, marked by substantial growth and volatility, attract investors and scholars keen on deciphering and forecasting cryptocurrency price movements. The vast and diverse array of data available for such predictions increases the complexity of the task. In our study, we introduce a novel approach termed hard and soft information fusion (HSIF) to enhance the accuracy of cryptocurrency price movement forecasts. The hard information component of our approach encompasses historical price records alongside technical indicators. Complementing this, the soft data component extracts from X (formerly Twitter), encompassing news headlines and tweets about the cryptocurrency. To use this data, we use the Bidirectional Encoder Representations from Transformers (BERT)-based sentiment analysis method, financial BERT (FinBERT), which performs best. Finally, our model feeds on the information set including processed hard and soft data. We employ the bidirectional long short-term memory (BiLSTM) model because processing information in both forward and backward directions can capture long-term dependencies in sequential information. Our empirical findings emphasize the superiority of the HSIF approach over models dependent on single-source data by testing on Bitcoin-related data. By fusing hard and soft information on Bitcoin dataset, our model has about 96.8% accuracy in predicting price movement. Incorporating information enables our model to grasp the influence of social sentiment on price fluctuations, thereby supplementing the technical analysis-based predictions derived from hard information.

Index Terms—Cryptocurrency Prediction, Sentiment Analysis, Hard and Soft Information Fusion, Multi-Source Data.

I. INTRODUCTION

CRYPTOCURRENCY, emerged in the financial markets in recent years, earning a sizable following. The growth rate of cryptocurrencies was such that in early 2022 they reached the highest level and the total market value of nearly two trillion dollars [1], [2]. In 2008 Bitcoin system has been introduced which evolved into an open-source community and payment network [3]–[5]. Cryptocurrencies have grown

in number and variety over time. Bitcoin received increased attention and consideration because of its dominance in transaction volume and amount. The market share of bitcoin in early 2022 was approximately 40% [1]. As a decentralized cryptocurrency and payment system, Bitcoin relies on peer-to-peer transactions without any bureaucratic control. Cryptography secures network transactions and liquidity instead [3].

Due to the rapid evolution of the cryptocurrency market, investors and traders are increasingly seeking effective methods to forecast trends and make informed decisions. The increasing development of artificial intelligence (AI) has a significant impact on the financial market industry, so predicting price movements with new and updated methods has increased accuracy and improved performance of intelligent models [6]–[8]. Cryptocurrency markets are highly complex due to the myriad factors that affect their prices [9].

A substantial amount of research has been conducted on forecasting stock and cryptocurrency price movements using historical data and technical indicators, commonly referred to as quantitative indicators [10]–[12]. Additionally, financial news is an important source of information for investors because it has a direct impact on their attitudes and behaviors toward investing, which impacts prices directly [13]–[15]. We can produce quantitative polarity values for positive, neutral, and negative news sentiment analysis and human expert opinions using natural language processing (NLP) techniques. A number of these features can be used by AI models [16]–[18]. Hard data and soft data are two types of financial market data. There are hard and soft data: hard data are the quantitative data, such as historical data and indicators, and soft data are the qualitative data, such as data from X (Twitter), financial news, and investor opinion [6], [18], [19].

The subcategories of AI include machine learning (ML), deep learning (DL), and reinforcement learning (RL), which use algorithms to extract patterns from data [20]–[25]. We examined the effectiveness of traditional machine learning algorithms for predicting stock and cryptocurrency markets. The algorithms included logistic regression (LR), support vector machines (SVMs), random forest (RF), LightGBM, K-nearest neighbors (KNN), Gboosted trees, neural networks (NNs), LDA, XGBoost, QDA and multilayer perceptron (MLP), decision trees (DTs) [20], [26]. DL methods were also used to predict financial market trends, such as artificial neural networks (ANN), deep neural networks (DNN), convolutional neural

(Corresponding Authors: B. Moshiri and M. J. Piran)

S. M. Dashtaki and M. H. Chagahi are with the School of Electrical and Computer Engineering, College of Engineering, University of Tehran, Tehran, Iran, (e-mail: saeedmohammadi.d@ut.ac.ir; mhdi.hoseini@ut.ac.ir)

B. Moshiri is with the School of Electrical and Computer Engineering, College of Engineering, University of Tehran, Tehran, Iran and the Department of Electrical and Computer Engineering, University of Waterloo, Waterloo, Canada, (e-mail: moshiri@ut.ac.ir; bmoshiri@uwaterloo.ca)

M. J. Piran is with the Department of Computer Science and Engineering, Sejong University, Seoul 05006, South Korea, (e-mail: piran@sejong.ac.kr)

networks (CNN), recurrent neural networks (RNN), long short-term memories (LSTM), gated recurrent units (GRU) [20], [27], [28].

The concept of data fusion is the merging of data to obtain more reliable, accurate, and consistent information than the original raw data, which are often unreliable, uncertain, imprecise, inconsistent, and conflicting [29]. There is a difference between data fusion and information fusion. The term "data fusion" refers to data obtained directly from sensors without any processing. Information, on the other hand, refers to processed, organized, and interpreted data. When such processed information is used, the term "information fusion" is used [30].

The purpose of this study is to present a groundbreaking hard and soft information fusion (HSIF) model designed to predict cryptocurrency price movements. By processing information forward and backward, we are able to capture long-term dependencies in sequential information using a bidirectional long short-term memory (BiLSTM) model. The model is able to detect patterns and trends that may be missed by single-direction models because it understands the full temporal context of the information.

With the proposed HSIF model, investors are empowered to make informed decisions by forecasting the price movement of their cryptocurrency for the following trading day. When the model signals an "up" movement, investors can confidently choose to buy or hold the cryptocurrency. On the other hand, if a "down" movement is predicted, investors may choose not to buy or hold the cryptocurrency. The following is a summary of this work's contributions:

- We introduce a new model for cryptocurrency prediction based on a multi-source hard and soft information fusion, where the hard data includes quantitative data and indicators, while the soft data includes news and important cryptocurrency-related information.
- We use our dataset as both a comprehensive set of cryptocurrency news from X and a comprehensive set of hard data including various indicators.
- Through information fusion, the HSIF model's performance metrics are significantly improved, resulting in a more robust and reliable model.
- In terms of accuracy and area under the curve (AUC), our model achieves 96.8% accuracy and 99.6% AUC for Bitcoin trend prediction. The high accuracy and AUC demonstrate the effectiveness of our model.
- By integrating diverse information sources, our BiLSTM model is able to predict Bitcoin price movements better than LSTM-based methods.

The rest of this article is structured as follows. Section II introduces related work on cryptocurrency price trend prediction using the hard and soft information fusion. Section III explains the proposed HSIF model. Section IV presents our experimental setups and the simulation results and accompanying discussion. Future research directions are covered in Section V. Finally conclusions are drawn in Section VI.

TABLE I: List of symbols.

Notation	Description
O_t	The opening price of the cryptocurrency on day t .
C_t	The closing price of the cryptocurrency on day t .
N	The entire time period.
T	The time window before the movement prediction day.
h_t	The hard information on trading day t .
s_t	The soft information on trading day t .
H_t	The hard information on a T period on trading day t .
S_t	The soft information on a T period on trading day t .
x_t	The concatenated daily features in X on trading day t .
X	The hard and soft information on a T period.
EOM_t	The Ease of Movement indicator on trading day t .
y_t	The price movement label on trading day t .
\hat{y}_t	The predicted price movement label on trading day t .

II. RELATED WORK

As part of this section, we will review various research works and approaches that other researchers have used to predict cryptocurrency prices. Academic research and the financial industry have shown considerable interest in cryptocurrency price prediction. A prediction model's accuracy depends on the quality of its input data. In order for the model's results to be valid, it is crucial to select the most relevant and informative features.

Cryptocurrency price forecasting relied heavily on hard data, including daily price data and technical indicators (e.g., moving average (MA), relative strength index (RSI), moving average divergence (MACD), etc.) [27], [31]. The indicators show how cryptocurrency trading behaviors have changed over time and how they are structured.

By combining news with numerical indicators, NLP has led to studies that improve cryptocurrency forecasts using behavioral finance principles [32]–[34].

Financial news features were extracted using sentiment analysis to predict cryptocurrency prices in several studies [35]. Li et al. in [36], integrated quantitative metrics and sentiment-derived news features into their four ML classifiers which on the prediction of 10-day price movements. Azamjon et al. in [37], predicted Bitcoin trends using on-chain data and whale-alert tweets by employing a Q-learning algorithm. Zhong et al. in [12], forecasted cryptocurrency trends, leveraging a combination of historical trading patterns and sentiment analysis from social media by using LSTM and relationwise graph attention network (ReGAT). The findings showed that models that use financial sentiment dictionaries to analyze news sentiment consistently outperform models that rely solely on general sentiment dictionaries or only use technical indicators [38], [39]. Picasso et al. in [40], forecasted stock market trends by combining technical and fundamental analysis that indicators of technical analysis and the sentiment of news articles are both exploited as input. With the multi-source aggregated classification technique in [6], it predicted the price movement for several different Chinese stocks, and the effectiveness of this method, as well as news data and sentiment analysis, was investigated.

Numerous studies have attempted to predict cryptocurrency price movements, but single-source methods are less reliable than multi-source approaches. The results of multi-source

approaches are more reliable because they combine data from several sources. Studies that have attempted to predict cryptocurrency price movements using multi-source methods often used too few sources or relied on less comprehensive sources. This research utilizes comprehensive and complete resources, including meticulously selected hard and soft data. As a result of presenting this proposed approach, we demonstrate the effectiveness of our HSIF model.

III. OUR PROPOSED HSIF MODEL

Identifying valuable data related to cryptocurrency price fluctuations is the first step in predicting cryptocurrency price movements. Using historical trading data and social media data, we forecast cryptocurrency price movements based on existing research. In addition, we propose a new model that collects data from a wide variety of sources, such as hard and soft data sources, extracts information from these datasets, and finally fuses these data in an effort to predict cryptocurrency prices more accurately. Table I summarizes the symbols used in this research. Our goal is to forecast the cryptocurrency price movement on the next trading day (either upward or downward). Price movement can be described as follows.

$$y_{t+1} = \begin{cases} 1 & C_{t+1} > C_t, \\ 0 & \text{otherwise,} \end{cases} \quad (1)$$

where, the label y_{t+1} is the cryptocurrency price movement, where the value “1” indicates a positive movement and the value “0” indicates a negative movement. C_{t+1} represents the closing price of the cryptocurrency on the trading day $t + 1$, while C_t represents the closing price on the trading day t [6], [12].

Our proposed HSIF model consists of three separate components shown in Fig. 1. In Section III-A, first, we extract hard data for the cryptocurrency and after applying the required operations, we calculate the mentioned indicators and oscillators in the appendix for it in the time interval T (\mathbf{H}_t).

In Section III-B, at first, we extract soft data from X (former Twitter) for the cryptocurrency, and after applying the cleaning and the tokenizing an embedding generator is used to provide news features for the cryptocurrency over the same time interval T trading days (\mathbf{S}_t). This generator makes use of a FinBERT, a pre-trained sentiment classifier. We employ the aforementioned classifiers to acquire the embedding feature of each news headline. The news embeddings pertaining to a cryptocurrency on a given day are then averaged to derive the news representations of the cryptocurrency within the T trading days.

Lastly, in Section III-C, The multi-source information (\mathbf{H}_t and \mathbf{S}_t) are fused and fed into our proposed classifier to predict the cryptocurrency price trends on the following trading day (y_{t+1}). The next subsections go into further detail about the technical components. The names of features and selected indicators in this section are shown in Table II.

A. Hard Information

In predicting the price or trend of stocks and cryptocurrencies, hard or quantitative information, such as historical

TABLE II: Features and selected technical indicators

Feature	Description	Parameters
C	Closing Price	
H	Highest Price	
L	Lowest Price	
Vol	Volume of Trade	
O	Opening Price	
$MA(n)$	Moving Average	200
$ROC(n)$	Rate of Change	10, 30
$MOM(n)$	Momentum	10, 30
$RSI(n)$	Relative Strength Index	10, 30, 200
$STOK(n)$	Stochastic Oscillator %K	10, 14, 30, 200
$STOD(n)$	Stochastic Oscillator %D	10, 14
$ATR(n)$	Average True Range	14
$ADX(n)$	Average Directional Movement Index	14, 21
$tr1 / tr2 / tr3$	True Range	
$+DI_t(n)$	Positive Directional Indicator	14
$-DI_t(n)$	Negative Directional Indicator	14
$Aroon(n)$	Aroon Up/Aroon Down	21
BOP	Balance of Power	
$PPO(n_1, n_2)$	Percentage Price Oscillator	(12, 26)
$CMO(n)$	Chande Momentum Oscillator	14
$MFI(n)$	Money Flow Index	14
$MDI(n)$	Minus Directional Indicator	14
$PDI(n)$	Plus Directional Indicator	14
$MACD(n_1, n_2)$	Moving Average Convergence Divergence	(12, 26)
$MACD_Hist(n)$	MACD_Histogram	9
$CCI(n)$	Commodity Channel Index	20
$FI(n)$	Force Index	13
$EOM(n)$	Ease of Movement	14

data and technical indicators, is essential. This study carefully selects 53 features from this hard information, as indicated in previous studies. A detailed explanation of the indicators used is given in Section VI.

We use the yahoofinance¹ [41] platform as a credible source to acquire historical quantitative data on cryptocurrencies. This data collection procedure guarantees that we have access to correct and complete information for our study. The dataset that is extracted comprises closing prices, opening prices, high prices, low prices, and daily trading volumes, from which we derive precise hard information [19], [42]–[45]. Then we have a stage of choosing the appropriate features, in this stage, after calculating the correlation value, we remove the features that have more than 95% correlation, so the total number of hard features goes from 53 to 36. Table II lists their names and descriptions.

The hard information for a cryptocurrency on a specific trading day t is represented as

$$\mathbf{h}_t = [O_t, \dots, EOM_t], \quad (2)$$

where $\mathbf{h}_t \in \mathbb{R}^{1 \times 36}$ is a 36-dimensional vector. We collect hard information related to a specific cryptocurrency for N consecutive trading days to build a comprehensive dataset for study. In this case, the time span that comprises our training, evaluation, and testing data is shown by N . We use quantitative (hard) data collected from a subset of T (where $T \in N$) preceding trading days to learn the cryptocurrency price movement on the day $t + 1$ (y_{t+1}) during each training iteration.

¹<https://finance.yahoo.com/>

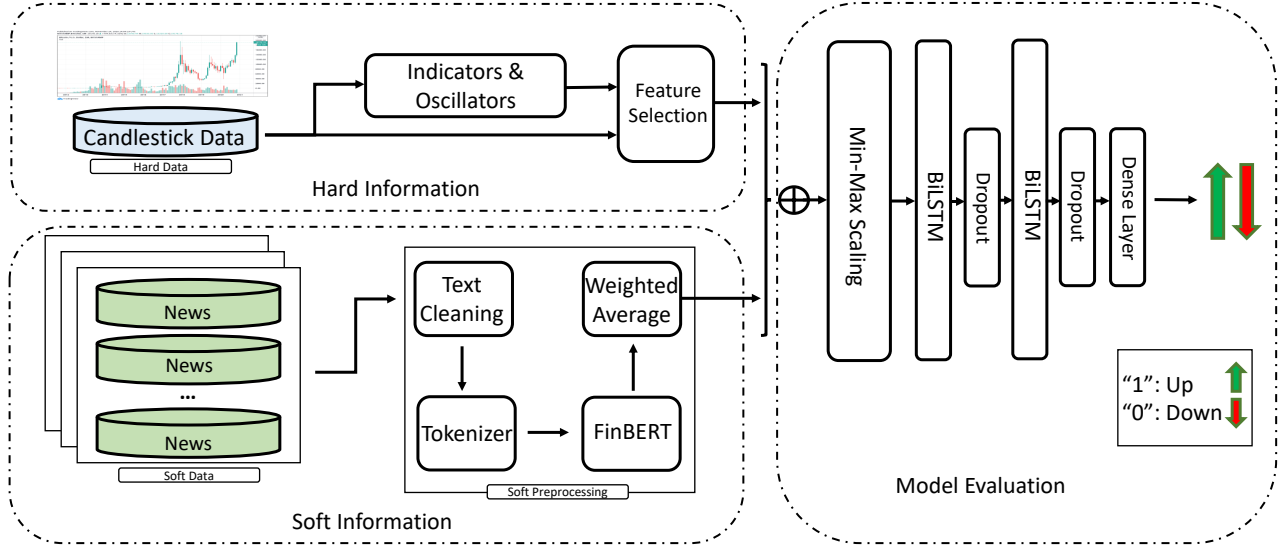

Fig. 1: Overview of the proposed HSIF framework.

This enables us to acquire crucial time series information. We purposefully ignore historical data from day 1 to ensure the accuracy of our forecasts regarding cryptocurrency price changes on day $t + 1$, as such ancient information may inject extra noise into the research.

As a result, the hard information included in the T window is described as follows.

$$\mathbf{H}_t = [h_{t-T+1}, \dots, h_{t-1}, h_t], \quad (3)$$

where $\mathbf{H} \in \mathbb{R}^{T \times 36}$ is the feature matrix for a specific cryptocurrency's hard information.

B. Soft Information

Investing behavior and decisions are significantly influenced by social media news and investor opinions. In order to stay informed about their investments and the financial markets, investors are using social media platforms more than ever before. Social media data can provide accurate news about cryptocurrencies, their future, or anything related to these markets. Investors' investment trends can also be reflected in them. The influence of social media on cryptocurrency price fluctuations has been demonstrated by many researchers who have utilized social media data to forecast cryptocurrency price movements [1], [46].

Therefore, we incorporate soft data into our analysis. Soft data includes news data from X^2 (formerly Twitter) data, which X is a very popular social network. Due to the diversity of expertise among users within this network, the veracity of individual opinions remains uncertain, making them unreliable. Our focus should be on outlets that specialize in

cryptocurrency news. As a result, we should choose pages that publish news instantly. Each page has a column of data, so we get their data as a time series.

Employing this approach, we construct the feature matrix by extracting tweets associated with relevant news headlines corresponding to the trading day t , after extracting financial news headlines pertinent to the cryptocurrency over the specified period.

For the sentiments extracted from people's usernames and page addresses not to affect the output extracted from the sentiments of the news data, we perform the data cleaning step, so that if there is a word in the news text that contains "@", it means that it is related to a user account, change it to "@user". Also if there is a word containing "http" in the text of the news, that is a link to an address, change it to "http".

Then, in the next step, after the tokenization step, three positive, neutral, and negative values are assigned to each tweet using RoBERTa [47] and FinBERT [48] models.

- RoBERTa: as an extension of BERT (Bidirectional Encoder Representations from Transformers), RoBERTa enhances the capabilities of transformer-based pre-training models. By leveraging embedding vector spaces, it delves deeper into contextual comprehension rather than merely analyzing word-by-word. Initially, BERT was designed to create pre-training bi-directional representations to extract context-specific information from the input. Its ability to comprehend text from both directions minimizes information loss. RoBERTa is a state-of-the-art BERT model which has been trained on 160GB of extra data, which has increased BERT's robustness and improved its performance [35], [47].
- FinBERT: FinBERT, an extension of the BERT archi-

²<https://twitter.com/>

ecture, is tailored for financial sentiment analysis and classification tasks. Trained on a diverse range of financial texts including news articles and earnings call transcripts, FinBERT capitalizes on BERT’s pretraining capabilities. However, it goes a step further by fine-tuning on financial data, enhancing its grasp of financial language nuances and sentiment expressions. The strength of FinBERT lies in its capacity to comprehend the intricacies of financial terminology and context. Through pretraining on financial data and subsequent fine-tuning for specific financial tasks, FinBERT delivers heightened accuracy in sentiment analysis and classification for financial text [48], [49].

Our dataset contains values obtained from both methods, and we train our models separately based on each. During this step, we also convert our soft information into numerical information. Since we have multiple tweets per day and our hard information is daily, we must aggregate this information on a daily basis after obtaining these three values for each tweet. Thus, daily tweet sentiment is calculated by averaging these three metrics. So finally, we have three positive, neutral, and negative values for each day, and we refer to them as S_t .

C. Hard and Soft Information Fusion for Model Evaluation

After collecting the hard and soft financial information, we get a whole set of processed information which are all numerical values. In the investigations we conducted, it seems that we have two categories of information: one containing information extracted from FinBERT and the other containing information extracted from RoBERTa. Therefore, our features are \mathbb{R}^{39} and we continue modeling with this new dataset. First, assuming T as the rolling window size, \mathbf{X} represents the concatenation of the hard information of a cryptocurrency called \mathbf{H}_t and the soft information of a cryptocurrency called \mathbf{S}_t . \mathbf{X} is the input of the model as follows

$$\mathbf{X} = [\mathbf{H}_t \oplus \mathbf{S}_t], \quad (4)$$

where $\mathbf{X} \in \mathbb{R}^{T \times 39}$ and \oplus denotes concatenation. The concatenated daily features in \mathbf{X} are $\mathbf{x}_{t-T+1}, \dots, \mathbf{x}_{t-1}, \mathbf{x}_t$, where $\mathbf{x}_t \in \mathbb{R}^{1 \times 39}$. Then, \mathbf{X} enters into a Min-Max scaling and then divides into three datasets including train, validation, and test with the ratios of 70%, 15%, and 15% respectively. Then it is fed into our models.

D. Suggested Bitcoin Trend Prediction Model

Our proposed model as shown in Fig. 2 uses two layers of BiLSTM to discover patterns to predict the movement of the cryptocurrency. The best advantage of using BiLSTM for predicting cryptocurrency price trends is its ability to capture long-term dependencies in sequential information by processing information in both forward and backward directions. This dual-context capability enables the model to understand the full temporal context of the information, recognizing patterns and trends that single-direction models might miss.

$$k_{t+1} = D(\text{BiLSTM}_2(D(\text{BiLSTM}_1(\mathbf{X})))), \quad (5)$$

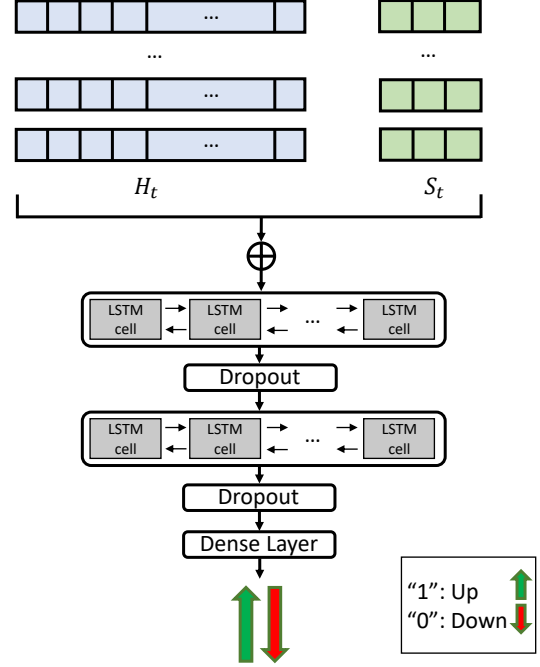

Fig. 2: The proposed model for final prediction of Cryptocurrency price movements.

where k_{t+1} is the forward and backward outputs of $\text{BiLSTM}_2(\cdot)$ with dropout ($D(\cdot)$) concatenated with their final hidden states. It is employed to forecast the movement of the price of the cryptocurrency on day $t + 1$. Finally, to forecast the probability of a movement label \hat{y}_{t+1} , k_{t+1} is fed into a *dense* layer and *softmax*.

$$\hat{y}_{t+1} = \text{Softmax}(\text{Dense}(k_{t+1})). \quad (6)$$

To update the neural network, we use Cross Entropy loss

$$\mathcal{L} = \text{CrossEntropy}(\hat{y}_{t+1}, y_{t+1}), \quad (7)$$

where y_{t+1} indicates the movement label of cryptocurrency price up or down, which is the same as upward and downward.

IV. EXPERIMENTS AND RESULTS

A. Datasets

Bitcoin, the world’s most valuable cryptocurrency, is used to test our model. A high level of comprehensive soft data is available for Bitcoin. Therefore, we extract both hard and soft data for Bitcoin.

All hard data is collected from Yahoofinance platform and extracted from them, finally, all hard information is available from April 6, 2015, to December 31, 2022.

We also collect our soft data from X platform [50]. To collect the soft data, we first downloaded all tweets of 12 pages that published news about Bitcoin. News about Bitcoin is reported on these pages in real-time. After the initial checks, 8 pages are selected and their data is used. Between April 6, 2015, and December 31, 2022, we collected 104296 news tweets about Bitcoin. Table III summarises the statistics of

TABLE III: Dataset statistics

Dataset	Start	End	News	Days	Up	Down
Train	04/06/2015	09/03/2020	33023	1978	1083	895
Validation	09/04/2020	11/01/2021	35797	424	235	189
Test	11/02/2021	12/31/2022	35476	425	198	227
All	04/06/2015	12/31/2022	104296	2827	1516	1311

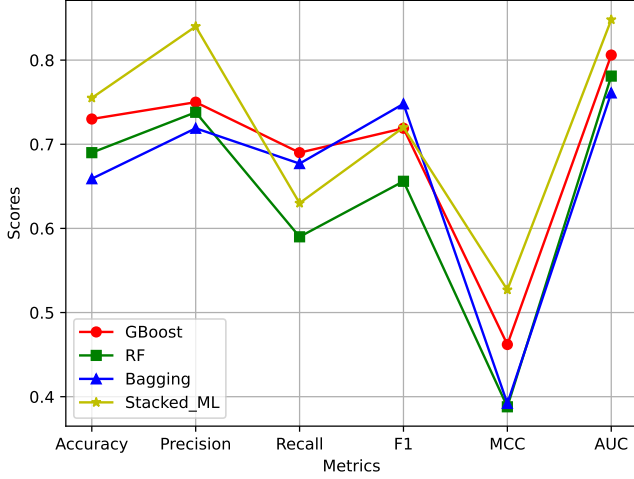

Fig. 3: Performance metrics results for machine learning models

training sets (70%), validation sets (15%), and testing sets (15%).

B. Baselines

We benchmark the proposed approach against baselines in order to evaluate its performance. The results produced by machine learning models are comparatively weaker than those produced by deep learning models at first. Improved results can be obtained by combining three machine learning models (GBoost, Random Forest, and bagging) [51], [52]. However, they perform poorly compared to DL models. Consequently, we solely report the outcomes derived from utilizing exclusively hard and soft information, with the soft information being refined through processing with the FinBERT model. The results are shown in Fig. 3.

For comparative analysis, we will utilize baseline DL models. This DL model includes various LSTM-based models due to the advantages of LSTM networks. The baselines are described as follows.

- **Stacked Long Short-Term Memory (StackedLSTM):** A StackedLSTM is an extension of the traditional LSTM architecture where multiple LSTM layers are stacked on top of each other. Each layer in the stack receives input from the previous layer and provides output to the subsequent layer [53]. This stacking allows the model to learn hierarchical representations of the input data, potentially capturing more complex patterns and dependencies. We use stackedLSTM with three LSTM layers also with dropout (D(0.20)) after each layer.

TABLE IV: Experiment parameters

Parameter Name	Value
batch size	16
maximum number of training epochs	200
optimizer	Adam
learning rate	0.001
number of BiLSTM layers	2
dimension of BiLSTM hidden states	64
time step T	21
dropout ($D(\cdot)$)	0.20

- **Convolutional Neural Network Long Short-Term Memory (CNNLSTM):** A CNNLSTM is a hybrid neural network architecture that combines convolutional layers from Convolutional Neural Networks (CNNs) with recurrent layers from Long Short-Term Memory (LSTM) networks [28]. In this architecture, the CNN layers are typically used for feature extraction from input data. The output of the CNN layers is then fed into LSTM layers, which are capable of capturing long-term dependencies in sequential data. We use CNN with three LSTM layers also with dropout (D(0.20)) after each layer.
- **Ordinary LSTM:** An ordinary LSTM (LSTM) refers to a basic sequential model that incorporates one or more LSTM layers. In an ordinary LSTM model, each LSTM layer processes the input sequence and captures relevant temporal dependencies within the data [54]. The LSTM layers are typically arranged sequentially, with each layer receiving input from the previous layer and passing its output to the next layer. This allows the model to learn hierarchical representations of the input data and capture complex patterns over time. Overall, the simplicity of the architecture makes ordinary LSTM models easy to implement and interpret. We use Ordinary LSTM with two LSTM layers also with dropout (D(0.20)) after each layer.

C. Setups

Our main model framework is performed using Keras and TensorFlow. We also consider the experiment parameters as in Table IV.

The early-stop technique minimizes the risk of overfitting by automatically stopping the training process. Specifically, to discover the optimal time step T , we consider the values $\{1, 5, 9, 13, 17, 21, 25, 29, 33\}$, and the value 21 is selected. Then we again consider the values $\{19, 20, 21, 22, 23\}$, and finally the same value 21 is selected. also the number of BiLSTM layers within $\{1, 2, 3, 4\}$. After selecting two layers of BiLSTM we have the best results and also choosing the optimal time step ($T = 21$), we display the benchmarking results on the testing set.

D. Evaluation metrics

Assessing a data science model becomes challenging in the financial. Therefore, it is imperative to thoroughly assess our proposed model through diverse performance evaluations, encompassing both classification and financial aspects.

Algorithm 1 Cryptocurrency Trading Algorithm with Commission

Input Prediction Results, Closing Price

Output TMoney

```

1:  $TMoney \leftarrow \$100,000$ 
2:  $label\_previous \leftarrow -1$ 
3:  $Commission\ Rate \leftarrow 0.001$ 
4: while Cryptocurrency Price Prediction Data Available do
5:    $label \leftarrow$  Prediction Result
6:   if  $label \neq label\_previous$  then
7:     if  $label = 1$  then
8:        $Commission \leftarrow Commission\ Rate \times TMoney$ 
9:       Buy Cryptocurrency
10:       $TMoney \leftarrow TMoney + Closing\ Price \times$ 
      Number of Stocks  $- Commission$ 
11:     else
12:       Sell Cryptocurrency
13:        $Commission \leftarrow Commission\ Rate \times TMoney$ 
14:        $TMoney \leftarrow TMoney + Closing\ Price \times$ 
      Number of Stocks  $- Commission$ 
15:     end if
16:   end if
17:    $label\_previous \leftarrow label$ 
18: end while
19: Calculate TMoney

```

Consistent with prior research [12], [55]–[57], we employ accuracy, precision, recall, F1-Score and Matthew’s correlation coefficient (MCC) as evaluation metrics for classification performance. The definitions of these metrics are as follows:

1) *Accuracy*: Accuracy evaluates a model’s prediction correctness by comparing the number of true positives and true negatives to the total number of predictions made.

$$Accuracy = \frac{TP + TN}{TP + TN + FP + FN}. \quad (8)$$

2) *Precision*: In order to assess the accuracy of positive predictions, precision looks at the ratio of true positive predictions to all positive predictions made by a model.

$$Precision = \frac{TP}{TP + FP}. \quad (9)$$

3) *Recall*: A model’s recall rate, also called its sensitivity or true positive rate, measures the percentage of true positives correctly identified by the model. All positive occurrences can be captured by the model, according to the statement.

$$Recall = \frac{TP}{TP + FN}. \quad (10)$$

4) *F1-Score*: Taking into account the trade-off between recall and precision, the F1-score provides a well-balanced measure. Due to this quality, it is particularly useful for handling imbalanced datasets.

$$F1 - Score = \frac{2 \times TP}{2 \times TP + FP + FN}. \quad (11)$$

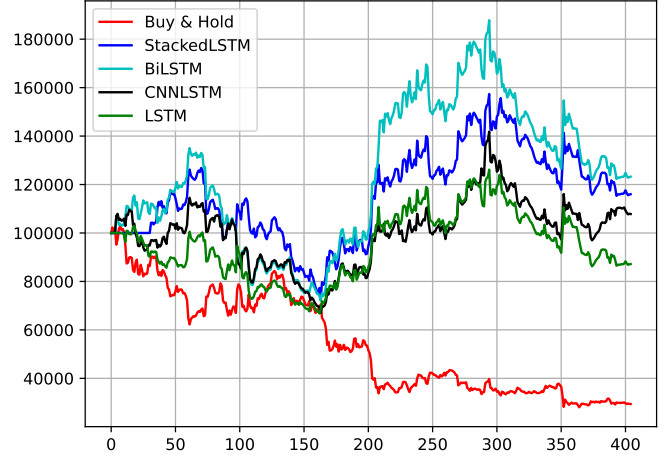

Fig. 4: TMoney of different models.

5) *MCC*: Unlike other metrics that tend to emphasize the positive class or are overly optimistic in imbalanced datasets, even if the classes are of different sizes, MCC provides a balanced measure.

$$MCC = \frac{TP \times TN - FP \times FN}{\sqrt{(TP + FP)(TP + FN)(TN + FP)(TN + FN)}}. \quad (12)$$

where TP is true positive, FP is false positive, TN is true negative and FN is false negative.

For financial assessment, we simulate cryptocurrency trading (backtesting) based on the prediction results of the cryptocurrency price movements.

6) *Total Money (TMoney)*: Total money is utilized to assess the performance of simulated trading [6], [58]. We begin with an initial capital of 100,000 USD for financial assessment. Additionally, as an extra benchmark for this assessment, we use the Buy & Hold strategy. Our initial investment capital is set at 100,000 USD, considering a 0.1% commission per transaction. We buy at the closing price of the current trading day (t), using all of our available money after deducting the commission, if the forecasted label for the following trading day ($t + 1$) is “1” (showing an upward trend). Conversely, if the predicted label is “0” (indicating a downward trend), we execute a sale at the closing price for the current trading day (t), while also considering the commission charges. Should the predicted label for the subsequent trading day ($t + 1$) correspond with the label from the previous day (t), no buying or selling actions are executed. Under the Buy & Hold strategy, we invest all initial capital in Bitcoin at the beginning and hold it without further transactions. Consequently, the capital of this strategy mirrors the real-time price fluctuations of Bitcoin. The trading basis is according to the algorithm 1.

This section compares the classification performance of our proposed model with state-of-the-art baseline approaches. The evaluation results, obtained for Bitcoin, are presented in Fig. 5. Notably, our proposed method attains the highest performance across all methods, as evidenced by accuracy,

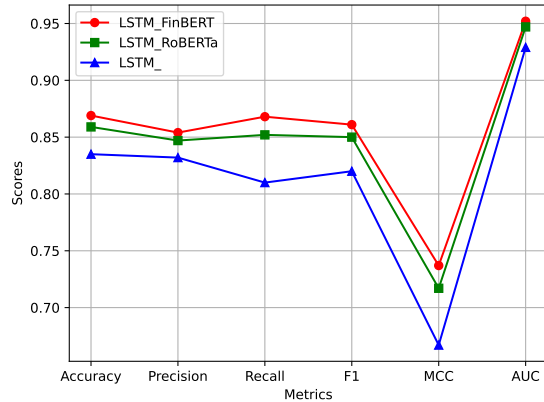

(a) LSTM

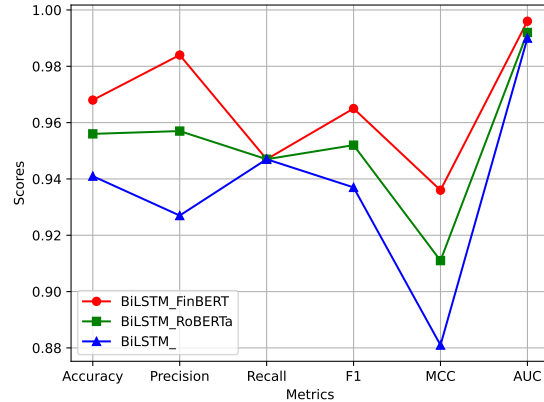

(b) BiLSTM

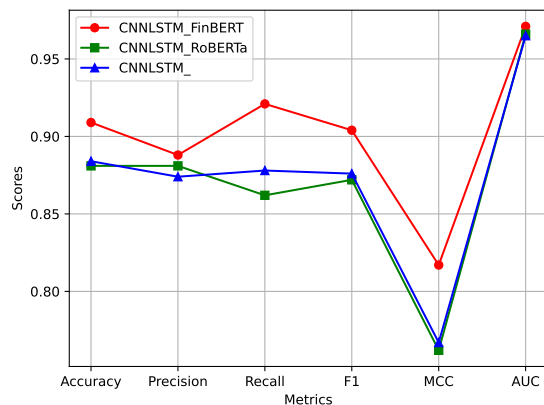

(c) CNNLSTM

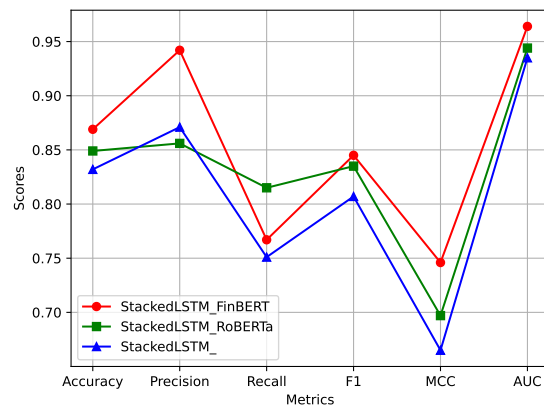

(d) StackedLSTM

Fig. 5: Performance metrics results of models (a) LSTM, (b) BiLSTM (Proposed model), (c) CNNLSTM, and (d) StackedLSTM

precision, recall, F1-Score, AUC, and MCC metrics. As a result of considering sequential dependencies in financial data, market-driven sentiment analysis, and fusing information from various sources, including cryptocurrency news from the X platform, the proposed method far outperforms the baseline methods.

According to Fig. 5, it can be concluded that our proposed model, or the BiLSTM model has the best results compared to other methods. There are two ways to interpret the results of this figure: First, it can be concluded that using a fusion of hard and soft data, including X news data, produces better results than using just hard data. As a result, we can say that soft data, including financial news about Bitcoin obtained from X, affects our model positively. As a second point, the results of the models after applying the FinBERT information are better than the results obtained from the RoBERTa model after applying the FinBERT information. Therefore, the proposed model that incorporates both hard and soft data and FinBERT information is more effective.

In addition, Fig. 4, which shows TMoney values for all types of models along with “Buy & Hold”, shows that our proposed model, which is BiLSTM, has better results than other models, and its price growth rate is better than all

models. This simulation uses only the proposed final model, which includes the soft information obtained from FinBERT.

V. FUTURE RESEARCH DIRECTIONS

There are challenges to prediction in the cryptocurrency field that researchers can address in the future.

- As previously indicated, the model cannot discern the authenticity of the news, thereby necessitating the integration of a fake news detector and an investigation into the differential impacts of real and fake news on cryptocurrency.
- Another challenge is needing a new model to distinguish more important news from less important news or metaphorical expressions.
- Upcoming studies could implement the suggested architecture for combining some related cryptocurrencies to forecast the cryptocurrency movement price.

VI. CONCLUSION

Cryptocurrency price prediction is a popular topic among investors and researchers. The complexity of these forecasts stems from the fact that they are dependent on so many factors.

Data in this field are extensive and varied, typically categorized into hard and soft data. By focusing on the most relevant and useful information, we developed a novel architecture that utilized multi-source hard and soft information to accurately predict cryptocurrency trends. Multi-source information was incorporated into this architecture. It collected a variety of quantitative features for hard information. Through pre-processing, soft data, such as news and tweets, were also collected and converted into soft information. The model was trained using the BiLSTM approach by combining these features from different sources. A set of Bitcoin representing the best and most expensive cryptocurrency was used in our experimental evaluation. The empirical findings demonstrated a notable superiority of our method over the strongest baselines, with at least 5.9% and 11.9% better results in terms of accuracy and MCC, respectively. Our model also outperformed state-of-the-art baselines in financial evaluation and demonstrated higher profitability. The fusion of hard and soft information significantly enhanced Bitcoin prediction performance. The proposed method provides investors with better investment decisions and reduces trading-related risks by providing superior prediction of cryptocurrency price movements.

APPENDIX

The closing price (C), opening price (O), highest price (H) lowest price (L), and volume of trade ($Volume$) featured in Table II can be acquired from the yahoofinance platform. However, the remaining features are computed using the following methodologies:

Moving Average (MA):

$$MA_t(C, n) = \frac{C_t + C_{t-1} + \dots + C_{t-n+1}}{n}$$

Exponential Moving Average (EMA):

$$EMA_t(C, n) = \alpha \times C_t + (1 - \alpha) \times EMA_{t-1}(C, n - 1)$$

Where $\alpha = \frac{2}{n+1}$ denotes the smoothing factor.

Rate of Change (ROC):

$$ROC_t(C, n) = \left(\frac{C_t - C_{t-n+1}}{C_{t-n+1}} \right) \times 100$$

Momentum (MOM):

$$MOM_t(C, n) = C_t - C_{t-n+1}$$

Relative Strength Index (RSI):

$$RSI_t(n) = 100 - \frac{100}{1 + \frac{\text{average gain}}{\text{average loss}}}$$

Stochastic Oscillator %K:

$$STOK_t(n) = \%K_t(n) = \frac{C_t - LL_{t,t-n+1}}{HH_{t,t-n+1} - LL_{t,t-n+1}} \times 100$$

Where $LL_{t,t-n+1}$ and $HH_{t,t-n+1}$ are the lowest low and the highest high prices in the last n days respectively.

Stochastic Oscillator %D:

$$STOD_t(n) = \%D_t = \frac{K_t + K_{t-1} + \dots + K_{t-n+1}}{n} \times 100$$

Average Directional Movement Index (ADX):

$$tr1_t = H_t - L_t$$

$$tr2_t = H_t - C_{t-1}$$

$$tr3_t = L_t - C_{t-1}$$

$$ADX_t(C, n) = \frac{ADX_{t-1} \times (n - 1) + DX_t}{n}$$

Where

$$TR_t = \max\{tr1_t; |tr2_t|; |tr3_t|\}$$

$$+DM_t = \max\{0; H_t - H_{t-1}\}$$

$$-DM_t = \max\{0; L_{t-1} - L_t\}$$

$$+DM_{avg,t} = \frac{\sum_{i=0}^{n-1} +DM_{t-i}}{n}$$

$$-DM_{avg,t} = \frac{\sum_{i=0}^{n-1} -DM_{t-i}}{n}$$

$$+DI_t(n) = \frac{+DM_{avg,t}}{ATR_t} \times 100\%$$

$$-DI_t(n) = \frac{-DM_{avg,t}}{ATR_t} \times 100\%$$

$$DX_t(n) = \frac{|+DI_t - -DI_t|}{+DI_t + -DI_t} \times 100\%$$

Minus Directional Indicator (MDI):

$$MDM_t = \begin{cases} L_{t-1} - L_t & L_{t-1} - L_t > H_t - H_{t-1} \\ & L_{t-1} - L_t > 0, \\ 0 & \text{otherwise,} \end{cases}$$

$$MDM_{avg,t}(n) = \frac{\sum_{i=1}^{n-1} MDM_{t-i}}{n}$$

$$MDI_t(n) = \frac{MDM_{avg,t}(n)}{ATR_t(n)} \times 100$$

Plus Directional Indicator (PDI):

$$PDM_t = \begin{cases} H_t - H_{t-1} & H_t - H_{t-1} > L_{t-1} - L_t \\ 0 & \text{otherwise,} \end{cases}$$

$$PDM_{avg,t}(n) = \frac{\sum_{i=1}^{n-1} PDM_{t-i}(n)}{n}$$

$$PDI_t(n) = \frac{PDM_{avg,t}}{ATR_t(n)} \times 100$$

Average True Range (ATR):

$$ATR_t(n) = \frac{TR_t + TR_{t-1} + \dots + TR_{t-n+1}}{n}$$

Aroon:

$$\text{Aroon_Up}_t(n) = \left(\frac{n - \text{argmax}(H[t-n:t+1])}{n} \right) \times 100$$

$$\text{Aroon_Down}_t(n) = \left(\frac{n - \text{argmin}(L[t-n:t+1])}{n} \right) \times 100$$

Balance of Power (BOP):

$$BOP_t = \frac{C_t - O_t}{H_t - L_t}$$

Percentage Price Oscillator (PPO):

$$PPO_t(n_1, n_2) = \left(\frac{EMA_t(C, n_1) - EMA_t(C, n_2)}{EMA_t(C, n_2)} \right) \times 100$$

Where $n_1 = 12$ and $n_2 = 26$.

Chande Momentum Oscillator (CMO):

$$CMO_t(n) = \frac{Su - Sd}{Su + Sd} \times 100$$

Where Su is the sum of higher closes over n periods and Sd is the sum of lower closes over n periods.

Money Flow Index (MFI):

$$TP_t = \text{Typical_Price}_t = \frac{H_t + L_t + C_t}{3}$$

$$RMF_t = \text{Raw Money Flow}_t = TP_t \times Vol_t$$

$$MFI_t(n) = 100 - \frac{100}{1 + \frac{PMF}{NMF}}$$

Moving Average Convergence Divergence (MACD):

$$MACD_t(n_1, n_2) = EMA_t(C, n_1) - EMA_t(C, n_2)$$

Where $n_1 = 12$ and $n_2 = 26$.

$$MACD_Signal_t(n) = EMA(MACD_t, n)$$

Where $n = 9$.

$$MACD_Hist_t(n) = MACD_t(n_1, n_2) - MACD_Signal_t(n)$$

Commodity Channel Index (CCI):

$$CCI_t(n) = \frac{M_t - SM_t}{0.015D_t}$$

Where

$$M_t = TP_t = \frac{H_t + L_t + C_t}{3}$$

and

$$SM_t = \frac{\sum_{i=0}^{n-1} M_{t-i}}{n}$$

and

$$D_t = \frac{\sum_{i=0}^{n-1} |M_{t-i} - SM_t|}{n}$$

Bollinger Bands:

Bollinger Bands include Lower Band, Middle Band, and Upper Band:

$$LB_t = MA_t(C, 20) + 2 \times std(C, 20)$$

$$MB_t(C, n) = 20 \times MA_t(C, 20)$$

$$UB_t(C, n) = MA_t(C, 20) - 2 \times std(C, 20)$$

Where $std(C, 20)$ represents the standard deviation of C over the past 20 days.

Force Index (FI):

$$Fi_t = (C_t - C_{t-1}) \times Vol_t$$

$$FI(n) = \frac{\sum_{i=1}^n Fi_i}{n}$$

Ease of Movement (EOM):

$$HLD_t = H_t - L_t$$

$$HLA_t = \frac{H_t + L_t}{2}$$

$$BR_t = \text{Box Ratio}_t = \frac{\text{Vol}_t}{\text{Scale}} \frac{1}{HLD_t}$$

That we assume $\text{Scale} = 10^{-10}$.

$$EM_t = \frac{HLA_t - HLA_{t-1}}{HLD_t}$$

$$EMV_t = \frac{EM_t}{BR_t}$$

$$EOM_t(n) = \frac{\sum_{i=t-n+1}^t EMV_i}{n}$$

REFERENCES

- [1] Z. Zhou, Z. Song, H. Xiao, and T. Ren, "Multi-source data driven cryptocurrency price movement prediction and portfolio optimization," *Expert Systems with Applications*, vol. 219, p. 119600, 2023.
- [2] Y. Xiang, Y. Lei, D. Bao, T. Li, Q. Yang, W. Liu, W. Ren, and K.-K. R. Choo, "Babd: A bitcoin address behavior dataset for pattern analysis," *IEEE Transactions on Information Forensics and Security*, 2023.
- [3] S. Nakamoto, "Bitcoin: A peer-to-peer electronic cash system," *Decentralized business review*, p. 21260, 2008.
- [4] A. Wahrstätter, A. Taudes, and D. Svetinovic, "Reducing privacy of coinjoin transactions: Quantitative bitcoin network analysis," *IEEE Transactions on Dependable and Secure Computing*, 2024.
- [5] A. S. Shah, M. A. Karabulut, A. S. Akhter, N. Mustari, A.-S. K. Pathan, K. M. Rabie, and T. Shongwe, "On the vital aspects and characteristics of cryptocurrency—a survey," *Ieee Access*, vol. 11, pp. 9451–9468, 2023.
- [6] Y. Ma, R. Mao, Q. Lin, P. Wu, and E. Cambria, "Multi-source aggregated classification for stock price movement prediction," *Information Fusion*, vol. 91, pp. 515–528, 2023.
- [7] M. N. Ashtiani and B. Raahmei, "News-based intelligent prediction of financial markets using text mining and machine learning: A systematic literature review," *Expert Systems with Applications*, p. 119509, 2023.
- [8] J. Chen, Y. Wen, Y. A. Nanehkaran, M. Suzaudola, W. Chen, and D. Zhang, "Machine learning techniques for stock price prediction and graphic signal recognition," *Engineering Applications of Artificial Intelligence*, vol. 121, p. 106038, 2023.
- [9] N. P. Patel, R. Parekh, N. Thakkar, R. Gupta, S. Tanwar, G. Sharma, I. E. Davidson, and R. Sharma, "Fusion in cryptocurrency price prediction: A decade survey on recent advancements, architecture, and potential future directions," *IEEE Access*, vol. 10, pp. 34 511–34 538, 2022.
- [10] S. Goutte, H.-V. Le, F. Liu, and H.-J. Von Mettenheim, "Deep learning and technical analysis in cryptocurrency market," *Finance Research Letters*, vol. 54, p. 103809, 2023.
- [11] G. Li, A. Zhang, Q. Zhang, D. Wu, and C. Zhan, "Pearson correlation coefficient-based performance enhancement of broad learning system for stock price prediction," *IEEE Transactions on Circuits and Systems II: Express Briefs*, vol. 69, no. 5, pp. 2413–2417, 2022.
- [12] C. Zhong, W. Du, W. Xu, Q. Huang, Y. Zhao, and M. Wang, "Lstm-regat: A network-centric approach for cryptocurrency price trend prediction," *Decision Support Systems*, vol. 169, p. 113955, 2023.
- [13] S. Kumar, S. Rao, K. Goyal, and N. Goyal, "Journal of behavioral and experimental finance: A bibliometric overview," *Journal of Behavioral and Experimental Finance*, vol. 34, p. 100652, 2022.
- [14] K. A. Coulter, "The impact of news media on bitcoin prices: modelling data driven discourses in the crypto-economy with natural language processing," *Royal Society Open Science*, vol. 9, no. 4, p. 220276, 2022.
- [15] A. Anamika and S. Subramaniam, "Do news headlines matter in the cryptocurrency market?" *Applied Economics*, vol. 54, no. 54, pp. 6322–6338, 2022.
- [16] A. Thakkar and K. Chaudhari, "Fusion in stock market prediction: a decade survey on the necessity, recent developments, and potential future directions," *Information Fusion*, vol. 65, pp. 95–107, 2021.
- [17] I. Gurrib and F. Kamalov, "Predicting bitcoin price movements using sentiment analysis: a machine learning approach," *Studies in Economics and Finance*, vol. 39, no. 3, pp. 347–364, 2022.
- [18] S. M. Dashtaki, M. Alizadeh, and B. Moshiri, "Stock market prediction using hard and soft data fusion," in *2022 13th International Conference on Information and Knowledge Technology (IKT)*. IEEE, 2022, pp. 1–7.
- [19] M. M. Kumbure, C. Lohrmann, P. Luukka, and J. Porras, "Machine learning techniques and data for stock market forecasting: a literature review," *Expert Systems with Applications*, p. 116659, 2022.
- [20] N. Nazareth and Y. Y. R. Reddy, "Financial applications of machine learning: A literature review," *Expert Systems with Applications*, p. 119640, 2023.
- [21] G. Dudek, P. Fiszeder, P. Kobus, and W. Orzeszko, "Forecasting cryptocurrencies volatility using statistical and machine learning methods: A comparative study," *Applied Soft Computing*, vol. 151, p. 111132, 2024.
- [22] S. K. Sahu, A. Mokhade, and N. D. Bokde, "An overview of machine learning, deep learning, and reinforcement learning-based techniques in quantitative finance: Recent progress and challenges," *Applied Sciences*, vol. 13, no. 3, p. 1956, 2023.
- [23] P. Mantilla and S. Dormido-Canto, "A novel feature engineering approach for high-frequency financial data," *Engineering Applications of Artificial Intelligence*, vol. 125, p. 106705, 2023.
- [24] N. Majidi, M. Shamsi, and F. Marvasti, "Algorithmic trading using continuous action space deep reinforcement learning," *Expert Systems with Applications*, vol. 235, p. 121245, 2024.
- [25] W. Serrano, "Deep reinforcement learning with the random neural network," *Engineering Applications of Artificial Intelligence*, vol. 110, p. 104751, 2022.
- [26] R. Amirzadeh, A. Nazari, and D. Thiruvady, "Applying artificial intelligence in cryptocurrency markets: A survey," *Algorithms*, vol. 15, no. 11, p. 428, 2022.
- [27] M. Ortu, N. Uras, C. Conversano, S. Bartolucci, and G. Destefanis, "On technical trading and social media indicators for cryptocurrency price classification through deep learning," *Expert Systems with Applications*, vol. 198, p. 116804, 2022.
- [28] Y. Mao, Z. Chen, S. Liu, and Y. Li, "Unveiling the potential: Exploring the predictability of complex exchange rate trends," *Engineering Applications of Artificial Intelligence*, vol. 133, p. 108112, 2024.
- [29] T. Meng, X. Jing, Z. Yan, and W. Pedrycz, "A survey on machine learning for data fusion," *Information Fusion*, vol. 57, pp. 115–129, 2020.
- [30] M. A. Becerra, C. Tobón, A. E. Castro-Ospina, and D. H. Peluffo-Ordóñez, "Information quality assessment for data fusion systems," *Data*, vol. 6, no. 6, p. 60, 2021.
- [31] H. Pabuçcu, S. Ongan, and A. Ongan, "Forecasting the movements of bitcoin prices: an application of machine learning algorithms," *arXiv preprint arXiv:2303.04642*, 2023.
- [32] S. A. Farimani, M. V. Jahan, and A. Milani Fard, "From text representation to financial market prediction: A literature review," *Information*, vol. 13, no. 10, p. 466, 2022.
- [33] R. Chiong, Z. Fan, Z. Hu, and S. Dhakal, "A novel ensemble learning approach for stock market prediction based on sentiment analysis and the sliding window method," *IEEE Transactions on Computational Social Systems*, 2022.
- [34] J. Shah, D. Vaidya, and M. Shah, "A comprehensive review on multiple hybrid deep learning approaches for stock prediction," *Intelligent Systems with Applications*, p. 200111, 2022.
- [35] S. Bhatt, M. Ghazanfar, and M. Amirhosseini, "Machine learning based cryptocurrency price prediction using historical data and social media sentiment," *Computer Science & Information Technology (CS & IT)*, vol. 13, no. 10, pp. 1–11, 2023.
- [36] J. Li, Y. Gong, Q. Zhao, Y. Xie, S. Fong, and J. Yen, "Market sentiment analysis based on social media and trading volume for asset price movement prediction," in *International Conference on Advanced Data Mining and Applications*. Springer, 2023, pp. 383–398.
- [37] M. Azamjon, O. Sattarov, and J. Cho, "Forecasting bitcoin volatility through on-chain and whale-alert tweet analysis using the q-learning algorithm," *IEEE Access*, 2023.
- [38] W. Jiang, "Applications of deep learning in stock market prediction: recent progress," *Expert Systems with Applications*, vol. 184, p. 115537, 2021.
- [39] S. A. Farimani, M. V. Jahan, A. M. Fard, and S. R. K. Tabbakh, "Investigating the informativeness of technical indicators and news sentiment in financial market price prediction," *Knowledge-Based Systems*, vol. 247, p. 108742, 2022.

- [40] H. Lee, J. H. Kim, and H. S. Jung, "Deep-learning-based stock market prediction incorporating esg sentiment and technical indicators," *Scientific Reports*, vol. 14, no. 1, p. 10262, 2024.
- [41] "<https://finance.yahoo.com/>."
- [42] Y. Han, J. Kim, and D. Enke, "A machine learning trading system for the stock market based on n-period min-max labeling using xgboost," *Expert Systems with Applications*, vol. 211, p. 118581, 2023.
- [43] J. Nobre and R. F. Neves, "Combining principal component analysis, discrete wavelet transform and xgboost to trade in the financial markets," *Expert Systems with Applications*, vol. 125, pp. 181–194, 2019.
- [44] T. A. Borges and R. F. Neves, "Ensemble of machine learning algorithms for cryptocurrency investment with different data resampling methods," *Applied Soft Computing*, vol. 90, p. 106187, 2020.
- [45] F. Ozer and C. O. Sakar, "An automated cryptocurrency trading system based on the detection of unusual price movements with a time-series clustering-based approach," *Expert Systems with Applications*, vol. 200, p. 117017, 2022.
- [46] Z. Boukhers, A. Bouabdallah, M. Lohr, and J. Jürjens, "Ensemble and multimodal approach for forecasting cryptocurrency price," *arXiv preprint arXiv:2202.08967*, 2022.
- [47] Y. Liu, M. Ott, N. Goyal, J. Du, M. Joshi, D. Chen, O. Levy, M. Lewis, L. Zettlemoyer, and V. Stoyanov, "Roberta: A robustly optimized bert pretraining approach," *arXiv preprint arXiv:1907.11692*, 2019.
- [48] D. Araci, "Finbert: Financial sentiment analysis with pre-trained language models," *arXiv preprint arXiv:1908.10063*, 2019.
- [49] Y. Zou and D. Herremans, "Prebit—a multimodal model with twitter finbert embeddings for extreme price movement prediction of bitcoin," *Expert Systems with Applications*, vol. 233, p. 120838, 2023.
- [50] "<https://twitter.com/>."
- [51] A. Bâra and S.-V. Oprea, "An ensemble learning method for bitcoin price prediction based on volatility indicators and trend," *Engineering Applications of Artificial Intelligence*, vol. 133, p. 107991, 2024.
- [52] M. H. Chagahi, S. M. Dashtaki, B. Moshiri, and M. J. Piran, "Cardiovascular disease detection using a novel stack-based ensemble classifier with aggregation layer, dowu operator, and feature transformation," *Computers in Biology and Medicine*, vol. 173, p. 108345, 2024.
- [53] M. Ayitey Junior, P. Appiahene, and O. Appiah, "Forex market forecasting with two-layer stacked long short-term memory neural network (lstm) and correlation analysis," *Journal of Electrical Systems and Information Technology*, vol. 9, no. 1, p. 14, 2022.
- [54] E. Koo and G. Kim, "Centralized decomposition approach in lstm for bitcoin price prediction," *Expert Systems with Applications*, vol. 237, p. 121401, 2024.
- [55] H. Huang, X. Liu, Y. Zhang, and C. Feng, "News-driven stock prediction via noisy equity state representation," *Neurocomputing*, vol. 470, pp. 66–75, 2022.
- [56] Q. Li, J. Tan, J. Wang, and H. Chen, "A multimodal event-driven lstm model for stock prediction using online news," *IEEE Transactions on Knowledge and Data Engineering*, vol. 33, no. 10, pp. 3323–3337, 2020.
- [57] X. Wang, S. Tian, and W. Cui, "Contractcheck: Checking ethereum smart contracts in fine-grained level," *IEEE Transactions on Software Engineering*, 2024.
- [58] Y. Ma, R. Mao, Q. Lin, P. Wu, and E. Cambria, "Quantitative stock portfolio optimization by multi-task learning risk and return," *Information Fusion*, vol. 104, p. 102165, 2024.