

A Comprehensive Evaluation of Deep Learning Object Detection Models on Heterogeneous Edge Devices

Daghash K. Alqahtani, Muhammad Aamir Cheema, Maria A. Rodriguez, Adel N. Toosi

Abstract—Modern applications such as autonomous vehicles, intelligent surveillance, and smart city systems increasingly require object detection on resource-constrained edge devices. Yet, there is still limited understanding of how different object detection models behave across heterogeneous edge devices and under varying scene complexity. In this paper, we benchmark YOLOv8 (Nano, Small, Medium), EfficientDet Lite (Lite0, Lite1, Lite2), and SSD (SSD MobileNet V1, SSDLite MobileDet) on Raspberry Pi 3, 4, 5 with/without Coral TPU accelerators, Raspberry Pi 5 with AI HAT+, Jetson Nano, and Jetson Orin Nano. We evaluate energy consumption, inference time, and accuracy, and further examine how accuracy changes with the number of objects in the input image. The results reveal clear trade-offs among accuracy, latency, and energy efficiency across model-device combinations. SSD MobileNet V1 achieves the lowest latency and energy consumption but the lowest accuracy, whereas YOLOv8 Medium achieves the highest accuracy at higher computational cost. TPU-based Raspberry Pi devices improve the efficiency of SSD and EfficientDet Lite while reducing YOLOv8 accuracy. Orin Nano offers the most favorable overall balance across most model families. The object-count-based analysis further shows that models achieve more similar accuracy on simpler images, while the accuracy gap widens as scene complexity increases.

Index Terms—Object Detection Models, Performance Evaluation, Inference Time, Energy Efficiency, Accuracy, Edge.

I. INTRODUCTION

OBJECT detection is a fundamental task in computer vision that aims to identify and localize objects in images or video streams. It underpins a wide range of applications, including autonomous driving, intelligent surveillance, retail analytics, healthcare, agriculture, manufacturing, environmental monitoring, and smart city systems. In many of these scenarios, object detection must be performed under strict latency and energy constraints while maintaining acceptable accuracy. For example, in autonomous transportation systems, object detectors are used to recognize pedestrians, vehicles, and obstacles in real time to support safe navigation and decision making. By combining onboard computing platforms with Internet of Things (IoT) sensors, such systems can process visual data locally without relying on remote cloud infrastructure, thereby reducing communication delay and improving responsiveness and operational reliability [1].

Recent advances in deep learning have significantly improved the accuracy and robustness of object detection models.

Daghash K. Alqahtani, Maria A. Rodriguez, and Adel N. Toosi are with the DisNet Lab, School of Computing and Information Systems, The University of Melbourne, Melbourne, VIC, Australia (e-mail: daghash.alqahtani@student.unimelb.edu.au; marodriguez@unimelb.edu.au; adel.toosi@unimelb.edu.au).

Muhammad Aamir Cheema and Adel N. Toosi are also with Monash University, Melbourne, VIC, Australia (e-mail: aamir.cheema@monash.edu).

This research was partially supported by the Australian Research Council (ARC) through funded projects DP230100081 and LP210200213.

At the same time, the emergence of *edge computing* has made it increasingly feasible to deploy these models directly on resource-constrained devices, including embedded boards, smart cameras, and IoT gateways. Performing object detection at the edge offers several important advantages, such as lower end-to-end latency, reduced bandwidth usage, improved privacy, and greater resilience to network disruptions. However, practical deployment remains challenging because edge platforms differ substantially in compute capability, accelerator support, memory capacity, and energy characteristics. As a result, selecting an appropriate model-device combination requires carefully balancing inference time, energy consumption, and detection accuracy.

Although many light-weight object detection models are now available for edge deployment, there is still limited understanding of how they perform across heterogeneous edge devices under varying scene complexity. Existing benchmarking studies typically report aggregate results over an entire dataset, without examining how image content, particularly the number of objects present in a scene, influences the trade-offs among latency, energy consumption, and accuracy. In real-world IoT and edge intelligence applications, however, workloads are rarely uniform. Some images may contain no relevant objects, whereas others may contain multiple objects and thus impose different processing demands. A more detailed evaluation is therefore needed to understand how model-device combinations behave under realistic and diverse visual workloads.

In this paper, we present a benchmarking study of representative deep learning object detection models across a diverse set of edge devices, including Raspberry Pi platforms, TPU-enabled Raspberry Pi configurations, Raspberry Pi 5 with AI HAT+, Jetson Nano, and Jetson Orin Nano. We evaluate widely used object detection model families, including *You Only Look Once (YOLO)* [2], *Single Shot MultiBox Detector (SSD)* [3], and *EfficientDet Lite* [4]. For each family, we consider representative variants: YOLOv8 (Nano, Small, Medium) [5], SSD (SSD MobileNet V1 and SSDLite MobileDet), and EfficientDet (Lite0, Lite1, Lite2). These models are evaluated using key performance metrics such as energy consumption, inference time, and mean Average Precision (mAP). Furthermore, to capture the effect of object count as a proxy for scene complexity, we partition the evaluation images into five groups according to the number of objects present: 0, 1, 2, 3, and 4 or more objects. This grouping enables a finer-grained analysis of model accuracy and system behavior, providing deeper insight into how different model-device combinations respond to varying levels of image content complexity.

Our **key contributions** are summarized as follows:

- We develop object detection applications as web services for image processing on heterogeneous edge platforms, enabling a consistent and reproducible benchmarking environment.
- We deploy multiple object detection model families, including *YOLOv8*, *SSD*, and *EfficientDet Lite*, using different inference frameworks such as *PyTorch*, *TensorFlow Lite*, *Hailo-8*, and *TensorRT* across a diverse set of edge devices, including *Raspberry Pi* series, *Edge TPU* enabled devices, *Raspberry Pi 5 with AI HAT+*, *Jetson Nano*, and *Jetson Orin Nano*.
- We evaluate detection accuracy using the FiftyOne tool and report *mAP* not only at the overall model level but also across image subsets grouped by object count, enabling a more detailed understanding of performance under varying levels of scene complexity.
- We conduct automated performance benchmarking using the Locust tool and report *energy consumption* and *inference time* of the evaluated models on the investigated edge devices, providing practical insights into suitable model-device combinations for edge and IoT deployments.

The remainder of this paper is organized as follows. Section II describes the evaluation methodology, including the evaluation metrics and experimental setup. Section III reports the performance evaluation results. Section IV reviews the related literature. Finally, Section V concludes the paper and outlines directions for future work.

II. EVALUATION METHODOLOGY

This section outlines the methodology used to evaluate the investigated object detection models on the selected edge devices. It introduces the evaluation framework and the criteria used to assess performance, including accuracy, inference time, energy consumption, and object-count-based analysis.

A. Metrics

1) *Inference Time*: Inference time measures the time required by a model service to process an input image and generate the detection response. In our setup, this time is measured on the target edge device from the moment the image is received by the object detection service to the moment the response is produced and returned by the service. Thus, the reported inference time captures the server-side processing time on the edge device, including model execution and the associated response generation within the service, but excluding network transmission delay between the client and the edge device. Inference time is reported in milliseconds for each model-device combination and is averaged over the processed requests to ensure consistent and reliable measurement.

2) *Energy Consumption*: Energy consumption is used to evaluate the energy efficiency of each model on the investigated edge devices. We first measure the base energy consumption, denoted by BE , while the device remains idle for a fixed duration of 5 minutes without executing any workload. We then measure the total energy consumption, denoted by

TE , over the same duration while the object detection model is running.

The energy consumption per request, excluding base energy, denoted by E_{excR} , is computed in milliwatt-hours (mWh) as

$$E_{\text{excR}} = \frac{TE - BE}{NR}, \quad (1)$$

where NR denotes the number of processed requests. Reporting energy on a per-request basis enables a fairer comparison across heterogeneous platforms, since total energy usage depends on the number of completed requests. This metric is particularly important for power-constrained and battery-powered edge devices.

3) *Model Evaluation Using the COCO Dataset*: To evaluate the detection capability of the investigated *YOLOv8*, *EfficientDet Lite*, and *SSD* models, we use the COCO validation dataset containing 5,000 images [6]. The open source FiftyOne tool¹ is employed for dataset access, result visualization, and model evaluation using COCO annotations. It measures detection performance by comparing the predicted bounding boxes and class labels against the ground truth annotations. We report standard accuracy metric *mAP*. Furthermore, we perform an object-count-based analysis by partitioning images into five groups according to the number of objects present in each image: 0, 1, 2, 3, and 4 or more objects. This grouping allows us to examine how accuracy varies with scene complexity and provides deeper insight into the behavior of different model-device combinations under diverse visual workloads.

B. Experimental Setup

1) *Hardware and Device Setup*: Our experimental setup includes a diverse set of edge devices for evaluating object detection performance, as summarized in Table I. The evaluated platforms include Raspberry Pi 3 Model B+, Raspberry Pi 4 Model B, Raspberry Pi 5, Raspberry Pi 3 with TPU, Raspberry Pi 4 with TPU, Raspberry Pi 5 with TPU, Raspberry Pi 5 with AI HAT+, Jetson Nano, and Jetson Orin Nano. These devices were selected to represent a broad range of edge computing configurations with different levels of computational capability and hardware acceleration. In particular, the setup includes CPU-only platforms, TPU-enabled Raspberry Pi platforms, Raspberry Pi 5 with a dedicated NPU-based accelerator, and NVIDIA GPU-based edge devices. This diversity enables a comprehensive comparison of object detection performance across heterogeneous model-device combinations. In addition, a UM25C² power meter with Bluetooth connectivity is used to measure the energy consumption of each device.

2) *Software and Deployment Stack*: In our experimental setup, we employ different deployment stacks to execute object detection models on the investigated edge devices, as summarized in Table I. The choice of framework or runtime is determined by the capabilities of each target platform and the need to obtain efficient inference performance across CPU-based, TPU-enabled, AI accelerator-based, and GPU-based devices. For Raspberry Pi 3, Raspberry Pi 4, and Raspberry Pi

¹<https://docs.voxel51.com/>

²<https://joy-it.net/en/products/JT-UM25C>

TABLE I
EDGE DEVICES, MODELS, INPUT SIZES, AND DEPLOYMENT STACK.

Edge Device/RAM	Model	Model Size	Input Size	Deployment Stack
Raspberry Pi 3 Model B+ (1 GB) Raspberry Pi 4 Model B (4 GB) Raspberry Pi 5 (4 GB)	EfficientDet Lite0	5.7 MB	320 × 320 × 3	TFLite
	EfficientDet Lite1	7.6 MB	384 × 384 × 3	TFLite
	EfficientDet Lite2	10.2 MB	448 × 448 × 3	TFLite
	SSD MobileNet V1	7.0 MB	300 × 300 × 3	TFLite
	SSDLite MobileDet	5.1 MB	320 × 320 × 3	TFLite
	YOLOv8 Nano	6.5 MB	640 × 640 × 3	PyTorch
	YOLOv8 Small	22.6 MB	640 × 640 × 3	PyTorch
Raspberry Pi 3 with TPU (1 GB) Raspberry Pi 4 with TPU (4 GB) Raspberry Pi 5 with TPU (4 GB)	EfficientDet Lite0	6.0 MB	320 × 320 × 3	TFLite
	EfficientDet Lite1	8.0 MB	384 × 384 × 3	TFLite
	EfficientDet Lite2	10.7 MB	448 × 448 × 3	TFLite
	SSD MobileNet V1	7.4 MB	300 × 300 × 3	TFLite
	SSDLite MobileDet	5.4 MB	320 × 320 × 3	TFLite
	YOLOv8 Nano	3.9 MB	320 × 320 × 3	TFLite
	YOLOv8 Small	11.6 MB	320 × 320 × 3	TFLite
Raspberry Pi 5 with AI HAT+ (4 GB)	EfficientDet Lite0	9.4 MB	320 × 320 × 3	HailoRT
	EfficientDet Lite1	11.4 MB	384 × 384 × 3	HailoRT
	EfficientDet Lite2	14.0 MB	448 × 448 × 3	HailoRT
	SSD MobileNet V1	7.0 MB	300 × 300 × 3	HailoRT
	SSDLite MobileDet	6.8 MB	320 × 320 × 3	HailoRT
	YOLOv8 Nano	5.2 MB	640 × 640 × 3	HailoRT
	YOLOv8 Small	10.4 MB	640 × 640 × 3	HailoRT
Jetson Nano (4 GB) Jetson Orin Nano (4 GB)	EfficientDet Lite0	15.4 MB	320 × 320 × 3	TensorRT
	EfficientDet Lite1	19.8 MB	384 × 384 × 3	TensorRT
	EfficientDet Lite2	24.9 MB	448 × 448 × 3	TensorRT
	SSD MobileNet V1	14.7 MB	300 × 300 × 3	TensorRT
	SSDLite MobileDet	10.8 MB	320 × 320 × 3	TensorRT
	YOLOv8 Nano	14.2 MB	640 × 640 × 3	TensorRT
	YOLOv8 Small	46.1 MB	640 × 640 × 3	TensorRT
YOLOv8 Medium	105.3 MB	640 × 640 × 3	TensorRT	

5, *PyTorch* is used to run YOLOv8 models, while *TensorFlow Lite* is used to deploy EfficientDet Lite and SSD models. To exploit Edge TPU acceleration, the YOLOv8 models are converted from PyTorch to TensorFlow Lite format and then compiled for execution on Raspberry Pi devices equipped with Coral USB Accelerators. In this configuration, the YOLOv8 models use an input size of 320×320 rather than 640×640 in order to fit the constraints of TPU-based deployment. EfficientDet Lite and SSD models are also deployed in TensorFlow Lite format and compiled for execution on Edge TPU. For Raspberry Pi 5 with AI HAT+, the evaluated models are deployed using the Hailo software stack to execute inference on the Hailo-8 accelerator. For both Jetson Nano and Jetson Orin Nano, the models are converted and deployed using *TensorRT* to enable optimized inference on NVIDIA GPUs.

The operating systems used in the experiments are Raspberry Pi OS Bookworm 64-bit for the Raspberry Pi-based devices and Jetson Linux, which is Ubuntu-based, for Jetson Nano and Jetson Orin Nano. Additional software tools, including OpenCV for image processing and FiftyOne for model evaluation, are used to facilitate the experiments. To perform object detection, we implement each model as a Python-based service using the Flask RESTful library and expose it through an API endpoint. This design enables consistent integration, automation, and testing across different edge platforms.

3) *Experimental Procedure*: The evaluation procedure consists of several stages, as illustrated in Fig. 1. First, the base energy consumption of each device is measured over a five-minute period while the device remains idle and no inference workload is executed. Energy readings are collected using a Python-based energy reader running on a separate device

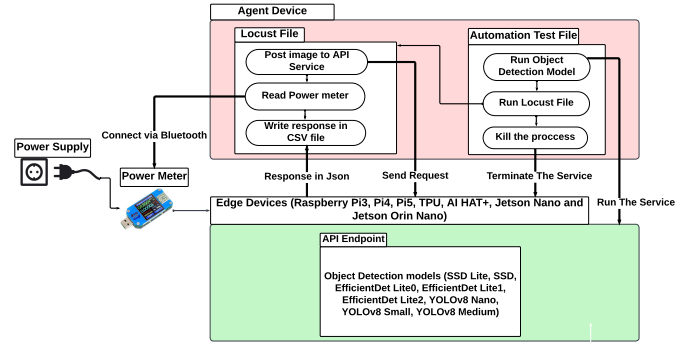

Fig. 1. Experimental software and hardware setup.

connected to the UM25C power meter.

Next, the object detection service is executed on the target edge device, and a Locust³ client is used to generate requests for five minutes. In particular, the workload is generated using a single Locust user, meaning that only one request is active at a time and each new request is issued after the previous response is received. During this period, the total energy consumption, number of processed requests, and inference time values returned by the service are recorded automatically and stored in CSV files.

To automate the experiments, a bash script running on an agent device launches the object detection service on the target edge platform, executes the Locust workload, terminates the service after completion, and then proceeds to the next model. This process ensures consistent execution across all evaluated

³<https://locust.io/>

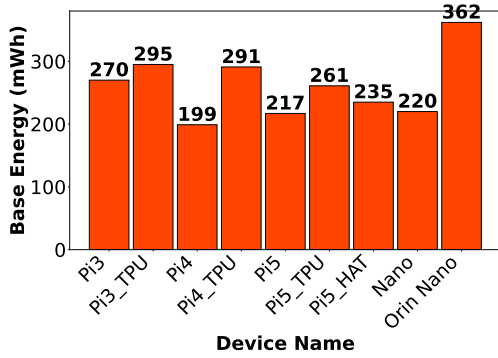

Fig. 2. Base energy for different edge devices over a 5-minute period.

model-device combinations. Each experiment is repeated three times, and the average values are used in the final analysis.

Finally, accuracy is evaluated using FiftyOne and the COCO validation dataset by comparing model predictions with ground-truth annotations to compute *mAP*. In addition to the full validation dataset evaluation, we also perform an object-content-based accuracy analysis to examine how detection accuracy varies with image content.

III. PERFORMANCE EVALUATION RESULTS

A. Energy Consumption

This section presents the results for base energy consumption, total energy consumption per request, and energy consumption per request excluding base energy across the evaluated edge devices.

We begin with the base energy consumption results, which provide insight into the idle energy characteristics of the different hardware platforms before analyzing request-level energy behavior. Fig. 2 first reports the base energy consumption of the devices in mWh. Among the CPU-only Raspberry Pi platforms, Raspberry Pi 3 exhibits the highest base energy consumption at 270 mWh, followed by Raspberry Pi 5 at 217 mWh and Raspberry Pi 4 at 199 mWh. This suggests that the newer Raspberry Pi generations are generally more energy efficient in the idle state. When TPU-based configurations are considered, Raspberry Pi 3 with TPU and Raspberry Pi 4 with TPU show similar base energy consumption values of 295 mWh and 291 mWh, respectively, while Raspberry Pi 5 with TPU records a lower value of 261 mWh. Raspberry Pi 5 with AI HAT+ has a base energy consumption of 235 mWh, which is lower than Raspberry Pi 5 with TPU but slightly higher than Raspberry Pi 5 without acceleration. Among the NVIDIA platforms, Jetson Nano records a base energy consumption of 220 mWh, whereas Jetson Orin Nano exhibits the highest base energy consumption overall at 362 mWh.

In addition to the base energy consumption, the energy consumption per request excluding base energy reveals clear differences across the evaluated model-device combinations. On Raspberry Pi 3, as shown in Fig. 3(a), the EfficientDet Lite models consume between 0.41 and 0.98 mWh per request, while SSD_v1 and SSD_lite consume 0.31 mWh and 0.41 mWh, respectively. The YOLOv8 models exhibit substantially

higher energy consumption, ranging from 1.22 to 5.87 mWh per request. When TPU acceleration is added to Raspberry Pi 3, as shown in Fig. 3(b), the energy consumption decreases across all model families. In this setting, EfficientDet Lite models consume between 0.32 and 0.61 mWh per request, SSD_v1 and SSD_lite consume 0.11 mWh and 0.13 mWh, respectively, and YOLOv8 models range from 0.23 to 0.43 mWh per request.

A similar trend is observed for Raspberry Pi 4 and its TPU-based configuration. On Raspberry Pi 4, as shown in Fig. 3(c), EfficientDet Lite models consume between 0.14 and 0.33 mWh per request, while SSD_v1 and SSD_lite consume 0.11 mWh and 0.14 mWh, respectively. The YOLOv8 models show noticeably higher energy consumption, ranging from 0.77 to 2.92 mWh per request. When TPU acceleration is used, as shown in Fig. 3(d), the energy consumption decreases across all model families. In this setting, EfficientDet Lite models consume between 0.13 and 0.19 mWh per request, SSD_v1 and SSD_lite consume 0.10 mWh and 0.11 mWh, respectively, and YOLOv8 models range from 0.26 to 0.32 mWh per request.

For Raspberry Pi 5 and its accelerator-based configurations, the same overall pattern is maintained. On Raspberry Pi 5, shown in Fig. 3(e), EfficientDet Lite models consume between 0.24 and 0.47 mWh per request, while SSD_v1 and SSD_lite consume 0.22 mWh and 0.24 mWh, respectively. The YOLOv8 models again record higher values, ranging from 1.02 to 3.58 mWh per request. With TPU acceleration on Raspberry Pi 5, as shown in Fig. 3(f), EfficientDet Lite models consume between 0.18 and 0.30 mWh per request, SSD_v1 and SSD_lite consume 0.13 mWh and 0.14 mWh, respectively, and YOLOv8 models range from 0.47 to 0.62 mWh per request. For Raspberry Pi 5 with AI HAT+, shown in Fig. 3(g), EfficientDet Lite models consume between 0.26 and 0.31 mWh per request, SSD_v1 and SSD_lite consume 0.21 mWh and 0.23 mWh, respectively, and YOLOv8 models range from 0.20 to 0.36 mWh per request.

For the NVIDIA platforms, as shown in Fig. 3(h) and Fig. 3(i), Jetson Nano and Jetson Orin Nano both show strong energy efficiency. On Jetson Nano, EfficientDet Lite models consume between 0.20 and 0.35 mWh per request, while SSD_v1 and SSD_lite consume 0.15 mWh and 0.17 mWh, respectively. The YOLOv8 models range from 0.28 to 1.07 mWh per request. On Jetson Orin Nano, the corresponding values decrease further, with EfficientDet Lite models consuming between 0.09 and 0.14 mWh per request, SSD_v1 and SSD_lite consuming 0.01 mWh and 0.06 mWh, respectively, and YOLOv8 models ranging from 0.13 to 0.22 mWh per request.

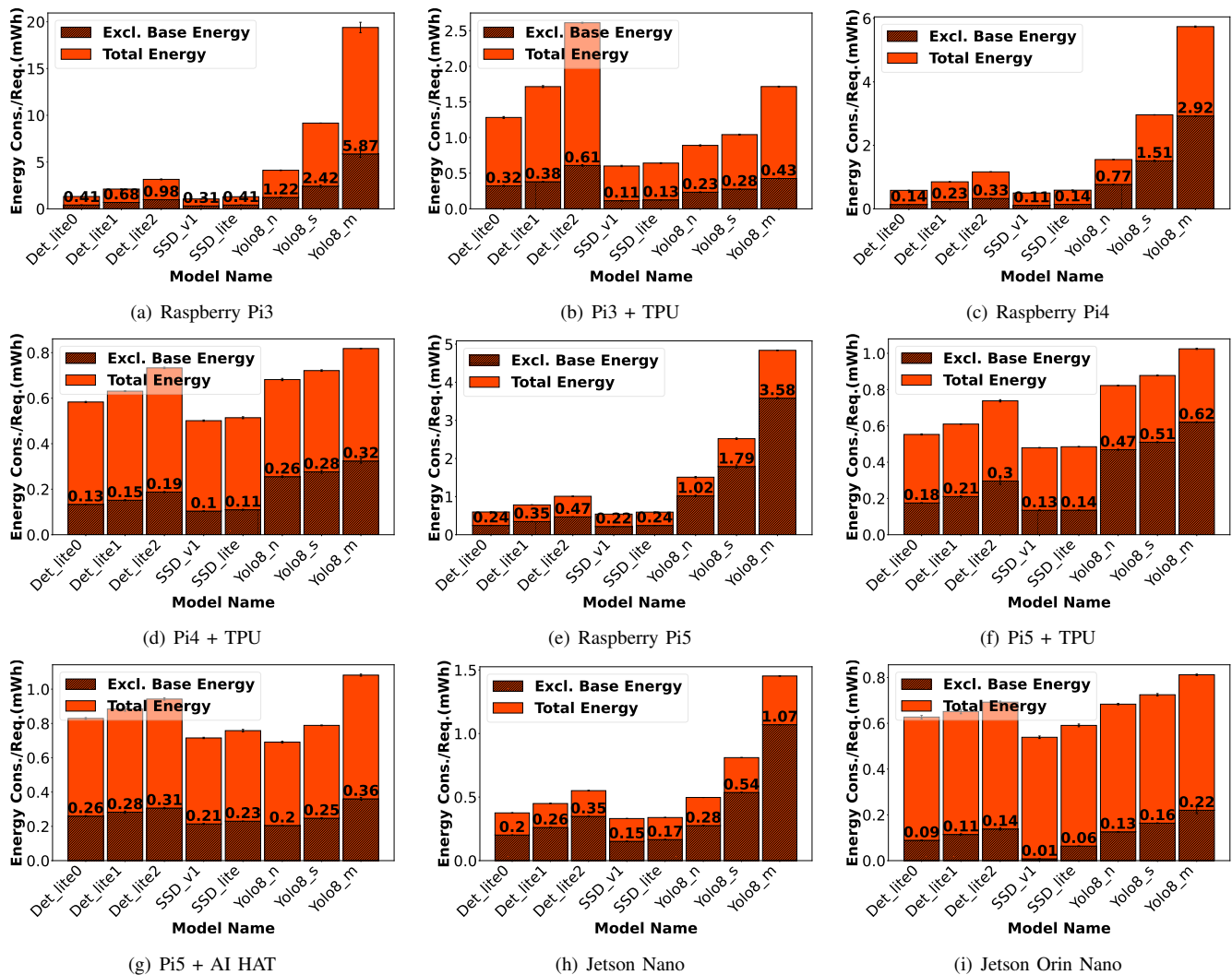

Fig. 3. Energy consumption per request excluding base energy and total energy consumption per request across different edge devices.

Key Insight 1

Model energy consumption varies with size and architecture, but overall trends remain consistent across devices. The ratio between per-request energy excluding and including idle baseline varies across platforms—being higher for some devices e.g., Jetson Nano and Pi 5 and lower for others e.g., Pi 3 + TPU and Jetson Orin Nano—reflecting differences in how idle energy impacts total consumption. Hardware accelerators (TPUs, NPUs, GPUs) generally improve energy efficiency per request.

B. Inference Time

This section analyzes the inference time of the evaluated object detection models across the investigated edge devices. The results, reported in milliseconds, reveal clear differences in latency across model-device combinations.

On Raspberry Pi 3, as shown in Fig. 4(a), SSD_v1 achieves the lowest inference time at 427 ms, followed by SSD_lite at 589 ms. The EfficientDet Lite models require between 611

and 1,985 ms, while the YOLOv8 models exhibit substantially higher latency, ranging from 2,548 to 12960 ms. When TPU acceleration is added to Raspberry Pi 3, as shown in Fig. 4(b), the inference times of SSD and YOLOv8 models decrease markedly. In this configuration, SSD_v1 remains the fastest at 61 ms, whereas EfficientDet Lite2 records the highest inference time at 1,576 ms.

A similar trend is observed for Raspberry Pi 4 and its TPU-based configuration. On Raspberry Pi 4, as shown in Fig. 4(c), SSD_v1 and SSD_lite achieve the lowest inference times at 209 ms and 292 ms, respectively. EfficientDet Lite models range from 297 to 882 ms, while YOLOv8 models range from 760 to 3,671 ms, with YOLOv8_m exhibiting the highest latency. When TPU acceleration is used, as shown in Fig. 4(d), latency decreases substantially across all model families. In this setting, SSD_v1 records 12 ms, SSD_lite records 20 ms, EfficientDet Lite models range from 79 to 188 ms, and YOLOv8 models range from 34 to 112 ms.

For Raspberry Pi 5 and its accelerator-based configurations, the same overall pattern is maintained. On Raspberry Pi 5, shown in Fig. 4(e), SSD_v1 and SSD_lite achieve the lowest

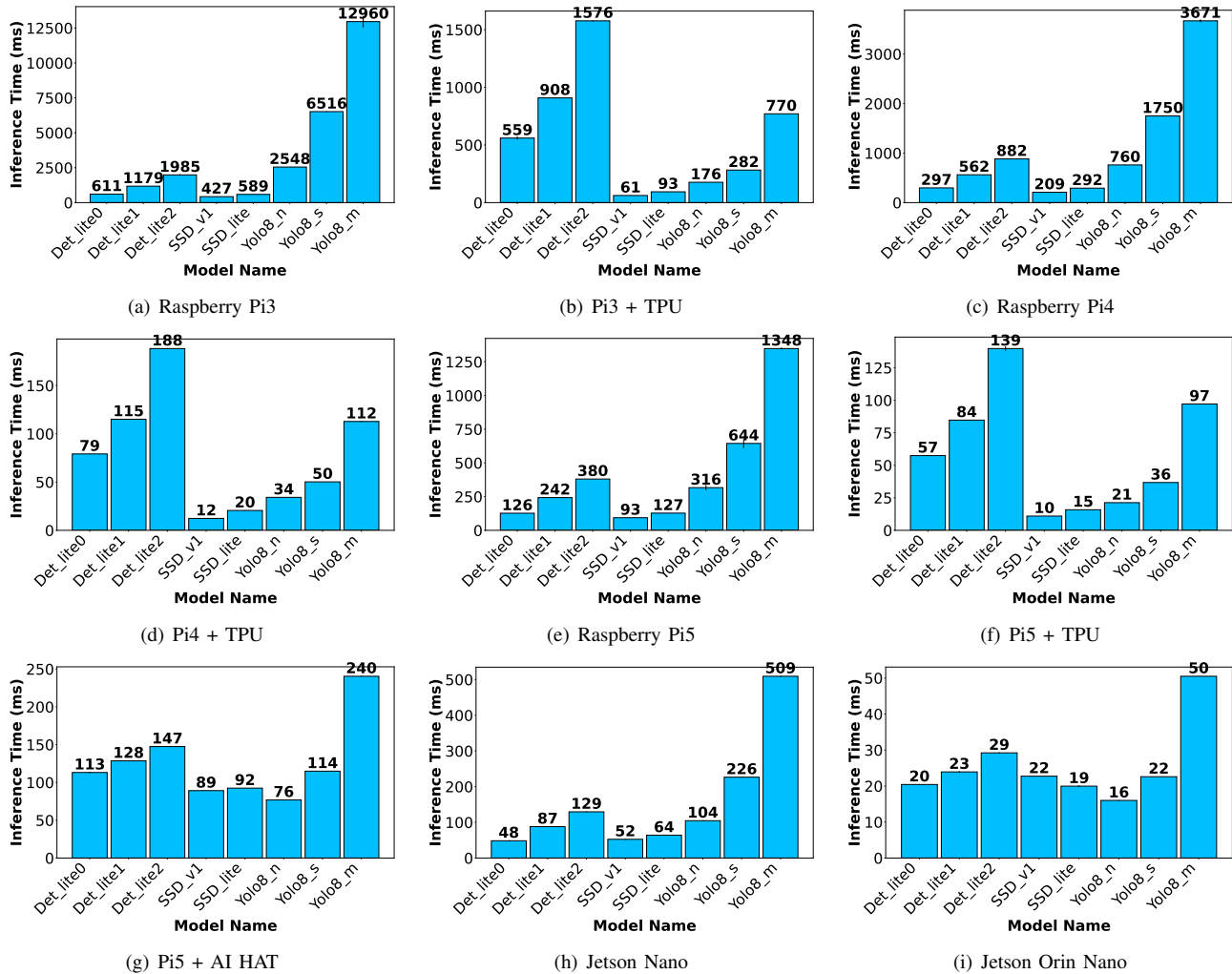

Fig. 4. Inference Time per request for different edge devices.

inference times at 93 ms and 127 ms, respectively, while EfficientDet Lite models range from 126 to 380 ms and YOLOv8 models range from 316 to 1,348 ms. For Raspberry Pi 5 with TPU, shown in Fig. 4(f), SSD_v1 records the lowest inference time at 10 ms, SSD_lite records 15 ms, EfficientDet Lite models range from 57 to 139 ms, and YOLOv8 models range from 21 to 97 ms. For Raspberry Pi 5 with AI HAT+, shown in Fig. 4(g), SSD_v1 and SSD_lite record 89 ms and 92 ms, respectively, EfficientDet Lite models range from 113 to 147 ms, and YOLOv8 models range from 76 to 240 ms. Notably, YOLOv8_n achieves the lowest inference time on this platform at 76 ms.

For the NVIDIA platforms, as shown in Fig. 4(h) and Fig. 4(i), Jetson Nano and Jetson Orin Nano both exhibit strong latency performance. On Jetson Nano, EfficientDet Lite models range from 48 to 129 ms, while SSD_v1 and SSD_lite record 52 ms and 64 ms, respectively. The YOLOv8 models range from 104 to 509 ms. On Jetson Orin Nano, the corresponding values decrease further, with EfficientDet Lite models ranging from 20 to 29 ms, SSD_v1 and SSD_lite recording 22 ms and 19 ms, respectively, and YOLOv8 models ranging from 16 to 50 ms. On this platform, YOLOv8_n achieves the

minimum inference time at 16 ms, while YOLOv8_m remains the slowest at 50 ms.

Key Insight 2

Overall, accelerators such as NPUs, TPUs, and GPUs significantly reduce inference time, with the most pronounced improvements observed for computationally intensive models such as YOLOv8. In contrast, the performance gains are more modest for lighter models like EfficientDet and SSD, with the GPU-based Jetson Orin Nano achieving the best overall inference time.

C. Accuracy

This subsection presents the accuracy results of the evaluated object detection models in terms of mAP. On the Raspberry Pi platforms, as shown in Fig. 5(a), the accuracy varies noticeably across model families and model sizes. Among the evaluated models, SSD_v1 records the lowest mAP at 19, whereas YOLOv8_m achieves the highest mAP at 44. The EfficientDet Lite models exhibit intermediate accuracy levels, with mAP values ranging from 26 to 33. SSD_lite

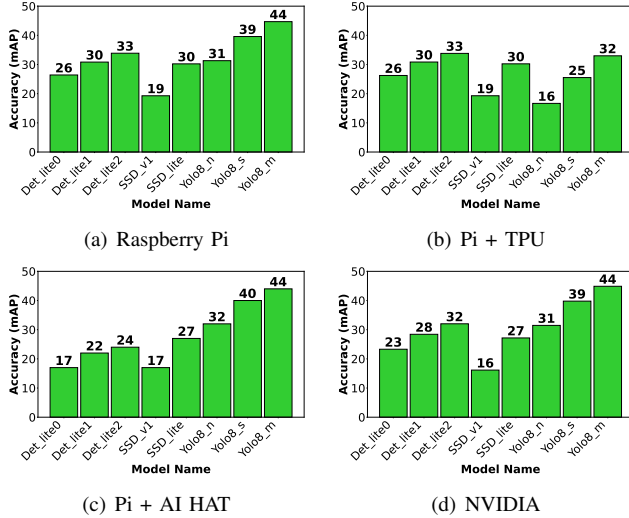

Fig. 5. Accuracy (mAP) for different edge devices.

and YOLOv8_n achieve similar mAP values around 30, while YOLOv8_s attains a higher mAP of 39.

For the Raspberry Pi devices equipped with TPU accelerators, as shown in Fig. 5(b), the EfficientDet Lite and SSD model families maintain accuracy levels comparable to those observed on the CPU-based Raspberry Pi platforms. In contrast, the YOLOv8 models experience a noticeable reduction in accuracy under TPU-based deployment. Specifically, YOLOv8_n decreases to an mAP of 16, YOLOv8_s decreases to 25, and YOLOv8_m decreases to 32. This reduction is consistent with the TPU deployment setting, in which the YOLOv8 models are executed with a reduced input size.

On Raspberry Pi 5 with AI HAT+, as shown in Fig. 5(c), YOLOv8_m again achieves the highest mAP at 44, while YOLOv8_s and YOLOv8_n record 40 and 32, respectively. SSD_v1 records 17, SSD_lite records 27, and the EfficientDet Lite models range from 17 to 24. Compared with the CPU-based Raspberry Pi results, the YOLOv8 models retain competitive accuracy on this platform, whereas EfficientDet Lite and SSD_v1 show lower mAP values.

For the NVIDIA platforms, Jetson Nano and Jetson Orin Nano exhibit the same accuracy results in our setup, as shown in Fig. 5(d). The YOLOv8 models follow a similar pattern to the Raspberry Pi platforms, with mAP values ranging from 31 to 44. In particular, YOLOv8_m achieves the highest mAP at 44, while YOLOv8_n and YOLOv8_s record 31 and 39, respectively. In contrast, the EfficientDet Lite and SSD models exhibit slightly lower mAP values than those observed on the Raspberry Pi platforms. Specifically, SSD_v1 records the lowest mAP at 16, SSD_lite records 27, and EfficientDet Lite0, Lite1, and Lite2 record 23, 28, and 32, respectively.

Key Insight 3

Accuracy is primarily model-dependent and remains largely consistent when the same model is deployed under similar processing conditions. However, noticeable variations arise when hardware platforms support different numerical precisions—for example, INT8-only execution on Raspberry Pis with TPU versus FP16 support on the Jetson Orin Nano.

D. Energy Consumption vs Inference Time

This subsection shows the trade-off between energy consumption per request and inference time across edge devices, which is important for energy-efficient, latency-sensitive deployment.

For the SSD models, as shown in Fig. 6(a) and Fig. 6(b), energy consumption per request and inference time exhibit a clear positive correlation across the evaluated devices. Raspberry Pi 3 lies at the least favorable end of the trade-off space, with both high latency and high energy consumption. In contrast, Raspberry Pi 4 with TPU, Raspberry Pi 5 with TPU, Jetson Nano, and Jetson Orin Nano occupy the most favorable region of the plots, indicating substantially improved efficiency. Among these platforms, Raspberry Pi 5 with TPU generally provides one of the lowest inference times, whereas Jetson Orin Nano achieves the lowest energy consumption, with Jetson Nano also showing competitive efficiency. Raspberry Pi 3 with TPU provides a noticeable improvement over the CPU-only Raspberry Pi platforms, while Raspberry Pi 5 with AI HAT+, Raspberry Pi 4 and Raspberry Pi 5 without accelerators remain in an intermediate region.

A similar overall relationship is observed for the EfficientDet Lite and YOLOv8 models, as shown in Fig. 6(c)–(h). In general, devices with lower inference time also tend to exhibit lower energy consumption per request, indicating a positive correlation between the two metrics across model families. Jetson Orin Nano consistently occupies the most favorable region of the trade-off space, while Jetson Nano and the accelerator-enabled Raspberry Pi platforms also achieve competitive results. Raspberry Pi 3 again shows the least favorable behavior, with both high latency and high energy consumption. Raspberry Pi 5 with AI HAT+ achieves competitive results, particularly for the YOLOv8 models, where it clearly outperforms the CPU-only Raspberry Pi platforms and provides a favorable compromise between inference time and energy consumption. At the same time, Raspberry Pi 5 occasionally deviates slightly from the overall trend for the YOLOv8 models relative to the fitted regression line.

Key Insight 4

Across the evaluated models, energy consumption per request and inference time are strongly correlated, indicating that faster execution often leads to lower request-level energy usage.

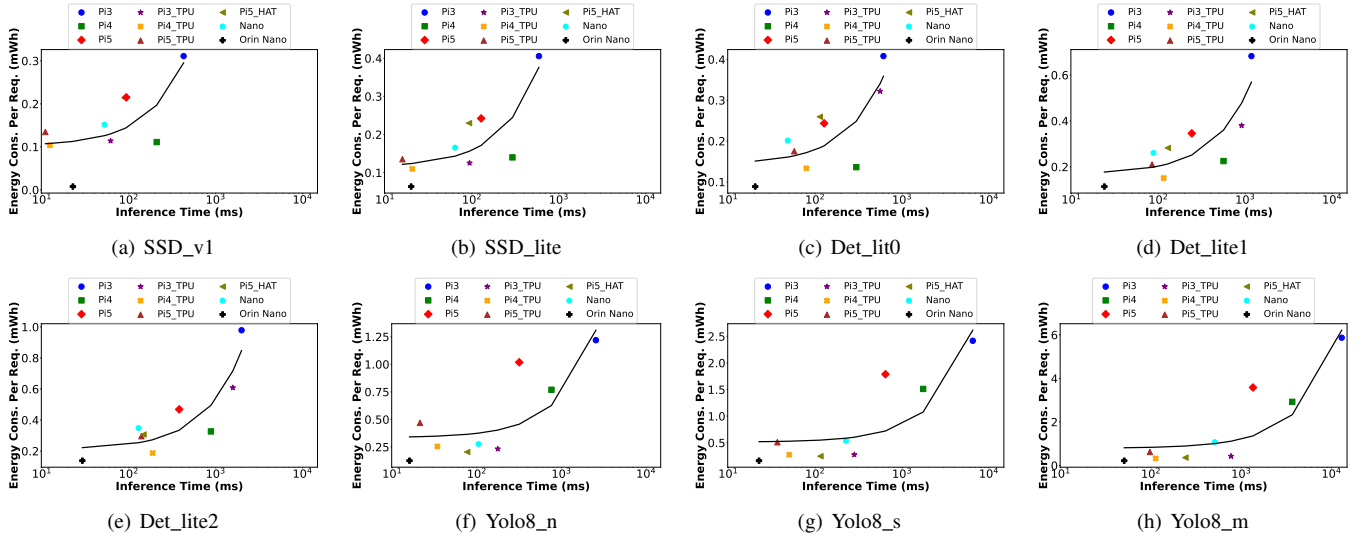

Fig. 6. Energy consumption per request (excluding base energy) versus inference time for various object detection models (A fitted linear regression line is shown, which appears curved due to the logarithmic scale of the inference time).

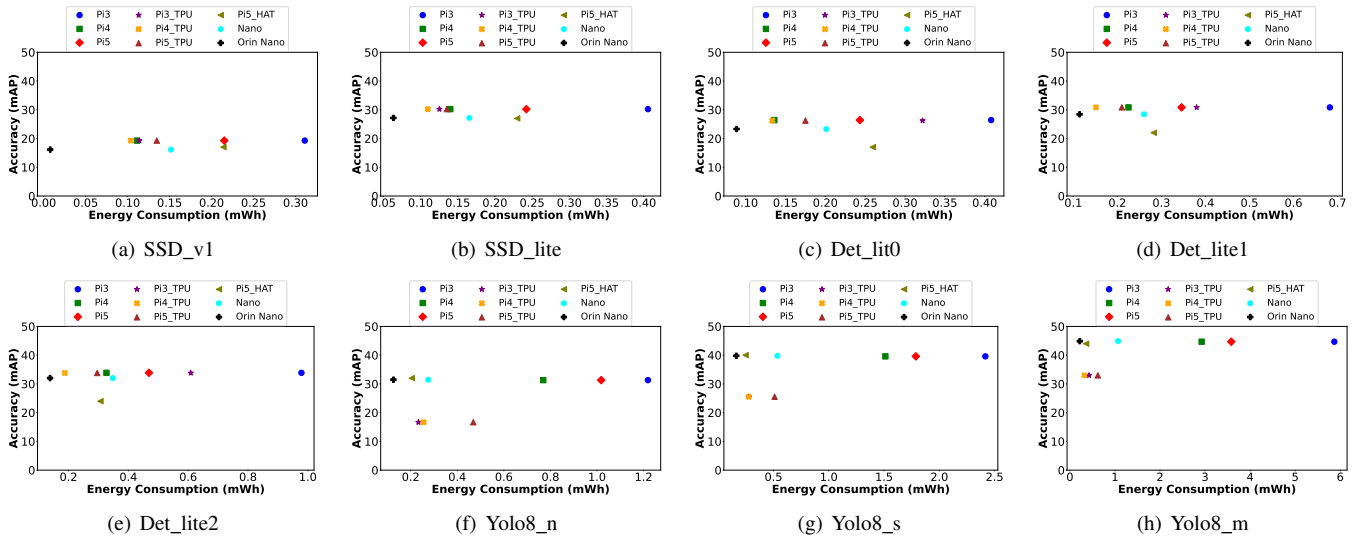

Fig. 7. Energy consumption per request (excluding base energy) versus accuracy for various object detection models

E. Energy Consumption vs Accuracy

This subsection highlights the trade-off between energy consumption per request and accuracy across the evaluated edge devices, which is important for improving energy efficiency while maintaining detection accuracy.

For the SSD and EfficientDet Lite models, as shown in Fig. 7(a)–(e), accuracy remains relatively stable across many of the evaluated devices, while the energy consumption per request varies substantially. In these model families, Jetson Orin Nano occupies one of the most favorable regions of the trade-off space because it achieves low energy consumption while maintaining competitive mAP values. In contrast, several CPU-only Raspberry Pi platforms, particularly Raspberry Pi 3 and Raspberry Pi 5, often require higher energy consumption without a clear accuracy advantage. The TPU-based Raspberry Pi platforms generally maintain comparable accuracy while reducing energy consumption, although some accuracy

reduction is visible for certain EfficientDet Lite configurations. Raspberry Pi 5 with AI HAT+ typically achieves lower energy consumption than CPU-only Raspberry Pi 5, but for several non-YOLO models this is accompanied by a modest reduction in accuracy.

For the YOLOv8 models, as shown in Fig. 7(f)–(h), accuracy remains stable across most non-TPU devices, while the TPU-based Raspberry Pi configurations show a noticeable reduction in mAP. This behavior is consistent with the reduced input size used for TPU-based deployment. In contrast, Raspberry Pi 5 with AI HAT+ preserves strong YOLOv8 accuracy while achieving substantially lower energy consumption than CPU-only Raspberry Pi 5. Jetson Orin Nano again occupies a highly favorable region of the plots, combining strong accuracy with low energy consumption. Overall, the CPU-only Raspberry Pi platforms tend to be less favorable because they often consume more energy without delivering a

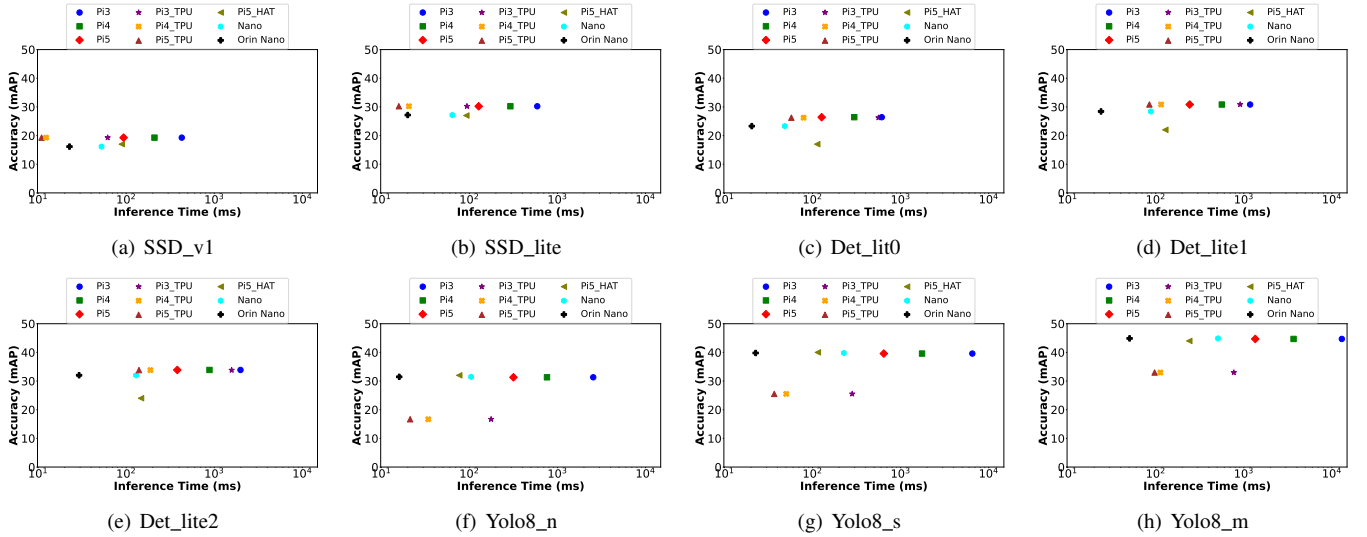

Fig. 8. Inference time versus accuracy for various object detection models

corresponding accuracy benefit.

Key Insight 5

There is a clear trade-off between accuracy and energy consumption per request, with higher accuracy generally requiring greater energy. However, some models achieve comparable accuracy with lower energy costs—for example, SSD Lite delivers similar performance to YOLOv8 Nano while consuming less energy per request.

F. Inference Time vs Accuracy

This subsection examines the trade-off between inference time and accuracy for the evaluated object detection models across edge devices, which is important for achieving low latency without substantially reducing detection quality.

For the SSD models, as shown in Fig. 8(a) and Fig. 8(b), accuracy remains largely stable across the evaluated devices, while inference time varies considerably. Raspberry Pi 5 with TPU achieves one of the lowest inference times among the Raspberry Pi platforms, whereas Raspberry Pi 3 exhibits the highest latency. Jetson Nano and Jetson Orin Nano also occupy favorable positions in the trade-off space because they combine low inference time with competitive accuracy. For the EfficientDet Lite models, shown in Fig. 8(c)–(e), a similar pattern is observed. The mAP values remain relatively stable across most devices, while the main difference lies in latency. In these plots, Jetson Orin Nano achieves the lowest inference times, while several CPU-only Raspberry Pi platforms occupy less favorable latency regions.

For the YOLOv8 models, as shown in Fig. 8(f)–(h), accuracy remains strong across most devices, but the TPU-based Raspberry Pi configurations exhibit a noticeable reduction in mAP because of the reduced input size used in that deployment setting. In contrast, Raspberry Pi 5 with AI HAT+ preserves competitive YOLOv8 accuracy while substantially reducing

inference time compared with CPU-only Raspberry Pi 5. Jetson Orin Nano provides the most favorable latency-accuracy trade-off for the YOLOv8 family, combining low inference time with high mAP values, while Raspberry Pi 5 with AI HAT+ also offers a highly competitive compromise. Overall, the CPU-only Raspberry Pi platforms tend to be less favorable because they often incur high latency without a corresponding accuracy advantage.

Key Insight 6

Across model families, the results show a broad trade-off between accuracy and inference time: lighter models generally achieve lower latency with lower accuracy, whereas heavier models provide higher accuracy at the cost of increased inference time. Across devices, however, this trade-off is less strict, as some accelerator-enabled platforms preserve similar accuracy for the same model while substantially reducing inference time.

G. Energy Consumption vs Inference Time vs Accuracy

This subsection summarizes the overall performance of the evaluated object detection models across the edge devices. Fig. 9 jointly illustrates the trade-off among energy consumption, inference time, and accuracy for each model family.

For the SSD models, as shown in Fig. 9(a) and Fig. 9(b), Raspberry Pi 5 with TPU, Raspberry Pi 4 with TPU, Jetson Nano, and Orin Nano occupy the most favorable region of the trade-off space. Among these, Raspberry Pi 5 with TPU and Raspberry Pi 4 with TPU are particularly attractive because they combine very low energy consumption and inference time with the same accuracy level observed on the Raspberry Pi platforms. In contrast, Jetson Nano and Orin Nano achieve similarly strong energy and latency performance, but with a slight reduction in accuracy for SSD models.

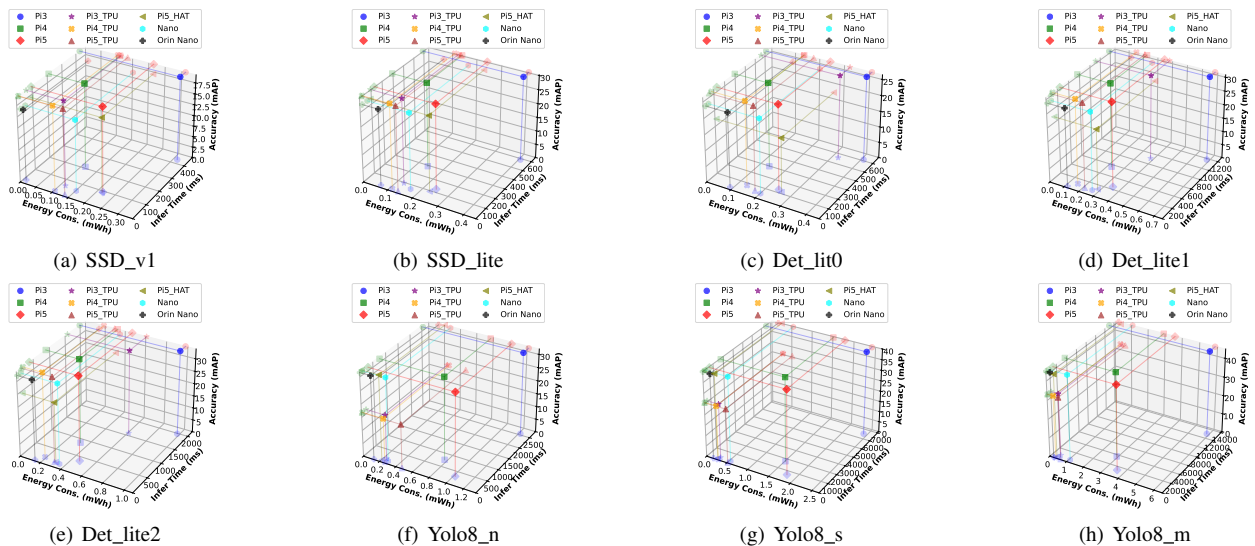

Fig. 9. Energy consumption per request (excluding base energy) versus inference time versus accuracy for various object detection models

For the EfficientDet Lite models, shown in Fig. 9(c)–(e), Jetson Nano and Orin Nano provide the most favorable overall trade-off, combining low energy consumption and low inference time with only a small decrease in mAP relative to the Raspberry Pi-based platforms. The TPU-enabled Raspberry Pi devices also provide strong latency and energy improvements, but the NVIDIA platforms remain more favorable overall in this model family. Raspberry Pi 3 consistently occupies the least favorable region because it combines higher energy consumption and longer inference time without offering an accuracy advantage.

For the YOLOv8 models, as shown in Fig. 9(f)–(h), Jetson Orin Nano and Pi 5 with AI HAT+ are the most suitable choices among the evaluated devices, providing the best overall balance among energy consumption, inference time, and accuracy. Raspberry Pi 5 with AI HAT+ also emerges as a strong option, particularly because it preserves competitive YOLOv8 accuracy while substantially improving both energy consumption and inference time relative to CPU-only Raspberry Pi 5. In contrast, TPU-based Raspberry Pi platforms achieve excellent latency and energy efficiency for YOLOv8, but their reduced accuracy makes them less attractive when all three metrics are considered jointly.

Key Insight 7

The 3D analysis shows that the suitability of an object detection model depends on both the model family and the edge device type. In our experiments, Pi4 and Pi5 with TPU are most favorable for SSD, whereas Orin Nano is most favorable for EfficientDet Lite and YOLOv8.

H. Object-Count-Based Analysis

This subsection investigates how object count affects the performance of the evaluated object detection models. In par-

ticular, it examines whether the number of objects in an image influences accuracy, inference time, and energy consumption.

In our experiments, meaningful variation is observed mainly in accuracy, whereas inference time and energy consumption remain largely unchanged. Therefore, the following discussion focuses on accuracy. To this end, the evaluation images are divided into five object-count groups: images containing 0, 1, 2, 3, and 4 or more objects. Images with 0 annotated objects form a special case, for which mAP is not particularly informative and is reported as 0 under our evaluation pipeline. Accordingly, the following discussion focuses primarily on the relative accuracy trends for images containing 1, 2, 3, and 4 or more objects.

As shown in Fig. 10, all platform categories exhibit the same overall trend: mAP is highest for images containing one object and decreases progressively as object count increases. Across the evaluated settings, YOLOv8_m consistently achieves the strongest accuracy, followed by YOLOv8_s and YOLOv8_n, while EfficientDet Lite2 is the best performing variant within the EfficientDet family and SSD_lite consistently outperforms SSD_v1. Compared with the Raspberry Pi devices in Fig. 10(a), the Raspberry Pis with TPU in Fig. 10(b) preserve the accuracy of EfficientDet Lite and SSD relatively well, but introduce a clear accuracy reduction for YOLOv8. In Fig. 10(c), Raspberry Pi 5 with AI HAT+ preserves YOLOv8 accuracy much more effectively than the TPU-based setting, particularly for images with higher object counts, although EfficientDet Lite and SSD show lower accuracy than on the Raspberry Pi devices. In Fig. 10(d), the NVIDIA platforms remain highly competitive overall, preserving strong YOLOv8 performance for more complex scenes while showing slightly lower mAP for EfficientDet Lite and SSD than the Raspberry Pi devices.

To further examine the effect of scene complexity, we analyze model performance across different object counts. For images containing one or two objects, the models show relatively small performance differences, and in some cases,

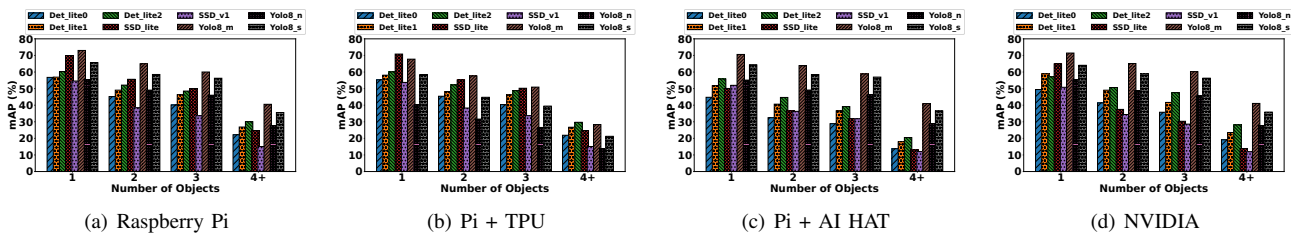

Fig. 10. Object-count-based mAP results for the evaluated platform categories.

SSDLite achieves accuracy comparable to heavier models such as YOLOv8m. However, as the number of objects increases to four or more, SSD and SSDLite exhibit the lowest accuracy, while YOLOv8 achieves the highest among the evaluated models.

Key Insight 8

The object-count-based analysis shows that on simpler images, lightweight models achieve accuracy close to heavier models while requiring less energy and lower inference time, whereas the accuracy gap becomes more pronounced as object count increases.

IV. RELATED WORK

This section reviews the most relevant studies on object detection for edge computing devices and positions our work within the existing literature. Table II provides a structured comparison of prior studies across hardware platforms, model families, and evaluation criteria. Although prior work has reported valuable results on selected models and platforms, a unified evaluation across multiple detector families, heterogeneous edge devices, and complementary metrics remains limited.

Existing studies have explored edge-based object detection from different perspectives. Cantero et al. [7], Kamath and Renuka [8], Chen et al. [9], and Puchtler and Peinl [10] investigate the deployment of SSD, EfficientDet, or SSD-MobileNet variants on embedded devices, focusing mainly on inference speed, quantization, accuracy, or accelerator-level benchmarking within a limited set of models and hardware platforms. Kang and Somtham [11], Feng et al. [12], Santos et al. [13], Baller et al. [14], Bulut et al. [15], and Appavu [16] benchmark edge devices using object detection models and report metrics such as latency, FPS, accuracy, memory usage, hardware utilization, or energy consumption, but their analyses are typically restricted to YOLO-based models or a narrow set of devices.

More recent work broadens the evaluated models or hardware, but important gaps remain. Zagitov et al. [17], Galliera and Suri [18], Magalhães et al. [19], and Lema et al. [20] compare a wider range of detectors or accelerators, yet they do not cover the same diverse range of edge devices evaluated in our study. Shakya et al. [21], Meimetis et al. [22], and Suchý and Turčaník [23] provide recent deployment-oriented analyses of lightweight YOLO models, UAV-oriented edge detectors, and large YOLOv8/RT-DETR models, respectively.

In addition, Mittal [24] and Zhai et al. [25] survey lightweight object detection and edge deployment for visual detection, covering detector architectures, optimization methods, deployment frameworks, and edge hardware platforms. However, these works either focus on specific detector families or provide surveys rather than a unified experimental comparison.

Overall, existing studies do not provide a unified comparison across multiple detector families, heterogeneous edge devices, and complementary performance dimensions. Most focus on a narrow set of models or platforms, often emphasize latency or accuracy alone, and only inconsistently consider energy consumption. In addition, the effect of scene complexity on model behavior remains largely underexplored in edge benchmarking. In contrast, our study jointly evaluates SSD, EfficientDet Lite, and YOLOv8 across CPU-, TPU-, NPU-, and GPU-based edge devices, while systematically analyzing inference time, energy consumption, accuracy, and object-count-based behavior in a single experimental framework.

V. CONCLUSIONS AND FUTURE DIRECTION

In this paper, we benchmarked deep learning object detection models across heterogeneous edge devices, including YOLOv8, EfficientDet Lite, and SSD variants deployed on Raspberry Pi platforms (with and without TPU and NPU acceleration) and NVIDIA Jetson devices. The evaluation considered accuracy (mAP), inference time, and energy consumption, together with an analysis of how accuracy varies with scene complexity.

The results highlight clear trade-offs across model-device combinations. Lightweight models such as SSD MobileNet V1 achieve the lowest latency and energy consumption but at the cost of reduced accuracy, whereas higher-capacity models such as YOLOv8 Medium deliver the highest accuracy with increased computational and energy demands. TPU-accelerated Raspberry Pi devices significantly improve the efficiency of SSD and EfficientDet Lite while preserving their accuracy, but negatively affect YOLOv8 performance. Overall, Jetson Orin Nano provides the most favorable balance between accuracy and energy consumption across most model families.

The object-count-based analysis further shows that model accuracy is strongly influenced by scene complexity: performance differences are small for simple scenes but become more pronounced as the number of objects increases, highlighting the importance of considering input characteristics in edge deployment decisions.

These findings demonstrate that selecting an appropriate model-device combination depends not only on accuracy or

TABLE II
COMPARISON OF EXISTING STUDIES ACROSS EDGE DEVICES, MODELS, AND EVALUATION CRITERIA.

Study	CPU	TPU	GPU	NPU	YOLOv8	EfficientDet	SSD	Infer Time	Energy	mAP	Object-Count-Based
Cantero et al. [7]	✓	✓				✓	✓	✓			
Kamath and Renuka [8]	✓					✓		✓		✓	
Kang and Somtham [11]		✓	✓				✓	✓	✓	✓	
Baller et al. [14]	✓	✓	✓				✓	✓	✓	✓	
Bulut et al. [15]			✓				✓	✓	✓	✓	
Chen et al. [9]	✓						✓	✓		✓	
Zagitov et al. [17]	✓		✓		✓	✓	✓	✓		✓	
Galliera and Suri [18]		✓	✓				✓	✓		✓	
Magalhães et al. [19]		✓	✓				✓	✓	✓	✓	
Lema et al. [20]		✓	✓				✓	✓	✓	✓	
Feng et al. [12]	✓		✓				✓	✓	✓	✓	
Appavu [16]	✓	✓	✓				✓	✓	✓	✓	
Santos et al. [13]	✓		✓				✓	✓	✓	✓	
Meimetis et al. [22]			✓				✓	✓	✓	✓	
Puchtler and Peinl [10]	✓	✓	✓				✓	✓	✓	✓	
Suchý and Turčaník [23]	✓		✓	✓	✓		✓	✓	✓	✓	
Shakya et al. [21]			✓		✓		✓	✓	✓	✓	
Mittal [24]							✓	✓	✓	✓	
Zhai et al. [25]							✓	✓	✓	✓	
Our Work	✓	✓	✓	✓	✓	✓	✓	✓	✓	✓	✓

latency requirements, but also on energy constraints and scene complexity, which are critical for practical edge and IoT deployments.

Future work will investigate how reduced precision and quantization techniques, such as FP16 and INT8, affect accuracy, latency, and energy consumption across heterogeneous edge devices. It will also extend the image content analysis beyond object count by considering additional factors, such as the object classes present in the scene, to better understand how scene characteristics influence model behavior.

REFERENCES

- [1] A. Balasubramaniam and S. Pasricha, "Object detection in autonomous vehicles: Status and open challenges," *arXiv preprint arXiv:2201.07706*, 2022.
- [2] J. Redmon, S. Divvala, R. Girshick, and A. Farhadi, "You only look once: Unified, real-time object detection," in *Proceedings of the IEEE conference on computer vision and pattern recognition*, pp. 779–788, 2016.
- [3] W. Liu, D. Anguelov, D. Erhan, C. Szegedy, S. Reed, C.-Y. Fu, and A. C. Berg, "Ssd: Single shot multibox detector," in *Computer Vision–ECCV 2016: 14th European Conference, Amsterdam, The Netherlands, October 11–14, 2016, Proceedings, Part I 14*, pp. 21–37, Springer, 2016.
- [4] M. Tan, R. Pang, and Q. V. Le, "Efficientdet: Scalable and efficient object detection," in *Proceedings of the IEEE/CVF conference on computer vision and pattern recognition*, pp. 10781–10790, 2020.
- [5] G. Jocher, A. Chaurasia, and J. Qiu, "Ultralytics yolov8," 2023.
- [6] T.-Y. Lin, M. Maire, S. Belongie, J. Hays, P. Perona, D. Ramanan, P. Dollár, and C. L. Zitnick, "Microsoft coco: Common objects in context," in *Computer Vision–ECCV 2014: 13th European Conference, Zurich, Switzerland, September 6–12, 2014, Proceedings, Part V 13*, pp. 740–755, Springer, 2014.
- [7] D. Cantero, I. Esnaola-Gonzalez, J. Miguel-Alonso, and E. Jauregi, "Benchmarking object detection deep learning models in embedded devices," *Sensors*, vol. 22, no. 11, p. 4205, 2022.
- [8] V. Kamath and A. Renuka, "Performance analysis of the pretrained efficientdet for real-time object detection on raspberry pi," in *2021 International Conference on Circuits, Controls and Communications (CCUBE)*, pp. 1–6, IEEE, 2021.
- [9] C.-W. Chen, S.-J. Ruan, C.-H. Lin, and C.-C. Hung, "Performance evaluation of edge computing-based deep learning object detection," in *Proceedings of the 2018 VII International Conference on Network, Communication and Computing*, pp. 40–43, 2018.
- [10] P. Puchtler and R. Peinl, "Evaluation of deep learning accelerators for object detection at the edge," in *German Conference on Artificial Intelligence (Künstliche Intelligenz)*, pp. 320–326, Springer, 2020.
- [11] P. Kang and A. Somtham, "An evaluation of modern accelerator-based edge devices for object detection applications," *Mathematics*, vol. 10, no. 22, p. 4299, 2022.
- [12] H. Feng, G. Mu, S. Zhong, P. Zhang, and T. Yuan, "Benchmark analysis of yolo performance on edge intelligence devices," *Cryptography*, vol. 6, no. 2, p. 16, 2022.
- [13] R. C. C. d. M. Santos, M. Coelho, and R. Oliveira, "Real-time object detection performance analysis using yolov7 on edge devices," *IEEE Latin America Transactions*, vol. 22, no. 10, pp. 799–805, 2024.
- [14] S. P. Baller, A. Jindal, M. Chadha, and M. Gerndt, "Deepedgebench: Benchmarking deep neural networks on edge devices," in *2021 IEEE International Conference on Cloud Engineering (IC2E)*, pp. 20–30, IEEE, 2021.
- [15] A. Bulut, F. Ozdemir, Y. S. Bostanci, and M. Soyuturk, "Performance evaluation of recent object detection models for traffic safety applications on edge," in *Proceedings of the 2023 5th International Conference on Image Processing and Machine Vision*, pp. 1–6, 2023.
- [16] N. Appavu, "Analysing the effect of edge-optimized deep learning models on improving low-powered iot devices real-time object detection," in *2025 9th International Conference on Inventive Systems and Control (ICISC)*, pp. 1663–1669, IEEE, 2025.
- [17] A. Zagitov, E. Chebotareva, A. Toschev, and E. Magid, "Comparative analysis of neural network models performance on low-power devices for a real-time object detection task," *Computer*, vol. 48, no. 2, 2024.
- [18] R. Galliera and N. Suri, "Object detection at the edge: Off-the-shelf deep learning capable devices and accelerators," *Procedia Computer Science*, vol. 205, pp. 239–248, 2022.
- [19] S. C. Magalhães, F. N. dos Santos, P. Machado, A. P. Moreira, and J. Dias, "Benchmarking edge computing devices for grape bunches and trunks detection using accelerated object detection single shot multibox deep learning models," *Engineering Applications of Artificial Intelligence*, vol. 117, p. 105604, 2023.
- [20] D. G. Lema, R. Usamentiaga, and D. F. García, "Quantitative comparison and performance evaluation of deep learning-based object detection models on edge computing devices," *Integration*, vol. 95, p. 102127, 2024.
- [21] B. Shakya, O. El-Gayar, J. Kaabi, and K. M. Ahmed, "Small-object detection at the edge: A pareto-efficient benchmark of lightweight yolo models on uav and overhead datasets," *IEEE Access*, vol. 14, pp. 528–548, 2025.
- [22] D. Meimetis, I. Daramouskas, N. Patrinooulou, V. Lappas, and V. Kostopoulos, "Comparative analysis of object detection models for edge devices in uav swarms," *Machines*, vol. 13, no. 8, p. 684, 2025.
- [23] I. Suchý and M. Turčaník, "Review of large yolov8 and rt-detr energy efficiency on edge devices for real-time detection," *Scientific Reports*, 2026.
- [24] P. Mittal, "A comprehensive survey of deep learning-based lightweight object detection models for edge devices," *Artificial Intelligence Review*, vol. 57, no. 9, 2024.
- [25] H. Zhai, J. Du, Y. Ai, and T. Hu, "Edge deployment of deep networks for visual detection: a review," *IEEE Sensors Journal*, vol. 25, no. 11, pp. 18662–18683, 2024.