

Theory of optical spinpolarization of axial divacancy and nitrogen-vacancy defects in 4H-SiC

Guodong Bian and Gergő Thiering

*HUN-REN Wigner Research Centre for Physics,
Institute for Solid State Physics and Optics, PO Box 49, H-1525, Budapest, Hungary*

Ádám Gali*

*HUN-REN Wigner Research Centre for Physics,
Institute for Solid State Physics and Optics, PO Box 49, H-1525, Budapest, Hungary and
Department of Atomic Physics, Institute of Physics,
Budapest University of Technology and Economics, Műegyetem rakpart 3., 1111 Budapest, Hungary
(Dated: September 17, 2024)*

The neutral divacancy and the negatively charged nitrogen-vacancy defects in 4H-silicon carbide (SiC) are two of the most prominent candidates for functioning as room-temperature quantum bits (qubits) with telecommunication-wavelength emission. Nonetheless, the pivotal role of electron-phonon coupling in the spinpolarization loop is still unrevealed. In this work, we theoretically investigate the microscopic magneto-optical properties and spin-dependent optical loops utilizing the first-principles calculations. First, we quantitatively demonstrate the electronic level structure, assisted by symmetry analysis. Moreover, the fine interactions, including spin-orbit coupling and spin-spin interaction, are fully characterized to provide versatile qubit functional parameters. Subsequently, we explore the electron-phonon coupling, encompassing dynamics- and pseudo-Jahn–Teller effects in the intersystem crossing transition. In addition, we analyze the photoluminescence PL lifetime based on the major transition rates in the optical spinpolarization loop. We compare two promising qubits with similar electronic properties, but their respective rates differ substantially. Finally, we detail the threshold of ODMR contrast for further optimization of the qubit operation. This work not only reveals the mechanism underlying the optical spinpolarization but also proposes productive avenues for optimizing quantum information processing tasks based on the ODMR protocol.

I. INTRODUCTION

Optically addressable defect spins in solids have attracted significant research interest serving as promising quantum bit (qubit) candidates for emerging quantum information science in the coming noisy intermediate-scale quantum (NISQ) era [1–5]. Except for the negatively charged nitrogen-vacancy center in diamond (NV-diamond) well-understood both in theory [6–9] and experiments [10–13], defective silicon carbide (SiC) systems, especially the 4H-SiC polytype [14–43], have attracted an ever growing attention with leveraging an advanced artificial growth and microfabrication techniques of the host SiC crystal. The 4H-SiC is one of the most common polytypes of SiC crystals, with cubic (k) and hexagonal (h) Si-C bilayers that are stacked by repeating the pattern "ABCB" [see Fig. 1(a)]. Hence, for the neutral divacancy $V_{\text{Si}}V_{\text{C}}^0$ (abbreviated as VV^0) configuration, there are totally four distinct forms: two axial configurations (hh , kk) and two basal configurations (hk and kh). hh and kk configurations have high C_{3v} symmetry and are named PL1 and PL2 centers, respectively [14]. The other two possess the C_{1h} symmetry and are labeled as PL3 and PL4 centers [15]. All four configurations are named after the four photoluminescence (PL) peaks of

UD-2 [16, 17] that have $S = 1$ ground state spin [18] with zero-phonon line (ZPL) emission at 1132, 1131, 1108, and 1078 nm [22] for PL1 to PL4 center, respectively. The combination of substitutional nitrogen (N_{C}) and adjacent Si-vacancy (V_{Si}), i.e., the $N_{\text{C}}V_{\text{Si}}$ center (abbreviated as NV center), also has four configurations. After capturing an electron from the crystalline environment, the NV^- center in 4H-SiC is formed, of which ZPL peaks yield at 1241, 1242, 1223, and 1180 nm [20] that are labeled by PLX1 to PLX4 similar to the labels of divacancy color centers in 4H-SiC. The two hh -axial centers among the four configurations (hh , kk , hk and kh), i.e., the PL1 and PLX1 centers [see Fig. 1(a)], are often favored for their potential in implementing quantum information processing applications and leveraging advantages such as coherent control of spins persist up to elevated temperatures, even room temperature [14, 21–23] and fluorescence emission around the telecommunication wavelengths [19, 20]. Although they have been extensively investigated experimentally [14, 16, 19, 21–28, 31–34, 37, 38, 44, 45] and theoretically [15, 31, 36, 46], the mechanism underlying the optical spinpolarization has remained elusive, posing a significant obstacle in implementing quantum information tasks based on the two centers.

In this work, we first present the electronic structure and the resulting multiplet basis wavefunctions, which are fundamental to the entire research. Subsequently, we investigate the electronic interaction, encompassing zero-field splitting (ZFS) and spin-orbit coupling (SOC),

* gali.adam@wigner.hun-ren.hu

to elucidate the fine electronic structure. Moreover, we demonstrate that spin-conserving direct transitions involve radiative and direct non-radiative processes between excited and ground-state triplets. We conduct a microscopic examination of the non-radiative spin-dependent intersystem crossing (ISC) transition between states with different spin-multiplicities. Based on the resulting parameters, we assemble a spinpolarization optical loop with five key energy levels and the major transitions that occur between them and investigate the optimal optically detected magnetic resonance (ODMR) contrast.

II. METHODOLOGY

We employ the Vienna *Ab-initio* Simulation Package (VASP 5.4.1) code in the framework of density functional theory (DFT) for implanting all atomistic simulations [47–50]. The Heyd–Scuzeria–Ernzerhof (HSE) hybrid functional with HSE06 parameters [51–53] within the DFT technique is applied to reproduce accurate energy band and related information. The PL1 and PLX1 centers are modeled in a standard 576-atom 4H-SiC supercell ($6 \times 6 \times 2$) with a Γ -point sampling of the Brillouin zone. The optimized a and c lattice constants are 18.43 Å and 20.10 Å, respectively. The cutoff energy is set as 420 eV. The atomic configurations are relaxed with the total energy and force thresholds of 1×10^{-4} eV and 0.01 eV/Å. The excited state $|^3E\rangle$ is determined using the Δ SCF method [54], which involves promoting an electron from the a_1 orbital to the unoccupied e orbital in the fundamental band gap, as illustrated in Fig. 1(b). Because of that, the conventional Kohn–Sham (KS) DFT cannot adequately describe the $|^1A_1\rangle$ singlet state because of the high correlation between the two degenerate e orbitals. In this work, the energy and geometry of $|^1A_1\rangle$ are simulated by spinpolarized singlet occupation of the e_x orbital [55]. The calculation of SOC parameters employs the noncollinear approach implemented in VASP [56]. The ZFS parameters are calculated by employing the VASP projector-augmented-wave implementation of electron spin-spin interaction [57] as implemented by Martijn Marsman.

III. ELECTRONIC PROPERTIES

It is imperative to fully characterize the electronic properties of the spin system of the color center in order to develop quantum information processing applications. First, we examine the electronic multiplet wavefunctions that belong to variable irreducible representation (IR) spaces to lay the foundation for the entire research. We also obtain the electronic structure through first-principles calculations. Additionally, we investigate two types of fine electronic interactions: zero-field splitting and spin-orbit coupling, which jointly determine the

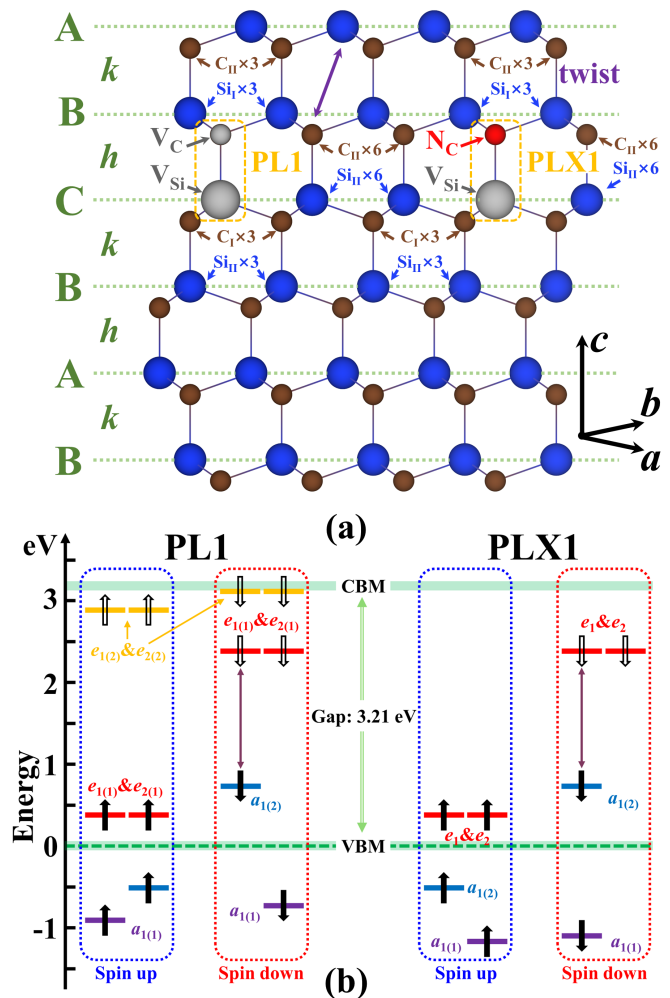

FIG. 1. (a) Geometry of the PL1 (left) and PLX1 (right) centers. The purple double arrow indicates a 60-degree twist. The arrow combination in the lower right corner is the lattice coordinate system, and a , b , and c represent the crystal axis. The Si and C with subscripts “I” and “II” are used to label the hyperfine interactions, which will be discussed in the following sections. (b) Hierarchy sketch of the electronic structures for PL1 (left) and PLX1 (right) centers. The horizontal short line is the KS energy level; the solid arrows on it represent occupied electrons, and the hollow arrows represent holes. The gap is the calculated energy band gap of 4H-SiC. CBM (VBM) is the conduction band minimum (valence band maximum). The labels of the levels can be found in the main text. The double arrow between a_1 and e levels represents the nature of the transition between ground and excited states.

fine structure. ZFS provides important parameters for the ODMR protocol, while SOC induces transitions, particularly facilitating intersystem crossing (ISC) via its parallel and perpendicular components. Besides, the hyperfine interaction parameters from isotopes proximate to the core of the point defect are also discussed.

A. Electronic multiplet wavefunctions

Firstly, we investigate the electronic multiplet wavefunctions using the projection method in group theory [7, 9, 58]. For the PL1 center, there are six dangling bonds in the divacancy [see Fig. 1(a)], which contributes sp^3 hybrid atomic orbitals to the initial basis. The initial basis vector is $\{s_1, s_2, s_2, c_1, c_2, c_3\}$, where s_i and c_i are atomic orbitals of Si and C atoms, respectively. Under the framework of C_{3v} symmetry, the projection method is employed to construct the symmetrical molecular orbitals (MOs) belonging to variable IR spaces (A_1 , A_2 , and E for C_{3v} symmetry) by linear combinations of the atomic orbitals (LCAOs). Ignoring orbital overlap integrals, all the resulting projected MOs are

$$a_{1(1)} = \frac{s_1 + s_2 + s_3}{\sqrt{3}}, \quad a_{1(2)} = \frac{c_1 + c_2 + c_3}{\sqrt{3}}, \quad (1a)$$

$$e_{1(1)} = \frac{2c_1 - c_2 - c_3}{\sqrt{6}}, \quad e_{1(2)} = \frac{2s_1 - s_2 - s_3}{\sqrt{6}}, \quad (1b)$$

$$e_{2(1)} = \frac{c_2 - c_3}{\sqrt{2}}, \quad e_{2(2)} = \frac{s_2 - s_3}{\sqrt{2}}, \quad (1c)$$

where $a_{1(1)}$ and $a_{1(2)}$ are non-degenerate and belong to A_1 IR; $e_{1(1)}$ and $e_{2(1)}$ are degenerate, and so are $e_{1(2)}$ and $e_{2(2)}$. All e MOs belong to the E IR. $\{a_{1(1)}, a_{1(2)}, e_{1(1)}, e_{2(1)}, e_{1(2)}, e_{2(2)}\}$ is a set of symmetric basis vectors of PL1 center. Similarly, based on the initial basis of the PLX1 center $\{n, c_1, c_2, c_3\}$, the resulting projected MOs of the PLX1 center in variable IR spaces are

$$a_{1(1)} = n, \quad (2a)$$

$$a_{1(2)} = \frac{c_1 + c_2 + c_3}{\sqrt{3}}, \quad (2b)$$

$$e_1 = \frac{2c_1 - c_2 - c_3}{\sqrt{6}}, \quad e_2 = \frac{c_2 - c_3}{\sqrt{2}} \quad (2c)$$

where n is the nitrogen atom's sp^3 orbital, c is from the same site as in PL1 center. The electron singlet basis of PLX1 center $\{a_{1(1)}, a_{1(2)}, e_1, e_2\}$. Although the LCAO method will not accurately describe the orbitals [7], the DFT-HSE06 calculations show the character of this analysis with accurate energy ordering and contributions of every atomic orbital to highly localized states. Both color centers localize six unpaired electrons, but the sources of the electrons are slightly different. In the PL1 center, the three silicon and three carbon nearest neighbor atoms around the divacancy contribute one electron each. In the PLX1 center, the substitutional N contributes two electrons, the three nearest neighbor carbon atoms contribute one electron each, and one electron is captured from the environment. Combining the projection MOs with the first principles calculation KS levels, the energy level diagram is sketched in Fig. 1(b). The calculated band gap is 3.21 eV, close to the experimental value of 3.23 eV [59].

From Fig. 1(b), for both two centers, the $a_{1(1)}$ level is deeply submerged in the valence band, which means

that it will be very difficult to promote electrons from it to other levels with higher energy. Besides, for the PL1 center, the two unoccupied $e_{1(2)}$ and $e_{2(2)}$ are also difficult to be occupied by electrons from lower levels. Hence, in this work, we focus only on three energy levels close to each other in the band gap: $a_{1(2)}$ and e_x ($e_{1(1)}$ of PL1, e_1 of PLX1), e_y ($e_{2(1)}$ of PL1, e_2 of PLX1). From Eq. (1) and Eq. (2), all selected levels are contributed primarily by dangling bonds of C atoms proximate to the centers. The basis vector of $\{a, e_x, e_y\}$ shows the $\{z, x, y\}$ space properties in the color center coordinate system. Fig. 1(b) also shows the total spin $S = 1$ of both centers. Meanwhile, there are a total of four electrons occupying the a , e_x , and e_y levels, leaving two holes. The multi-electron picture can be equivalently transformed into a double-hole picture, which will significantly simplify the analysis. Starting from the $\{a, e_x, e_y\}$ basis within the hole notation, all two-hole orbital basis functions $|\varphi\rangle$ are represented as following Eq.(3) to Eq.(12).

All the ground states possess (ee) configuration. The presentations of triplet $|^3A_2\rangle$ is

$$\left. \begin{array}{l} |^3A_2^+\rangle \\ |^3A_2^0\rangle \\ |^3A_2^-\rangle \end{array} \right\} = \frac{1}{2}(|e_+e_- - |e_-e_+\rangle) \otimes \left\{ \begin{array}{l} \sqrt{2}|\uparrow\uparrow\rangle \\ |\uparrow\downarrow\rangle + |\downarrow\uparrow\rangle \\ \sqrt{2}|\downarrow\downarrow\rangle \end{array} \right\}, \quad (3)$$

where the label $\{+, 0, -\}$ means the $\{|1\rangle, |0\rangle, |-1\rangle\}$ spin sub-states. $|e_{\pm}\rangle = \mp \frac{1}{\sqrt{2}}(|e_x\rangle \pm i|e_y\rangle)$ is a complex combination of the real orbitals e_x and e_y . Besides, in the (ee) configuration, there are three other singlet ground states with a spin basis function of $(|\uparrow\downarrow\rangle - |\downarrow\uparrow\rangle)$, the expressions for double-degenerate $|^1E_{\mp}\rangle$ and non-degenerate $|^1A_1\rangle$

$$|^1E_{\mp}\rangle = \left. \begin{array}{l} |e_+e_+\rangle \\ |e_-e_-\rangle \end{array} \right\} \otimes \frac{1}{\sqrt{2}}(|\uparrow\downarrow\rangle - |\downarrow\uparrow\rangle), \quad (4)$$

$$|^1A_1\rangle = (|e_+e_- + |e_-e_+\rangle) \otimes \frac{1}{2}(|\uparrow\downarrow\rangle - |\downarrow\uparrow\rangle). \quad (5)$$

To lay the foundation for the following discussion of the lower branch ISC transition, we introduce a new set of basis vectors $\{|xx\rangle, |xy\rangle, |yy\rangle\}$ as

$$\left. \begin{array}{l} |xx\rangle = |e_xe_x\rangle \\ |xy\rangle = \frac{1}{\sqrt{2}}(|e_xe_y\rangle + |e_ye_x\rangle) \\ |yy\rangle = |e_ye_y\rangle \end{array} \right\} \otimes \frac{1}{\sqrt{2}}(|\uparrow\downarrow\rangle - |\downarrow\uparrow\rangle), \quad (6)$$

to represent the three singlets $|^1E_{1,2}\rangle$ and $|^1A_1\rangle$ of (ee) configuration as

$$|^1E_x\rangle = \frac{1}{\sqrt{2}}(|xx\rangle - |yy\rangle), \quad (7)$$

$$|^1E_y\rangle = |xy\rangle, \quad (8)$$

$$|^1A_1\rangle = \frac{1}{\sqrt{2}}(|xx\rangle + |yy\rangle). \quad (9)$$

When promoting one electron of spin-minority channel from the occupied in-gap a level to the unfilled in-gap e level, the electronic configuration becomes (ae) , which corresponds to the first excited states with basis functions of $|^3E_{\pm}\rangle$ and $|E'_{\pm}\rangle$

$$|^3E_{\pm}\rangle = \begin{Bmatrix} |e_+a\rangle - |ae_+\rangle \\ |e_-a\rangle - |ae_-\rangle \end{Bmatrix} \otimes \frac{1}{2} \begin{Bmatrix} \sqrt{2}|\uparrow\uparrow\rangle \\ |\uparrow\downarrow\rangle + |\downarrow\uparrow\rangle \\ \sqrt{2}|\downarrow\downarrow\rangle \end{Bmatrix}, \quad (10)$$

$$|^1E'_{\pm}\rangle = \begin{Bmatrix} |e_+a\rangle + |ae_+\rangle \\ |e_-a\rangle + |ae_-\rangle \end{Bmatrix} \otimes \frac{1}{2}(|\uparrow\downarrow\rangle - |\downarrow\uparrow\rangle). \quad (11)$$

$|^3E_{\pm}\rangle$ is a multiple degenerate state, which can be divided further into $|E_{1,2}\rangle$, $|E_{x,y}\rangle$, and $|A_{1,2}\rangle$ states [see Fig. 2]. $|E'_{\pm}\rangle$ is a double-degenerate singlet state. All states of the first excited states are Jahn–Teller (JT) unstable because of the unequal occupation of electrons in the two degenerate e orbitals. When promoting two electrons from a to e orbital, the a orbital will be empty, and two e orbitals will be fully occupied. This is the second excited state with the highest energy and is expressed as

$$|^1A'_1\rangle = |aa\rangle \otimes \frac{1}{\sqrt{2}}(|\uparrow\downarrow\rangle - |\downarrow\uparrow\rangle). \quad (12)$$

B. SOC and ZFS

The SOC can be divided into axial and transverse components because of the possessed C_{3v} symmetry. The axial component dominates the fine modification of the energy levels, especially in the excited states [7–9], which can be determined by the photoluminescence excitation (PLE) measurement at low temperatures [26]. The transverse component induces spin-dependent ISC between states with different spin multiplicities, where ISC is one of the most critical prerequisites in spin-dependent fluorescence dynamics. For the two centers, the SOC Hamiltonian \hat{H}_{SOC} can be written in terms of the angular momentum operators \hat{l}_j by selecting basis of $\{e_+, e_-, a\}$ defined in Section III A is

$$\hat{H}_{\text{SOC}} = \sum_j \left[\frac{1}{2} \lambda_{\perp} (\hat{l}_j^+ \hat{s}_j^- + \hat{l}_j^- \hat{s}_j^+) + \lambda_z \hat{l}_j^z \hat{s}_j^z \right], \quad (13)$$

where λ_z and λ_{\perp} are the respective axial and transverse non-zero matrix elements of the orbital operator \hat{O}_k^j ; $\hat{l}_z |e_{\pm}\rangle = \pm |e_{\pm}\rangle$ and $\hat{l}_{\pm} = \hat{l}_x \pm i\hat{l}_y$ are orbital raising and lowering operators with operational relationship of $\hat{l}_{\pm} |a\rangle = \mp \frac{1}{\sqrt{2}} |e_{\pm}\rangle$ and $\hat{l}_z |e_{\pm}\rangle = \pm |e_{\pm}\rangle$; $\hat{s}_{\pm} = \hat{s}_x \pm i\hat{s}_y$ are spin raising and lower operators. Eq. (13) can be further rewritten as [9, 55]

$$\begin{aligned} \hat{H}_{\text{SOC}} = & \lambda_z (|A_1\rangle \langle A_1| + |A_2\rangle \langle A_2| - |E_1\rangle \langle E_1| - |E_2\rangle \langle E_2|) \\ & + \lambda_{\perp} (|^1E'_+\rangle \langle ^3A_2^+| + |^1E'_-\rangle \langle ^3A_2^-|) \\ & + \text{c.c.} \end{aligned} \quad (14)$$

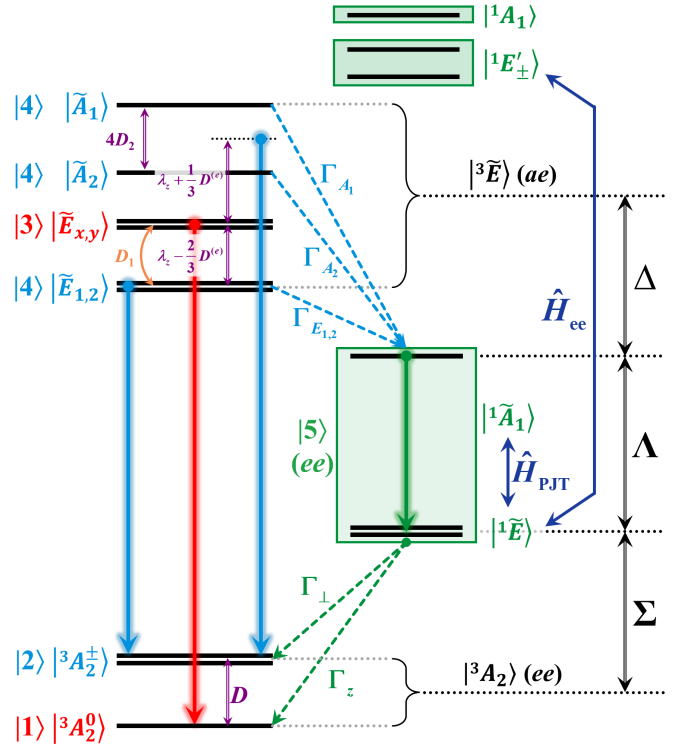

FIG. 2. Hierarchy of multi-electron levels in ascending order shared by PL1 and PLX1 centers. The black horizontal lines represent energy levels. λ_z and D represent the axial SOC and ZFS parameters, respectively. The positions of A_1 and A_2 may be swapped due to the different signs of D_2 . The glow and dotted arrow lines, respectively, mean radiative and non-radiative transitions. Δ , Λ , and Σ are the energy differences between $|^3\tilde{E}\rangle$ and $|^1\tilde{A}_1\rangle$, between $|^1\tilde{A}_1\rangle$ and $|^1\tilde{E}\rangle$, and between $|^1\tilde{E}\rangle$ and $|^3A_2\rangle$, respectively. Tilde indicates vibronic state. The dark blue line with double arrows indicates electronic interactions. The orange double arrow curves represent mixing interaction arising from spin-spin interaction. It is important to note that the energy gap among sublevels of $|^3E\rangle$ is not to scale to display fine splitting. In reality, fine splittings on the order of GHz can be disregarded in comparison to Δ , Λ , and Σ , which usually have values in the hundreds of meV or even larger.

where all the Dirac notations arise from Eq. (3) to Eq. (12). We note that

$$\lambda_z = \langle ^3E | \hat{H}_{\text{SOC}} | ^3E \rangle = \frac{1}{2} \langle e_+ | \hat{H}_{\text{SOC}} | e_+ \rangle, \quad (15a)$$

$$\lambda_{\perp} = \langle ^3E | \hat{H}_{\text{SOC}} | ^1A_1 \rangle = \frac{1}{\sqrt{2}} \langle e_+^\downarrow | \hat{H}_{\text{SOC}} | a^\uparrow \rangle, \quad (15b)$$

where up and down arrows represent the respective spin states and $|e_{\pm}\rangle$ was defined in Eq. (3) to Eq. (12) and depicted in Fig. 2.

The λ_z and λ_{\perp} can be obtained by employing the non-collinear magnetic calculations. The quantization axis was set to the C_3 axis, i.e., the c -axis of the 4H-SiC crystal. The geometry comes from spinpolarized DFT calculations possessing high symmetry by smeared electrons in

the degenerate e levels, which is fixed when performing the noncollinear calculations because SOC is a tiny perturbation to the system [60]. The procedure of SOC calculation is under Γ -point sampling of the Brillouin zone because other k points will introduce ambiguity by reducing the symmetry of orbitals. The strength of λ_z can be found by comparing the energy difference between electrons occupying the e_+ and e_- levels. This difference is also equal to the splitting of the two double-degenerate e levels when both levels are half occupied. However, we found that a supercell of such a size of 576 atoms is insufficient to converge the SOC value. As the size of the supercell changes, the resulting trend is described by a composite function that consists of sine, reciprocal, and exponential functions (see Appendix A for detail). We perform a scaling method to obtain λ_z from various sizes of supercells, and then the fitting result λ_{z0} will belong to an isolated qubit. The calculated λ_{z0} for PL1 center is 18.5 GHz, 5.2 times larger than the experimental value of 3.538 ± 0.052 GHz [26] measured at 8 K by PLE. The difference between calculated and experimental results can be attributed to the dynamic-JT (DJT) effect, which is beyond the Born–Oppenheimer approximation and reduces the theoretical value by the p Ham reduction factor (abbreviated as p factor) for correcting the λ_{z0} result to $\lambda_z = p \cdot \lambda_{z0}$ [60–63]. After being reduced by the p factor, the final λ_{z0} result for the PL1 center is 1.302 GHz. Besides, the calculated λ_{z0} of PLX1 is 9.7 GHz and is reduced to 0.85 GHz with p factor (see Appendix A for details of p factor). Though the λ_{\perp} can be obtained from the off-diagonal terms of SOC matrix, the calculated value of the λ_{\perp} is always much larger in our experience [60] where the origin of this effect has not yet been identified. Since λ_{\perp} remains fixed when simulating the ISC transition process in Section IV A, we utilize the relationship $\lambda_{\perp} = \lambda_z \times 1.2$ to account for the uncertainty of λ_{\perp} resulting from the C_{3v} symmetry [9, 64].

The ZFS is a fine splitting arising from the electronic spin-spin interaction among two or more uncoupled electrons without any external magnetic field. The ZFS parameters can be determined by conventional electron spin resonance (ESR) [65] and will serve as a direct reference for the microwave frequencies used in experimental ODMR implementations. The Hamiltonian of electronic spin-spin interaction \hat{H}_{ss} is

$$\hat{H}_{ss} = \frac{\mu_0 g^2 \beta^2}{4\pi r^3} \left[\hat{s}_1 \cdot \hat{s}_2 - \frac{3(\hat{s}_1 \cdot \hat{r})(\hat{s}_2 \cdot \hat{r})}{r^2} \right], \quad (16)$$

where μ_0 is the magnetic constant, g is the electron Landé factor, β is the Bohr magneton, \hat{s} is the spin momentum operator, and \hat{r} is the distance between two electrons. The matrix representation form of \hat{H}_{ss} is [58, 66]

$$\begin{aligned} \hat{H}_{ss} &= \hat{S}^T \cdot ({}^dD) \cdot \hat{S} \\ &= D_{xx} \hat{S}_{xx}^2 + D_{yy} \hat{S}_{yy}^2 + D_{zz} \hat{S}_{zz}^2 \\ &= D \left(\hat{S}_{zz}^2 - \frac{2}{3} \right) + E \left(\hat{S}_{xx}^2 - \hat{S}_{yy}^2 \right), \end{aligned} \quad (17)$$

where \hat{S} is the total spin, dD is a second-order trace-less tensor, the superscript "d" indicates diagonal, and D and E are the ZFS parameters in the eigenvalue framework of

$$D = \frac{3}{2} D_{zz}, \quad E = \frac{D_{yy} - D_{xx}}{2}. \quad (18)$$

D provides vital evidence for identifying color centers and, further, the frequency of microwave manipulation that causes spin flipping. E indicates the axial symmetry and should be zero for perfect C_{3v} symmetry. However, the DFT calculated D is generally overestimated compared to experimental values due to spin contamination. By eliminating the spin contamination of the two-particle spin density [67], the second-order trace-less tensor dD of both triplet dD_t and singlet dD_s are calculated separately. After getting the results of dD_t and dD_s , the final tensor ${}^d\tilde{D}$ will be brought by

$${}^d\tilde{D} = \frac{{}^dD_t - {}^dD_s}{2}. \quad (19)$$

The corrected ZFS parameters D and E will finally yield using Eq. (18) by diagonalizing the ${}^d\tilde{D}$. Prior to addressing spin contamination, the calculated D parameter is 1.93 and 1.95 GHz for PL1 and PLX1 centers, respectively. Following successful spin decontamination [67], the corrected D parameters are 1.43 and 1.41 GHz, which align well with the experimental values of 1.34 GHz (Ref. 22) and 1.33 GHz (Ref. 37) for PL1 and PLX1 centers, respectively.

In addition to the ZFS of the ground states, the ZFS among excited triplet state $|{}^3E\rangle$ is also discussed. There is also energy level splitting caused by spin-spin interaction, the $D^{(e)}$ -tensor (the superscript (e) indicates the excited state) between different spin sublevels in $|{}^3E\rangle$ [see Fig. 2], which is more complicated than the ground triplet state $|{}^3A_2\rangle$. Utilizing the method implemented in Ref. 68, the calculated $\{D^{(e)}, D_1^{(e)}, D_2^{(e)}\}$ are respectively $\{2042.49, 128.12, 473.33\}$ and $\{1515.00, 249.61, -839.53\}$ in MHz for PL1 and PLX1 centers. Furthermore, the Ham reduction factor q should be practically utilized to reflect the $(E \otimes e)$ DJT effect [68, 69] on the $D_1^{(e)}$ and $D_2^{(e)}$ tensors (see Appendix B for detail). The finally $\{D_1^{(e)}, D_2^{(e)}\}$ values after reduced are $\{64.96, 239.98\}$ and $\{128.05, -430.68\}$ in MHz. We do not currently perform spin decontamination here. Aside from the parallel SOC and $D^{(e)}$ -tensor, energy splitting among $|{}^3E\rangle$ can also be influenced by strain and the external magnetic field to determine the final energy spacing. The effects of strain and the external magnetic field are not within the scope of this work and will not be addressed for now.

C. Hyperfine parameters

The hyperfine interaction between electron spins of color centers and proximate nuclear spins is investigated

TABLE I. The calculated total hyperfine coupling parameters for PL1 and PLX1 centers with units in megahertz (MHz). See Fig. 1(a) for details on the isotopic subscripts. Notably, hyperfine parameters for nitrogen isotopes occur in the PLX1 center.

Sites	PL1/PLX1		
	A_{xx}	A_{yy}	A_{zz}
^{14}N	/ -1.67	/ -1.67	/ -1.73
^{15}N	/ -0.54	/ -0.54	/ -0.56
$^{29}\text{Si}_{\text{I}} \times 3$	0.52 / 0.54	-0.48 / -0.01	0.56 / 0.64
$^{13}\text{C}_{\text{I}} \times 3$	48.89 / 45.95	48.20 / 45.23	119.15 / 117.07
$^{29}\text{Si}_{\text{II}} \times 6$	9.44 / 9.89	8.07 / 8.69	10.25 / 10.73
$^{29}\text{Si}_{\text{II}} \times 3$	11.35 / 11.76	11.26 / 11.68	11.69 / 12.10
$^{13}\text{C}_{\text{II}} \times 6$	0.97 / 0.44	0.85 / 0.39	2.03 / 1.26
$^{13}\text{C}_{\text{II}} \times 3$	-0.34 / -0.10	-0.12 / -0.09	-0.35 / 0.15

to expand diversified QIS applications such as quantum storage. Table I displays all the calculated hyperfine parameters for the first and second neighbor isotopes [see Fig. 1(a)] to the color centers. $\text{C}_{\text{I}} \times 3$ means there are three nearest neighbor ^{13}C nuclear spins with equivalent positions. C_{II} means the next-nearest ^{13}C nuclear spins. Besides, the C_{II} is divided into two categories according to the relative position in the color center: $\text{C}_{\text{II}} \times 6$ and $\text{C}_{\text{II}} \times 3$, which will show different hyperfine interaction strength. The Si atoms with "I" and "II" indicate ^{29}Si nuclear spins and possess the same location information as ^{13}C . In Fig. 1(a), due to the screenshot angle, some atoms are not visible. All the calculated hyperfine parameter results of the PL1 center are consistent with data in Ref. 18. The most critical hyperfine parameters of the PLX1 center are for the substitutional nitrogen isotopes. The calculated ^{14}N hyperfine parameters of PLX1 center are shown in Table I, which agree with experimental results: 1.23 MHz in Ref. 20 and 37 and around 1.3 MHz in Ref. 23, and it is also consistent with theoretical results [36] well. Besides, we also calculated the ^{15}N hyperfine parameters to provide an additional pathway for QIS application based on the PLX1 center's nuclear spins.

IV. SPIN-DEPENDENT OPTICAL LOOP

The ODMR technique is essential for achieving qubit applications by utilizing spin-dependent fluorescence dynamics within a customized optical loop framework, where the major transition rates among key levels are essential. The non-radiative ISC transition dominated by electron-phonon coupling plays a pivotal role in the ODMR protocol for achieving optical spinpolarization. Additionally, the ODMR contrast ratio is closely related to both the non-radiative transition and radiative transition rates. In this section, both the upper branch of ISC transitions (between $|^3E\rangle$ and $|^1A_1\rangle$) mediated by the DJT effect and of the lower branch (between $|^1E_{1,2}\rangle$

and $|^3A_2\rangle$) mediated by the joint effect of DJT and PJT are demonstrated separately. Then, the radiative and directly non-radiative transitions from $|^3E\rangle$ to $|^3A_2\rangle$ are also investigated. Finally, by combining all the results with published experimental data, a brief discussion on ODMR contrast is provided.

A. Upper branch of ISC

Combined with our analysis of electronic properties in Section III, the high symmetry of the orbitally doubly-degenerate 3E excited state will be broken when coupling e phonons or quasi-local vibration modes. This is the so-called $(E \otimes e)$ DJT system [60, 62, 63]. By introducing two phonon operators \hat{x} and \hat{y} , the $(E \otimes e)$ DJT Hamiltonian is [60]

$$\hat{H}_{\text{DJT}} = \hbar\omega_e(\hat{a}_x^\dagger\hat{a}_x + \hat{a}_y^\dagger\hat{a}_y + 1) + F(x\hat{\sigma}_z + y\hat{\sigma}_x) + G[(x^2 - y^2)\hat{\sigma}_z + 2xy\hat{\sigma}_x], \quad (20)$$

where $\hbar\omega_e$ is the energy of e mode which will drive the distortion, F and G are linear and second-order electron-vibration coupling related terms, $\hat{x} = \frac{1}{\sqrt{2}}(a_x^\dagger + a_x)$, $\hat{y} = \frac{1}{\sqrt{2}}(a_y^\dagger + a_y)$ are the two dimensionless non-Hermitian operators, $|0,0\rangle$, $|1,0\rangle$ and $|0,1\rangle$ are selecting as basis vectors, σ is the Pauli matrix. The F and G are directed obtained by

$$F = \sqrt{2\hbar\omega_e E_{\text{JT}}}, \quad G = \frac{\delta_{\text{JT}}\hbar\omega_e}{2E_{\text{JT}}}. \quad (21)$$

The $\hbar\omega_e$ is derived directly by parabola fitting in the actual adiabatic potential energy surface (APES) of the quadratic DJT system. All the calculated parameters in Eq. (21) are shown in Table II. Additionally, the APES of the PL1 center is plotted for visualization [see Fig. 3]. For simplicity, we only show the Q configuration coordinates of the PL1 center here; in fact, the case of the PLX1 center is very close to the PL1 center.

TABLE II. The DJT effect parameters of PL1 and PLX1 centers with unit of meV. All results are valid at 0 K.

	E_{JT}	δ	$\hbar\omega_e$	F	G
PL1	73.62	18.24	46.21	76.43	3.27
PLX1	79.22	23.01	54.78	84.88	4.65

The electron-phonon coupling coefficients c_{nm} and d_{nm} can be obtained by solving Eq. (20) with parameters displayed in Table II. The solution expands as

$$|\Psi_{\pm}\rangle = \sum_{nm} (c_{nm}|E_{\pm}\rangle \otimes |n, m\rangle + d_{nm}|E_{\mp}\rangle \otimes |n, m\rangle). \quad (22)$$

The upper branch of ISC transitions from triplet $|^3E\rangle$ to singlet $|^1A_1\rangle$ mediated by transverse SOC follow the

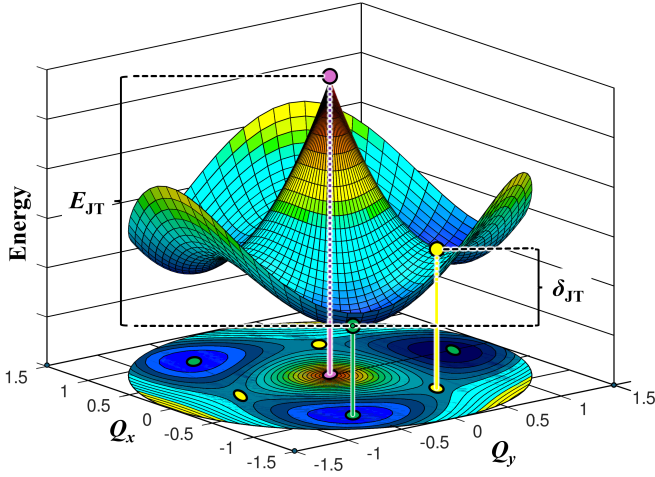

FIG. 3. APES of the quadratic DJT system for $|^3E\rangle$ of PL1 center. Q_x and Q_y represent the degenerate e phonons. E_{JT} is the linear DJT energy, which is the difference between the high (C_{3v}) geometry energy and minima (C_{1h}). δ_{JT} is the barrier energy arising from the second-order DJT effect. Green and yellow circles, respectively, indicate the configuration coordinates of three minima and three barrier points.

Fermi's golden rule, and the transition rate can be expressed as [60, 64, 70]

$$\Gamma_{1A_1} = 4\pi\hbar\lambda_{\perp}^2 F(\Delta), \quad (23)$$

where $F(\Delta)$ is the vibrational overlap function, which is the energy-dependent density of states multiplied by the overlap of the vibrational states between $|^3E\rangle$ and $|^1A_1\rangle$ with energy spacing of Δ . The first order ISC transition occurs only between $|A_1\rangle$ substate of $|^3E\rangle$ (see [4] in Fig. 2) and $|^1A_1\rangle$ (|5) in Fig. 2) described by Eq. (23), with an assumption of that the λ_{\perp} remains fixed independently of the coordinates of the atoms [60]. Hence, we not only use calculated numerical data of the λ_{\perp} described in Section III B, but also experimental data available [26]. For meticulous investigation of the ISC transition between $|^3E\rangle$ and $|^1A_1\rangle$, the nature of $|^3E\rangle$ invoking DJT should be involved, which will bring to a second order of the ISC transitions. The four wavefunctions of electron-phonon coupled triple excited states with magnetic quantum number $m_s = \pm 1$ in the Born–Oppenheimer basis of symmetry-adapted terms $\{|\tilde{A}_1\rangle, |\tilde{A}_2\rangle, |\tilde{E}_1\rangle, |\tilde{E}_2\rangle\}$ are variants of Eq. (22) and take the forms below

$$\begin{aligned} |\tilde{A}_1\rangle &= \frac{1}{\sqrt{2}} (|\Psi_{-}\rangle \otimes |\uparrow\uparrow\rangle - |\Psi_{+}\rangle \otimes |\downarrow\downarrow\rangle) \\ &= \sum_i \left[c_i |A_1\rangle |\varrho_i(A_1)\rangle + f_i |A_2\rangle |\varrho_i(A_2)\rangle \right. \\ &\quad \left. + \frac{d_i}{\sqrt{2}} (|E_1\rangle |\varrho_i(E_1)\rangle + |E_2\rangle |\varrho_i(E_2)\rangle) \right], \quad (24a) \end{aligned}$$

$$\begin{aligned} |\tilde{E}_1\rangle &= \frac{1}{\sqrt{2}} (|\Psi_{-}\rangle \otimes |\downarrow\downarrow\rangle - |\Psi_{+}\rangle \otimes |\uparrow\uparrow\rangle) \\ &= \sum_i \left[c_i |E_1\rangle |\varrho_i(A_1)\rangle + f_i |E_2\rangle |\varrho_i(A_2)\rangle \right. \\ &\quad \left. + \frac{d_i}{\sqrt{2}} (|A_1\rangle |\varrho_i(E_1)\rangle + |A_2\rangle |\varrho_i(E_2)\rangle) \right], \quad (24b) \end{aligned}$$

$$\begin{aligned} |\tilde{E}_2\rangle &= \frac{1}{\sqrt{2}} (|\Psi_{-}\rangle \otimes |\downarrow\downarrow\rangle + |\Psi_{+}\rangle \otimes |\uparrow\uparrow\rangle) \\ &= \sum_i \left[c_i |E_2\rangle |\varrho_i(A_1)\rangle + f_i |E_1\rangle |\varrho_i(A_2)\rangle \right. \\ &\quad \left. + \frac{d_i}{\sqrt{2}} (|A_1\rangle |\varrho_i(E_2)\rangle + |A_2\rangle |\varrho_i(E_1)\rangle) \right], \quad (24c) \end{aligned}$$

$$\begin{aligned} |\tilde{A}_2\rangle &= \frac{1}{\sqrt{2}} (|\Psi_{-}\rangle \otimes |\uparrow\uparrow\rangle + |\Psi_{+}\rangle \otimes |\downarrow\downarrow\rangle) \\ &= \sum_i \left[c_i |A_2\rangle |\varrho_i(A_1)\rangle + f_i |A_1\rangle |\varrho_i(A_2)\rangle \right. \\ &\quad \left. + \frac{d_i}{\sqrt{2}} (|E_1\rangle |\varrho_i(E_1)\rangle - |E_2\rangle |\varrho_i(E_2)\rangle) \right], \quad (24d) \end{aligned}$$

where the calculated c_i , d_i , f_i values are taken from Table VI in Appendix B, and the expressions of symmetry-adapted vibrational wavefunctions $|\varrho_i(\Gamma_i)\rangle$ are shown in Table III. Furthermore, by taking account the DJT effect in $|^3E\rangle$, the degenerate $|\tilde{A}_2\rangle, |\tilde{E}_1\rangle, |\tilde{E}_2\rangle$ vibronic wavefunctions containing $|A_1\rangle$ could induce the second order ISC transitions to $|^1A_1\rangle$ with expressions as

$$\Gamma_{A_1} = 4\pi\hbar\lambda_{\perp}^2 \sum_{i=1}^{\infty} [c_i^2 F(\Delta - n_i\hbar\omega_e)], \quad (25a)$$

$$\Gamma_{E_{1,2}} = 4\pi\hbar\lambda_{\perp}^2 \sum_{i=1}^{\infty} \left[\frac{d_i^2}{2} F(\Delta - n_i\hbar\omega_e) \right], \quad (25b)$$

$$\Gamma_{A_2} = 4\pi\hbar\lambda_{\perp}^2 \sum_{i=1}^{\infty} [f_i^2 F(\Delta - n_i\hbar\omega_e)]. \quad (25c)$$

The calculation of the ISC rates based on Eq. (25) needs a determination of the unknown Δ , so it was set as a parameter in the following analysis. However, the current HSE06-DFT method cannot explicitly simulate the $|^1A_1\rangle$. The energy and geometry of the $|^1A_1\rangle$ are roughly approximated by the non-spinpolarized DFT calculations of closed-shell $|xx\rangle$ in Eq. (6). The feasibility of this method has been verified in Refs. 55 and 60. The overlap function $F(\Delta)$ is approximated from the phonon sideband in the PL spectrum within the Huang–Rhys approximation of the Franck–Condon theory (see Supplementary Material of Ref. 60). The original PL spectrum is in the form of $\omega^3 S(\omega)$, and we used $F(\omega) = S(\omega)$ instead. Under this assumption, there are only a_1 phonons considered in the ISC process, where the contribution of e phonons is responsible for the DJT nature of the $|^3E\rangle$

and work in the form of c_i , d_i , f_i coefficients as shown in Eq. (25). Hence, for calculating $F(\omega)$, we prefer a high symmetry geometry without any DJT feature of $|^3E\rangle$ by the smeared occupation of electrons in the e levels.

The upper branch of ISC transition originates from different states of $|^3E\rangle$, and it is imperative to provide all rates and ratios between them in relation to the gap energy Δ . All the calculated ISC rates are depicted in Fig. 4. We observed that although the DJT nature was invoked in triplet excited states, the contribution of ISC Γ_{A_2} remains smaller compared to Γ_{A_1} and $\Gamma_{E_{1,2}}$ in both centers due to the smaller value of $\sum f_i^2$. For the PL1 center, $\Delta = 160$ meV is obtained from this DFT calculation, while an additional $\Delta = 185$ meV comes from the multiconfigurational DFT approach [71]. For $\Delta = 160$ meV, we found that $\Gamma_{A_1} = 13.60$ MHz and $\Gamma_{E_{1,2}} = 6.85$ MHz, with ratio of $\Gamma_{E_{1,2}}/\Gamma_{A_1} = 0.50$; where for $\Delta = 185$ meV, $\Gamma_{A_1} = 9.46$ MHz and $\Gamma_{E_{1,2}} = 5.25$ MHz, with ratio of $\Gamma_{E_{1,2}}/\Gamma_{A_1} = 0.55$. The calculated rates of the PL1 center consistently show the reported effective dark state time of 60.7 ns at 5 K [24]. Moreover, Ref. 21 reported a mixed transition rate of approximately 14 MHz at room temperature, suggesting that the influence of temperature on ISC rates is relatively insignificant. As for PLX1 center at $\Delta = 62$ meV, Γ_{A_1} is 0.95 MHz, $\Gamma_{E_{1,2}}$ is 0.03 MHz, and Γ_{A_2} is almost zero, which shows same order of magnitude to experimental results in Refs. 23 and 34. $\Delta = 62$ meV is smaller than $\Delta = 160$ meV of PL1 center and maybe because there are more components from a states than e_x state contributing to $|xx\rangle$, where a has higher energy than e_x within the hole notation. The accuracy and reliability of the DJT parameters in $|^3E\rangle$ are highly credible, and a more precise determination of Δ values in the future may lead to an even more accurate estimation of the ISC rates.

B. Lower branch of ISC

The lower branch of ISC transition between the double-degenerate $|^1E_{1,2}\rangle$ (abbreviated as $|^1E\rangle$ here and after) and triplet $|^3A_2\rangle$ is more complex than the upper branch. Because $|^1E\rangle$ and $|^1A_1\rangle$ possess different IR spaces, only the symmetry-distorting e vibration modes couple the two states. This is the so-called pseudo-JT (PJT) effect [62, 63]. Employing the basis shown in Eq. (6), the expression of Hamiltonian including the electronic component \hat{H}_e , harmonic oscillator component \hat{H}_{osc} , and PJT component \hat{H}_{PJT} is

$$\begin{aligned} \hat{H} &= \hat{H}_e + \hat{H}_{\text{osc}} + \hat{H}_{\text{PJT}} \\ &= \frac{\Lambda_e}{2} \begin{bmatrix} 1 & 0 & 1 \\ 0 & 0 & 0 \\ 1 & 0 & 1 \end{bmatrix} + \hbar\omega_E (a_x^\dagger a_x + a_y^\dagger a_y + 1) \\ &\quad + \tilde{F} (\hat{\sigma}_z \hat{x} - \hat{\sigma}_x \hat{y}), \end{aligned} \quad (26)$$

where Λ_e is the energy gap between $|^1E\rangle$ and $|^1A_1\rangle$ when the electron-phonon interaction is not considered, $\hbar\omega_E$ is

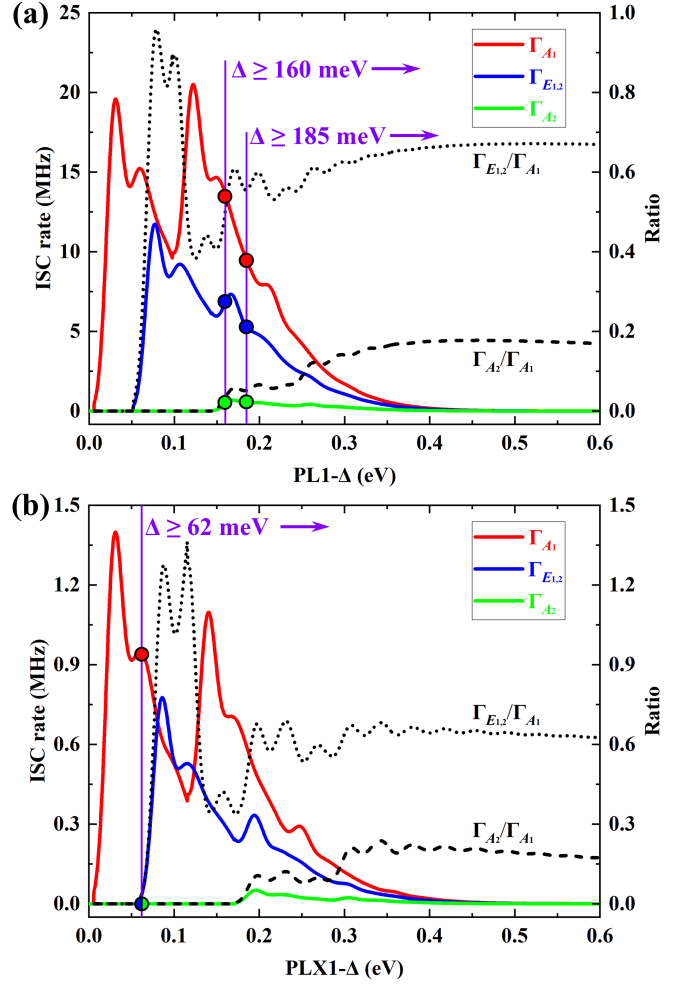

FIG. 4. The upper branch of ISC transition rates Γ and ratios for (a) PL1 center and (b) PLX1 center. The vertical purple lines correspond to Δ (see Fig. 2) values. For the PL1 center, the $\Delta = 160$ meV from DFT calculation and 185 meV from Ref. 71. For the PLX1 center, the $\Delta = 62$ meV comes from the DFT calculation. The colored circles represent the values of ISC rates at specific Δ .

the energy of e mode of PJT, \hat{x} and \hat{y} are dimensionless coordinates and defined in Eq. (20) with frequency of ω_E , \tilde{F} is the cumulative electron-phonon coupling, $\hat{\sigma}_z$ and $\hat{\sigma}_y$ are spin operators of the angular momentum $L = 1$ in the PJT interaction with the following form

$$\hat{\sigma}_z = \begin{bmatrix} 1 & 0 & 0 \\ 0 & 0 & 0 \\ 0 & 0 & -1 \end{bmatrix}, \quad \hat{\sigma}_x = \frac{-1}{\sqrt{2}} \begin{bmatrix} 0 & 1 & 0 \\ 1 & 0 & 1 \\ 0 & 1 & 0 \end{bmatrix}. \quad (27)$$

Besides the PJT interaction in $|^1E\rangle$, there is also a dynamic electron-electron correlation between the $|^1E'\rangle$ and $|^1E\rangle$, and the DJT effect will also be involved. The electron-electron correlation happens among two states with the same total symmetry, even themselves. In this work, we mainly focus on the mixture of $|^1E'\rangle$ and $|^1E\rangle$, which will allow the $\Gamma_{\perp} = \Gamma_{\pm} + \Gamma_{\mp}$. We introduced a

TABLE III. Expressions of symmetry-adapted vibration wave-functions individually defined in Eq. (24). i is the sum of quantum numbers of x and y phonons. "/" means no quantum number there. For example, $|\varrho_i(A_2)\rangle$ phonon function starts having a quantum number from $i = 3$. The expressions of the states are not normalized for the sake of brevity.

$i = m + n$	$ \varrho_i(A_1)\rangle$	$ \varrho_i(E_1)\rangle$	$ \varrho_i(E_2)\rangle$	$ \varrho_i(A_2)\rangle$
0	$ 0, 0\rangle$	/	/	/
1	/	$ x, 0\rangle$	$ 0, y\rangle$	/
2	$ x^2 + y^2\rangle$	$ x^2 - y^2\rangle$	$ xy + yx\rangle$	/
3	$ x(x^2 - 3y^2)\rangle$	$ (x^2 + y^2)x\rangle$	$ (x^2 + y^2)y\rangle$	$ y(3x^2 - y^2)\rangle$
4	$ (x^2 + y^2)^2\rangle$	$ (x^2 + y^2)(x^2 - y^2)\rangle$	$ (x^2 + y^2)(xy + yx)\rangle$...
5	...	$ x^4 - 6x^2y^2 + y^4\rangle$
...

mixing coefficient C for describing the multi-determinant singlet state $|^1\tilde{E}\rangle$ [55] quantitatively as

$$|^1\tilde{E}\rangle = C|^1E\rangle + \sqrt{1 - C^2}|^1E'\rangle. \quad (28)$$

Based on Eq. (28), the $|^1E\rangle$ will carry the DJT character by the extent of $(1 - C^2)$, which also indicates the contribution of $|^1E'\rangle$ in $|^1\tilde{E}\rangle$. The DJT Hamiltonian of $|^1E'\rangle$ is

$$\hat{H}_{\text{DJT}} = F_2(\bar{\sigma}_z \hat{X} - \bar{\sigma}_x \hat{Y}), \quad (29)$$

where F_2 is the electron-phonon coupling of DJT, $\bar{\sigma}_z$ and $\bar{\sigma}_x$ are spin operators of the $L = 1$ angular momentum spinning in the two-dimensional $|^1E'\rangle$ space with the form of

$$\bar{\sigma}_z = |E'_x\rangle \langle E'_x| - |E'_y\rangle \langle E'_y|, \quad (30a)$$

$$\bar{\sigma}_x = |E'_x\rangle \langle E'_y| + |E'_y\rangle \langle E'_x|, \quad (30b)$$

and under the basis of Eq. (6) are expressed in matrix form as

$$\bar{\sigma}_z = \frac{1}{2} \begin{bmatrix} -1 & 0 & 1 \\ 0 & 2 & 0 \\ 1 & 0 & -1 \end{bmatrix}, \quad \bar{\sigma}_x = \frac{1}{\sqrt{2}} \begin{bmatrix} 0 & -1 & 0 \\ -1 & 0 & 1 \\ 0 & 1 & 0 \end{bmatrix}. \quad (31)$$

Furthermore, based on basis of Eq. (6) and taking Eq. (28) into consideration, the effective DJT Hamiltonian is

$$\hat{H}_{\text{DJT}}^{\text{eff}} = (1 - C^2)F_2(\bar{\sigma}_z \hat{X} - \bar{\sigma}_x \hat{Y}). \quad (32)$$

The electron-phonon coupling \tilde{F} in PJT is about twice that of F in DJT, which due to the double e orbitals are JT unstable of $|xx\rangle$ in (ee) configuration. In contrast, in the (ae) configuration, only one e orbital is JT unstable. Finally, combining the PJT and DJT and electron-electron interaction, the final effective electron-phonon coupling Hamiltonian $\hat{H}_{\text{el-ph}}^{\text{eff}}$ of the shelving singlet state is

$$\hat{H}_{\text{el-ph}}^{\text{eff}} = C^2 \cdot (2F_2) \cdot (\hat{\sigma}_z \hat{X} - \hat{\sigma}_x \hat{Y}) + (1 - C^2) \cdot F_2 \cdot (\bar{\sigma}_z \hat{X} - \bar{\sigma}_x \hat{Y}), \quad (33)$$

where C^2 represents the contribution that is affected by the PJT effect and induces ISC through the Γ_z parameter. Similarly, the $(1 - C^2)$ contribution is governed by DJT and induces ISC by means of Γ_{\pm} . The full Hamiltonian for the $|^1\tilde{E}\rangle \oplus |^1\tilde{A}_1\rangle$ system is

$$\hat{H} = \hat{H}_e + \hat{H}_{\text{osc}} + \hat{H}_{\text{el-ph}}^{\text{eff}}. \quad (34)$$

In this work, we mainly focus on the ISC transition from $|^1\tilde{E}\rangle$ to $|^3A_2\rangle$. Based on Eq. (34), the e phonon modes expansion could result in the following vibronic wave-functions of

$$|\tilde{\Psi}\rangle = \sum_{n,m}^{\infty} \left[c_{nm}^{xx} |xx\rangle \otimes |nm\rangle + c_{nm}^{xy} |xy\rangle \otimes |nm\rangle + c_{nm}^{yy} |yy\rangle \otimes |nm\rangle \right], \quad (35)$$

where the expansion of the phonon modes in the Born-Oppenheimer basis $|nm\rangle = \frac{1}{\sqrt{nm}}(a_x^\dagger)^n (a_y^\dagger)^m |00\rangle$ is limited to 10, i.e., $(n + m \leq 10)$ to satisfy numerical convergence. Then, the expression of the $|^1\tilde{E}_{\pm}\rangle$ is

$$|^1\tilde{E}_{\pm}\rangle = \sum_{i=1}^{\infty} (c'_i |^1\tilde{E}_{\pm}\rangle \otimes |\chi_i(A_1)\rangle + d'_i |^1A_1\rangle \otimes |\chi_i(E_{\pm})\rangle + f'_i |^1\tilde{E}_{\mp}\rangle \otimes |\chi_i(E_{\mp})\rangle + g'_i |^1\tilde{E}_{\pm}\rangle \otimes |\chi_i(A_2)\rangle). \quad (36)$$

Similarly to $|\varrho_i(\dots)\rangle$ in Eq. (24), the $|\chi_i(\dots)\rangle$ in Eq. (36) also depicts symmetry-adapted vibrational wavefunctions. The ISC transition from $|^1\tilde{E}\rangle$ to $|^3A_2\rangle$ is one kind of SOC-driven scattering, which is mediated by the electron-phonon interactions. In these two centers, also in the NV-diamond, the energy gap between $|^1\tilde{E}\rangle$ and $|^3A_2\rangle$ are far larger than the strength of SOC, indicating that the electrons will be scattered to the vibration levels $\langle \dots |$ of $|^3A_2\rangle$ ground state. During this process, the E phonons play a vital role arising from the PJT and DJT effects. In the upper branch of ISC discussed in Section IV A, we assume that the SOC would not change significantly during the transition process. Hence, the

SOC data is also consistent with the upper branch in Section IV A. The ISC rate could also be expressed by the variety of Fermi's golden rule [55] like Eq. (23). However, we note that the ISC transitions mechanism towards $|^3A_2^0\rangle$ and $|^3A_2^\pm\rangle$ are different.

The Γ_z between $|^1\tilde{E}\rangle$ and $|^3A_2^0\rangle$ could be expressed as

$$\begin{aligned}\Gamma_z &= \frac{2\pi C^2}{\hbar} \sum_{|\dots\rangle} |\langle \dots | \otimes \langle ^3A_2^0 | \hat{W} | ^1\tilde{E} \rangle|^2 \delta(\Sigma - E(|\dots\rangle)) \\ &= \frac{2\pi C^2}{\hbar} \sum_i 4\lambda_z^2 d_i'^2 |\langle \dots | \chi_i(E_\pm) \rangle|^2 \delta(\Sigma - n_i \hbar \omega_E) \\ &\approx \frac{8\pi \lambda_z^2 C^2}{\hbar} \sum_i d_i'^2 S_E^{(n_i)}(\Sigma) \\ &= \frac{8\pi \lambda_z^2 C^2}{\hbar} F_E(\Sigma),\end{aligned}\quad (37)$$

where the d_i' coefficient means the contribution of $|^1A_1\rangle$ in $|^1\tilde{E}\rangle$, which connects to $|^3A_2^0\rangle$ by the λ_z [7, 9, 55]; n_i represents the i -th $|\chi_i(E_\pm)\rangle$ vibronic function. F_E is the PJT-modulated phonon overlap function based on the phonon overlap spectral function S_E . Σ is the energy gap between $|^1\tilde{E}\rangle$ and $|^3A_2^0\rangle$ as shown in Fig. 2. A recursive formula was used to avoid discrete quantum energy levels, causing the overlap in F_E to be zero [55]. Except for the Γ_z , there are also Γ_\pm and Γ_\mp between $|^1\tilde{E}\rangle$ and $|^3A_2^\pm\rangle$ driven by λ_\perp with a form as

$$\begin{aligned}\Gamma_\pm &= \frac{2\pi(1-C^2)}{\hbar} \sum_{|\dots\rangle} |\langle \dots | \otimes \langle ^3A_2^\pm | \hat{W} | ^1\tilde{E} \rangle|^2 \delta(\Sigma - E(|\dots\rangle)) \\ &= \frac{2\pi(1-C^2)}{\hbar} \sum_i \lambda_\perp^2 c_i'^2 |\langle \dots | \chi_i(A_1) \rangle|^2 \delta(\Sigma - n_i \hbar \omega_E) \\ &\approx \frac{2\pi \lambda_\perp^2 (1-C^2)}{\hbar} \sum_i c_i'^2 S_E^{(n_i)}(\Sigma) \\ &= \frac{2\pi \lambda_\perp^2 (1-C^2)}{\hbar} F'_E(\Sigma),\end{aligned}\quad (38)$$

and

$$\begin{aligned}\Gamma_\mp &= \frac{2\pi(1-C^2)}{\hbar} \sum_{|\dots\rangle} |\langle \dots | \otimes \langle ^3A_2^\pm | \hat{W} | ^1\tilde{E} \rangle|^2 \delta(\Sigma - E(|\dots\rangle)) \\ &= \frac{2\pi(1-C^2)}{\hbar} \sum_{i=1}^{\infty} \lambda_\perp^2 f_i'^2 |\langle \dots | \chi_i(A_1) \rangle|^2 \delta(\Sigma - n_i \hbar \omega_E) \\ &\approx \frac{2\pi \lambda_\perp^2 (1-C^2)}{\hbar} \sum_{i=1}^{\infty} f_i'^2 S_E^{(n_i)}(\Sigma) \\ &= \frac{2\pi \lambda_\perp^2 (1-C^2)}{\hbar} F''_E(\Sigma),\end{aligned}\quad (39)$$

where F'_E and F''_E represent the phonon overlap spectral functions resulting from the DJT effect.

The C^2 parameter could be obtained numerically by the character of the KS wavefunctions of the closed-shell $|xx\rangle$, which already contains the mixture between a and

e_x levels. The true KS state $|\xi\xi\rangle$ has a form of

$$\begin{aligned}|\xi\xi\rangle &= (p|e_x\rangle + s|a\rangle)(p|e_x\rangle + s|a\rangle) \\ &= p^2|e_x e_x\rangle + \sqrt{2}ps \left(\frac{|ae_x\rangle + |e_x a\rangle}{\sqrt{2}} \right)_{|^1E'_x\rangle} \\ &\quad + s^2(|aa\rangle)_{|^1A'_1\rangle},\end{aligned}\quad (40)$$

where p and s means the respective contribution of e_x and a ; and ($C^2 = 1 - 2p^2s^2$) could be read out directly from the KS wavefunctions. The F_2 in Eq. (33) could be obtained by the relationship of

$$F_2 = \frac{\sqrt{2\hbar\omega_E E_{JT2}}}{1 + C^2},\quad (41)$$

where the effective phonon mode $\hbar\omega_E$ and JT energy E_{JT2} arise from the fitting and energy of the distorted $|xx\rangle$ geometry, respectively. All the obtained parameters of Eq. (33) are shown in Table IV. Finally, the calculated $c_i'^2$, $d_i'^2$ and $f_i'^2$ coefficients are shown in Table VI of Appendix B.

The lower branch of ISC transition occurs from the double degenerate $|^1E\rangle$ state to the $|^3A_2\rangle$ triplet state, in contrast to the upper branch, which transitions from triplet to singlet states. Both the axial and transverse components of SOC are involved in this process: Γ_z (from $|^1E\rangle$ to $|^3A_2^0\rangle$) is associated with λ_z and Γ_\perp (from $|^1E\rangle$ to $|^3A_2^\pm\rangle$) is associated with λ_\perp . The Γ_z/Γ_\perp ratio is also crucial and could be advantageous to quickly assessing the spin polarizability. Additionally, the ratio highly depends on the combined nature of DJT and PJT effects with SOC. The calculated lower branch rates are illustrated in Fig. 5. For the PL1 center, $\Gamma_z = 0.19$ MHz and $\Gamma_\perp = 0.06$ MHz at $\Sigma_{PL1} = 146$ meV, where the related ratio of $\Gamma_z/\Gamma_\perp = 3.30$. For the PLX1 center, as shown in Fig. 5(b), $\Gamma_z = 0.01$ MHz and $\Gamma_\perp = 0.002$ MHz at $\Sigma_{PLX1} = 138$ meV, where the related ratio of $\Gamma_z/\Gamma_\perp = 5.17$. By comparing the differences between the theoretical and experimental SOC results of the PL1 center, we conclude that the calculated SOC of the PLX1 center may be slightly underestimated, resulting in a smaller rate than the actual value.

TABLE IV. PJT effect parameters of PL1 and PLX1 centers. All data are in meV except for C^2 .

	Λ_e	$\hbar\omega_E$	E_{JT2}	C^2	F_2
PL1	847	36.6	118.4	0.89	49.3
PLX1	891	39.5	109.5	0.91	48.7

C. PL lifetime and ODMR contrast

The PL lifetime τ_{PL} of the $|^3E\rangle$ excited state is the reciprocal of the transition rate k_{PL} from the $|^3E\rangle$ to the $|^3A_2\rangle$ ground state. There are various pathways form

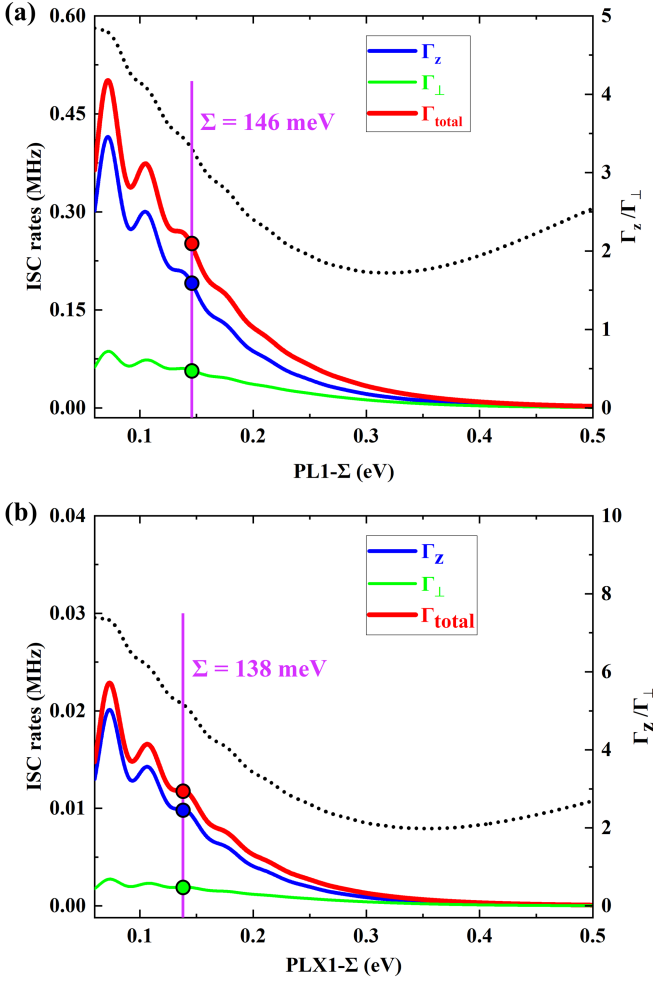

FIG. 5. The calculated rates of lower branch and (Γ_z/Γ_\perp) ratios. $\Gamma_\perp = \Gamma_\pm + \Gamma_\mp$ and $\Gamma_{\text{total}} = \Gamma_z + \Gamma_\perp$. Σ is the splitting between triplet $|^3A_2\rangle$ and degenerate singlet $|^1E_\mp\rangle$ as shown in Fig. 2. The details of the Σ values are shown in Table IV.

$|^3E\rangle$ to $|^3A_2\rangle$, mainly consisting of the radiative transition k_{rad} , the non-radiative transition k_{ph} , and the ionization (recombination) transition k_{ir} , with the relationship as

$$\frac{1}{\tau_{\text{PL}}} = k_{\text{PL}} = k_{\text{rad}} + k_{\text{ph}} + k_{\text{ir}}. \quad (42)$$

Based on the above results, for the sake of simplicity, energy levels shown in Fig. 2 are enumerated into a five-level rate-equation model with major transition rates as shown in Fig. 6(a). The radiative transition is a spin-conserving transition with photon emission dominated by the selection rules, which is mostly the source of fluorescence signals in QIS experiments and named as k_{31} and k_{42} in Fig. 6(a). The thermally assisted non-radiative transition contains two parts. One is the spin-conserving direct decay from $|^3E\rangle$ to $|^3A_2\rangle$, also called the internal conversion (IC) with a rate k_{IC} [72]. The other one is the ISC transition with a rate of k_{ISC} , which is the composite transition of upper (k_{35} and k_{45} in Fig. 6(a)) and

lower (k_{51} and k_{52} in Fig. 6(a)) branches. Ignoring any weaker phonon-mediated transitions, $k_{\text{ph}} = k_{\text{IC}} + k_{\text{ISC}}$ in general. Under some specific conditions, the ionization (recombination) transition via other charge states [73] is also non-negligible, which also affects the ODMR contrast.

The radiative transition is the spin-conserved dipole transition between the $|^3E\rangle$ excited state to the $|^3A_2\rangle$ ground state dominated by the selection rules. The expression of the transition rate k_{rad} is

$$k_{\text{rad}} = \frac{3\pi\epsilon_0\hbar^4 c^3}{nE_{\text{ZPL}}^3 |\mu|^2}, \quad (43)$$

where ϵ_0 is the vacuum permittivity; \hbar is the reduced Planck constant; c is the speed of light in vacuum; $n = 2.647$ is the refractive index of 4H-SiC [74]; E_{ZPL} is the ZPL energy, and μ is the optical-transition dipole moment. Referring to Fig. 6(a), k_{rad} corresponds to two transitions: k_{31} between the $|0\rangle$ sublevels of $|^3E\rangle$ and $|^3A_2\rangle$, and k_{42} between the $|\pm 1\rangle$ sublevels of $|^3E\rangle$ and $|^3A_2\rangle$. We used the Δ SCF method to calculate the ZPL values of 1.15 eV and 1.09 eV for the PL1 and PLX1 centers. These values are in line with experimental results of 1.095 eV (1132 nm) for the PL1 center [22], and 0.999 eV (1241 nm) for the PLX1 center [19]. Furthermore, the dipole moments were calculated using the pseudo wavefunctions of the a and e KS levels in JT-distorted excited state [75], yielding values of 7.36 D and 8.44 D for PL1 and PLX1 centers. Finally, the calculated k_{rad} values are 35.6 and 40.3 MHz for PL1 and PLX1 centers, corresponding to radiative times of 28.1 and 24.8 ns, respectively.

For the PL1 center, the radiative lifetime of $k_{\text{rad}} = 28.09$ ns aligns closely with another simulated value of 23.01 ns [74], as well as with the experimental value of around 16 ns at low temperature for both single and ensemble [24, 28]. We also calculated the levels crossing between $|^3A_2\rangle$ and $|^3E\rangle$ as shown in Fig. 6(b). Even in a large configuration coordinate (Q) of $3\sqrt{\text{amu}\cdot\text{\AA}}$, there is still no crossing point between the two levels. It is because of the large energy gap of about 1.1 eV between $|^3A_2\rangle$ and $|^3E\rangle$ [21], which results in almost no overlap between their APESs. Hence, the k_{IC} for PL1 center could be ignored compared to the k_{rad} at 0 K. Fig. 6(b) also indicates that in low temperature, the $|^3E\rangle$ is too small to be ignored. However, the calculated radiative lifetime of 24.81 ns for the PLX1 center deviates from the experimental measured excited state lifetime of 2.7 ns at low temperature [23]. From Fig. 6(c), there is also no overlap between APESs of $|^3E\rangle$ to $|^3A_2\rangle$ because of a large energy gap of 1 eV [19], which means the k_{rad} at 0 K of PLX1 center also could be ignored like for PL1 center. Therefore, this deviation should be mainly caused by the non-negligible k_{ir} . In the case of NV-diamond, which is isovalent center to the PLX1 center, k_{ir} has a significant maximum ionization rate of 21.2 MHz and a recombination rate of 390.3 MHz under certain circumstances [73]. Besides, the ionization/recombination tran-

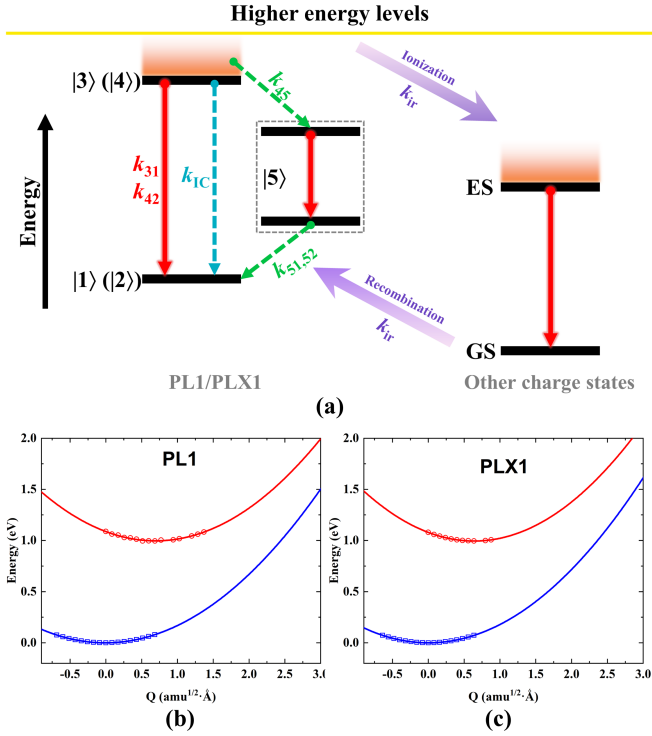

FIG. 6. Diagram of the five-level rate-equation model with major associated rates. Key features: black line (energy levels), glowing arrow (radiative transitions), dashed line (phonon-mediated non-radiative transitions), and gradient arrow line (ionization/recombination transitions). GS (ES) is the ground (excited) state. $|1\rangle = |^3A_2^0\rangle$, $|2\rangle = |^3A_2^\pm\rangle$, $|3(4)\rangle$ is sublevel of $|^3E\rangle$ with $m_s = 0(\pm 1)$. Gradients above the energy levels indicate phonon sidebands. Charge states vary while maintaining the same atomic structure. Transition rates between states $|i\rangle$ and $|j\rangle$ are denoted as k_{ij} . Panels (b) and (c) illustrate energy level crossings between $|^3A_2\rangle$ and $|^3E\rangle$ for the PL1 and PLX1 centers at 0 K, showing energy E versus configuration coordinate Q .

sition depends heavily on complicated conditions such as laser power and sequence, surface or internal impurities, and readout protocol [11]. Ref. 43 also demonstrates a single-shot readout of the PL1 center via spin-to-charge conversion. The competing non-negligible k_{ir} in special circumstances shows excellent reference significance for the PLX1 center, which reasonably explains the deviation between the theoretical and experimental results.

Finally, all the resulting major transition rates related to ODMR contrast are collected and shown in Table V. Besides, the average arises from the assumption that one event only occurs from one of the vibronic states and occupation of any of the triplets can happen with the same probability when the electron is excited from the $|m_s = \pm 1\rangle$ sub-state of the ground state at low temperatures. The quantum yield is a key indicator for evaluating quantum information readout efficiency [76], with a relation of $\eta_{QY} = k_{rad}/k_{PL}$. Based on Eq. (42) and data shown in Table V, the resulting η_{QY} are 83.86% and

TABLE V. Summary of the calculated major rates in Fig. 6 for PL1 and PLX1 centers. The k_{ij} means rates shown in Fig. 6, and Γ is shown in Fig. 2. $k_{45} = (\Gamma_{A_1} + 2\Gamma_{E_{1,2}} + \Gamma_{A_2})/4$ is for the case of off-resonant excitation.

Parameters	PL1 (MHz)	PLX1 (MHz)
k_{31} (k_{42})	35.60	40.31
Γ_{A_1}	13.60	0.95
$\Gamma_{E_{1,2}}$	6.85	0.03
Γ_{A_2}	0.46	≈ 0
k_{45}	6.94	0.25
k_{51} (Γ_z)	0.19	0.01
k_{52} (Γ_\perp)	0.06	≈ 0

99.41% for PL1 and PLX1 centers, respectively. Though the actual pulse off-resonant ODMR readout contrast \mathcal{C} depends on many factors, the trend can be simplified to an expression with defect intrinsic parameters and expressed as [6, 21]

$$\mathcal{C} = \frac{\tau_{\pm 1} - \tau_0}{\tau_0} = \frac{k_0 - k_{\pm 1}}{k_{\pm 1}}, \quad (44)$$

where the $\tau_{\pm 1}$ and τ_0 are optical lifetimes of the $|\pm 1\rangle$ and $|0\rangle$ for the excited state $|^3E\rangle$ and inverse of the rates k_0 and $k_{\pm 1}$, respectively. Based on Fig. 6, there should have $k_0 = k_{31} + k_{IC} + k_{35} + k_{ir}$, and $k_{\pm 1} = k_{42} + k_{IC} + k_{45} + k_{ir}$. $k_{rad} = k_{31} = k_{42}$ [21]. Besides, the non-radiative transition rate of k_{35} is extremely weak, so that can be ignored [6, 21]. Based on the results shown in Fig. 6(b) and (c), the direct non-radiative transition rate k_{IC} could also be neglected. Therefore, $k_0 = k_{31} + k_{ir}$ and $k_{\pm 1} = k_{42} + k_{45} + k_{ir}$. For the PL1 center, based on the comparison and analysis of the above calculated and experimentally measured radiative lifetimes, we concluded that under normal circumstances, the contribution of k_{ir} is very small and can also be ignored there. Taking data shown in Table V, the ideal ODMR contrast $\mathcal{C} = -19.49\%$. For the PLX1 center without considering k_{ir} , based on parameters shown in Table V, the resulted contrast is -0.6% . As mentioned above, the ionization (recombination) transition (with rate of k_{ir}) may play an important role in the whole transition loop, which results in the deviation between the calculated radiative lifetime and the experimental measured excited state lifetime when ignoring the k_{IC} and precipitously decrease the contrast to -0.11% [23]. Additionally, the ideal contrast calculated by Eq. (44) rests upon several basic assumptions [21]. However, real-world experiments are imperfect and can result in a lower contrast (in absolute values) than predicted. This deviation from the theoretical limit is influenced by factors such as setup performance, sample preparation, pulse sequence design, and the test environment. Eq. (44) provides an upper bound for the pulsed microwave ODMR contrast that can be principally approached by optimizing the sam-

ples, optical and microwave controls, and protocols in the experiments.

V. CONCLUSION

In this work, we comprehensively investigate the microscopic magneto-optical properties and optical spinpolarization of PL1 and PLX1 centers in 4H-SiC for potential qubit applications in quantum information science by employing the first-principles calculations. First, we present a detailed overview of the KS levels with a quantitative sketch, followed by a thorough analysis of the two-particle basis functions within the hole notation and their intrinsic hierarchy. The DJT-reduced SOC is fully investigated to deduce the ISC transition rates. Additionally, the ZFS among different spin sublevels of both the ground and excited triplet states is computed, which provides key parameters of the ODMR protocol and, along with the parallel component of SOC, determines the fine energy structure. Moreover, the upper and lower branches of the ISC transition mediated by the electron-phonon coupling are well demonstrated, particularly unveiling the JT nature in different cases. The PL lifetime of excited triplet states is also investigated in detail. Finally, based on the calculated major transition rates among key states, an optical spinpolarization loop is fully assembled, and the optimal ODMR contrast is derived in detail. This work reveals the electron-phonon coupling mechanism underlying the optical spinpolarization. Our results imply that there is potential to optimize the ODMR contrast of the PL1 and PLX1 centers, which is of high importance to versatile applications such as increasing the sensitivity in quantum sensing.

ACKNOWLEDGMENTS

Support by the Ministry of Culture and Innovation and the National Research, Development and Innovation Office within the Quantum Information National Laboratory of Hungary (Grant No. 2022-2.1.1-NL-2022-00004) is much appreciated. AG acknowledges the high-performance computational resources provided by KIFÜ (Governmental Agency for IT Development) institute of Hungary and the European Commission for the projects QuMicro (Grant No. 101046911) and SPINUS (Grant No. 101135699).

Appendix A: SOC calculation details

The calculation of SOC based on the most commonly used standard supercell size, $a \times b \times c = 6 \times 6 \times 2$ with 576 atoms, will not fully converge. Hence, we use various supercell sizes to calculate the λ_z . However, 4H-SiC is a hexagonal crystal system, so we cannot simultaneously expand the supercell in the x , y , and z directions

like a cubic diamond. We expand a , b , and c lattice constants in two directions separately, where a and b are expanded together, and c is expanded solely. We changed the transverse size ($a \times b$) to (5×5) , (6×6) , (7×7) , and (8×8) and changed the longitude direction c to 1, 2, 3, and 4, respectively. The strength of λ_z arises from the splitting of the two double-degenerate e levels when both levels are half occupied. The total energy is converged to 10^{-7} eV with a fixed high-symmetry geometry. Besides, the large supercell size ensures sufficient accuracy for calculating λ_z using the Perdew–Burke–Ernzerhof (PBE) functional [56, 77]. The calculated λ_z of all the supercell size cases are shown in Table VII.

From Table VII, we find that the value of λ_z changes differently when the supercell size changes along the c -axis compared to when it changes along the a and b axes simultaneously and synchronously. Therefore, it is necessary to fit the various results using a composite function that can contain two trends at the same time and obtain a convergence value to reflect the characteristics of an isolated qubit. Unlike in NV-diamond, the extension of the color center’s wave function along the transverse (a and b axes) and axial (c axis) directions is not identical in 4H-SiC. Hence, the most practical fitting function is composite exponential functions with an expression as

$$\lambda_z(x_{ab}, y_c) = A \cdot \exp(B \cdot x_{ab} + C \cdot y_c) + \lambda_{z0}, \quad (\text{A1})$$

where A , B , C , and λ_{z0} are fitting parameters; $x_{ab} = \frac{2}{\sqrt{3}ab}$ represents the reciprocal of the supercell cross-sectional area, $y_c = c$, and λ_{z0} corresponds to the SOC for an isolated qubit. The final fitted convergent λ_{z0} is 18.501 and 9.664 GHz for PL1 and PLX1 centers, respectively.

Appendix B: Electron-phonon coupling coefficients and the reduction factors

The p factor derived from the electron-phonon coupling coefficients implies a mixture between $|E^+\rangle$ and $|E^-\rangle$ of $|^3E\rangle$, which quenches the effective angular momentum [60]. The p factor is obtained in the following initial form of $p = \sum_{nm}(c_{nm}^2 - d_{nm}^2)$ in Eq. (22). Based on the rewritten symmetry adapted wavefunctions of Eq. (24), the reduction factors p and q are obtained from

$$p = \sum_i (c_i^2 - d_i^2 + f_i^2), \quad q = \sum_i (c_i^2 - f_i^2) \quad (\text{B1})$$

where c_i^2 , d_i^2 , and f_i^2 are expansion coefficients by solving the electron-phonon Hamiltonian Eq. (20). The expansion is limited up to six oscillator quanta ($m+n \leq 6$) for numerical convergence of $< 1\%$, which is more than the NV-diamond ($m+n \leq 4$) [60] because of the larger E_{JT} and smaller $\hbar\omega_e$ of the two centers than those of NV-diamond. Table VI displays the calculated values of c_i , d_i , and f_i . Still, in Table VI, we present the row only up

TABLE VI. Coefficients utilized in both upper and lower branches.

$i = m + n$	PL1						PLX1					
	c_i^2	$c_i'^2$	d_i^2	$d_i'^2$	f_i^2	$f_i'^2$	c_i^2	$c_i'^2$	d_i^2	$d_i'^2$	f_i^2	$f_i'^2$
0	0.274	0.000	0.000	0.000	0.000	0.940	0.301	0.960	0.000	0.000	0.000	0.000
1	0.000	0.027	0.328	0.007	0.000	0.000	0.000	0.000	0.334	0.006	0.000	0.017
2	0.201	0.013	0.013	0.000	0.000	0.010	0.186	0.007	0.016	0.000	0.000	0.009
3	0.010	0.000	0.093	0.000	0.010	0.001	0.011	0.000	0.080	0.000	0.011	0.000
4	0.029	0.000	0.013	0.000	0.000	0.000	0.023	0.000	0.014	0.000	0.000	0.000
5	0.003	0.000	0.010	0.000	0.003	0.000	0.003	0.000	0.008	0.000	0.003	0.000
...
Sum	0.519	0.041	0.460	0.008	0.012	0.951	0.526	0.967	0.454	0.007	0.013	0.026

TABLE VII. Calculated λ_z values of all cases of supercell size.

Supercell size $a \times b \times c$	Volume (\AA^3)	No. of atoms	λ_z (GHz)	
			PL1	PLX1
$5 \times 5 \times 1$	2087.98	198	31.07	22.00
$5 \times 5 \times 2$	4175.96	400	22.49	17.65
$5 \times 5 \times 3$	6263.94	598	21.88	17.77
$5 \times 5 \times 4$	8351.92	798	21.52	17.65
$6 \times 6 \times 1$	3006.69	288	29.98	25.03
$6 \times 6 \times 2$	6013.39	576	24.06	23.45
$6 \times 6 \times 3$	9020.08	864	23.58	23.33
$6 \times 6 \times 4$	12026.77	1152	23.21	23.33
$7 \times 7 \times 1$	4092.44	390	33.97	31.31
$7 \times 7 \times 2$	8184.89	784	29.98	31.55
$7 \times 7 \times 3$	12277.33	1174	29.14	31.31
$7 \times 7 \times 4$	16369.77	1566	29.14	31.19
$8 \times 8 \times 1$	5345.23	510	37.84	35.79
$8 \times 8 \times 2$	10690.46	1024	34.34	36.51
$8 \times 8 \times 3$	16035.70	1534	33.85	36.51
$8 \times 8 \times 4$	21380.93	2046	33.97	36.51

to 5 since all coefficients are so small to be ignored when $i > 5$. The expressions of symmetry-adapted vibrational wavefunctions $|\varrho_i(\Gamma_i)\rangle$ in Eq. (24) are shown in Table III. From Table VI we find that $|\varrho_i(E_{1,2})\rangle$ phonon functions has a minimum quantum number of $i = 1$ and $|\varrho_i(A_2)\rangle$ phonon function has a minimum quantum number of $i = 3$. Besides, the p factor resulted from quadratic DJT with the barrier energy because it will be 10% smaller when using only the linear DJT approximation. Based on data displayed in Table VI, the p factors are derived with values of 0.070 and 0.087 for PL1 and PLX1 centers, respectively. Though there is always a discrepancy between experimental and theoretical results, our results and analysis still contribute to the further understanding of complex physical systems when containing the JT effect. Besides, based on data displayed in Table VI, the

q factors are calculated and show the values of 0.507 and 0.513 for PL1 and PLX1 centers, respectively.

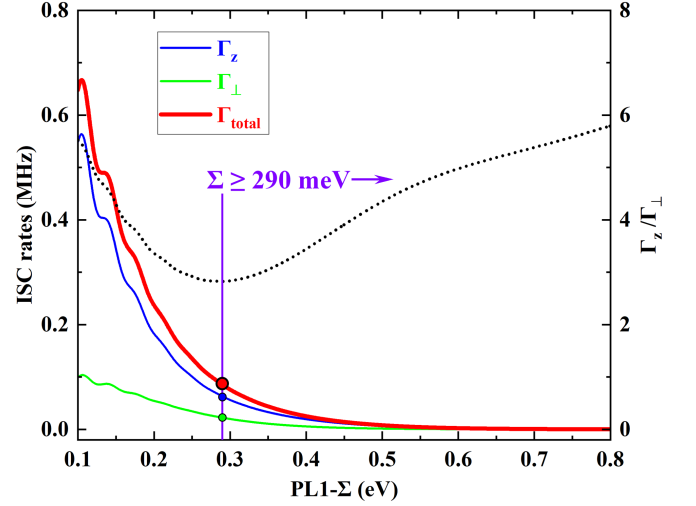
FIG. 7. Calculated ISC rates and Γ_z/Γ_\perp ratios in the lower branch of PL1 center utilizing parameters in Ref. 71.

Table VI displays the electron-phonon coupling coefficients defined in Eq. (36) in the lower branch of the ISC transition. The determination of the phonon limitation is $i = 10$ to satisfy numerical convergence. The coefficient $g_i'^2$ for the lower branch is very small and can be ignored. Ref. 71 also provides key parameters obtained from the multiconfigurational approach, including $\Sigma_{\text{PL1}'} = 290$ meV, $\Lambda = 620$ meV and $C^2 = 0.88$. The larger $\Sigma_{\text{PL1}'}$ in comparison to this work may arise from the fact that the JT effect is not involved and the vertical transition is considered there. Combining the vibrational calculations of this work, the lower branch rate is demonstrated and shown in Fig. 7. From Fig. 7, we find that $\Gamma_z(\Gamma_\perp) = 0.06(0.02)$ MHz and $\Gamma_z/\Gamma_\perp = 2.83$ at $\Sigma_{\text{PL1}'} = 290$ meV, consistent with the findings of this work.

-
- [1] J. Preskill, Quantum Computing in the NISQ era and beyond, *Quantum* **2**, 79 (2018).
- [2] Á. Gali, Recent advances in the ab initio theory of solid-state defect qubits, *Nanophotonics* **12**, 359 (2023).
- [3] A. Chatterjee, P. Stevenson, S. De Franceschi, A. Morello, N. P. de Leon, and F. Kuemmeth, Semiconductor qubits in practice, *Nature Reviews Physics* **3**, 157 (2021).
- [4] G. Wolfowicz, F. J. Heremans, C. P. Anderson, S. Kanai, H. Seo, A. Gali, G. Galli, and D. D. Awschalom, Quantum guidelines for solid-state spin defects, *Nature Reviews Materials* **6**, 906 (2021).
- [5] M. Atatüre, D. Englund, N. Vamivakas, S.-Y. Lee, and J. Wrachtrup, Material platforms for spin-based photonic quantum technologies, *Nature Reviews Materials* **3**, 38 (2018).
- [6] Á. Gali, Ab initio theory of the nitrogen-vacancy center in diamond, *Nanophotonics* **8**, 1907 (2019).
- [7] M. W. Doherty, N. B. Manson, P. Delaney, and L. C. Hollenberg, The negatively charged nitrogen-vacancy centre in diamond: the electronic solution, *New Journal of Physics* **13**, 025019 (2011).
- [8] M. W. Doherty, N. B. Manson, P. Delaney, F. Jelezko, J. Wrachtrup, and L. C. Hollenberg, The nitrogen-vacancy colour centre in diamond, *Physics Reports* **528**, 1 (2013).
- [9] J. R. Maze, A. Gali, E. Togan, Y. Chu, A. Trifonov, E. Kaxiras, and M. D. Lukin, Properties of nitrogen-vacancy centers in diamond: the group theoretic approach, *New Journal of Physics* **13**, 025025 (2011).
- [10] J. Du, F. Shi, X. Kong, F. Jelezko, and J. Wrachtrup, Single-molecule scale magnetic resonance spectroscopy using quantum diamond sensors, *Reviews of Modern Physics* **96**, 025001 (2024).
- [11] J. F. Barry, J. M. Schloss, E. Bauch, M. J. Turner, C. A. Hart, L. M. Pham, and R. L. Walsworth, Sensitivity optimization for nv-diamond magnetometry, *Reviews of Modern Physics* **92**, 015004 (2020).
- [12] S. Pezzagna and J. Meijer, Quantum computer based on color centers in diamond, *Applied Physics Reviews* **8** (2021).
- [13] C. L. Degen, F. Reinhard, and P. Cappellaro, Quantum sensing, *Reviews of Modern Physics* **89**, 035002 (2017).
- [14] W. F. Koehl, B. B. Buckley, F. J. Heremans, G. Calusine, and D. D. Awschalom, Room temperature coherent control of defect spin qubits in silicon carbide, *Nature* **479**, 84 (2011).
- [15] A. Csóré, I. G. Ivanov, N. T. Son, and A. Gali, Fluorescence spectrum and charge state control of divacancy qubits via illumination at elevated temperatures in 4h silicon carbide, *Physical Review B* **105**, 165108 (2022).
- [16] W. E. Carlos, N. Y. Garces, E. R. Glaser, and M. A. Fanton, Annealing of multivacancy defects in 4h-SiC, *Physical Review B* **74**, 235201 (2006).
- [17] B. Magnusson and E. Janzén, Optical characterization of deep level defects in sic, in *Materials Science Forum*, Vol. 483 (Trans Tech Publ, 2005) pp. 341–346.
- [18] N. T. Son, P. Carlsson, J. ul Hassan, E. Janzén, T. Umeda, J. Isoya, A. Gali, M. Bockstedte, N. Morishita, T. Ohshima, and H. Itoh, Divacancy in 4h-sic, *Physical Review Letters* **96**, 055501 (2006).
- [19] S. A. Zargaleh, B. Eble, S. Hameau, J.-L. Cantin, L. Legrand, M. Bernard, F. Margaillan, J.-S. Lauret, J.-F. Roch, H. J. von Bardeleben, E. Rauls, U. Gerstmann, and F. Treussart, Evidence for near-infrared photoluminescence of nitrogen vacancy centers in 4h-SiC, *Physical Review B* **94**, 060102 (2016).
- [20] S. A. Zargaleh, H. J. von Bardeleben, J. L. Cantin, U. Gerstmann, S. Hameau, B. Eblé, and W. Gao, Electron paramagnetic resonance tagged high-resolution excitation spectroscopy of nv-centers in 4h-sic, *Physical Review B* **98**, 214113 (2018).
- [21] Q. Li, J.-F. Wang, F.-F. Yan, J.-Y. Zhou, H.-F. Wang, H. Liu, L.-P. Guo, X. Zhou, A. Gali, Z.-H. Liu, *et al.*, Room-temperature coherent manipulation of single-spin qubits in silicon carbide with a high readout contrast, *National Science Review* **9**, nwab122 (2022).
- [22] A. L. Falk, B. B. Buckley, G. Calusine, W. F. Koehl, V. V. Dobrovitski, A. Politi, C. A. Zorman, P. X.-L. Feng, and D. D. Awschalom, Polytype control of spin qubits in silicon carbide, *Nature communications* **4**, 1819 (2013).
- [23] J.-F. Wang, F.-F. Yan, Q. Li, Z.-H. Liu, H. Liu, G.-P. Guo, L.-P. Guo, X. Zhou, J.-M. Cui, J. Wang, Z.-Q. Zhou, X.-Y. Xu, J.-S. Xu, C.-F. Li, and G.-C. Guo, Coherent control of nitrogen-vacancy center spins in silicon carbide at room temperature, *Physical Review Letters* **124**, 223601 (2020).
- [24] A. L. Crook, C. P. Anderson, K. C. Miao, A. Bourassa, H. Lee, S. L. Bayliss, D. O. Bracher, X. Zhang, H. Abe, T. Ohshima, *et al.*, Purcell enhancement of a single silicon carbide color center with coherent spin control, *Nano letters* **20**, 3427 (2020).
- [25] G. Wolfowicz, C. P. Anderson, A. L. Yeats, S. J. Whiteley, J. Niklas, O. G. Poluektov, F. J. Heremans, and D. D. Awschalom, Optical charge state control of spin defects in 4h-sic, *Nature communications* **8**, 1876 (2017).
- [26] D. J. Christle, P. V. Klimov, C. F. de las Casas, K. Szász, V. Ivády, V. Jokubavicius, J. Ul Hassan, M. Syväjärvi, W. F. Koehl, T. Ohshima, N. T. Son, E. Janzén, A. Gali, and D. D. Awschalom, Isolated spin qubits in sic with a high-fidelity infrared spin-to-photon interface, *Physical Review X* **7**, 021046 (2017).
- [27] D. J. Christle, A. L. Falk, P. Andrich, P. V. Klimov, J. U. Hassan, N. T. Son, E. Janzén, T. Ohshima, and D. D. Awschalom, Isolated electron spins in silicon carbide with millisecond coherence times, *Nature materials* **14**, 160 (2015).
- [28] A. L. Falk, P. V. Klimov, B. B. Buckley, V. Ivády, I. A. Abrikosov, G. Calusine, W. F. Koehl, A. Gali, and D. D. Awschalom, Electrically and mechanically tunable electron spins in silicon carbide color centers, *Physical Review Letters* **112**, 187601 (2014).
- [29] N. Son, D. Shafizadeh, T. Ohshima, and I. Ivanov, Modified divacancies in 4h-sic, *Journal of Applied Physics* **132** (2022).
- [30] G. Wolfowicz, S. Whiteley, and D. Awschalom, Electrometry by optical charge conversion of deep defects in 4h-sic, *Proceedings of the National Academy of Sciences* **115**, 7879 (2018).
- [31] Y. Zhu, B. Kivos, M. Onizhuk, D. Awschalom, and G. Galli, Theoretical and experimental study of the nitrogen-vacancy center in 4h-sic, *Physical Review Ma-*

- terials **5**, 074602 (2021).
- [32] Z. Mu, S. A. Zargaleh, H. J. von Bardeleben, J. E. Fröch, M. Nonahal, H. Cai, X. Yang, J. Yang, X. Li, I. Aharonovich, *et al.*, Coherent manipulation with resonant excitation and single emitter creation of nitrogen vacancy centers in 4h silicon carbide, *Nano Letters* **20**, 6142 (2020).
- [33] Z. Jiang, H. Cai, R. Cernansky, X. Liu, and W. Gao, Quantum sensing of radio-frequency signal with nv centers in sic, *Science advances* **9**, eadg2080 (2023).
- [34] J.-F. Wang, Z.-H. Liu, F.-F. Yan, Q. Li, X.-G. Yang, L. Guo, X. Zhou, W. Huang, J.-S. Xu, C.-F. Li, *et al.*, Experimental optical properties of single nitrogen vacancy centers in silicon carbide at room temperature, *Acs Photonics* **7**, 1611 (2020).
- [35] K. Khazen and H. J. von Bardeleben, Nv-centers in sic: A solution for quantum computing technology?, *Frontiers in Quantum Science and Technology* **2**, 1115039 (2023).
- [36] A. Csóré, H. J. von Bardeleben, J. L. Cantin, and A. Gali, Characterization and formation of nv centers in 3c, 4h, and 6h sic: An ab initio study, *Physical Review B* **96**, 085204 (2017).
- [37] H. J. von Bardeleben, J. L. Cantin, A. Csóré, A. Gali, E. Rauls, and U. Gerstmann, Nv centers in 3c, 4h, and 6h silicon carbide: A variable platform for solid-state qubits and nanosensors, *Physical Review B* **94**, 121202 (2016).
- [38] H. J. von Bardeleben, J. L. Cantin, E. Rauls, and U. Gerstmann, Identification and magneto-optical properties of the nv center in 4h – SiC, *Physical Review B* **92**, 064104 (2015).
- [39] J.-F. Wang, J.-Y. Zhou, Q. Li, F.-F. Yan, M. Yang, W.-X. Lin, Z.-Y. Hao, Z.-P. Li, Z.-H. Liu, W. Liu, *et al.*, Optical charge state manipulation of divacancy spins in silicon carbide under resonant excitation, *Photonics Research* **9**, 1752 (2021).
- [40] C. P. Anderson, A. Bourassa, K. C. Miao, G. Wolfowicz, P. J. Mintun, A. L. Crook, H. Abe, J. Ul Hassan, N. T. Son, T. Ohshima, *et al.*, Electrical and optical control of single spins integrated in scalable semiconductor devices, *Science* **366**, 1225 (2019).
- [41] S. Ecker, M. Fink, T. Scheidl, P. Sohr, R. Ursin, M. J. Arshad, C. Bonato, P. Cilibrizzi, A. Gali, P. Udvarhelyi, *et al.*, Quantum communication networks with defects in silicon carbide, *arXiv preprint arXiv:2403.03284* (2024).
- [42] A. Csóré and A. Gali, Point defects in silicon carbide for quantum technology, *Wide Bandgap Semiconductors for Power Electronics: Materials, Devices, Applications* **2**, 503 (2021).
- [43] C. P. Anderson, E. O. Glen, C. Zeledon, A. Bourassa, Y. Jin, Y. Zhu, C. Vorwerk, A. L. Crook, H. Abe, J. Ul-Hassan, *et al.*, Five-second coherence of a single spin with single-shot readout in silicon carbide, *Science advances* **8**, eabm5912 (2022).
- [44] B. Magnusson, N. T. Son, A. Csóré, A. Gällström, T. Ohshima, A. Gali, and I. G. Ivanov, Excitation properties of the divacancy in 4h-sic, *Physical Review B* **98**, 195202 (2018).
- [45] D. Shafizadeh, J. Davidsson, T. Ohshima, I. A. Abrikosov, N. T. Son, and I. G. Ivanov, Selection rules in the excitation of the divacancy and the nitrogen-vacancy pair in 4 h-and 6 h-sic, *Physical Review B* **109**, 235203 (2024).
- [46] A. Csóré, N. Mukesh, G. Károlyházy, D. Beke, and A. Gali, Photoluminescence spectrum of divacancy in porous and nanocrystalline cubic silicon carbide, *Journal of Applied Physics* **131** (2022).
- [47] G. Kresse and J. Furthmüller, Efficient iterative schemes for ab initio total-energy calculations using a plane-wave basis set, *Physical Review B* **54**, 11169 (1996).
- [48] G. Kresse and J. Hafner, Ab initio molecular dynamics for liquid metals, *Physical Review B* **47**, 558 (1993).
- [49] G. Kresse and J. Furthmüller, Efficiency of ab-initio total energy calculations for metals and semiconductors using a plane-wave basis set, *Computational materials science* **6**, 15 (1996).
- [50] J. Paier, M. Marsman, K. Hummer, G. Kresse, I. C. Gerber, and J. G. Ángyán, Screened hybrid density functionals applied to solids, *The Journal of chemical physics* **124** (2006).
- [51] J. Heyd, G. E. Scuseria, and M. Ernzerhof, Hybrid functionals based on a screened coulomb potential, *The Journal of chemical physics* **118**, 8207 (2003).
- [52] A. V. Krukau, O. A. Vydrov, A. F. Izmaylov, and G. E. Scuseria, Influence of the exchange screening parameter on the performance of screened hybrid functionals, *The Journal of chemical physics* **125** (2006).
- [53] P. Deák, B. Aradi, T. Frauenheim, E. Jánzén, and A. Gali, Accurate defect levels obtained from the hse06 range-separated hybrid functional, *Physical Review B* **81**, 153203 (2010).
- [54] A. Gali, E. Jánzén, P. Deák, G. Kresse, and E. Kaxiras, Theory of spin-conserving excitation of the $n-V^-$ center in diamond, *Physical Review Letters* **103**, 186404 (2009).
- [55] G. Thiering and A. Gali, Theory of the optical spin-polarization loop of the nitrogen-vacancy center in diamond, *Physical Review B* **98**, 085207 (2018).
- [56] S. Steiner, S. Khmelevskiy, M. Marsmann, and G. Kresse, Calculation of the magnetic anisotropy with projected-augmented-wave methodology and the case study of disordered $\text{Fe}_{1-x}\text{Co}_x$ alloys, *Physical Review B* **93**, 224425 (2016).
- [57] Z. Bodrog and A. Gali, The spin–spin zero-field splitting tensor in the projector-augmented-wave method, *Journal of Physics: Condensed Matter* **26**, 015305 (2013).
- [58] G. Bian, J. Zhang, L. Xu, P. Fan, M. Li, C. Wu, J. Li, H. Wang, Q. Zhang, Z. Cai, *et al.*, Symmetry-protected two-level system in the H3 center enabled by a spin–photon interface: A competitive qubit candidate for the nisq technology, *Advanced Quantum Technologies* **5**, 2200044 (2022).
- [59] M. E. Levinshtein, S. L. Rumyantsev, and M. S. Shur, *Properties of Advanced Semiconductor Materials: GaN, AlN, InN, BN, SiC, SiGe* (John Wiley & Sons, 2001).
- [60] G. Thiering and A. Gali, Ab initio calculation of spin-orbit coupling for an NV center in diamond exhibiting dynamic jahn-teller effect, *Physical Review B* **96**, 081115 (2017).
- [61] F. S. Ham, Effect of linear jahn-teller coupling on paramagnetic resonance in a 2e state, *Physical Review* **166**, 307 (1968).
- [62] I. Bersuker, *The Jahn-Teller Effect* (Cambridge University Press, 2006).
- [63] I. B. Bersuker and V. Z. Polinger, *Vibronic interactions in molecules and crystals*, Vol. 49 (Springer Science & Business Media, 2012).
- [64] M. L. Goldman, M. W. Doherty, A. Sipahigil, N. Y. Yao, S. D. Bennett, N. B. Manson, A. Kubanek, and M. D. Lukin, State-selective intersystem crossing in nitrogen-

- vacancy centers, *Physical Review B* **91**, 165201 (2015).
- [65] A. Gruber, A. Drabenstedt, C. Tietz, L. Fleury, J. Wrachtrup, and C. v. Borczyskowski, Scanning confocal optical microscopy and magnetic resonance on single defect centers, *Science* **276**, 2012 (1997).
- [66] V. Ivády, T. Simon, J. R. Maze, I. A. Abrikosov, and A. Gali, Pressure and temperature dependence of the zero-field splitting in the ground state of NV centers in diamond: A first-principles study, *Physical Review B* **90**, 235205 (2014).
- [67] T. Biktagirov, W. G. Schmidt, and U. Gerstmann, Spin decontamination for magnetic dipolar coupling calculations: Application to high-spin molecules and solid-state spin qubits, *Physical Review Research* **2**, 022024 (2020).
- [68] G. Thiering and A. Gali, Nuclear spin relaxation in solid state defect quantum bits via electron-phonon coupling in their optical excited state, *arXiv preprint arXiv:2402.19418* (2024).
- [69] S. Evangelou, M. O'Brien, and R. Perkins, Ham factors in multi-mode jahn-teller systems, *Journal of Physics C: Solid State Physics* **13**, 4175 (1980).
- [70] M. L. Goldman, A. Sipahigil, M. Doherty, N. Y. Yao, S. Bennett, M. Markham, D. Twitchen, N. Manson, A. Kubanek, and M. D. Lukin, Phonon-induced population dynamics and intersystem crossing in nitrogen-vacancy centers, *Physical Review Letters* **114**, 145502 (2015).
- [71] M. Bockstedte, F. Schütz, T. Garratt, V. Ivády, and A. Gali, Ab initio description of highly correlated states in defects for realizing quantum bits, *npj Quantum Materials* **3**, 31 (2018).
- [72] A. Nizovtsev, S. Y. Kilin, C. Tietz, F. Jelezko, and J. Wrachtrup, Modeling fluorescence of single nitrogen-vacancy defect centers in diamond, *Physica B: Condensed Matter* **308**, 608 (2001).
- [73] Z. Yuan, M. Fitzpatrick, L. V. Rodgers, S. Sangtawesin, S. Srinivasan, and N. P. De Leon, Charge state dynamics and optically detected electron spin resonance contrast of shallow nitrogen-vacancy centers in diamond, *Physical Review Research* **2**, 033263 (2020).
- [74] J. Davidsson, Theoretical polarization of zero phonon lines in point defects, *Journal of Physics: Condensed Matter* **32**, 385502 (2020).
- [75] M. Mohseni, P. Udvarhelyi, G. Thiering, and A. Gali, Positively charged carbon vacancy defect as a near-infrared emitter in 4h-sic, *Physical Review Materials* **7**, 096202 (2023).
- [76] Y. Ping and T. J. Smart, Computational design of quantum defects in two-dimensional materials, *Nature Computational Science* **1**, 646 (2021).
- [77] J. P. Perdew, K. Burke, and M. Ernzerhof, Generalized gradient approximation made simple, *Physical Review Letters* **77**, 3865 (1996).