

---

# A CRITICAL ANALYSIS ON MACHINE LEARNING TECHNIQUES FOR VIDEO-BASED HUMAN ACTIVITY RECOGNITION OF SURVEILLANCE SYSTEMS: A REVIEW

---

**Shahriar Jahan, Roknuzzaman, Md Robiul Islam**

Department of Mechatronics Engineering

Rajshahi University of Engineering & Technology

Rajshahi-6204, Bangladesh

shahriar.sakib.glhs@gmail.com, lara051195@gmail.com, robiulislam07@gmail.com

## ABSTRACT

Upsurging abnormal activities in crowded locations such as airports, train stations, bus stops, shopping malls, etc., urges the necessity for an intelligent surveillance system. An intelligent surveillance system can differentiate between normal and suspicious activities from real-time video analysis that will enable to take appropriate measures regarding the level of an anomaly instantaneously and efficiently. Video-based human activity recognition has intrigued many researchers with its pressing issues and a variety of applications ranging from simple hand gesture recognition to crucial behavior recognition in a surveillance system. This paper provides a critical survey of video-based Human Activity Recognition (HAR) techniques beginning with an examination of basic approaches for detecting and recognizing suspicious behavior followed by a critical analysis of machine learning and deep learning techniques such as Convolutional Neural Network (CNN), Recurrent Neural Network (RNN), Hidden Markov Model (HMM), K-means Clustering etc. A detailed investigation and comparison are done on these learning techniques on the basis of feature extraction techniques, parameter initialization, and optimization algorithms, accuracy, etc. The purpose of this review is to prioritize positive schemes and to assist researchers with emerging advancements in this field's future endeavors. This paper also pragmatically discusses existing challenges in the field of HAR and examines the prospects in the field.

**Keywords** Human Activity Recognition · Surveillance · Anomaly · CNN · RNN · KNN · SVM · HMM · K-means clustering.

## 1 Introduction

There have been alarming rates of crime of different kinds around the world. The manual surveillance system which depends on the human security guards demands more effort and financial expenses. Thus the existing surveillance systems have lost their credibility and therefore, arise the need for an artificial intelligence-based video surveillance system [1] and that requires Human Activity Recognition (HAR). Video-based HAR can generally be classified into two groups depending on motion feature, i.e. marker-based and vision-based where the first-mentioned refers to as optical marker-based motion capture (MoCap) system, and the second-mentioned is formed on depth video cameras which are marker-free. Because of that particular reason, the latter can be used for HAR in the surveillance system. In recent years, recognition using Deep Learning (DL) has gained tremendous prominence because of its ability to learn deep structures of patterns. DL methods are becoming more and more highly regarded each day and gaining significant attention from pattern recognition and application researchers. As a result in the recent past, more research funding has been assigned to the particular sector. Conceptually, deep learning alludes to neural networks that utilize layers of non-linear data processing for feature classification [2]. Layers are structured hierarchically together with outcomes for preceding layers are processed by current layers. Within the realm of computer vision, DL approaches have surpassed many conventional methods [3, 4, 5, 6].

An intelligent surveillance system monitors vulnerable areas such as ATMs and banks for detecting violence, burglary, fire, and fighting-like incidents [1]. The main objective of a deep learning-based video surveillance system is to specify suspicious behavior from the captured video from certain areas where the abnormality of behavior can be categorized based on activity detection, feature extraction, classification, and recognition of the interesting patterns [2, 7]. This process has been an arising research issue as to perpetuate surveillance in an encapsulated video that contains detecting, classifying, tracking, and recognizing the doings of a human. Not having HAR has led to too many incidents turn into accidents. A few of the accidents that frequently happen which can be prevented by having a HAR system are listed below.

1. Bank robbery has been more frequent these days than in the last few decades. Lack of smart surveillance [8] the robbers often get away before the police arrive or get information about the bank getting robbed.
2. Sudden Cardiac Death (SCD) [9] is a common phenomena happening all around the world. Most cases of death have happened not getting the treatment timely or not reacting for the proper step which is to be taken.
3. ATM robbery [10] is a common scene nowadays. ATM booths all over the world are prone to severe criminal activities. In any case of criminal activity, the victims become helpless when the booths are located in remote areas. The investigation officials are aware of the crime activity only after the crime is over after the robbers escape.

Therefore, several processes have been outlined and implemented by many researchers but flawless intelligent surveillance has not been developed yet [11].

Human action recognition expects to affirm human behaviors from a video. To precisely group, input information into its covered-up category, and to successfully characterize input data into its hidden movement category is the principal objective of the human action recognition system. Contingent upon their complexity, human exercises are classified into: atomic actions, gestures, intercommunication, group actions, and behaviors. Fig. 1 explains the partition of human action as maintained by the complexities. Gestures are considered as crude developments of the body portions of an individual that may compare to a specific activity of an individual [12]. Atomic activities are developments of an individual portraying a specific movement that might be a piece of progressively complex exercises [13]. Intercommunication between people is a human exercise that includes at least two people [14]. Group activities are exercises executed by a gathering of individuals [15]. Human behavior alludes to physical activities that are related to the feelings, character, and mental conditions of a person.



Figure 1: Partition of Human Action [16]

The eyes of the video monitoring system are cameras. Cameras may be mounted in ideal positions and be dynamic in motion to help display items without obstruction. Internet protocol (IP) cameras are used for high-quality video applications. For human behavior analysis, video analysis is used. The absence of static images will maximize storage as saving all videos requires a lot of memories. This is achieved if a video recording sequence is activated when movement happens in a scene hence storage costs are reduced [1]. A human being can identify things in motion intuitively only by watching a video. But the video must be separated into a series of images first to make a computer do so. A task consisting of three elements required to overcome the issue are background subtraction [17], human tracking [18] and human action recognition [19]. Fig. 2 focuses most of the used keywords in the research field of HAR. In background separation, the system attempts to differentiate among different pieces of an image that are time-invariant. In human tracking, the system distinguishes human movement over time and motion detection helps a system to detect the video part. In human action recognition, the system confines a human movement in a motionless picture. The initial steps involved in processing a video in the HAR system consist of preprocessing, motion detection, motion tracking, feature extraction, object classification, and finally, activity recognition as shown in Fig. 3. The motion detection module consists of background modeling, foreground modeling, and foreground segmentation. Background modeling derives a background image from a frame-set. Modeling parts of the foreground puts out a vivid picture of moving objects. The segmentation of the foreground removes noise and leads to a blob representing the silhouette of the human.

Two of the common problems in the video remain among different methods of classification, the recognition problem and the localization problem [16]. One must decide the active conditions of an individual to let the system run efficiently When endeavoring to perceive human activities. Activities, for example, "handshaking" and "walking," emerge very normally in everyday life and are moderately simple to perceive. Again, increasingly complex exercises, for example, "opening a bottle", "wearing a wristwatch" are increasingly hard to identify. The improvement of a completely automated human movement detection framework, fit for ordering an individual's movements with a low mistake, is a difficult assignment because of changes in scale, background distortion, partial occlusion, frame resolution, viewpoint, and lighting.

In the last decade, a large amount of research has been conducted in the field of HAR. Table 1 represents that this paper highlights various phases of video processing techniques and provides a detailed overview and comparison of several of the most used supervised and unsupervised learning techniques and identified their limitations, result parameters, and proposed some future trends to work on, in the field of human activity recognition. The research also differentiates based on the adopted techniques of each algorithm. In this research different stages of a complete activity recognition system are separately discussed. Data preprocessing and feature extraction methods of different machine learning techniques applied in numerous previous works are briefly reviewed. Different video-based adopted features are used in different supervised and unsupervised learning techniques and the most used human action datasets are also been explored in this research. On the other hand, various similar review papers failed to cover most of these aspects and lack depth of discussion and comparison. In [20], the authors provided a review on HAR sensing technologies where lacking a thorough discussion on the feature extraction or the learning models have been noticed. Also, the research does not contain any comparison of the result parameters of the works they reviewed. [21] reviewed on video-based HAR but it also lacks comparison regarding the result parameters or any clear distinction between various approaches of the reviewed papers. Moreover, they only discussed stochastic and segmentation-based models ignoring the state of art deep learning approaches. [11] reviewed a few supervised learning and unsupervised machine learning models but did not go through full depths and also did not go through the state-of-the-art deep learning models. [22] surveyed the state of the art techniques of HAR but the emphasis was put on feature representations of actions rather than the learning methods. The discussion on datasets is also poorly represented.

Table 1: Keywords used in many research articles related to HAR.

Paper	Video Based	Sensor Based	Data Preprocessing Techniques	Dataset	Supervised Learning				Unsupervised Learning		Comparison Among Different Adopted Techniques of a Learning Method
					CNN	RNN	KNN	SVM	K-Means Clustering	HMM	
[11]	✓	✗	✓	✗	✗	✗	✗	✓	✓	✓	
[20]	✓	✓	✗	✗	✗	✗	✗	✗	✗	✗	
[21]	✓	✗	✓	✗	✗	✗	✓	✓	✗	✓	
[22]	✓	✓	✓	✓	✗	✗	✗	✗	✗	✗	
Current Work	✓	✗	✓	✓	✓	✓	✓	✓	✓	✓	

## 1.1 Paper Organization

The paper begins by explaining the need for HAR based surveillance system with a glimpse of how the system works. The outline of the paper is arranged as follows: A basic approach towards HAR is discussed in section II. A brief overview of supervised and supervised learning methods used in HAR is in sections III and IV consecutively. After that

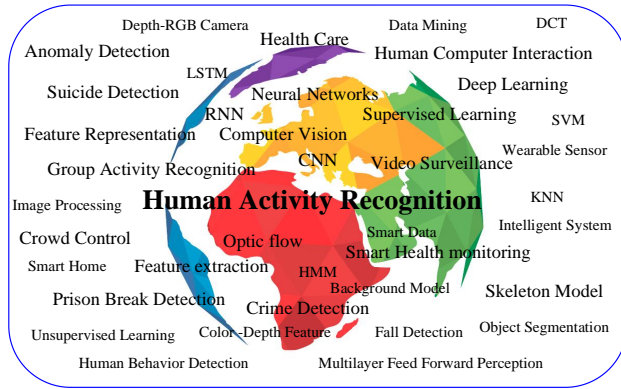

Figure 2: Keywords used in many research articles related to HAR

a detail of datasets used in HAR is discussed in section V . The challenges and future trends of the reviewed learning methods for surveillance systems are discussed in section VI with the conclusion of the work in section VII.

## 2 Basic approach towards HAR

In Fig. 3 the basic model towards HAR is shown. This model has already been used in past works of literature. This model contains important steps like preprocessing, motion detection, data filtration, feature extraction. This methodology has an advantage that is all the supervised machine learning algorithms apply it.

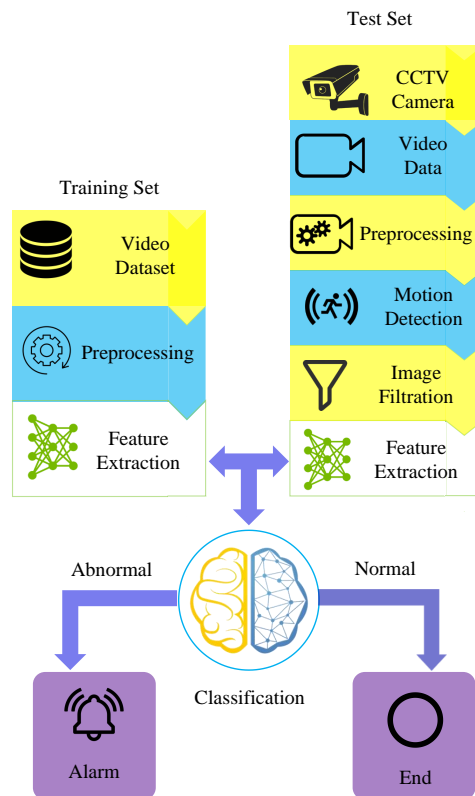

Figure 3: Basic model of activity detection and classification in intelligent surveillance system [20][23]

## **2.1 Preprocessing**

Data preprocessing is an indispensable stage in Artificial Intelligence [24]. The main intention is to get the final dataset which is acknowledged as suitable and helpful data for algorithms [25]. It was suggested by Pyle [26] that more than 50% of executed time should be spent on preprocessing. It also has a significant impression on the quality and quantity of the identified knowledge during the process [27]. The real-world dataset, associated with human activity, is extremely sensitive to noise, mechanical failures, missing including irregular data because of human faults, and to their typically large quantity which is known as dirty data. Data quality elements such as accuracy, completeness, consistency, believability, and interpretability get hampered without preprocessing. Believability resembles how much the user trusts the data and interpretability means how much the data is understandable [28]. Improvement of the data quality depends on applying suitable preprocessing techniques. For that purpose of helping to enhance the performance of the following process, [29],[26] and [30] suggested representations of established methods for outfitting data for analysis. The methods delineated by the authors are summed as follows:

### **2.1.1 Data Cleaning**

The data cleaning techniques have been formed and executed to refine data for data exploration and analysis. It is done by filling in lost values or value ascription, grading data containing noise, classifying and/or excreting outliers, and correcting inequalities [25]. Smoothing methods that are associated with discretization are likewise known as methods of data reduction. The reason behind this is it lessens the number of separated values per attribute. For Detecting outliers to remove noise, Clustering methods can also be used [25]. Overall the main task of cleaning is filling in absent data, smoothing data consisting of noise, passing anomalies, and fixing inequalities.

### **2.1.2 Data Integration**

Many systems demand the integration of collective database or multiple records [27]. A system similar to this phenomenon requires data integration as preprocessing task. Data integration merges data that are associated with the system to produce more consistent, accurate, and more useful information. From multiple real-world data sets, it takes system-oriented data and merges them into one without harming or deflecting the system result. Conventional processes achieved within the data integration are the classification and union of variables as well as domains, the study of characteristics, the duplication of tuples, and the exposure of conflicts in data values of separate sources [25].

### **2.1.3 Data Transformation**

Data transformation is a preprocessing step that transforms and/or consolidates data from real-world data. It generally makes the process result suitable for the system and makes it more efficient. The task is divided into several sub-tasks that are feature construction, smoothing, normalization, aggregation, and generalization of data [31].

### **2.1.4 Data Characterization**

Data characterization details data on how a system or a user demands. [32] outlined the following qualities that are considered as ideal for a provided dataset and they are the number of classes, the number of checks, the percentage of missing contents in each attribute, the number of qualities, the number of features with an integer data type as well as the number of features with a symbolic type of data [27]. Location parameters are quantification for example maximum, minimum, average, median, and practical quartiles although dispersion criteria such as range, standard departure, and quartile deviation render quantification that specifies the scattering contents of the class [31]. Location plus dispersion specifications are classified into two categories. One is the kind that can work with extreme values and the other is the kind that is sensitive to extreme values [25].

### **2.1.5 Data Visualization**

For the data exploration and characterization phase, having the assistance of data Visualization methods can similarly be very helpful. Visualizing data before preprocessing helps to understand the data [25]. Because of that novel and valuable knowledge can be deduced from the data. To distinguish the presence of absent contents, and anomalies, as well as to recognize correlations among characteristics, visualization methods conceivably be used which helps ranking data according to contaminants and to select the most appropriate data for the system [27].

## 2.2 Feature extraction

In the identification of patterns and pictures methods of finding a few significant points or identification points of interest that can describe the quality of the images as boundaries, Corners, cloth and so on. Feature extraction is a technique for dimension reduction where massive data are modified to features, which are designated as vectors since the larger length of the input has more data size but fewer facts.

*Data reduction* produces data that represents or replicates the raw data or real-world data but in a much smaller volume which produces the same analytical result. The reduced data provides more efficiency yet delivering the same result.

Data reduction is performed utilizing feature selection and/or instance selection. Feature selection seeks to classify the most relevant, explanatory input variables within a data set. [28] suggested the succeeding approaches for data reduction:

*Dimension reduction* is known as the process of lessening the number of arbitrary variables or traits or features under consideration. It is a data reduction task where algorithms are employed to erase unrelated and unneeded attributes [28].

*Data compression* is the data reduction process where transformations are employed to achieve a decreased or compressed rendering or replication of the real data. Two common categories are wavelet transforms and Principal Component Analysis (PCA) [33]. If the original data can be regenerated without any data loss from the compressed data then it is called lossless. If not or if there can be generated a quite approximate data that has a number of data losses then it is called lossy.

*Numerosity reduction* is the reduction process in which the data are restored or evaluated by stand-in compact data characterization acting as parametric models that just keep the paradigm specifications or non-parametric techniques for example clustering, sampling, data cube aggregation, and the application of histograms are mostly used.

There exist many other methods to organize the data reduction process. The computational time estimated to spend should not be outweighed.

## 2.3 Classification

Classification is the method of classifying the data sequences. The input data is classified in class numbers. This is normally applied to allocate freshly tested data according to the learned model into class tags. Normal and abnormal incidents are typically a question with two classes. Going a bit deeper, abnormal cases can also be classified into different levels depending on the actions of a human in a time sequence. As more complex cases arise in order to achieve human-level performance, the algorithms had to be involved.

While HAR has been an active research topic for quite a long time, traditional HAR algorithms have struggled in the past with some critical problems. Some of the major problems were:

- i. Previous HAR-based methods depended primarily on time series data where most of the features had to be hand-crafted for the AI algorithms to get a good enough accuracy. The hand-crafting feature was often a lengthy and time-consuming process.
- ii. Another problem of hand-crafted feature-based models is that these relied on a lot of factors and were not a good fit whenever subtle things such as camera movement, harsh environments such as rainy or smokey situations aroused. Because of this, these models often only worked on the datasets they were trained for, which was quite impractical.
- iii. Traditional approaches had to go through a lot of steps while detecting abnormal behavior, where the recent approaches use end-to-end models.
- iv. Traditional approaches were not accurate enough with image data, hence vision-based HAR approaches were not a viable solution until state-of-the-art deep learning solution came into the scenario which seemed to have remarkable performance in working with images.

Many researchers used different types of classifiers to identify usual and anomalous events. K-Nearest Neighbour (KNN), Support Vector Machine (SVM), Hidden Markov model (HMM) are some of the most used machine learning algorithms used in this research sector. Also, some of the state-of-the-art supervised deep learning algorithms such as Convolutional Neural Network (CNN) [34], Recurrent Neural Network (RNN), etc. have also been used. All of them are discussed in the following section. Fig. 4 shows a tree diagram of different learning methods discussed in this paper.

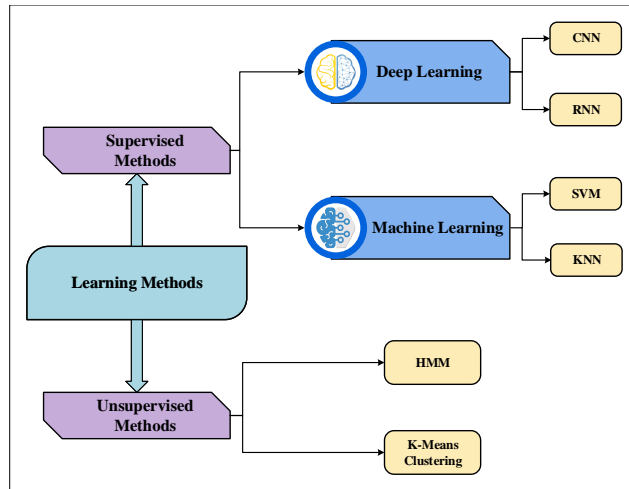

Figure 4: Tree diagram of the learning methods discussed in this paper

### 3 Anomaly Detection using Supervised Learning

An anomaly can be defined as a sequence of actions that can be used to determine whether the activity is abnormal in the context of the environment, place, or social standard. For example, people running in a marathon may be determined as a normal activity but people running in the middle of the street at an odd time may be considered an abnormal activity. Anomaly detection can be crucial in several cases such as:

- i. Sudden crowd gatherings for doing any mischievous activities.
- ii. Sudden criminal activities like people fighting, or a person getting mugged/ kidnapped/ attacked by another person.
- iii. People suddenly falling off in the street which may be a case of a heart attack or other disease.
- iv. Sudden road accidents. Supervised learning is the method of learning in which a model is trained initially with the

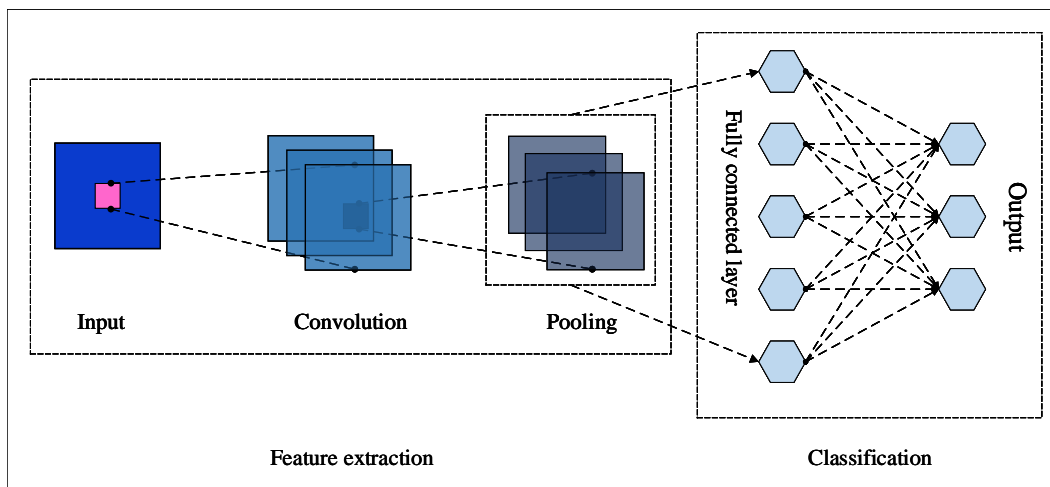

Figure 5: Basic Architecture of CNN

required dataset and after that classifies the new data given to it as an input into normal and anomaly [11]. Development in the field of HAR and anomaly detection for surveillance using supervised learning, especially deep learning methods has proven to be ground-breaking [35]. Supervised learning conceivably is severed into an individual class or multi-class problems. Thus some important classifiers for anomaly detection in HAR are discussed in this section.

### 3.1 Convolutional Neural Network

Convolutional Neural Networks (CNNs) have demonstrated their superiority in many applications [36, 37, 33]. Among them, the development of HAR systems has been greatly benefited by CNN variants. Being in the class of deep neural networks, CNN is used to peruse visual entities [38]. It employs a mathematical method named convolution operation thus named Convolutional neural network. CNN resembles more like a neural network possessing a grid-like topology in the process [39, 37]. For a neuro-scientific principle influencing deep learning, CNN stands out of all other algorithms.

CNN comprises two parts, the hierarchical feature extractor that holds the convolutional with the pooling layers, and the fully connected layer which classifies the feature vectors [40]. In the fully connected layer, hidden layers typically incorporate a sequence of convolutional layers which convolute with multiplication operations. The convolved output is passed consequently to the next layer. Fig. 5 shows a basic layer terminology of CNN. The lower layers of CNN undertake the local salient data and the higher layers undertake salient patterns from the data. However, multiple salient patterns jointly affect and resembles the output as CNN is a multilayered network [41, 42].

Manual feature extraction, as well as filtering, is not essential in CNN-based activity recognition. CNN can easily obtain complex gestures of humans while investigating nonlinear as well as time-domain interconnections [43]. Three important ideas make CNN advantageous sparse interaction, equivariant representation, and parameter sharing [44]. Space interaction is gained by declaring the kernel smaller than the input that helps to save both memory and run time. Equivariance to translation in convolution resembles the specific structure of parameter sharing [45]. [46] employed CNN with two convolutional and pooling layers that led them to result in a recognition rate of 95.9% in human action recognition.

Table 2: Comparison between different features of CNN in HAR.

Adopted Techniques	Dataset	Performance (%)		Highlights	Limitations	Ref.
		Recognition Rate	F1 score			
ReLU layer with CNN	Hand gesture	96	-	• Automatic task dependent feature extraction.	• Lengthy training time	[41]
	Opportunity	87.6	-			
ConvLSTM-ELM	Opportunity (With Null)	91.8	-	• This model can automatically learn feature representations, • It can automatically model the temporal dependencies between features. • it has better runtime with higher efficiency.	• Imbalanced dataset.	[40]
	Opportunity (Without Null)	90.6	-			
AlexNet with CNN for transfer learning	CCTV Camera	99	-	• Requires less time to train the model.	• Calculation complexity.	[47]
PCAnet with MHOF, ODF and SI	UMN	71 (Overall top 1%)	0.99978	• Detects anomaly and generates an alarm, • Dynamic and affordable.	• Calculation complexity.	[35]
	Avenue and UCF-101		0.98120			
	UCSD	-				
	UCF-101	-				
Rehabilitation motion with CNN	Smartphone and smartwatch	-	0.989	• Increased Time-window size.	• Unable to achieve sufficient learning, • Insufficient dataset.	[43]

Among the three stages in convolution, the second stage linear activation has to pervade in some nonlinear activation function which is the detector stage [44]. In the next stage, pooling is employed for the activation function to be linearized once again. The pooling layer decreases data dimension by mixing outcomes of neuron clusters which are at the current layer into a solitary neuron in the following one. The local pooling layer combines small layers where the global pooling layer works on all the neurons in the convolution [47]. Pooling can calculate the maximum value as well as the average value. Max pooling [36] operation uses maximum values which got from each of the clusters used [48], [49]. On the other hand, the average pooling operation uses the mean values got from each of the clusters used [50]. Both maximum pooling and average pooling works with a cluster of neurons at the prior layer.

In the paper [51] transfer learning technique is applied by using pre-trained CNN AlexNet [3] for abnormal activity recognition. This technique transfers knowledge gained by solving one task to solve another. Therefore, it requires less time training CNN model for new datasets compared to train it from the scratch. The author made changes to layers of the already existing CNN AlexNet architecture to distinguish the activities into two classes which are required for abnormal activity recognition. In [41], the authors constructed the CNN layer architecture in groups of five sections. In each of the first three sections incorporation of normalization layer and Rectified Linear Unit (ReLU) layer had been done to gain better results.

[40] proposed a hybrid architecture for human activity recognition where feature extraction and classification are not solely dependent on convolutional layers like the traditional algorithms. The hybrid architecture comprises convolutional



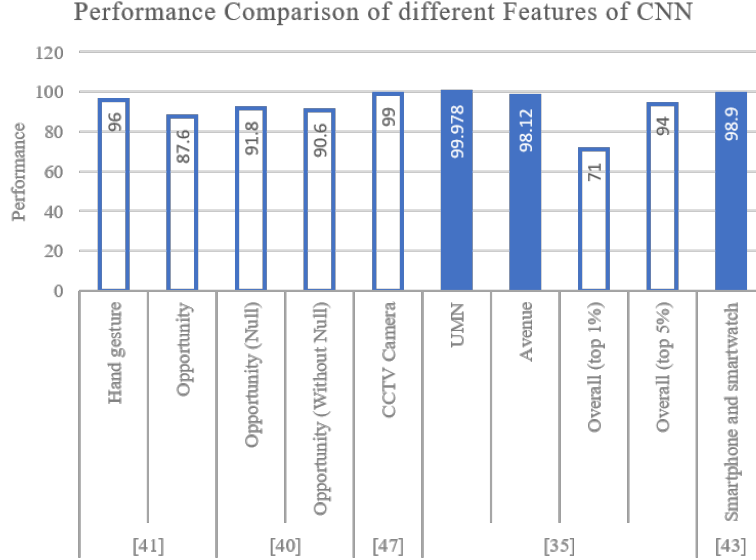

Figure 6: Histogram of the performance comparison of different features of CNN

layers for feature extraction, Long Short-Term Memory (LSTM) layers for producing temporal dependencies of the extracted features by convolutional layers, and an Extreme Learning Machine (ELM) classifier to replace the fully connected layers working on abnormal human activity classification. The main challenges faced by researchers in HAR are large varieties of classes including a massive proportion of Null classes and the similarities between the classes. Analyzing the activities and putting them into proper classes requires an enormous amount of time.

A model proposed in [52] exploiting CNN and LSTM solved this problem but real-time performance could not be achieved. Inclusion of ELM as a classifier immensely improved real-time performance that has been shown in [40].

In [35], the authors proposed A CNN model in which at first abnormal frames will be detected then the abnormal activity in that frame will be located. Features of Saliency Information (SI) and Multi-scale Histogram of Optical Flow (MHOF) have been applied for recognizing abnormal frames. For reducing computational complexity MHOF divides each frame into many image patches and then processes them. MHOF can detect anomalies in real-time with high precision. The Principal Component Analysis (PCA) is used for higher-order extraction from the previously extracted features and those higher-level features have been trained in SVM. CNN (frame-wise classification) has an accuracy of 69% and 92% respectively in top 1 and top 5 conditions. When CNN to extract features with Recurrent Neural Network(RNN) has an accuracy of 71% and 94% respectively in top 1 and top 5 conditions. A compact representation of all the features discussed in this sub-section is compared in Table 2. Fig. 6 Shows a histogram of comparison among different features of CNN where the filled pillars represent f1 score  $\times 100\%$  and the hollow pillars represent recognition rate.

### 3.2 Recurrent Neural Network

Recurrent neural network (RNN) has been the center of focus in the domain of Deep Learning (DL) techniques since the 1990s. They are trained to recognize successive or time-varying patterns. A recurrent network is a neural network consisting of feedback linking [53] which are different from other feed-forwarding neural networks [54]. These techniques have been applied in various kinds of problems and over the last few years, it has a wide margin of effect in the field of HAR. Depending on some feature data, the activities of humans are interpreted as time-sequential variations in numerous joint angles. For that intention, a recognizing competent in encoding time-sequential data is required [2]. Fig. 7 shows the basic architecture of RNN. Thus, one of the consecutive DL approaches is needed for this type of work and data, that is Recurrent neural network [55]. Also, RNN models are generally better than CNN as they can construct embedded compositional portrayals of input data in the time domain [56]. RNNs can remember the relations between the input data and simultaneously train themselves using feedback loops [57]. However, basic RNNs have a vanishing gradient problem called the Long-Term Dependencies problem due to the back-spreading of an error signal over a long range of temporal intervals. This limits the processing of long-term information [2, 56]. Searching for the solution to

get rid of the vanishing gradient problem to learn the data in the protracted range, Long Short-Term Memory (LSTM) was proposed [58, 59, 60].

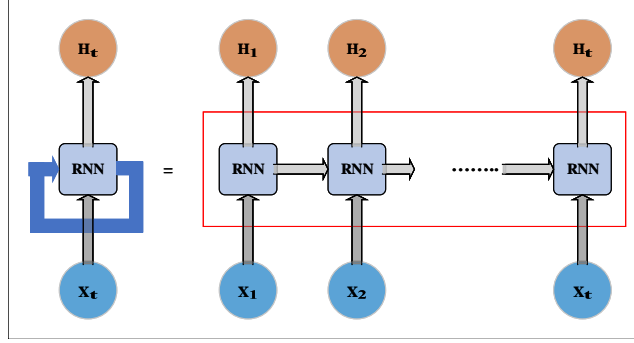

Figure 7: Basic Structure of Recurrent Neural Network [57, 61]

LSTM is a version of RNN makes up as input layer [57] and is capable of comprehending long-term reliance [62]. A block of LSTM usually contains a cell state and four different gates that are Forget gate, Input gate, Output gate, and Candidate gate . The cell state acts as an information carrier and the gates are there to control and protect that information in the cell state [63].

The input gate  $g_{ti}$  decides values that have to be updated as shown in Equation 1. The forget gate  $F_{ti}$  is used for termination of information that have to be drop out as shown in Equation 2. Cell state vector of  $s_{ti}$  is used to store the long-term memory as shown in Equation 3. The output gate  $o_{ti}$  decides output as shown in Equation 4 and the hidden state  $h_{ti}$  can be demonstrated as a multiplication of the output gate  $o_{ti}$  and the non-linear transformed cell state  $s_{ti}$  as shown in Equation 5.

$$g_{ti} = \sigma(W_{xg}x_{ti} + W_{hg}h_{ti-1} + b_g) \quad (1)$$

$$F_{ti} = \sigma(W_{xF}x_{ti} + W_{hF}h_{ti-1} + b_F) \quad (2)$$

$$s_{ti} = f_{ti}s_{ti-1} + i_{ti} \tanh(W_{xs}x_{ti} + W_{hs}h_{ti-1} + b_s) \quad (3)$$

$$o_{ti} = \sigma(W_{xo}x_{ti} + W_{ho}h_{ti-1} + b_o) \quad (4)$$

$$h_{ti} = o_{ti} \tanh(s_{ti}) \quad (5)$$

Where  $x_{ti}$  is an input sequence.  $W$  represents weight matrices.  $b$  represents bias vectors.  $\sigma$  is the logistic sigmoid function.

[64] demonstrated 3 different methods to execute LSTM-RNN for time-series classification.

### 3.2.1 Unidirectional LSTM-RNN:

A series of LSTM layers are piled until the Dense layer is applied in the unidirectional RNN model. The output provided by the bottom layer is transmitted to the upper layer as data. The general premise of the unidirectional deep RNN model [65] is shown in Fig. 9.

### 3.2.2 Bidirectional LSTM-RNN:

Bidirectional RNN [66, 67] comprised of multiple tracks as portrayed in Fig. 10. One track for a forward shift for the upcoming state and the other for a backward shift to a previous state. The outcome is achieved by figuring the average result within these two output tracks [64].

### 3.2.3 Cascaded LSTM-RNN:

Both uni-directional and bi-directional layers forms together in the Cascade model. The lower one is bidirectional in nature and the remaining ones are unidirectional [64]. The general premise of the Cascade RNN model is shown in Fig. 11.

Table 3: Comparison between different features of RNN in HAR.

Adopted Techniques	Dataset	Recognition Rate (%)	Highlights	Limitations	Ref.
RNN-LSTM with STIP and HOF	KTH	90.7	<ul style="list-style-type: none"> <li>Fast and robust system.</li> <li>Shows good efficiency in restricted settings.</li> </ul>	<ul style="list-style-type: none"> <li>Confusion exist between the activities 'Jogging' and 'Running'.</li> </ul>	[65]
dRNN with skeleton based features	KTH-1	93.96	<ul style="list-style-type: none"> <li>Delivers better performance as evolution of time.</li> </ul>	<ul style="list-style-type: none"> <li>Not tailored for some specific types of activity sequence.</li> </ul>	[66]
	KTH-2	92.12			
	MSR Action3D	92.03			
HBRNN with extracted skeleton data	MSR Action3D	94.49	<ul style="list-style-type: none"> <li>The system considered to be more robust than some other discussed deep RNN architectures.</li> <li>The system Fast and reliable.</li> <li>The recognition rate was considered to be the state-of-art at that time.</li> </ul>	<ul style="list-style-type: none"> <li>Consist of some misclassifications.</li> <li>Some other architecture might be more suitable for online applications.</li> </ul>	[67]
	Berkeley MHAD Action	100			
	HDM05	96.92 ± 0.50			
RNN-LSTM with Co-occurrence exploration and in-depth dropout	SBU Kinect interaction	90.41	<ul style="list-style-type: none"> <li>Accurate system result.</li> </ul>	<ul style="list-style-type: none"> <li>Calculation complexity.</li> </ul>	[68]
	HDM05	97.25			
	CMU	81.04			
CNN-RNN with LSTM	KTH	96.8	<ul style="list-style-type: none"> <li>Better Structure than conventional CNN.</li> </ul>	<ul style="list-style-type: none"> <li>Some misclassification exist in the system.</li> </ul>	[69], [70]
	HMDB51	65.2			
	UCF 101	92.2			
RNN-LSTM with Deep-CNN based OpenPose	Built database	98	<ul style="list-style-type: none"> <li>Superior performance was achieved.</li> <li>The system is robust.</li> <li>The system works on low-light.</li> </ul>	<ul style="list-style-type: none"> <li>Experimented on a very small dataset.</li> <li>Thermal cameras were not calibrated.</li> <li>Output of OpenPose was inconsistent.</li> </ul>	[56]

Performance Comparison of different Features of RNN

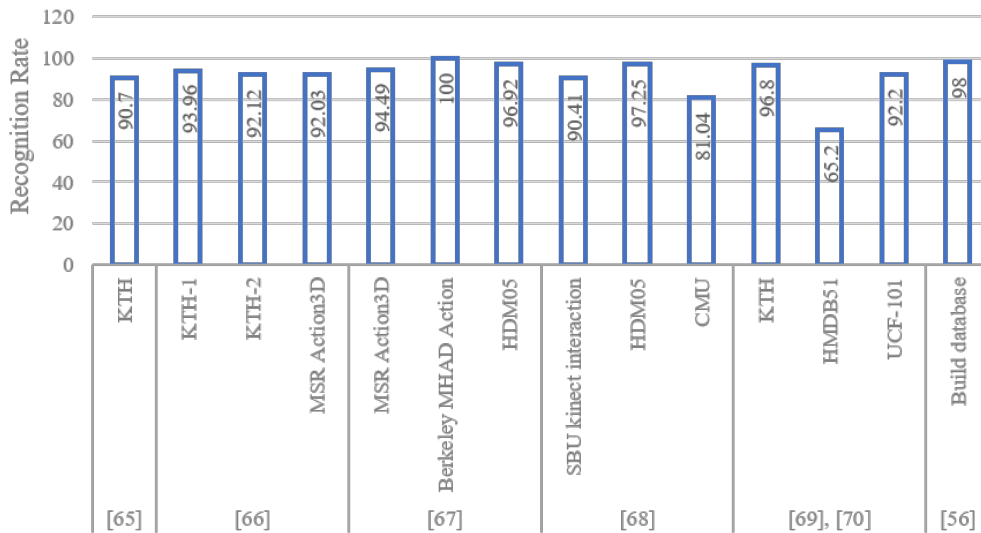

Figure 8: Histogram of the performance comparison of different features of RNN

In the paper [68], the authors used LSTM-RNN with space-time interest points(STIP) and histogram of optical flow (HOF) descriptor is used for HAR in restricted settings. The authors tried to exhibit the robustness of LSTM in the real-world scenario which has an immense impact in the field of HAR-based surveillance. Harris operator [69] was extended to find STIPs, the local regions in video from which spatiotemporal features could be extracted. A HOF descriptor was computed for each of those regions where a descriptor contained 90 elements and for each of the elements there was an input neuron in LSTM. The LSTM network also included 50 memory blocks and the quantity of output neurons was equal to the quantity of activity classes which was 6 and its initial weights were arbitrarily selected. Despite having small and noisy training data and tight deadlines for making the call on activity recognition this method had shown great performance by achieving 90.7% of the overall activity recognition rate of on KTH dataset.

[56] applied Deep-CNN based OpenPose library and non-linear discriminant feature extraction method with RNN-LSTM as the classifier for HAR. In low-light environments detecting and analyzing activities is a massive challenge as the normal colorized cameras cannot pick up the actual scenario and extracting features out of the unclear data is difficult. Therefore, the authors used a thermal camera and OpenPose library to detect human silhouettes and extract robust features. Non-linear discriminant analysis is used for further robust spatiotemporal extraction of features which

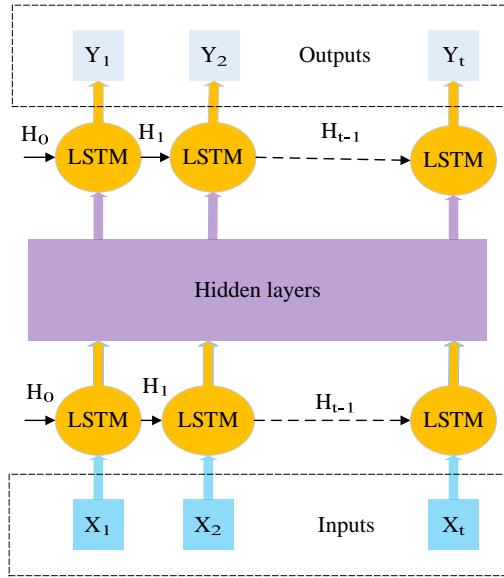

Figure 9: Unidirectional LSTM-RNN Model [57]

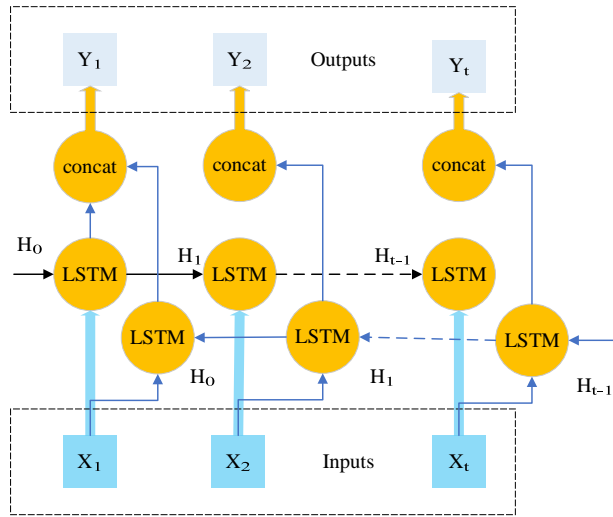

Figure 10: Bidirectional LSTM-RNN Model [61]

are directed RNN-LSTM classifier for training the model. It had been trained by using a small database consisted of five different activities comprised of 20 long-length videos of each activity and acquired the highest overall recognition rate of 98%.

[70] proposed a hierarchical bidirectional RNN (HBRNN-L) model for skeleton dependent on HAR. The authors were the early ones to achieve an end-to-end solution for skeleton depended on HAR applying this method. They divided a skeleton into 5 parts where each part has a different number of joints for 3 different datasets. For MSR 3D action dataset, each subnet of bidirectional RNN has  $15 \times 2$ ,  $30 \times 2$ ,  $60 \times 2$  and  $40 \times 2$  neurons for the 4 layers respectively. For MHAD action [71] and HDM05 [72] datasets, each subnet of bidirectional RNN has  $15 \times 2$ ,  $30 \times 2$ ,  $60 \times 2$  and  $60 \times 2$  neurons for the 4 layers respectively. The model's efficiency was compared to five other deep RNN architectures proposed by the authors and for all three data sets, this model's performance was considered the state of the art at that time.

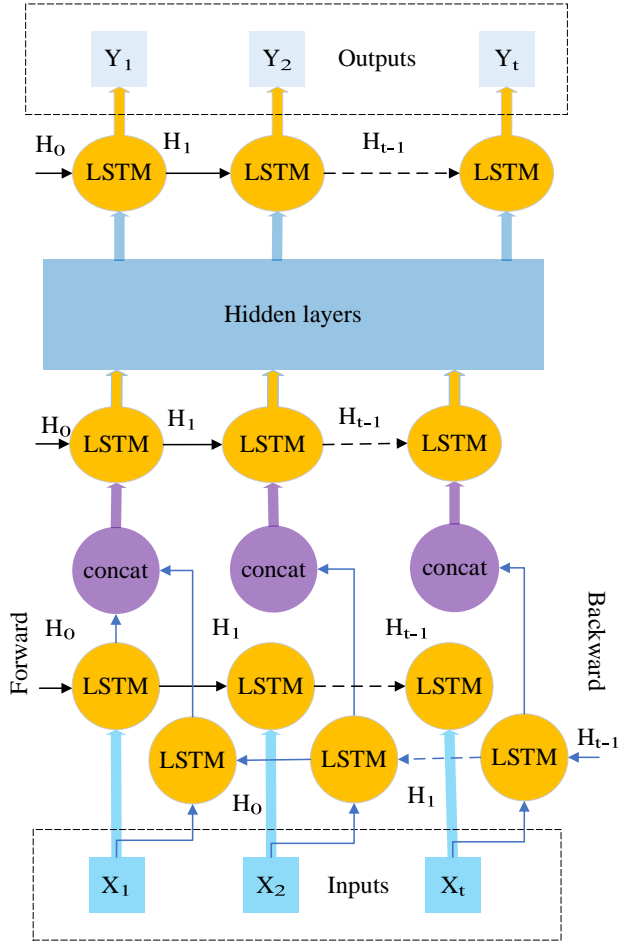

Figure 11: Cascade LSTM-RNN Model [57]

[73] also put forward an end-to-end RNN-LSTM model for skeleton dependent on HAR. The authors suggested a novel strategy of regularization learning the co-occurrence features of a skeleton as well as a new dropout algorithm for training the RNN-LSTM network efficiently. The proposed architecture contained three bidirectional layers with two feedforward fusion layers situated among them and a softmax layer in the end to give the predictions. As a consequence of massive parameter space, it is tough to learn important features despite deep LSTMs powerful learning abilities and to overcome this hurdle co-occurrence exploration was introduced. The co-occurrence of some joints of a skeleton can define human behavior inherently. The new drop-out algorithm enabled the dropping of the LSTM neuron's internal gates, cell and output response and encourages each system to learn better parameters. The authors also claimed the state of the art execution on several datasets.

In [61], the authors introduced a DL architecture applying a bidirectional recurrent network. This introduced method executes the best performance by achieving a recognition accuracy of 92.7% on the opportunity dataset. With the same dataset [74] achieved 91.3% of accuracy. They used  $D^2CL$  and LSTM for human activity recognition. The summary of all the applied features that are discussed in this subsection are compared in Table 3. Fig. 8 Shows a histogram of comparison among different features of RNN.

### 3.3 K-Nearest Neighbor

K-Nearest Neighbor (KNN) has been serving as one well-known supervised learning algorithm. KNN is based on the instance or lazy learning because the function is solely estimated sectionally. It uses neighborhood classifications to result in the prediction of new instantaneous data skepticism. Kaghyan [45] stated that three cons consist in the traditional algorithm and they are calculation complexity for simultaneous usage of all training sets, achievement

depending merely on training sets, and samples consisting of zero weight difference between themselves. The value of  $k$  affects the prediction results [45]. Fig. 12 shows the algorithm flow diagram of KNN.

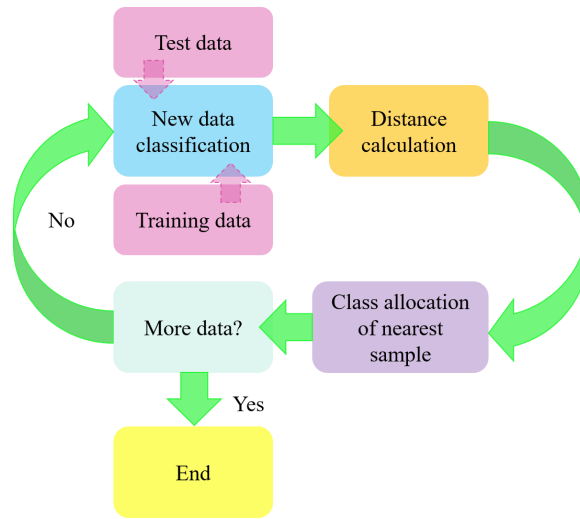

Figure 12: KNN algorithm flow diagram [45, 75, 76]

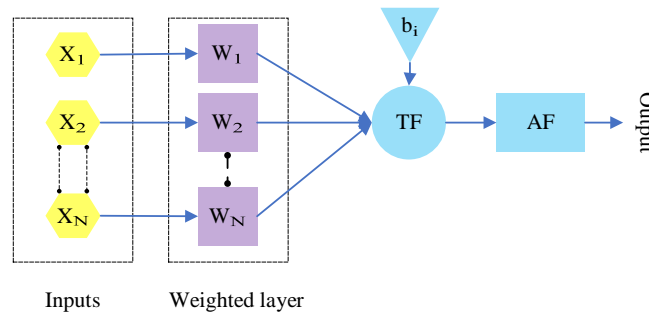

Figure 13: Basic KNN architecture [75]

Everitt [77] stated that a larger value of  $k$  filters noises while classification although makes barriers less visible among classes. And then data solely is allocated to its nearest neighbors class [45]. For the optimal value determination, the bootstrap method is quite popular and is both suggested and used by [78].

KNN combined with other algorithms results in greater accuracy in similar works related to recognition and detection. Fig. 13 shows the basic architecture of KNN. The authors of [79] used decision tables and decision trees along with KNN which lead to increased accuracy in calibrated systems for users. For continuous variables, Euclidean distance is the most common and mostly used distance metric in KNN [45]. For variables that possess discrete characteristics as well as text categorization other metrics as the Hamming distance is utilized mostly [80]. The authors of [45] stated the frequent test set that nominates to rule over the prediction vectors over new ones as a major drawback. These sets tend to come up while the neighbors are being computed for their large amount of data. It happens when the distribution class is being pitched. To overcome this drawback the classification is weighted that of its distance to the  $k$  nearest neighbor.

The authors of [81] claimed LMKNN to be proven to enhance classification performance with simple and effective nonparametric classification techniques. It is also said to lessen the consequence of the anomalies which exist,

particularly for small-sized data [76]. This process could be represented by equations as follows [75]:

$$D(l, z) = ||l - z||^2 = \sqrt{\sum_{j=1}^N |l - z|^2} \quad (6)$$

The goal is to calculate and find the following equation [76]:

$$m_w^k = \frac{i}{k} \sum_{i=1}^k l_{i,j}^{NN} \quad (7)$$

For LMKNN the quantity of nearest neighbors from all class is noted as the value of k in training data [76, 75].

In [82], the authors computed the accuracy of KNN and SVM to achieve a mean accuracy between SVM and KNN which is obtained 92.40% and 71.28% respectively. In [83] the correlation is shown between kNN and NCC in which the research result unveiled that NCC obtains an accuracy margin between 96.67% and 33.33%, whereas kNN only produced an accuracy margin between 26.7% and 22.5%. Their research unquestionably showed the poor accuracy of kNN compared to NCC. The authors of [84] noticed that KNN produces the best accuracy of 48.78% when the value of k is k=8.

Table 4: Comparison between different features of KNN in HAR.

Adopted Techniques	Dataset	Recognition Rate (%)	Highlights	Limitations	Ref.
KNN utilizing Euclidean formula	Smartphone data	100	<ul style="list-style-type: none"> <li>Better accuracy.</li> </ul>	<ul style="list-style-type: none"> <li>Calculation complexity.</li> </ul>	[45]
KNN with Generic Algorithm (GA)	UCI Machine Learning Repository dataset	94.88 ± 0.28 (Dermatology)	<ul style="list-style-type: none"> <li>Capable to overcome KNN limitations.</li> </ul>	<ul style="list-style-type: none"> <li>Lengthy process.</li> <li>Feature extraction needed.</li> </ul>	[81]
		96.67 ± 0.4 (Cleveland heart)			
		97.92 ± 0.51 (Breast cancer)			
LMKNN and DWKNN	UCI Machine Learning Respiratory dataset	86.86 (Ionosphere)	<ul style="list-style-type: none"> <li>Improved accuracy.</li> <li>Better runtime.</li> </ul>	<ul style="list-style-type: none"> <li>Calculation complexity.</li> </ul>	[78]
		98.33 (Iris)			
	Real world Data	87.58			
KNN with ANN	Blackberry Z10 smartphone data	74 (KNN)	<ul style="list-style-type: none"> <li>Handy data collection system.</li> <li>Less complex calculation.</li> </ul>	<ul style="list-style-type: none"> <li>Poor recognition result for the activity 'Going upstairs and downstairs'.</li> </ul>	[88]
		75.3 (ANN)			
KNN with GLC	KTH	91 (walking)	<ul style="list-style-type: none"> <li>Better accuracy.</li> <li>Less calculation complexity.</li> </ul>	<ul style="list-style-type: none"> <li>No multiple or group action detected.</li> </ul>	[89]
		100 (boxing)			
		91.6 (clapping)			
		83 (waving)			
DFT on silhouettes with KNN	MuHaVi dataset	96	<ul style="list-style-type: none"> <li>Tuning needed for few parameters.</li> </ul>	<ul style="list-style-type: none"> <li>Misclassification remains in sequences between 'Walking' and 'Running'.</li> <li>Could be more robust if multi-camera vision was used.</li> </ul>	[90]
	DA-IICT dataset	82.667			

In [45], the Euclidean formula is used along with KNN to recognize various human activities from the data gained from the Tri-axial accelerometer. KNN is used for analyzing the raw data gained from the accelerometer. To separate and calculate 3-dimensional attributes Euclidean formula is applied. This is because KNN works with multidimensional data and standard classifiers are unable to classify raw data. The system was optimized considering k=1. This is because the device, smartphone, is not optimal to compute complex calculations especially when the calculation becomes difficult for k being number(s) higher than 1.

[78] overcame the classic KNN limitations regarding HAR such as calculation complexity, majority voting system, training set dependent performance, weight balancing between sample data. They proposed Genetic KNN (GKNN) which is a fusion of Genetic Algorithm (GA) with KNN. Unlike classic KNN, GKNN uses GA to directly employ the K-neighbours and after taking the k-neighbor, it classifies distance measurement between test data. This helps to avoid the consideration of similarities and weight categorization between all the test data for each iteration which simplifies the calculation.

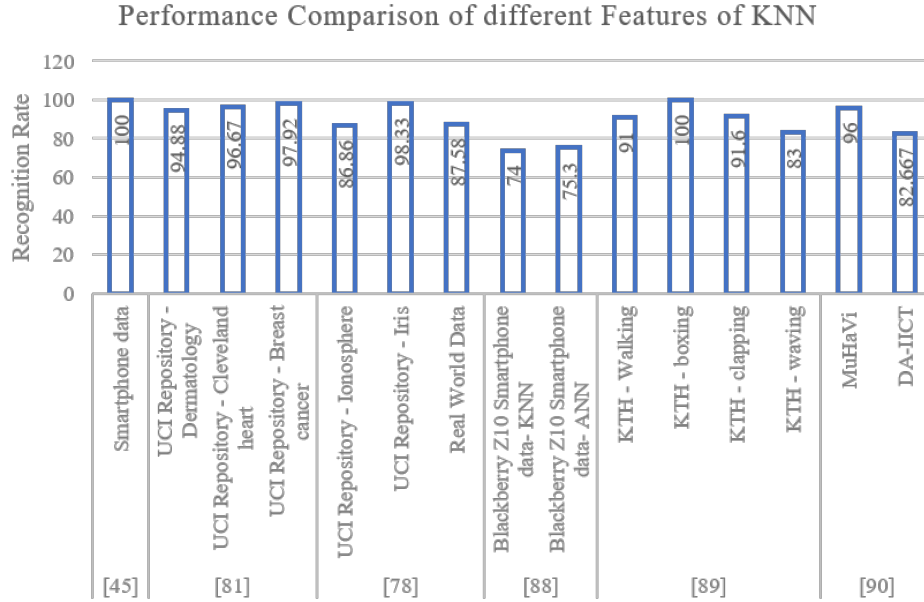

Figure 14: Histogram of the performance comparison of different features of KNN

The authors of [75] used LMKNN and DWKNN instead of classic KNN for accuracy improvement of activity recognition. Classic KNN deploys a vote majority system which is a reason for KNN having low accuracy. Vote majority system passes over the proximity between test data [85]. For this reason, distance differs greatly from each of the nearest neighbors against each of the test data. To avoid this phenomenon they used LMKNN and DWKNN instead of classic KNN. Using LMKNN the closest distance was calculated and sorted from the training data for a fixed value of  $k$  and DWKNN is used for computing and picking out a class containing the highest average of weight for the latest class assigned for the test dataset. They found an increase of 5.16% in average accuracy. Though acknowledged as simple, instinctive, and easy to apply, the kNN algorithm is observed to produce lower accuracy than other classification algorithms, particularly when compared [75].

[86] recognized daily human activity employing just the data obtained from an accelerometer and the gyroscope of a smartphone. They used Artificial Neural Networks (ANN) along with KNN. They considered that the smartphone would be located in the user's (human) pocket. The data or signal from both accelerometer and gyroscope is preprocessed and extracted to their prime features by using different methods. Then the extracted features were classified by KNN using the Euclidean formula. This is to compute the distance between different sample data in test data. After classification ANN is used to recognize the user's (human) activity. This helps to get precise results on different activities. They successfully pulled out on average 76% to 100% overall accuracy on different activity recognition.

[87] focused on data preprocessing and they used different methods for operating background subtraction. They used Gaussian Mixture Model (GMM) for background subtraction. This helps reducing data noise at a great level. Discrete Fourier transform (DFT) is used to extract features of the test data. This is because the Fourier domain has multiple advantages such as having a greater range in imagery, being able to calculate and store data in a float value, ensuring featured data being preserved, having important data from original samples. After the feature is extracted with DFT, classical KNN is used to classify features and recognize human action. They used the classical KNN algorithm to make the calculation simple and robust. The summary of all the techniques applied in this sub-section is compared along with their advantages & limitations in Table 4. Fig. 14 Shows a histogram of comparison among different features of KNN.

### 3.4 Support Vector Machine

The Support Vector Machine (SVM) happens to be a supervised learning model consisting of work-associated learning algorithms. SVM represents sort of a statistical learning method where several principles are inaugurated to obtain classifiers having accurate results [88]. For Data separation it builds many hyperplanes in infinite-dimensional space. Both linear and nonlinear operations can be acquired by SVM. For linear separation, margin operation is applied, for obtaining the maximum distance or deviation from the data to the margin. This is the hard margin method. It is only



applicable when the data are linearly separated. when not, a loss function is added in the function classifier although it is bound with a tolerance factor [89]. This is called the soft margin method for linear operation.

SVM is mainly and broadly used for data classification. Fig. 16 shows the basic architecture of SVM. Classification is executed by using hyperplanes in the featured space by making several linear decisions [90]. It has several extensions as Support vector clustering [91], multi-class SVM [92], kernel PCA, density estimation and regression [90], and others.

[93] demonstrated a method that portrays both 3D joint motion features and depth contours. This method is to represent, recognize, and classify several human activities using multi SVM. For very large training data sets of HAR, the scale of SVM runs very accurately and is also very much cost-effective but the complexity rises incrementally with the increment of numbers of any dataset although classification operation in SVM is served independent [90]. However, the authors of [94] stated that hyperplane separation towards linear classifiers can be put down as follows:

$$v = \text{sgn}((s \times U) + c) \quad (8)$$

And the classification condition for separating hyper plane classifier worth zero training loss is:

$$v = ((s \times U) + c) \geq 1; i = 1, \dots, n \quad (9)$$

Where 's' expressed as normal vector of hyper-plane, 'v' expressed as the label of training pattern, 'U' expressed as input space, and 'i' expressed as a counter of patterns [94].

This learning method intends to express the optimal hyperplane. The goal is to minimize [94]:

$$\frac{1}{2} \|s\|^2 \quad (10)$$

Table 5: Comparison between different features of SVM in HAR.

Adopted Techniques	Dataset	Recognition rate (%)	Highlights	Limitations	Ref.
Space-time interest points with SVM	KTH	71.7	• Capable of recognizing complex motion patterns,	• Occurrence of confusion between the activities 'Jogging' and 'Running'.	[99]
HOG+HOOF with multi-class SVM	Weizmann	100	• Robust and achieved perfect accuracy.	• Low dimensional imagery.	[100]
	Soccer	78.66			
	Tower	100			
AdaBoost algorithm	KTH	90.50	• Can perform low level action recognition on video sequence	• The system is not cloth proof.	[101]
	Weizmann	100			
Multiclass SVM	UIUC1	100	• Better pattern recognition rate, • Fast performance.	• Poor performance on imbalanced datasets.	[94]
	Weizemann	100			
SVM with PCA, HOG, DCT	ADXL330	97.51	• High accuracy.	• Have problem with the activity 'Jumping'.	[102]
SVM with ScTPM and CS-Mltp	MSR Action3D	93.83 (Sparse Coding)	• Robust system, • No extra stabilization system needed.	• Very complex structure.	[103]
	MSR Daily Activity3D	93.83 (Cross Subject)			

[95] applied the Spatio-temporal model along with human-object interaction for HAR in videos. The spatial and temporal model is evaluated to identify the human-object relationship. This model is dependent on steams. The acquired targets, as well as the humans, are spotted and the positions for both humans and objects that are in the streams are encoded with a successful explanation. Human-object features are extracted using the detection window. SVM classifier is used to classify to describe the estimation of sequences of intervals among the entire video. They get an accuracy of 96.3% and 98% which is been evaluated in various checks on various data- sets. Although having a remarkable result, the system failed to consider the location poses and objects surroundings in the process.

[96] employed local space-time features along with SVM for the enhancement of results in complex human activity recognition. They created a new video dataset for this purpose which contains 2391 sequences with 25 subjects. Their work aims to show that Local Features (LF), that is, regarding Spatio-temporal interest points the local measurements conceivably pull off recognizing complex human activities along with SVM classifier. They achieved a recognition rate of 71.7% recognizing complex human activity using LF with SVM. SVM is used because it works well space-time margin assigning an optimal hyper-plane measurement.

In [90], the authors used multiclass SVM to recognize human action. The motivation behind this is to overcome the limitations of classic classifiers, such as longer training time, a larger size of the feature, limited space-time margin. They used LF as well as motion descriptors for feature extraction. Background subtraction is used for the extraction of

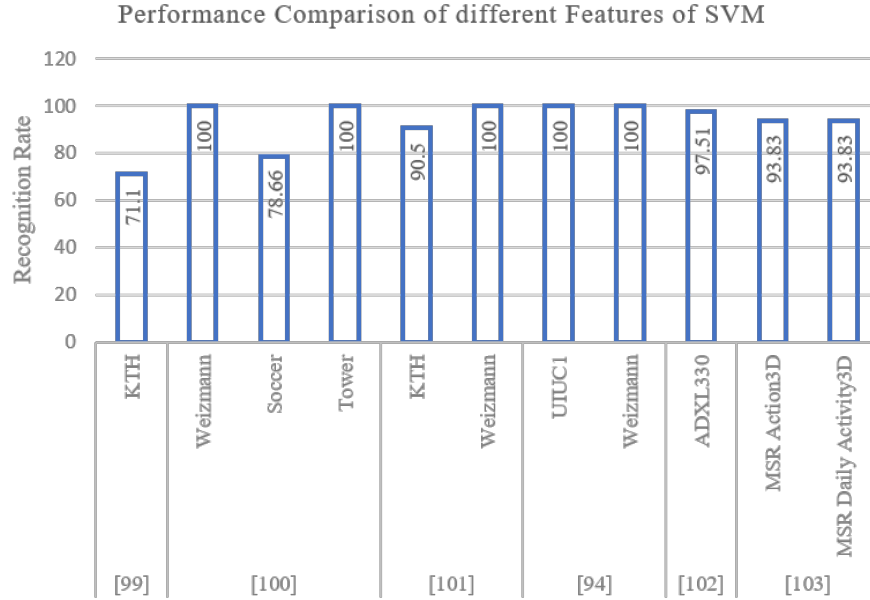

Figure 15: Histogram of the performance comparison of different features of SVM

profiles of the character samples. It helps to pull off the activity recognition task in both high and low-resolution images. Multiclass SVM is used as a classifier to reduce computational and training time though it lacks accuracy at the larger dataset. They successfully gained a result of which the recognition rate was 100% with UIUC1 and Weizmann datasets.

[97] utilized Histogram of Oriented Gradients (HOG) [98] and Histogram of Oriented Optical Flow (HOOF) alongside with SVM in Activity recognition. To describe human pose HOG is applied. It mainly work as a human indicator [99] but it is robust enough to successfully apply in HAR problems [100], [101], [102]. But only human detection is not enough for Activity recognition. That is why HOOF is implied as it can characterize and detect human movements by extracting feature vectors with the help of optic flow. Features are extracted with dimensional space-time reduction for every type of featured vector. Multi-class SVM was deployed to classify human action and for computing nonlinear relation between actions, radial basis function (RBF) kernel is used. For the assessment of the best classifier in a particular dataset, they used the grid search technique.

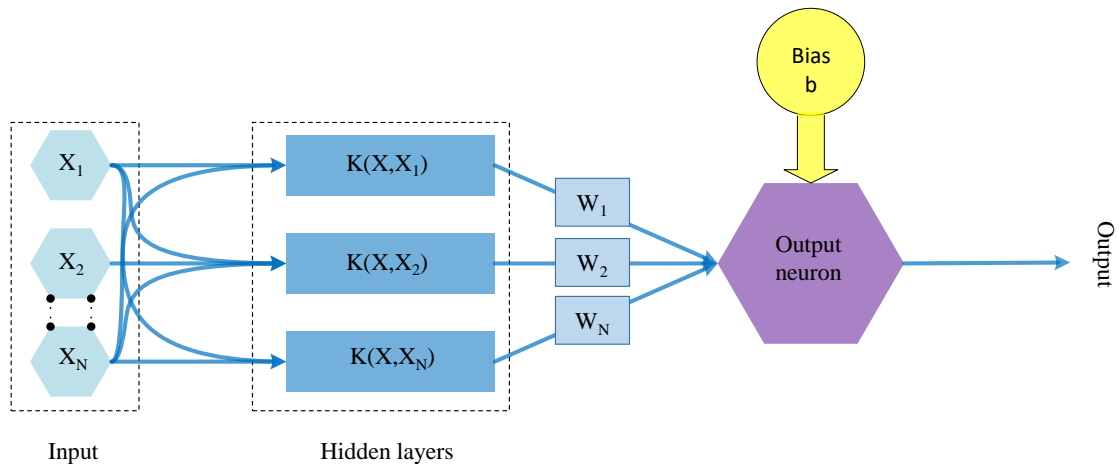

Figure 16: Basic SVM Architecture [90, 93]

In [103], the authors approached in a different way towards HAR. Instead of just assigning LFs, they moved on to figure-centric motion representations of human actions. This representation is gained by employing a detector or motion tracker at the very beginning of input image sequencing. They used three layers for training and classifier learning so that they can distinguish between different activities. AdaBoost is used to extract pieces of information from both low and mid-level image sequences. AdaBoost is run for a second time to merge different parts of different image sequences. For classification, they used a one versus all approach to differentiate classes and recognize different activities using AdaBoost and Multi-class classifier with Hamming decoding. With this approach, they have successfully achieved an efficient and fast runtime compared to others with a range of about 0.2 to 4 seconds per frame. [104] introduced a framework that is quite different for HAR. Depend on RGB and depth features, the framework serves to accompany SVM.

[105] Utilized SVM along with Discrete Cosine Transform (DCT) as well as PCA with data from a tri-axial accelerometer for HAR. Features are extracted with the help of DCT to carry out the most effective ones. Then feature reduction is employed to lessen data proportion of as well as from original data. PCA is used to do this reduction operation. After reduction SVM is employed for the classification of the data and human action detection. They used SVM because the training dataset was limited. To overcome this problem they used the leave-one-subject-out validation [106] approach. And they achieved a rich recognition rate of 97.51% in different types of daily human activity. A comparison of all these previously applied techniques of SVM is shown in Table 5. Fig. 15 Shows a histogram of comparison among different features of SVM.

## 4 Abnormality Detection using Unsupervised Learning

While supervised learning algorithms perform well in some cases, there exist several challenges which have to be addressed to get good performance from these models. Supervised learning-based methods work based on ground truth or data with labels that have to be provided by a human expert. To get these algorithms to perform well, the labeled data has to be a hundred percent accurate and the dataset has to be large. Labeling a large amount of data is no easy task for any human expert, and is often, quite impractical, and not a viable solution. Also, in many cases, a human expert may fail to find the underlying structure of the data which can be vital to detect certain behaviors. For these reasons, Unsupervised learning-based methods were introduced into the HAR problem.

Unsupervised Learning algorithms possess a vital impression in HAR for anomaly detection. Unlike supervised learning, these methods learn untagged data, which saves the trouble of labeling thousands of data. This method does not require any past knowledge or in simple words, this method is not pre-trained for any operation. These methods find identical patterns in the data, group them accordingly, saving the trouble of hand-labeling. Unsupervised learning-based methods find the underlying structure of the data, which may be very difficult sometimes to detect and label properly. The idea of this method is that the normal events happen frequently but abnormal event seldom happens from which the abnormality in daily life events can be easily detected.

### 4.1 K-Means Clustering

The k-means is a popular unsupervised clustering algorithm. It is also recognized to merge the local minimum value of the Euclidean distance. K-means algorithm applies the Sum of Squared Error (SSE) and Total Sum of Squares (SST) to compute the status of the cluster. In a k-means algorithm, the lower the SSE or SST value, the better the clustering. SSE and SST can be mathematically represented by equation 11 and equation 12 respectively where  $x$  is a vector representation of an object,  $C_i$  represents the  $i^{th}$  cluster,  $c_i$  is the centroid of  $C_i$ , and  $c_m$  represents the mean of all the allocated points [107].

$$SSE = \sum_{i=1}^k \sum_{c_i} dist(c_i, x)^2 \quad \text{and} \quad \forall x \in C_i \quad (11)$$

$$SST = \sum dist(c_m, x)^2 \quad \text{and} \quad \forall x \text{ in dataset } D \quad (12)$$

In [108], the authors put forward an adjustable technique formed on K-Means clustering, local outlier factor (LOF) as well as multivariate Gaussian distribution (MGD) for HAR. They personalized their classifier to recognize human activity into four levels that are light-intensity activity (LIA), moderate-intensity activity (MIA), vigorous-intensity activity (VIA), and fall. Their proposed technique copes with user-specified data to learn and detect human activities. Their essence is to replace the initial centroids of the unclustered data with the k centroids of the activity dataset that is collected before. They achieved the fastest testing time of 0.02 seconds and an F-measure of 0.9875, 0.9729, 0.9692, and 0.9766 for LIA, MIA, VIA, and fall respectively. In [109] introduced a novel K-means clustering method for abnormality detection in a crowded area based on acceleration feature. The acceleration feature is based on Newton's

Table 6: Comparison between different features of Unsupervised learning in HAR.

Adopted Techniques	Dataset	Performance (%)		Highlights	Limitations	Ref.
		Recognition rate	F Measure			
K-Means clustering with LOF and MGD	Real World Data	-	0.9875 (LIA)	<ul style="list-style-type: none"> <li>• Fastest testing time,</li> <li>• Low computational complexity.</li> </ul>	<ul style="list-style-type: none"> <li>• Longer training time.</li> </ul>	[112]
		-	0.9729 (MIA)			
		-	0.9692 (VIA)			
		-	0.9766 (fall)			
HMM-DNN	Collected from smartphone	93.37	-	<ul style="list-style-type: none"> <li>• The model can automatically extract features.</li> <li>• Performs better than generative and discriminative models.</li> </ul>	<ul style="list-style-type: none"> <li>• Dataset was poor.</li> </ul>	[113]
FP-MGGMM-MML	KTH	91.97	-	<ul style="list-style-type: none"> <li>• Better results are obtained when taking into account the full covariance matrix.</li> <li>• Performs better than Regular Gaussian mixture models.</li> </ul>	<ul style="list-style-type: none"> <li>• Computational Complexity.</li> </ul>	[114]
Embedded-HMM with multi features	Online Self annotated	71.6	-	<ul style="list-style-type: none"> <li>• Effective encoding relevant Activity information.</li> </ul>	<ul style="list-style-type: none"> <li>• Not compatible with human to human interactions with human-object interactions.</li> </ul>	[115]
	MSR Action3D	93.1	-			
	MSR Daily Activity3D	92.2	-			
HMM-GMM with skeleton features	Cornel Activity Detection	84 (Previously seen)	-	<ul style="list-style-type: none"> <li>• The model can automatically extract features,</li> <li>• Effective against inter and intra individual patterns.</li> </ul>	<ul style="list-style-type: none"> <li>• The performance could have been better.</li> </ul>	[116]
		78 (Unseen)	-			
HVT-HMM	Gesture	90.6	-	<ul style="list-style-type: none"> <li>• Real time and online based system,</li> <li>• Very accurate and robust system.</li> </ul>	<ul style="list-style-type: none"> <li>• Problematic in large camera motion,</li> <li>• System tends to wander.</li> </ul>	[117], [118]
	Weizemann	100	-			

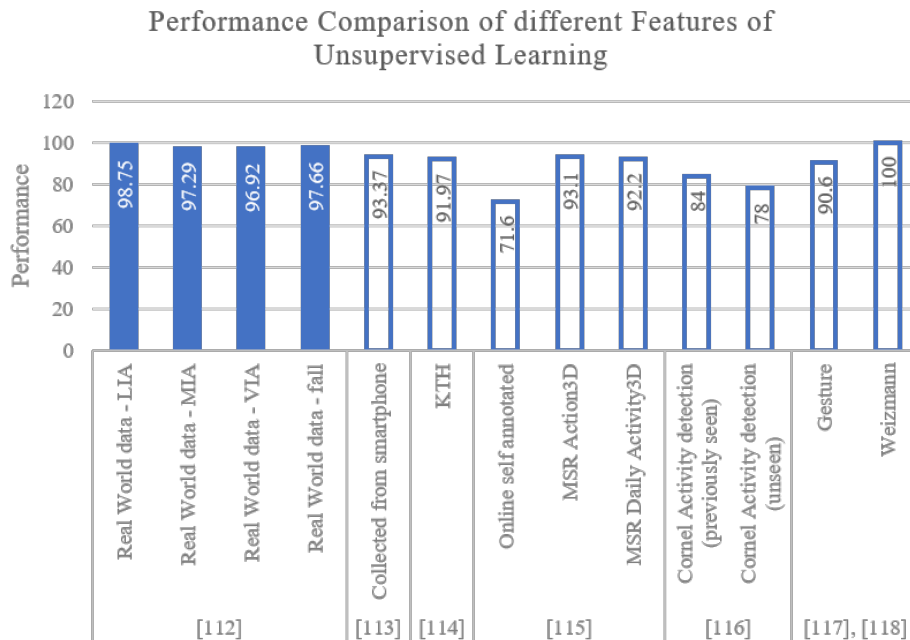

Figure 17: Histogram of the performance comparison of different features of Unsupervised Learning

2nd law and it utilizes the assumption that when an abnormal event is taking place the acceleration of the movements of people in the crowd would increase. The frames of the videos are represented using velocity and acceleration fields and are divided into patches where K-means clustering was used to detect the abnormal situation adopting acceleration features. The proposed model was used on UMN and PETS2009 datasets and showed better performance than compared methods.

#### 4.2 Hidden Markov Model

Hidden Markov Model (HMM) emerges from a basic chain of Markov. It contains observation vectors that are used for data item sequencing. The states of the system are obtained through this statistical model [110]. Fig. 18 shows a basic architecture of HMM. It is an important way to automatically recognize speeches and processing signals

[111]. Interaction among individuals is estimated based on possibility distribution via HMM with sequence learning dispensation [112]. As far as recognition techniques are concerned, HMMs are extensively used in numerous HAR systems so far, as they are competent in time-varying pattern decoding [113, 114, 115]. Many types of HMM models are being used for HAR such as continuous HMM, probability-based graphical HMM, HMM-DNN, HMM-GMM models are seen to be used in some of the reviewed literature.

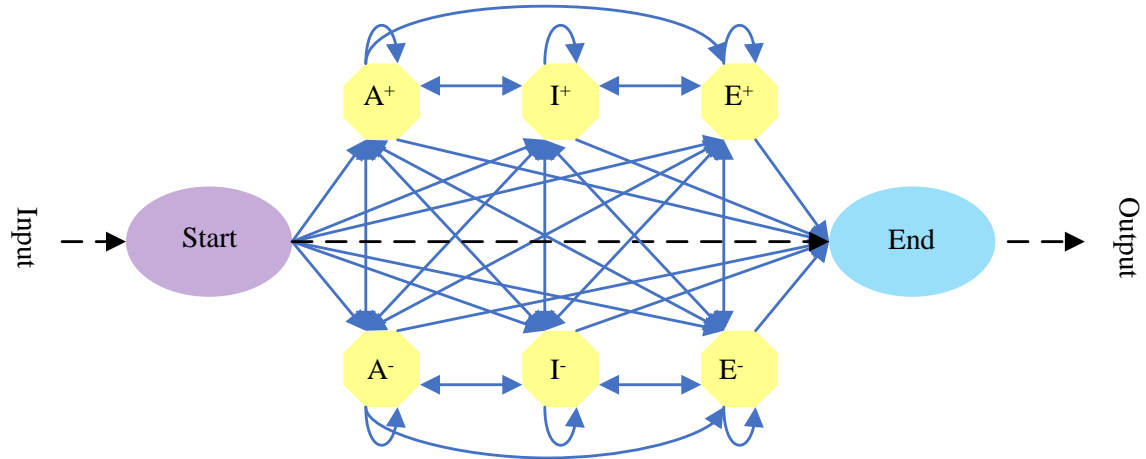

Figure 18: Basic HMM Architecture [116]

[117] proposed a novel approach of embedded HMM with multi-features using depth video sensor for HAR. The authors introduced a real-time body parts tracking system for extracting human silhouettes from noisy backgrounds and several symbolic features counting in-variants, multi-view differentiation, and Spatio-temporal body joints, which have been combined to explore change in gradient orientation and motion of specific body parts. To recognize human activities these sub-features were unified together forming a multi-feature vector that sizes  $689 \times 1$  and trained in the proposed embedded HMM where active feature regions of human body joints were specifically focused on. The authors constructed a new online dataset regarding human activity to evaluate the proposed model along with three other existing datasets and found a commendable recognition rate atop the state-of-the-art performance at that moment. Fig. 19 shows a simplified flow diagram of the HMM classifier. The authors of [118] introduced a human activity recognition system employing depth silhouettes context features using advanced HMMs applying depth sensors that provide higher performance on recognition rates over the state-of-the-art methods. The recognition rates are 57.69% on IM Daily Depth Activity dataset and 83.92% on the MSR Action3D dataset. In [119] the authors proposed unsupervised learning of finite multivariate generalized Gaussian mixture model. The authors have developed a novel learning algorithm based on a Fixed-point covariance matrix estimator combined with the Expectation-Maximization (EM) algorithm and to overcome the model selection problem and an appropriate minimum message length (MML) criterion was proposed. The proposed model has shown promising outputs in the KTH dataset.

[113] employed a Gaussian Mixture Model (GMM) depended HMM using 3-D skeleton features for HAR provided by RGB-D camera. Being a set of multinomial Gaussian distributions, Gaussian mixtures can cluster data into various groups therefore, each of the body positions conceivably is formulated as a multitude of the multinomial distribution. The authors employed the following model applying Bayesian Network ToolBox found in Matlab. The mixture with Gaussian parameters was embarked applying the K-mean algorithm and optimized by expectation maximization (EM) algorithm.

However, [116] acclaimed Deep Neural Networks (DNNs) to work better in modeling the emission distribution of HMM than generative Gaussian Mixture Models (GMM) or discriminative Random Forest(RF). The authors recommended HMM-DNN methods over HMM-GMM and HMM-RF methods as they have the capability to automatically extract important features that could be lost or time-consuming in the case of HMM-GMM and HMM-RF. The parameters such as weights and biases of the proposed HMM-DNN model were randomly initialized and optimized using a

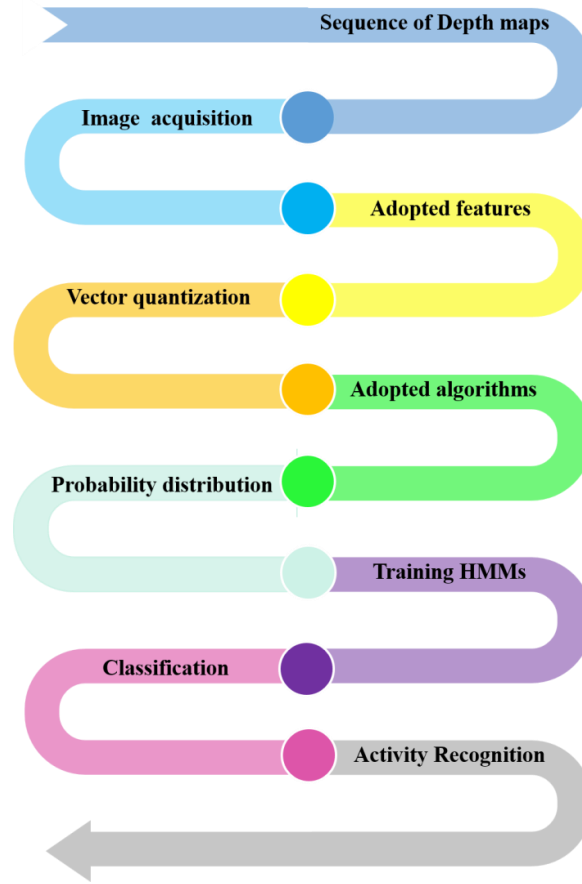

Figure 19: Simple Flow Diagram of HMM Algorithm [117]

back-propagation algorithm and it was trained to apply stochastic gradient descent with a mini-batch size of 100 training samples where 1000 epochs at a rate of learning of 0.1 with a weight decay of about 0.0002 were run. The experimental results found the HMM-DNN process generates an accuracy of 93.37% when HMM-RF generates 85.69%, and HMM-GMM generates 84.88% of accuracies sequentially.

A comparison of these unsupervised learning techniques applied to solving the HAR problem is presented in Table 6. Fig. 6 Shows a histogram of comparison among different features of unsupervised learning techniques where the filled pillars represent  $f1 \text{ score} \times 100\%$  and the hollow pillars represent recognition rate.

## 5 Datasets of HAR

The importance of datasets is increasing drastically as the approach to the solution of the HAR problem is gradually favoring the data-driven deep learning models because of their massive advantages like accurate results, adaptability, and quick decision-making ability. For smoothing the path to clearly distinguish between the abilities of these learning models various datasets consisting of labeled human activity have been created. To cope with the continuously advancing field of HAR the evolution of video-based datasets has also come a long way. In this section, some of the most used datasets in the research of HAR are discussed.

### 5.1 UCF50

The UCF50 [120] is an activity recognition dataset holding fifty (50) action Classes. It consists of 6676 practical videos attained from YouTube. This dataset is an enlargement of the dataset UCF11. The UCF11 contains eleven (11) action classes. Many of the available activity recognition datasets are impractical as well as staged by actors. In which many of the activities are not executed well. In UCF50, the principal focus is to provide the computer vision world with a dataset

Table 7: Overview of Some Popular Video Datasets Used in HAR.

Dataset	Year of Publication	Modality	Activity Class	Reference
KTH	2004	RGB	6	[99]
Weizmann	2005	RGB	10	[126]
MSR-Action3D	2010	Depth	20	[127]
Hollywood	2008	RGB	8	[128]
Hollywood 2	2009	RGB	12	[129]
UCF101	2012	RGB	101	[70]
UCF50	2012	RGB	50	[130]

possessing true-to-life videos. The dataset is very intricate because of having large fluctuations of in-camera motion, appearance, and pose of the central object, object computation, focus, cluttered environment, lighting limitations, and so on. The videos are arranged into 25 groups of the entire dataset, and each group has more than 4 action clips. The video clips share some common features in a group as it is done by the same actor in the same environment.

## 5.2 UCF101

The UCF101 [121] is an activity recognition dataset. It consists of practical videos gathered from YouTube. It holds 101 action classes of videos. This dataset is an augmentation of the UCF50 dataset which has fifty (50) action classes. Possessing 13320 video clips from 101 action classes, UCF101 affords the largest multifariousness in terms of actions and with the presence of large inconstancies in-camera motion, appearance, and posture of the central object, the balance of the object, location, cluttered environment, lighting states, and so on. It possesses the unique reputation of being the most challenging data set to date. UCF101 intends to promote moreover research toward activity recognition by learning and investigating new lifelike action classes.

## 5.3 Weizmann

Weizmann actions dataset [122] consists of 10 different types of natural activities. There are 90 videos in the dataset. The videos are of a low resolution of 180x144 and 50fps. Testing is executed in a leave-one-out manner on a per-person basis. Training is done on eight subjects and testing on the remaining subject and all its videos. An adjusted camera and a simple background were adopted. Then the video clips of the dataset was recorded . Most of the activities were performed by a single actor.

## 5.4 KTH

The KTH [96] video database containing 6 types of human activities. It is one of the most cited datasets. It was conducted numerous times by 25 subjects in four separate scenarios. The database consists of 2391 sequences. All sequences were taken over uniform backgrounds. A static camera was used to record. The sequences were of 25fps frame rate. The continuities were downsampled to the spatial resolution of 160x120 pixels. And it consists of a length of four seconds on average. There lie  $25 \times 6 \times 4 = 600$  video clips for each succession of 25 subjects, 6 actions, and 4 scenarios. It has got high inter-class variation which has to lead it to its success.

## 5.5 Hollywood

The Hollywood [123] dataset, also called HOHA, was created at IRISA institute, France. The datasets associated with HAR are different. They are explained by automatic script-to-video order along with text-based script classification in movie scenarios. Hollywood has 8 activity classes collected from 32 movies. There consists dynamic background as the video scenes were taken from different movies and it makes a tough task for any HAR model for activity recognition. Of these video scenes, 20 make the train set and 12 the test set. The train is separated into two sets, an automatic annotation set possessing 233 video clips and a manually verified set possessing 219 video clips. The test set has 211 video clips that are manually validated. This dataset is very much challenging as the camera viewpoints change simultaneously.

## 5.6 Hollywood 2

The Hollywood 2 [124] is an extension of Hollywood and has a total number of 12 categories. Four new additional activity categories are added and they are driving a car, eat, fight, and run. The dataset aims to provide a complete benchmark for human activity recognition in realistic and challenging environments. A total number of 69 movies used

in the data set are split into 33 trains and 36 test clips. Scene video samples are produced next to employ script-to-video alignment. Labels of test scene samples are verified manually.

### 5.7 MSR-Action3D

The MSR-Action3D [125] dataset is an activity dataset of depth sequences created by Wanqing Li at Microsoft Research Redmond. It is frequently used to benchmark different depth based HAR approaches. The video scene was captured by a depth camera. This dataset contains 20 action types with 10 subjects. Each of the subjects in this dataset performs each activity more than once. There are 567 depth map sequences of 640x240 resolution in total. The video data was recorded by a depth sensor comparable to the Kinect device. A summary of all the discussed dataset is presented in Table 7.

## 6 Challenges and Future Trends

HAR is a provoking yet unsolved problem although great progress has been made, there remain some unsolved challenges. HAR involves tracking, detecting, and recognizing human action which leads to some challenges as subject sensitivity, activity sensitivity, inaccurate gesture detection, insufficient training data [126]. Fig. 20 indicates some of the future trends of HAR. Some of the challenges faced by finding anomalies in HAR are discussed in this section.

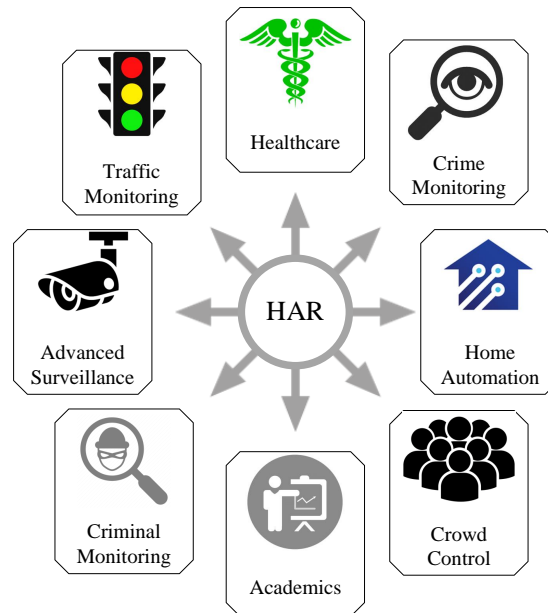

Figure 20: Future scopes of HAR

### 6.1 Differentiating among the level of anomalies

One of the greatest challenges of HAR techniques is identifying the usual and unusual activity patterns. Another major challenge is to distinguish the level between usual and unusual activity. The level of anomaly between shoplifting and robbery is different just like it is between punching and stabbing. The diversity among different types of activities like in,

- Actions: Walking, running, throwing, etc.
- Interactions: Ranging from hugging, kissing, and shaking hands to punching and killing, interactions between objects and persons.

are very hard to detect. Therefore, training the models to differentiate between the anomalies has become a huge challenge for upcoming researchers working in this sector.



## 6.2 Availability of Proper Dataset

Another major issue is the availability of labeled sets of data for model training and testing used for the detection and affirmation of anomaly sequences. Deep learning models are data-dependent models hence their accomplishment is highly influenced by the size, standards, and features regarding the training data. Datasets of HAR include many videos divided into classes regarding the activities. Many of the datasets used in the reviewed literature like UCF101 [121] and HMDB51 [127] contains basic activities such as standing up, sitting down, waving, playing musical instruments playing. But for surveillance system anomalous activity related datasets have much more impact like in CAVIAR [128], Visor, IXMAS [129, 130] etc. Hence creating more datasets containing activities for surveillance systems is an important task.

## 6.3 Developing Models for SBC

Human Activity Recognition models are very power-demanding models. To process the models very powerful hardware setups with more than capable graphics processing units are needed. In the HAR system, there are multiple cameras placed in very crowded locations to gather data, and then it is processed in super-powerful computers where the most up-to-date Deep learning models run smoothly. But it is a hard task to install heavy setups in such crowded places as it is very costly and space-consuming. As in the past decade technologies in edge devices like Single Board Computers are flourishing rapidly and many developers around the world dedicating time and efforts to develop applications for these devices. But these up-to-date Deep learning models do not run properly in SBCs as they need heavy GPU to operate. Hence, there arises the need of optimizing these models. Many types of researches are being conducted to optimizing Deep learning models to run them in lower-end devices. It is a challenge to look forward to in the upcoming decade.

## 6.4 Developing system for Real world

Besides the difficulties and problems mentioned above, there are also some challenges when the system is executed in the real world such as anthropometric variation [87, 131, 132, 133, 134], multi-view variation [133, 135, 136, 137], low clarity, variable lighting, weather conditions, camera motion [138, 139], cluttered and dynamic background [140, 141], input video quality and resolution, shadow and scale variation, occlusions etc [142] or in robotic systems [143]. Similar activities vary from person to person based on posture, motion, or appearance. Moreover, the models used in much previous literature tried to solve the HAR problem from a fixed viewpoint and their claimed success is based on that viewpoint. But when multiple viewpoints are considered the accuracy rates drop significantly because considering another viewing angle means the motion of the body, lighting, shadow, scale everything seems to be different. Hence the HAR models can not recognize the activities properly as their training dataset had not prepared them for other angles. The change in weather also creates changes in clarity and lighting which affects HAR. Researchers have been working to resolve these issues for a long time now. Using multiple synchronized dynamic cameras seems to be a promising option as it can capture from multiple viewpoints. But optimizing models according to the solution is not that easy as it generates a tremendous volume of data that increases computation time and complexity. Hence developing the method for achieving a generalized solution for HAR in the real world is a sector to be worked on in this decade.

## 7 Conclusion

The necessity of a surveillance system using human activity recognition is skyrocketing with each day passing by as we want the world to be a safe and secured place. Despite the widespread need, HAR is yet to achieve the level to deliver the generalized performance needed for it to be used in the surveillance system in the real world scenario. In this review, the basic solution towards HAR has been discussed and an overview of state-of-the-art supervised and unsupervised learning methods has been investigated. The methods are analyzed and compared in terms of their adopted techniques, performance, advantages, and limitations from the latest researches. Finally, a number of major challenges and possible solutions are introduced for the upcoming researches. From the review, it conceivably can be said that vision-based HAR is an uprising and prominent sector in the field of computer vision and lots of challenges remain before these methods can be used for any real-world applications.

## References

- [1] D Gowsikhaa, S Abirami, and Ramachandran Baskaran. Automated human behavior analysis from surveillance videos: a survey. *Artificial Intelligence Review*, 42(4):747–765, 2014.

- [2] SU Park, JH Park, MA Al-Masni, MA Al-Antari, Md Z Uddin, and T-S Kim. A depth camera-based human activity recognition via deep learning recurrent neural network for health and social care services. *Procedia Computer Science*, 100:78–84, 2016.
- [3] Alex Krizhevsky, Ilya Sutskever, and Geoffrey E Hinton. Imagenet classification with deep convolutional neural networks. *Communications of the ACM*, 60(6):84–90, 2017.
- [4] Karen Simonyan and Andrew Zisserman. Very deep convolutional networks for large-scale image recognition. *arXiv preprint arXiv:1409.1556*, 2014.
- [5] Christian Szegedy, Wei Liu, Yangqing Jia, Pierre Sermanet, Scott Reed, Dragomir Anguelov, Dumitru Erhan, Vincent Vanhoucke, and Andrew Rabinovich. Going deeper with convolutions. In *Proceedings of the IEEE conference on computer vision and pattern recognition*, pages 1–9, 2015.
- [6] Stefan Duffner, Samuel Berlemont, Grégoire Lefebvre, and Christophe Garcia. 3d gesture classification with convolutional neural networks. In *2014 IEEE International Conference on Acoustics, Speech and Signal Processing (ICASSP)*, pages 5432–5436. IEEE, 2014.
- [7] Gal Lavee, Latifur Khan, and Bhavani Thuraisingham. A framework for a video analysis tool for suspicious event detection. *Multimedia Tools and Applications*, 35(1):109–123, 2007.
- [8] Rutvik Kakadiya, Reuel Lemos, Sebin Mangalan, Meghna Pillai, and Sneha Nikam. Ai based automatic robbery/theft detection using smart surveillance in banks. In *2019 3rd International conference on Electronics, Communication and Aerospace Technology (ICECA)*, pages 201–204. IEEE, 2019.
- [9] P Markwerth, T Bajanowski, I Tzimas, and R Dettmeyer. Sudden cardiac death—update. *International Journal of Legal Medicine*, 135(2):483–495, 2021.
- [10] S Viji, R Kannan, and N Yogambal Jayalashmi. Intelligent anomaly detection model for atm booth surveillance using machine learning algorithm: Intelligent atm surveillance model. In *2021 International Conference on Computing, Communication, and Intelligent Systems (ICCCIS)*, pages 1007–1012. IEEE, 2021.
- [11] Kamal Kant Verma, Brij Mohan Singh, and Amit Dixit. A review of supervised and unsupervised machine learning techniques for suspicious behavior recognition in intelligent surveillance system. *International Journal of Information Technology*, pages 1–14, 2019.
- [12] Yang Yang, Imran Saleemi, and Mubarak Shah. Discovering motion primitives for unsupervised grouping and one-shot learning of human actions, gestures, and expressions. *IEEE transactions on pattern analysis and machine intelligence*, 35(7):1635–1648, 2012.
- [13] Bingbing Ni, Pierre Moulin, Xiaokang Yang, and Shuicheng Yan. Motion part regularization: Improving action recognition via trajectory selection. In *Proceedings of the IEEE Conference on Computer Vision and Pattern Recognition*, pages 3698–3706, 2015.
- [14] Alonso Patron-Perez, Marcin Marszalek, Ian Reid, and Andrew Zisserman. Structured learning of human interactions in tv shows. *IEEE Transactions on Pattern Analysis and Machine Intelligence*, 34(12):2441–2453, 2012.
- [15] Khai N Tran, Apurva Gala, Ioannis A Kakadiaris, and Shishir K Shah. Activity analysis in crowded environments using social cues for group discovery and human interaction modeling. *Pattern Recognition Letters*, 44:49–57, 2014.
- [16] Michalis Vrigkas, Christophoros Nikou, and Ioannis A Kakadiaris. A review of human activity recognition methods. *Frontiers in Robotics and AI*, 2:28, 2015.
- [17] Ahmed Elgammal, Ramani Duraiswami, David Harwood, and Larry S Davis. Background and foreground modeling using nonparametric kernel density estimation for visual surveillance. *Proceedings of the IEEE*, 90(7):1151–1163, 2002.
- [18] Heng Wang, Alexander Kläser, Cordelia Schmid, and Cheng-Lin Liu. Dense trajectories and motion boundary descriptors for action recognition. *International journal of computer vision*, 103(1):60–79, 2013.
- [19] Chuang Gan, Naiyan Wang, Yi Yang, Dit-Yan Yeung, and Alex G Hauptmann. Devnet: A deep event network for multimedia event detection and evidence recounting. In *Proceedings of the IEEE Conference on Computer Vision and Pattern Recognition*, pages 2568–2577, 2015.
- [20] Ong Chin Ann and Lau Bee Theng. Human activity recognition: a review. In *2014 IEEE international conference on control system, computing and engineering (ICCSCE 2014)*, pages 389–393. IEEE, 2014.
- [21] Shian-Ru Ke, Hoang Le Uyen Thuc, Yong-Jin Lee, Jenq-Neng Hwang, Jang-Hee Yoo, and Kyoung-Ho Choi. A review on video-based human activity recognition. *Computers*, 2(2):88–131, 2013.

- [22] Chhavi Dhiman and Dinesh Kumar Vishwakarma. A review of state-of-the-art techniques for abnormal human activity recognition. *Engineering Applications of Artificial Intelligence*, 77:21–45, 2019.
- [23] Madallah Alruwaili, Muhammad Hameed Siddiqi, and Amjad Ali. Human body segmentation using level set-based active contours with application on activity recognition. *IEEE Access*, 7:157841–157858, 2019.
- [24] Hui Yang. Data preprocessing, 2018.
- [25] Salvador García, Julián Luengo, and Francisco Herrera. Tutorial on practical tips of the most influential data preprocessing algorithms in data mining. *Knowledge-Based Systems*, 98:1–29, 2016.
- [26] Dorian Pyle. *Data preparation for data mining*. morgan kaufmann, 1999.
- [27] Edgar Acuña. Preprocessing in data mining., 2011.
- [28] Jiawei Han, Jian Pei, and Micheline Kamber. *Data mining: concepts and techniques*. Elsevier, 2011.
- [29] Hongjun Lu, Sam Yuan, and Sung Ying Lu. On preprocessing data for effective classification. In *ACM SIGMOD'96 Workshop on Research Issues on Data Mining and Knowledge Discovery*. Citeseer, 1996.
- [30] Leif Azzopardi. " am i right?" asked the classifier: Preprocessing data in the classification process. *Computing and Information Systems*, 9(1):37–44, 2002.
- [31] Salvador García, Julián Luengo, and Francisco Herrera. *Data preprocessing in data mining*. Springer, 2015.
- [32] Robert Engels and Christiane Theusinger. Using a data metric for preprocessing advice for data mining applications. In *ECAI*, volume 98, pages 23–28. Citeseer, 1998.
- [33] Hend Basly, Wael Ouarda, Fatma Ezahra Sayadi, Bouraoui Ouni, and Adel M Alimi. Dtr-har: deep temporal residual representation for human activity recognition. *The Visual Computer*, pages 1–21, 2021.
- [34] Shahriar Rahman Fahim, Dristi Datta, MD Rafiqul Islam Sheikh, Sanjay Dey, Yeahia Sarker, Subrata K Sarker, Faisal R Badal, and Sajal K Das. A visual analytic in deep learning approach to eye movement for human-machine interaction based on inertia measurement. *IEEE Access*, 8:45924–45937, 2020.
- [35] Aiswarya Mohan, Meghavi Choksi, and Mukesh A Zaveri. Anomaly and activity recognition using machine learning approach for video based surveillance. In *2019 10th International Conference on Computing, Communication and Networking Technologies (ICCCNT)*, pages 1–6. IEEE, 2019.
- [36] Yeahia Sarker, Shahriar Rahman Fahim, Subrata K Sarker, Faisal R Badal, Sajal K Das, and Md Nazrul Islam Mondal. A multidimensional pixel-wise convolutional neural network for hyperspectral image classification. In *2019 IEEE International Conference on Robotics, Automation, Artificial-intelligence and Internet-of-Things (RAAICON)*, pages 104–107. IEEE, 2019.
- [37] Shahriar Rahman Fahim, Yeahia Sarker, Subrata K Sarker, Md Rafiqul Islam Sheikh, and Sajal K Das. Self attention convolutional neural network with time series imaging based feature extraction for transmission line fault detection and classification. *Electric Power Systems Research*, 187:106437, 2020.
- [38] A Agarwal, S Negahban, and MJ Wainwright. A simple way to prevent neural networks from overfitting. *Ann. Stat.*, 40(2):1171–1197, 2012.
- [39] Yann LeCun et al. Generalization and network design strategies. *Connectionism in perspective*, 19:143–155, 1989.
- [40] Jian Sun, Yongling Fu, Shengguang Li, Jie He, Cheng Xu, and Lin Tan. Sequential human activity recognition based on deep convolutional network and extreme learning machine using wearable sensors. *Journal of Sensors*, 2018, 2018.
- [41] Jianbo Yang, Minh Nhut Nguyen, Phyo Phyo San, Xiao Li Li, and Shonali Krishnaswamy. Deep convolutional neural networks on multichannel time series for human activity recognition. In *Twenty-Fourth International Joint Conference on Artificial Intelligence*, 2015.
- [42] Yeahia Sarker, Shahriar Rahman Fahim, Md Sakhawat Hosen, Subrata K Sarker, Md Nazrul Islam Mondal, and Sajal K Das. Regularized singular value decomposition based multidimensional convolutional neural network for hyperspectral image classification. In *2020 IEEE Region 10 Symposium (TENSYP)*, pages 1502–1505. IEEE, 2020.
- [43] Kyoung-Soub Lee, Sanghoon Chae, and Hyung-Soon Park. Optimal time-window derivation for human-activity recognition based on convolutional neural networks of repeated rehabilitation motions. In *2019 IEEE 16th International Conference on Rehabilitation Robotics (ICORR)*, pages 583–586. IEEE, 2019.
- [44] Ian Goodfellow, Yoshua Bengio, and Aaron Courville. *Deep Learning*. MIT Press, 2016. <http://www.deeplearningbook.org>.

- [45] Sahak Kaghyan and Hakob Sarukhanyan. Activity recognition using k-nearest neighbor algorithm on smart-phone with tri-axial accelerometer. *International Journal of Informatics Models and Analysis (IJIMA)*, ITHEA International Scientific Society, Bulgaria, 1:146–156, 2012.
- [46] Min Sheng, Jing Jiang, Benyue Su, Qingfeng Tang, Ali Abdullah Yahya, and Guangjun Wang. Short-time activity recognition with wearable sensors using convolutional neural network. In *Proceedings of the 15th ACM SIGGRAPH Conference on Virtual-Reality Continuum and Its Applications in Industry-Volume 1*, pages 413–416, 2016.
- [47] Dan Claudiu Cireșan, Ueli Meier, Jonathan Masci, Luca Maria Gambardella, and Jürgen Schmidhuber. Flexible, high performance convolutional neural networks for image classification. In *Twenty-Second International Joint Conference on Artificial Intelligence*, 2011.
- [48] Dan Cireșan, Ueli Meier, and Jürgen Schmidhuber. Multi-column deep neural networks for image classification. In *2012 IEEE conference on computer vision and pattern recognition*, pages 3642–3649. IEEE, 2012.
- [49] Yi-Tong Zhou and Rama Chellappa. Computation of optical flow using a neural network. In *IEEE International Conference on Neural Networks*, volume 1998, pages 71–78, 1988.
- [50] Sparsh Mittal. A survey of fpga-based accelerators for convolutional neural networks. *Neural computing and applications*, pages 1–31, 2018.
- [51] Lesya Anishchenko. Machine learning in video surveillance for fall detection. In *2018 Ural Symposium on Biomedical Engineering, Radioelectronics and Information Technology (USBREIT)*, pages 99–102. IEEE, 2018.
- [52] Francisco Javier Ordóñez and Daniel Roggen. Deep convolutional and lstm recurrent neural networks for multimodal wearable activity recognition. *Sensors*, 16(1):115, 2016.
- [53] L Fausset. What is a neural net? *Fundamentals of neural networks: architectures, algorithms, and applications* D. Fowley, B. Baker, and A. Dworkin, eds., Prentice Hall, Englewood Cliffs, NJ, pages 3–4, 1994.
- [54] Daniel Svozil, Vladimir Kvasnicka, and Jiri Pospichal. Introduction to multi-layer feed-forward neural networks. *Chemometrics and intelligent laboratory systems*, 39(1):43–62, 1997.
- [55] Alex Graves, Abdel-rahman Mohamed, and Geoffrey Hinton. Speech recognition with deep recurrent neural networks. In *2013 IEEE international conference on acoustics, speech and signal processing*, pages 6645–6649. IEEE, 2013.
- [56] Md Zia Uddin, Weria Khaksar, and Jim Torresen. A thermal camera-based activity recognition using discriminant skeleton features and rnn. In *2019 IEEE 17th International Conference on Industrial Informatics (INDIN)*, volume 1, pages 777–782. IEEE, 2019.
- [57] Ramya Anasseriyl Viswambaran, Gang Chen, Bing Xue, and Mohammad Nekooei. Evolutionary design of recurrent neural network architecture for human activity recognition. In *2019 IEEE Congress on Evolutionary Computation (CEC)*, pages 554–561. IEEE, 2019.
- [58] Sepp Hochreiter and Jürgen Schmidhuber. Long short-term memory. *Neural computation*, 9(8):1735–1780, 1997.
- [59] Dehua Hong, Zilong Zhang, and Xiaodong Xu. Automatic modulation classification using recurrent neural networks. In *2017 3rd IEEE International Conference on Computer and Communications (ICCC)*, pages 695–700. IEEE, 2017.
- [60] Hironao Okamoto, Takayuki Nishio, Masahiro Morikura, and Koji Yamamoto. Recurrent neural network-based received signal strength estimation using depth images for mmwave communications. In *2018 15th IEEE Annual Consumer Communications & Networking Conference (CCNC)*, pages 1–2. IEEE, 2018.
- [61] Nils Y Hammerla, Shane Halloran, and Thomas Plötz. Deep, convolutional, and recurrent models for human activity recognition using wearables. *arXiv preprint arXiv:1604.08880*, 2016.
- [62] Bram Bakker. Reinforcement learning with long short-term memory. *Advances in neural information processing systems*, 14:1475–1482, 2001.
- [63] Fathi M Salem. Slim lstms. *arXiv preprint arXiv:1812.11391*, 2018.
- [64] Abdulmajid Murad and Jae-Young Pyun. Deep recurrent neural networks for human activity recognition. *Sensors*, 17(11):2556, 2017.
- [65] Heiga Zen and Haşim Sak. Unidirectional long short-term memory recurrent neural network with recurrent output layer for low-latency speech synthesis. In *2015 IEEE International Conference on Acoustics, Speech and Signal Processing (ICASSP)*, pages 4470–4474. IEEE, 2015.

- [66] Cheng Wang, Haojin Yang, Christian Bartz, and Christoph Meinel. Image captioning with deep bidirectional lstms. In *Proceedings of the 24th ACM international conference on Multimedia*, pages 988–997, 2016.
- [67] Shudong Li, Zhou Yan, Xiaobo Wu, Aiping Li, and Bin Zhou. A method of emotional analysis of movie based on convolution neural network and bi-directional lstm rnn. In *2017 IEEE Second International Conference on Data Science in Cyberspace (DSC)*, pages 156–161. IEEE, 2017.
- [68] Alexander Grushin, Derek D Monner, James A Reggia, and Ajay Mishra. Robust human action recognition via long short-term memory. In *The 2013 International Joint Conference on Neural Networks (IJCNN)*, pages 1–8. IEEE, 2013.
- [69] Christopher G Harris, Mike Stephens, et al. A combined corner and edge detector. In *Alvey vision conference*, volume 15, pages 10–5244. Citeseer, 1988.
- [70] Yong Du, Wei Wang, and Liang Wang. Hierarchical recurrent neural network for skeleton based action recognition. In *Proceedings of the IEEE conference on computer vision and pattern recognition*, pages 1110–1118, 2015.
- [71] Ferda Ofli, Rizwan Chaudhry, Gregorij Kurillo, René Vidal, and Ruzena Bajcsy. Berkeley mhad: A comprehensive multimodal human action database. In *2013 IEEE Workshop on Applications of Computer Vision (WACV)*, pages 53–60. IEEE, 2013.
- [72] Meinard Müller, Tido Röder, Michael Clausen, Bernhard Eberhardt, Björn Krüger, and Andreas Weber. Documentation mocap database hdm05. 2007.
- [73] Wentao Zhu, Cuiling Lan, Junliang Xing, Wenjun Zeng, Yanghao Li, Li Shen, and Xiaohui Xie. Co-occurrence feature learning for skeleton based action recognition using regularized deep lstm networks. *arXiv preprint arXiv:1603.07772*, 2016.
- [74] Rui Xi, Mengshu Hou, Mingsheng Fu, Hong Qu, and Daibo Liu. Deep dilated convolution on multimodality time series for human activity recognition. In *2018 International Joint Conference on Neural Networks (IJCNN)*, pages 1–8. IEEE, 2018.
- [75] KU Syaliman, EB Nababan, and OS Sitompul. Improving the accuracy of k-nearest neighbor using local mean based and distance weight. In *Journal of Physics: Conference Series*, volume 978, page 012047. IOP Publishing, 2018.
- [76] Zhibin Pan, Yidi Wang, and Weiping Ku. A new k-harmonic nearest neighbor classifier based on the multi-local means. *Expert Systems with Applications*, 67:115–125, 2017.
- [77] Brian S Everitt, Sabine Landau, Morven Leese, and Daniel Stahl. Miscellaneous clustering methods. *Cluster Analysis*, pages 215–255, 2011.
- [78] N Suguna and K Thanushkodi. An improved k-nearest neighbor classification using genetic algorithm. *International Journal of Computer Science Issues*, 7(2):18–21, 2010.
- [79] Sauvik Das, L Green, Beatrice Perez, and Michael Murphy. Detecting user activities using the accelerometer on android smartphones (2010).
- [80] Mohammad Norouzi, David J Fleet, and Russ R Salakhutdinov. Hamming distance metric learning. In *Advances in neural information processing systems*, pages 1061–1069, 2012.
- [81] Yoshihiro Mitani and Yoshihiko Hamamoto. A local mean-based nonparametric classifier. *Pattern Recognition Letters*, 27(10):1151–1159, 2006.
- [82] Amri Danades, Devie Pratama, Dian Anggraini, and Diny Anggriani. Comparison of accuracy level k-nearest neighbor algorithm and support vector machine algorithm in classification water quality status. In *2016 6th International Conference on System Engineering and Technology (ICSET)*, pages 137–141. IEEE, 2016.
- [83] Elizabeth Nurmiyati Tamatjita and Aditya Wikan Mahastama. Comparison of music genre classification using nearest centroid classifier and k-nearest neighbours. In *2016 International Conference on Information Management and Technology (ICIMTech)*, pages 118–123. IEEE, 2016.
- [84] Jessica Maikhanh Brown. Predicting math test scores using k-nearest neighbor. In *2017 IEEE Integrated STEM Education Conference (ISEC)*, pages 104–106. IEEE, 2017.
- [85] Jianping Gou, Taisong Xiong, and Yin Kuang. A novel weighted voting for k-nearest neighbor rule. *JCP*, 6(5):833–840, 2011.
- [86] Vu Ngoc Thanh Sang, Nguyen Duc Thang, Vo Van Toi, Nguyen Duc Hoang, and Truong Quang Dang Khoa. Human activity recognition and monitoring using smartphones. In *5th International Conference on Biomedical Engineering in Vietnam*, pages 481–485. Springer, 2015.

- [87] Sonal Kumari and Suman K Mitra. Human action recognition using dft. In *2011 Third National Conference on Computer Vision, Pattern Recognition, Image Processing and Graphics*, pages 239–242. IEEE, 2011.
- [88] Vladimir Vapnik. *The nature of statistical learning theory*. Springer science & business media, 2013.
- [89] Shahid A Hasib, S Islam, Ripon K Chakraborty, Michael J Ryan, DK Saha, Md H Ahamed, SI Moyeen, Sajal K Das, Md F Ali, Md R Islam, et al. A comprehensive review of available battery datasets, rul prediction approaches, and advanced battery management. *IEEE Access*, 2021.
- [90] KG Manosha Chathuramali and Ranga Rodrigo. Faster human activity recognition with svm. In *International Conference on Advances in ICT for Emerging Regions (ICTer2012)*, pages 197–203. IEEE, 2012.
- [91] Asa Ben-Hur, David Horn, Hava T Siegelmann, and Vladimir Vapnik. Support vector clustering. *Journal of machine learning research*, 2(Dec):125–137, 2001.
- [92] Yoonkyung Lee, Yi Lin, and Grace Wahba. Multicategory support vector machines: Theory and application to the classification of microarray data and satellite radiance data. *Journal of the American Statistical Association*, 99(465):67–81, 2004.
- [93] Salah Althloothi, Mohammad H Mahoor, Xiao Zhang, and Richard M Voyles. Human activity recognition using multi-features and multiple kernel learning. *Pattern recognition*, 47(5):1800–1812, 2014.
- [94] K-R Muller, Sebastian Mika, Gunnar Ratsch, Koji Tsuda, and Bernhard Scholkopf. An introduction to kernel-based learning algorithms. *IEEE transactions on neural networks*, 12(2):181–201, 2001.
- [95] Victor Escorcía and Juan Niebles. Spatio-temporal human-object interactions for action recognition in videos. In *Proceedings of the IEEE International Conference on Computer Vision Workshops*, pages 508–514, 2013.
- [96] Christian Schuldt, Ivan Laptev, and Barbara Caputo. Recognizing human actions: a local svm approach. In *Proceedings of the 17th International Conference on Pattern Recognition, 2004. ICPR 2004.*, volume 3, pages 32–36. IEEE, 2004.
- [97] Chia-Chih Chen and JK Aggarwal. Recognizing human action from a far field of view. In *2009 Workshop on Motion and Video Computing (WMVC)*, pages 1–7. IEEE, 2009.
- [98] Hafiz Ahamed, Ishraq Alam, and Md Manirul Islam. Hog-cnn based real time face recognition. In *2018 International Conference on Advancement in Electrical and Electronic Engineering (ICAEEE)*, pages 1–4. IEEE, 2018.
- [99] Navneet Dalal and Bill Triggs. Histograms of oriented gradients for human detection. In *2005 IEEE computer society conference on computer vision and pattern recognition (CVPR'05)*, volume 1, pages 886–893. IEEE, 2005.
- [100] Kardelen Hatun and Pinar Duygulu. Pose sentences: a new representation for action recognition using sequence of pose words. In *2008 19th International Conference on Pattern Recognition*, pages 1–4. IEEE, 2008.
- [101] Wei-Lwun Lu and James J Little. Simultaneous tracking and action recognition using the pca-hog descriptor. In *The 3rd Canadian Conference on Computer and Robot Vision (CRV'06)*, pages 6–6. IEEE, 2006.
- [102] Christian Thureau. Behavior histograms for action recognition and human detection. In *Workshop on Human Motion*, pages 299–312. Springer, 2007.
- [103] Alireza Fathi and Greg Mori. Action recognition by learning mid-level motion features. In *2008 IEEE Conference on Computer Vision and Pattern Recognition*, pages 1–8. IEEE, 2008.
- [104] Jiajia Luo, Wei Wang, and Hairong Qi. Spatio-temporal feature extraction and representation for rgb-d human action recognition. *Pattern Recognition Letters*, 50:139–148, 2014.
- [105] Zhenyu He and Lianwen Jin. Activity recognition from acceleration data based on discrete cosine transform and svm. In *2009 IEEE International Conference on Systems, Man and Cybernetics*, pages 5041–5044. IEEE, 2009.
- [106] Shuangquan Wang, Jie Yang, Ningjiang Chen, Xin Chen, and Qinfeng Zhang. Human activity recognition with user-free accelerometers in the sensor networks. In *2005 International Conference on Neural Networks and Brain*, volume 2, pages 1212–1217. IEEE, 2005.
- [107] Mohiuddin Ahmed, Abdun Naser Mahmood, and Md Rafiqul Islam. A survey of anomaly detection techniques in financial domain. *Future Generation Computer Systems*, 55:278–288, 2016.
- [108] Shizhen Zhao, Wenfeng Li, and Jingjing Cao. A user-adaptive algorithm for activity recognition based on k-means clustering, local outlier factor, and multivariate gaussian distribution. *Sensors*, 18(6):1850, 2018.
- [109] Chunyu Chen, Yu Shao, and Xiaojun Bi. Detection of anomalous crowd behavior based on the acceleration feature. *IEEE sensors journal*, 15(12):7252–7261, 2015.

- [110] Xiangbin Zhu and Huiling Qiu. High accuracy human activity recognition based on sparse locality preserving projections. *PloS one*, 11(11):e0166567, 2016.
- [111] J Bilmes. What hmms can do, university of washington technical report, 2002.
- [112] Smita Kulkarni, Sangeeta Jadhav, and Debashis Adhikari. A survey on human group activity recognition by analysing person action from video sequences using machine learning techniques. In *Optimization in Machine Learning and Applications*, pages 141–153. Springer, 2020.
- [113] Lasitha Piyathilaka and Sarath Kodagoda. Gaussian mixture based hmm for human daily activity recognition using 3d skeleton features. In *2013 IEEE 8th conference on industrial electronics and applications (ICIEA)*, pages 567–572. IEEE, 2013.
- [114] Salvatore Iengo, Silvia Rossi, Mariacarla Staffa, and Alberto Finzi. Continuous gesture recognition for flexible human-robot interaction. In *2014 IEEE International Conference on Robotics and Automation (ICRA)*, pages 4863–4868. IEEE, 2014.
- [115] Ahmad Jalal, Naeha Sarif, Jeong Tai Kim, and Tae-Seong Kim. Human activity recognition via recognized body parts of human depth silhouettes for residents monitoring services at smart home. *Indoor and built environment*, 22(1):271–279, 2013.
- [116] Licheng Zhang, Xihong Wu, and Dingsheng Luo. Human activity recognition with hmm-dnn model. In *2015 IEEE 14th International Conference on Cognitive Informatics & Cognitive Computing (ICCI\* CC)*, pages 192–197. IEEE, 2015.
- [117] Ahmad Jalal, Shaharyar Kamal, and Daijin Kim. A depth video-based human detection and activity recognition using multi-features and embedded hidden markov models for health care monitoring systems. *International Journal of Interactive Multimedia & Artificial Intelligence*, 4(4), 2017.
- [118] Ahmad Jalal, Shaharyar Kamal, and Daijin Kim. Individual detection-tracking-recognition using depth activity images. In *2015 12th International Conference on Ubiquitous Robots and Ambient Intelligence (URAI)*, pages 450–455. IEEE, 2015.
- [119] Fatma Najar, Sami Bourouis, Nizar Bouguila, and Safya Belghith. Unsupervised learning of finite full covariance multivariate generalized gaussian mixture models for human activity recognition. *Multimedia Tools and Applications*, 78(13):18669–18691, 2019.
- [120] Kishore K Reddy and Mubarak Shah. Recognizing 50 human action categories of web videos. *Machine vision and applications*, 24(5):971–981, 2013.
- [121] Khurram Soomro, Amir Roshan Zamir, and Mubarak Shah. Ucf101: A dataset of 101 human actions classes from videos in the wild. *arXiv preprint arXiv:1212.0402*, 2012.
- [122] Moshe Blank, Lena Gorelick, Eli Shechtman, Michal Irani, and Ronen Basri. Actions as space-time shapes. In *Tenth IEEE International Conference on Computer Vision (ICCV’05) Volume 1*, volume 2, pages 1395–1402. IEEE, 2005.
- [123] Ivan Laptev, Marcin Marszalek, Cordelia Schmid, and Benjamin Rozenfeld. Learning realistic human actions from movies. In *2008 IEEE Conference on Computer Vision and Pattern Recognition*, pages 1–8. IEEE, 2008.
- [124] Marcin Marszalek, Ivan Laptev, and Cordelia Schmid. Actions in context. In *2009 IEEE Conference on Computer Vision and Pattern Recognition*, pages 2929–2936. IEEE, 2009.
- [125] Wanqing Li, Zhengyou Zhang, and Zicheng Liu. Action recognition based on a bag of 3d points. In *2010 IEEE Computer Society Conference on Computer Vision and Pattern Recognition-Workshops*, pages 9–14. IEEE, 2010.
- [126] Jubil T Sunny, Sonia Mary George, Jubilant J Kizhakkethottam, Jubil T Sunny, Sonia Mary George, and Jubilant J Kizhakkethottam. Applications and challenges of human activity recognition using sensors in a smart environment. *IJIRST Int. J. Innov. Res. Sci. Technol.*, 2:50–57, 2015.
- [127] Hildegard Kuehne, Hueihan Jhuang, Estibaliz Garrote, Tomaso Poggio, and Thomas Serre. Hmdb: a large video database for human motion recognition. In *2011 International Conference on Computer Vision*, pages 2556–2563. IEEE, 2011.
- [128] James L Crowley. Context aware vision using image-based active recognition. 2004.
- [129] Daniel Weinland, Remi Ronfard, and Edmond Boyer. Free viewpoint action recognition using motion history volumes. *Computer vision and image understanding*, 104(2-3):249–257, 2006.
- [130] Di Wu and Ling Shao. Silhouette analysis-based action recognition via exploiting human poses. *IEEE Transactions on Circuits and Systems for Video Technology*, 23(2):236–243, 2012.

- [131] Zhuolin Jiang, Zhe Lin, and Larry Davis. Recognizing human actions by learning and matching shape-motion prototype trees. *IEEE Transactions on Pattern Analysis and Machine Intelligence*, 34(3):533–547, 2012.
- [132] Piotr Bilinski and Francois Bremond. Video covariance matrix logarithm for human action recognition in videos. In *IJCAI 2015-24th International Joint Conference on Artificial Intelligence (IJCAI)*, 2015.
- [133] Hossein Rahmani, Ajmal Mian, and Mubarak Shah. Learning a deep model for human action recognition from novel viewpoints. *IEEE transactions on pattern analysis and machine intelligence*, 40(3):667–681, 2017.
- [134] Fabien Baradel, Christian Wolf, and Julien Mille. Pose-conditioned spatio-temporal attention for human action recognition. *arXiv preprint arXiv:1703.10106*, 2017.
- [135] Zhong Zhang, Chunheng Wang, Baihua Xiao, Wen Zhou, Shuang Liu, and Cunzhao Shi. Cross-view action recognition via a continuous virtual path. In *Proceedings of the IEEE Conference on Computer Vision and Pattern Recognition*, pages 2690–2697, 2013.
- [136] Jiang Wang, Xiaohan Nie, Yin Xia, Ying Wu, and Song-Chun Zhu. Cross-view action modeling, learning and recognition. In *Proceedings of the IEEE Conference on Computer Vision and Pattern Recognition*, pages 2649–2656, 2014.
- [137] Honghai Liu, Zhaojie Ju, Xiaofei Ji, Chee Seng Chan, and Mehdi Khoury. A view-invariant action recognition based on multi-view space hidden markov models. In *Human Motion Sensing and Recognition*, pages 251–267. Springer, 2017.
- [138] Simon Hadfield, Karel Lebeda, and Richard Bowden. Hollywood 3d: What are the best 3d features for action recognition? *International Journal of Computer Vision*, 121(1):95–110, 2017.
- [139] Khoulood Chebli and Anouar Ben Khalifa. Pedestrian detection based on background compensation with block-matching algorithm. In *2018 15th International Multi-Conference on Systems, Signals & Devices (SSD)*, pages 497–501. IEEE, 2018.
- [140] Qinjun Xu, Tongchi Zhou, Lin Zhou, and Zhenyang Wu. Exploring encoding and normalization methods on probabilistic latent semantic analysis model for action recognition. In *2016 8th International Conference on Wireless Communications & Signal Processing (WCSP)*, pages 1–5. IEEE, 2016.
- [141] Paul Duckworth, Muhannad Alomari, Yiannis Gatsoulis, David C Hogg, and Anthony G Cohn. Unsupervised activity recognition using latent semantic analysis on a mobile robot. In *IOS Press Proceedings*, number 285, pages 1062–1070, 2016.
- [142] Imen Jegham, Anouar Ben Khalifa, Ihsen Alouani, and Mohamed Ali Mahjoub. Vision-based human action recognition: An overview and real world challenges. *Forensic Science International: Digital Investigation*, 32:200901, 2020.
- [143] AK Niloy, Anika Shama, Ripon K Chakraborty, Michael J Ryan, Faisal R Badal, Zinat Tasneem, Md H Ahamed, Sumaya I Moyeen, Sajal K Das, Md F Ali, et al. Critical design and control issues of indoor autonomous mobile robots: A review. *IEEE Access*, 2021.