

CLUSTER STRUCTURES ON SPINOR HELICITY AND MOMENTUM TWISTOR VARIETIES

LARA BOSSINGER, JIAN-RONG LI

ABSTRACT. We study the homogeneous coordinate rings of partial flag varieties and Grassmannians in their Plücker embeddings and exhibit an embedding of the former into the latter. Both rings are cluster algebras and the embedding respects the cluster algebra structures in the sense that there exists a seed for the Grassmannian that restricts to a seed for the partial flag variety (i.e. it is obtained by freezing and deleting some cluster variables).

The motivation for this project stems from the application of cluster algebras in scattering amplitudes: spinor helicity and momentum twistor varieties describe massless scattering without assuming dual conformal symmetry. Both may be obtained from Grassmannians which model the dual conformal case. They are instances of partial flag varieties and their cluster structures reveal information for the scattering amplitudes. As an application of our main result we exhibit the relation between these cluster algebras.

1. INTRODUCTION

1.1. Motivation from particle physics. In the study of scattering amplitudes in quantum field theories for massless scattering the kinematic space modeling particle interactions is represented by two complex matrices λ and $\tilde{\lambda}$ of size $2 \times n$ with property that $\lambda \tilde{\lambda}^T$ is zero. This is known as the *spinor-helicity formalism* [BHPZ24, Section 1.8]. In this situation the 2×2 -minors of λ are typically denoted by $\langle ij \rangle$ and the 2×2 -minors of $\tilde{\lambda}$ by $[ij]$ for $1 \leq i < j \leq n$ (notice that $\langle ij \rangle = -\langle ji \rangle$ and similarly for $[ij]$). Each class of minors satisfy *quadratic Plücker relations* also known as *Schouten identities*, namely for all $1 \leq i < j < k < l \leq n$

$$[ij][kl] - [ik][jl] + [il][jk] = 0 \quad \text{and} \quad \langle ij \rangle \langle kl \rangle - \langle ik \rangle \langle jl \rangle + \langle il \rangle \langle jk \rangle = 0$$

and additionally *momentum conservation* for all $1 \leq i, j \leq n$

$$\sum_{s=1}^n \langle is \rangle [sj] = 0.$$

Adding the genericity assumptions that λ and $\tilde{\lambda}$ are of full rank the space determined by the above equations is known as the **spinor helicity variety** [EMPS24] and we denote it by \mathcal{SH}_n (the notation \mathcal{SH}_n corresponds to $SH(2, n, 0)$ in [EMPS24], the spaces of interest to the authors in *loc.cit.* are generalizations). It is shown in [EMPS24, Proposition 2.5] that \mathcal{SH}_n is isomorphic to the *partial flag variety* $\mathcal{F}_{2, n-2; n}$ (see (1.4) for the definition) with isomorphism given by

$$(1.1) \quad \langle ij \rangle \mapsto P_{ij}, \quad \text{and} \quad [ij] \mapsto (-1)^{i+j-1} P_{[n]-\{i, j\}},$$

here P_{ij} and $P_{[n]-\{i, j\}}$ denote *Plücker coordinates* of $\mathcal{F}_{2, n-2; n}$, see (2.2) below. From the physics point of view the scattering process may also be described in terms of *momentum twistors* $Z_1, \dots, Z_n \in \mathbb{CP}^3$ representing the particles in Minkowski space. In the planar model a fixed order among the Z_i is assumed which yields a cyclic symmetry. Interpreting

the coordinates of Z_i as column vectors we obtain a $4 \times n$ matrix up to column rescaling. If the system has *dual conformal symmetry* a parametrization is given by maximal minors of this matrix

$$\langle ijkl \rangle := \det(Z_i Z_j Z_k Z_l)$$

representing a Plücker coordinate P_{ijkl} in the Grassmannian $\text{Gr}_{4;n}$ (up to sign). If the system does not have dual conformal symmetry, i.e. it is *non-dual conformal invariant* (or NDCI for short) we add an *infinity twistor* in form of a line ℓ_∞ . The line ℓ_∞ may be understood as the line spanned by two additional points $Z_{n+1}, Z_{n+2} \in \mathbb{C}P^3$. In particular, we may now interpret the coordinates of Z_1, \dots, Z_{n+2} as a $4 \times (n+2)$ matrix. However the kinematics do not depend on each of the two points Z_{n+1}, Z_{n+2} separately, but rather only on the line ℓ_∞ : moving either point along the line (as long as it does not collide with the other) does not change the configuration. This fact is reflected in the parametrization as follows: consider only those minors $\langle ijkl \rangle$ that satisfy

$$n+1, n+2 \in \{i, j, k, l\} \quad \text{or} \quad n+1, n+2 \notin \{i, j, k, l\}.$$

The former are denoted by $\langle ij \rangle$ omitting the indices $n+1, n+2$ from the set. More precisely, we define a map of polynomial rings

$$\phi_n : \mathbb{k}[\langle ij \rangle, \langle ijkl \rangle : i, j, k, l \in [n]] \rightarrow \mathbb{k}[z_{a,b} : a \in [4], b \in [n+2]]$$

by $\langle ij \rangle \mapsto \det((z_{a,b})_{a \in [4], b \in \{i, j, n+1, n+2\}})$ and $\langle ijkl \rangle \mapsto \det((z_{a,b})_{a \in [4], b \in \{i, j, k, l\}})$. Let $J_n = \ker(\phi_n)$. The vanishing set of the ideal J_n is naturally defined in a product of two projective spaces $\mathbb{P}^{\binom{n}{2}-1} \times \mathbb{P}^{\binom{n}{4}-1}$ determined by the bigrading on $\mathbb{k}[\langle ij \rangle, \langle ijkl \rangle : i, j, k, l \in [n]]$. We define the **momentum twistor variety** \mathcal{MT}_n as $V(J_n) \subset \mathbb{P}^{\binom{n}{2}-1} \times \mathbb{P}^{\binom{n}{4}-1}$. Identifying

$$(1.2) \quad \langle ij \rangle \mapsto P_{ij}, \quad \text{and} \quad \langle ijkl \rangle \mapsto P_{ijkl},$$

yields an isomorphism between \mathcal{MT}_n and the partial flag variety $\mathcal{Fl}_{2,4;n}$ by Proposition 2.2.

The change of parametrization between spinor helicity and momentum twistor variables is known, however highly nontrivial, see *e.g.* [EtH15, Equation 5.49]. Part of the map is given by $\langle ij \rangle \mapsto \langle ij \rangle$ and

$$(1.3) \quad \langle i-1, i, j, j+1 \rangle \mapsto [ij] \langle ij \rangle \langle i-1, i \rangle \langle j, j+1 \rangle,$$

see [EtH15, Equation 5.52]. In the case of $n=5$ there is a further isomorphism between the affine cone of \mathcal{SH}_5 and the affine cone of the Grassmannian $\text{Gr}_{3;6}$, see *e.g.* [BDG23, Equation (6.12)]. To summarize, we have the following spaces modelling massless particle configurations and maps between them:

$$\begin{array}{ccc} \mathcal{SH}_n & \xleftarrow[\sim]{(1.1)} & \mathcal{Fl}_{2,n-2;n} \\ \downarrow (1.3) & & \downarrow (1.3) \\ \mathcal{MT}_n & \xleftarrow[\sim]{(1.2)} & \mathcal{Fl}_{2,4;n} \end{array}$$

In recent years the computation of scattering amplitudes has been simplified by refraining from actually computing the Feynman integrals which are its summand, but rather computing the amplitude directly (*e.g.* as the canonical form of the *amplituhedron* [AHT14, DFLP19, EZLP⁺23, EZLP⁺24]). This has led to a *bootstrap*: the amplitude is expected to be a polylogarithmic function on the kinematic space with a certain singularity structure. Predicting the singularities eventually leads to a unique solution, see *e.g.* [BSS77, BDS05, CHDMvH16, CHDD⁺19b, CHDD⁺19a, DDH⁺17, DDH11, DDH12, DDvHP13, DFG18, DFG19,

DFGP19, DDDP14, DvH14, DvHM16, DPS15, GGS⁺14, GSO77, tH93]. In the planar dual conformal case corresponding to $\text{Gr}_{4;n}$ cluster algebras have been extremely useful as in many cases cluster variables are singularities of the amplitude. For non-planar non-dual cases however so far few is known, see [BDG23, Section 6] for $n = 5$.

In this paper we explore the cluster structures of kinematic spaces in form of the spinor helicity variety $\mathcal{SH}_n \cong \mathcal{F}\ell_{2,n-2;n}$ and the momentum twistor variety $\mathcal{MT}_n \cong \mathcal{F}\ell_{2,4;n}$ and show how they can be obtained from the cluster structure on Grassmannians. Our results work for general partial flag varieties. To state our results, we first give some mathematical background.

1.2. Mathematical setup. We refer to [LB15, §5] and [Ful97] for more details on the material in this subsection.

For a positive integer i write $[i] := \{1, \dots, i\}$ and for $j > i$ write $[i, j] := \{i, i+1, \dots, j\}$. Let n be a positive integer and let $1 \leq d_1 < d_2 < \dots < d_k < n$. To this data we associate the variety of partial flags of subspaces in \mathbb{k}^n (\mathbb{k} a field of characteristic zero):

$$(1.4) \quad \mathcal{F}\ell_{d_1, \dots, d_k; n}(\mathbb{k}) := \{0 \in V_1 \subset V_2 \subset \dots \subset V_k \subset \mathbb{k}^n : \dim V_i = d_i\}.$$

When there is no confusion regarding the base field we drop it from the notation and simply write $\mathcal{F}\ell_{d_1, \dots, d_k; n}$. Moreover, it will be convenient to set $d_0 := 0$ and $d_{k+1} := n$. If $k = 1$ the associated partial flag variety is a *Grassmannian*

$$\mathcal{F}\ell_{d; n} = \text{Gr}_{d; n} := \{0 \in V \subset \mathbb{k}^n : \dim V = d\}.$$

In this paper we are interested in a map between the (multi-)homogeneous coordinate rings of a partial flag variety in its Plücker embedding (recalled below), denoted $\mathbb{k}[\mathcal{F}\ell_{d_1, \dots, d_k; n}]$ and the homogeneous coordinate ring of a Grassmannian in its Plücker embedding, denoted $\mathbb{k}[\text{Gr}_{d_k; N}]$ with $N = n + d_k - d_1$. We define

$$(1.5) \quad \varphi^* : \mathbb{k}[\mathcal{F}\ell_{d_1, \dots, d_k; n}] \rightarrow \mathbb{k}[\text{Gr}_{d_k; N}]$$

given by the images of the Plücker coordinates with $I \subset [n]$ of cardinality d_i , $i \in [k]$ by

$$P_I \mapsto P_{I \cup [n+1, n+d_k-d_i]}.$$

In Lemma 2.2 we verify that the map is well defined. We are slightly abusing notation by denoting Plücker coordinates of $\mathcal{F}\ell_{d_1, \dots, d_k; n}$ and $\text{Gr}_{d_k; N}$ by the same symbol.

Both rings $\mathbb{k}[\text{Gr}_{d_k; N}]$ and $\mathbb{k}[\mathcal{F}\ell_{d_1, \dots, d_k; n}]$ carry the structure of a cluster algebra [FZ02], see [Sco06] for $\mathbb{k}[\text{Gr}_{d_k; N}]$ and [GLS08] for $\mathbb{k}[\mathcal{F}\ell_{d_1, \dots, d_k; n}]$. Our main result is the following.

Theorem 1.1. *There exists a seed s' for $\mathbb{k}[\text{Gr}_{d_k; N}]$ such that the initial seed of $\mathbb{k}[\mathcal{F}\ell_{d_1, \dots, d_k; n}]$ is obtained from s' by freezing and deleting.*

In technical terms the initial seed of $\mathbb{k}[\mathcal{F}\ell_{d_1, \dots, d_k; n}]$ is a *restricted seed* of s' for $\mathbb{k}[\text{Gr}_{d_k; N}]$, see §4 and [FWZ17]. Theorem 1.1 is proved in §4 by exhibiting an explicit mutation sequence.

The momentum twistor variety has a cluster structure induced by the cluster structure on $\mathcal{F}\ell_{2,4;n}$ and the spinor helicity variety has a cluster structure, namely the one on $\mathcal{F}\ell_{2,n-2;n}$. Theorem 1.1 the following results regarding the momentum twistor variety \mathcal{MT}_n and the spinor helicity variety \mathcal{SH}_n (more details in §5):

Theorem 1.2. *The momentum twistor variety has a cluster structure induced by the cluster structure on $\mathcal{F}\ell_{2,4;n}$. It may be obtained from the initial cluster of the Grassmannian $\text{Gr}_{4;n+2}$ by three mutations followed by one freezing and three deletions.*

Theorem 1.3. *The spinor helicity variety has a cluster structure, induced by the one on $\mathcal{F}\ell_{2,n-2;n}$. It may be obtained from the initial cluster of the Grassmannian $\text{Gr}_{n-2;2n-4}$ by $\frac{1}{2}(n-5)(n^2-10n+30)$ mutations followed by freezing $n-5$ cluster variables and deleting $(n-3)(n-5)$ vertices.*

Cluster algebras of Grassmannians and flag varieties have been studied from several points of view including monoidal categorification [HL10]. This has led to a good combinatorial understanding of certain elements. More precisely, there is a bijection between *semistandard Young tableaux* [Ful97] (of suitable shape and up to equivalence of tableaux, see §3.6) and elements of the *dual canonical basis* [Lus90] (compare to *crystal basis* in [Kas91]) sending T to the basis element $\text{ch}(T)$; this bijection is due to [CDFL20, Li24] based on the representation theory of quantum affine algebras [CP91] and their relation to cluster algebras [HL10]. An explicit expression of the dual canonical basis element denoted by $\text{ch}(T)$ in terms of monomials in Plücker coordinates is given by the *character formula*, see (3.2) and (3.4). More precisely, the character of a tableau is an expression in *standard monomials*, *i.e.* monomials in Plücker coordinates whose index sets form the columns of a semistandard Young tableau [LR08]. The character formula amounts to the change of basis from standard monomial basis to dual canonical basis. In particular, cluster variables and more generally *cluster monomials* (monomials in cluster variables that are all in one seed) are elements of the dual canonical basis [Qin17, KKOP21, KKOP24].

The tableaux for the Grassmannian $\text{Gr}_{d;n}$ are of rectangular shape with d rows and entries in $[n]$, denoted $\text{SSYT}_{d;n}$. The tableaux for $\mathcal{F}\ell_{d_1,\dots,d_k;n}$ may have columns with d_1, \dots, d_k many rows and entries in $[n]$, denoted $\text{SSYT}_{d_1,\dots,d_k;n}$. In Corollary 3.5 we describe the tableaux of the initial cluster variables of $\mathcal{F}\ell_{d_1,\dots,d_k;n}$ explicitly, called the *initial tableaux*.

The map (1.5) naturally induces a map

$$(1.6) \quad \phi : \text{SSYT}_{d_1,\dots,d_k;n} \rightarrow \text{SSYT}_{d_k;N}$$

by filling up all columns with $d_i < d_k$ many rows to columns with d_k many rows by adding the entries $n+1, n+2, \dots, n+d_k-d_i$. The images of the initial tableaux of $\mathcal{F}\ell_{d_1,\dots,d_k;n}$ are given in Corollary 3.6. The following result is a consequence of Theorem 1.1 and we prove it in §3.6.

Corollary 1.4. *Let $1 \leq d_1 < \dots < d_k < n$ and consider the flag variety $\mathcal{F}\ell_{d_1,\dots,d_k;n}$. Let T be the tableaux of an initial cluster variable. Then*

$$(1.7) \quad \text{ch}(\phi(T)) = \varphi^*(\text{ch}(T)).$$

It would be insightful to see if this is true more generally for arbitrary dual canonical basis elements, that is:

Question 1.5. Given a tableaux T for $\mathcal{F}\ell_{d_1,\dots,d_k;n}$ and the corresponding element of the dual canonical basis $\text{ch}(T)$. Then $\phi(T)$ is a tableaux for $\text{Gr}_{d_k;N}$ with dual canonical basis element $\text{ch}(\phi(T))$. Is it true that Equation (1.7) holds in this generality?

1.3. Structure. In §2 we recall the cluster algebra structure on partial flag varieties due to Geiss, Leclerc and Schröer [GLS08]. We extend their results by introducing the combinatorial gadget of *pseudoline arrangements* in this context and slightly adapt their constructions to our needs. Further, in §3 we recall the notion of tableaux that parametrize dual canonical basis elements [CDFL20]. In this section we investigate the characters and tableaux of initial minors and how they behave under the embeddings into Grassmannians. The proof of

Corollary 1.4 is included in this section. In §4 we prove Theorem 1.1 by exhibiting explicit mutation sequences in the corresponding Grassmannians. In §5, we describe the mutation sequences for momentum twist varieties and spinor helicity varieties as an application of Theorem 1.1.

Acknowledgements. This project started at the Simons Center for Geometry and Physics workshop on *Mathematical Aspects of N=4 Super-Yang-Mills Theory*, we are grateful to the organizers. Moreover, we would like to thank James Drummond, Ömer Gürdoğan, June Huh and Lauren Williams for their comments and fruitful discussions. LB is grateful to Leonid Monin and Alfredo Nájera Chávez for discussions on the cluster structure of partial flag varieties. JRL would like to thank the Galileo Galilei Institute for Theoretical Physics for the hospitality and the INFN for partial support during the completion of this work. LB is supported by the UNAM DGAPA PAPIIT project IA100724 and the CONAHCyT project CF-2023-G-106. JRL is supported by the Austrian Science Fund (FWF): P-34602, Grant DOI: 10.55776/P34602, and PAT 9039323, Grant-DOI 10.55776/PAT9039323.

2. CLUSTER STRUCTURE ON PARTIAL FLAG VARIETIES

Denote by SL_n the special linear group of $n \times n$ matrices with entries in a field \mathbb{k} . We fix the Borel subgroup of upper triangular matrices $B \subset SL_n$ and the subgroup of unipotent matrices $U \subset B$; analogously for the lower triangular case we denote $U^- \subset B^- \subset SL_n$. Additionally, let $T \subset B$ be the torus of diagonal matrices. Given a parabolic subgroup $P^- \supset B^-$ of SL_n the quotient $P^- \backslash SL_n$ is a partial flag variety $\mathcal{F}l_{d_1, \dots, d_k; n}$ for some d_1, \dots, d_k , so we write $P^- = P_{d_1, \dots, d_k; n}^-$. We denote the unipotent radical of $P_{d_1, \dots, d_k; n}^- := (P_{d_1, \dots, d_k; n}^-)^T$ by $U_{d_1, \dots, d_k; n}$. Then $U_{d_1, \dots, d_k; n} \subset U$ is an affine variety of the same dimension as $\mathcal{F}l_{d_1, \dots, d_k; n}$. In fact we have an embedding $\iota : U_{d_1, \dots, d_k; n} \hookrightarrow \mathcal{F}l_{d_1, \dots, d_k; n}$ given by generating a flag from the rows of a matrix in $U_{d_1, \dots, d_k; n}$.

Example 2.1. Consider $\mathcal{F}l_{2,4,5}$ and let $B \subset SL_5$ be upper triangular matrices. Then

$$P_{2,4,5}^- = \begin{pmatrix} * & * & 0 & 0 & 0 \\ * & * & 0 & 0 & 0 \\ * & * & * & * & 0 \\ * & * & * & * & 0 \\ * & * & * & * & * \end{pmatrix} \quad \text{and} \quad U_{2,4,5} = \begin{pmatrix} 1 & 0 & * & * & * \\ 0 & 1 & * & * & * \\ 0 & 0 & 1 & 0 & * \\ 0 & 0 & 0 & 1 & * \\ 0 & 0 & 0 & 0 & 1 \end{pmatrix}.$$

The embedding $U_{2,4,5} \hookrightarrow \mathcal{F}l_{2,4,5}$ sends a matrix $M \in U_{2,4,5}$ with rows m_1, \dots, m_5 to the flag

$$\{0\} \subset \langle m_1, m_2 \rangle \subset \langle m_1, \dots, m_4 \rangle \subset \mathbb{k}^5.$$

For the corresponding Lie algebras we use the notation: $\text{Lie}(SL_n) = \mathfrak{sl}_n$, $\text{Lie}(B) = \mathfrak{b}$ and $\text{Lie}(U) = \mathfrak{n}$, $\text{Lie}(T) = \mathfrak{h}$. The simple roots of \mathfrak{h} are denoted by $\alpha_1, \dots, \alpha_{n-1}$ and the fundamental weights are $\omega_1, \dots, \omega_{n-1}$.

The coordinate ring $\mathbb{k}[U]$ has a cluster algebra structure due to Berenstein, Fomin and Zelevinsky [BFZ96, BFZ05]. Their work was generalized to the case of $\mathbb{k}[U_{d_1, \dots, d_k; n}]$ by Geiss, Leclerc and Schröer [GLS08]. The cluster algebra structure on $\mathbb{k}[U_{d_1, \dots, d_k; n}]$ lifts to a cluster algebra structure on $\mathbb{k}[\mathcal{F}l_{d_1, \dots, d_k; n}]$ via the pullback of the embedding $U_{d_1, \dots, d_k; n} \hookrightarrow \mathcal{F}l_{d_1, \dots, d_k; n}$. We recall the details in the following subsections.

2.1. Plücker relations. We start by recalling the Plücker embedding of a Grassmannian. Let $(e_i)_{1 \leq i \leq n}$ denote the standard basis of \mathbb{k}^n , so that

$$\{e_{i_1} \wedge \cdots \wedge e_{i_d} \mid 1 \leq i_1 < i_2 < \cdots < i_d \leq n\}$$

is a basis of $\wedge^d \mathbb{k}^n$. Let $(\wedge^d \mathbb{k}^n)^*$ be the dual vector space, then the Plücker coordinate $P_{i_1, \dots, i_d} \in (\wedge^d \mathbb{k}^n)^*$ for $1 \leq i_1 < i_2 < \cdots < i_d \leq n$ is defined to be the basis element dual to $e_{i_1} \wedge \cdots \wedge e_{i_d}$. For $i_1, \dots, i_d \in [n]$ pairwise distinct, but not necessarily increasing, the Plücker coordinate P_{i_1, \dots, i_d} has the following property

$$P_{\sigma(i_1), \dots, \sigma(i_d)} = (-1)^{\ell(\sigma)} P_{i_1, \dots, i_d} \quad \text{for all } \sigma \in S_n,$$

where S_n denotes the symmetric group. Let $\mathcal{S}(n, d)$ be the set of tuples $I = (i_1, \dots, i_d)$ with entries in n and denote by $P_I = P_{i_1, \dots, i_d}$ the Plücker coordinate. Notice that $P_I = 0$ if not all entries in I are distinct. To simplify notation we index some Plücker coordinates by a set instead of a sequence which is interpreted as being indexed by the sequence obtained by arranging the elements of the set in an increasing order. In this way we obtain the *Plücker embedding*

$$(2.1) \quad \text{Gr}_{d;n} \hookrightarrow \mathbb{P}(\wedge^d \mathbb{k}^n) \cong \mathbb{P}^{\binom{n}{d}-1}.$$

The flag variety is embedded in the product of Grassmannians

$$\mathcal{F}l_{d_1, \dots, d_k; n} \hookrightarrow \text{Gr}_{d_1; n} \times \text{Gr}_{d_2; n} \times \cdots \times \text{Gr}_{d_k; n}.$$

By composing the latter embedding with the embedding (2.1) for each Grassmannian in the product, we get the *Plücker embedding*

$$(2.2) \quad \mathcal{F}l_{d_1, \dots, d_k; n} \hookrightarrow \mathbb{P}^{\binom{n}{d_1}-1} \times \cdots \times \mathbb{P}^{\binom{n}{d_k}-1}.$$

Denote by $I_{d_1, \dots, d_k; n}$ the (homogeneous) ideal of $\mathcal{F}l_{d_1, \dots, d_k; n}$ in $\mathbb{k}[P_I : I \in \mathcal{S}(n, d_i), i \in [k]]$ with respect to this embedding. The ideal $I_{d_1, \dots, d_k; n}$ is generated by *Plücker relations*, which are defined as follows: for each choice of $p \leq q$ with $p, q \in \{d_1, \dots, d_k\}$, a number $s \in [p]$ and a pair of tuples $J \in \mathcal{S}(n, d_p), L \in \mathcal{S}(n, d_q)$ we define

$$(2.3) \quad R_{J,L}^s = P_J P_L - \sum_{1 \leq r_1 < \cdots < r_s \leq d_q} P_{J'} P_{L'},$$

where $L' = (L \setminus (l_{r_1}, \dots, l_{r_s})) \cup (j_1, \dots, j_s)$ and $J' = (J \setminus (j_1, \dots, j_s)) \cup (l_{r_1}, \dots, l_{r_s})$ [Ful97, p.135, Equation (3)], [Fei12, Equation (1.1)]. Notice that this is a restricted set of Plücker relations in the sense that the exchange taking place among the index sets only involves the elements $j_1, \dots, j_s \in J$.

Before proceeding to verify that the map (1.5) is well defined, notice that $\mathbb{k}[\mathcal{F}l_{d_1, \dots, d_k; n}]$ is $\mathbb{Z}_{\geq 0}^k$ -multigraded. Denote by $\epsilon_1, \dots, \epsilon_k$ the standard basis of \mathbb{Z}^k . We have $\deg(P_I) = \epsilon_{|I|}$. Recall that φ^* defined in (1.5) is induced by a map on the polynomial rings (which we also denote as φ^* by abuse of notation)

$$\varphi^* : \mathbb{k}[P_I : I \in \mathcal{S}(n, d_i), i \in [k]] \rightarrow \mathbb{k}[P_I : I \in \mathcal{S}(N, d_k)]$$

given by $P_I \mapsto P_{I \cup [n+1, n+d_k-d_i]}$ for $I \in \mathcal{S}(n, d_i), i \in [k]$.

Proposition 2.2. *We have the identity*

$$(2.4) \quad I_{d_k; N} \cap \mathbb{k}[P_{I \cup [n+1, n+d_k-d_i]} : I \in \mathcal{S}(n; d_i), i \in [k]] = \varphi^*(I_{d_1, \dots, d_k; n}),$$

and the map $\varphi^* : \mathbb{k}[\mathcal{F}l_{d_1, \dots, d_k; n}] \rightarrow \mathbb{k}[\text{Gr}_{d_k; N}]$ is a homomorphism of graded algebras and an embedding.

Proof. By definition, the images of Plücker coordinates in the flag are Plücker coordinates in the Grassmannian, in consequence the map is graded. The algebra $\mathbb{k}[\mathcal{F}\ell_{d_1, \dots, d_k; n}]$ is a quotient of the polynomial ring $\mathbb{k}[P_I : I \in \mathcal{S}(n, d_i), i \in [k]]$ by the ideal $I_{d_1, \dots, d_k; n}$. Similarly, $\mathbb{k}[\text{Gr}_{d_k; N}]$ is the quotient of the polynomial ring $\mathbb{k}[P_I : I \in \mathcal{S}(N, d_k)]$ by the ideal $I_{d_k; N}$. The map φ^* on the polynomial rings is a well defined embedding. We first show that the image of $I_{d_1, \dots, d_k; n}$ is contained in $I_{d_k; N}$ by proving it for each of the generators: let $p \leq q$, $p, q \in \{d_1, \dots, d_k\}$, $s \in [p]$ and $J \in \mathcal{S}(n, d_p), L \in \mathcal{S}(n, d_q)$ and compute

$$\varphi^*(R_{J,L}^s) = P_{J \cup [n+1, n+d_k-d_p]} P_{L \cup [n+1, n+d_k-d_q]} - \sum_{1 \leq r_1 < \dots < r_s \leq d_q} P_{J' \cup [n+1, n+d_k-d_p]} P_{L' \cup [n+1, n+d_k-d_q]}$$

We claim that the image coincides with the generator for $s, J \cup [n+1, n+d_k-d_p], L \cup [n+1, n+d_k-d_q]$ in $I_{d_k; N}$:

$$(2.5) \quad R_{J \cup [n+1, n+d_k-d_p], L \cup [n+1, n+d_k-d_q]}^s = P_{J \cup [n+1, n+d_k-d_p]} P_{L \cup [n+1, n+d_k-d_q]} - \sum_{1 \leq r_1 < \dots < r_s \leq d_k} P_{(J \cup [n+1, n+d_k-d_p])'} P_{(L \cup [n+1, n+d_k-d_q])'}$$

The sum of the right hand side splits into two parts: either $1 \leq r_1 < \dots < r_s \leq d_q$ in which case

$$(J \cup [n+1, n+d_k-d_p])' = J' \cup [n+1, n+d_k-d_p] \text{ and } (L \cup [n+1, n+d_k-d_q])' = L' \cup [n+1, n+d_k-d_q];$$

or there exists $r_j > d_q$ so that $\ell_{r_j} \in [n+1, n+d_k-d_q]$, hence $\ell_{r_j} \in (J \setminus (j_1, \dots, j_s)) \cup [n+1, n+d_k-d_p]$ and therefore $P_{(J \cup [n+1, n+d_k-d_p])'} = 0$. We deduce

$$\varphi^*(R_{J,L}^s) = R_{J \cup [n+1, n+d_k-d_p], L \cup [n+1, n+d_k-d_q]}^s,$$

which implies $\varphi^*(I_{d_1, \dots, d_k; n}) \subset I_{d_k; N}$. To see that φ^* is an embedding consider $\bar{f} \in \mathbb{k}[\mathcal{F}\ell_{d_1, \dots, d_k; n}]$ with $\varphi^*(\bar{f}) = 0$. Then \bar{f} is represented by a polynomial $f \in \mathbb{k}[P_I : I \in \mathcal{S}(n, d_i), i \in [k]]$ with $\varphi^*(f) \in I_{d_k; N}$, so

$$\varphi^*(f) \in I_{d_k; N} \cap \mathbb{k}[P_{I \cup [n+1, n+d_k-d_i]} : I \in \mathcal{S}(n; d_i), i \in [k]].$$

The RHS is generated by elements of form (2.5) which coincides with the image of a generator of $I_{d_1, \dots, d_k; n}$. So we have the identity (2.4) and the second claim follows. \square

Hence, geometrically we have a map between the affine cones

$$\widetilde{\text{Gr}}_{d_k; N} \rightarrow \widetilde{\mathcal{F}\ell}_{d_1, \dots, d_k; n}.$$

Note that the map does not induce a map between the projective varieties due to the different gradings.

2.2. Pseudoline arrangements. For $\mathcal{F}\ell_{d_1, \dots, d_k; n}$ the *pseudoline arrangement* (sometimes also known as *wiring diagram*) $\mathcal{P}_{d_1, \dots, d_k; n}$ is a pictorial presentation of the permutation $\sigma \in S_n$ whose one-line presentation is

$$\sigma = [d_k + 1, d_k + 2, \dots, n, d_{k-1} + 1, d_{k-1} + 2, \dots, d_k, \dots, 1, \dots, d_1].$$

Notice that σ is the permutation corresponding to the minimal representative of the coset of the longest word in $S_n / (s_i : i \notin \{d_1, \dots, d_k\})$.

Algorithm 1: Pseudoline arrangement

We draw $\mathcal{P}_{d_1, \dots, d_k; n}$ inside a two-dimeinsional positive orthant.

- (1) Label the x - and y -axes by $1, \dots, n$

- (2) For each i draw a line segment from $(i, 0)$ to $(i, \sigma(i))$ and another line segment from $(0, \sigma(i))$ to $(i, \sigma(i))$. The union of the two line segments is called the *pseudoline* (or *wire*) ℓ_i .

An example of the resulting pseudoline arrangement $\mathcal{P}_{2,5;7}$ is given in Figure 1.

2.3. Quivers. We associate a quiver $Q_{d_1, \dots, d_k; n}$ to $\mathcal{P}_{d_1, \dots, d_k; n}$ that determines a seed in the cluster structure of the multi-homogeneous coordinate ring $\mathbb{k}[\mathcal{F}\ell_{d_1, \dots, d_k; n}]$ with respect to the Plücker embedding, compare to [GLS08, §9.3.2].

Algorithm 2: From pseudoline arrangement to quiver

- (1) **Vertices of $Q_{d_1, \dots, d_k; n}$:**
- (a) mutable vertices of $Q_{d_1, \dots, d_k; n}$ correspond to bounded faces of $\mathcal{P}_{d_1, \dots, d_k; n}$;
 - (b) there are two types of frozen vertices: $n-1$ of them correspond to the unbounded faces along the y -axis; additionally there are k frozen vertices, we denote them by v_{d_1}, \dots, v_{d_k} .
- (2) **Arrows of $Q_{d_1, \dots, d_k; n}$:** There are four types of arrows:
- (a) from left to right perpendicular to a vertical straight lines segment connecting adjacent faces of $\mathcal{P}_{d_1, \dots, d_k; n}$;
 - (b) from top to bottom perpendicular to a horizontal straight line segment connecting adjacent faces of $\mathcal{P}_{d_1, \dots, d_k; n}$;
 - (c) diagonally from bottom right to top left through a crossing of two straight line segments connecting faces of $\mathcal{P}_{d_1, \dots, d_k; n}$ that share a vertex;
 - (d) arrows to and from the extra frozen vertices v_{d_1}, \dots, v_{d_k} : there is an arrow from the face bounded by ℓ_{d_i-1}, ℓ_{d_i} vertically and by $\ell_{d_i+1}, \ell_{d_i+2}$ horizontally to the vertex v_{d_i} , and an arrow from v_{d_i} to the face bounded by ℓ_{d_i} on the left, by ℓ_{d_i+1} on the top and right (this is where ℓ_{d_i+1} bends) and by ℓ_{d_i+2} on the bottom.

The quiver $Q_{2,5;7}$ is depicted in Figure 1. The frozen vertices v_2, v_5 are labelled ω_2, ω_5 , respectively. Every face of the pseudoline arrangement $\mathcal{P}_{d_1, \dots, d_k; n}$ can be associated with a minor in $\mathbb{k}[U]$ [BFZ96]. The minors are of form $D_{I,J}$ with $I, J \subset [n]$ of the same size. In our case, the column index set J is always of form $\{n-|I|-1, \dots, n\}$. We associate index sets I_F to faces F of $\mathcal{P}_{d_1, \dots, d_k; n}$:

$$(2.6) \quad I_F := \{i : \ell_i \text{ passes north-east of } F\} \quad \text{and} \quad D_{I_F} := D_{I_F, \{n-|I_F|+1, \dots, n\}}.$$

2.4. Actions on $\mathbb{k}[U]$. [GLS08, §2.1] Recall that there is a left and right action of U on $\mathbb{k}[U]$ given by

$$(x \cdot f)(n) = f(nx) \quad \text{and} \quad (f \cdot x)(n) = f(xn), \quad \text{for all } f \in \mathbb{k}[U], x, n \in U.$$

Differentiating these actions we obtain a left and right action of \mathfrak{n} on $\mathbb{k}[U]$. Recall that \mathfrak{n} has a basis given by elementary matrices $E_{i,j}$ with $i < j$. Define the *Chevalley generators* $e_i := E_{i,i+1}$ for $1 \leq i \leq n-1$. Set $e_i^\dagger(f) := f \cdot e_i$. Given a minor $D_{I, \{n-d-1, \dots, n\}} =: D_I$ it is not hard to see that

$$(2.7) \quad \begin{aligned} e_i^\dagger(D_I) &= 0 & \text{if } i \notin I, \text{ or } i, i+1 \in I, \\ e_i^\dagger(D_I) &\neq 0 & \text{if } i \in I \not\equiv i+1. \end{aligned}$$

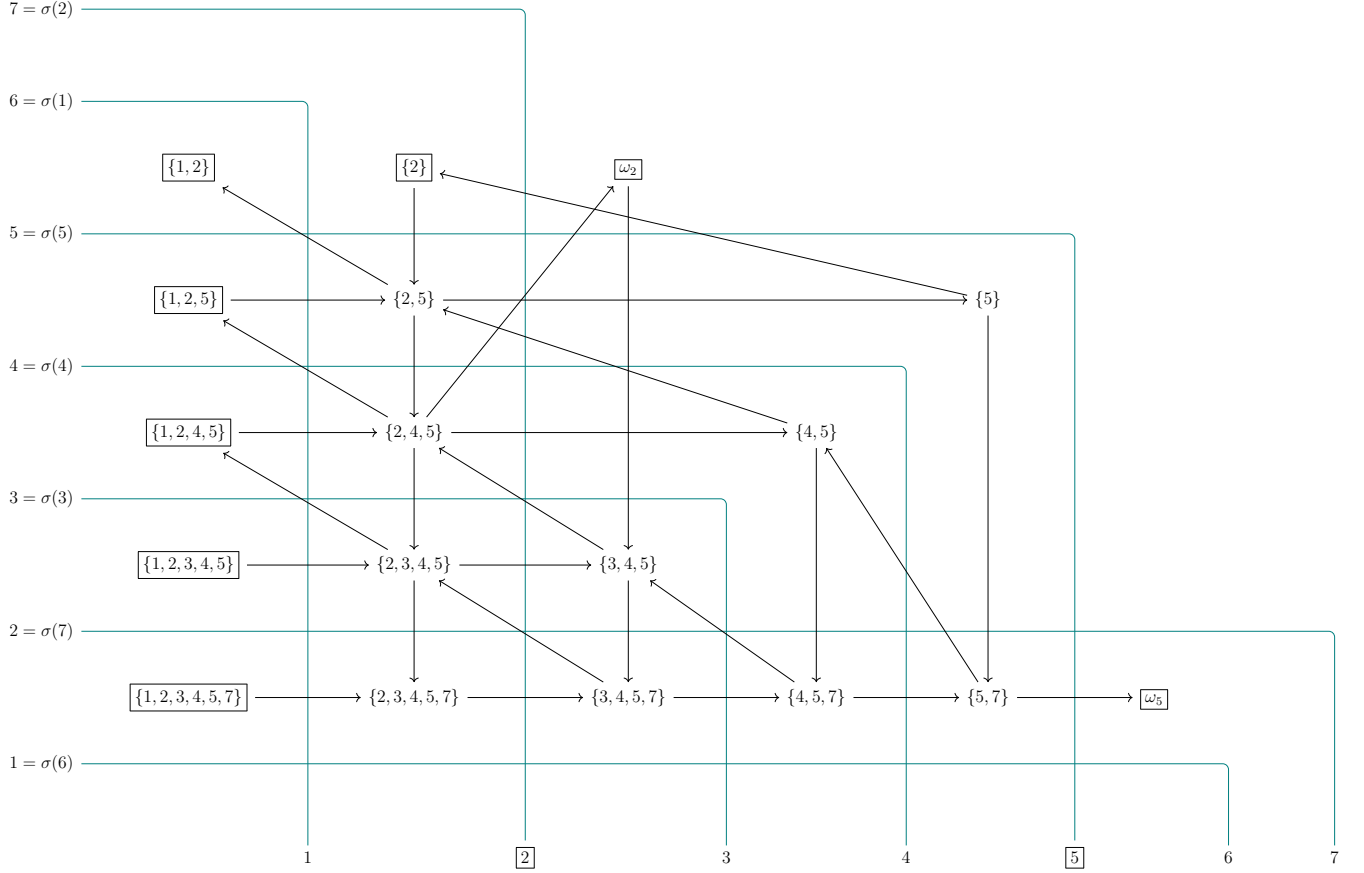

FIGURE 1. The pseudoline arrangement $\mathcal{P}_{2,5;7}$ and its quiver $Q_{2,5;7}$ together with the index sets I_F of the initial minors and the additional frozen vertices corresponding to $d_1 = 2, d_2 = 5$ labelled by their weights (as is §2.4), ω_2 respectively ω_5 .

Additionally we have $(e_i^\dagger)^2(D_I) = 0$ for all i and I . The coordinate ring $\mathbb{k}[U_{d_1, \dots, d_k; n}]$ can be identified with a subalgebra of $\mathbb{k}[U]$:

$$(2.8) \quad \mathbb{k}[U_{d_1, \dots, d_k; n}] \cong \{f \in \mathbb{k}[U] : e_j^\dagger(f) = 0 \forall j \notin \{d_1, \dots, d_k\}\}.$$

Hence, we also have an \mathfrak{n} -action on $\mathbb{k}[U_{d_1, \dots, d_k; n}]$.

The multi-homogeneous coordinate ring $\mathbb{k}[\mathcal{F}l_{d_1, \dots, d_k; n}]$ is multigraded by a submonoid of the weight lattice of the Cartan subalgebra of diagonal matrices $\mathfrak{h} \subset \mathfrak{sl}_n$. More precisely, let $\omega_1, \dots, \omega_{n-1}$ denote the fundamental weights. Then $\mathbb{k}[\mathcal{F}l_{d_1, \dots, d_k; n}]$ is graded by $\bigoplus_{i \in \{d_1, \dots, d_k\}} \mathbb{Z}_{\geq 0} \omega_i$. In [GLS08, Proof of Lemma 2.4] the authors construct a lift $\hat{f} \in \mathbb{k}[\mathcal{F}l_{d_1, \dots, d_k; n}]$ for every $f \in \mathbb{k}[U_{d_1, \dots, d_k; n}]$ uniquely determined by

- (1) $\iota^*(\hat{f}) = f$, where $\iota : U_{d_1, \dots, d_k; n} \hookrightarrow \mathcal{F}l_{d_1, \dots, d_k; n}$;
- (2) \hat{f} is homogeneous;
- (3) \hat{f} is of minimal degree with respect to (1) and (2).

As the degree of an element $\mathbb{k}[\mathcal{F}\ell_{d_1, \dots, d_k; n}]$ is a weight of \mathfrak{h} we use the term weight to refer to the degree. The weight of \hat{f} is

$$\lambda(\hat{f}) = \lambda(f) := \sum_{i \in \{d_1, \dots, d_k\}} a_i(f) \omega_i, \quad \text{where } a_i(f) := \max\{s : (e_i^\dagger)^s(f) \neq 0\}.$$

In particular, as $(e_i^\dagger)^2(D_I) = 0$ for all i and I we have

$$(2.9) \quad \lambda(D_I) = \sum_{i \in \{d_1, \dots, d_k\}, i \in I \neq i+1} \omega_i.$$

Therefore weights of minors D_{I_F} corresponding to faces $F \in \mathcal{P}_{d_1, \dots, d_k; n}$ are encoded in the pseudoline arrangement as follows:

Lemma 2.3. *Let F be a face of $\mathcal{P}_{d_1, \dots, d_k; n}$ and D_{I_F} the corresponding minor. Then $a_i(D_{I_F}) = 1$ if and only if the line ℓ_i passes north-east of F and the line ℓ_{i+1} passes south-west of F . In particular, $a_i(D_{I_F}) = 1$ if and only if F lies in between the horizontal segments of the pseudolines ℓ_{d_i} and $\ell_{d_{i+1}}$.*

Proof. Both claims follow directly from (2.9). In particular, the faces between between the horizontal segments of the pseudolines ℓ_{d_i} and $\ell_{d_{i+1}}$ are the only ones satisfying $d_i \in I_F$ and $d_i + 1 \notin I_F$. \square

Notice that the pseudolines ℓ_i and ℓ_{i+1} cross if and only if $i \in \{d_1, \dots, d_k\}$.

2.5. Cluster variables. We extend $Q_{d_1, \dots, d_k; n}$ to a seed for $\mathbb{k}[\mathcal{F}\ell_{d_1, \dots, d_k; n}]$ by associating cluster variables with its vertices. As $\mathbb{k}[\mathcal{F}\ell_{d_1, \dots, d_k; n}]$ is graded the main challenge is to verify that the mutation relations are homogeneous. For a vertex v_F corresponding to a face F of $\mathcal{P}_{d_1, \dots, d_k; n}$ the cluster variable is the lift \widehat{D}_{I_F} of the corresponding minor $D_{I_F} \in \mathbb{k}[U]$, which we describe explicitly in terms of Plücker coordinates subsequently in §3.6. To a frozen vertex v_{d_i} we associate the Plücker coordinate $P_{[d_i]}$, which is of weight ω_{d_i} in $\mathbb{k}[\mathcal{F}\ell_{d_1, \dots, d_k; n}]$. Denote the resulting cluster by $\mathbf{x}_{d_1, \dots, d_k; n}$.

Remark 2.4. For partial flag varieties without *gaps* in dimension, that is $\{d_1, \dots, d_k\} = [d_1, d_k]$, all lifts \widehat{D}_{I_F} are Plücker coordinates. In particular, the case of the full flag variety and the Grassmannian are included in this class. This is not the case for a general partial flag variety with *gaps*, the lifts may be homogeneous binomials in Plücker coordinates of degree two, see Proposition 3.4. It is worth noting that the initial seed for the Grassmannian obtained from its pseudoline arrangement coincides with the “standard” or “rectangle” initial seed.

Definition 2.5. A vertex v of $Q_{d_1, \dots, d_k; n}$ is called *balanced* if

$$\sum_{v_F \rightarrow v} \lambda(\widehat{D}_F) = \sum_{v \rightarrow v_{F'}} \lambda(\widehat{D}_{F'}).$$

The quiver $Q_{d_1, \dots, d_k; n}$ is called *balanced* if all of its mutable vertices are.

The following corollary is a consequence of Lemma 2.3.

Corollary 2.6. *Let $v \in Q_{d_1, \dots, d_k; n}$ be a mutable vertex. Then v is balanced.*

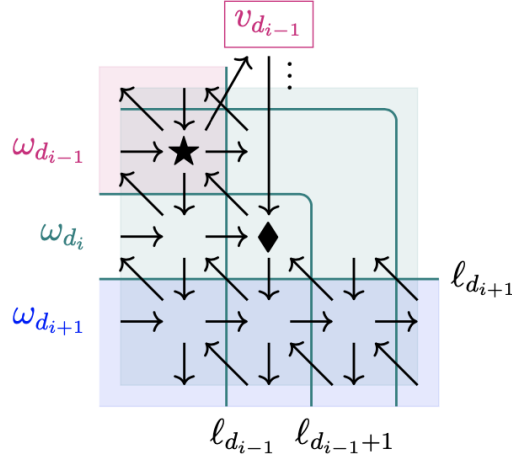

FIGURE 2. The shading of the regions indicates the weight of the associated minor. Notice that the vertices \star and \blacklozenge are non-balanced while all others are balanced.

Proof. Consider Figure 2. The top left shaded regions are of weight $\omega_{d_{i-1}}$, the bottom shaded region is of weight $\omega_{d_{i+1}}$ and all visible regions are of weight ω_{d_i} . From the picture one can see that all regions except the \star and \blacklozenge yield balanced vertices in $Q_{d_1, \dots, d_k; n}$. For the vertex \blacklozenge the weights of incoming arrows from faces of $\mathcal{P}_{d_1, \dots, d_k; n}$ sum to $2\omega_{d_i} + \omega_{d_{i+1}}$ and outgoing such arrows sum to $2\omega_{d_i} + \omega_{d_{i-1}} + \omega_{d_{i+1}}$; this imbalance is fixed by the incoming arrow to $v_{d_{i-1}}$ which is of weight $\omega_{d_{i-1}}$. For the vertex \star the incoming arrows from faces of $\mathcal{P}_{d_1, \dots, d_k; n}$ contribute $3\omega_{d_i} + 2\omega_{d_{i-1}}$ and outgoing such arrows $3\omega_{d_i} + \omega_{d_{i-1}}$; this imbalance is fixed by the outgoing arrow to $v_{d_{i-1}}$. \square

Proposition 2.7. *The seed $(Q_{d_1, \dots, d_k; n}, \mathbf{x}_{d_1, \dots, d_k; n})$ is an initial seed defining Geiss–Leclerc–Schröer’s cluster structure on $\mathbb{k}[\mathcal{F}\ell_{d_1, \dots, d_k; n}]$.*

Proof. By construction the pseudoline arrangement $\mathcal{P}_{d_1, \dots, d_k; n}$ corresponds to a reduced expression of $\sigma \in S_n$. Let Q' be the full subquiver of $Q_{d_1, \dots, d_k; n}$ on all vertices except v_{d_1}, \dots, v_{d_k} and let \mathbf{x}' be the set of minors D_{I_F} corresponding to vertices in Q' . Then by [GLS08, Proposition 9.4 and §10] (Q', \mathbf{x}') is an initial seed for $\mathbb{k}[U_{d_1, \dots, d_k; n}]$. An initial seed for $\mathbb{k}[\mathcal{F}\ell_{d_1, \dots, d_k; n}]$ can be obtained from (Q', \mathbf{x}') as follows:

- (1) extend Q' by add k frozen vertices and arrows following [GLS08, Theorem 10.2(iii)];
- (2) lift all elements of \mathbf{x}' and add the k Plücker coordinates $p_{[d_1]}, \dots, p_{[d_k]}$ for the new frozen vertices.

By definition the cluster $\mathbf{x}_{d_1, \dots, d_k; n}$ has the desired form and we only need to verify that the arrows adjacent to v_{d_1}, \dots, v_{d_k} agree with the ones in the reference. The number of arrows from v_{d_j} to a vertex v_F (eventually negative if there are only arrows from v_F to v_{d_j}) is obtained by the unique lift of $D_{I_F} \mu_F(D_{I_F}) = M_F + N_F$. According to [GLS08, Lemma 2.5, Equations (10.1)&(10.2)]

$$D_{I_F} \widehat{\mu_F}(D_{I_F}) = \widehat{D}_{I_F} \widehat{\mu_F}(D_{I_F}) = m_F \widehat{M}_F + n_F \widehat{N}_F,$$

where m_F, n_F are corprime monomials in $P_{[d_1]}, \dots, P_{[d_k]}$. By definition $m_F \widehat{M}_F + n_F \widehat{N}_F$ is homogeneous and of weight $\lambda(D_{I_F}) + \lambda(\mu_F(D_{I_F}))$. This uniquely determines m_F and n_F , which in turn define the missing arrows as follows:

- (1) identify a non-balanced mutable vertex v of Q' ;
- (2) compute the weights of all cluster variables corresponding to vertices adjacent to (and including) v ;
- (3) for $\sum_{v_F \rightarrow v} \lambda(D_F) = \sum_{i=1}^k a_i \omega_{d_i}$ and $\sum_{i=1}^k b_i \omega_{d_i} = \sum_{v \rightarrow v_{F'}} \lambda(D_{F'})$ add $\max\{0, b_i - a_i\}$ -many arrows $v \rightarrow v_{d_i}$ and $\max\{0, a_i - b_i\}$ -many arrows $v_{d_i} \rightarrow v$.

Then $m_F = \prod_{i=1}^k P_{[d_i]}^{\max\{0, a_i - b_i\}}$ and $n_F = \prod_{i=1}^k P_{[d_i]}^{\max\{0, b_i - a_i\}}$, see [GLS08, Equation (10.2)]. By Corollary 2.6 we only have to consider vertices of type \blacklozenge and \blackstar in Figure 2. In the proof of Corollary 2.6 we have computed the weights of minors for adjacent vertices. For $v = \blacklozenge$ in Step 3 we add one incoming arrow $v_{d_{i-1}} \rightarrow \blacklozenge$; for $v = \blackstar$ we add one outgoing arrow $\blackstar \rightarrow v_{d_{i-1}}$. The resulting quiver coincides with $Q_{d_1, \dots, d_k; n}$. \square

3. CLUSTER VARIABLES AS TABLEAUX

In this section we describe the initial cluster variables in more detail. We start by recalling some combinatorial notions. A *Young diagram* is an arrangement of boxes that are north-west bound, that is the number of boxes in each row, respectively column, is weakly decreasing from top to bottom, respectively left to right. A *semistandard Young tableau* is a filling of a Young diagram with positive integers that are weakly increasing in rows and strictly increasing in columns. As we are mainly interested in Young tableaux (as apposed to Young diagrams) we refrain from drawing the boxes, but rather just depict the filling, see Example 3.1.

3.1. Tableaux. For $k, m \in \mathbb{Z}_{\geq 1}$, denote by $\text{SSYT}_{\leq k; m}$ the set of all semistandard Young tableaux (including the empty tableau denoted by $\mathbb{1}$) with less or equal to k rows and with entries in $[m]$. To simplify language we frequently refer to semistandard Young tableaux simply as *tableaux*. For a tableau $T \in \text{SSYT}_{\leq k; m}$ with $k' \leq k$ many rows, we set the i th row to be empty for $i > k'$.

For $T, T' \in \text{SSYT}_{\leq k; m}$, we denote by $T \cup T'$ the row-increasing tableau whose i th row is the union of the i th rows of T and T' as multisets. The resulting tableau is semistandard [Li24, Lemma 3.2]. Therefore $\text{SSYT}_{\leq k; m}$ has the structure of a monoid with multiplication given by “ \cup ”.

Example 3.1. In $\text{SSYT}_{\leq 5; 6}$, we have that

$$\begin{array}{ccc} 1 & & 1 & 2 \\ 4 \cup & 2 & = & 3 & 4. \\ 6 & 3 & & 6 \end{array}$$

For $S, T \in \text{SSYT}_{\leq k; m}$, we say that S is a *factor* of T , denoted $S \subset T$, if for every $i \in [k]$, the i th row of S is contained in the i th row of T as multisets. For a factor S of T , we define $\frac{T}{S} = S^{-1}T = TS^{-1}$ as the row-increasing tableau whose elements in the i th row are the elements in the multiset-difference of i th row of T and the i th row of S for every $i \in [k]$.

We call a tableau $T \in \text{SSYT}_{\leq k; m}$ *trivial* if it is a one-column tableau with entries $\{1, \dots, p\}$ for some $p \in [k]$. For any $T \in \text{SSYT}_{\leq k; m}$, we denote by $T_{\text{red}} \subset T$ the *reduced* semistandard tableau obtained by from T by removing a maximal trivial factor.

For $S, T \in \text{SSYT}_{\leq k; m}$ we define an equivalence relation

$$S \sim T \text{ if and only if } S_{\text{red}} = T_{\text{red}}.$$

Note that if $T \sim T'$, then T and T' have the same number of rows. We denote by $\text{SSYT}_{\leq k; m, \sim}$ the set of \sim -equivalence classes in $\text{SSYT}_{\leq k; m}$. With a slight abuse of notation, we write $T \in \text{SSYT}_{\leq k; m, \sim}$ instead of $[T] \in \text{SSYT}_{\leq k; m, \sim}$.

Recall that we denote by $U \subset SL_n$ the subgroup of unipotent upper triangular matrices. The dual canonical basis of $\mathbb{k}[U]$ is parametrized by the set $\text{SSYT}_{\leq n-1; n, \sim}$ of equivalence classes of semistandard Young tableaux [Li24, Theorem 4.8]. For every $T \in \text{SSYT}_{\leq n-1; n, \sim}$ denote by $\text{ch}(T)$ the corresponding element in the dual canonical basis of $\mathbb{k}[U]$. The dual canonical basis for $\mathbb{k}[\mathcal{F}_{1, \dots, n-1; n}] = \mathbb{k}[U^- \setminus SL_n]$ is indexed by $\text{SSYT}_{\leq n-1; n}$ and it is obtained from the dual canonical basis of $\mathbb{k}[U]$ by lifting $\text{ch}(T) \in \mathbb{k}[U]$ along $\iota^* : \mathbb{k}[\mathcal{F}_{1, \dots, n-1; n}] \rightarrow \mathbb{k}[U]$ (as in [GLS08, Proof of Lemma 2.4] discussed in §2.4). Every homogeneous element in the fibre $(\iota^*)^{-1}(\text{ch}(T))$ obtained from the unique lift $\widehat{\text{ch}}(T)$ by multiplying with a monomial in $P_{[i]}$, $1 \leq i \leq n-1$ is a dual canonical basis element for $\mathbb{k}[\mathcal{F}_{1, \dots, n-1; n}]$. The indexing set in this case is $\text{SSYT}_{\leq n-1; n}$ as follows from the discussion in §3.3. By (2.8) $\mathbb{k}[U_{d_1, \dots, d_k; n}]$ is a subalgebra in $\mathbb{k}[U]$ so we refrain from treating this case separately, unless $k = 1$.

We denote by $\text{SSYT}_{k; n}$ (resp. $\text{SSYT}_{k; n, \sim}$) the subset of $\text{SSYT}_{\leq k; n}$ (resp. $\text{SSYT}_{\leq k; n, \sim}$) consisting of all semistandard Young tableaux of rectangular shapes with k rows. Denote by $\mathbb{k}[\text{Gr}_{k; n, \sim}]$ the quotient of $\mathbb{k}[\text{Gr}_{k; n}]$ by the inhomogeneous ideal $\langle P_{[i, i+k-1]} - 1 : 1 \leq i \leq n-k+1 \rangle$. The dual canonical basis of $\mathbb{k}[\text{Gr}_{k; n, \sim}]$ is parametrized by the set $\text{SSYT}_{k; n, \sim}$ of equivalence classes of semistandard Young tableaux, [CDFL20, Theorem 3.25]. The dual canonical basis of $\mathbb{k}[\text{Gr}_{k; n}]$ is parametrized by the set $\text{SSYT}_{k; n}$ of semistandard Young tableaux, [DGL24, Theorem 3.1].

3.2. Partial order on tableaux. There is a partial order on the set of semistandard Young tableaux that is induced from a partial order on partitions as follows [Bri05, Section 5.5].

Let $\lambda = (\lambda_1, \dots, \lambda_\ell)$, $\mu = (\mu_1, \dots, \mu_\ell)$, with $\lambda_1 \geq \dots \geq \lambda_\ell \geq 0$, $\mu_1 \geq \dots \geq \mu_\ell \geq 0$, be partitions. Then the *dominance order on partitions* is defined as

$$\lambda \leq \mu \quad \text{if and only if} \quad \sum_{j \leq i} \lambda_j \leq \sum_{j \leq i} \mu_j \text{ for all } 1 \leq i \leq \ell.$$

For $T \in \text{SSYT}_{\leq k; m}$ and $i \in [m]$, denote by $T[i]$ the sub-tableau obtained from T by restriction to the entries in $[i]$. For a tableau T , let $\text{sh}(T)$ denote the *shape of T* , that is a partition $(\lambda_1, \dots, \lambda_\ell)$ where $\ell \leq k$ is the number of rows of T and λ_i is the number of entries in the i^{th} row. If $T, T' \in \text{SSYT}_{\leq k; m}$ are of the same shape, Then the *dominance order on tableaux* is defined as

$$T \leq T' \quad \text{if and only if} \quad \text{sh}(T[i]) \leq \text{sh}(T'[i]) \quad \text{for all } 1 \leq i \leq m.$$

3.3. From tableaux to dual canonical basis elements in $\mathbb{k}[U]$. We recall how to obtain a dual canonical basis element $\widehat{\text{ch}}(T) \in \mathbb{k}[U]$ from a tableau $T \in \text{SSYT}_{\leq n-1; n, \sim}$, see [Li24, §5]. There is a natural bijection between one-column tableaux T and Plücker coordinates with index set given by the filling of T . Monomials in Plücker coordinates whose index sets form columns of a semistandard Young tableaux (up to reordering) are called *standard monomials*. For a tableau $T \in \text{SSYT}_{\leq k; n}$ we denote by $P_T = P_{T_1} \cdots P_{T_m}$ the standard monomial of T , where T_1, \dots, T_m are columns of T . We define a *fundamental tableau* as a one-column tableau $T_{(a, b)}$ with entries $\{1, 2, \dots, a-1, b\}$ for some $a \in [n-1]$ and $b \in [p+1, n]$.

For the rest of this subsection let us fix a tableau $T \in \text{SSYT}_{\leq n-1; n, \sim}$ and construct its associated element of the dual canonical basis. First take the unique tableau T' that satisfies

- (1) $T \sim T'$,
- (2) columns of T' are fundamental tableaux of form $T_{(a_i, b_i)}$ with $1 \leq i \leq m$, where m is number of columns of T' .

By definition, $a_1, \dots, a_m \in [n-1]$ and $b_1, \dots, b_m \in [n]$. We denote $\mathbf{p}_T := \{(a_i, b_i) : i \in [m]\}$ as a multi-set. Let $\mathbf{i}_T = (i_1, \dots, i_m)$, respectively $\mathbf{j}_T = (j_1, \dots, j_m)$, be such that

$$\begin{aligned} i_1 \leq \dots \leq i_m & \quad \text{and} \quad \{i_1, \dots, i_m\} = \{a_1, \dots, a_m\}, & \text{respectively} \\ j_1 \leq \dots \leq j_m & \quad \text{and} \quad \{j_1, \dots, j_m\} = \{b_1, \dots, b_m\}. \end{aligned}$$

For $\mathbf{c} = (c_1, \dots, c_m)$, $\mathbf{d} = (d_1, \dots, d_m) \in \mathbb{Z}^m$ we write $\mathbf{p}_{\mathbf{c}, \mathbf{d}} := \{(c_i, d_i) : i \in [m]\}$ as a multi-set. Let S_m be the symmetric group on $[m]$ and $\ell(w)$ the length of $w \in S_m$; denote by $w_0 \in S_m$ be the longest permutation. For any $T \in \text{SSYT}_{\leq n-1; n, \sim}$, there exists $w \in S_m$ such that $\mathbf{p}_T = \mathbf{p}_{w \cdot \mathbf{i}_T, \mathbf{j}_T}$, and let $w_T \in S_m$ be the unique permutation with maximal length such that $\mathbf{p}_T = \mathbf{p}_{w_T \cdot \mathbf{i}_T, \mathbf{j}_T}$, see [BKP⁺18, Proposition 2.7], [Bou02, §2.4-5] and [Kob11, Proposition 2.3].

Let $T, T' \in \text{SSYT}_{\leq n-1; n, \sim}$ be as above. For $u \in S_m$ we define a standard monomial $P_{u; T} \in \mathbb{k}[U]$ as follows. If $j_a \in [i_{u(a)}, i_{u(a)} + n]$ for all $a \in [m]$, define $\alpha(u; T)$ as the tableau with columns $T_{(i_{u(a)}, j_a)}$, $a \in [m]$, and define $P_{u; T} := P_{\alpha(u; T)} \in \mathbb{k}[U]$ as its standard monomial. If $j_a \notin [i_{u(a)}, i_{u(a)} + n]$ for some $a \in [m]$, then $\alpha(u; T)$ is undefined and $P_{u; T} := 0$.

Let $T, T' \in \text{SSYT}_{\leq n-1; n, \sim}$ be as above. Then by [Li24, Theorem 5.3]

$$(3.1) \quad \tilde{\text{ch}}(T) = \sum_{u \in S_m} (-1)^{\ell(uw_T)} p_{uw_0, w_T w_0}(1) P_{u; T'} \in \mathbb{k}[U],$$

where $p_{u,v}(q)$ is a Kazhdan-Lusztig polynomial [KL79]. The expression (3.1) is of the form $\tilde{\text{ch}}(T) = \sum_S c_S P_S$, where S 's are semistandard tableaux. The largest tableau in the expression is T' and $c_{T'} = 1$. After removing the trivial tableaux in T' , we obtain the tableau T back. Denote by T'' the unique trivial tableau such that $T' = T \cup T''$. The expression (3.1) can be simplified to

$$(3.2) \quad \text{ch}(T) = \frac{1}{P_{T''}} \tilde{\text{ch}}(T).$$

Since $P_{T''}$ is equal to 1 on $\mathbb{k}[U]$, $\text{ch}(T)$ and $\tilde{\text{ch}}(T)$ take the same value on $\mathbb{k}[U]$. The dual canonical basis for $\mathbb{k}[\mathcal{F}\ell_{1, \dots, n-1; n}] = \mathbb{k}[U^- \setminus SL_n]$ is obtained from the dual canonical basis of $\mathbb{k}[U]$ via the unique lifting (see Theorem 1.1 in [Kad23] and §2.4) and multiplying lifts with monomials in $P_{[d]}$ where $1 \leq d \leq n-1$. Notice that $P_{T''}$ above is such a monomial.

3.4. From tableaux to dual canonical basis elements in $\mathbb{k}[\text{Gr}_{k; n}]$. The map from tableaux to dual canonical basis elements in $\mathbb{k}[\text{Gr}_{k; n}]$ [CDFL20, §5] is similar to the case of $\mathbb{k}[U]$, but they differ in the notion of fundamental tableaux. A *fundamental tableau* in $\text{SSYT}_{k; n}$ is a one-column tableau whose entries are of the form $\{i, i+1, \dots, \hat{j}, \dots, i+k\}$, where $1 \leq i \leq n-k$, $i < j < i+k$, and \hat{j} means the number j is missing.

We recall the map from tableaux to dual canonical basis elements in $\mathbb{k}[\text{Gr}_{k; n}]$. Let $T \in \text{SSYT}_{k; n}$. Denote by T' the unique tableau whose columns are fundamental tableaux in $\text{SSYT}_{k; n}$ and $T \sim T'$. Let m denote the number of columns of T' . Let $\mathbf{i} = i_1 \leq i_2 \leq \dots \leq i_m$ be the entries in the first row of T' , and let r_1, \dots, r_m be the elements such that the a th column

of T' has content $[i_a, i_a + k] \setminus \{r_a\}$. Let $\mathbf{j} = j_1 \leq j_2 \leq \dots \leq j_m$ be the elements r_1, \dots, r_m written in weakly increasing order.

For $u \in S_m$, define $P_{u;T'} \in \mathbb{k}[\text{Gr}_{k;n}]$ as follows. Provided $j_a \in [i_{u(a)}, i_{u(a)} + k]$ for all $a \in [m]$, define $\alpha(u; T')$ as the tableau whose columns have entries $[i_{u(a)}, i_{u(a)} + k] \setminus \{j_a\}$ for $a \in [m]$. Then $P_{u;T'} := P_{\alpha(u;T')} \in \mathbb{k}[\text{Gr}_{k;n}]$ is the corresponding standard monomial. If $j_a \notin [i_{u(a)}, i_{u(a)} + k]$ for some a , then the tableau $\alpha(u; T')$ is undefined and $P_{u;T'} := 0$.

There is a unique $u \in S_m$ of maximal length with the property that the sets $\{[i_{u(a)}, i_{u(a)} + k] \setminus \{j_a\}\}_{a \in [m]}$ describe the columns of T' . This u is denoted by $u = w_T$. By [CDFL20, Theorem 5.8], the element $\tilde{\text{ch}}(T)$ in the dual canonical basis of $\mathbb{k}[\text{Gr}_{k;n,\sim}]$ is given by

$$(3.3) \quad \tilde{\text{ch}}(T) = \sum_{u \in S_m} (-1)^{\ell(uw_T)} p_{uw_0, w_T w_0}(1) P_{u;T'} \in \mathbb{k}[\text{Gr}_{k;n,\sim}],$$

where $p_{u,v}(q)$ is a Kazhdan-Lusztig polynomial [KL79]. The formula (3.3) is a change of basis from the standard monomial basis to the dual canonical basis. Define

$$(3.4) \quad \text{ch}(T) = \frac{1}{P_{T''}} \tilde{\text{ch}}(T)$$

where $T'' = T'T^{-1}$. The set $\{\text{ch}(T) : T \in \text{SSYT}_{k;n}\}$ is the dual canonical basis of $\mathbb{k}[\text{Gr}_{k;n}]$, see [DGL24, Theorem 3.1].

Remark 3.2. The concept of fundamental tableaux in this subsection is different from the concept of fundamental tableaux in §3.3. We expect that for a rectangular tableau $T \in \text{SSYT}_{k;n}$, after simplification, $\text{ch}(T)$ in (3.4) is equal to $\text{ch}(T)$ in (3.2), *c.f.* Question 1.5.

3.5. Mutation of cluster variables in terms of tableaux. Mutations of cluster variables in the cluster algebra $\mathbb{k}[U]$ can be described in terms of tableaux [Li24, §6]. Starting from an initial seed of $\mathbb{k}[U]$, each time we perform a mutation at a cluster variable $\text{ch}(T_r)$, we obtain a new cluster variable $\text{ch}(T'_r)$ determined by

$$(3.5) \quad \text{ch}(T'_r)\text{ch}(T_r) = \prod_{i \rightarrow r \text{ in } Q} \text{ch}(T_i) + \prod_{r \rightarrow j \text{ in } Q} \text{ch}(T_j),$$

where $\text{ch}(T_i)$ is the cluster variable at the vertex i . The two tableaux $\cup_{i \rightarrow r} T_i, \cup_{r \rightarrow j} T_j$ are comparable in the dominance order \leq and T'_r is determined by

$$(3.6) \quad T'_r = T_r^{-1} \max_{\leq} \{\cup_{i \rightarrow r} T_i, \cup_{r \rightarrow j} T_j\}.$$

As $\mathbb{k}[U_{d_1, \dots, d_k; n}]$ is a subalgebra of $\mathbb{k}[U]$, if all elements in (3.5) belong to $\mathbb{k}[U_{d_1, \dots, d_k; n}]$ then the equation is an exchange relation in $\mathbb{k}[U_{d_1, \dots, d_k; n}]$.

3.6. Tableaux for initial minors. First we describe the initial cluster variables for the cluster algebra $\mathbb{k}[\mathcal{F}\ell_{d_1, \dots, d_k; n}]$ explicitly in terms of Plücker coordinates. This will allow us to easily compute their image with respect to the algebra embedding (1.5) and also express them in terms of tableaux. To simplify notation we denote the lift of a minor D_I from now on by $\Delta_I := \widehat{D}_I$. All computations take place in $\mathbb{k}[\mathcal{F}\ell_{d_1, \dots, d_k; n}]$.

Lemma 3.3. *The index sets I_F associated with faces F of $\mathcal{P}_{d_1, \dots, d_k; n}$ are*

frozens (*faces unbounded to the left*): $\{d_1\}, [d_1 - 1, d_1], \dots, [d_1], [d_1] \cup \{d_2\}, [d_1] \cup [d_2 - 1, d_2], \dots, [d_2], [d_2] \cup \{d_3\}, \dots, [d_k], [d_k] \cup \{n\}, \dots, [n] \setminus d_k + 1$.

mutable (*bounded faces*):

- (1) for all $i > 1$ we have $d_i, [d_i - 1, d_i], \dots, [2, d_i]$ (notice that $[d_i]$ appears as frozen);

(2) for all $1 \leq i < j \leq k + 1$ we get

$$\begin{array}{ccccccc} [d_{i-1}+1, d_{j-1}] \cup \{d_j\}, & [d_{i-1}+2, d_{j-1}] \cup \{d_j\}, & \dots & [d_{i-1}, d_{j-1}] \cup \{d_j\} & [d_i, d_{j-1}] \cup \{d_j\}, \\ [d_{i-1}+1, d_{j-1}] \cup [d_j-1, d_j], & [d_{i-1}+2, d_{j-1}] \cup [d_j-1, d_j] & \dots & [d_{i-1}, d_{j-1}] \cup [d_j-1, d_j] & [d_i, d_{j-1}] \cup [d_j-1, d_j], \\ \vdots & & & & \\ [d_{i-1}+1, d_{j-1}] \cup [d_{j-1}+2, d_j], & [d_{i-1}+2, d_{j-1}] \cup [d_{j-1}+2, d_j], & \dots & [d_{i-1}, d_{j-1}] \cup [d_{j-1}+2, d_j], & [d_i, d_{j-1}] \cup [d_{j-1}+2, d_j]. \end{array}$$

In particular, the index sets of initial minors take the form of one or two intervals:

- (a) $[i_j, d_j]$ for $1 \leq j \leq k$ and $1 \leq i_j \leq d_j$, or
- (b) $[i_j, d_j] \cup [i_{j+1}, d_{j+1}]$ for $1 \leq i_j \leq d_j < i_{j+1} \leq d_{j+1} \leq n$ and $0 \leq j < k$

(by convention $d_{k+1} = n$ and $d_0 = 0$). In case (a) observe that for any columnset J of appropriate size satisfying $J \cap [1, i_j - 1] = \emptyset$ we have

$$(3.7) \quad \Delta_{[i_j, d_j]} = \Delta_{[i_j, d_j], J} = \Delta_{[1, d_j], [1, i_j - 1] \cup J} = P_{[1, i_j - 1] \cup J}.$$

This yields an expression of all cluster variables with index set of form (a) in terms of Plücker coordinates:

$$(3.8) \quad \Delta_{[i_j, d_j]} = P_{[1, i_j - 1] \cup [n - d_j + i_j, n]}$$

For index sets of type (b) we have the following Proposition:

Proposition 3.4. *Consider an arbitrary flag variety $\mathcal{F}_{d_1, \dots, d_k; n}$ and an arbitrary initial minor $\Delta_{[i_j, d_j] \cup [i_{j+1}, d_{j+1}]}$ with $1 \leq i_j \leq d_j < i_{j+1} \leq d_{j+1} \leq n$ and $0 \leq j < k$ (recall, that $d_0 := 0, d_{k+1} := n$). Set $\ell = n - d_j - d_{j+1} + i_j + i_{j+1} - 1$. Then*

$$(3.9) \quad \Delta_{[i_j, d_j] \cup [i_{j+1}, d_{j+1}]} = \sum_{J \in \binom{[\ell, n]}{d_j - i_j + 1}, J' = [\ell, n] \setminus J} (-1)^{\Sigma(i_j, d_j, J)} P_{[i_j - 1] \cup J} P_{[i_{j+1} - 1] \cup J'}$$

where $\Sigma(i_j, d_j, J) := \sum_{q=i_j}^{d_j} q + \sum_{j \in J} j$.

Proof. The minor $\Delta_{[i_j, d_j] \cup [i_{j+1}, d_{j+1}]}$ is the determinant of a matrix of size $n - \ell + 1 = d_j + d_{j+1} - i_j - i_{j+1} + 2$. To be precise

$$\Delta_{[i_j, d_j] \cup [i_{j+1}, d_{j+1}]} = \Delta_{[i_j, d_j] \cup [i_{j+1}, d_{j+1}], [\ell, n]}.$$

Observe that for any set $J \subset [\ell, n]$ of size $d_j - i_j + 1$ we have

$$\Delta_{[i_j, d_j], J} = \Delta_{[1, d_j], [1, i_j - 1] \cup J} = P_{[1, i_j - 1] \cup J}.$$

Equation (3.9) is a Laplace expansion:

$$\begin{aligned} \Delta_{[i_j, d_j] \cup [i_{j+1}, d_{j+1}], [\ell, n]} &\stackrel{\text{Laplace}}{=} \sum_{J \in \binom{[\ell, n]}{d_j - i_j + 1}, J' = [\ell, n] \setminus J} (-1)^{\Sigma(i_j, d_j, J)} \Delta_{[i_j, d_j], J} \Delta_{[i_{j+1}, d_{j+1}], J'} \\ &\stackrel{(3.8)}{=} \sum_{J \in \binom{[\ell, n]}{d_j - i_j + 1}, J' = [\ell, n] \setminus J} (-1)^{\Sigma(i_j, d_j, J)} P_{[i_j - 1] \cup J} P_{[i_{j+1} - 1] \cup J'} \end{aligned}$$

□

We can now deduce the tableaux corresponding to the initial cluster variables.

Corollary 3.5. *The tableau corresponding to the initial cluster variable $\Delta_{[i_j, d_j] \cup [i_{j+1}, d_{j+1}]} \in \mathbb{k}[\mathcal{F}l_{d_1, \dots, d_k; n}]$ in Proposition 3.4 is*

$$(3.10) \quad T_{\Delta_{[i_j, d_j] \cup [i_{j+1}, d_{j+1}]}} := \begin{array}{cc} & 1 \\ & \vdots \\ & \vdots \\ i_{j+1} - 1 & n - d_{j+1} - d_j + i_{j+1} + i_j - 1 \\ n - d_{j+1} + i_{j+1} & \vdots \\ \vdots & n - d_{j+1} + i_{j+1} - 1 \\ n & \end{array}$$

We call the tableaux of form $T_{\Delta_{[i_j, d_j] \cup [i_{j+1}, d_{j+1}]}}$ *initial tableaux*.

Proof. Notice that the two columns correspond to one of the monomials in the Plücker expression of $\Delta_{[i, d_i] \cup [i_{j+1}, d_{j+1}]}$ in (3.9). Moreover, $\Delta_{[i, d_i] \cup [i_{j+1}, d_{j+1}]}$ is an element of the dual canonical basis. Hence, by (3.1) it can be expressed as $P_T + \sum_{T' < T} c_{T'} P_{T'}$, where $P_{T'}$ are standard monomials. Note that in the right hand side of (3.9), each term $P_{[i_j-1] \cup J} P_{[i_{j+1}-1] \cup J'}$ is equal to $P_{T'}$, where the first column of T' has entries $[i_{j+1} - 1] \cup J'$ and the second column of T' has entries $[i_j - 1] \cup J$, and T' is semistandard. The tableau T corresponding to the dual canonical basis element is the largest tableau appearing in the expression (3.9). Further, the tableau $T_{\Delta_{[i_j, d_j] \cup [i_{j+1}, d_{j+1}]}}$ of the claim is indeed the largest with respect to the partial order defined in §3.2 as $T_{\Delta_{[i_j, d_j] \cup [i_{j+1}, d_{j+1}]}} = P_{[i_j-1] \cup J} P_{[i_{j+1}-1] \cup J'}$, where $J' = [n - d_{j+1} + i_{j+1}, n]$ is the largest possible value among all choices of J' . □

Now consider the embedding of algebras defined in Equation (1.5). Recall that Plücker coordinates P_I correspond to single column tableaux of length (*i.e.* number of rows) equal to the cardinality of the index set I . The embedding $\varphi^* : \mathbb{k}[\mathcal{F}l_{d_1, \dots, d_k; n}] \hookrightarrow \mathbb{k}[\text{Gr}_{d_k; N}]$ from (1.5) *fills up* the index set I until it is of size d_k . In particular, the image of an initial cluster variables $\Delta_{[i_j, d_j] \cup [i_{j+1}, d_{j+1}]}$ is determined by filling up the index sets of the Plücker coordinates of its Laplace expansion. From the proof of Corollary 3.5 we may therefore deduce the tableaux of $\varphi^*(\Delta_{[i_j, d_j] \cup [i_{j+1}, d_{j+1}]})$: it is precisely given by filling up the tableaux $T_{[i_j, d_j] \cup [i_{j+1}, d_{j+1}]}$, that is $\phi(T_{[i_j, d_j] \cup [i_{j+1}, d_{j+1}]})$ for ϕ defined in (1.6).

Corollary 3.6. *The tableau of the image $\varphi^*(\Delta_{[i_j, d_j] \cup [i_{j+1}, d_{j+1}]} \in \mathbb{k}[\text{Gr}_{d_k; N}]$ of an initial cluster variable $\Delta_{[i_j, d_j] \cup [i_{j+1}, d_{j+1}]} \in \mathbb{k}[\mathcal{F}\ell_{d_1, \dots, d_k; n}]$ is*

$$\begin{array}{ccc}
1 & & 1 \\
\vdots & & \vdots \\
\vdots & & i_j - 1 \\
i_{j+1} - 1 & & n - d_{j+1} - d_j + i_{j+1} + i_j - 1 \\
n - d_{j+1} + i_{j+1} & & \vdots \\
\vdots & & n - d_{j+1} + i_{j+1} - 1 \\
\vdots & & n + 1 \\
n & & \vdots \\
n + 1 & & \vdots \\
\vdots & & \vdots \\
n + d_k - d_{i_{j+1}} & & n + d_k - d_{i_j}
\end{array} = \phi(T_{\Delta_{[i_j, d_j] \cup [i_{j+1}, d_{j+1}]}}).$$

As mentioned in the introduction, by exhibiting explicit mutation sequences in §4 we show that the images with respect to φ^* of the initial minors for $\mathcal{F}\ell_{d_1, \dots, d_k; n}$ are cluster variables in $\mathbb{k}[\text{Gr}_{d_k; N}]$. From this we deduce the proof of Corollary 1.4 stated in the introduction:

Proof of Corollary 1.4. Let $[i_j, d_j] \cup [i_{j+1}, d_{j+1}]$ be the index set of an initial minor in the respective cases according to Lemma 3.3 with associated tableau $T_{\Delta_{[i_j, d_j] \cup [i_{j+1}, d_{j+1}]}}$ as in Corollary 3.5. Corollary 3.6 shows that $\phi(T_{\Delta_{[i_j, d_j] \cup [i_{j+1}, d_{j+1}]}})$ is the tableau of $\varphi^*(\text{ch}(T_{\Delta_{[i_j, d_j] \cup [i_{j+1}, d_{j+1}]}}))$. Moreover, we know from §4 that $\varphi^*(\text{ch}(T_{\Delta_{[i_j, d_j] \cup [i_{j+1}, d_{j+1}]}}))$ is a cluster variables and hence an element of the dual canonical basis for $\mathbb{k}[\text{Gr}_{d_k; N}]$. Its expression in terms of Plücker coordinates is obtained by applying φ^* to (3.9).

Observe that φ^* maps standard monomials in Plücker coordinates in $\mathbb{k}[\mathcal{F}\ell_{d_1, \dots, d_k; n}]$ to standard monomials in Plücker coordinates in $\mathbb{k}[\text{Gr}_{d_k; N}]$. This happens precisely because it amounts to applying the map of semistandard Young tableaux ϕ to the tableaux associated with a standard monomial. Every dual canonical basis element admits a unique expression in the basis of standard monomials which is its character. Hence, the obtained expression is $\text{ch}(\phi(T_{\Delta_{[i_j, d_j] \cup [i_{j+1}, d_{j+1}]}}))$. \square

As stated in the introduction, it would be interesting to see if φ^* more generally maps the character of a tableau $T \in \text{SSYT}_{d_1, \dots, d_k; n}$ to the character of its image the tableau $\phi(T) \in \text{SSYT}_{d_k; N}$, *i.e.* if Question 1.5 has an affirmative answer.

3.7. Examples. We exhibit the results of the previous subsection in some examples.

Example 3.7. In the case of $\mathcal{F}\ell_{2,4,5}$, there are two cluster variables, one mutable one frozen, with two-column tableaux. More precisely we have

$$\text{ch} \left(\begin{array}{cc} 1 & 3 \\ 2 & 4 \\ 3 & 5 \end{array} \right) = P_{1235}P_{34} - P_{1234}P_{35}, \quad \text{and} \quad \text{ch} \left(\begin{array}{cc} 1 & 1 \\ 2 & 4 \\ 3 & 5 \end{array} \right) = P_{1235}P_{14} - P_{1234}P_{15}.$$

The initial seed is shown in Figure 3 on the left.

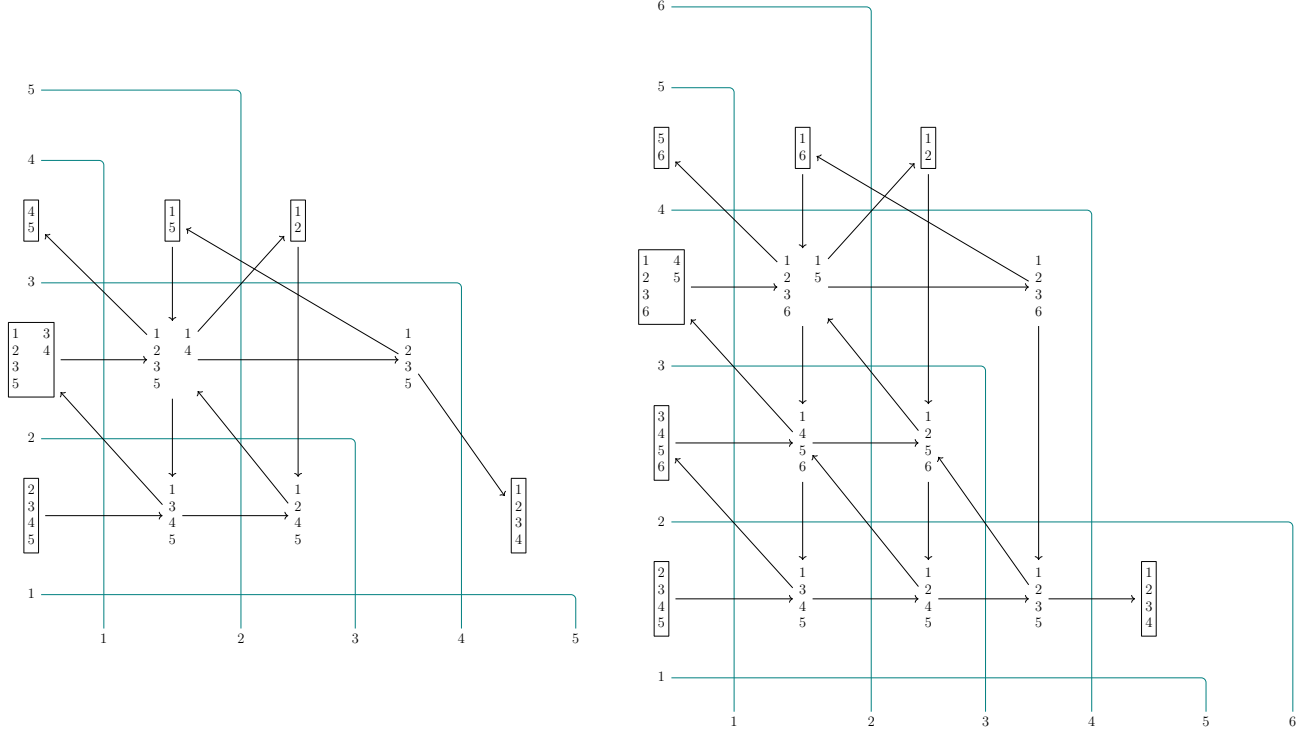

FIGURE 3. The initial seeds for the partial flag varieties $\mathcal{F}_{2,4;5}$ (on the left) and $\mathcal{F}_{2,4;6}$ (on the right).

Example 3.8. In the case of $\mathcal{F}_{2,4;6}$, there are two cluster variables, one mutable one frozen, with two-column tableaux. More precisely we have

$$\text{ch} \begin{pmatrix} 1 & 4 \\ 2 & 5 \\ 3 & 6 \end{pmatrix} = P_{1234}P_{56} - P_{1235}P_{46} + P_{1236}P_{45}, \quad \text{and} \quad \text{ch} \begin{pmatrix} 1 & 1 \\ 2 & 5 \\ 3 & 6 \end{pmatrix} = P_{1236}P_{15} - P_{1235}P_{16}.$$

The initial seed is shown in Figure 3 on the right.

Example 3.9. In Figure 4 we display the initial seed for $\mathcal{F}_{2,5;7}$ in terms of tableaux instead of initial minors for direct comparison with Figure 1 above.

4. MUTATION SEQUENCES FROM GRASSMANNIANS TO PARTIAL FLAG VARIETIES

In this section, we prove Theorem 1.1: we construct a mutation sequence starting from an initial seed of Grassmannian cluster algebra, which produce an initial seed for a partial flag variety after we freeze some cluster variables and delete some cluster variables. We provide a mutation sequence from the initial seed for $\text{Gr}_{d_k;N}$ to a seed s' with the properties

- (1) the images under the algebra embedding (1.5) of the initial cluster variables for $\mathcal{F}_{d_1, \dots, d_k; n}$ are cluster variables in s' ;
- (2) the initial quiver for $\mathcal{F}_{d_1, \dots, d_k; n}$ is a full subquiver of the quiver of s' , after freezing.

4.1. Restricted seeds. Before proceeding we recall the notion of *restricted seed* from [FWZ17, §4.2].

Definition 4.1. [FWZ17, Definition 4.2.3] Let $(Q, (x_i : i \in Q_0))$ be a seed, and let $I \cup J$ be a partition of the vertex set Q_0 of Q such that there are no arrows between mutable vertices

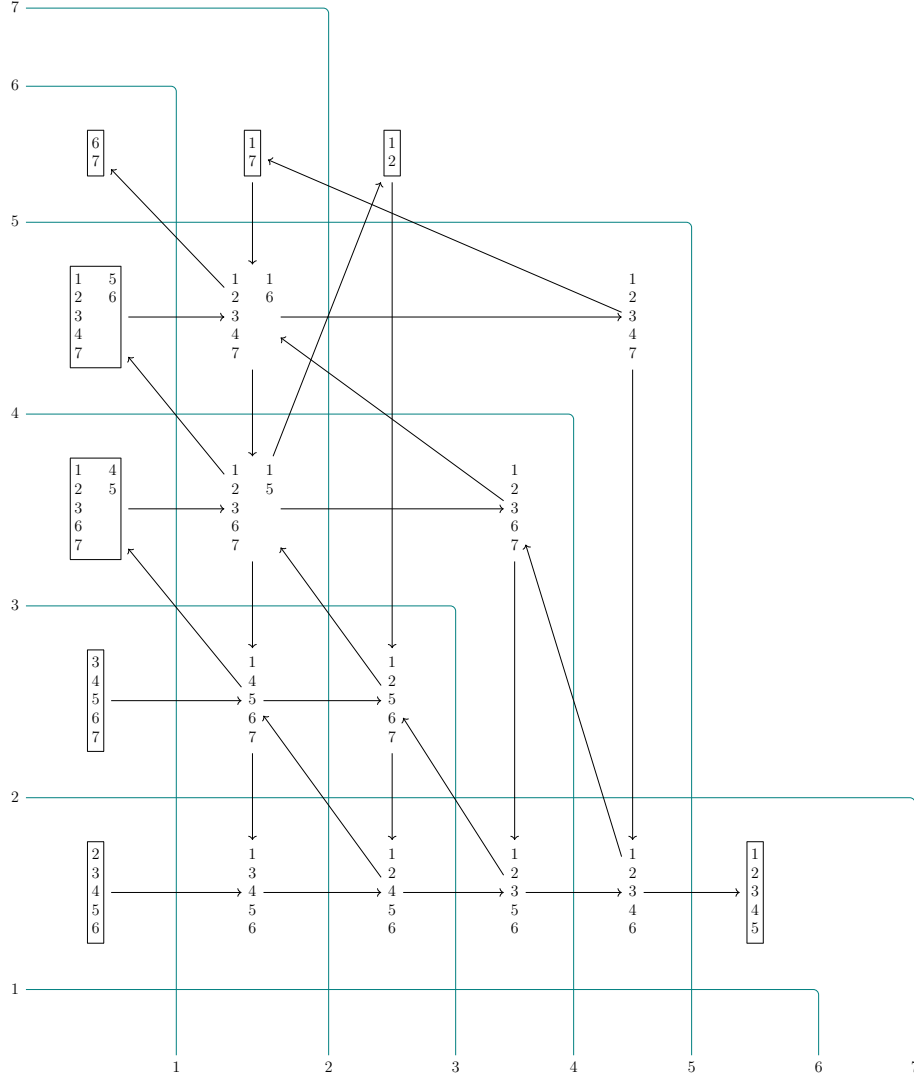

FIGURE 4. The initial seed for the partial flag variety $\mathcal{F}_{2,5,7}$.

in I and vertices in J . Let Q' be the quiver obtained from Q by deleting all vertices in J (i.e. the vertex set of Q' is I). Then the seed $(Q', (x_i : i \in I))$ is called a **restricted seed** of $(Q, (x_i : i \in Q_0))$.

By [FWZ17, Lemmata 4.2.2 and 4.2.5] passing to a restricted seed commutes with mutation and there yields a *seed subpattern* and induces a *cluster subalgebra* (see [FWZ17, Definition 4.2.6]).

Recall the initial seed for a partial flag variety $(Q_{d_1, \dots, d_k; n}, \mathbf{x}_{d_1, \dots, d_k; n})$. Denote by $\varphi^*(\mathbf{x}_{d_1, \dots, d_k; n})$ the tuple of images of cluster variables under the ring homomorphism φ^* defined in (1.5). In this section we exhibit an explicit mutation sequence from the initial seed of the Grassmannian $\text{Gr}_{d_k; N}$ to a seed which contains $(Q_{d_1, \dots, d_k; n}, \varphi^*(\mathbf{x}_{d_1, \dots, d_k; n}))$ as a restricted seed.

Recall the initial seed for $\mathbb{k}[\text{Gr}_{k; n}]$ as constructed in §2, it is shown in Figure 5.

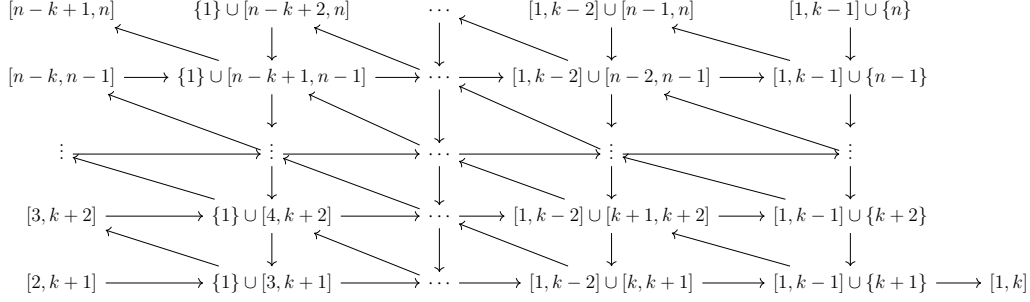

FIGURE 5. The initial seed for $\mathbb{C}[\text{Gr}_{k;n}]$ we used.

4.2. Mutation sequence for two-step partial flag varieties. We start by describing the case of two-step partial flag varieties which serves as a building block for the general case. The mutations for the case of two-step partial flag varieties $\mathcal{F}l_{d_1, d_2; n}$ is to perform a mutation sequence in the $(d_2 - d_1 - 1) \times (d_2 - 2)$ rectangle with left corner in the second row and second column in the initial seed. The region where the cluster variables in partial flag variety appears is a rectangle of size $(d_2 - d_1 - 1) \times d_1$ with left corner in the second row and second column.

Denote $a = d_2 - d_1 - 1$, $b = d_2 - 2$, $c = d_1$. We denote the coordinates of the region of the $(d_2 - d_1 - 1) \times (d_2 - 2)$ rectangle with left corner in the second row and second column by (i, j) , $i \in [a]$, $j \in [b]$, where the left upper corner has coordinate $(a, 1)$, the right upper corner has coordinate (a, b) , the left lower corner has coordinate $(1, 1)$, the lower right corner has coordinate $(1, b)$, see Figure 6. The mutation sequence is similar to a maximal green sequence for the Grassmannian [MS16, §11] and we use similar notation: a *page* in the sequence refers to a subsequence of consecutive mutations so that each vertex in the mutation grid is mutated at most once. The mutation sequence is as follows.

- The first page consists of the following mutations

$$\begin{aligned}
 & (a, 1), (a, 2), \dots, (a, b), \\
 & (a - 1, 1), (a - 1, 2), \dots, (a - 1, b), \\
 & \vdots \\
 & (2, 1), (2, 2), \dots, (2, b), \\
 & (1, 1), (1, 2), \dots, (1, c).
 \end{aligned}$$

After performing these mutations the cluster variable with tableaux

1	$d_1 + 2$
\vdots	\vdots
$d_1 + 1$	$2d_1 + 1$
$n - d_2 + d_1 + 2$	
\vdots	
n	

appears in position $(1, c)$.

- The first page consists of the following mutations

$$\begin{aligned}
&(a, 1), (a, 2), \dots, (a, b), \\
&(a-1, 1), (a-1, 2), \dots, (a-1, b), \\
&\vdots \\
&(3, 1), (3, 2), \dots, (3, b), \\
&(2, 1), (2, 2), \dots, (2, c), \\
&(1, 1), (1, 2), \dots, (1, c-1).
\end{aligned}$$

The two cluster variables

$$\begin{array}{cccc}
& 1 & d_1 + 3 & 1 & 1 \\
& \vdots & \vdots & \vdots & \vdots \\
& d_1 + 2 & 2d_1 + 2 & d_1 + 1 & 2d_1 + 1 \\
\text{and} & n - d_2 + d_1 + 3 & & n - d_2 + d_1 + 2 & \\
& \vdots & & \vdots & \\
& n & & n &
\end{array}$$

appear in positions $(2, c)$ and $(1, c-1)$ respectively.

- Continue this procedure, that is, the i th ($i \in [1, a+c-1]$) page consists of mutations at

$$\begin{aligned}
&(a, 1), (a, 2), \dots, (a, b), \\
&(a-1, 1), (a-1, 2), \dots, (a-1, b), \\
&\vdots \\
&(i+1, 1), (i+1, 2), \dots, (i+1, b), \\
&(i, 1), (i, 2), \dots, (i, c), \\
&(i-1, 1), (i-1, 2), \dots, (i-1, c-1), \\
&\vdots \\
&(1, 1), (1, 2), \dots, (1, c-i+1),
\end{aligned}$$

where the last few lines can be empty if $i > c$. Subsequently the cluster variables

$$\begin{array}{cc}
1 & 1 \\
\vdots & \vdots \\
\vdots & j_2 \\
d_1 + j_1 + 1 & d_1 + j_1 + j_2 + 2 \\
n - d_2 + d_1 + j_1 + 2 & \vdots \\
\vdots & 2d_1 + j_1 + 1 \\
n &
\end{array}$$

appear in positions $(j_1+1, c-j_2)$, $j_1+j_2 = i-1$, $j_1, j_2 \in \mathbb{Z}_{\geq 0}$, $j_2 \leq c-1$, $i \in [1, a+c-1]$, respectively.

By direct counting, we have the following.

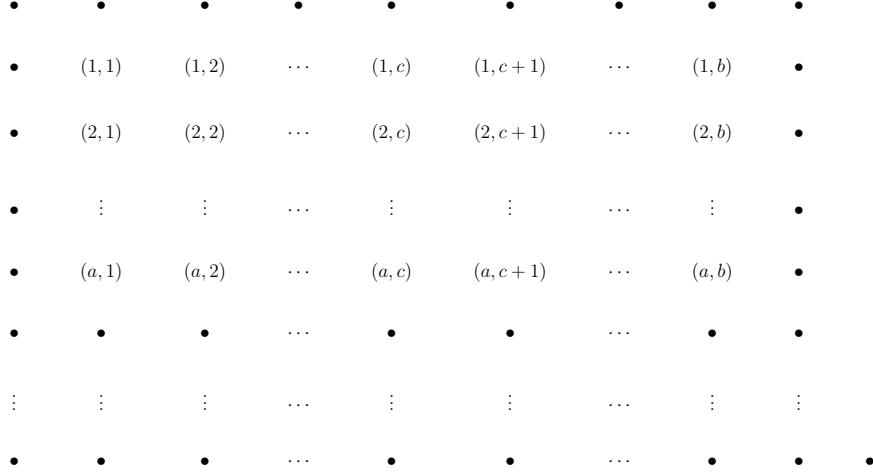

FIGURE 6. The mutation region for a two-step partial flag variety, where bullets have other cluster variables and frozen variables in the initial seed which we do not mutate.

Lemma 4.2. *The number of mutations to obtain the initial seed for $\mathbb{C}[\mathcal{F}l_{d_1, d_2; n}]$ starting from the initial seed for $\mathbb{C}[\text{Gr}_{d_2; n+d_2-d_1}]$ is $\frac{ac(c+1)}{2} + \frac{ab(a-1)}{2}$, where $a = d_2 - d_1 - 1$, $b = d_2 - 2$, $c = d_1$.*

Proof. The number is equal to

$$\begin{aligned} & a^2c + ac(c-a) - \frac{(a-1)a(c-a)}{2} - \frac{(c-a+1)(c-a)a}{2} + \frac{a(a-1)(b-c)}{2} \\ &= \frac{ac(c+1)}{2} + \frac{ab(a-1)}{2}. \end{aligned}$$

□

4.3. General partial flag varieties. We describe the mutation sequence for $\mathcal{F}l_{d_1, \dots, d_k; n}$. In each region: $(d_j - d_{j-1} - 1) \times (d_k - 2)$ rectangle with left upper corner at the $(d_{j-1} - d_1 + 2)$ nd row, the second column in the initial seed, $j \in [2, k]$, perform the same mutation sequence as in the two-step partial flag varieties in Section 4.2. The new cluster variables which belong to the partial flag variety appears at rectangles $(d_j - d_{j-1} - 1) \times d_{j-1}$, with the left upper corner at the $(d_{j-1} - d_1 + 2)$ th row, the second column in the initial seed, $j \in [2, k]$.

Denote the seed obtained as s' with quiver Q' . The above exposition shows

Lemma 4.3. *The images of the initial cluster variables for $\mathcal{F}l_{d_1, \dots, d_k; n}$ are contained in the set of cluster variables of s' .*

The final quiver. Recall that the desired tableaux are sitting at the vertices of each grid of size $(d_j - d_{j-1} - 1) \times d_{j-1}$ with left corner at the $(d_{j-1} - d_1 + 2)$ th row and second column. We freeze the cluster variables at positions $(i, d_{j-1} + 1)$ in Q' , $i \in [d_{j-1} - d_1 + 2, d_j - d_1]$, $j \in [2, k]$. Moreover, we freeze the cluster variables

$$P_{[1, d_j] \cup [n+1, n+d_k-d_j]}, \quad j \in [1, k-1].$$

They correspond to frozen variables $P_{[1, d_j]}$ for $\mathcal{F}l_{d_1, \dots, d_k; n}$. The obtained quiver splits into two mutable subquivers that are connected only through the newly frozen vertices, see for

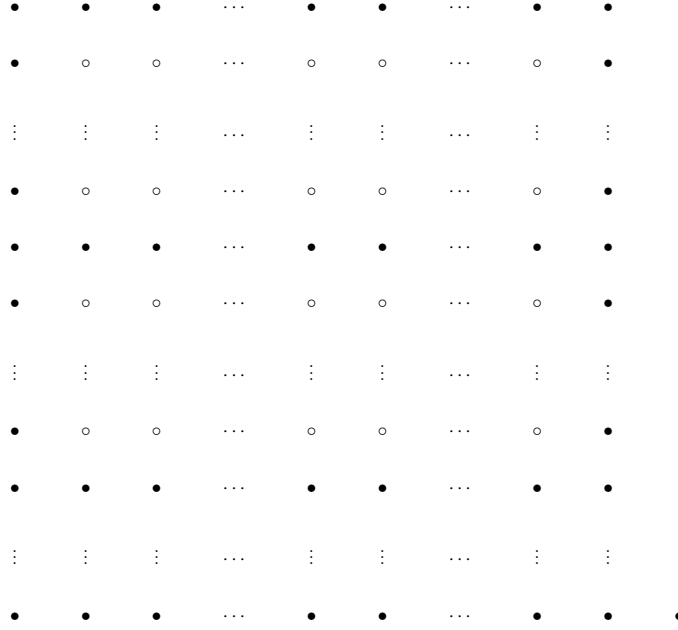

FIGURE 7. The mutation region for a general partial flag variety, where the rectangular regions of circles are the places we perform the mutations, and bullets have other cluster variables and frozen variables in the initial seed which we do not mutate.

example, Figure 9, where we have rotated the grid with positions 39, 47, 55, 63 and the grid with positions 20, 21, 28, 29, 36, 37, 44, 45, 52, 53, 60, 61, by 180° around their centers.

Lemma 4.4. *The seed $(Q_{d_1, \dots, d_k; n}, \varphi^*(\mathbf{x}_{d_1, \dots, d_k; n}))$ is a restricted seed of s' . In particular, φ^* is an embedding of algebras.*

Proof. After freezing the additional vertices the quiver Q' splits into two mutable subquivers: one is of the same type as $\mathcal{F}l_{d_1, \dots, d_k; n}$ (including frozen). The two subquivers are connected only through the newly frozen vertices.

By Lemma 4.3 the images of initial cluster variables in $\mathcal{F}l_{d_1, \dots, d_k; n}$ are contained in the seed s' . Hence, by [FWZ17, §4.2] the cluster algebra generated by the restricted seed is a subalgebra in $\mathbb{k}[\text{Gr}_{d_k; N}]$. \square

4.4. Example: $\mathcal{F}l_{4,6,9;12}$. In this subsection, we describe the mutation sequence from the initial seed of $\text{Gr}_{9;17}$ to the initial seed of $\mathcal{F}l_{4,6,9;12}$ explicitly. Computations of mutations can be found in: <https://github.com/lijr07/Grassmannian-cluster-algebra-and-pathial-flag-varieties>.

In this case, we have two mutation regions. We use $t_{(i,j)}$ (resp. $s_{(i,j)}$) to denote the positions of the vertices of the first (resp. second) mutation region.

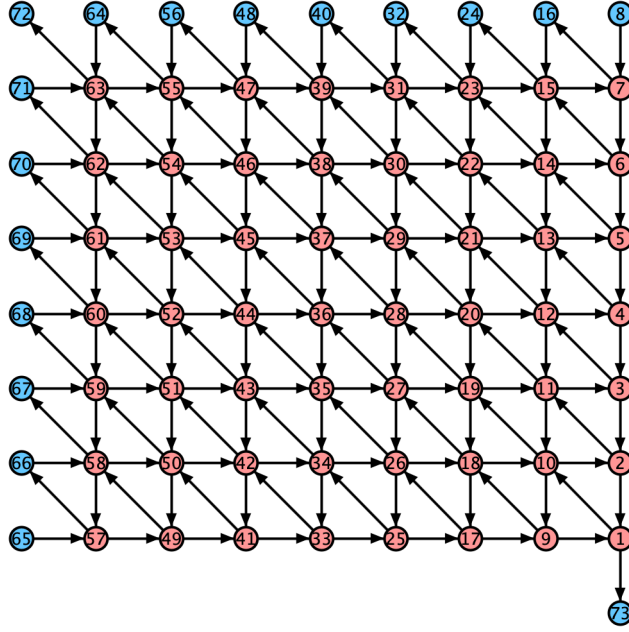

FIGURE 8. The initial seed of $\text{Gr}_{9,17}$ with labels.

The initial seed for $\text{Gr}_{9,17}$ we choose is shown in Figure 10. We label the vertices where we will perform mutations by $t_{(i,j)}$ and $s_{(i,j)}$. The mutation sequence is

$$\begin{aligned}
& t_{(1,1)}, t_{(1,2)}, t_{(1,3)}, t_{(1,4)}, \quad t_{(1,1)}, t_{(1,2)}, t_{(1,3)}, \quad t_{(1,1)}, t_{(1,2)}, \quad t_{(1,1)}, \\
& s_{(2,1)}, s_{(2,2)}, \dots, s_{(2,7)}, \quad s_{(1,1)}, s_{(1,2)}, \dots, s_{(1,6)}, \quad s_{(2,1)}, s_{(2,2)}, \dots, s_{(2,6)}, \quad s_{(1,1)}, s_{(1,2)}, \dots, s_{(1,5)}, \\
& s_{(2,1)}, s_{(2,2)}, \dots, s_{(2,5)}, \quad s_{(1,1)}, s_{(1,2)}, \dots, s_{(1,4)}, \quad s_{(2,1)}, s_{(2,2)}, s_{(2,3)}, s_{(2,4)}, \quad s_{(1,1)}, s_{(1,2)}, s_{(1,3)}, \\
& s_{(2,1)}, s_{(2,2)}, s_{(2,3)}, \quad s_{(1,1)}, s_{(1,2)}, \quad s_{(2,1)}, s_{(2,2)}, \quad s_{(1,1)}, \quad s_{(2,1)}.
\end{aligned}$$

After mutations, we freeze the cluster variables at positions $t_{(1,4)}, \dots, t_{(1,8)}, s_{(1,6)}, s_{(1,7)}, s_{(1,8)}, s_{(2,6)}, s_{(2,7)}, s_{(2,8)}$. We also freeze $[1, 6] \cup [13, 15]$ (the cluster variable $P_{[1,6] \cup [13,15]}$). Then we obtain the initial seed for $\mathcal{F}\ell_{4,6,9;12}$ in Figure 11 after removing all irrelevant frozen variables.

To see the initial seed of $\mathcal{F}\ell_{4,6,9;12}$ as a restricted seed of a seed for $\text{Gr}_{9,17}$, we label the initial seed of $\text{Gr}_{9,17}$ as shown in Figure 8. After performing the above mutations and freezing cluster variables, we obtain the seed in Figure 9. We see that the initial seed of $\mathcal{F}\ell_{4,6,9;12}$ is a restricted seed for the seed of $\text{Gr}_{9,17}$ in Figure 8.

5. APPLICATION: CLUSTER STRUCTURES ON \mathcal{MT}_n AND \mathcal{SH}_n FROM GRASSMANNIANS

In this section, as special cases of general partial flag varieties in §4, we focus on $\mathcal{F}\ell_{2,4;n}$, respectively $\mathcal{F}\ell_{2,n-2;n}$, which are of particular interest for the momentum twistor variety \mathcal{MT}_n , respectively for the spinor helicity variety \mathcal{SH}_n . We exhibit an explicit mutation sequence from the initial seed of the Grassmannian $\text{Gr}_{4;n+2}$, respectively $\text{Gr}_{n-2;2n-4}$, to a seed which contains $(Q_{2,4;n}, \varphi^*(\mathbf{x}_{2,4;n}))$, respectively $(Q_{2,n-2;n}, \varphi^*(\mathbf{x}_{2,n-2;n}))$, as a restricted seed.

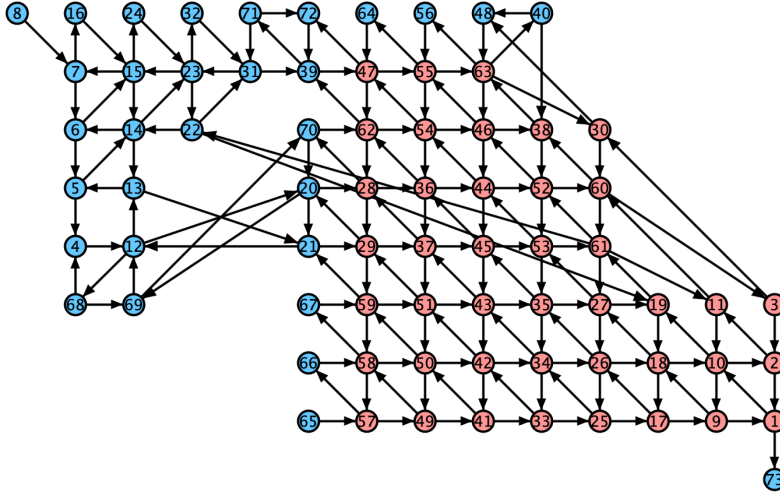

FIGURE 9. The seed of $\text{Gr}_{9;17}$ with labels after performing the mutation sequence in §4.4.

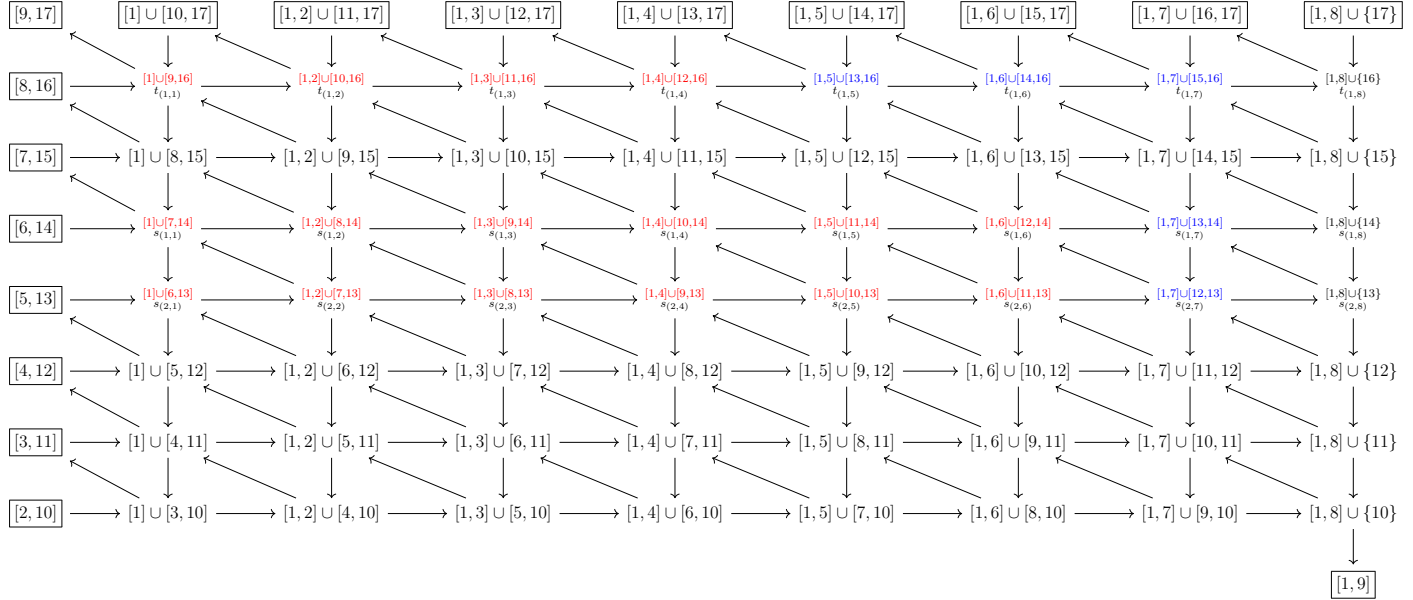

FIGURE 10. The initial seed for $\mathbb{k}[\text{Gr}_{9;17}]$.

5.1. Momentum twistor varieties. The initial seeds for $\mathcal{F}\ell_{2,4;n}$ and $\text{Gr}_{4;n+2}$ are depicted in Figure 12. Notice that out of the $4n - 7$ initial cluster variables of $\text{Gr}_{4;n+2}$ all but five coincide with (images of) initial cluster variables of $\mathcal{F}\ell_{2,4;n}$. Hence, we only need to recover the two missing initial cluster variables, respectively their images under (1.5):

$$\begin{array}{|c|} \hline 1 & n-2 \\ 2 & n-1 \\ 3 & n+1 \\ n & n+2 \\ \hline \end{array} \quad \text{and} \quad \begin{array}{|c|} \hline 1 & 1 \\ 2 & n-1 \\ 3 & n+1 \\ n & n+2 \\ \hline \end{array}.$$

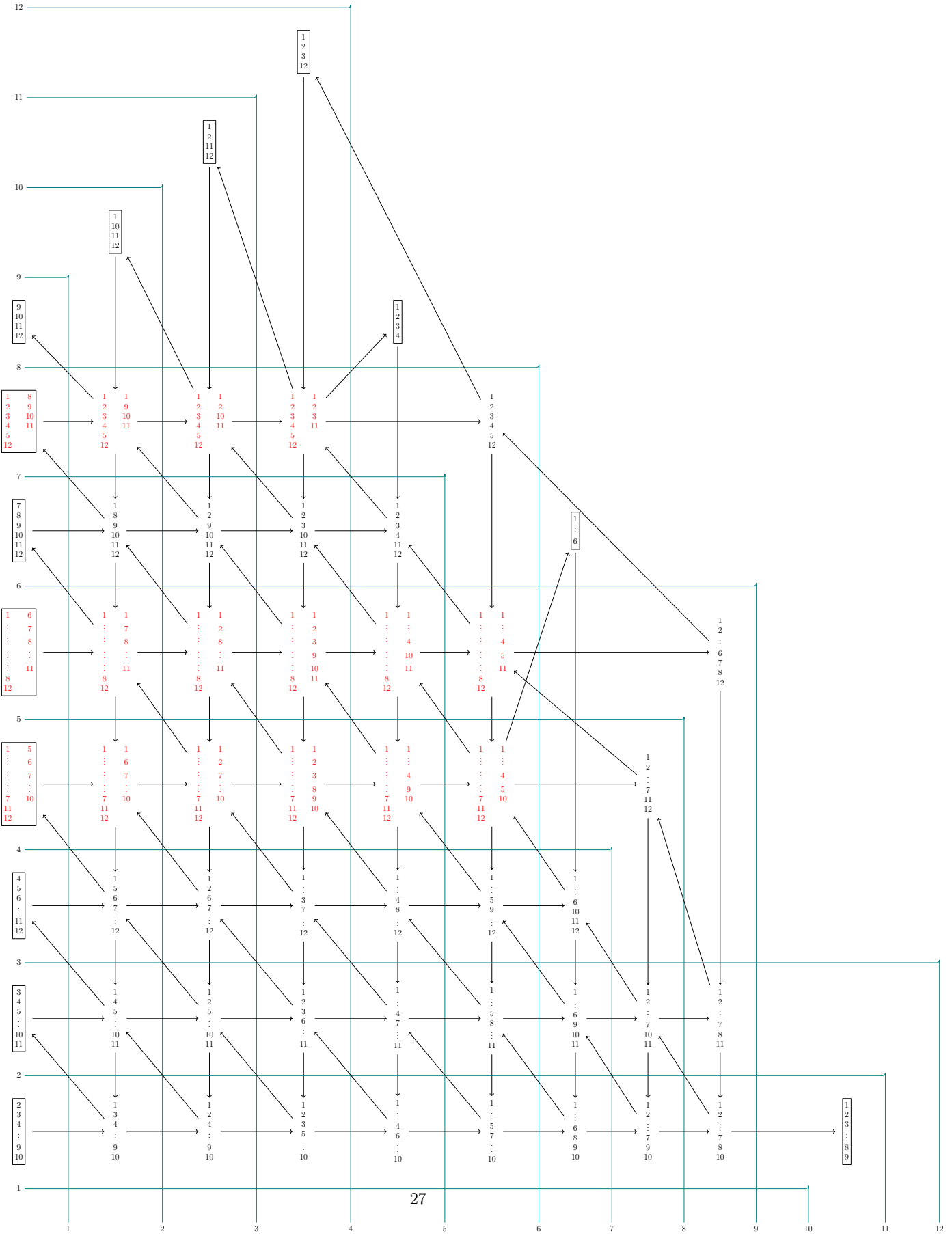

FIGURE 11. The initial seed for $\mathcal{F}_{4,6,9;12}$.

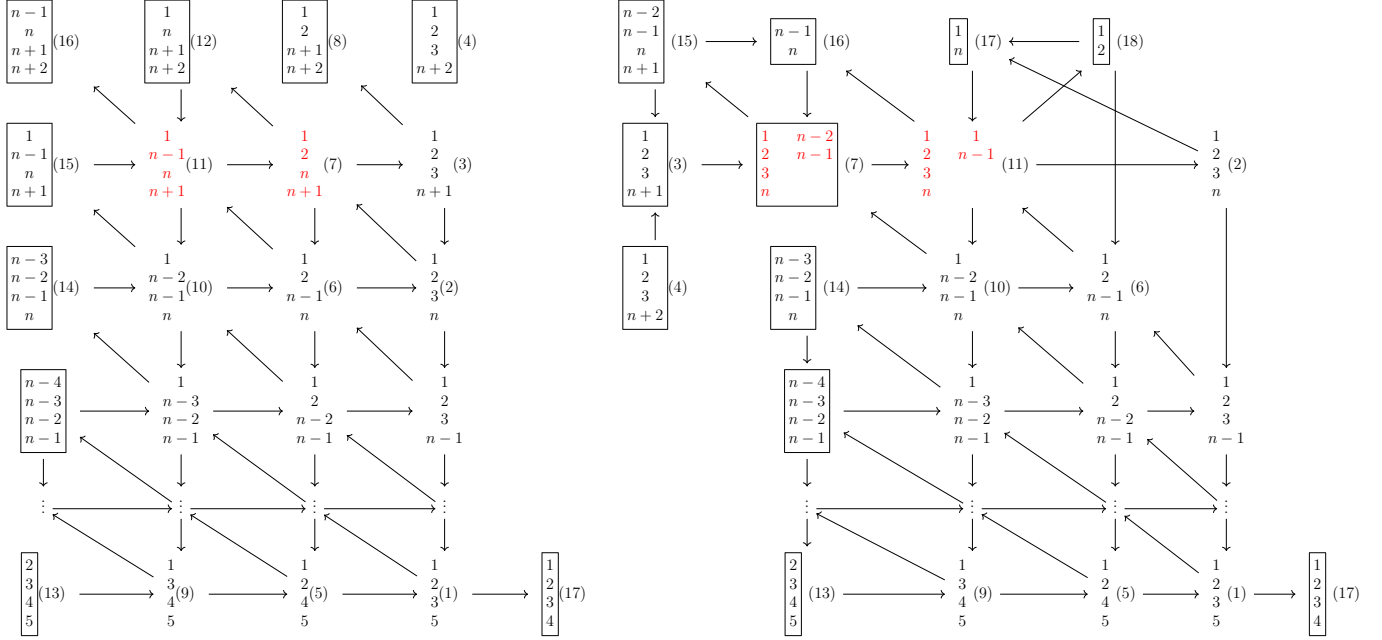

FIGURE 12. LHS: The initial seed for Grassmannian $\text{Gr}_{4;n+2}$. RHS: a seed obtained by mutating (11), (7), (11) of the seed on LHS and freeze (7). The full subquiver on RHS on all vertices but (3), (4), (15) coincides with the initial seed for $\mathcal{F}\ell_{2,4;n}$.

The mutation sequence (11), (7), (11) yields the missing cluster variables, see Figure 12. This is followed by freezing

$$\begin{array}{l} 1 \ n-2 \\ 2 \ n-1 \\ 3 \ n+1 \\ \vdots \\ n \ n+2 \end{array}$$

which is the mutable vertex (7) in the Grassmannian. Now all tableaux but

$$\begin{array}{|c|} \hline n-2 \\ \hline n-1 \\ \hline n \\ \hline n+1 \\ \hline \end{array}, \quad \begin{array}{|c|} \hline 1 \\ \hline 2 \\ \hline 3 \\ \hline n+2 \\ \hline \end{array} \quad \text{and} \quad \begin{array}{|c|} \hline 1 \\ \hline 2 \\ \hline 3 \\ \hline n+1 \\ \hline \end{array}.$$

coincide with the images of the initial tableaux for $\mathcal{F}\ell_{2,4;n}$. Furthermore, the full subquiver on all vertices but the ones corresponding to the above mentioned three tableaux is the initial quiver for $\mathcal{F}\ell_{2,4;n}$.

5.2. Spinor helicity varieties. As already mentioned in the introduction the spinor helicity variety $\mathcal{S}\mathcal{H}_n$ is isomorphic to the partial flag variety $\mathcal{F}\ell_{2,n-2;n}$ with isomorphism given in (1.1). The initial seed for $n = 8$ and $\mathcal{F}\ell_{2,6;8}$ is displayed in Figure 13.

The initial quiver for $\text{Gr}_{n-2;2n-4}$ consists of a $(n-2) \times (n-2)$ -grid with one additional vertex at the south-east corner. The first row and the first column of the grid consist of frozen vertices. All mutations we perform take place in a $(n-5) \times (n-4)$ grid that is north-west bound inside the initial quiver. We call the latter the *mutation grid*. An example for $n = 8$ and $\text{Gr}_{6;12}$ is given in Figure 14.

Let $a = d_2 - d_1 - 1 = n - 5$, $b = d_2 - 2 = n - 4$, $c = d_1 = 2$. The mutation sequence is as follows.

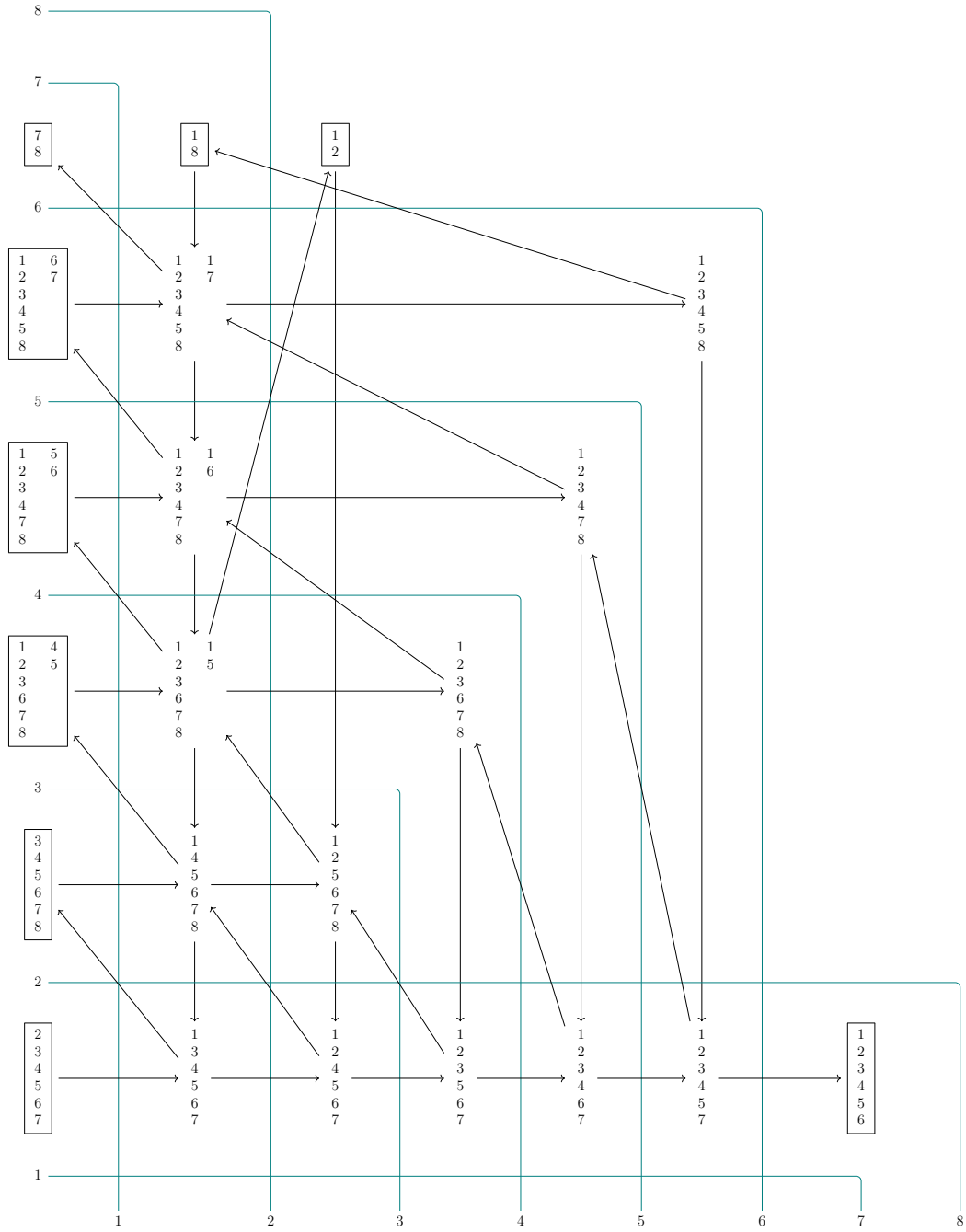

FIGURE 13. The initial seed for the partial flag variety $\mathcal{F}l_{2,6;8}$.

- The first page:

$$\begin{aligned}
 & (a, 1), (a, 2), \dots, (a, b), \\
 & (a - 1, 1), (a - 1, 2), \dots, (a - 1, b), \\
 & \vdots \\
 & (2, 1), (2, 2), \dots, (2, b), \\
 & (1, 1), (1, 2).
 \end{aligned}$$

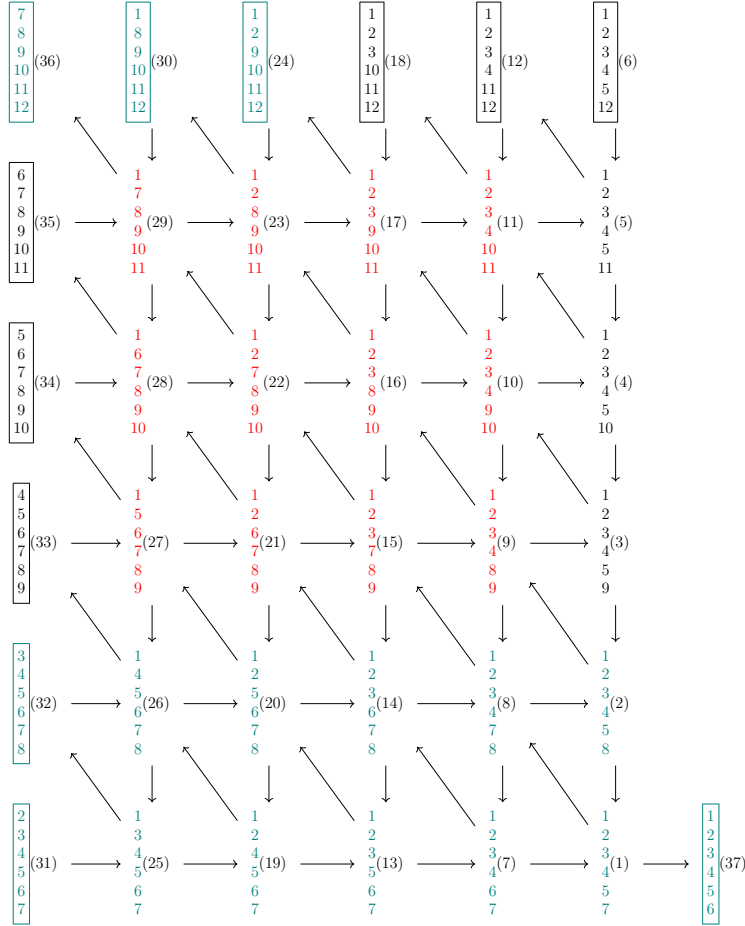

FIGURE 14. The initial seed for the Grassmannian $\text{Gr}_{6,12}$. The central 3×4 -grid from vertex (9) to (29) marked in red is the mutation grid. After the mutation sequence we freeze vertices (29), (16) and (10). Vertices marked in teal are those that already correspond to initial cluster variables for $\mathcal{F}_{2,6,8}$.

The cluster variable $\begin{matrix} 1 & 4 \\ 2 & 5 \\ 3 & 6 \\ \vdots & \\ n & \end{matrix}$ appears at position (1, 2).

- The second page:

$$\begin{aligned}
& (a, 1), (a, 2), \dots, (a, b), \\
& (a - 1, 1), (a - 1, 2), \dots, (a - 1, b), \\
& \vdots \\
& (3, 1), (3, 2), \dots, (3, b), \\
& (2, 1), (2, 2), \\
& (1, 1).
\end{aligned}$$

The two cluster variables $\frac{4}{7}$ and $\frac{3}{6}$ appears at positions $(2, 2)$ and $(1, 1)$ respectively.

- Continue this procedure. At the i th ($i \in [1, n - 4]$) page:

$$\begin{aligned}
& (a, 1), (a, 2), \dots, (a, b), \\
& (a - 1, 1), (a - 1, 2), \dots, (a - 1, b), \\
& \vdots \\
& (i + 1, 1), (i + 1, 2), \dots, (i + 1, b), \\
& (i, 1), (i, 2), \\
& (i - 1, 1).
\end{aligned}$$

where the last line is empty if $i = 1$. The cluster variables

$$\begin{array}{cc}
1 & 1 \\
\vdots & \vdots \\
\vdots & j_2 \\
j_1 + 3 & j_1 + j_2 + 4 \\
j_1 + 6 & \vdots \\
\vdots & j_1 + 5 \\
n &
\end{array}$$

appears at positions $(j_1 + 1, 2 - j_2)$, $j_1 + j_2 = i - 1$, $j_1, j_2 \in \mathbb{Z}_{\geq 0}$, $j_2 \leq 1$, $i \in [1, n - 4]$, respectively.

The number of mutation steps is $\frac{1}{2}(n - 5)(n^2 - 10n + 30)$, see Lemma 4.2. We freeze the cluster variables at positions $(i, 2)$, $i \in [a]$, $a = n - 5$. Let s' denote the seed of the Grassmannian obtained from the initial seed by applying the above mutation sequence and let Q' be its quiver. The images of the initial cluster variables for $\mathcal{F}\ell_{2, n-2; n}$ are contained in the set of cluster variables of s' . The seed $(Q_{2, n-2; n}, \varphi^*(\mathbf{x}_{2, n-2; n}))$ is a restricted seed of s' . We can delete $(n - 3)(n - 5)$ vertices to obtain the initial seed for $\mathcal{F}\ell_{2, n-2; n}$. The final seed of the example $\mathcal{F}\ell_{2, 6; 8}$ is shown in Figure 15.

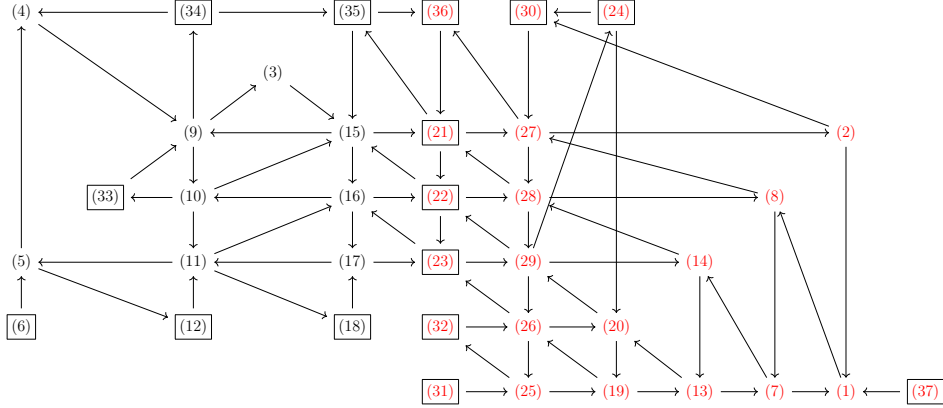

FIGURE 15. The quiver Q' obtained from the initial seed in Figure 14 after the mutation sequence (27), (21), (15), (9), (28), (22), (16), (10), (29), (23), (27), (21), (15), (9), (28), (22), (29), (27), (21), (28), (27) and freezing vertices (21), (22), (23). All colored vertices on the RHS yield the restricted seed corresponding to the initial seed for $\mathcal{F}\ell_{2,6;8}$ (compare to Figure 13).

REFERENCES

- [AHT14] Nima Arkani-Hamed and Jaroslav Trnka. The Amplituhedron. *JHEP*, 10:030, 2014.
- [BDG23] L. Bossinger, J. M. Drummond, and R. Glew. Adjacency for scattering amplitudes from the Gröbner fan. *JHEP*, 11:002, 2023.
- [BDS05] Zvi Bern, Lance J Dixon, and Vladimir A Smirnov. Iteration of planar amplitudes in maximally supersymmetric Yang-Mills theory at three loops and beyond. *Physical Review D-Particles, Fields, Gravitation, and Cosmology*, 72(8):085001, 2005.
- [BFZ96] Arkady Berenstein, Sergey Fomin, and Andrei Zelevinsky. Parametrizations of canonical bases and totally positive matrices. *Adv. Math.*, 122(1):49–149, 1996.
- [BFZ05] Arkady Berenstein, Sergey Fomin, and Andrei Zelevinsky. Cluster algebras. III. Upper bounds and double Bruhat cells. *Duke Math. J.*, 126(1):1–52, 2005.
- [BHPZ24] Simon Badger, Johannes Henn, Jan Christoph Plefka, and Simone Zoia. Scattering Amplitudes in Quantum Field Theory. *Lect. Notes Phys.*, 1021:pp., 2024.
- [BKP⁺18] Sara Billey, Matjaz Konvalinka, T. Kyle Petersen, William Slofstra, and Bridget Tenner. Parabolic double cosets in Coxeter groups. *Electron. J. Combin.*, 25(1):Paper No. 1.23, 66, 2018.
- [Bou02] Nicolas Bourbaki. *Lie groups and Lie algebras. Chapters 4–6*. Elements of Mathematics (Berlin). Springer-Verlag, Berlin, 2002. Translated from the 1968 French original by Andrew Pressley.
- [Bri05] Andrea Brini. Combinatorics, superalgebras, invariant theory and representation theory. *Séminaire Lotharingien de Combinatoire [electronic only]*, 55:B55g–117, 2005.
- [BSS77] Lars Brink, John H Schwarz, and Joel Scherk. Supersymmetric Yang-Mills theories. *Nuclear Physics B*, 121(1):77–92, 1977.
- [CDFL20] Wen Chang, Bing Duan, Chris Fraser, and Jian-Rong Li. Quantum affine algebras and Grassmannians. *Mathematische Zeitschrift*, 296(3):1539–1583, 2020.
- [CHDD⁺19a] Simon Caron-Huot, Lance J Dixon, Falko Dulat, Matt Von Hippel, Andrew J McLeod, and Georgios Papathanasiou. The cosmic galois group and extended steinmann relations for planar $n = 4$ sym amplitudes. *Journal of High Energy Physics*, 2019(9):1–67, 2019.
- [CHDD⁺19b] Simon Caron-Huot, Lance J Dixon, Falko Dulat, Matt Von Hippel, Andrew J McLeod, and Georgios Papathanasiou. Six-gluon amplitudes in planar $n = 4$ super-Yang-Mills theory at six and seven loops. *Journal of High Energy Physics*, 2019(8):1–47, 2019.

- [CHDMvH16] Simon Caron-Huot, Lance J Dixon, Andrew McLeod, and Matt von Hippel. Bootstrapping a five-loop amplitude using steinmann relations. *Physical Review Letters*, 117(24):241601, 2016.
- [CP91] Vyjayanthi Chari and Andrew Pressley. Quantum affine algebras. *Comm. Math. Phys.*, 142(2):261–283, 1991.
- [DDDP14] Lance J Dixon, James M Drummond, Claude Duhr, and Jeffrey Pennington. The four-loop remainder function and multi-regge behavior at NNLLA in planar $N = 4$ super-Yang-Mills theory. *Journal of High Energy Physics*, 2014(6):1–59, 2014.
- [DDH11] Lance J Dixon, James M Drummond, and Johannes M Henn. Bootstrapping the three-loop hexagon. *Journal of High Energy Physics*, 2011(11):1–34, 2011.
- [DDH12] Lance J Dixon, James M Drummond, and Johannes M Henn. Analytic result for the two-loop six-point nmhv amplitude $n = 4$ super Yang-Mills theory. *Journal of High Energy Physics*, 2012(1):1–50, 2012.
- [DDH⁺17] Lance J Dixon, James Drummond, Thomas Harrington, Andrew J McLeod, Georgios Papathanasiou, and Marcus Spradlin. Heptagons from the steinmann cluster bootstrap. *Journal of High Energy Physics*, 2017(2):1–42, 2017.
- [DDvHP13] Lance J Dixon, James M Drummond, Matt von Hippel, and Jeffrey Pennington. Hexagon functions and the three-loop remainder function. *Journal of High Energy Physics*, 2013(12):1–95, 2013.
- [DFG18] James Drummond, Jack Foster, and Ömer Gürdoğan. Cluster Adjacency Properties of Scattering Amplitudes in $N = 4$ Supersymmetric Yang-Mills Theory. *Phys. Rev. Lett.*, 120(16):161601, 2018.
- [DFG19] James Drummond, Jack Foster, and Ömer Gürdoğan. Cluster adjacency beyond MHV. *JHEP*, 03:086, 2019.
- [DFGP19] James Drummond, Jack Foster, Ömer Gürdoğan, and Georgios Papathanasiou. Cluster adjacency and the four-loop NMHV heptagon. *JHEP*, 03:087, 2019.
- [DFLP19] David Damgaard, Livia Ferro, Tomasz Lukowski, and Matteo Parisi. The Momentum Amplituhedron. *JHEP*, 08:042, 2019.
- [DGL24] James Drummond, Ömer Gürdoğan, and Jian-Rong Li. Tropical symmetries of cluster algebras. in preparation, 2024.
- [DPS15] James M Drummond, Georgios Papathanasiou, and Marcus Spradlin. A symbol of uniqueness: the cluster bootstrap for the 3-loop mhv heptagon. *Journal of High Energy Physics*, 2015(3):1–28, 2015.
- [DvH14] Lance J Dixon and Matt von Hippel. Bootstrapping an nmhv amplitude through three loops. *Journal of High Energy Physics*, 2014(10):1–64, 2014.
- [DvHM16] Lance J Dixon, Matt von Hippel, and Andrew J McLeod. The four-loop six-gluon nmhv ratio function. *Journal of High Energy Physics*, 2016(1):1–66, 2016.
- [EMPS24] Yassine El Mazzouz, Anäelle Pfister, and Bernd Sturmfels. Spinor-Helicity Varieties. 2024.
- [EtH15] Henriette Elvang and Yu tin Huang. Scattering amplitudes in gauge theory and gravity. 2015.
- [EZLP⁺23] Chaim Even-Zohar, Tsviqa Lakrec, Matteo Parisi, Ran Tessler, Melissa Sherman-Bennett, and Lauren Williams. Cluster algebras and tilings for the $m = 4$ amplituhedron. 10 2023.
- [EZLP⁺24] Chaim Even-Zohar, Tsviqa Lakrec, Matteo Parisi, Melissa Sherman-Bennett, Ran Tessler, and Lauren Williams. A cluster of results on amplituhedron tiles. 2 2024.
- [Fei12] Evgeny Feigin. \mathbb{G}_a^M degeneration of flag varieties. *Selecta Math. (N.S.)*, 18(3):513–537, 2012.
- [Ful97] William Fulton. *Young tableaux*, volume 35 of *London Mathematical Society Student Texts*. Cambridge University Press, Cambridge, 1997. With applications to representation theory and geometry.
- [FWZ17] Sergey Fomin, Lauren Williams, and Andrei Zelevinsky. Introduction to cluster algebras. chapters 4-5. *arXiv preprint arXiv:1707.07190*, 2017.
- [FZ02] Sergey Fomin and Andrei Zelevinsky. Cluster algebras. I. Foundations. *J. Amer. Math. Soc.*, 15(2):497–529, 2002.
- [GG⁺14] John Golden, Alexander B. Goncharov, Marcus Spradlin, Cristian Vergu, and Anastasia Volovich. Motivic Amplitudes and Cluster Coordinates. *JHEP*, 01:091, 2014.
- [GLS08] Christof Geiss, Bernard Leclerc, and Jan Schröer. Partial flag varieties and preprojective algebras. *Ann. Inst. Fourier (Grenoble)*, 58(3):825–876, 2008.

- [GSO77] Ferdinando Gliozzi, Joel Scherk, and David Olive. Supersymmetry, supergravity theories and the dual spinor model. *Nuclear Physics B*, 122(2):253–290, 1977.
- [HL10] David Hernandez and Bernard Leclerc. Cluster algebras and quantum affine algebras. *Duke Math. J.*, 154(2):265–341, 2010.
- [Kad23] Fayadh Kadhém. A cluster structure on the coordinate ring of partial flag varieties. *Journal of Algebra*, 628:328–349, 2023.
- [Kas91] M. Kashiwara. On crystal bases of the Q -analogue of universal enveloping algebras. *Duke Math. J.*, 63(2):465–516, 1991.
- [KKOP21] Masaki Kashiwara, Myungho Kim, Se-jin Oh, and Euiyong Park. Categories over quantum affine algebras and monoidal categorification. *Proc. Japan Acad. Ser. A Math. Sci.*, 97(7):39–44, 2021.
- [KKOP24] Masaki Kashiwara, Myungho Kim, Se-jin Oh, and Euiyong Park. Monoidal categorification and quantum affine algebras II. *Invent. Math.*, 236(2):837–924, 2024.
- [KL79] David Kazhdan and George Lusztig. Representations of coxeter groups and hecke algebras. *Inventiones mathematicae*, 53(2):165–184, 1979.
- [Kob11] M. Kobayashi. Two-sided structure of double cosets in coxeter groups. *http://www.math.titech.ac.jp/~toshio/Preprints/pdf/162.pdf*, 2011.
- [LB15] V. Lakshmibai and Justin Brown. *The Grassmannian variety*, volume 42 of *Developments in Mathematics*. Springer, New York, 2015. Geometric and representation-theoretic aspects.
- [Li24] Jian-Rong Li. Dual canonical bases for unipotent groups and base affine spaces. *Journal of Algebra and its Applications*, <https://doi.org/10.1142/S0219498825503542>, 2024.
- [LR08] Venkatramani Lakshmibai and Komaranapuram N. Raghavan. *Standard monomial theory*, volume 137 of *Encyclopaedia of Mathematical Sciences*. Springer-Verlag, Berlin, 2008. Invariant theoretic approach, Invariant Theory and Algebraic Transformation Groups, 8.
- [Lus90] George Lusztig. Canonical bases arising from quantized enveloping algebras. *Journal of the American Mathematical Society*, 3(2):447–498, 1990.
- [MS16] R. J. Marsh and J. S. Scott. Twists of Plücker coordinates as dimer partition functions. *Comm. Math. Phys.*, 341(3):821–884, 2016.
- [Qin17] Fan Qin. Triangular bases in quantum cluster algebras and monoidal categorification conjectures. *Duke Math. J.*, 166(12):2337–2442, 2017.
- [Sco06] Joshua S. Scott. Grassmannians and cluster algebras. *Proc. London Math. Soc. (3)*, 92(2):345–380, 2006.
- [tH93] Gerard 't Hooft. A planar diagram theory for strong interactions. In *The Large N Expansion In Quantum Field Theory And Statistical Physics: From Spin Systems to 2-Dimensional Gravity*, pages 80–92. World Scientific, 1993.

INSTITUTO DE MATEMÁTICAS UNIDAD OAXACA, UNIVERSIDAD NACIONAL AUTÓNOMA DE MÉXICO, LEÓN 2, ALTOS, CENTRO HISTÓRICO, 68000 OAXACA, MEXICO
Email address: lara@im.unam.mx

JIAN-RONG LI, FACULTY OF MATHEMATICS, UNIVERSITY OF VIENNA, OSKAR-MORGENSTERN-PLATZ 1, 1090 VIENNA, AUSTRIA
Email address: jianrong.li@univie.ac.at