

# Software Defined Vehicles for Development of Deterministic Services

Pedro V. Teixeira, *Student Member, IEEE*, Duarte Raposo, *Member, IEEE*,  
Rui Eduardo Lopes, *Student Member, IEEE*, Susana Sargento, *Senior Member, IEEE*

**Abstract**—With modern vehicles evolving with more features, services, complex systems, with more sensors, actuators, and processing units, it is essential to think about vehicles not only as means of transportation that may tend towards full autonomy, but also as adaptive objects, that suit themselves to the needs of occupants. Vehicular services can be developed to support these adaptations. However, the increasing complexity of vehicular service development, even with current standardizations and best practices and guidelines, are insufficient to tackle the high complexity of development, with expectations of up to 1 (U.S.) billion lines of code for a fully (level 5) autonomous vehicle. Within this survey, the paradigm of Deterministic Software Defined Vehicles is explored towards increasing the quality and easiness of the development of services for automotive. Towards this, a proposed vision with four pillars is also provided: the deterministic network configurator, the data layer configurator, and the hypervisor configurator and the vehicle abstraction layer, all coordinated by a software orchestrator.

**Index Terms**—Software-Defined Vehicles, Connected Vehicles, Vehicular Applications, Vehicular Services, Intelligent Transportation Systems, Deterministic Networks, Time Sensitive Networks

## I. INTRODUCTION

We are living in an ever more connected world, which is not very safe nor designed for everyone. This is particularly true within vehicular scenarios, where autonomous next generation vehicles are designed solely to remove the need of a driver without much consideration for occupants and other road users' specific needs. This is even more substantial in a more and more elderly society, where impairments are unavoidable.

Even if vehicle will tend to become driver-less, autonomous vehicles may also take decades to be fully on the roads and starting now, they will coexist with manual-driven cars. As such, autonomous vehicles do not take on the needs of the other occupants. Examples of such needs would be the vehicle recognizing them or potential health issues and providing personalized profiles and automatic adjustments on seating, cooling systems, driving profiles but also other vehicular subsystems that may support some sort of impairment.

It is therefore essential to think about vehicles not only as means of transportation that may tend towards not requiring drivers, but also as adaptive objects, that suit themselves to the needs of occupants. But this adaptation must be carried out flawlessly, since any failure can mean harm to someone,

Financial support from the National Science and Technology Foundation within grant FCT.2023.04459.BD.

Pedro V. Teixeira, Rui Lopes and Susana Sargento are with the Instituto de Telecomunicações and Universidade de Aveiro, Aveiro, Portugal. Duarte Raposo is with the Instituto de Telecomunicações, Aveiro, Portugal.

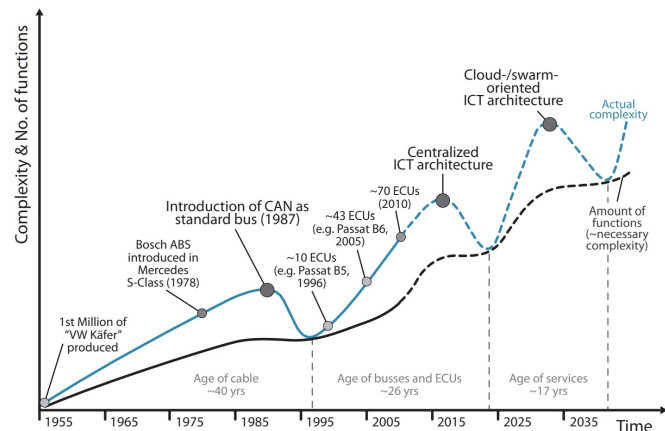

Fig. 1: Evolution of complexity in vehicular architectures [1].

or even death. The context of deterministic — *i.e.* where the result is exactly what was intended in the exact moment it was intended — critical vehicular services — pieces of software that carry out something within the vehicle or its environment — within Software-Defined Vehicle can provide a solution to this problem.

With the introduction of computational systems into vehicles in late 1980s, the complexity — *i.e.*, the amount of systems that need to be choreographed, developed, tested and that have to communicate — of vehicles exploded, as well as the possibilities of something going wrong [2], [3]. Product compliance in the automotive industry already have to deal with more than 100 million source lines of code [4] and will have to deal with more than 300 million lines of code by 2030, to take into account more than 500 thousand regulations and requirements (80% of them focused on safety) [5]. With fully autonomous driver-less cars, Original Equipment Manufacturers (OEMs) estimations are even more problematic, with expectations of up to 1 billion lines of code [4].

Current vehicular systems are extremely complex, with many Electronic Control Units (ECUs) (at least around 100<sup>1</sup>), sensors, and actuators scattered throughout the vehicle and more than 100 million lines of code<sup>2</sup>, with perspective of reaching 500 million to 1 billion with level 5 autonomous vehicles [6]. This is part of an ever-growing tendency of

<sup>1</sup>Described in [www.fortunebusinessinsights.com](http://www.fortunebusinessinsights.com).

<sup>2</sup>More than in a military or commercial aircraft (F-35, 787 Dreamliner) [6].

increasing complexity in vehicular architectures, as depicted in fig. 1.

This growing code base is becoming unmanageable to vehicle manufacturers and developers of vehicular services. As described in fig. 2, automakers will tend to leave unchecked, unverified and poorly tested software go into production vehicles if the growth trend of the code base continues — with potentially deadly results<sup>3</sup>. The overall intra-vehicular systems as developed following legacy standards and practices are deemed too complex and static — and thus costly to maintain, update and keep safe — by vehicle manufacturers, with the reduction of the overall complexity (both in software and hardware terms, in particular wiring harness weight savings) becoming a major goal in order to reduce operational costs and decrease potential security issues from unchecked, poorly tested code [7].

Standardization of best practices and development guidelines for intra vehicular software gained traction during the early 2000s [8], they are insufficient to tackle such complexity of development. While programming methodologies<sup>4</sup> and guidelines<sup>5</sup> are critical and cannot be disregarded, they are no longer enough to tackle this complexity.

In this article, we propose that *the quality and easiness of the development of services for automotive can be improved using the paradigm of Deterministic Software Defined Vehicles*. The main contributions of this tutorial are as follows:

- 1) Demonstrate the suitability and relevance of the software defined vehicles for an sustainable development of vehicular services.
- 2) Improve the state-of-the-art on Software Defined Vehicle concept and its main building blocks.
- 3) Propose an integration of Time-Aware and Deterministic Networks concepts and solutions within a Software Defined Vehicle.
- 4) Definition of a set of potential use cases that aim to frame the proposed integration not only in the foreseeable future, but in a long-term perspective.
- 5) Survey of hardware and software alternatives for validation of the proposed integration.

The remaining of this document is organized into four sections. Section II: Software Defined Vehicles — introduces the background concepts, defining vehicular services and their characteristics and the concept of Software-Defined Vehicle (SDV) and additional information on the industrial landscape and how automakers or suppliers are facing the SDV paradigm. Next, section III: Main building blocks of Software Defined Vehicles — presents the main building blocks for a SDV based vehicle (and vehicular services) development, and section IV: Open challenges — discusses on the main challenges.

Section V: Potential use cases — follows with the main use cases and requirements that can be drawn from them, while

<sup>3</sup>Unverified logic and deadly effects on Tesla's autopilot [www.washingtonpost.com](http://www.washingtonpost.com).

<sup>4</sup>Such as static code analysis, Test Driven Development (TDD) and equivalent methodologies.

<sup>5</sup>Such as the Automotive Safety Integrity Levels (ASILs) within ISO 26262 or Motor Industry Software Reliability Association (MISRA)-C, a set of guidelines for safety-related systems, such as automotive vehicles. Details at [synopsys.com](http://synopsys.com), [misra.org.uk](http://misra.org.uk) and [synopsys.com](http://synopsys.com).

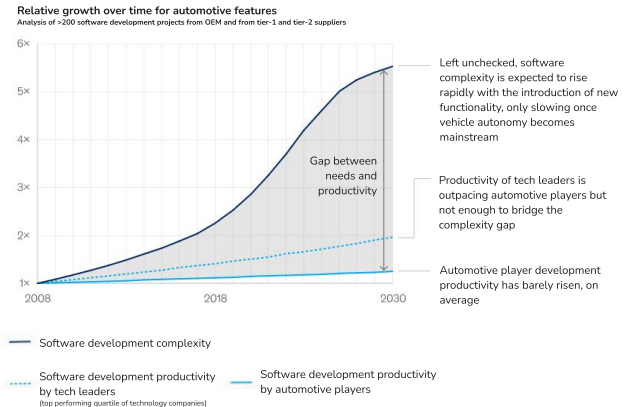

Fig. 2: Average complexity of individual software projects grown by 300 percent over the past decade, creating an unsustainable gap between software complexity and the productivity of software developers [6], [9].

Section VI: Proposed vision — considers those requirements for a proposed architecture, as well as a proposal of how the evaluation process to validate the work may be considered, with considerations on required hardware and software for results obtained both through simulation or real-world testing. Finally, conclusions are provided in section VII: Conclusions.

## II. SOFTWARE DEFINED VEHICLES

This section presents the concept of vehicular services, software defined vehicles and the efforts in the framework of the industry landscape.

### A. Vehicular Services

The desired transition from fossil-fueled vehicles towards clean-energy Intelligent Transport System (ITS) requires the introduction of more advanced systems and services. Such services are required to support the necessary auxiliary electrical systems, increase overall range while decreasing the environmental impact, but also to improve the overall quality of life for passengers and drivers and support (semi)autonomous driving. Vehicular services can be drawn a parallelism to personal computing applications: some services are critical, others are less critical, some require vast computing resources, either in terms of Central Processing Unit (CPU), memory, storage, or graphical resources [10], and can broadly be classified in terms of real-time guarantee levels in [11] either hard real-time services (where deadline failure means a system failure with potential catastrophic consequences), weakly hard real-time (where some tasks can be skipped, while keeping the deadline fulfillment) or soft real-time (where a specific number of deadlines can be missed).

Critical services such as safety services (*e.g.* emergency braking) can be considered within the SDV as well as services related to the occupants [12]. Main requirements of most of those services include high interoperability, reliability, availability, safety, security, performance, scalability, extensibility, adaptability and testability [13]. During the overall definition

and characterization of a vehicular service it is essential to formulate the service and characterize its tasks in terms of those requirements, with particular emphasis on characteristics such as the priority of the service, data specifications — such as format, size and real time guarantee requirements (periodicity or deadline for receiving/sending data) — expected computing location (vehicle edge vs smart city cloud) [11], [14]. Non functional characteristics such as cost minimization, efficient use of available resources, maintainability and scalability, high flexibility to add new services (without custom hardware and software stacks), and redundancy at network and computing level, while keeping backwards compatibility with older vehicles shall also be taken into account [14].

These characteristics can be seen as the Service Level Agreement (SLA) of the service. Such SLAs can and should be defined by the developer of each vehicular service and could be ensured/enforced by a distributed configurator through a set of Quality of Service (QoS) tools and policies, including [11]:

- Network and resource monitoring and discovery.
- Dynamic, intelligent task scheduling and resource estimation, provisioning and allocation, including the offloading to other layers of communication (fog and cloud), if the overall end to end communication latency is capable of supporting such offloading while fulfilling deterministic well defined deadlines.
- Federation of multiple physical wireless and wired access layers in order to obtain a multi-homing solution.
- Slicing of the multi-homing communication solution to support different levels of QoS specified by the service descriptors.
- Management of the high mobility, for example through the management of reactive and proactive handovers through Software-Defined Network (SDN) [15] based solutions.
- Prediction of the overall resource usage while considering heterogeneity of the nodes. For example, a system that, through the service descriptor and usage trends of each/all ECUs, analyzes the likelihood of such service of being resource starved or not, can be a good first estimation<sup>6</sup>. This can be further improved by defining an overall cost of each node [16], or by introducing reinforcement learning techniques into the scheduling of the tasks [17].
- Estimation and prediction of the mobility of a certain service deployment based on trends of resource usage and prediction of the mobility of the vehicle [18].

While considering specifics of the vehicular domain, such as the mobility of vehicular nodes, communication and node failures, heterogeneity of the nodes hardware specifications, overall low specification and communication techniques and overall security threats.

## B. Concept

Automotive vehicles need to evolve to a new concept of SDV since in-vehicle services must be dynamic, and should

be able to adapt over the vehicle life-cycle. At the same time, in-vehicle services need to interact with the vehicle's systems, sensors, and the surrounding infrastructure within a well-defined time-frame. Therefore, systems must also be interconnected with a high-performance, high-precision, reliable set of networks and protocols with time guarantees.

SDV aims to improve cars along their life-cycle [19], while potentially mitigating the increased unmanaged complexity of modern vehicular software, hardware, and communications. The paradigm states that vehicles manage their operations, add functionality, and enable new features primarily or entirely through software<sup>7</sup>. Since vehicles evolve over their lifetime, with more features, solutions that may require remote control or remote updates, main features being delivered by software adds flexibility and reduces the overhead. The shift towards SDV signifies new features can be pushed to existing and new vehicles, which are now more defined through software than through hardware or mechanical systems as in the past [6]. To support this new paradigm, computational architectures within vehicles are going from fully distributed ECUs scattered throughout the vehicle towards a more centralized solution, with zone-based architectures, *i.e.* ECUs positioned in specific parts of the vehicle responsible for certain types of actions [20]. ECUs are now responsible for more functions, thus being more powerful, powered with tailor made System-on-chips (SoCs) with more cores and Digital Signal Processors (DSPs), Graphical Processing Units (GPUs) and Ethernet capability [6] with partnerships with Integrated Circuits (ICs) manufacturers [21].

SDV support not just the improvement of the development of vehicular services but also helps towards a decrease in hardware complexity (with decreased number of ECUs, cables and the cost and weight savings which follow), with more uniform software code-base (and the reduction of the costs and complexity of the development process which follow) and greater adaptability<sup>8</sup> towards the future, with the possibility of new or updated features as over the air updates during the vehicle's lifetime. This adaptability also supports a greater capability to process higher volumes of data while fulfilling the overall performance requirements — essential in Connected Autonomous Vehicles (CAVs).

Vehicles in the past added new features at the cost of new specialized ECUs close to the sensors and actuators and connected to them through CAN or other equivalent bus (more details at section III-D. This tendency created an upwards trend in the number of ECUs and connecting wiring.

The new Electrical/Electronic (E/E) architectures within a vehicle follow the principle of aggregation of ECUs into a small subset of more powerful ECU, interconnected through a high performance bus, such as Ethernet [23]. Figure 3 provides an overview of this evolution.

Intra vehicular computational architectures have evolved from the original distributed approach, where custom isolated ECUs implement a dedicated very specific function towards

<sup>7</sup>More details at <https://blackberry.qnx.com/en/ultimate-guides/software-defined-vehicle>.

<sup>8</sup>This adaptability is essential specially if the future of the car ownership is car sharing [22].

<sup>6</sup>Author proposal.

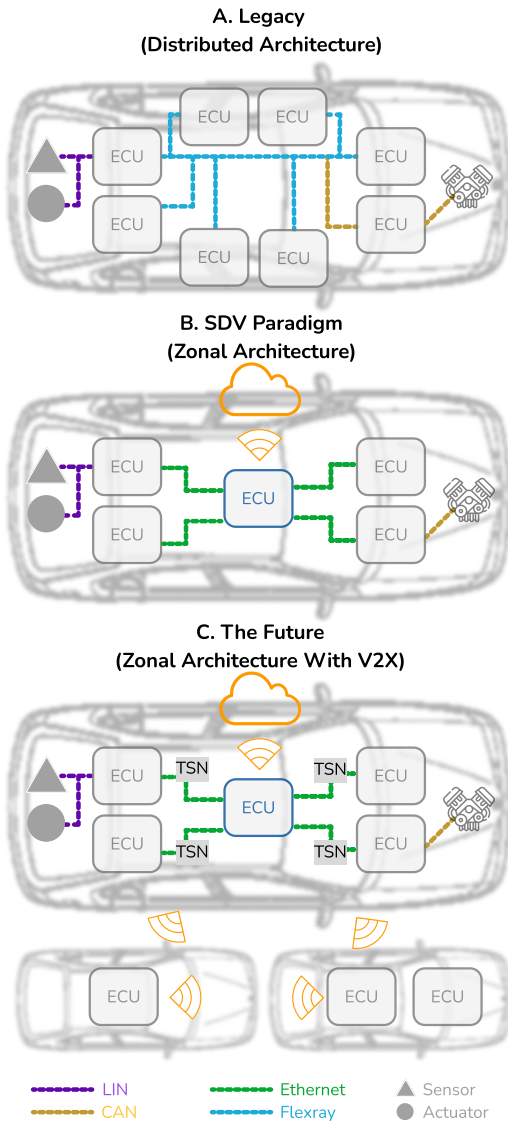

Fig. 3: Legacy, current, and future SDV paradigm on the topology of ECUs within a vehicle.

interconnected ECUs with various degrees of aggregation of function. With the introduction of ECUs during the 1980s, as in fig. 3 (a), ECUs did very specific functions in an isolated manner and connected only to specific sensors and actuators through Controller Area Network bus (CAN) or equivalent. With the explosion of features in vehicles, specially luxury cars, during the 1990s, ECUs became interconnected. By 2000s, the high complexity of intra vehicular systems became subject to *de facto* standards such as Automotive Open System Architecture (AUTOSAR) [2], [3] and buses such as FlexRay aimed at mitigating some of the shortcomings of CAN.

Decentralized architectures were the norm within intra vehicular systems, allowing a better decoupling, separation of concerns and higher tolerance to equipment failure. However, the scalability of the deployment of services to multiple ECUs (specially considering all the possible ECU variations), the performance of communications and the overall cost in bulky

wiring harnesses and several ECUs created a trend towards a more centralized architecture, with more centralization of processing in less computing units. This follows previous trends within other industries, in particular the aviation industry [14].

While distributed architectures tend to ensure high reliability in the event of equipment failure and each ECU is simpler, cheaper, and with a very specific purpose (and thus easier to outsource its manufacturing), the overall architecture is not designed for scalability, flexibility and changeability. By 2010s, domain architectures were a first step towards mitigating those issues through the aggregation of functions per domain. However, the integration of multiple domains required by systems such as Advanced Driving Assistance System (ADAS) require coordination between different domains [2], [3].

A fully centralized architecture aims at mitigating that issue while potentiating reduction of costs in the number of ECUs and the higher software reusability, while allowing greater flexibility. In a centralized architecture, high performance microprocessor<sup>9</sup> based ECUs are interconnected through a high performance bus [2], [3]. Centralization within the intra-vehicular systems can thus be achieved at a domain, cross domain or zone/vehicle centralized way [14]:

- Domain oriented solution: In a domain-oriented solution, the clustering is done by vehicle function, which requires heavy interaction between ECUs for complex systems such as ADAS.
- Cross domain solution: In a cross-domain solution, functions of several domains are consolidated within more powerful ECUs. This minimizes, without removing, the high bandwidth required to transfer between ECUs.
- Zone-oriented architecture: In a zone-oriented architecture, ECUs in each zone of the vehicle collect and forward information to a much more powerful central ECU, or even offloads to the cloud. Bosch reported on achieving a 15–20% reduction in wiring harness weight when using a zone-oriented architecture instead of a domain-oriented architecture.

Since functions are now centralized in less ECUs, each one must be more powerful, with multi core CPUs, GPUs, DSPs, and potentially Field-Programmable Gate Arrays (FPGAs). To ensure optimal usage of ECUs, with concurrent execution of different services with different criticality, partitioning of scheduling of each core per service(s) is required. Virtualization of resources, either memory, buses (*e.g.* CAN) and CPU allows both isolation of services within virtual machines while allowing migration and reuse of legacy software (by installing legacy stacks on top of the virtual machines) [14]. Some ECUs can also be dedicated to computing intensive tasks, including Machine Learning (ML) and Deep Learning (DL) workloads supporting ADAS systems [13].

### C. Industrial landscape

Vehicular manufacturers are aware of the necessary changes in thinking. The industry, while already aware for the need

<sup>9</sup>Microcontroller based ECUs are only for very specific safety real-time subsystems.

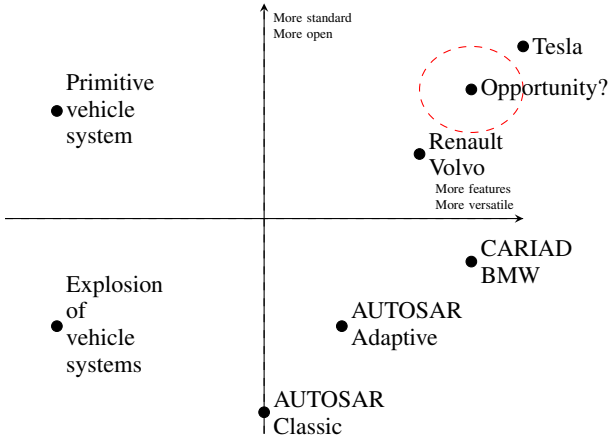

Fig. 4: Positioning of main automakers and frameworks over the overall industrial landscape.

of such solutions, the transition from the previous mentality of closed source, customized solutions for each model of vehicle towards a more extendable, interoperable, architecture. In particular, the Renault, Volvo/Polestar and Volkswagen group seems to be ahead in terms of a more interoperable architecture based on ECUs interconnected through Ethernet that run Android and well-known versions of chipsets. It is however not possible to ignore efforts from other vehicle manufacturers that may be developing equivalent solutions but have not, at the time of this survey, announced their efforts. The opacity of the vehicular industry — expected within a competitive market — while partially mitigated through the research of *gray literature*, remains and will remain a threat to any related work, including this work.

After the landscape changing forced by Tesla, automakers such as BMW [24]; the Renault group through the Renault Software Factory<sup>10</sup>; Volvo; Kia and Hyundai<sup>11</sup>; and the Volkswagen group through the CARIAD<sup>12</sup>, supported by companies such as Vector [25] and VXworks, are shifting towards a software-first development of the vehicles, based on novel hardware and communication paradigms. The next phases of automotive software development should also have a deep integration with cloud and follow the best practices of software development (CI/CD) [26]. Figure 4 provides an overview of the efforts of automakers on adoption the main aspects related to SDV, with table I providing further detail per associated areas.

The Tesla company is probably the most well-known example of application of the SDV paradigm principles. Within their vehicles the ECUs — such as the Autopilot Control Unit, the Media Control Unit, and several Body Control Units — are interconnected through Ethernet and are much less than the usual within vehicles up to that point.

The Volkswagen group take on SDV is based on creating and controlling the whole platform — cloud (Volkswagen Automotive Cloud VW.AC), hardware and software

TABLE I: Overview of the manufacturers effort on SDV.

Entity	State of integration						
	Ethernet	TSN	Zonal ECUs	SOA	SDV	Open	Standard
AUTOSAR Classic	×	×	×	×	×	×	✓
AUTOSAR Adaptive	✓	×	×	✓-	✓-	×	✓
BMW	✓	✓	✓	✓	✓	✓	×
Renault <sup>a</sup>	✓	✓	✓	✓	✓	✓-	✓-
Volvo	✓	✓	✓	✓	✓	✓- <sup>c</sup>	×
Volkswagen group <sup>b</sup>	✓?	✓?	✓?	✓?	✓	×	×
NVIDIA	✓	✓	×	✓	×	×	×
Tesla	✓	✓	✓	✓	✓	✓	✓-
Eclipse	✓	✓	✓	✓	✓	✓	×

<sup>a</sup> Renault software factory

<sup>b</sup> CARIAD

<sup>c</sup> Partial access through Volvo Application Programming Interfaces (APIs).

(VW.Operating System (OS)) [27], affecting interoperability with other automakers and hardware providers. While in initial stages, it was not possible to obtain documentation on APIs or Software Development Kits (SDKs) that should be used to developed vehicular services using the CARIAD ecosystem, highlighting a possible tendency towards a close proprietary SDV paradigm. A notable exception is the Roobadge<sup>13</sup>, a solution to avoid collisions with kangaroos — very common in Australia — by adding, through a front badge or license plate holder sensors to detect the kangaroos. This solution not only showcases a real example of the potential of SDV, since new features are added to an existing vehicle through a new deployed service, but is also compatible with other brand's vehicles, showcasing a real SDV example that considers brand interoperability.

The Renault group considers a backbone of ECUs interconnected with Ethernet, with gateways to bridge the Ethernet connected ECUs with legacy sensors or actuators interconnected by CAN [19], [28]. These ECUs run Android and are based on Qualcomm chipsets, supporting an interoperable, open SDV architecture<sup>14</sup>. Volvo and Polestar have a similar approach, with zone controllers — high performance controllers in specific zones of the vehicle — interconnected and connected to a central master Vehicle Control Unit (VCU) with an Ethernet backbone [29]. The Zone Controllers can also act as a bridge to legacy buses, like CAN and Local Interconnect Network bus (LIN). Volvo within their SDV efforts also published OpenAPI specifications for their CAVs [30].

The BMW group also aims to go from signal oriented to unified vehicle wide layered Service Oriented Architecture (SOA) architecture with providers and consumers [24], [31]. This also requires latencies, configurations and bandwidth options encoded in the system.

The Stellantis group aims at supporting sustainability and user experience use cases through service oriented solutions. SOA can provide the necessary scalability previous service development paradigms could not — namely 1 application per ECU — while allowing a firm contract between services [32].

<sup>10</sup>More details on [www.reuters.com](http://www.reuters.com).

<sup>11</sup>More details on [www.carscoops.com](http://www.carscoops.com).

<sup>12</sup>Available at [cariad.technology](http://cariad.technology).

<sup>13</sup>Product description available at <https://www.volkswagen.com.au/en/roobadge.html>.

<sup>14</sup>More details at [www.qualcomm.com](http://www.qualcomm.com).

General Motors is also working towards their SDV efforts through the uServices solution, a set of APIs for developers and Ultifi, a end-to-end software platform that “will enable Over-the-air (OTA) updates and in-car subscription services” [33].

Non automakers are also working towards providing automakers with new tools. Nvidia is also entering the market with a clear AI first approach<sup>15</sup> — the Nvidia DRIVE OS, which includes a embedded Real-Time Operating System (RTOS), a hypervisor, Compute Unified Device Architecture (CUDA) libraries and TensorRT, and features such as secure boot, security services, firewall, and OTA updates<sup>16</sup>. Vector<sup>17</sup> within its ecosystem propose tools to support development of vehicles with ECUs interconnected by Ethernet with TSN and of services using AUTOSAR within SOA architectures.

MotionWise [34] proposes a middleware for safe orchestration of vehicle software across ECUs for automated driving platforms, with support for AUTOSAR classic and adaptive, Robotic Operating System (ROS), and Data Distribution Service (DDS) support.

The Eclipse Foundation, within its SDV working group, is also working within incubating initiatives to define orchestrators and virtualization managers (Ankaos, Velocitas), vehicle abstraction models (Chariott), a development platform (Kuksa), an abstraction layer for communication between nodes (eCAL) and operation system (MoEc.OS) with support for DDS and integration with environments such as the SUMO and CARLA simulators (further details in section VI-B). While in an initial development phase, these projects can be a good future basis for anyone entering the SDV.

Continental, with the Amazon Internet of Things (IoT) for Automotive<sup>18</sup> support, is also working towards a “a modular multi-tenant hardware and software framework that connects the vehicle to the cloud”<sup>19</sup>.

Autoware, through its Open AD Kit, the first Scalable Open Architecture for Embedded Edge (SOAFEE) blueprint, enables cloud-native DevOps of autonomous driving solutions for SDV<sup>20</sup>.

Hardware companies such as Renesas propose the AosCloud<sup>21</sup>, a solution to support OEMs and service providers from seamless software installation to operation in the vehicle, and implement various new services and functional enhancements simply.

These individual initiatives are being target towards a co-operation. By 2024, at CES 2024, AUTOSAR, Connected Vehicle Systems Alliance (COVESA), Eclipse SDV, and SOAFEE announced a “collaboration of collaborations” to

<sup>15</sup>Developer documentation available at <https://developer.nvidia.com/drive>.

<sup>16</sup>Developer documentation available at <https://developer.nvidia.com/drive/drive-sdk>.

<sup>17</sup>Available at <https://www.vector.com/>

<sup>18</sup>More details at <https://catalog.workshops.aws/awsiotforautomotive/en-US>.

<sup>19</sup>More details at <https://aws.amazon.com/pt/blogs/architecture/developing-a-platform-for-software-defined-vehicles-with-continental-automotive-edge-caedge/>.

<sup>20</sup>Developer documentation at <https://autowarefoundation.github.io/open-ad-kit-docs/latest/version-2.0/>.

<sup>21</sup>More details at <https://www.renesas.com/us/en/software-tool/aosedge-platform>.

“align efforts in the SDV ecosystem and create a joint SDV vision clear and unified definition of what constitutes an SDV”, which points towards a brighter future in SDV with greater interoperability [35].

### III. MAIN BUILDING BLOCKS OF SOFTWARE DEFINED VEHICLES

Developing a vehicle within the SDV paradigm (a) requires considerations on several verticals within the context provided by fig. 5:

- **Service Oriented Architectures (b)**, section III-A): how vehicular services are developed and communicate between one another and abstractions for the vehicular service development and for transferring data between services.
- **Virtualization techniques and operating systems (c, d)**, sections III-B and III-C): how vehicular services are deployed within each ECU, including the software stack within each ECU and virtualization techniques..
- **Intra and inter vehicular communication architectures, protocols and physical layers (e)**, section III-D): how vehicular ECUs communicate with each other — intra-vehicular communications — and with ECUs on other vehicles — inter-vehicular and **deterministic communications (f)**, section III-E): how to ensure those communications always happen and within the necessary reliability and timing requirements.

Existing automakers were not agile enough within the development of their vehicular services [37], which lead to the rise of new automakers, such as Tesla, in very software-intensive tasks such as autonomous driving.

The SDV paradigm main ideas are not new. Prior to the advent of SDVs, the automotive industry focus on software was mostly restricted to connectivity between vehicles and the user’s smartphones to provide basic insights into the state of the vehicle [38]. By 1998, [39] considered intelligent vehicles as essential to autonomous transportation, designing a proposal of a vehicle capable of communicating with a centralized management control system. Also in 1998, [40] proposes that smart vehicles are a junction of communication architectures, system architecture, sensors, tasks, kinematics and man-machine interface. The authors propose a communication architecture in a producer-distributor-consumer pattern with buses such as RS232 and CAN, where time coherence is necessary. By 2001, a reference model architecture for intelligent vehicles [41] considered the vehicle as having intelligent control systems with each layer with one or more computational nodes interconnected and connected to sensors.

#### A. Service-Oriented Architecture

With vehicular E/E architectures getting more complex, standards were required in order to model both the ECUs hardware and the software. The AUTOSAR is a initiative of vehicle manufacturers based on design by contract [8], [42] for the development and modeling of vehicular applications through Object Oriented Programming (OOP) concepts. During the

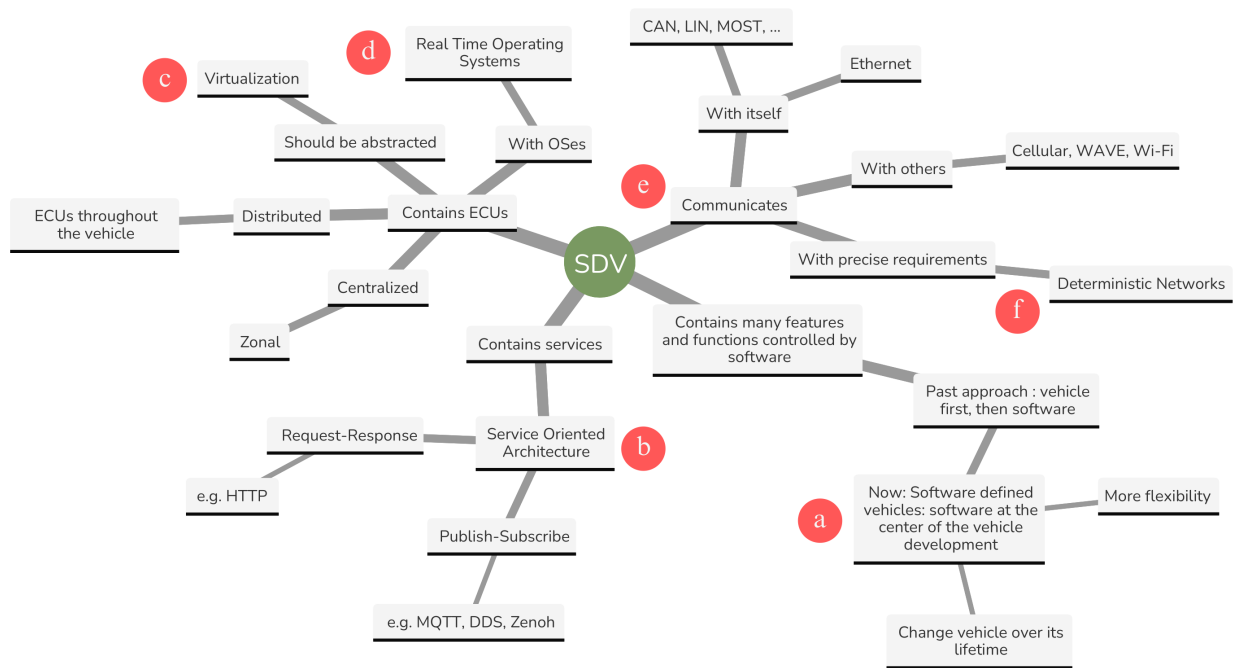

Fig. 5: Overview of the topics involved in modern vehicular development to be referred, lightly based on [36].

2000s this initiative aimed at defining the whole vehicular software stack with support to running several applications and communication with other services through several buses — either CAN, LIN or even Ethernet — through an abstraction of the several hardware possibilities into a Run Time Environment (RTE) [8].

While a very mature *de facto* standard with the support from vehicle manufacturers and vendors, AUTOSAR is a highly complex ecosystem, with more than 100 modules and its documentation reaching more than 21 000 pages [8]. Development through the original Classic Platform is also very hard-coded to the vehicle and its E/E architecture [43]. AUTOSAR has two different types of platforms as depicted in fig. 6: the already mentioned Classic, for traditional hard real-time systems based on micro-controllers with a static configuration, and set of pre-compiled monolithic binaries; but also a newer Adaptive platform, for high performance services and ECUs, with greater flexibility and adaptability to new or changed services. The Classic Platform is aimed at safety critical systems with hard real-time requirements with a stated linkage between services and CPU cores, while the Adaptive is aimed at high performance ECUs [14] and is capable of considering heterogeneous ECUs and departs from legacy buses like CAN towards a SOA communication architecture with Ethernet based on Scalable service-Oriented Middlewae over IP (SOME/IP) as bus protocol [44] and is overall more dynamic but less time predictable [45], [29], essential within critical vehicular systems.

The SOAFEE<sup>22</sup> presents a cloud-native alternative with an architecture enhanced for mixed-criticality automotive appli-

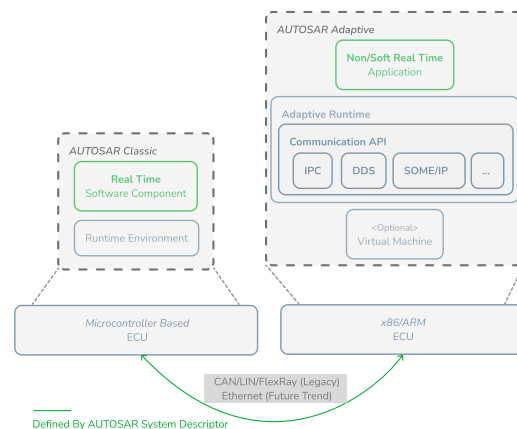

Fig. 6: AUTOSAR Classic VS Adaptive.

cations with corresponding open-source reference implementations to enable commercial and non-commercial offerings.

Each ECU can now part of a SOA, where distributed services interact with one another based on some remote access protocol. In this context, and as defined by [46], a service is “*a mechanism to enable access to one or more capabilities, where the access is provided using a prescribed interface and is exercised consistent with constraints and policies as specified by the service description*”. Figure 7 presents an overview of the SOA paradigm.

Service Oriented Architectures are a software architectural pattern where each component provide and consume services — a discrete unit of functionality — over a predefined protocol over a network. It can be considered an architecture following the main definitions of the Actor Model computational model, since components are decoupled from how the communication

<sup>22</sup>Available at <https://www.soafee.io/>. More details at <https://www.arm.com/blogs/blueprint/cloud-native-automotive-development>

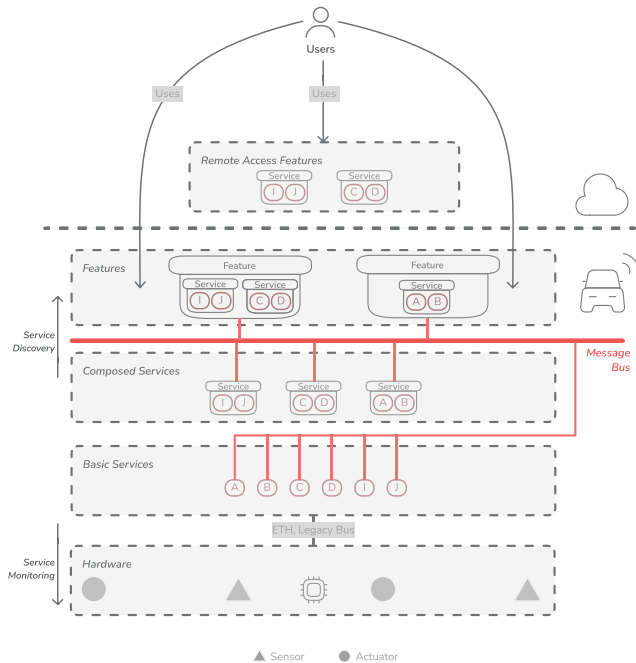

Fig. 7: SOA as perceived by the Renault Group automaker (adapted). Services are the basic unit of vehicular applications, from simple services that directly interact with sensors and actuators, up to more complex services — deployed either in vehicle or in a cloud — that integrate simpler service. Services communicate with one another via one or more message bus [19].

is achieved, allowing asynchronous communication [47]. SOA, when implemented on a vehicle, on a more reduced set of zonal ECUs, bring benefits such as the decoupling of hardware and software, increased modularity and separation of concerns, and contribute towards the overall decrease in hardware complexity. [48]:

At the cost of increased complexity in maintaining contracts between services and ensuring availability and discovery of the services [48]. This is particularly complex within a vehicular context, with a SOA supporting at most 60 to 80 services [24], not addressing situations where there are hundreds or thousands of micro-services.

Within SOA based architectures, data layers can abstract the physical medium of services by providing a unified way of exchanging and accessing data between services on different components/ECUs [49]. Three main design paradigms can be considered for implementing a data layer [50] a) a fully periodic publisher-subscriber based, b) a fully event triggered client-server based, or c) a mixed model, with periodic model for non time-critical chains and event-triggered for time-critical chains.

Information from vehicle sensors can be fed from/to services leveraging the ECUs and their communication paradigm through data layer solutions like DDS<sup>23</sup> middleware,

<sup>23</sup>Available at <https://www.dds-foundation.org/>.

SOME/IP, Constrained Application Protocol (CoAP) or Message Queuing Telemetry Transport (MQTT) [29].

Publish/subscribe paradigms — with protocols such as MQTT, DDS or SOME/IP — can respond to a data centric paradigm, when the data sending is event triggered, unlike solutions such as Hypertext Transfer Protocol (HTTP) or CoAP based on the request/response paradigm [25].

Table II provides a summary on some of the main possible solutions for SOA data middleware. While all these solutions

TABLE II: Qualitative comparison of IoT standards (partially based on [51], [52], [53]).

Standard	MQTT	DDS	SOME/IP	Zenoh	HTTP
<b>Transport</b>	UDP (in MQTT-SN), TCP	UDP, TCP	IP	UDP, TCP, QUIC	TCP, QUIC
<b>Paradigm</b>	Pub / Sub	Pub / Sub	Pub / Sub	Pub / Sub	Request / Reply
<b>Node Discovery</b>	No	Yes (SDP and alternatives)	Yes	Yes	No
<b>Fault Tolerance</b>	Broker is SPoF	Yes, fully distributed by default	Yes	Yes, can be fully distributed.	Client and server are SPoF
<b>Data Schema</b>	None	Required	Required	Only encoding is required	Optional <sup>c</sup>
<b>QoS Policies</b>	At delivery level	At multiple entities <sup>a</sup>	N/A	At 2 levels <sup>b</sup>	N/A

<sup>a</sup> For delivery, presentation, transport, availability, cache, resource management.

<sup>b</sup> For reliability and fragmentation level.

<sup>c</sup> Based for example on the Content-Type.

can ensure delivery of data, there is a tendency to consider DDS and Zenoh the best performant solutions since they provide better flexibility and performance. According to [54], which compared performance of MQTT, DDS, and Zenoh, the latter shows (for multi-machine scenarios, more realistic in zonal vehicular architectures) a double increase on the throughput of DDS and 50 times of MQTT, while DDS usually provides the best latency and better flexibility with more QoS levels.

### B. Virtualization and orchestration techniques

Considering the need for flexibility but also real-time constraints, ECUs can leverage virtualization principles to support multiple operating systems, both real-time and general purpose OSs, through virtualization.

Virtualization provides support for running multiple OSs on the same hardware. It is an essential concept in the context of vehicular systems, since in zonal architectures the number of ECUs will tend to be much less than the number of services and required OSs.



Virtualization allows hardware to be shared and not uniquely assigned to one operating system, while achieving the necessary isolation automakers require between critical and non-critical services. Within the responsibilities of the virtualization layer is the abstraction of hardware and of network topologies [55]. Virtualization also allows to deploy services in heterogeneous platforms and ECUs [56].

Virtualization creates a number of challenges, including:

- **Orchestration:** how to distribute resources (both location and quantity) of the virtualization continuum across virtual machines.
- **Shared I/O:** how to distribute input and output devices, such as Universal Serial Bus (USB) or Ethernet buses, across virtual machines. Allowing virtualized services to use and share the same Ethernet port for example requires a scheduler that is capable of communicating with the different virtual machines and the deterministic network configurator. This communication can be achieved through *hypercalls*, the equivalent of *syscalls* but to invoke a hypervisor [57]. This may impact however the overall frame transmission delays.
- **Virtualization with real-time performance:** since schedulability at hypervisor level is not deterministic [14].

When virtualization is considered, having the scheduler of the traffic can be at either application level, virtual machine level or hypervisor level [56]. At applicational level, since there's one scheduler per application, there are going to be race conditions between each scheduler, with non-deterministic behaviors and therefore providing results with high jitter. At virtual machine level, for example leveraging the *Linux Traffic Control* subsystem, while the necessary configurations are transparent to the applications, the hypervisor will not be aware of the special traffic. Working at the hypervisor level solves the previous issue through special *Hypercalls* invoked by the middleware within the Hypervisor level. *Hypercalls*<sup>24</sup> may be used within the middleware to support deterministic networking within virtualized intra vehicular services [57].

Vehicular OSs such as Android Automotive provides full support for virtualization through Kernel-based Virtual Machine (KVM) and *virtIO*<sup>25</sup> devices, allowing support at the Virtual Machine (VM) side for sensors, graphics, storage, network (including Wi-Fi through *virtio-net* and *VirtWifi*<sup>26</sup>) and with support for communicating with the vehicle through Google RPC (gRPC)<sup>27</sup>.

Generic Linux-based OSs also support virtualization through containerization. Containerized services have advantages over hypervisor virtualization such as the reduced overhead and reduced storage space usage [13].

Eclipse, within the SDV foundation proposes Eclipse Ankaio<sup>28</sup> to “manage multiple nodes and virtual machines

<sup>24</sup>Similarly to *syscalls* concept, *hypercalls* provide an interface between a guest OS and the hypervisor.

<sup>25</sup>Developer documentation available at <https://wiki.libvirt.org/Virtio.html>

<sup>26</sup>Developer documentation available at <https://source.android.com/docs/devices/automotive/virtualization/architecture>.

<sup>27</sup>Details available at .

<sup>28</sup>Developer documentation available at <https://projects.eclipse.org/projects/automotive.ankaio>

with a single unique API in order to start, stop, configure, and update containers and workloads”. Ankaio is tailored towards automotive applications and developed for automotive ECUs and provides a central place to manage automotive applications, supporting:

- Management of multiple nodes and virtual machines with a single unique API.
- Various container runtimes like Podman and also native applications.
- Automotive Software Process Improvement and Capability Determination (SPICE) process with requirement tracing.
- Existing communication frameworks like SOME/IP, DDS or Representational State Transfer (REST) API can be used with Ankaio workloads.

Kubernetes<sup>29</sup>, as a container orchestration tool mainly designed for datacenters, can also be consider to manage vehicular workloads. The work of [58] proposes vehicles as nodes of a Kubernetes cluster.

Apart from its inherent advantages as container orchestration and scheduler, Kubernetes is very flexible in networking terms. Networking between containers can be changed through Container Network Interfaces (CNIs)<sup>30</sup>, a specification for configuring network interfaces in containers. This allows considering deterministic networking concepts — further discussed in section III-E — in container scenarios. For example the work of [59] proposes support for deterministic networking within Kubernetes containers without modifying the application binaries — essential to ensure compatibility with existing vehicle services but also to simplify the development process of new services — through a side car container that exposes the standard Portable Operating System Interface (POSIX) socket interface to other containers and redirects traffic to deterministic configured network interfaces in the host computer. Integration with cloud infrastructure is also possible. For example, within [60] is proposed a full-fledged dynamic interference-aware cloud scheduling architecture for latency-sensitive workloads.

### C. Vehicular operating systems

ECUs within a vehicle run services that require deterministic scheduling from the OS. Failure to have a deterministic real-time scheduling can lead to services being dispatched too soon or too late to the OS, with dramatic effect on the services behavior. Therefore, Real-Time Operating System are a need within vehicular computing domains to ensure services are dispatched in a determined specific order and time-frame. While many OSs can support real-time constraints — including any generic Linux kernel based OS with `PREEMPT_RT`<sup>31</sup> patches [61], some solutions are heavily automotive focused, such as Android Automotive, Nvidia Drive OS and QNX.

<sup>29</sup>Available at <https://kubernetes.io/>.

<sup>30</sup>Project available at <https://github.com/containernetworking/cni>.

<sup>31</sup>Available at <https://wiki.linuxfoundation.org/realtime/>.

Android Automotive<sup>32</sup> and its extensions such as SnapOS<sup>33</sup> provide an OS and a platform that is based on Android — and can therefore leverage the existing application ecosystem — while supporting specific characteristics of vehicles, including the support for the creation of a vehicle abstraction layer required to abstract the vehicle’s specific/proprietary components, UI support for setting vehicle’s settings and OTA updates.

Nvidia Drive OS<sup>34</sup> is the “reference operating system and associated software stack designed specifically for developing and deploying autonomous vehicle applications on DRIVE AGX-based hardware”. It is in fact a custom RTOS with a Nvidia Hypervisor and necessary CUDA and TensorRT libraries to fully utilize the hardware (graphical) potential.

Yocto<sup>35</sup>-based OSs are also a possibility. Yocto supports the creation of custom OS based on Linux, allowing adding custom layers to embedded systems. Yocto based Wind River Linux<sup>36</sup> is an example of such family of OS, providing support for multiple board support packages in both x86 and Arm hardware. Automotive Grade Linux<sup>37</sup> is another example of a Yocto based OS and a industry supported initiative to develop software for the “infotainment, instrument cluster, Heads-Up Display (HUD), telematics, connected car, ADAS, functional safety, and autonomous driving” [62].

Alternative OSs include the VxWorks<sup>38</sup> [63], a RTOS for mission critical embedded systems. While usually considered in spacial scenarios, automotive are also supported for example through the integration with AUTOSAR Adaptive Platform. The QNX<sup>39</sup> is another alternative as a micro-kernel RTOS with extensive foothold in the automotive sector installed in more than 215 million vehicles. Another open source initiative, albeit in initial stages (launched by January 2024), is the Eclipse ThreadX<sup>40</sup>, an open-source, vendor neutral RTOS.

Vehicular services should be developed independently of the RTOS and thus an isolation between the services and the RTOS is desired. Initiatives such as Operating system abstraction layer (OSAL) from IBM<sup>41</sup> or NASA consider “isolates embedded application software from a RTOS” by providing “a well-defined, generic interface to RTOS services”<sup>42</sup> and can, therefore, contribute to the necessary portability of services between RTOS.

<sup>32</sup>Developer documentation available at <https://source.android.com/docs/devices/automotive>. Not to be confused with Android Auto, a platform to use a smartphone as a infotainment alternative.

<sup>33</sup>Available at <https://www.snappautomotive.io/snappos>

<sup>34</sup>Developer documentation available at <https://developer.nvidia.com/drive/driveos>

<sup>35</sup>Available at <https://www.yoctoproject.org/>

<sup>36</sup>Available at <https://www.windriver.com/products/linux>.

<sup>37</sup>Available at <https://docs.automotivelinux.org/>, [https://github.com/nxp-auto-linux/auto\\_yocto\\_bsp](https://github.com/nxp-auto-linux/auto_yocto_bsp).

<sup>38</sup>Available at <https://www.windriver.com/products/vxworks>

<sup>39</sup>Available at <https://blackberry.qnx.com>.

<sup>40</sup>Previously Azure RTOS. Available at <https://threadx.io/>, with developer documentation at <https://projects.eclipse.org/proposals/eclipse-threadx>.

<sup>41</sup>Developer documentation at <https://www.ibm.com/docs/en/engineering-lifecycle-management-suite/design-rhapsody/9.0.2?topic=references-operating-system-abstraction-layer-osal>.

<sup>42</sup>More information at <https://opensource.gsfc.nasa.gov/projects/osal/>.

These operating systems, being mostly RTOS or RTOS-like, can be evaluated through the worst-case execution time for each task, modularity, response time or jitter [64]. At the time of writing, no comparison between some or all of the aforementioned OSs was found, with the choice of OS mostly related to the associated ecosystem (such as already available applications or SDKs).

#### D. Inter- and intra-vehicular communication

Vehicular systems need to communicate both with other systems within and outside the vehicle. While most intra-vehicular communication is expected to be through wired physical layers, this does not have to be the norm. It is impractical to consider wired physical layer for inter-vehicular contexts.

Within inter-vehicular contexts, the Vehicle to Everything (V2X) paradigm, is of increasing importance considering the advent of both Vehicle to Vehicle (V2V) scenarios and smart cities.

The usage of cloud infrastructure is also an integrated part of the SDV paradigm, requiring Vehicle to Infrastructure (V2I) wireless communications. For example, CARIAD, the initiative from the Volkswagen group towards SDVs, launched an uniform application store for all brands within the Volkswagen group [27], that indicates a strong cloud presence within its ecosystem.

While intra-vehicular systems tend to be interconnected with CAN, LIN, FlexRay, or Media Oriented Systems Transport (MOST), they are unsuitable to the higher volume of data and interconnections of centralized architectures. Therefore, existing solutions, such as Ethernet, if associated with determinism mechanisms (further discussed in section III-E), can provide the required time-critical high throughput to both Input/Output (I/O) and control data streams [14].

TABLE III: Overall comparison of main intra vehicular wired buses [14].

Characteristic / Bus	LIN	CAN	FlexRay	Ethernet
<b>Media Topology</b>	1 wire Bus	UTP Bus	2/4 wires Star, bus	UTP Star
<b>Access control</b>	Master-slave	Priority-based messages	TDMA	Switched point-to-point link
<b>Max. Baud Rate</b>	19.2 Kb/s	1 Mb/s, up to 16 Mb/s (XL)	10 Mb/s	10 Mb/s, 100 Mb/s, 1000+ Mb/s
<b>MTU (Bytes)</b>	8	8/64	254	1472 (UDP), 1460 (TCP), 9000 (Jumbo)
<b>Max nodes</b>	16 (1 master)	16 (500 Kb/s)	22 (bus), 22/64 (star), 64 (mixed)	256 to theoretically limited
<b>Security Modules</b>	None	SecOC	SecOC	MACsec, IPsec, TLS/DTLS, SecOC

<sup>a</sup> If disregarding recommended maximum data-rates [4].

CAN has a limitation of 1 megabit per second of data rate, while CAN Flexible Data Rate (CAN-FD) raises the practical

maximum data to 6 megabits per second with a higher 64 byte data field, while keeping the limitations on number of nodes and cable length [14].

While legacy buses like CAN or LIN can and will continue to be on edge intra vehicular systems, such as smaller more specific ECUs, sensors and actuators, the long term objective is the edges nodes to be also connected through Ethernet [65]. In the meantime, automakers aim at integrating legacy CAN or LIN based components by integrating in zonal ECUs CAN controllers or gateways [66].

While these limitations could be overcome in the past with a static analysis of the overall vehicular systems and ECUs, the growing number of features, specially data-intensive features related to (semi) autonomous driving, required an increase in the volume of the overall wiring harness both in terms of number of wires and of complexity (with heavy at least 40-50 kg<sup>43</sup>) now commonplace).

Current LIN bus based solutions also limit the overall system and the number of devices. The BMW group, for example, is working towards an SOA to support for example new solutions of in vehicle ambient lighting [65]. Other buses, such as CAN can support more LEDs, but Ethernet — in conjunction with Time Sensitive Network (TSN) can better support an accurate 20 ms LED update deadline without jitter and necessary synchronizations to support multi LED lighting animations.

In addition, the CAN — and its variations, such as LIN<sup>44</sup> — is based on broadcasting messages. This contributes towards the biggest flaw of the CAN — its fragility to the injection of counterfeit messages<sup>45</sup>. While filtering of messages (at the receiver level) is a possibility, it requires additional implementation on software (increasing the overall development complexity), and does not guarantee the CAN bus capability of handling and delivery other, genuine, messages is not affected [4].

Ethernet, within the context of vehicular networks, is being more and more considered as the backbone connection between high performance ECUs, with gateways to legacy buses like CAN. Several physical layer specifications can be considered, including IEEE 100BASE-T1, 1000BASE-T1, and 1000BASE-RH [67], [68]. Possible Ethernet backbone upgrades to ensure future scalability are also being explored, including 10BASE-T1S or multi-Gb links.

As depicted in fig. 8, there are multiple iterations of Ethernet standards, *i.e.* there's not a single cable and solution for all scenarios. Automakers shall take into consideration the characteristics of the cables (such as width, weight or resistance to heat and vibrations)— and not only the theoretical bandwidth — in order to choose the best ones to interconnect vehicular ECUs.

Common to all the alternatives, Ethernet presents several advantages, including longer payloads, higher bandwidth, the possibility to support QoS or multiple protocol lay-

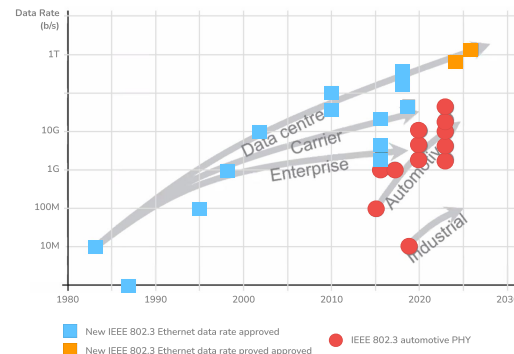

Fig. 8: Evolution of Ethernet data rate and standards over time [68]

ers [66]. Ethernet is capable of greater bandwidth (compared to  $1\text{ Mbit s}^{-1}$  /  $16\text{ Mbit s}^{-1}$  of the CAN / CAN-FD baud-rate) and can transmit data with low latency and jitter [68]. The work of [69] proves the overall better performance of Ethernet than FlexRay in the end-to-end latency for the tested use case (a simulated Electronic Stability Control module).

To this goal, major automakers and their providers have created the OPEN Alliance (One-Pair Ether-Net)<sup>46</sup> initiative. Canonical also defends E/E architectures which combines and consolidates ECUs and interconnects them using an Ethernet network [6]. Such solutions could also benefit from industry grade protocols, such as PROFINET<sup>47</sup>.

Ethernet can be integrated with CAN for example through the CAN-XL protocol. This is done by mapping an Ethernet frame into a CAN-XL frame. Since CAN-XL provides 2048 data bytes, Q-tagged or enveloped Ethernet frames fit into a CAN-XL frame [70]. Examples of gatewaying strategies from CAN to Ethernet has been presented by [71], including FPGA based gateways with suitable latency, routing mechanisms between Ethernet and CAN or FlexRay, with the authors proposing a gatewaying up to the application layer — SOME/IP in this case through a SOME/IP service and a RTOS program that read the CAN messages.

Other alternatives Unlike CAN, FlexRay manages the medium with Time-Division Multiple Access (TDMA). FlexRay has a communication cycle with an explicit stage (the Network Idle Time) necessary to maintain synchronization between node clocks.

FlexRay has the unique ability to sync up nodes on a network without an external synchronization clock signal. To do so, it uses two special types of frames: Startup Frames, and Sync Frames. Like CAN, if not properly configured, may create starvation for some slots of data [72]. This protocol considers a eXtended Markup Language (XML) file format, the Field Bus EXchange, which contains configuration details on a network, including signal definitions, bit-level encoding of signals, information on network topology (*e.g.* information

<sup>43</sup>Source: <https://semiengineering.com/shedding-pounds-in-automotive-electronics/>.

<sup>44</sup>Lower cost bus with just 2 wires (including ground) at the cost of lower throughput.

<sup>45</sup>Example at <https://kentindell.github.io/2023/04/03/can-injection/>.

<sup>46</sup>Available at <https://www.opensig.org/>.

<sup>47</sup>Details at <https://www.profibus.com/technology/profinet/>.

on the ECUs) and configurations (such as baud rates and timings).

MOST is an alternative. The MOST specification defines “the protocol, hardware and software layers necessary to allow for the efficient and low-cost transport of control, real-time and packet data” using “different physical layers (fiber optic, UTP, coax)” and supporting 25, 50 and 150 Mbps data transfer speeds [73].

Vehicular nodes can use different wireless access technologies to communicate with other road elements, including vehicles (V2V), pedestrians (Vehicle to Pedestrian (V2P)), and infrastructure (V2I), creating a Vehicular Ad-hoc Network (VANET), a sub-type of a Mobile Ad-hoc Networks (MANETs). These technologies can be classified based on their communication range [74], with a summary of the main characteristics of the most used access technologies described in table IV.

TABLE IV: Example of wireless vehicular communications access technologies and main characteristics.

Technology	Data Rate <sup>a</sup>	Range	Latency
Cellular (LTE) [75]	100/50 Mbit s <sup>-1</sup>	Long (1 km)	(> 10-100 ms)
Cellular (LTE-A) [75]	3/1.5 Gbit s <sup>-1</sup>	Long (1 km)	(> 10 ms)
Cellular (5G) [75], [76]	20/10 Gbit s <sup>-1</sup>	Long (1 km)	(> ≤ 4 ms)
Wi-Fi (IEEE 802.11be) <sup>c</sup>	≤ 40 Gbit s <sup>-1</sup> <sup>b</sup>	Short (90 m to 2.4 GHz)	(< 10 ms [77] in)
Li-Fi (IEEE 802.11bb) [78]	10 Mbit s <sup>-1</sup> up to 9.6 Gbit s <sup>-1</sup>	Short (few meters) <sup>d</sup>	Low <sup>e</sup>
3GPP C-V2X [79]	≤ 26 Mbit s <sup>-1</sup> [80] <sup>f</sup>	Short to Long	Low
ITS G5 (IEEE 802.11p) [79]	≤ 3 up to 27 Mbit s <sup>-1</sup> [80]	Short (1 km)	(< Low)
IEEE 802.11bd [81] <sup>g</sup>	2× IEEE 802.11p	2× IEEE 802.11p	Low

<sup>a</sup> Downlink / uplink.

<sup>b</sup> Theoretical.

<sup>c</sup> Details at <https://standards.ieee.org/beyond-standards/the-evolution-of-wi-fi-technology-and-standards/>.

<sup>d</sup> As described at <https://spectrum.ieee.org/li-fi-better-than-wi-fi>.

<sup>e</sup> Up to 1 ms as claimed by <https://emag.directindustry.com/2021/07/20/li-fi-shines-as-the-future-of-short-range-communications-light-led-microchip-radio-waveband/>.

<sup>f</sup> Considering Long Term Evolution (LTE) based C-V2X and as claimed by <https://eu.mouser.com/applications/new-v2x-architectures>.

<sup>g</sup> Theoretical values.

Cellular based solutions, either through LTE, Long Term Evolution Advanced (LTE-A) or 5G, can provide connection to other vehicles and infrastructure, with high coverage and medium latency at a high monetary cost [79].

Wi-Fi, including its latest iteration (Wi-Fi 7 / IEEE 802.11be), can also theoretically provide connectivity to and from vehicles, as well as IEEE 802.11bb / Li-Fi. Li-Fi adapts the Media Access Control (MAC) layer of 802.11 while supporting light (visible or infrared) based physical layers in order to overcome interference in dense deployments (which Wi-Fi is particularly susceptible to) and restrictions or inefficiencies of radio frequencies - potentially increasing the maximum. An evolution of the original infrared physical layer proposed in 1999 for IEEE 802.11, it is targeted at the industrial

markets [82]. However, both solutions fail to consider the high mobility of vehicular nodes, which means frequent handovers between access points.

Vehicular targeted standards exist. Cellular Vehicle-to-Everything (C-V2X) is cellular based and aims at integrating cellular technologies within V2V scenarios. Based on cellular standards (5.9 GHz band), it also allows direct device-to-device (ad-hoc) communication with low latency and high reliability, but in short ranges ( $\pm 1$  km), with low cost/free of cost. C-V2X also support device-to-network, enabling cloud services to be part and parcel of the end-to-end solution.

ITS-G5 is based on IEEE 802.11p for physical and MAC layer. It requires existence of road infrastructure — Road Side Units (RSUs) — and that vehicles are equipped with On-Board Units (OBUs). It suffers from problems on handling handovers and scaling to many nodes simultaneously. It is also vulnerable to packet collisions due to concurrent transmissions, and packet collisions due to hidden vehicular nodes.

Existing literature shows that C-V2X offers performance advantages over ITS-G5 in terms of its additional link budget, higher resilience to interference, and better non-line-of-sight capabilities [83].

Radio Access Technology (RAT) evolutions, such as the IEEE 802.11bd and New Radio for C-V2X can supplement today’s vehicular networks in supporting higher bandwidth and QoS wireless communications. IEEE 802.11bd are more suitable for supporting more V2X applications efficiently, with better throughput and low transmission latency. IEEE 802.11bd adapts the physical and MAC layer techniques introduced in IEEE 802.11n/ac/ax, while ensuring interoperability and backwards compatibility with 802.11p. This implies that 802.11bd and 802.11p devices must be able to communicate with each other while operating on the same channel [84]. IEEE 802.11bd also considers re-transmissions, Dual Carrier Modulation and operates also in the mmWave spectrum.

Both ITS-G5 and C-V2X can reliably support safety applications that demand an end-to-end latency of around 100 ms as long as the vehicular density is not very high [85]. However, as the quality of service requirements of V2X use-cases become more stringent, which is the case in many advanced V2X applications [86], the two current RAT fall short of providing the desired performance, since some use-cases require the end-to-end latency to be as low as 3 ms with a reliability of 99.999% [84].

### E. Deterministic inter- and intra-vehicular communication

The usage of deterministic communications and networks that support such communications is vital when considering vehicular services that are somehow critical. Determinism “is the quality or state of being determined”<sup>48</sup>, *i.e.* the quality of being firmly resolved. Within networks this concept can be regarded as the delivery of units of information — either abstracted in frames or packets or other abstraction — in a fully resolved manner in several domains, such as temporal

<sup>48</sup>Definition per Merriam-Webster dictionary, available at <https://www.merriam-webster.com/dictionary/determinism>.

or reliability, in all the steps of the frame/packet from the producer to the consumer(s) of information.

Regarding the temporal determinism, within the exchange of a unit of data between two network entities one may consider the main steps of a packet switching as presented in fig. 9.

Each step introduces delay that, if the network is not properly configured, can be unbounded and potentially even random. Even if high bandwidth is a possibility, transmission, and queuing delays still exist, affecting end-to-end delay [83], [85].

High performance and high precision of services running through a communication network should consider not only techniques to decrease the overall end-to-end latency of data from/to services — for example by leveraging the edge computing concept [88], [89] — but also techniques to ensure the latency requirements and real-time hard constraints are followed. Sets of standards such as TSN<sup>49</sup> and Deterministic Networks<sup>50</sup> can ensure that any critical messages from/to services arrive with high reliability and that arrive at the exact supposed moment [90].

Current solutions to tackle these issues within the TSN and Deterministic Networks are further presented in section III-E. The next subsections present the state-of-the-art on the main initiatives and sets of standards towards determinism in networks in lower Open Systems Interconnection (OSI) layers. These initiatives started for wired mediums such as Ethernet but can also be extended to wireless contexts.

1) *In wired context:* Methods towards achieving deterministic communications within a wired context — such as the connectivity between vehicular ECUs — are being standardised, with two major initiatives to be considered: the Institute of Electrical and Electronics Engineers (IEEE) TSN set of standards, operating at OSI layer 2; and Internet Engineering Task Force (IETF) Deterministic Networking (DetNet) operating at OSI layer 3. The next subsections will focus on both initiatives that shall be seen not as competitors but as complementary initiatives.

**Deterministic Networking (IETF DetNet)** The IETF Deterministic Networking set of standards aim at defining deterministic — *i.e.* with bounded latency, loss and jitter — paths for the packets [91]. Those standards operate at layer 3 on a SDN approach, where one or more controllers are responsible for defining the nodes behavior, to warrant [92]:

- Explicit routes: to ensure deterministic routing. This may be achieved for example through the usage of Multiprotocol Label Switching (MPLS), a routing technique based not on network addresses but labels.
- Resource allocation: to ensure protection against congestion, resources (such as bandwidth) is allocated.
- Service paths: to ensure protection against equipment and medium failures packets are replicated through disjoint paths.

Table V provides an overview on the Request for Comments (RFC) standards and documents that define the goals, use cases and building blocks behavior.

TABLE V: Main DetNet standards, specifications and documents.

Document	Goal	Importance
RFC 8557	Problem statement	Contextualizes the need for DetNet with the need for a deterministic forwarding of packets.
RFC 8578	Use cases	Validates self-driving vehicles as examples of use cases that can be addressable by DetNet techniques.
RFC 8655	Architecture	Defines the main building blocks of DetNet.
RFC 8938, 8939, 9023, 9025, 9056	Data Plane	Defines how building blocks may be implemented and metadata that packets require. Includes information of integration with TSN and MPLS for explicit routing.
RFC 9016 YANG model (draft [93])	Flow information model	Modelling of the configuration information for configuration of DetNet building blocks.
RFC 9055	Security	Considerations on security, including challenges posed by replication of packets and spoofing.
RFC 9320	Bounded Latency	Provides mathematical modelling of the bounded latency values for a DetNet architecture.

The DetNet building blocks operate at the Internet Protocol (IP) layer and use lower-layer technologies such as MPLS and TSN (further discussed in section III-E1). These building blocks can and should be controlled based on observable metrics (hops, their state, and end-to-end latency), and on fault detection/prediction and identification [92].

Two open questions remain: (1) whether DetNet protocols will include a way for an application to communicate expectations regarding such timing properties to the network and (2) if so, whether those properties would likely have a material effect on network performance as a result [94].

**Time Sensitive Networking (IEEE TSN)** The Time Sensitive Network group presents an effort to solve transmission, and queuing delays issues, by adding to Ethernet time characteristics, performance, reliability, and security. Mechanisms include time synchronization (gPTP [86]), replication and elimination for reliability (e.g. Frame Replication and Elimination for Reliability (FRER)) [95], and bounded low latency (such as credit-based [96] or time aware shaping algorithms [97]) that can provide the necessary real-time performance and bounding of the latencies [98], [99], [100].

Table VI provides an overview on the IEEE standards and documents that define the goals, use cases and building blocks behavior. The TSN standards are an evolution of existing standards, the Audio Video Bridging (AVB) standards, dedicated to extending the Ethernet standards to provide guaranteed quality of service by ensuring high precision time synchronization between nodes, bounded latency of high throughput streams (at  $\mu\text{s}$  scale) and reservation of bandwidth within audio and video scenarios. The TSN toolbox of standards add reliability concerns, more accurate clock synchronization, bounded low latency even for real-time streams (at  $\mu\text{s}$  scale) and security concerns [101]. As a comparison, “the design goal of the AVB was a maximum latency of 2 ms over 7 hops in a 100 Mbit s<sup>-1</sup> network for audio and video traffic”, while TSN standards set “the goal to set the maximum latency to 100  $\mu\text{s}$  over 5 hops” [102]. Through the IEEE 802.1Q standard three types of traffic classes for such traffic are defined — Scheduled Traffic

<sup>49</sup>Details at <https://1.ieee802.org/tsn/>.

<sup>50</sup>Details at <https://datatracker.ietf.org/wg/detnet/about/>.

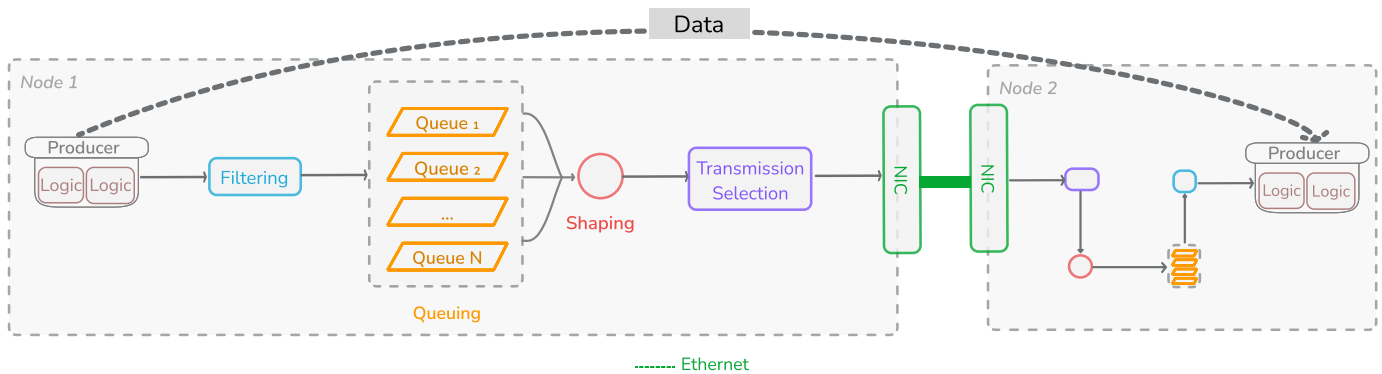

Fig. 9: Main steps of a packet switching. Partially adapted from [87].

(with precise scheduling), Stream Reservation (which needs to be configured in order to ensure fairness) and Best Effort [56].

TABLE VI: Main TSN standards [103] (partially adapted).

Document	Goal	Importance
802.1Qca	Path control and reservation	Define mechanisms to allocate resources to transmit frames.
802.1Qbv	Time-aware scheduling	Defining when and what frames are sent by the emitter.
802.1Qbu, 802.3br	Frame preemption	Defines the possibility of higher priority frames interrupting lower priority, essential in ensuring precise transmission time for higher priority flows.
802.1Qcc	Central configuration model	Defines the need for coordination nodes (the CUC and CNC). Updates on the SRP protocol.
802.1Qci	Filtering and policing	Defines mechanisms to count and filter frames and detect and mitigate disruptive flows of frames.
802.1CB	Redundancy through frame replication and elimination	Defines mechanisms to replicate frames and manage the repeated frames to increase reliability of the network and avoid equipment failure impacting PER and similar metrics.
1588, 802.1AS	Precise ( $ns$ level) time synchronization between nodes	Defines mechanisms for a nanosecond synchronization between clocks of several network nodes.
P802.1DG (draft)	TSN profile for automotive in-vehicle Ethernet communications.	Recommendations for TSN implementation within vehicular architectures.

In conjunction to DetNet, but operating at OSI layer 2 — and originally on top of wired Ethernet networks — the IEEE 802.1 Time Sensitive Network set of standards provide mechanisms for [103]:

- Time synchronization: applications and other network mechanisms require a precise (down to nanosecond accuracy) synchronization between the nodes of the network. Protocols such as Precision Time Protocol (PTP) [86] can provide such precision within wired and wireless networks. Synchronization should have into mind the physical layer latencies and their variations since they can affect the propagation delay measurement and the overall sync time accuracy. IEEE 802.3cx proposes a mechanism to report the physical layer delays in a dynamic way [104].
- Replication and elimination for reliability: improve the reliability by ensuring frames of information are replicated and sent through disjoint paths. This replication needs additional mechanisms to ensure repeated frames

are ignored. Protocols such as FRER [95] can manage this replication.

- Resource management: Mechanisms to ensure the configuration of TSN talker, listener and of equipment between both.
- Bounded latency or bandwidth: ensure the bandwidth or latency and its jitter is deterministic by ensuring transmission happens at a specific time. Traffic shaping can provide the necessary real-time performance and bounding of the latencies or bandwidth [98], [99], [100], with shapers such as:
  - Credit Based Shaper (CBS) [96] based on regulating the transmission rate of frames to smooth out traffic, reduce bursts and ensure bandwidth for certain traffic classes, by delaying the transmission of some frames. When the queue contains a frame to be transmitted, a credit counter is checked and the frame is only transmitted if the counter is non-negative (and if it is, is held back until is non-negative). This counter accumulates credits when the transmission queue is idle, and consumes credits when frames are transmitted, with the rate of accumulation and consumption configurable via parameters (*idle slope* and *send slope*)<sup>51</sup>.
  - Time Aware Shaper (TAS) [97] that works by associating the data to traffic classes and the traffic classes to gates that open and close at specific times and for specific intervals of time, ensuring no unwanted competition between traffic classes that should not compete for transmission, therefore eliminating the jitter associated with that competition [105].
  - Asynchronous Traffic Shaping (ATS), which is based on the leaky bucket principle, with transmission allowed when credit is greater than the size of the frame [102].

How the network should be configured is also addressed through the IEEE 802.1Qcc standard, which describes three possible models [106]:

<sup>51</sup>More details at <https://inet.omnetpp.org/docs/showcases/tsn/trafficshaping/creditbasedshaper/doc/index.html>.

- A fully distributed model where all the end stations communicate their requirements — through protocols such as Stream Reservation Protocol (SRP) or Resource Allocation Protocol (RAP).
- A centralized network/distributed user model, where the Centralized Network Controller (CNC) gather the network capabilities.
- A fully centralized model, where the CNC is helped by the Centralized User Configuration (CUC) to ensure proper network equipment configuration.

These three models are based on the existence of two entities — the CNC and the CUC. The CNC defines the overall network schedule and is the main controller of the network within the network bridges, dispatching configuration with protocols such as Network Configuration Protocol (NETCONF). The CUC mediates the requests between end devices and their applications [107], collects all user requirements and interacts with the CNC to decide the topology and scheduling of the network. Figure 10 provides an overview of these interactions.

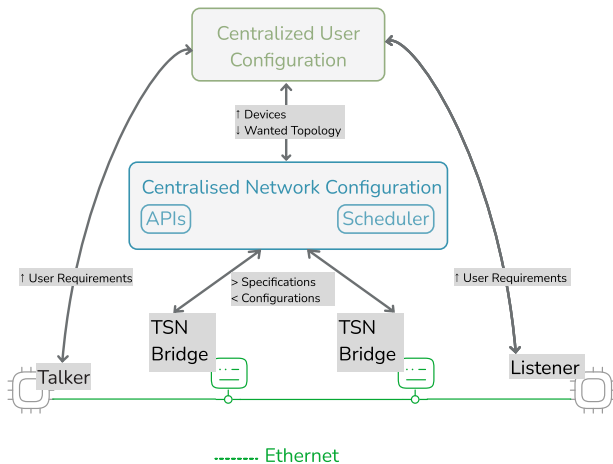

Fig. 10: Interaction between CUC, CNC and the remaining TSN topology [107].

TSN is not however the only standard at layer 2 for deterministic communications. Time-Triggered Ethernet (TTEthernet), a standard for industrial and avionics applications improved from the Avionics Full Duplex Switched Ethernet, can be a standard to consider [14]. While the concepts of deterministic timing of the transmission of frames is inherently the same, both differ in a number of aspects [108], [109]. TSN is a set of standards while TTEthernet is a specific Society of Automotive Engineers (SAE) AS6802 standard. In the former, the schedule is on entire traffic classes, while in latter is on individual frames. In addition, TSN supports lower-priority traffic using non-used bandwidth, while TTEthernet blocks other traffic even when there are no time-scheduled frames to transmit results in efficient use of bandwidth.

2) *In wireless context:* While wired network access mediums have well defined / bounded error rates, based essentially on the electromagnetic noise ratio, wireless mediums are prone to the creation of unpredictable non-stochastic jitter

and packet losses through additional issues and challenges, including [103]:

- Fading of the transmission: based on distance between nodes, changes in the propagation environment or node mobility.
- Interference from other devices communicating on the same spectrum frequencies. This issue is more pronounced when unlicensed spectrum (*e.g.* 2.4 GHz) is used since its usage is uncontrolled and prone to additional noise from other uncontrollable entities.
- Shadowing and attenuation from other physical obstacles and phenomena (*e.g.* reflection, absorption, diffraction) [110].
- Random channel access latency: the randomness associated with existing listen-before-talk procedures for multiple access to the wireless channels contributes to non-stochastic delays.
- Integration of synchronization mechanisms: while considering the differences in propagation time in wireless communications.
- Bounding an end-to-end latency or its jitter by integrating scheduling on transmission by each Access Point (AP).
- Integration of reliability techniques while considering and taking maximum advantage of the main different channel characteristics.
- Resource management: including the usage of several APs for reliability or the dynamic management of the spectrum used at a given moment, which remain open challenges.

Achieving determinism within a wireless communication requires that all these challenges are properly addressed.

While fading, interference, shadowing and attenuation are mostly unavoidable without changes to the physical environment, interference can be minimised. The usage of other parts of the spectrum, possibly licensed, with wider channels, and frequencies in multiple links working in conjunction (multi link operation) can further decrease the overall noise within the physical layer and therefore decrease the jitter of latencies, and increase the determinism of the communications [103]. In addition, a periodic analysis of the spectrum usage can support a decision on the best frequencies to be used.

Regarding the unpredictable time to access the wireless medium, existing listen-before-talk solutions such as Carrier-Sense Multiple Access (CSMA) consider that in the event of a collision, before re-transmission a random amount of time shall be waited. This creates an unpredictable, non-deterministic jitter on the transmission of information. Other channel access solutions must be considered in order to achieve higher determinism on the transmission of the frames through both a wired or wireless medium, such as dividing the channel per frequency, time or both — Frequency-Division Multiple Access (FDMA), TDMA and Orthogonal FDMA (OFDMA), respectively — or adding scheduling algorithms to listen-before-talk solutions [111] — CSMA-Collision Avoidance (CSMA-CA). In alternative, solutions that consider collisions to be solved at the receptor side — *e.g.* Non-orthogonal Multiple Access (NOMA) — can also be considered.

Another promising solution is a coordination and scheduling of the access to the wireless medium to ensure not fairness or throughput — the usual concerns — but the fulfillment of a specific time of transmission, ensuring more determinism than the previous approaches [103].

Within wireless mediums, the usage of the IEEE 802.11be (Wi-Fi 7) concept of restricted Target Wake Time (rTWT) — originally introduced for power saving — can further decrease conflicts during transmission. By defining when a certain station cannot transmit — and therefore any transmission ends before the start of this time — it is possible to further decrease collisions between critical and less critical frames being transmitted simultaneously.

Projects such as PREDICT-6G [112] and DETERMINISTIC-6G [113] defend that, since the wireless environment has a non-stochastic jitter that is unavoidable (at the very least because of fading, interference, shadowing and attenuation), any system should adapt to those variations. Such adaptation can be done through online (in runtime) prediction of the variability of latency and jitter through monitoring of the system and prediction on Key Performance Indicators (KPIs) (e.g. instantaneous availability) to then act on resource allocation and schedules. To support this prediction, models of the channel behaviour can be considered to model the performance of the channel based on the medium conditions, transmission power, an angle or distance between nodes. Such models are not a one size fits all solution, with each different environment requiring a different analysis [103].

Regarding the integration of synchronization mechanisms, the IEEE 802.11 standards provides time synchronization capabilities through a mechanism named Timing Synchronization Function (TSF) that supports a low precision synchronization with a maximum of 1 second of accuracy [114]. The TSN standard for high precision synchronization, the IEEE 802.1AS (PTP) defines a profile for 802.11 mediums [103] that considers within the synchronization of the clocks an estimation of the propagation delay and based on the number of neighbours of the nodes.

Regarding the bounding of end-to-end latency and jitter, the integration of shaping techniques, namely TAS/802.11Qbv or ATS is possible. Solutions for integration include mapping the scheduling policies to each transmission queue within an AP and by adding to each frame fields with the flow identification and characteristics (delay bound, maximum packet size) to map the scheduling policies to the 802.11be MAC. The overall scheduling requires a full knowledge of the network topology.

Regarding reliability, including FRER (TSN standard IEEE 802.1CB) through redundant wireless links and channels is possible. The usage of several APs, with the necessary seamless predictive handover between APs, remains however an open challenge [114]. In addition, management of the transmission power can further improve the reliability by decreasing the impact of interference and obstructions in the transmission.

Finally, regarding the resource management, the need for some sort of centralization in decision making for the configuration of the network nodes — APs and switches — is supported both by TSN and DetNet standards. TSN

IEEE 802.1Qcc standard define that 2 entities — the CUC and CNC — are responsible for monitoring and defining resource allocation and configurations [114], while the DetNet Reference Architecture [92] considers the existence of a Controller Plane responsible for “topology discovery and maintenance, packet route selection and instantiation or path fail-over mechanisms” [115]. An architecture should therefore consider the existence at least of a controller that configures and monitors the network nodes and the information flow.

All the previous points can benefit from more flexibility and performance with a deployment using FPGAs [116]. FPGAs, by allowing the reconfiguration of the hardware to fit the needs of the application(s), can support the deployment of new wireless APs that combine the previous techniques accelerated by hardware. Such acceleration is essential to ensure the processing times are sufficiently small to allow determinism in the overall communication.

Examples of such hardware assisted solutions is the `openwifi`<sup>52</sup> stack or the work in [117], which introduces a custom 802.11 and TSN inspired solution that allows ultra low control cycles (within 100  $\mu$ s), reduced jitter (within the ns barrier) and low Packet Error Rate (PER) (less than  $< 10^{-7}$  for distances to the AP between 6 m and 12 m and  $5 \times 10^{-6}$  for distances greater than 23 m) through a FPGA implemented solution for APs. Each node contains several modules implemented in a FPGA:

- Timer: used by the scheduler, is synchronized by an external Pulse Per Second (PPS) signal.
- Scheduler: operating at level 2, decides which frames should be sent and when are they due.
- Custom MAC: contains information for controlling frames, with changes from the original 802.11 access scheme to avoid collision between real-time and non-real-time frames and support the synchronization between clocks.
- Physical layer: The encoder/decoder and additional hardware modules required for modulation features.

A promising solution that however lacks full testing in mobility scenarios, integration with TSN and integration with other wireless standards such as 5G-NR. Such integration with cellular communication technologies is possible. 3GPP Releases 16-18 defends that, ensuring ultra reliable and low latency communications start at the radio level. TSN standards should be added to the overall architecture, with parts of the 5G core acting as TSN bridges [114], one per 5G User Plane Function (UPF) [118]. This allows a transparent integration of 5G systems with a TSN system but require a set of translators between the 5G control plane and TSN standards [119].

The configuration of the TSN network is based on the 5G configuration, with the mapping between the TSN network configurations [120] — such as priorities or TAS gate opening times — and 5G QoS parameters — such as the 5G QoS Identifier (5QI), a scalar that represents characteristics such as [118], [121]:

<sup>52</sup>Source code available at <https://github.com/open-sdr/openwifi>.



- Resource Type: Guaranteed Bit Rate (GBR), Delay Critical GBR (DC-GBR) or non-GBR, where the first two can pre-allocate resources.
- Priority Level: indicates a priority in scheduling resources. Can be used to prioritize the allocation of resources to certain flows.
- Delay Budget: an upper bound of the time a packet can spend inside a 5G system (between the User Equipment (UE) and a UPF) without being dropped.
- Packet Error Rate: a ratio between the number of received packets and the number of transmitted packets.

The algorithms for mapping the TSN configurations to 5G configuration values are current research topics. The work of [122] proposed mapping the default priority value of a 5G frame to the Priority Code Point (PCP). Other work by [123] consider that TSN frames shall be considered DC-GBR, while [121] propose the mapping of TSN traffic into 5G QoS 5QI characteristics. For example, the *resource type* characteristic is derived from the type of TSN flow: deadline constrained, jitter constrained or bandwidth constrained, per the truth table in table VII, with similar analysis for the other characteristics within 5QI.

TABLE VII: Mapping between TSN flow characteristics and 5QI values by [121].

Deadline	Jitter	Bandwidth	GBR	DC-GBR	Non-GBR
0	0	X	0	0	1
0	1	0	1	0	0
0	1	1	0	1	0
1	0	0	1	0	0
1	0	1	0	1	0
1	1	0	1	0	0
1	1	1	0	1	0

While most current work is towards exploring future industrial integration between 5G and TSN [119], real applicability remains limited. This is partially due to the lack of interoperability between 5G and TSN-capable equipment, with configuration usually considering propriety mechanisms or at least standard mechanisms with exceptions [106]. In fact, according to [106], no tool has been contributed within the TSN-5G interaction, with most work regarding high precision synchronization support — which 5G network support through IEEE 802.1AS with a time error limited to 900 ns [119] — and proof-of-concept architectures and mathematical analysis. A notable exception is the work by [124] which presents “a prototype 5G system integrated with a TSN network for a typical industrial mobile robotics use case”. The prototype is based on commercial solutions for a 5G system and TSN switches for deterministic communications between an application in the factory cloud and a mobile robot for a factory floor environment. Results of such integration were promising, with end-to-end latency below 0.8 ms and, more importantly, with a 99.9% reliability and jitter in the order of 500  $\mu$ s.

The integration of deterministic communications is not exclusive to TSN standards. DetNet standards can be used in conjunction with TSN standards to provide both upper and lower latency boundaries (while TSN can only ensure an upper bound), better scalability and interoperability with existing IP

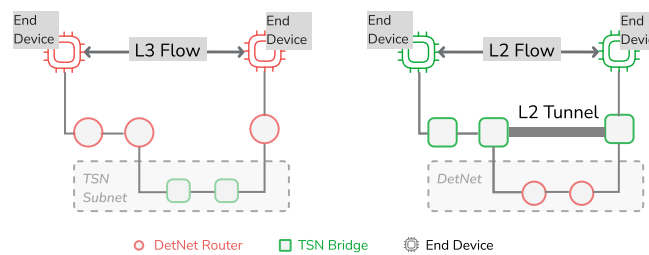

Fig. 11: Examples of integration of TSN and DetNet may be considered within a 5G system [125].

infrastructure (since it acts on OSI layer 3) [125]. Both sets of standards can act simultaneously, with [125] proposing that each TSN domain would be mapped into a subnet (or a tunnel) of a DetNet network, as depicted in fig. 11.

3) *In vehicular context:* Solutions to adopt TSNs within the vehicle’s systems are sparse and moreless recent, with some of the oldest integration within vehicular systems in 2016 [126], and further integration in recent years [127], [128], including with 5G [129], [130]. In addition to 5G, both wired and wireless technologies based on IEEE 802.11p or IEEE 802.11bd should be considered within these networks, ensuring that service(s) can communicate with the vehicle’s systems and surroundings with reliability and redundancy.

The challenges on TSNs within vehicular contexts are two-fold: for one, the automotive use case is a critical scenario, which requires well defined latencies, ordering and high level reliability; on the other side, the high dynamism of the intra and inter vehicular topology — each vehicle may have a different set of sensors and actuators, creates the need for a more **automatized** TSN configuration that can be adapted to different streams.

The work of [131] discusses how to characterize the traffic — frame size, period, deadline constrains, priority, proportion of streams and how to analyze efficiency — overload analysis, scheduling analysis, and spacial complexity/memory usage. This can be a basis for a TSN configurator to decide the mapping between the streams within the vehicular network and the necessary TSN shapers configurations.

Not only TSN has to be properly configured, but interoperability with other protocols must be assured. Ethernet with TSN must coexist and be interoperable between with other wired and wireless access technologies, including legacy automotive standards such as CAN. The synchronization strategies between the vehicular Ethernet backbone and CAN sync is current investigation by [19], [71], with three strategies to consider:

- Periodic snapshot: periodically all original frames are mapped unto 1 or more frames of the destination bus. Within this solution, the main challenge is the computation of the period of snapshot, specially in asynchronous traffic.
- 1:1 Packing: in this solution, 1 frame from the original bus is mapped onto 1+ frame of the destination bus. This may mean unused space in a frame, particularly in the direction CAN to Ethernet, since the maximum size of

a CAN frame is 108 bit<sup>53</sup> vs 1500 B for the Ethernet Maximum Transmission Unit (MTU).

- **All packing:** in this solution, all CAN frames up to a point (functionally defined) are grouped into 1 Ethernet frame. This solution optimizes the usage of MTU of Ethernet vs the 1:1 packing solution.

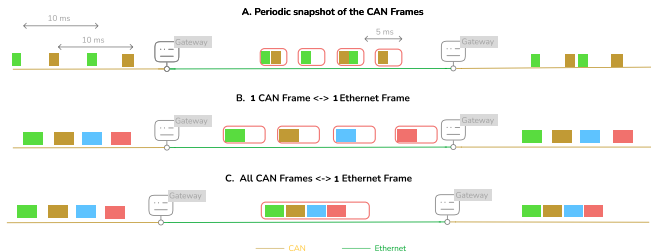

Fig. 12: Examples of CAN from and to Ethernet Gatewaying Strategies [19].

#### IV. OPEN CHALLENGES

Per the current state-of-the-art, it is essential to create tools to support a more agile service development, that considers the services requirements in terms of bandwidth, safety, criticality and timing of delivery of its information, while ensuring a interoperability and modularity to support (almost) any vehicle. These tools shall take into account not only the orchestration of those services throughout the vehicular zonal E/E architecture and its ECUs but also the network interconnecting those ECUs and connecting the vehicle to other elements on the smart city road. Therefore, deterministic communications and its standards, tendentially and historically thought for static well-known environments, need to be able to be dynamically configured to support the highly dynamic environment within vehicles and their equally dynamic surroundings.

The previous subsections focused on specific parts of the vehicular stack - either middleware, Operating System and virtualization techniques. All these parts need to be configured properly in a holistic way to ensure the services are deployed properly. The work of [32] emphasizes the need for configurations and reconfigurations of the whole vehicular stack to be dynamic, from the subjacent bus (such as Ethernet), up to the configuration of the ECUs and services. Such reconfigurations require the integration of multiple levels of configuration — from deterministic networking standards to the appropriated SOA protocols to higher level as described in fig. 13.

Other challenges include:

- 1) **Agility of service development:** simplify and harmonize vehicular development processes — (almost) everything as software and software processes.
- 2) **Data driven:** vehicular architectures should be data driven in order to process great quantities of data from camera/lidar/sensors streams in use cases like autonomous driving [132].

<sup>53</sup>Considering standard CAN as described in <https://www.ti.com/lit/an/sloa101b/sloa101b.pdf>.

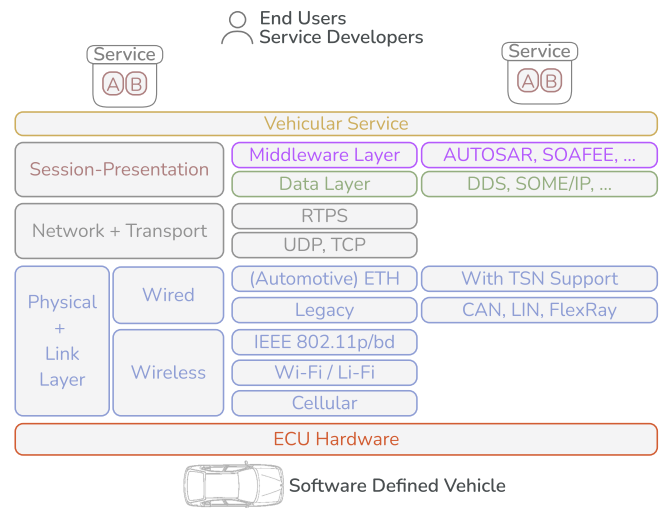

Fig. 13: OSI layers to have into consideration for an automated configuration of the whole vehicular stack [32].

- 3) **Safety issues:** following zero trust policies is essential.
- 4) **Resource orchestration:** leverage the unused resources — but not necessarily on a in-vehicle point of view, while considering costs and capabilities (CPU bound, I/O bound) from the hardware into the scheduling and orchestration.
- 5) **Interoperability:** multi-vendor, multi-hardware and multi vehicle interoperability.
- 6) **Modularity:** towards a more manageable stack where automakers don't do everything.
- 7) **Next-gen storage:** consider cloud storage and solutions such as InterPlanetary File System (IPFS) towards use cases such as OTA updates.
- 8) **Clustering:** support the clustering of ECUs and the deployment of vehicular services across clusters, with reinforcement learning to choose the best node affinity.
- 9) **Automatic generation of design architectures:** computer generated architectures for zonal vehicular ECUs
- 10) **Legacy compatibility:** solutions to integrate ECUs interconnected with deterministic communications in a zonal SOA architecture.
- 11) **Virtualization and automatic scheduling:** reallocate workloads depending of resources with general purpose hardware and virtualized infrastructure.
- 12) **Digital twin:** standardize the vehicle state representation [32].

Considering the current state-of-the-art, the main challenges of TSN and deterministic networks within vehicular contexts include:

- 1) **Easy to use/plug and play:** Auto-configuration of parameters for TSN shapers based on the number, characteristics of ECUs and workloads. For example [57] propose a TSN platform abstraction layer and set of API for applications to send/receive frames. The API was responsible for managing flow registration, transmit and receive Ethernet frames, creating the Ethernet frames, configuring the Ethernet port and scheduling frames to

the appropriate queue.

- 2) **Integration of TSN within wireless networks:** Some efforts are being done, but it is current work as discussed in section III-E2 [133].
- 3) **Built-in time awareness:** at the link layer — at the applicational level is more resource intensive, while at link layer could even be accelerated by FPGAs.
- 4) **TSN shaper automatic selection and configuration:** automatic generation of necessary configurations, with reinforcement learning as a possibility to choose the best configurations.

The next sections will focus on discussing potential use cases that may benefit from such solution and strategies, while also discussing the proposed solution for a more agile service development, and tools for its evaluation.

## V. POTENTIAL USE CASES

Vehicular services within an SDV context can benefit both intra-vehicular functions and occupants — both driver and passenger — as well as other vehicles and the overall smart city environment. Figure 14 lays out the main areas of use cases where the SDV paradigm may be useful.

With the SDV paradigm, the vehicle may send the information about its occupant to other subsystems, or vehicles through communications, which must be deterministic in order to ensure the information is obtained not too soon nor too late, therefore risking lives.

In all described use cases, the SDV paradigm supports some adaptability of the vehicle to the occupants' characteristics and state to support some automated action (instead of a manual process). The occupants, either driving or passengers, can greatly benefit from services for customization of vehicular functions, protection, monitoring, and companionship.

When considering areas of use cases for SDV, one can consider both the drivers — for which most use cases, including autonomous driving, tend to focus on — and occupants. Both can benefit from vehicular technology that adapts to each occupant while increasing their autonomy and fostering their dignity. Software-Defined Vehicle can use the existing sensors and actuators on vehicles to support new services to support drivers and occupants in situations automakers could not predict during their design phase.

The following subsections present some use cases that are envisioned as possibilities to validate the system(s) to be researched — **intra and inter-vehicle deterministic use cases and critical non-active safety use cases** that require adaptability — both at software level but also at the network level (while ensuring reliability and bounded latency).

Table VIII provides an overview of the main requirements envisioned for the use cases. Use cases can be characterized by several types of requirements. The work of [134] define several vehicular use cases and their characteristics in terms of deadline (soft/hard and interval), data complexity (simple/complex and large) and pattern (discrete/continuous).

The classification of vehicular services based on their required level of abstraction (from signal processing up to behavior decisions), temporal layer (from cycles of 1 ms to

50 ms) and spatial layer (from communication between sensors up to global communication scenarios) is proposed by [137]. These criteria can be used within a descriptor file for the service to support selecting the best technologies/stacks.

All these use cases require  $N$  time critical services and  $K$  services, allowing to prove the need for orchestration and schedulability of intra- and inter-vehicular services. In all these use cases, a certain vehicular service can either be fully deployed on one or more node or divided through multiple nodes / cluster of vehicles, with both scenarios considering the cloud as an option.

Also common to all use cases is their need for time criticality. While the use cases do not necessarily focus on controlling the critical systems intra-vehicle such as power-train and braking subsystems, they are essential for other passive safety functionalities. For example, **the systems to be researched are not going to actuate on the brakes for collision avoidance, but might want to warn cars behind to slow down because there is a disabled person in the car.**

### A. Towards autonomous driving for all road situations

While autonomous driving is a current and future trend with great focus from automakers, **its adaptability to all road and traffic situations is an open problem.** Current solutions can handle open road or highway contexts, but higher density (e.g. urban) contexts require a more cooperative approach to autonomous driving, with vehicles sharing all the information they possess and coordinating manoeuvres.

**Context Aware Maneuvering** Vehicles may consider cooperative manoeuvres between non-autonomous vehicles and/or autonomous vehicles to ensure complex manoeuvres are done with no harm.

For example, within the context of the cooperation between public and private transportation, a service can be considered to give priority to bus, ambulance or other public transportation to enter a certain crossroad instead of a privately owned vehicle. This service shall be dynamic and consider several potential alternatives, including scenarios where the proprietary vehicle must in fact stop in order to prevent an accident. The service(s) to decide each vehicle's action require a minimized bounded latency to receive information on the road situation and to send information with the proposed action to other vehicle(s).

When considering the air mobility paradigm, in particular electrical Vertical Take Off and Landing (eVTOL) vehicles, the cooperation between vehicles gain an additional importance. New scenarios shall be considered, including cooperation between vehicles and between the eVTOL and the road infrastructure — such as landing pads [9] — to ensure no accident occurs during take off or landing, even in bad visibility (by occlusion or lack of lighting). In these scenarios coordination between vehicles and infrastructure can avoid a catastrophic air accident between the vehicles or a crash on top of property or people.

Considering the importance of working towards autonomous driving for everyone, it is vital to ensure that each autonomous driving vehicle is capable of creating the best possible decision

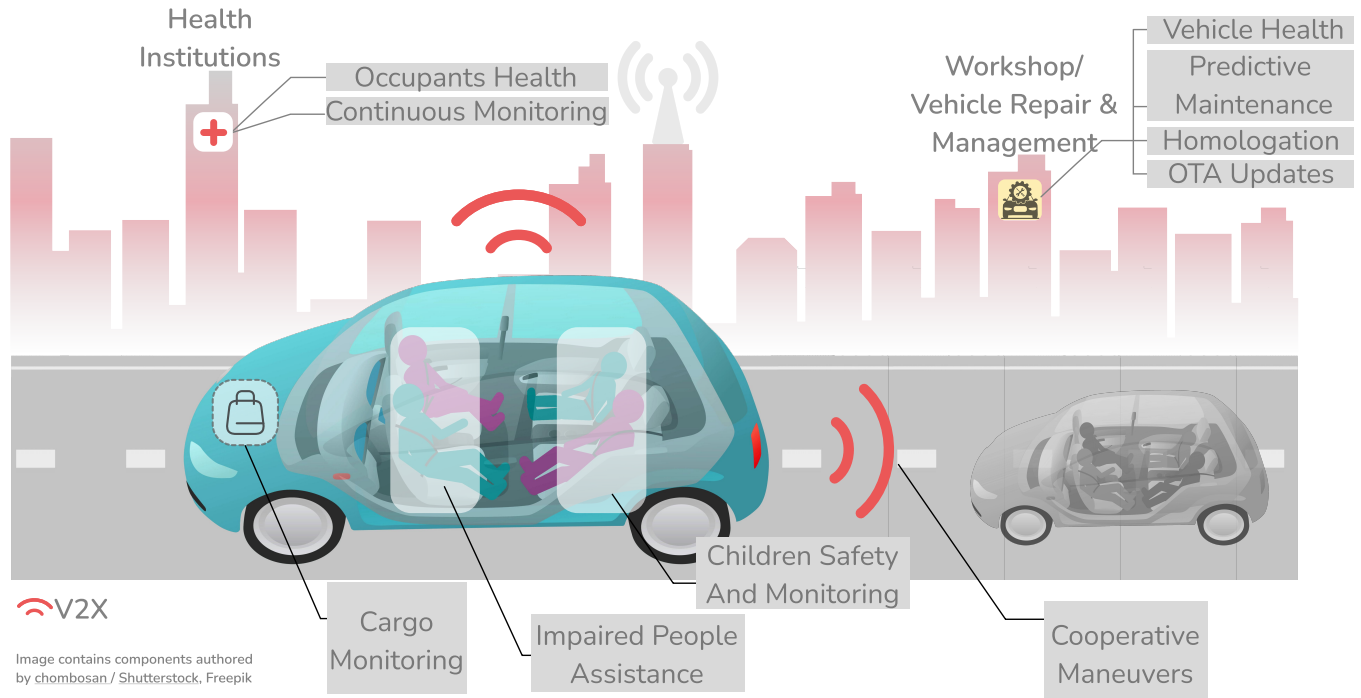

Fig. 14: Overview of the potential use cases.

TABLE VIII: Main requirements for the possible use cases (based on [135], with adaptations)

Use Case	Range	Information size	Latency	Reliability	Velocity	Node density	Positioning	Pattern
Cross Traffic Left Turn Assist	350 m	1000 bytes / message <sup>a</sup>	10 ms	99.9%	33.(3) m/s <sup>b</sup>	1500 /km <sup>2</sup>	1 m for lane accuracy	Discrete
Software Update	<100 m (V2V)	<10 GB / day <10 GB / hour (urgent)	None / 30 s (V2V)	99%	25 m/s <sup>c</sup> ; 70 m/s <sup>d</sup>	<1500/km <sup>2</sup>	30 m for street/road accuracy	Discrete
Remote Vehicle Health (e.g. predictive maintenance)	N/A	<1 KB	<30 s	99.99%	70 m/s <sup>e</sup>	15000/km <sup>2f</sup>	1 m for lane accuracy	Continuous
Speed Harmonisation <sup>g</sup>	<150 m <sup>h</sup>	<500 bytes/ message <sup>i</sup>	1400 ms <sup>j</sup>	~80%	69.4 / 33.3 / 19.4 <sup>k</sup>	<15000/km <sup>2</sup>	1 m for lane accuracy	Continuous
Context aware maneuvering	100 m	100 B per message <sup>o</sup>	50 ms	99%	33.(3) m/s <sup>l</sup>	<15000/km <sup>2m</sup>	1 m for lane accuracy	Continuous (10 Hz) <sup>n</sup>

<sup>a</sup> ETSI CAM size with extras<sup>b</sup> considering maximum velocity of 120 km/h<sup>c</sup> maximum non highway speed of 90 km/h<sup>d</sup> urgent, during a vehicle top speed at certain highways<sup>e</sup> during a vehicle top speed at certain highways<sup>f</sup> heavy traffic around the vehicle<sup>g</sup> worst case scenario, with human reaction<sup>h</sup> majorant of the provided values<sup>i</sup> speed, location and additional information<sup>j</sup> minorant of the provided values<sup>k</sup> highway / rural / urban<sup>l</sup> maximum velocity of 120 km/h<sup>m</sup> considering in an urban situation<sup>n</sup> worst case scenario in possible range of frequency of transmission of Manoeuvre Coordination Message (MCM), per [136]<sup>o</sup> maximum size of the message [136]

not only for itself, but for other vehicles, and road occupants as well. This requires leveraging the concept of cooperation between vehicles and others. While standardization work, for example through European Telecommunications Standards Institute (ETSI) MCMs are under way, the cooperation between vehicles, particularly for autonomous driving is in its initial stages.

Autoware, an open source framework considered to be state-of-the-art for autonomous driving<sup>54</sup>, considers several services to ensure an autonomous driving — albeit in previously mapped environments — to support manoeuvres such as curb-to-curb, lane following, lane merging, parking or reaction to traffic lights and dynamic entities (e.g. Vulnerable Road Users (VRUs)).

To produce plans that eventually become decisions and actuation to the engines, braking and other vehicular subsystems,

<sup>54</sup>Apart from closed source solutions from automakers (more details on section II-C), where it is not possible to fully understand the scope of the cooperation between vehicles and its interoperability with other brands.

Autoware relies on information of the vehicle itself and on a model of the environment. All this planning is therefore very local, with cooperation from other vehicles and road entities proving essential not only to improve Autoware's vision of the world (in a cooperative sensing solution such as the one defined by ETSI Collective Perception Service (CPS)), but also to coordinate the manoeuvre that each vehicle will do, ensuring that a safe manoeuvre for one vehicle does not possess danger to another.

When the planning becomes cooperative and not only local, a new problem arises. Information from and to each vehicle *must* be sent and *must* be sent within a well defined time-frame that is compatible with Autoware producing a decision and actuating on the vehicle's subsystems. If the information arrives after this defined time-frame, the decision will not be correct, while if it arrives before this defined time-frame, the decision might be unnecessary — but also potentially

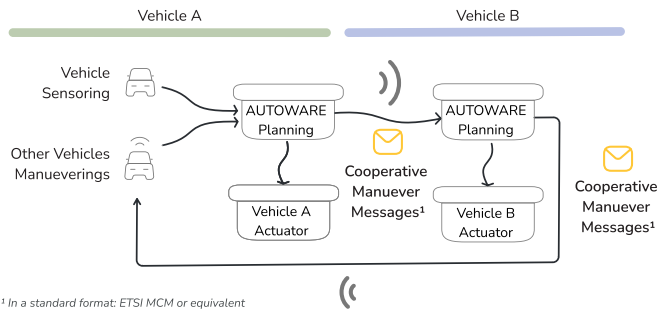

Fig. 15: Overview of the Context Aware Maneuvering use case.

dangerous<sup>55</sup>.

This rational defines the currently considered use case: **cooperative deterministic manoeuvring**, where vehicles receive information from other entities and use them as part of the planning.

As an example scenario, one may consider coordinating lane merging manoeuvre between an ambulance and a private vehicle. This use case requires the development of services depicted in fig. 15, namely a) a message creator and producer to support exchanging data between Autoware instances in different vehicles, and b) a parser and injector of such information into Autoware planning. The data format would follow ETSI MCM standards and it would be periodic, with deadline insurance requirements — and therefore both a minimum and bounded latency requirement — with no tolerance to failures of delivery and with a variable size with an upper bounds corresponding to the maximum size of the MCM message.

The integration of Autoware with cooperative manoeuvring is considered in [138]<sup>56</sup>. However, it fails to consider the deterministic communications requirements or the need for orchestrating the overall deployment in vehicles' ECUs in a more automated approach.

**Vehicle malfunction situations** Even when full autonomy of a vehicle is not only a reality but also legal, vehicles can still have unexpected issues that endanger their occupants and surroundings. Examples include a flat tire, a tire explosion, failed waterproofing of the batteries (in the case of electric vehicles), or a failure on the valve timing (in the case of internal combustion engines). In these scenarios, services to **analyze, monitor and warn** others about the situation should be deployed in a bounded minimal time and the information to other vehicles shall be sent with both minimized, and bounded latency.

When considering Connected Autonomous Vehicles, services that monitor and react when sensors are malfunctioning are critical and their information must also be bounded in time and transmitted reliably. Without such services, the CAVs cannot react to a malfunctioning or occluded camera, Light Detection And Ranging (Lidar) or equivalent and can wrongly

<sup>55</sup>For example, a vehicle would end up braking before being necessary, becoming vulnerable to being hit in the back.

<sup>56</sup>Additional details at <https://tlab-wide.github.io/AutowareV2X/pr-48/design/use-cases/>.

assume their information is correct, with potentially deadly consequences.

### B. Towards vehicles tailored for everyone

While the future of mobility is inherently more autonomous and more feature-packed, less concern is given to occupants, including children or occupants who may have some sort of physical or cognitive restriction. Restrictions considered here may include some minor impairment, vision or hearing issues, concentration issues, and others, that restrict the occupants' capability of reacting to the environment in the same way.

The following situations are examples where a vehicle has an occupant with some issue/limitation who can greatly benefit from a SDV paradigm. In this paradigm, the vehicle can deploy services tailored for the people's specific needs for customization of vehicular functions, protection, monitoring, and companionship. In all situations, the services to be deployed shall have their data delivered in a bounded time — so the services are not left in an inconsistent state.

Automatic vehicle configuration based on occupants characteristics Information on the occupants' characteristics and vital parameters can be obtained by intra-vehicular subsystems that allow the vehicle to adapt interior functions (*e.g.* lighting, sound, infotainment) to the best comfort of the occupants, therefore creating a set of customizations tailored to each occupant's characteristics.

Not only the services can adapt but warn if there is an issue (like a non-fixed wheelchair or baby seat). Such warnings can be sent both to the vehicle's infotainment systems but also to other vehicles. Vehicles can then use such information, as well as information about the occupants' characteristics, to deploy services to adapt the vehicle driving — *e.g.* to increase cruise control following distances, reduce throttle response, or warn other smart city infrastructures.

These services can greatly benefit the healthcare industry in particular. Consider a scenario where an ambulance is transporting a patient. Vehicular services can support scenarios such as this:<sup>k</sup>

- *Ambulance: I have a person in risk of life.*
- *Other vehicles: OK, I need to slow down.*
- *Cloud: I'll provide you with specific applications (e.g. to control acceleration profiles or climate control settings). I'll deploy an application for monitoring impaired people that will run on a cluster of X vehicles.*

#### **Adapting the vehicle's subsystems to impaired occupants**

Consider a situation where, in order to transport impaired people in a wheelchair, a healthcare provider must<sup>57</sup>:

- 1) *Get the wheel chair up a moving ramp or lift, per depicted in fig. 16a<sup>58</sup>*
- 2) *Attach the wheelchair to the vehicle through a set of several belts fixed to specific points within the vehicle, as depicted in fig. 16b.*

<sup>57</sup>From an informal interview with a specialist nurse in medical-surgical nursing

<sup>58</sup>Another example of such ramps and lifts in <https://www.gilaniengineering.com.au/product/hydraulic-wheelchair-platform-accessible-lift-hoist-for-cars-and-vans/>.



(a) Example of ramp where wheelchairs need to be pushed manually by the healthcare provider (courtesy of Tripod Mobility<sup>a</sup>).

<sup>a</sup>More details at <https://www.tripodmobility.com/en/products/wheelchair-accessible-vehicles/upfront/>.

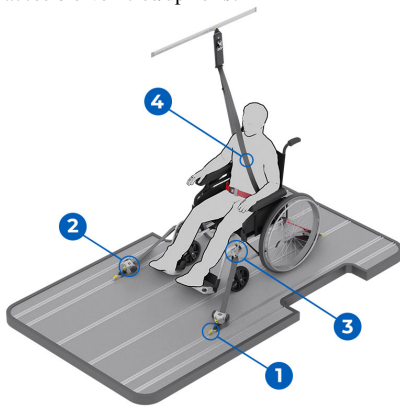

(b) Example of expected attachment points within a vehicle for a wheelchair (courtesy of BraunAbility<sup>a</sup>).

<sup>a</sup>Available at <https://www.braunability.eu/en/products/tie-downs-and-seatbelts/wtors/>.

Fig. 16: Detail view on the main steps for transporting impaired people on a vehicle.

The healthcare provider must do such **manually**, multiple times (for multiple people) and in a short time-frame and without little to no feedback if the person and the chair is actually fixed properly. Mistakes include fixing outside of the fixing point, twisting the straps and/or simply not fixing the person and/or chair. In addition to that, specific formation is required to do such tasks.

A vehicular services (or set of services) that is capable of communicating with other in vehicle systems (e.g. infotainment), but also with the healthcare provider registry systems, would greatly decrease the potential human errors of the current solution, and since it would minimize the dependency on humans could even support an increase on the patient's privacy. One could even consider a more intelligent connected wheelchair directly coordinating with the vehicle all the necessary movements. Such systems would not require a minimized latency but guarantees of delivery of the information within well-known time bounds and with low jitter in order to ensure

no unwanted movements of the wheelchair that may harm the person.

Other situations include:

- Monitoring a baby that is ill or very restless and provide such information directly to a hospital.
- Decrease the brightness of other vehicle's lightning in order to protect the eyes of a newly operated occupant.

**Personal assistants** While the SDV paradigm is parallel to the advent of autonomous vehicles, vehicles can include humans in new ways within the driving experience. The unparalleled amount of information and sensing the vehicle can obtain from its environment, driver and occupants, can be used to support personal assistants that give occupants the sensation of being in control — even if the vehicle is self-driving.

Such assistants can be developed as a set of subscribing services within the vehicle's ECUs dedicated to infotainment subsystems and, if using speech or touch interaction modalities, can greatly benefit from a well defined timely delivery of information which decreases the overall jitter visible to the end users.

### C. Towards assisted fleet management and maintenance

Remote vehicle health and predictive maintenance Constant monitoring of the main vital parameters of a vehicle state — such as tire condition, brake system condition, engine cooling system status (in the case of internal combustion engines) or the power delivery subsystems (in the case of electric vehicles) — requires not only a reduced latency but also, in case the vehicle detects an issue, a guarantee of delivery in a bounded time so at the very least other vehicles are aware of the problem before it has impact on the road. In the case of emergency scenarios — as previously described in section V-A, the latency shall also be minimized.

Predictive maintenance scenarios, while not necessarily requiring a bounded latency within its communication, still require a dynamic deployment of services that considers the vehicular ECUs.

**Fleet management** Fleet management scenarios and remote services, such as the one presented at fig. 17<sup>59</sup>, are other examples of use cases that can benefit from a set of services deployed across multiple vehicles. Considering a set of services containing the logic required to monitor, in real-time, the status (e.g. *location or number of hours the vehicle is driven*) of a vehicle within a fleet. This set of services, if orchestrated throughout a cluster of vehicles, can support systems for enterprises managing a vehicular fleet, homologating it, or even for state entities to perform the routine inspection. Information from/to those services, while do not necessarily require an extremely low latency, must be delivered within known time bounds and with low jitter.

**Over-the-air updates and real-time homologation** Changes in the vehicles' software — either via OTA updates, through the addition of new services or after a vehicle is sold to ensure no changes — should, in an automated way, be reflected

<sup>59</sup>More details at <https://www.autowiz.in/fleet-features.html>.

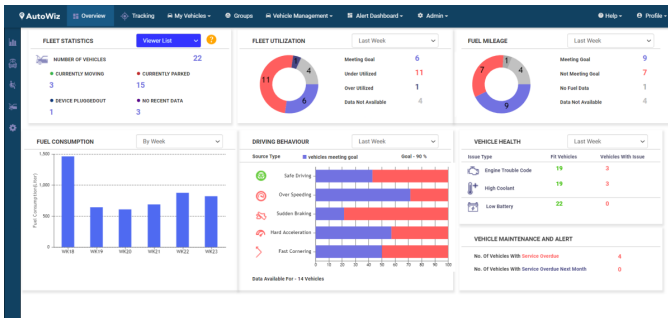

Fig. 17: Example of vehicle fleet management system (courtesy of AutoWiz).

in a re-homologation process. This process, while not requiring a minimized latency, shall be done in a bounded timely manner, with a guarantee of reliability, otherwise, vehicles may be driving on public roads with an unwanted, unsafe state [5].

## VI. PROPOSED VISION

In order to support a dynamic management of the services several layers must be considered as depicted in fig. 18. These layers should act at least in the following domains [32]:

- Orchestration of the services: where they should be run and policies to decide the node(s) and the number of replicas.
- Virtualization and management of the network: including automatic configuration of routing and TSN shapers and reliability processes (e.g. FRER).
- Virtualization of the hardware in order to support better resource usage and decoupling of services and operating systems from each ECU.

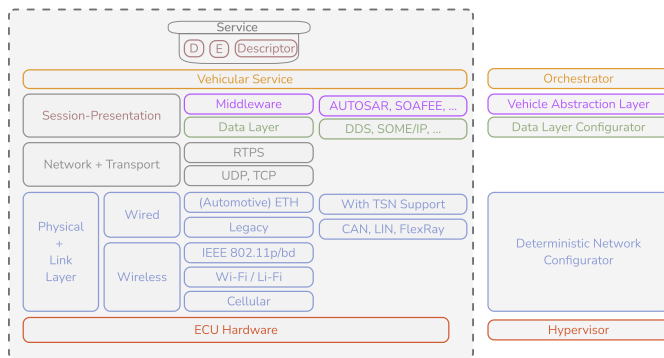

Fig. 18: Overall layered view of the architecture main modules.

Figure 19 presents the overview of an initial proposal of architecture. This architecture supports a cloud computing approach on vehicles to see them as a data center on wheels [32] in order to support service scheduling, redundancy, and healing based on the vehicles' computing capabilities.

The **Orchestrator** vertical (in yellow) is the main entry-point of the system to be researched and ensures the first aforementioned layer. Through user-defined and system-defined metrics within a Service Descriptor, decides the amount of resources and the placement of those resources throughout the

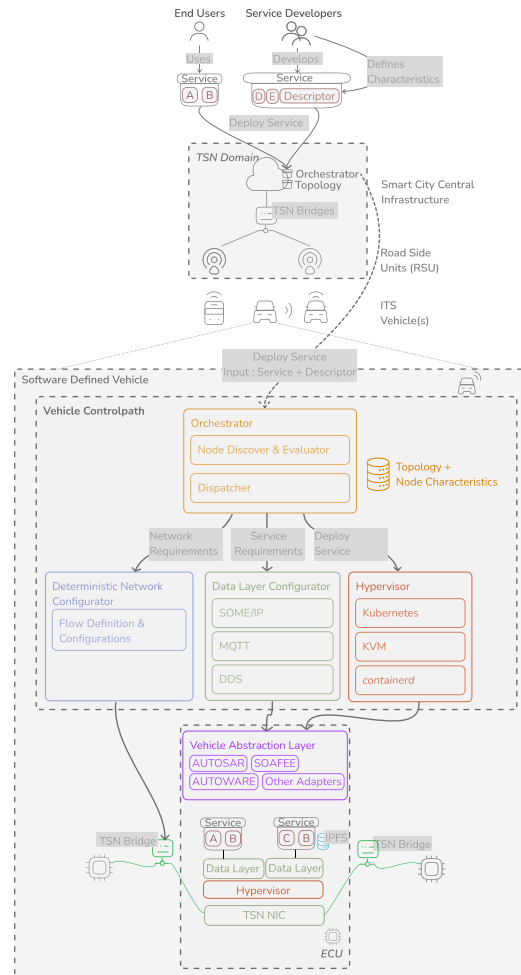

Fig. 19: Overall high level architecture of the proposed solution.

computing continuum and the different vehicles throughout the smart city, while considering possible handovers and optimal usage of the computing and network resources. The orchestrator is responsible for controlling 4 other verticals.

The first vertical, the **Deterministic Network** (in blue), ensures that messages – either control messages to actuate or status messages containing information from vehicles and the smart city – are delivered in a well-specified time bound and with fault-proof reliability. Research topics here include, but are not limited to, integrating clock synchronization mechanisms into wireless vehicular networks and mechanisms towards dynamic automatic definition, and optimal configuration of flows of packets, their queue priorities and characteristics. The module within the architecture, the *Deterministic Network Configurator*, is responsible for creating the necessary traffic flows, their parameters and configuring the necessary hardware, namely the Network Interface Controller/Card (NIC) within each ECU and the TSN capable Ethernet switches interconnecting them. It is expected at least 3 traffic classes to be configured: a) system control messages with maximum criticality; b) high size (non) periodic streams of data and c) periodic or non periodic service messages.

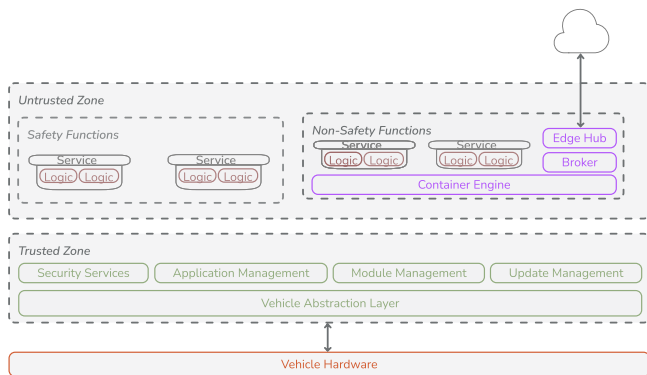

Fig. 20: The VAL based architecture for vehicles as described by [10].

The **Data Layer** vertical (in green) is responsible for ensuring the data is exchanged between the vehicular services in the most appropriated set of SOA protocols — such as SOME/IP, MQTT or DDS.

The **Hypervisor** vertical (in red) is responsible for ensuring the deployment of the services, either within a Kubernetes worker node, within a virtual machine managed for example by KVM or through a *containerd* or equivalent container runtime.

These 3 verticals dispatch orders to the **Vehicle Abstraction Layer (VAL)** (in purple) of each ECU, which abstracts different types and models of vehicles' ECUs – both simulators and real vehicles – their actuators, sensors, and ECUs through the abstraction of existing frameworks, such as AUTOSAR, Autoware or others. Conceptually, the VAL is no different to the standardized abstractions operating systems created during the mid 1980s and 1990s to abstract the hardware from the remaining kernel, with [10] proposing an extension of such a paradigm into the vehicular paradigm, as depicted in fig. 20.

The research on the VAL may also consider the creation of a digital twin of the vehicle and the research of the impact of sensors and services on the vehicle networks.

#### A. Overall end-to-end interaction

Figure 21 provides an overview of the end-to-end interaction of the system proposal, from the features the end-user (developer of vehicular services) can expect to see up to the configuration of the necessary hardware for the services to be run while fulfilling their requirements.

The system to be researched orchestrate the service deployment, execution and evaluation of intra- and inter- vehicular services. Services can be associated with domains, that define not only requirements but the universe of information the service can subscribe. Service developers define a service descriptor (an example is detailed in section VI-A) to describe the main service characteristics. This set of requirements is used by the orchestrator to configure and dispatch the services to the appropriated hypervisor in the appropriated ECUs and configure the *datapath*, *i.e.* the network and data layer resources required for the service to communicate with others.

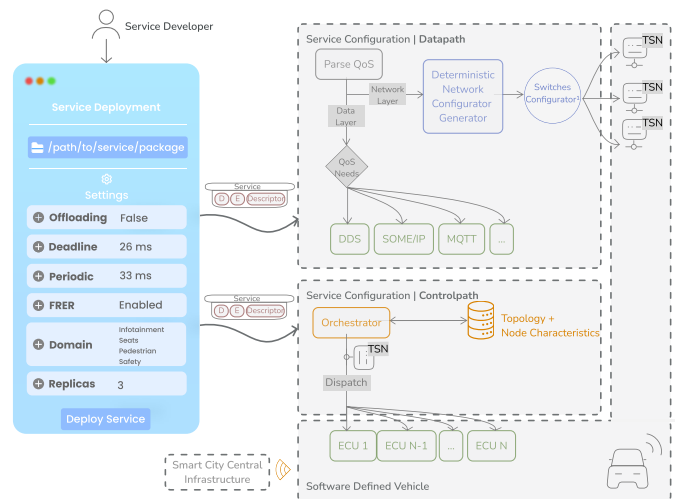

Fig. 21: Overall end-to-end interaction model of the proposed solution.

Services must be deployed by the orchestrator which must decide the best node(s) for the service characteristics — automatically, manually, or based on criteria (*e.g.* specifications, time, energy, cost), and ensure latency bounds for the deployment of the service and for the exchange of messages between them if the service descriptor (potential example on section VI-A) requires criticality and/or QoS levels on the data exchange. The orchestrator is the module responsible for a) evaluating the nodes on the match between the service characteristics and the node characteristics, and b) dispatching the configurations to the  $N$  nodes best fulfilling the service characteristics. Receiving as input both the service descriptor and the node characteristics, the algorithm outputs a score to each node and if the node may be used or not (to support requirements that **must** be fulfilled).

The vehicular service developer shall interact with the system through a declarative paradigm, *i.e.* set the wanted state<sup>60</sup>. A file — or equivalent structure — describing the necessary characteristics of the vehicular service can support this paradigm. This information is defined by the service developer and can be used by the system to be developed to support the service deployment.

Associated with each field is not only the value, with the type prescribed, but also its criticality. Since not all conditions can be met by a node, it is essential for the orchestrator module to know which metrics can be unmet and by what margin.

For example, when considering the use case in section V-B, one can imagine the service developer creating a service descriptor such as the one in section VI-A. This service descriptor is then submitted to a platform that sends to the controller within the target vehicle(s). Within each vehicle a controller is responsible for evaluating the ECUs and configuring them and the necessary network components to ensure that the service requirements are properly considered. In the case of the considered service, this entails at least deploying the necessary containers within an ECU connected to the

<sup>60</sup>Kubernetes is a widely known example of such declarative paradigm.



necessary actuators - the motors for the fixing points and the ramp - and configuring the switches connecting such actuators and the ECUs where the service connect with the necessary TSN TAS scheduling - while keeping fulfilling the other already running services and their requirements.

Listing 1: Example of possible service descriptor.

```

title = "WheelchairDriver"

[ServiceMetadata]
Author = "TheWheelChairCompany"
Version = "1.0"
Domain = "safety"

[Flows]
[Flows.Flow1]
[Flows.Flow1.NodeSpecs]
[Flows.Flow1.NodeSpecs.NodeA]
Image = "thewheelchairservice"
ImageType = "docker"
Replicas = 2
CPU = 2
Memory = 1024
Storage = 5120000000
GPU = false
Energy = 1
Offloading = false

[Flows.Flow1.DataSpecs]
DataFormat = "json"
DataSize = 8096

[Flows.Flow1.TrafficSpecs]
Guarantee = 4
Reliability = true
Delivery = true
Wired = true

[Flows.Flow1.TrafficSpecs.TrafficTimeSpecs]
MaxLatency = 50
Periodicity = 100
TransmitOffset = 0
Jitter = 10

```

### B. Proposal of evaluation architecture

The evaluation of the proposed system requires at least a testbed with a topology equivalent to the one depicted in fig. 22. A smart city infrastructure, including its cloud and RSUs form a Deterministic Network domain. This domain is responsible for ensuring a deterministic end-to-end latency for messages of vehicular services by configuring appropriately the necessary traffic shapers and synchronization between TSN capable switches. These switches are connected through Ethernet and ensure connectivity between RSUs, and between RSUs and the smart city cloud.

This testbed shall include at least one or more ECUs, a data center [139], a vehicular edge computing area [139], one vehicular sensor, one vehicular actuator, a Ethernet backbone with TSN capable switch, and a CAN legacy bus.

The testbed may be deployed either by software or hardware. Software simulators can be used to mimic: a) the network, b) the vehicular topology, and c) the inter vehicular domain, while hardware can be used to function/emulate ECUs, Ethernet switches with TSN support, CAN based sensors and actuators.

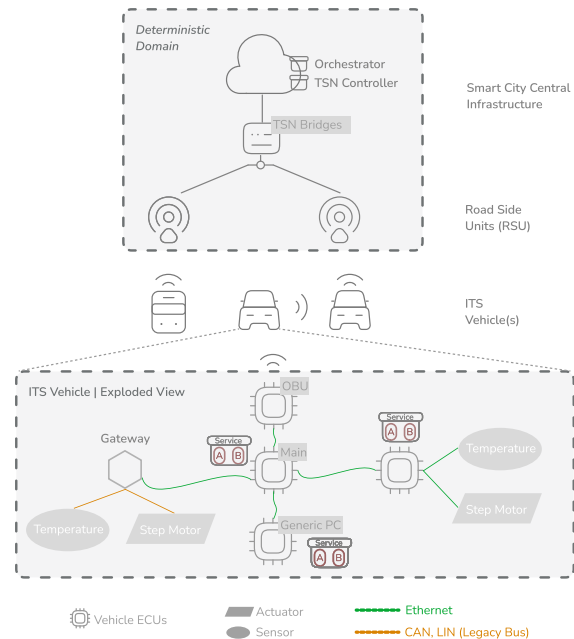

Fig. 22: Proposed testbed solution for evaluation of the system to be developed.

Analysis of overall performance of the system should be at least in terms of throughput and latency for edge (intra-vehicular), cloud, and hybrid approaches but also consider additional metrics, such as, inter-frame/packet latency [140], data rate, transmission queue length [141], percentage of missed deadline or offset of period and worst frame/packet latency.

1) *Hardware equipment*: The hardware equipment that may be considered within the testbed in fig. 22 shall consider hardware equipment in two different contexts:

- The network infrastructure, comprised by the switches, routers and access points that shall be compatible with deterministic communication standards, such as TSN standards.
- The ITS intra vehicle hardware, including generic computers or specific computers (*i.e.* ECUs).

A basic topology to simulate an entire vehicle is depicted in fig. 23 and requires at least two computational nodes, one per vehicle, connected through a network backbone (initially considered as a Ethernet Switch with support for deterministic communications), one sensor, one actuator, and necessary transceivers to bridge the sensors and the actuators to the Ethernet/Wireless domain.

Regarding the network infrastructure, solutions from closed source from typical network manufacturers to open source solutions are available. In principle all equipment supporting the basic architecture within [142], [143] are enough to support the basic testing of the proposed architecture. Cisco possesses TSN capable switches, such as the IE 4000 Series Industrial Switch. Within its operating system, the IOS, it is possible to

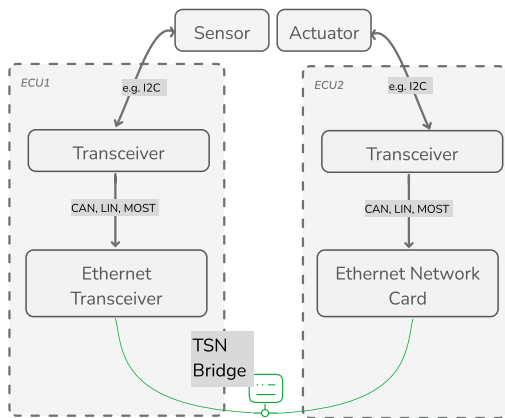

Fig. 23: Basic topology to simulate the vehicle.

install support to TSN standards<sup>61</sup>.

Closed source alternatives include for example the NXP SJA1105TEL<sup>62</sup> switch, specifically target at vehicular ECUs, or the Broadcom BCM53570 SoC.

Relyum offer closed-sourced FPGA based alternative solutions<sup>63</sup> for TSN switches, with theoretical support for configuration through NETCONF, with alternatives from SoC-e<sup>64</sup> also available.

In addition, several SoC alternatives also support TSN. Xilinx SoC, such as the KR260 series<sup>65</sup> contain support for TSN, integrate a FPGA that may support the hardware acceleration of parts of the proposed architecture in fig. 19 and support the interconnection with existing legacy vehicular systems through its support for CAN bus, while also keeping an open architecture having in mind the reconfigurability FPGAs support.

Regarding vehicular hardware, two alternatives may be considered: an approach based on simulating parts of the vehicle; and an entire development vehicle.

PixKit<sup>66</sup> is a possibility currently under study. Alternatives such as the The Car Lab's HYDRAONE<sup>67</sup> could also be considered, even if less advanced than the PixKit alternative, in particular without out-of-the-box semi autonomous driving<sup>68</sup>. Within the vehicle, computation systems such as NXP, through

its BlueBox Development Kit<sup>69</sup> or Renesas through its R-Car H3e-2G Starter Kit<sup>70</sup> can be considered as ECU for testing purposes. Well known alternatives such as the Raspberry Pi and equivalents can also be considered.

It is important to point out the usage of existing infrastructure, such as Aveiro Tech City Living Lab (ATCLL) smart city infrastructure — namely RSUs — to ensure connectivity of the testbed vehicular systems with the remaining smart city and other vehicles.

Finally, one should consider hardware equipment related to the use cases themselves. Sensors and actuators that are needed, for example for the use case in section V-B) include step motors — for the ramp or fixing the seat belts — or sensors to detect unbuckled seat belts, weight sensors to detect used wheelchairs and screens for the direct interaction with the users.

2) *Software and simulators*: When hardware equipment is not available or if does not correspond to the requirements of the testbed as depicted, software simulation alternatives may be considered.

While solutions such as AUTOSAR simulate and model the automotive Ethernet, it lacks TSN support for such modelation [4]. To simulate the network, both in its wired and wireless components, one can use use case agnostic solutions such as OMNET<sup>71</sup>, that with INET<sup>72</sup> and with CoRE4INET<sup>73</sup> or NeSTiNg<sup>74</sup> can be used to simulate networks with TTEthernet and TSN protocols [144].

OMNET can also be extended with SUMO<sup>75</sup> through frameworks such as Veins<sup>76</sup>, an open source framework for running vehicular network simulations [145]. It can also be extended for service-oriented communication, through the SOA4CoRE<sup>77</sup> initiative. Mininet, a popular alternative to create virtual networks with complex typologies and greatly used in evaluation for SDN contexts, can also be extended to considered wireless communications through the Mininet-WiFi<sup>78</sup> initiative and can therefore also be an alternative situation.

Matlab, within its Vehicle Network Toolbox, also allows the modeling of vehicle networks. Middleware layers, such as DDS can be integrated within MATLAB and Simulink tools as a block-set [146]

<sup>69</sup>Details available at <https://www.nxp.com/design/design-center/development-boards-and-designs/bluebox-3-0-automotive-high-performance-compute-ahpc-development-platform:BlueBox>.

<sup>70</sup>Details available at <https://www.renesas.com/in/en/products/automotive-products/automotive-system-chips-socs/rtp8j779m1askb0sk0sa003-r-car-h3e-2g-starter-kit>.

<sup>71</sup>Available at <http://omnetpp.org/>.

<sup>72</sup>Available at <https://inet.omnetpp.org/>.

<sup>73</sup>Albeit with notable limitations, such as no simulation of frame preemption or clock synchronization protocols, with TSimNet model being an alternative for both frame preemption and replication and elimination [4].

<sup>74</sup>Available at <https://omnetpp.org/download-items/NeSTiNg.html>. Most logic related to NeSTiNg is now integrated within INET.

<sup>75</sup>Available at <https://eclipse.dev/sumo/>.

<sup>76</sup>Available at <https://veins.car2x.org/>.

<sup>77</sup>Service-Oriented Architecture for Communication over Realtime Ethernet, available at <https://github.com/CoRE-RG/SOA4CoRE>.

<sup>78</sup>Available at <https://mininet-wifi.github.io/>.

<sup>61</sup>Details available at [https://www.cisco.com/c/en/us/td/docs/switches/lan/cisco\\_ie4000/tsn/b\\_tsn\\_ios\\_support/b\\_tsn\\_ios\\_support\\_chapter\\_010.html](https://www.cisco.com/c/en/us/td/docs/switches/lan/cisco_ie4000/tsn/b_tsn_ios_support/b_tsn_ios_support_chapter_010.html).

<sup>62</sup>Details at <https://www.nxp.com/products/interfaces/ethernet-automotive-ethernet-switches/five-ports-avb-and-tsn-automotive-ethernet-switch:SJA1105TEL>.

<sup>63</sup>More details at <https://www.relyum.com/web/rely-tsn-lab/>. Equipment available at the group lab.

<sup>64</sup>Such as <https://soc-e.com/avb-automotive-ethernet-switch-ip-core/>.

<sup>65</sup>Details available at <https://www.xilinx.com/content/dam/xilinx/publications/product-briefs/kr260-product-brief.pdf>.

<sup>66</sup>Details available at <https://pixmoving-moveit.github.io/pixkit-documentation-en/pix-chassis-user-manual/>. Equipment available on the lab as of April 2024.

<sup>67</sup>Available at <http://weisongshi.org/hydraone/>.

<sup>68</sup>Semi autonomous since the PixKit solution is fully dependent on previously mapped environments.

RealTime-At-Work Pegase<sup>79</sup> provides a closed proprietary tool for the equivalent purpose of testing ECUs communications. Renault, for example, considers within their TSN tests an ECU based on AUTOSAR classic software and interconnected with a physical + MAC Ethernet layer with TSN capable hardware [19]. The RTaW tool provide the Yet Another Next Generation (YANG) files for the hardware, with Bosch creating plugins to emulate detailed modeling of the ECUs integrate into the RTaW Pegase simulation [19].

Tools like Autoware<sup>80</sup> and Carla<sup>81</sup> can then be used to simulate vehicular use cases, particularly in autonomous driving scenarios. Autoware in particular is considered a good solution both for being based on the widely used ROS and for offering hardware<sup>82</sup> kits that can be integrated within their software. However, while it has monitoring tools for CPU and GPU usage and some redundancy in sensor fault management, lacks any in-vehicle networking, both wired and wireless<sup>83</sup>.

CSS Electronics CANedge<sup>84</sup> and equivalent equipment can be used to obtain real frames from CAN bus, either simulated or real, and send it to another computer. This can be used to obtain data to support the simulations with the aforementioned tools. If not possible, buses like CAN can also be simulated for example using Linux support for Virtual CAN tunnel (VXCAN).<sup>85</sup>

## VII. CONCLUSIONS

In this tutorial, the concept of Software Defined Vehicles was presented and framed as essential to support the development of the next generation of vehicular services. Its main building blocks - Service Oriented Architecture, operating systems, virtualization and orchestration techniques and inter- and intra-vehicular communications with determinism techniques can support the creation of a truly Software-Defined Vehicle. An architecture was proposed for the dynamic management of services within SDV. Based on a deterministic network configurator, a data layer configurator, a hypervisor configurator and a vehicle abstraction layer, all coordinated by a software orchestrator, it supports an easier dynamic management of vehicular services, easing the development burden of such artifacts. Future work includes implementation and the proper evaluation of its scheduling algorithms as well as a end-to-end acceptance test.

## REFERENCES

- [1] C. Buckl, A. Camek, G. Kainz, C. Simon, L. Mercep, H. Stähle, and A. Knoll, "The software car: Building ict architectures for future electric vehicles," in *2012 IEEE International Electric Vehicle Conference*, 2012, pp. 1–8.

<sup>79</sup>Available at <https://www.realtimeatwork.com/rtaw-pegase/>.

<sup>80</sup>Available at <https://autowarefoundation.github.io/autoware-documentation/main/>.

<sup>81</sup>Available at <https://carla.org>.

<sup>82</sup>Available at <https://www.autoware.org/autoware-open-ad-kit>.

<sup>83</sup>Current focus of Autoware V2X module, available at <https://tlab-wide.github.io/AutowareV2X/main/>.

<sup>84</sup>Details at <https://www.csselectronics.com/products/can-bus-data-logger-wifi-canedge2>.

<sup>85</sup>Source code available at <https://github.com/torvalds/linux/blob/master/drivers/net/can/vxcan.c>

- [2] Vector, "How have vehicle e/e systems evolved? — #engineeringthejigsaw — episode f10 - youtube," <https://www.youtube.com/watch?v=OjnQ52f1SEE>, Nov. 2021, (Accessed on 07/01/2023).
- [3] —, "How are vehicle e/e systems evolving? — #engineeringthejigsaw — f11 - youtube," <https://www.youtube.com/watch?v=XpvTOuOgGWY>, Dec. 2021, (Accessed on 07/01/2023).
- [4] M. Ashjaei, L. L. Bello, M. Daneshalab, G. Patti, S. Saponara, and S. Mubeen, "Time-sensitive networking in automotive embedded systems: State of the art and research opportunities," *Journal of Systems Architecture*, vol. 117, p. 102137, 2021. [Online]. Available: <https://www.sciencedirect.com/science/article/pii/S1383762121001028>
- [5] A. L. Andreas Herzig, Daniel Gamber, "Human vs. "digital driver" - compliance and digital homologation challenges in the automotive industry," <https://engagestandards.ieee.org/Human-vs-AI-Driver-Webinar-Registration.html>, Jun. 2023, (Accessed on 07/04/2023).
- [6] B. B. Gordan Markus, "A CTO's Guide to software-defined vehicles," *Canonical*, no. June, 2022. [Online]. Available: [https://pages.ubuntu.com/rs/066-EOV-335/images/SDV\\_WP\\_Final\\_27062022.pdf](https://pages.ubuntu.com/rs/066-EOV-335/images/SDV_WP_Final_27062022.pdf)
- [7] R. N. Charette, "How software is eating the car - ieee spectrum," <https://spectrum.ieee.org/software-eating-car>, Jun. 2021, (Accessed on 04/28/2023).
- [8] Vector, "Autosar essentials — #engineeringthejigsaw — episode f6 - youtube," <https://www.youtube.com/watch?v=W5F8nQuwuWY>, Aug. 2021, (Accessed on 07/01/2023).
- [9] McKinsey, "The case for an automotive software platform," <https://www.mckinsey.com/industries/automotive-and-assembly/our-insights/the-case-for-an-end-to-end-automotive-software-platform>, Jan. 2020, (Accessed on 05/05/2023).
- [10] M. O.-C. Sean Selitrennikoff, *Architecting for Secure, Safe and Agile Software Defined Vehicles - Learnings from the Personal Computer industry*, 1st ed., ser. VDI-Berichte. Düsseldorf: VDI Verlag, 2021, vol. 2384, pp. 395–408.
- [11] A. Chebaane, A. Khelil, and N. Suri, "Time-critical fog computing for vehicular networks," pp. 431–458, Apr. 2020.
- [12] Renault Group, "H1stvision, the concept car designed by software république: a human-centred vision of mobility for tomorrow - renault group global media website," <https://media.renaultgroup.com/h1st-vision-the-concept-car-designed-by-software-republique-a-human-centred-vision>, Jun. 2023, (Accessed on 07/01/2023).
- [13] S. Kugele, D. Hettler, and J. Peter, "Data-centric communication and containerization for future automotive software architectures," in *2018 IEEE International Conference on Software Architecture (ICSA)*. IEEE, Apr. 2018.
- [14] V. Bandur, G. Selim, V. Pantelic, and M. Lawford, "Making the case for centralized automotive e/e architectures," *IEEE Transactions on Vehicular Technology*, vol. 70, no. 2, pp. 1230–1245, Feb. 2021.
- [15] M. Silva, P. Teixeira, C. Gomes, D. Dias, M. Luís, and S. Sargento, "Exploring software defined networks for seamless handovers in vehicular networks," *Vehicular Communications*, vol. 31, p. 100372, 2021. [Online]. Available: <https://www.sciencedirect.com/science/article/pii/S2214209621000413>
- [16] R. Deng, R. Lu, C. Lai, T. H. Luan, and H. Liang, "Optimal workload allocation in fog-cloud computing toward balanced delay and power consumption," *IEEE Internet of Things Journal*, vol. 3, no. 6, pp. 1171–1181, 2016.
- [17] S. Park and Y. Yoo, "Real-time scheduling using reinforcement learning technique for the connected vehicles," in *2018 IEEE 87th Vehicular Technology Conference (VTC Spring)*. IEEE, 2018, pp. 1–5.
- [18] I. Farris, T. Taleb, M. Baggaa, and H. Flick, "Optimizing service replication for mobile delay-sensitive applications in 5g edge network," in *2017 IEEE International Conference on Communications (ICC)*. IEEE, 2017, pp. 1–6.
- [19] J. M. Josetxo Villanueva, Bouchra Achemlal and D. Martini, "Strategies for end to end timing guarantees in a centralized software defined vehicle architecture combining can with tsn backbone," in *Automotive Ethernet Congress*, Mar. 2023, (Accessed on 07/04/2023).
- [20] H. Proff, T. Pottebaum, and P. Wolf, "Software is transforming the automotive world," *Deloitte Insights*, p. 20, 2020. [Online]. Available: [https://www2.deloitte.com/content/dam/insights/us/articles/22951\\_software-is-transforming-the-automotive-world/DI\\_Software-is-transforming-the-automotive-world.pdf](https://www2.deloitte.com/content/dam/insights/us/articles/22951_software-is-transforming-the-automotive-world/DI_Software-is-transforming-the-automotive-world.pdf)
- [21] CARIAD Media Team, "The chips that power our cars," <https://cariad.technology/de/en/news/stories/semiconductors-power-our-cars.html>, Mar. 2023, (Accessed on 04/28/2023).
- [22] S. Corwin, N. Jameson, and P. Willigman, "The future of mobility: What's next?" *Deloitte*, p. 28, 2016. [Online]. Available:

- [https://www2.deloitte.com/content/dam/insights/us/articles/3367\\_Future-of-mobility-whats-next/DUP\\_Future-of-mobility-whats-next.pdf](https://www2.deloitte.com/content/dam/insights/us/articles/3367_Future-of-mobility-whats-next/DUP_Future-of-mobility-whats-next.pdf)
- [23] Bosch, "The e/e architecture of the future," <https://www.bosch-mobility.com/en/mobility-topics/ee-architecture/>, 2023, (Accessed on 05/05/2023).
- [24] P. K. Oliver Creighton, Nicolas Navet and J. Migge, "Towards computer-aided, iterative tsn-and ethernet-based e/e architecture design," in *2020 IEEE Standards Association (IEEE-SA) Ethernet & IP @ Automotive Technology Day*, Sep. 2020, (Accessed on 07/04/2023).
- [25] Vector, "Middleware Protocols in the Automobile: Service-Oriented, Data-Centric or RESTful? These," *Elektronik automotive*, no. 3, 2020.
- [26] B. Murphy, "What the Next Phase of Automotive Software Development Looks Like," pp. 1–9, 2021, (Accessed on 04/28/2023). [Online]. Available: [https://www.apativ.com/docs/default-source/white-papers/2021\\_apativ\\_whitepaper\\_cicd.pdf?sfvrsn=5fbbe33b\\_24](https://www.apativ.com/docs/default-source/white-papers/2021_apativ_whitepaper_cicd.pdf?sfvrsn=5fbbe33b_24)
- [27] CARIAD, "Cariad launches application store for the volkswagen group," <https://cariad.technology/de/en/news/stories/launch-application-store-for-volkswagen-group.html>, Mar. 2023, (Accessed on 07/04/2023).
- [28] J. M. Nicolas Navet, Josetxo Villanueva, "Early-stage topological and technological choices for tsn-based communication," in *2019 IEEE Standards Association (IEEE-SA) Ethernet & IP @ Automotive Technology Day*, Sep. 2019, (Accessed on 07/04/2023).
- [29] N. N. Hoai Hoang Bengtsson, "Time-predictable communication in service-oriented architecture - what are the challenges?" in *Automotive Ethernet Congress*, Mar. 2023, (Accessed on 07/04/2023).
- [30] Volvo, "Overview – apis — volvo cars developer portal," <https://developer.volvocars.com/apis/>, (Accessed on 06/28/2023).
- [31] Junko Yoshida, "Unveiled: Bmw's scalable av architecture," <https://www.eetimes.com/unveiled-bmws-scalable-av-architecture/>, Apr. 2020, (Accessed on 05/04/2023).
- [32] P. Laclau, "Ethernet-as-a-Service for Software Defined Vehicles: Design objectives and orientations for an Ethernet-based network stack," *IEEE SA Ethernet & IP @ Automotive Technology Day*, pp. 1–22, 2022. [Online]. Available: <https://standards.ieee.org/events/automotive/presentations-2022/>
- [33] A. J. Hawkins, "Gm now has its own api for software developers to make cool apps for its cars - the verge," <https://www.theverge.com/2023/10/12/23914060/gm-us-services-api-software-apps-car-sdv>, Oct. 2023, (Accessed on 04/16/2024).
- [34] SOME/IP, "Scalable service-oriented middleware over ip," <https://some-ip.com/>, (Accessed on 04/28/2023).
- [35] E. S. D. V. W. Group, "202401\_sdv member's meeting jan 2024," [https://docs.google.com/presentation/d/1uU4\\_BevDGuxFmEVvxt5-u99UZELF7BA2bEp2TneFZGw](https://docs.google.com/presentation/d/1uU4_BevDGuxFmEVvxt5-u99UZELF7BA2bEp2TneFZGw), Jan. 2024, (Accessed on 04/16/2024).
- [36] Z. Liu, W. Zhang, and F. Zhao, "Impact, challenges and prospect of software-defined vehicles," *Automotive Innovation*, vol. 5, no. 2, pp. 180–194, 2022.
- [37] J. W. Edward Taylor, Norihiko Shirouzu, "How tesla defined a new era for the global auto industry — reuters," <https://www.reuters.com/article/us-autos-tesla-newera-insight-idUSKCN24N0GB>, Jul. 2020, (Accessed on 04/28/2023).
- [38] S. Zhang, O. Makke, O. Gusikhin, A. Shah, and A. Vasilakos, "A security model for dependable vehicle middleware and mobile applications connection," in *Proceedings of the 4th International Conference on Vehicle Technology and Intelligent Transport Systems*. SCITEPRESS - Science and Technology Publications, 2018.
- [39] M. Kais, N. Hafez, and M. Parent, "An intelligent vehicle architecture for automated transportation in cities," in *2001 European Control Conference (ECC)*, 2001, pp. 277–282.
- [40] P. Fromm and P. Drews, "Modular, service-oriented design and architecture of smart vehicles for short distance person and freight transport," in *IECON '98. Proceedings of the 24th Annual Conference of the IEEE Industrial Electronics Society (Cat. No.98CH36200)*, vol. 4, 1998, pp. 2192–2197.
- [41] J. Albus, M. Juberts, and S. Szabo, "A reference model architecture for intelligent vehicle and highway systems," in *Proceedings of the Intelligent Vehicles '92 Symposium*, 1992, pp. 378–384.
- [42] Vector, "Autosar basic software and beyond - cutting edge automotive ecu development," <https://www.youtube.com/watch?v=vMaPqBLQ1Fw>, Nov. 2020, (Accessed on 07/04/2023).
- [43] S. Voget, "Autosar and the automotive tool chain," in *2010 Design, Automation & Test in Europe Conference & Exhibition (DATE 2010)*, 2010, pp. 259–262.
- [44] S. Füst and M. Bechter, "Autosar for connected and autonomous vehicles: The autosar adaptive platform," in *2016 46th Annual IEEE/I-FIP International Conference on Dependable Systems and Networks Workshop (DSN-W)*, 2016, pp. 215–217.
- [45] J. M. Josetxo Villanueva and N. Navet, "Qos-predictable soa on tsn: Insights from a case-study," in *Automotive Ethernet Congress*, Feb. 2021, (Accessed on 07/04/2023).
- [46] OASIS, "Oasis soa reference model tc," [https://www.oasis-open.org/committees/tc\\_home.php?wg\\_abbrev=soa-rm](https://www.oasis-open.org/committees/tc_home.php?wg_abbrev=soa-rm), (Accessed on 05/04/2023).
- [47] C. Hewitt, "Actor model of computation: Scalable robust information systems," 2015.
- [48] M. Richards, *Microservices vs. service-oriented architecture*. O'Reilly Media Sebastopol, 2015.
- [49] NXP Semiconductors, "Vehicle architectures and networking training academy," <https://www.nxp.com/design/training/vehicle-architectures-and-networking-training-academy:TS-VEHICLE-ARCHITECTURES-AND-NETWORKING-ACADEMY>, (Accessed on 07/01/2023).
- [50] H. H. Bengtsson, M. Hiller, J. Migge, and N. NAVET, "Signal-oriented ecus in a centralized service-oriented architecture: Scalability of the layered software architecture," 01 June 2022.
- [51] DDS Foundation, "How does dds compare to other iot technologies?" <https://www.dds-foundation.org/features-benefits/>, (Accessed on 07/12/2023).
- [52] J. S. Andrei Terechko, Yuting Fu, "Middleware for safe software-defined cars," [https://www.sasg.nl/SASG\\_72\\_Roly-poly\\_on\\_middleware.pdf](https://www.sasg.nl/SASG_72_Roly-poly_on_middleware.pdf), Oct. 2021, (Accessed on 04/18/2024).
- [53] Zenoh, "Developer documentation," <https://zenoh.io/docs/overview/what-is-zenoh/>, Jan. 2023, (Accessed on 04/20/2024).
- [54] W.-Y. Liang, Y. Yuan, and H.-J. Lin, "A performance study on the throughput and latency of zenoh, mqtt, kafka, and dds," 2023. [Online]. Available: <https://arxiv.org/abs/2303.09419>
- [55] J. Ren, M. Zhao, H. Wang, T. Gao, P. Yao, and Z. Shao, "A time sensitive network-based data distribution service implementation method," in *2022 International Symposium on Advances in Informatics, Electronics and Education (ISAIEE)*. IEEE, Dec. 2022.
- [56] L. Leonardi, L. L. Bello, and G. Patti, "Towards time-sensitive networking in heterogeneous platforms with virtualization," in *2020 25th IEEE International Conference on Emerging Technologies and Factory Automation (ETFA)*. IEEE, Sep. 2020.
- [57] B. Caruso, L. Leonardi, L. L. Bello, and G. Patti, "Design of a framework for enabling TSN support in heterogeneous platforms with virtualization and preliminary experimental results," in *2021 26th IEEE International Conference on Emerging Technologies and Factory Automation (ETFA)*. IEEE, Sep. 2021.
- [58] H. Sami, A. Mourad, and W. El-Hajj, "Vehicular-obus-as-on-demand-fogs: Resource and context aware deployment of containerized micro-services," *IEEE/ACM Transactions on Networking*, vol. 28, no. 2, pp. 778–790, 2020.
- [59] A. Garbugli, L. Rosa, A. Bujari, and L. Foschini, "Kubernetsn: a deterministic overlay network for time-sensitive containerized environments," in *ICC 2023 - IEEE International Conference on Communications*. IEEE, May 2023.
- [60] V. Meyer, M. L. da Silva, D. F. Kirchoff, and C. A. De Rose, "Iada: A dynamic interference-aware cloud scheduling architecture for latency-sensitive workloads," *Journal of Systems and Software*, vol. 194, p. 111491, 2022. [Online]. Available: <https://www.sciencedirect.com/science/article/pii/S0164121222001698>
- [61] C. S. V. Gutiérrez, L. U. S. Juan, I. Z. Ugarte, and V. M. Vilches, "Real-time linux communications: an evaluation of the linux communication stack for real-time robotic applications," 2018.
- [62] C. U. Marius Rotaru, "Service oriented architecture: Design and implementation using automotive linux bsp," <https://www.nxp.com.cn/docs/en/training-reference-material/DESIGN-AND-IMPLEMENTATION-USING-AUTOMOTIVE-LINUX-BSP.pdf>, Jun. 2019, (Accessed on 05/24/2023).
- [63] P. Kleiner, "Autosar adaptive deployment with oci containers for embedded using vxworks," Sep. 2019, (Accessed on 07/04/2023).
- [64] I. Ugrean, "Timing comparison of the real-time operating systems for small microcontrollers," *Symmetry*, vol. 12, no. 4, 2020. [Online]. Available: <https://www.mdpi.com/2073-8994/12/4/592>
- [65] P. Wilms and F. Hurley, "Centralised software and zonal architectures for future innovative ambient lighting enabled by E2B 10Base-T1S," *IEEE SA Ethernet & IP @ Automotive Technology Day*, 2022. [Online]. Available: <https://standards.ieee.org/events/automotive/presentations-2022/>

- [66] B. Petersen, "Signal to Service : Remote Control of Legacy Networks," *IEEE SA Ethernet & IP @ Automotive Technology Day*, no. November, 2022. [Online]. Available: <https://standards.ieee.org/events/automotive/presentations-2022/>
- [67] B. N. Amel, B. Rim, J. Houada, H. Salem, and J. Khaled, "Flexray versus ethernet for vehicular networks," in *2014 IEEE International Electric Vehicle Conference (IEVC)*. IEEE, Dec. 2014.
- [68] T.-C. Nichitelea and M.-G. Unguritu, "Automotive ethernet applications using scalable service-oriented middleware over IP: Service discovery," in *2019 24th International Conference on Methods and Models in Automation and Robotics (MMAR)*. IEEE, Aug. 2019.
- [69] M. Takrouni, A. Hasnaoui, I. Mejri, and S. Hasnaoui, "A new methodology for implementing the data distribution service on top of gigabit ethernet for automotive applications," *Journal of Circuits, Systems and Computers*, vol. 29, no. 13, p. 2050210, Mar. 2020.
- [70] Vector, "Can/can fd/can xl," <https://www.vector.com/int/en/known-how/can/>, (Accessed on 05/09/2023).
- [71] Z. Zuo, S. Yang, B. Ma, B. Zou, Y. Cao, Q. Li, S. Zhou, and J. Li, "Design of a CANFD to SOME/IP gateway considering security for in-vehicle networks," *Sensors*, vol. 21, no. 23, p. 7917, Nov. 2021.
- [72] NI, "FlexRay Automotive Communication Bus Overview." [Online]. Available: <https://www.ni.com/pt-pt/shop/seamlessly-connect-to-third-party-devices-and-supervisory-system/flexray-automotive-communication-bus-overview.html>
- [73] Microchip, "Most technology," <https://www.microchip.com/en-us/solutions/automotive-and-transportation/automotive-products/connectivity/most-technology>, (Accessed on 07/03/2023).
- [74] N. Dasanayaka, K. F. Hasan, C. Wang, and Y. Feng, "Enhancing Vulnerable Road User Safety: A Survey of Existing Practices and Consideration for Using Mobile Devices for V2X Connections," *arXiv preprint arXiv:2010.15502*, 2020.
- [75] R. Mishra, "An overview of backbone technology behind the latest advanced gadgets in use: 4g & 5g," *Spatial Information Research*, vol. 31, no. 1, pp. 15–26, Feb. 2023. [Online]. Available: <https://doi.org/10.1007/s41324-022-00474-1>
- [76] H. Fourati, R. Maaloul, and L. Chaari, "A survey of 5g network systems: challenges and machine learning approaches," *International Journal of Machine Learning and Cybernetics*, vol. 12, no. 2, pp. 385–431, Feb. 2021. [Online]. Available: <https://doi.org/10.1007/s13042-020-01178-4>
- [77] G. Naik, D. Ogbe, and J.-M. J. Park, "Can wi-fi 7 support real-time applications? on the impact of multi link aggregation on latency," in *ICC 2021 - IEEE International Conference on Communications*, 2021, pp. 1–6.
- [78] IEEE, "Ieee standard for information technology–telecommunications and information exchange between systems local and metropolitan area networks–specific requirements part 11: Wireless lan medium access control (mac) and physical layer (phy) specifications amendment 6: Light communications," *IEEE Std 802.11bb-2023 (Amendment to IEEE Std 802.11-2020 as amended by IEEE Std 802.11ax-2021, IEEE Std 802.11ay-2021, IEEE Std 802.11ba-2021, IEEE Std 802.11az-2022, IEEE Std 802.11-2020/Cor 1-2022, and IEEE Std 802.11bd-2023)*, pp. 1–37, 2023.
- [79] P. Teixeira, S. Sargento, P. Rito, M. Luís, and F. Castro, "A sensing, communication and computing approach for vulnerable road users safety," *IEEE Access*, vol. 11, pp. 4914–4930, 2023.
- [80] E. Moradi-Pari, D. Tian, M. Bahramgiri, S. Rajab, and S. Bai, "Dsrc versus lte-v2x: Empirical performance analysis of direct vehicular communication technologies," *IEEE Transactions on Intelligent Transportation Systems*, vol. 24, no. 5, pp. 4889–4903, 2023.
- [81] B. Y. Yacheur, T. Ahmed, and M. Mosbah, "Analysis and comparison of ieee 802.11p and ieee 802.11bd," in *Communication Technologies for Vehicles*, F. Krief, H. Aniss, L. Mendiboure, S. Chaumette, and M. Berbineau, Eds. Cham: Springer International Publishing, 2020, pp. 55–65.
- [82] E. Khorov and I. Levitsky, "Current status and challenges of li-fi: Ieee 802.11bb," *IEEE Communications Standards Magazine*, vol. 6, no. 2, pp. 35–41, 2022.
- [83] O. Alparlan, S. Arakawa, and M. Murata, "Next Generation Intra-Vehicle Backbone Network Architectures," in *2021 IEEE 22nd International Conference on High Performance Switching and Routing (HPSR)*. IEEE, Jun. 2021, pp. 1–7. [Online]. Available: <https://ieeexplore.ieee.org/document/9481803/>
- [84] G. Naik, B. Choudhury, and J.-M. Park, "Ieee 802.11bd & 5g nr v2x: Evolution of radio access technologies for v2x communications," *IEEE Access*, vol. 7, pp. 70 169–70 184, 2019. [Online]. Available: <https://ieeexplore.ieee.org/document/8723326/>
- [85] M. H. Farzaneh and A. Knoll, "Time-sensitive networking (TSN): An experimental setup," in *2017 IEEE Vehicular Networking Conference (VNC)*. IEEE, Nov. 2017, pp. 23–26. [Online]. Available: <http://ieeexplore.ieee.org/document/8275648/>
- [86] Q. Bailleul, K. Jaffres-Runser, J.-L. Scharbag, and P. Cuenot, "Towards robust network synchronization with ieee 802.1 as," *ETR 20*, p. 25, 2020.
- [87] R. Lopes, D. Raposo, and S. Sargento, "Towards time sensitive networking on smart cities: Techniques, challenges, and solutions," 2023. [Online]. Available: <https://arxiv.org/abs/2312.03635>
- [88] M. Malinverno, G. Avino, C. Casetti, C. F. Chiasserini, F. Malandrino, and S. Scarpina, "Edge-Based Collision Avoidance for Vehicles and Vulnerable Users: An Architecture Based on MEC," *IEEE Vehicular Technology Magazine*, vol. 15, no. 1, pp. 27–35, Mar. 2020.
- [89] A. Khakimov, A. Loborchuk, I. Ibodulokhodzha, D. Poluektov, I. A. Elgendy, and A. Muthanna, "Edge computing resource allocation orchestration system for autonomous vehicles," in *The 4th International Conference on Future Networks and Distributed Systems (ICFNDS)*. ACM, Nov. 2020.
- [90] Y. Seol, D. Hyeon, J. Min, M. Kim, and J. Paek, "Timely Survey of Time-Sensitive Networking: Past and Future Directions," *IEEE Access*, vol. 9, pp. 142 506–142 527, 2021. [Online]. Available: <https://ieeexplore.ieee.org/document/9576720/>
- [91] J. F. Carlos J. Bernardos, "Ietf reliable available wireless (raw)," <https://www.ieee802.org/1/files/public/docs2023/tutorial-bernardos-farkas-RAW-0723-v01.pdf>, Jul. 2023, (Accessed on 12/21/2023).
- [92] N. Finn, P. Thubert, B. Varga, and J. Farkas, "Deterministic Networking Architecture," RFC 8655, Oct. 2019. [Online]. Available: <https://www.rfc-editor.org/info/rfc8655>
- [93] X. Geng, Y. Ryoo, D. Fedyk, R. Rahman, and Z. Li, "Deterministic Networking (DetNet) YANG Model," Internet Engineering Task Force, Internet-Draft draft-ietf-detnet-yang-18, Jul. 2023, work in Progress. [Online]. Available: <https://datatracker.ietf.org/doc/draft-ietf-detnet-yang/18/>
- [94] E. Grossman, "Deterministic Networking Use Cases," RFC 8578, May 2019. [Online]. Available: <https://www.rfc-editor.org/info/rfc8578>
- [95] IEEE, "Ieee standard for local and metropolitan area networks–frame replication and elimination for reliability," *IEEE Std 802.1CB-2017*, pp. 1–102, Oct. 2017.
- [96] —, "Ieee standard for local and metropolitan area networks– virtual bridged local area networks amendment 12: Forwarding and queuing enhancements for time-sensitive streams," *IEEE Std 802.1Qav-2009 (Amendment to IEEE Std 802.1Q-2005)*, pp. 1–72, Jan. 2010.
- [97] —, "Ieee standard for local and metropolitan area networks – bridges and bridged networks - amendment 25: Enhancements for scheduled traffic," *IEEE Std 802.1Qbv-2015*, pp. 1–57, Mar. 2016.
- [98] H. Wang, Z. Zhao, and J. Wei, "Research on the application of time sensitive networking in unmanned in-vehicle network," in *ISCTT 2021; 6th International Conference on Information Science, Computer Technology and Transportation*, Nov. 2021, pp. 1–8.
- [99] Y. Ozawa and Y. Ito, "Evaluation of TCP Performance Under In-Vehicle Networks With IEEE 802.1 TSN," in *2022 IEEE 11th Global Conference on Consumer Electronics (GCCE)*. IEEE, Oct. 2022, pp. 668–669. [Online]. Available: <https://ieeexplore.ieee.org/document/10014097/>
- [100] M. Ulbricht, S. Senk, H. K. Nazari, H.-H. Liu, M. Reisslein, G. T. Nguyen, and F. H. P. Fitzek, "TSN-FlexTest: Flexible TSN Measurement Testbed (Extended Version)," Nov. 2022.
- [101] L. Deng, G. Xie, H. Liu, Y. Han, R. Li, and K. Li, "A survey of real-time ethernet modeling and design methodologies: From avb to tsn," *ACM Comput. Surv.*, vol. 55, no. 2, Jan. 2022.
- [102] S. Samii and H. Zinner, "Level 5 by layer 2: Time-sensitive networking for autonomous vehicles," *IEEE Communications Standards Magazine*, vol. 2, no. 2, pp. 62–68, 2018.
- [103] D. Cavalcanti, J. Perez-Ramirez, M. M. Rashid, J. Fang, M. Galeev, and K. B. Stanton, "Extending accurate time distribution and timeliness capabilities over the air to enable future wireless industrial automation systems," *Proceedings of the IEEE*, vol. 107, no. 6, pp. 1132–1152, 2019.
- [104] A. Regev and M. Gubow, "PHY latency and its effects on TSN performance," *IEEE SA Ethernet & IP @ Automotive Technology Day*, pp. 1–18, 2022. [Online]. Available: <https://standards.ieee.org/events/automotive/presentations-2022/>
- [105] T. H. Christian Mardmoeller, "Time-sensitive networking," U.S. patent US11 811 665B2, Nov. 7, 2023.

- [106] Z. Satka, M. Ashjaei, H. Fotouhi, M. Daneshalab, M. Sjödin, and S. Mubeen, "A comprehensive systematic review of integration of time sensitive networking and 5g communication," *Journal of Systems Architecture*, vol. 138, p. 102852, 2023. [Online]. Available: <https://www.sciencedirect.com/science/article/pii/S1383762123000310>
- [107] Cisco, "Time-sensitive networking: A technical introduction," Online, 2017. [Online]. Available: <https://www.cisco.com/c/dam/en/us/solutions/collateral/industry-solutions/white-paper-c11-738950.pdf>
- [108] L. Zhao, F. He, E. Li, and J. Lu, "Comparison of time sensitive networking (tsn) and tternet," in *2018 IEEE/AIAA 37th Digital Avionics Systems Conference (DASC)*, 2018, pp. 1–7.
- [109] S. S. Craciunas, R. S. Oliver, and T. Ag, "An overview of scheduling mechanisms for time-sensitive networks," *Proceedings of the Real-time summer school L'École d'Été Temps Réel (ETR)*, pp. 1551–3203, 2017.
- [110] A. Goldsmith, *Path Loss and Shadowing*. Cambridge University Press, 2005, pp. 27–63.
- [111] A. F. M. S. Shah, A. N. Qasim, M. A. Karabulut, H. Ilhan, and M. B. Islam, "Survey and performance evaluation of multiple access schemes for next-generation wireless communication systems," *IEEE Access*, vol. 9, pp. 113 428–113 442, 2021.
- [112] J. V. e. a. Luis M. Contreras, Antonio de la Oliva, "Analysis of use cases and system requirements," PREDICT6G, Report D11, Jun. 2023, published. [Online]. Available: <https://predict-6g.eu/deliverables/>
- [113] H. N. N. e. a. Dhruvin Patel, Edgardo Montes de Oca, "Use Cases and Architecture Principles," DETERMINISTIC6G, Report D11, Jun. 2023, published. [Online]. Available: <https://deterministic6g.eu/images/deliverables/DETERMINISTIC6G-D1.1-v1.0.pdf>
- [114] D. Cavalcanti, C. Cordeiro, M. Smith, and A. Regev, "Wifi tsn: Enabling deterministic wireless connectivity over 802.11," *IEEE Communications Standards Magazine*, vol. 6, no. 4, pp. 22–29, 2022.
- [115] E. Haleplidis, K. Pentikousis, S. Denazis, J. H. Salim, D. Meyer, and O. Koufopavlou, "Software-Defined Networking (SDN): Layers and Architecture Terminology," RFC 7426, Jan. 2015. [Online]. Available: <https://www.rfc-editor.org/info/rfc7426>
- [116] D. P. Hubertus Munz, Torsten Dudda, "Technique for time-sensitive networking over a radio access network," U.S. patentus US11 265 805B2, Mar. 1, 2022.
- [117] O. Seijo, J. A. López-Fernández, and I. Val, "w-sharp: Implementation of a high-performance wireless time-sensitive network for low latency and ultra-low cycle time industrial applications," *IEEE Transactions on Industrial Informatics*, vol. 17, no. 5, pp. 3651–3662, 2021.
- [118] ETSI (European Telecommunications Standards Institute), "ETSI TS 123 501 V16.5.1 / 3GPP TS 23.501 version 16.5.1 Release 16," ETSI (European Telecommunications Standards Institute), Tech. Rep., 2020.
- [119] 5G Alliance for Connected Industries and Automation, "Integration of 5g with time-sensitive networking for industrial communications," <https://5g-acia.org/whitepapers/integration-of-5g-with-time-sensitive-networking-for-industrial-communications/>, Feb. 2021.
- [120] R. P. Joseph Vinay, "Quality of service mapping for time-sensitive network traffic in a wireless communication system," English patentus US11 202 222B2, Dec. 14, 2021.
- [121] Z. Satka, M. Ashjaei, H. Fotouhi, M. Daneshalab, M. Sjödin, and S. Mubeen, "Qos-man: A novel qos mapping algorithm for tsn-5g flows," in *2022 IEEE 28th International Conference on Embedded and Real-Time Computing Systems and Applications (RTCSA)*, 2022, pp. 220–227.
- [122] Z. Satka, D. Pantzar, A. Magnusson, M. Ashjaei, H. Fotouhi, M. Sjödin, M. Daneshalab, and S. Mubeen, "Developing a translation technique for converged tsn-5g communication," in *2022 IEEE 18th International Conference on Factory Communication Systems (WFCS)*, 2022, pp. 1–8.
- [123] A. Larrañaga, M. C. Lucas-Estañ, I. Martínez, I. Val, and J. Gozalvez, "Analysis of 5g-tns integration to support industry 4.0," in *2020 25th IEEE International Conference on Emerging Technologies and Factory Automation (ETFA)*, vol. 1, 2020, pp. 1111–1114.
- [124] P. Kehl, J. Ansari, M. H. Jafari, P. Becker, J. Sachs, N. König, A. Göppert, and R. H. Schmitt, "Prototype of 5g integrated with tsn for edge-controlled mobile robotics," *Electronics*, vol. 11, no. 11, 2022. [Online]. Available: <https://www.mdpi.com/2079-9292/11/11/1666>
- [125] N. Ambrosy, T. Kampa, U. Jumar, and D. Großmann, "5g and detnet: Towards holistic determinism in industrial networks," in *2022 IEEE International Conference on Industrial Technology (ICIT)*, 2022, pp. 1–6.
- [126] M. H. Farzaneh and A. Knoll, "An ontology-based plug-and-play approach for in-vehicle time-sensitive networking (tsn)," in *2016 IEEE 7th Annual Information Technology, Electronics and Mobile Communication Conference (IEMCON)*, Oct. 2016, pp. 1–8.
- [127] A. A. Syed, S. Ayaz, T. Leinmuller, and M. Chandra, "Fault-Tolerant Static Scheduling and Routing for In-vehicle Networks," in *2022 32nd International Telecommunication Networks and Applications Conference (ITNAC)*. IEEE, Nov. 2022, pp. 273–279. [Online]. Available: <https://ieeexplore.ieee.org/document/9998340>
- [128] J. Zou, X. Dai, and J. A. McDerimid, "reTSN: Resilient and Efficient Time-Sensitive Network for Automotive In-Vehicle Communication," *IEEE Transactions on Computer-Aided Design of Integrated Circuits and Systems*, vol. 42, no. 3, pp. 754–767, Mar. 2023. [Online]. Available: <https://ieeexplore.ieee.org/document/9826899/>
- [129] D. Wang and T. Sun, "Leveraging 5G TSN in V2X Communication for Cloud Vehicle," in *2020 IEEE International Conference on Edge Computing (EDGE)*. IEEE, Oct. 2020, pp. 106–110. [Online]. Available: <https://ieeexplore.ieee.org/document/9284334/>
- [130] P. Ding, D. Liu, Y. Shen, H. Duan, and Q. Zheng, "Edge-to-Cloud Intelligent Vehicle-Infrastructure Based on 5G Time-Sensitive Network Integration," in *2022 IEEE International Symposium on Broadband Multimedia Systems and Broadcasting (BMSB)*. IEEE, Jun. 2022, pp. 1–5. [Online]. Available: <https://ieeexplore.ieee.org/document/9828687/>
- [131] C. Maclair, M. Gutiérrez, J. Migge, and N. Navet, "Do we really need tsn in next-generation helicopters? insights from a case-study," in *2021 IEEE/AIAA 40th Digital Avionics Systems Conference (DASC)*, 2021, pp. 1–7.
- [132] Intel Corporation, "Mobileye's self-driving secret? 200pb of data," <https://www.intel.com/content/www/us/en/newsroom/news/mobileye-ces-2022-self-driving-secret-data.html>, Jan. 2022, (Accessed on 07/20/2023).
- [133] Mathworks, "Next generation wi fi networks for time critical applications," <https://www.mathworks.com/content/dam/mathworks/mathworks-dot-com/images/events/matlabexpo/us/2019/next-generation-wi-fi-networks-for-time-critical-applications.pdf>, Nov. 2019, (Accessed on 05/08/2023).
- [134] A. Pretschner, M. Broy, I. H. Kruger, and T. Stauner, "Software engineering for automotive systems: A roadmap," in *Future of Software Engineering (FOSE '07)*. IEEE, May 2007.
- [135] 5GAA, "C-V2X Use Cases : Methodology, Examples and Service Level Requirements," 5GAA, Tech. Rep., 2019. [Online]. Available: [https://5gaa.org/content/uploads/2019/07/5GAA\\_191906\\_WP\\_CV2X\\_UCs\\_v1-3-1.pdf](https://5gaa.org/content/uploads/2019/07/5GAA_191906_WP_CV2X_UCs_v1-3-1.pdf)
- [136] ETSI (European Telecommunications Standards Institute), "TS 103 561 V0.0.2 (2022-09) - Manoeuvres' Coordination Service; Release 2," ETSI (European Telecommunications Standards Institute), Tech. Rep., 2022.
- [137] t. E. Jobst and C. Prehofer, "Towards hierarchical information architectures in automotive systems," in *2016 3rd International Workshop on Emerging Ideas and Trends in Engineering of Cyber-Physical Systems (EITEC)*. IEEE, Apr. 2016.
- [138] Y. Asabe, E. Javanmardi, J. Nakazato, M. Tsukada, and H. Esaki, "Autawarev2x: Reliable v2x communication and collective perception for autonomous driving," in *The 2023 IEEE 97th Vehicular Technology Conference (VTC2023-Spring)*, Florence, Italy, Jun. 2023.
- [139] Z. Laaroussi, R. Morabito, and T. Taleb, "Service provisioning in vehicular networks through edge and cloud: An empirical analysis," in *2018 IEEE Conference on Standards for Communications and Networking (CSCN)*. IEEE, Oct. 2018.
- [140] StarlingX, "Time sensitive networking," <https://docs.starlingx.io/operations/tsn.html>, Apr. 2024, (Accessed on 04/16/2024).
- [141] INET, "Time-aware shaping," <https://inet.omnetpp.org/docs/showcases/tsn/trafficshaping/timeawareshaper/doc/index.html>, Feb. 2023, (Accessed on 04/16/2024).
- [142] K. Kasichainula, "Time sensitive networking device," U.S. patentus US10754816, Aug. 25, 2020.
- [143] S. Bush, "Time sensitive network (tsn) scheduler with verification," English patentus US11 121 978B2, Sep. 14, 2021.
- [144] G. Patti, L. L. Bello, and L. Leonardi, "Deadline-aware online scheduling of tsn flows for automotive applications," *IEEE Transactions on Industrial Informatics*, 2022.
- [145] C. Sommer, R. German, and F. Dressler, "Bidirectionally coupled network and road traffic simulation for improved ivc analysis," *IEEE Transactions on Mobile Computing*, vol. 10, no. 1, pp. 3–15, 2011.
- [146] M. Takrouni, M. Gdhaifi, A. Hasnaoui, I. Mejri, and S. Hasnaoui, "Design and implementation of a simuLink DDS blockset and its integration to an active frame steering blockset conformed to SAE ElectricVehicle," in *2017 IEEE/ACS 14th International Conference on Computer Systems and Applications (AICCSA)*. IEEE, Oct. 2017.