

Slalom numbers

Miguel A. Cardona^{1,2}

Einstein Institute of Mathematics, The Hebrew University of Jerusalem. Givat Ram, Jerusalem, 9190401, Israel

Viera Gavalová¹

Department of Applied Mathematics and Business Informatics, Faculty of Economics of the Technical University of Košice, Némcovej 32, 040 01 Košice, Slovakia

Diego A. Mejía³

Graduate School of System Informatics, Kobe University, 1-1 Rokkodai-cho, Nada-ku, Kobe, Hyogo 657-8501, Japan

Miroslav Repický^{1,4}

Mathematical Institute, Slovak Academy of Sciences, Grešákova 6, 040 01 Košice, Slovak Republic.

Jaroslav Šupina^{1,5}

Institute of Mathematics, P.J. Šafárik University in Košice, Jesenná 5, 040 01 Košice, Slovakia

Abstract

The paper is an extensive and systematic study of cardinal invariants we call slalom numbers, describing the combinatorics of sequences of sets of natural numbers. Our general approach, based on relational systems, covers many such cardinal characteristics, including localization and anti-localization cardinals. We show that most of the slalom numbers are connected to topological selection principles, in particular, we obtain the representation of the uniformity of meager and the cofinality of measure. Considering instances of slalom numbers parametrized by ideals on natural numbers, we focus on monotonicity properties with respect to ideal orderings and computational formulas for the disjoint sum of ideals. Hence, we get such formulas for several pseudo-intersection numbers as well as for the bounding and dominating numbers parametrized with ideals. Based on the effect of adding a Cohen real, we get many consistent constellations of different values of slalom numbers.

Keywords: ideal, slalom, localization, selection principle, cardinal invariant, Cohen real

2020 MSC: 03E17, 03E35, 54G15, 54D20, 03E40

Email addresses: miguel.cardona@mail.huji.ac.il (Miguel A. Cardona), viera.gavalova@tuke.sk (Viera Gavalová), damejiag@people.kobe-u.ac.jp (Diego A. Mejía), repicky@saske.sk (Miroslav Repický), jaroslav.supina@upjs.sk (Jaroslav Šupina)

¹Supported by the Slovak Research and Development Agency under the Contract no. APVV-20-0045.

²Supported by Pavol Jozef Šafárik University in Košice at a postdoctoral position, and by Israel Science Foundation for partial support of this research by grant 2320/23 (2023-2027).

³Supported by the Grant-in-Aid for Scientific Research (C) 23K03198, Japan Society for the Promotion of Science.

⁴Supported by the grant VEGA 2/0104/24 of the Slovak Grant Agency VEGA.

⁵Supported by the grant VEGA 1/0657/22 of the Slovak Grant Agency VEGA.

1. Introduction

The notion of slalom, as a function $\omega \rightarrow [\omega]^{<\aleph_0}$, appeared implicitly in [Bar84] to prove that the additivity of measure is below the additivity of category. Later, Bartoszyński [Bar87] introduced the notion explicitly. It has been proven to be highly important in studying combinatorial properties of measure and category, namely, to characterize and approximate classical cardinal invariants of the continuum, like those in Cichoń’s diagram. In recent literature, the slalom-based cardinal invariants are usually called *localization and anti-localization cardinals*. The papers [CM19, CM23] are deep surveys on these invariants with a long list of research sources dedicated to their studies, starting in the 80’s and continuing to present-day results and modern treatment [Mil82, Paw85, GS93, KS12, KO14, BM14, CKM24]. We list some sources in Remark 3.3 to compare all known notations. The localization and anti-localization cardinals are instances of what we denominate *slalom numbers* or *slalom invariants*.

Many classical cardinal invariants of the continuum have been studied, in a more general form, parametrized by an ideal J on the natural numbers, see e.g. [BM99, FS09, Hru11, BF12, HST22, FK22, RS23, Š23] (throughout this text, we convey that an ideal contains all the finite sets). Very recently, the second and third authors [GM23] developed a version of the Lebesgue measure zero ideal \mathcal{N} and the σ -ideal \mathcal{E} generated by F_σ -measure zero sets modulo ideals on the natural numbers, and studied their associated cardinal invariants. These are denoted by \mathcal{N}_J and \mathcal{N}_J^* , respectively, for any ideal J on the natural numbers.

In this paper, we propose a general framework to define slalom numbers parametrized with ideals. Within this framework, we prove general theorems about their connections and show several applications to particular cases that have already appeared in previous research, as well as consistency results. We also study *selection principles* under this framework.

Instances of slalom numbers

Considering a function $h \in {}^\omega\omega$ and an ideal J on natural numbers, the paper focuses on slalom invariants of the following form [Šot20]:

$$\mathfrak{sl}_t(h, J) = \min \left\{ |\mathcal{S}| : \mathcal{S} \subseteq \prod_{n \in \omega} [\omega]^{\leq h(n)} \wedge (\forall x \in {}^\omega\omega) (\exists s \in \mathcal{S}) \{n \in \omega : x(n) \notin s(n)\} \in J \right\},$$

$$\mathfrak{sl}_e(h, J) = \min \left\{ |\mathcal{S}| : \mathcal{S} \subseteq \prod_{n \in \omega} [\omega]^{\leq h(n)} \wedge (\forall x \in {}^\omega\omega) (\exists s \in \mathcal{S}) \{n \in \omega : x(n) \in s(n)\} \notin J \right\}.$$

The classical instances of these numbers are obtained with $J = \text{Fin}$, the ideal of finite sets of natural numbers. Well-known results on the latter slalom numbers by Bartoszyński [Bar87, Bar84] and Miller [Mil82] state that $\text{cof}(\mathcal{N}) = \mathfrak{sl}_t(g, \text{Fin})$ when $\lim_{n \rightarrow \infty} g(n) = \infty$, and $\text{non}(\mathcal{M}) = \mathfrak{sl}_e(h, \text{Fin})$ when $h(n) \geq 1$ for all but finitely many $n \in \omega$. The dual forms of these slalom numbers characterize $\text{add}(\mathcal{N})$ and $\text{cov}(\mathcal{M})$, as well.

Considering $\mathcal{S} \subseteq {}^\omega I$ for an ideal I on ω instead of $\mathcal{S} \subseteq \prod_{n \in \omega} [\omega]^{\leq h(n)}$ in the definitions of $\mathfrak{sl}_t(h, J)$ and $\mathfrak{sl}_e(h, J)$ above, we obtain $\mathfrak{sl}_t(I, J)$ and $\mathfrak{sl}_e(I, J)$, see Section 3 for details. Moreover, we study two more cardinals $\mathfrak{sl}_t(\star, J)$, $\mathfrak{sl}_e(\star, J)$, allowing \mathcal{S} to be more general [Šup16, ŠŠ19, Šot19, Š23]. Basic relations among the invariants are depicted in Figure 1.

$$\begin{array}{ccccc} \mathfrak{sl}_t(\star, J) & \rightarrow & \mathfrak{sl}_t(I, J) & \rightarrow & \mathfrak{sl}_t(h, J) \\ \uparrow & & \uparrow & & \uparrow \\ \mathfrak{sl}_e(\star, J) & \rightarrow & \mathfrak{sl}_e(I, J) & \rightarrow & \mathfrak{sl}_e(h, J) \end{array}$$

Figure 1: Diagram of inequalities between slalom numbers. An arrow denotes that ZFC proves \leq .

These generalize more classical cardinal invariants, like the *dominating number* $\mathfrak{d} = \mathfrak{sl}_t(\text{Fin}, \text{Fin})$, the *bounding number* $\mathfrak{b} = \mathfrak{sl}_e(\text{Fin}, \text{Fin})$, and the *pseudo-intersection number* $\mathfrak{p} = \mathfrak{sl}_e(\star, \text{Fin})$ [Šup16, Š23]. We even obtain $\text{cov}(\mathcal{M}) = \mathfrak{sl}_t(\star, \text{Fin})$ (see [Š23] and Theorem 4.9). The ideal versions of the dominating and unbounding numbers are $\mathfrak{d}_J = \mathfrak{sl}_e(\text{Fin}, J)$ and $\mathfrak{b}_J = \mathfrak{sl}_t(\text{Fin}, J)$, i.e., those with respect to the relation $x \leq^{J^d} y$ iff $\{n \in \omega : x(n) > y(n)\} \in J$ on ${}^\omega\omega$. The study of \mathfrak{d}_J and \mathfrak{b}_J dates back to at least the 1980s, when dominating numbers modulo ultrafilters (i.e., maximal ideals) were used by R. Canjar [Can88] in the context of nonstandard arithmetic (to study the cofinality of ultrapowers of the natural numbers). Further research appears, for instance, in [BM99, TZ08, FS09].

The connections between the slalom numbers introduced so far are illustrated in Figure 2 (see [Šot20] and [Š23] for the diagram without the top row).

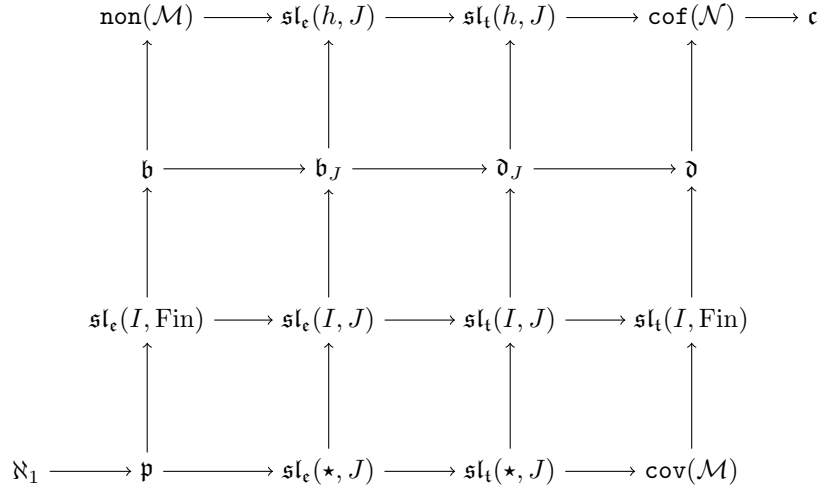

Figure 2: Relations among particular cases of slalom numbers.

We also look at combinatorial notions related with pseudo-intersection modulo ideals [BF12, Rep21a, Rep21b, Š23], and their counterparts, $\mathfrak{l}_K(\star, J)$ and $\mathfrak{l}_K(I, J)$, which are original in this paper. Here, \leq_K denotes the *Katětov order*.

$$\begin{aligned}
\mathfrak{p}_K(\star, J) &:= \min\{|A| : A \subseteq \mathcal{P}(\omega) \text{ generates an ideal and } A \leq_K J\}, \\
\mathfrak{l}_K(\star, J) &:= \min\{|A| : A \subseteq \mathcal{P}(\omega) \text{ generates an ideal and } A \leq_K J^{\text{dc}}\}, \\
\mathfrak{p}_K(I, J) &:= \min\{|A| : A \subseteq I \text{ and } A \leq_K J\}, \\
\mathfrak{l}_K(I, J) &:= \min\{|A| : A \subseteq I \text{ and } A \leq_K J^{\text{dc}}\}.
\end{aligned}$$

These invariants are upper bounds of the slalom numbers $\mathfrak{sl}_t(I, J)$ and $\mathfrak{sl}_e(I, J)$, as illustrated in Figure 3.

$$\begin{array}{ccc}
\mathfrak{sl}_t(I, J) & \rightarrow & \mathfrak{l}_K(I, J) \\
\uparrow & & \uparrow \\
\mathfrak{sl}_e(I, J) & \rightarrow & \mathfrak{p}_K(I, J)
\end{array}$$

Figure 3: Further connections between slalom numbers

It is known that $\mathfrak{p}_K(\star, \text{Fin}) = \mathfrak{p}$ and $\mathfrak{p}_K(I, \text{Fin}) = \text{cov}^*(I)$, where $\text{cov}^*(I)$ is a well-known idealized pseudo-intersection number, introduced for maximal ideals (dually for ultrafilters) in [BS99] under the notation $\pi\mathfrak{p}(\mathcal{U})$, whose current notation comes from [HH07].

General framework

We develop a general framework to define slalom numbers, using a single general definition that describes all the slalom numbers presented before (and much more), see [Definition 3.1](#). This framework allows general theorems that imply connections between slalom numbers, developed mainly in [Section 3](#). For instance, in [Section 4](#), we derive monotonicity properties of slalom numbers with respect to several orders of ideals, like the *Katětov order* and the *Katětov-Blass order*. As a consequence, \star -slalom numbers get characterized:

Theorem A ([Theorem 4.7](#)). *Let J be an ideal on ω . Then*

- (a) $\mathfrak{sl}_t(\star, J) = \min\{\mathfrak{sl}_t(I, J) : I \text{ is an ideal on } \omega\}$,
- (b) $\mathfrak{sl}_e(\star, J) = \min\{\mathfrak{sl}_e(I, J) : I \text{ is an ideal on } \omega\}$.

Concerning meager ideals, B. Tsaban and L. Zdomskyy [[TZ08](#)] have shown that $\mathfrak{b}_J = \mathfrak{b}$ for any meager ideal J on ω . Later on, B. Farkas and L. Soukup [[FS09](#)] have essentially complemented that $\mathfrak{d}_J = \mathfrak{d}$ as well. Similarly, the second and third authors [[GM23](#)] show that $\mathcal{N}_J = \mathcal{N}$ and $\mathcal{N}_J^* = \mathcal{E}$ when J is meager. We prove similar results for slalom numbers. The following result summarizes [Theorem 4.9](#), [Theorem 4.14](#), and [Theorem 4.21](#).

Theorem B. *Let I and J be ideals on ω , J with the Baire property, and $h \in {}^\omega\omega$. Then*

- (1) *If $h \geq 1$, then $\mathfrak{sl}_e(h, J) = \mathfrak{sl}_e(h, \text{Fin}) = \text{non}(\mathcal{M})$.*
- (2) *If $\lim_{n \in \omega} h(n) = \infty$, then $\mathfrak{sl}_t(h, J) = \mathfrak{sl}_t(h, \text{Fin}) = \text{cof}(\mathcal{N})$.*
- (3) $\mathfrak{sl}_t(I, J) = \mathfrak{sl}_t(I, \text{Fin})$.
- (4) $\mathfrak{sl}_t(\star, J) = \mathfrak{sl}_t(\star, \text{Fin}) = \text{cov}(\mathcal{M})$.
- (5) $\mathfrak{lk}(I, J) = \mathfrak{lk}(\star, J) = \infty$ (i.e., undefined).

To prove this theorem, we use Mathias', Jalali-Naini's, and Talagrand's characterization of the Baire property with the Rudin-Blass order,⁶ to which we apply our monotonicity results. The latter is deeply investigated in [Section 3](#) and [Section 4](#).

Disjoint sum of ideals

In [Section 5](#), we prove characterizations of slalom numbers modulo *disjoint sum of ideals*. Similar results appear in [[FK22](#), [GM23](#)].

Theorem C ([Theorem 5.7](#), [Theorem 5.8](#), and [Corollary 5.9](#)). *Let I_0, I_1, J_0 and J_1 be ideals on ω . Then:*

- (a) $\mathfrak{sl}_t(I_0 \oplus I_1, J_0) = \mathfrak{sl}_t(I_0 \cap I_1, J_0) = \max\{\mathfrak{sl}_t(I_0, J_0), \mathfrak{sl}_t(I_1, J_0)\}$.
- (b) $\mathfrak{sl}_e(I_0 \oplus I_1, \text{Fin}) = \mathfrak{sl}_e(I_0 \cap I_1, \text{Fin}) = \max\{\mathfrak{sl}_e(I_0, \text{Fin}), \mathfrak{sl}_e(I_1, \text{Fin})\}$.
- (c) $\mathfrak{lk}(I_0 \oplus I_1, J_0) = \mathfrak{lk}(I_0 \cap I_1, J_0) = \max\{\mathfrak{lk}(I_0, J_0), \mathfrak{lk}(I_1, J_0)\}$.
- (d) $\text{cov}^*(I_0 \oplus I_1) = \text{cov}^*(I_0 \cap I_1) = \max\{\text{cov}^*(I_0), \text{cov}^*(I_1)\}$.
- (e) $\mathfrak{sl}_t(I_0, J_0 \cap J_1) = \mathfrak{sl}_t(I_0, J_0 \oplus J_1) = \max\{\mathfrak{sl}_t(I_0, J_0), \mathfrak{sl}_t(I_0, J_1)\}$.
- (f) $\mathfrak{sl}_e(I_0, J_0 \cap J_1) \leq \mathfrak{sl}_e(I_0, J_0 \oplus J_1) = \min\{\mathfrak{sl}_e(I_0, J_0), \mathfrak{sl}_e(I_0, J_1)\}$.

⁶See, e.g., [[Far00](#)]. Note that an ideal J on ω has the Baire property if and only if J is meager.

- (g) $\mathfrak{l}_K(I_0, J_0 \cap J_1) = \mathfrak{l}_K(I_0, J_0 \oplus J_1) = \max\{\mathfrak{l}_K(I_0, J_0), \mathfrak{l}_K(I_0, J_1)\}$.
- (h) $\mathfrak{p}_K(I_0, J_0 \cap J_1) \leq \mathfrak{p}_K(I_0, J_0 \oplus J_1) = \min\{\mathfrak{p}_K(I_0, J_0), \mathfrak{p}_K(I_0, J_1)\}$.
- (i) $\mathfrak{sl}_t(\star, J_0 \oplus J_1) = \mathfrak{sl}_t(\star, J_0 \cap J_1) = \max\{\mathfrak{sl}_t(\star, J_0), \mathfrak{sl}_t(\star, J_1)\}$.
- (j) $\mathfrak{sl}_e(\star, J_0 \oplus J_1) = \min\{\mathfrak{sl}_e(\star, J_0), \mathfrak{sl}_e(\star, J_1)\}$.
- (k) $\mathfrak{l}_K(\star, J_0 \oplus J_1) = \mathfrak{l}_K(\star, J_0 \cap J_1) = \max\{\mathfrak{l}_K(\star, J_0), \mathfrak{l}_K(\star, J_1)\}$.
- (l) $\mathfrak{p}_K(\star, J_0 \oplus J_1) = \min\{\mathfrak{p}_K(\star, J_0), \mathfrak{p}_K(\star, J_1)\}$.
- (m) $\mathfrak{d}_{J_0 \oplus J_1} = \max\{\mathfrak{d}_{J_0}, \mathfrak{d}_{J_1}\}$.
- (n) $\mathfrak{b}_{J_0 \oplus J_1} = \min\{\mathfrak{b}_{J_0}, \mathfrak{b}_{J_1}\}$.

These results are relevant to obtain examples of ideals with different slalom numbers as part of our consistency results.

Selection principles

Systematic studies of selection principles were initiated in [Sch96, JMSS96]. The latter presents the list of uniformity numbers (or *critical cardinalities*) of studied selection principles in a form of standard cardinal invariants. For more recent sources, see [Buk11, Osi18, Buk19]. In [Šup16, ŠŠ19, Š23], it was pointed out that slalom numbers tend to be uniformity numbers of some selection principles. In Section 6, we propose a very general selection principle and derive its critical cardinality using the general definition of slalom number (Theorem 6.11). Many well-known and so far-unknown critical cardinalities are derived as direct consequences of this result. Below we present the new results. To show the flavor of the result, let us define selection principle $S_1(\Gamma_h, \mathcal{O})$ for a function $h \in {}^\omega\omega$, introduced first in [Šot20]. A topological space X satisfies the selection principle $S_1(\Gamma_h, \mathcal{O})$ if for each $\langle\langle V_{n,m} : m \in \omega \rangle : n \in \omega\rangle$ with $V_{n,m}$ being open subsets of X such that $|\{m : x \notin V_{n,m}\}| \leq h(n)$ for each $x \in X$, there is a $d \in {}^\omega\omega$ with $\{V_{n,d(n)} : n \in \omega\}$ being an open cover of X .

The following particular cases of Theorem 6.11 are formulated in Corollary 6.15.

Theorem D. *If $h \in {}^\omega\omega$ then $\text{non}(S_1(\Gamma_{b,h}, J-\Gamma)) = \mathfrak{sl}_t(b, h, J)$ and $\text{non}(S_1(\Gamma_{b,h}, J-\Lambda)) = \mathfrak{sl}_t(b, h, J)$. As a consequence,*

$$\begin{aligned} \text{non}(S_1(\Gamma_h, \Gamma)) &= \text{non}(\mathcal{M}) \quad \text{when } h \geq^* 1, \quad \text{and} \\ \text{non}(S_1(\Gamma_h, \mathcal{O})) &= \text{cof}(\mathcal{N}) \quad \text{when } h \rightarrow \infty. \end{aligned}$$

The latter two equalities as well as Figure 4 were obtained in the frame of [Šot20]. The same applies to the second part of Section 6 that treats properties of topological spaces possessing the investigated selection principles.

Consistency results

In Section 7, we construct forcing models to prove consistency constellations of our slalom numbers. These models are motivated by Canjar's result [Can88], which states that after adding λ many Cohen reals, there exists a (maximal) ideal J_κ for any uncountable regular cardinal $\kappa \leq \lambda$ such that $\mathfrak{b}_{J_\kappa} = \mathfrak{d}_{J_\kappa} = \kappa$. We expand this result to show the effect of Cohen reals on the slalom numbers parametrized by ideals. This allows us to present a strong iteration theorem to control slalom numbers using Cohen reals added at intermediate steps (Theorem 7.5). One consequence is that, in Cohen model, we have many different slalom numbers.

Theorem E (Theorem 7.7). *Let $\lambda = \lambda^{\aleph_0}$ be an infinite cardinal. Then, after adding λ -many Cohen reals:*

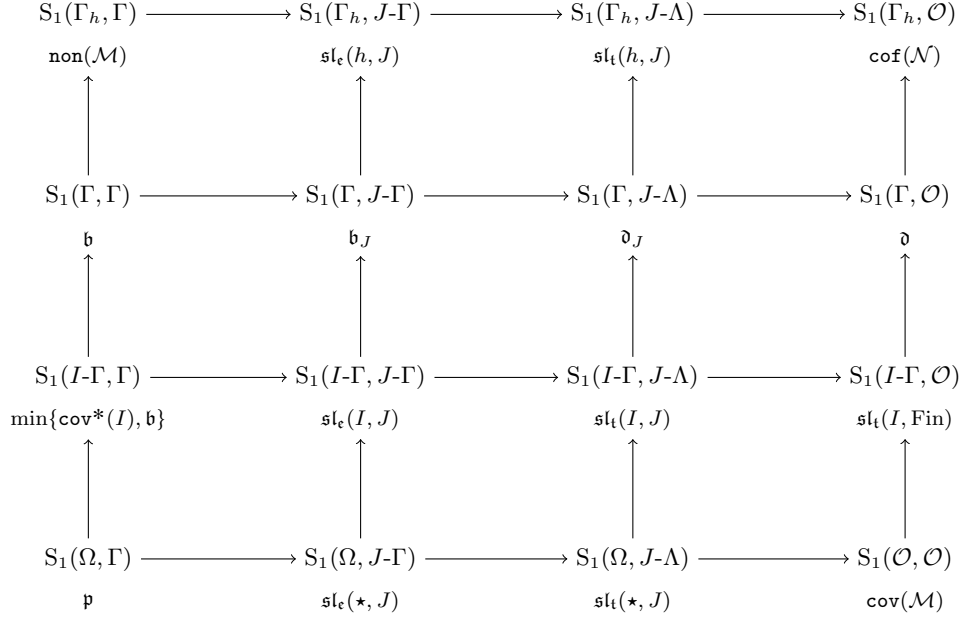

Figure 4: Critical cardinality of some selection principles.

- (a) Any uncountable regular cardinal κ satisfying $\lambda^{<\kappa} = \lambda$ is a slalom number of the form $\mathfrak{sl}_e(\star, J) = \mathfrak{sl}_t^\perp(h, J) = \mathfrak{sl}_t(h, J)$ (for all J -unbounded h) for some maximal ideal J on ω . (This corresponds to the two central columns of Figure 5)
- (b) For any regular $\aleph_1 \leq \kappa_1 \leq \kappa_2$, if $\lambda^{<\kappa_2} = \lambda$ then there is some ideal J on ω such that $\mathfrak{sl}_e(\star, J) = \mathfrak{sl}_t^\perp(h, J) = \mathfrak{sl}_e(h, J) = \kappa_1$ and $\mathfrak{sl}_t(\star, J) = \mathfrak{sl}_t^\perp(h, J) = \mathfrak{sl}_t(h, J) = \kappa_2$ for all $h \in {}^\omega\omega$ satisfying $\lim^J h = \infty$. In particular, the four columns of Figure 5 can be pairwise different.

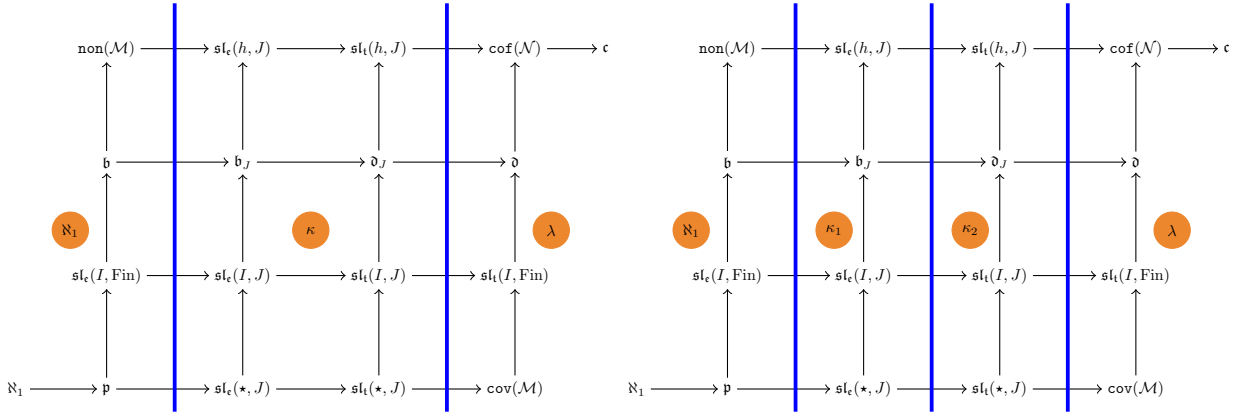

Figure 5: Effect of adding λ many Cohen reals.

The ideals satisfying (b) are obtained as sums of ideals from (a), where we use the characterization of the slalom numbers for sum of ideals (see Theorem C).

The general result Theorem 7.5 can be applied to any iteration adding Cohen reals. For more applications, we consider models obtained by FS (finite support) iterations and more sophisticated techniques like matrix

iterations and coherent systems of finite support iterations [FFMM18, Mej19]. We bring forcing constructions from [Mej13, Mej19, BCM21, GKMS21] and use our powerful theorem to prove the behavior of slalom numbers in these models.

In the final section, we present some open problems and discussions.

2. Preliminaries

We introduce basic notation.

- (T1) For $A \subseteq \mathcal{P}(M)$, denote $A^c := \mathcal{P}(M) \setminus A$ and $A^d := \{M \setminus a : a \in A\}$.
- (T2) An *ideal on M* is a family $I \subseteq \mathcal{P}(M)$ that is closed under taking subsets, closed under finite unions, containing all finite subsets of M but with $M \notin I$. A σ -ideal on M , usually considered on a Polish space M , is an ideal on M which is closed under countable unions.
- (T3) We say that A has the *finite union property (FUP)* whenever there is an ideal I on M such that $A \subseteq I$.
- (T4) For an ideal J on M , denote $J^+ := J^c = \mathcal{P}(M) \setminus J$ (the collection of J -positive sets), J^d is the dual filter of J and $J^{dc} = \mathcal{P}(M) \setminus J^d = \{M \setminus a : a \in J^+\}$. We often extend this notation to arbitrary collections $J \subseteq \mathcal{P}(M)$ that are not ideals.
- (T5) For a function $\varphi: M \rightarrow N$ and $A \subseteq \mathcal{P}(M)$, denote $\varphi^{-\rightarrow}(A) := \{y \subseteq N : \varphi^{-1} \llbracket y \rrbracket \in A\}$.
- (T6) Let \sqsubset be a relation. If x and y are two functions with the same domain w , denote $\|x \sqsubset y\| := \{i \in w : x(i) \sqsubset y(i)\}$.

We say that $\mathbf{R} = \langle X, Y, \sqsubset \rangle$ is a *relational system* if it consists of two non-empty sets X and Y and a relation \sqsubset .

- (1) A set $F \subseteq X$ is \mathbf{R} -bounded if $(\exists y \in Y)(\forall x \in F) x \sqsubset y$.
- (2) A set $D \subseteq Y$ is \mathbf{R} -dominating if $(\forall x \in X)(\exists y \in D) x \sqsubset y$.

We associate two cardinal characteristics with this relational system \mathbf{R} :

$$\begin{aligned} \mathfrak{b}(\mathbf{R}) &:= \min\{|F| : F \subseteq X \text{ is } \mathbf{R}\text{-unbounded}\}, & \text{the unbounding number of } \mathbf{R}, \text{ and} \\ \mathfrak{d}(\mathbf{R}) &:= \min\{|D| : D \subseteq Y \text{ is } \mathbf{R}\text{-dominating}\}, & \text{the dominating number of } \mathbf{R}. \end{aligned}$$

The dual of \mathbf{R} is defined by $\mathbf{R}^\perp := \langle Y, X, \sqsubset^\perp \rangle$ where $y \sqsubset^\perp x$ iff $x \not\sqsubset y$. Note that $\mathfrak{b}(\mathbf{R}^\perp) = \mathfrak{d}(\mathbf{R})$ and $\mathfrak{d}(\mathbf{R}^\perp) = \mathfrak{b}(\mathbf{R})$.

The cardinal $\mathfrak{b}(\mathbf{R})$ may be undefined, in which case we write $\mathfrak{b}(\mathbf{R}) = \infty$, likewise for $\mathfrak{d}(\mathbf{R})$. Concretely, $\mathfrak{b}(\mathbf{R}) = \infty$ iff $\mathfrak{d}(\mathbf{R}) = 1$; and $\mathfrak{d}(\mathbf{R}) = \infty$ iff $\mathfrak{b}(\mathbf{R}) = 1$.

The cardinal characteristics associated with an ideal can be characterized by relational systems.

Example 2.1. For $\mathcal{I} \subseteq \mathcal{P}(X)$, define the relational systems:

- (1) $\mathcal{I} := \langle \mathcal{I}, \mathcal{I}, \subseteq \rangle$, which is a directed partial order when \mathcal{I} is closed under unions (e.g. an ideal).
- (2) $\mathbf{C}_{\mathcal{I}} := \langle X, \mathcal{I}, \in \rangle$.

Whenever \mathcal{I} is an ideal on X ,

- (a) $\mathfrak{b}(\mathcal{I}) = \text{add}(\mathcal{I})$, the additivity of \mathcal{I} . (c) $\mathfrak{d}(\mathbf{C}_{\mathcal{I}}) = \text{cov}(\mathcal{I})$, the covering of \mathcal{I} .
(b) $\mathfrak{d}(\mathcal{I}) = \text{cof}(\mathcal{I})$, the cofinality of \mathcal{I} . (d) $\mathfrak{b}(\mathbf{C}_{\mathcal{I}}) = \text{non}(\mathcal{I})$, the uniformity of \mathcal{I} .

The Tukey connection is a practical tool to determine relations between cardinal characteristics. Let $\mathbf{R} = \langle X, Y, \sqsubset \rangle$ and $\mathbf{R}' = \langle X', Y', \sqsubset' \rangle$ be two relational systems. We say that $(\Psi_-, \Psi_+): \mathbf{R} \rightarrow \mathbf{R}'$ is a *Tukey connection from \mathbf{R} into \mathbf{R}'* if $\Psi_-: X \rightarrow X'$ and $\Psi_+: Y' \rightarrow Y$ are functions such that

$$(\forall x \in X)(\forall y' \in Y') \Psi_-(x) \sqsubset' y' \Rightarrow x \sqsubset \Psi_+(y').$$

The *Tukey order* between relational systems is defined by $\mathbf{R} \leq_{\mathbf{T}} \mathbf{R}'$ iff there is a Tukey connection from \mathbf{R} into \mathbf{R}' . *Tukey equivalence* is defined by $\mathbf{R} \cong_{\mathbf{T}} \mathbf{R}'$ iff $\mathbf{R} \leq_{\mathbf{T}} \mathbf{R}'$ and $\mathbf{R}' \leq_{\mathbf{T}} \mathbf{R}$.

Fact 2.2. Assume that $\mathbf{R} = \langle X, Y, \sqsubset \rangle$ and $\mathbf{R}' = \langle X', Y', \sqsubset' \rangle$ are relational systems and that $(\Psi_-, \Psi_+): \mathbf{R} \rightarrow \mathbf{R}'$ is a Tukey connection.

- (a) $(\Psi_+, \Psi_-): (\mathbf{R}')^{\perp} \rightarrow \mathbf{R}^{\perp}$ is a Tukey connection.
(b) If $E \subseteq X$ is \mathbf{R} -unbounded then $\Psi_-[E]$ is \mathbf{R}' -unbounded.
(c) If $D' \subseteq Y'$ is \mathbf{R}' -dominating, then $\Psi_+[D']$ is \mathbf{R} -dominating. □

Corollary 2.3. Let $\mathbf{R} = \langle X, Y, \sqsubset \rangle$ and $\mathbf{R}' = \langle X', Y', \sqsubset' \rangle$ be relational systems. Then

- (a) $\mathbf{R} \leq_{\mathbf{T}} \mathbf{R}'$ implies $(\mathbf{R}')^{\perp} \leq_{\mathbf{T}} \mathbf{R}^{\perp}$.
(b) $\mathbf{R} \leq_{\mathbf{T}} \mathbf{R}'$ implies $\mathfrak{b}(\mathbf{R}') \leq \mathfrak{b}(\mathbf{R})$ and $\mathfrak{d}(\mathbf{R}) \leq \mathfrak{d}(\mathbf{R}')$.
(c) $\mathbf{R} \cong_{\mathbf{T}} \mathbf{R}'$ implies $\mathfrak{b}(\mathbf{R}') = \mathfrak{b}(\mathbf{R})$ and $\mathfrak{d}(\mathbf{R}) = \mathfrak{d}(\mathbf{R}')$. □

We use a couple of types of products of relational systems for our main results.

Definition 2.4. Let $\overline{\mathbf{R}} = \langle \mathbf{R}_i : i \in K \rangle$ be a sequence of relational systems $\mathbf{R}_i = \langle X_i, Y_i, \sqsubset_i \rangle$. Define:

(P1) $\otimes \overline{\mathbf{R}} = \otimes_{i \in K} \mathbf{R}_i := \langle \prod_{i \in K} X_i, \prod_{i \in K} Y_i, \sqsubset^{\otimes} \rangle$ where $x \sqsubset^{\otimes} y$ iff $x_i \sqsubset_i y_i$ for all $i \in K$.

(P2) $\boxtimes \overline{\mathbf{R}} = \boxtimes_{i \in K} \mathbf{R}_i := \langle \prod_{i \in K} X_i, \prod_{i \in K} Y_i, \sqsubset^{\boxtimes} \rangle$ where $x \sqsubset^{\boxtimes} y$ iff $x_i \sqsubset_i y_i$ for some $i \in K$.

For two relational systems \mathbf{R} and \mathbf{R}' , write $\mathbf{R} \otimes \mathbf{R}'$ and $\mathbf{R} \boxtimes \mathbf{R}'$.

When $\mathbf{R}_i = \mathbf{R}$ for all $i \in K$, we write ${}^K \mathbf{R} := \otimes \overline{\mathbf{R}}$.

Notice that $\boxtimes \overline{\mathbf{R}} = (\otimes_{i \in K} \mathbf{R}_i^{\perp})^{\perp}$.

Fact 2.5 ([CM25]). Let $\overline{\mathbf{R}}$ be as in [Definition 2.4](#). Then

- (a) $\sup_{i \in K} \mathfrak{d}(\mathbf{R}_i) \leq \mathfrak{d}(\otimes \overline{\mathbf{R}}) \leq \prod_{i \in K} \mathfrak{d}(\mathbf{R}_i)$ and $\mathfrak{b}(\otimes \overline{\mathbf{R}}) = \min_{i \in K} \mathfrak{b}(\mathbf{R}_i)$.
(b) $\mathfrak{d}(\boxtimes \overline{\mathbf{R}}) = \min_{i \in K} \mathfrak{d}(\mathbf{R}_i)$ and $\sup_{i \in K} \mathfrak{b}(\mathbf{R}_i) \leq \mathfrak{b}(\boxtimes \overline{\mathbf{R}}) \leq \prod_{i \in K} \mathfrak{b}(\mathbf{R}_i)$. □

3. Slalom numbers

In this section, we present a general framework for slalom numbers and prove general theorems for connections between them.

Definition 3.1. Let $A \subseteq \mathcal{P}(a)$ and let \sqsubset be a relation. For two functions x and s with domain a , define the relation

$$x \sqsubset^A s \text{ iff } \|x \sqsubset s\| = \{i \in a : x(i) \sqsubset s(i)\} \in A.$$

Most of the time we use this notation when $a = \omega$.

For non-empty sets D and E of functions with domain ω (or some other set a in general), we consider the relational system $\langle D, E, \in^A \rangle$ and denote its associated cardinal characteristics by

$$\mathfrak{d}_A(D, E) := \mathfrak{d}(D, E, \in^A) \text{ and } \mathfrak{b}_A(D, E) := \mathfrak{b}(D, E, \in^A).$$

We will refer to any cardinal characteristic of this form as a *slalom number*. Any function $s \in E$ is called a *slalom* since $s(i)$ is a set typically contained in some domain where $x(i)$ lives for all $x \in D$. The expression “ $x \in^A s$ ” indicates that x passes through the slalom s precisely at coordinates on a set in A . We concentrate mostly on the \mathfrak{d} -numbers and the following situation:

- (1) For some sequence $b = \langle b(i) : i < \omega \rangle$ of non-empty sets, we consider $D \subseteq \prod b := \prod_{n < \omega} b(n)$. Most of the time $D = \prod b$ but there are some exceptions, e.g. when D is the set of 1-1 functions in ${}^\omega \omega$. We typically assume $E \subseteq \prod_{i < \omega} \mathcal{P}(b(i))$ for simplicity, but this is not required because $\langle D, E, \in^A \rangle \cong_{\mathbb{T}} \langle D, E', \in^A \rangle$ where E' is the collection of all sequences of the form $\langle s(n) \cap b(n) : n < \omega \rangle$ for some $s \in E$, see [Lemma 3.8](#).

In the case $D = \prod b$, we replace D by b in the notation for the relational system and its cardinal characteristics, i.e., $\langle b, E, \in^A \rangle := \langle \prod b, E, \in^A \rangle$, $\mathfrak{d}_A(b, E) := \mathfrak{d}_A(\prod b, E)$, and likewise for the \mathfrak{b} -number. When b is the constant sequence of a set a , we replace b by a in the previous notation, e.g. we write $\mathfrak{d}_A(a, E)$ and $\mathfrak{b}_A(a, E)$; when $a = \omega$, we omit ω in the cardinal characteristics, i.e., we just write $\mathfrak{d}_A(E)$ and $\mathfrak{b}_A(E)$.

We are interested in the case when $b(i)$ is countable for all $i < \omega$, but we do not need to assume this all the time.

- (2) The set A is associated to an ideal J on the natural numbers. In fact, we are only interested in the case when $A = J^{\perp}$ (the dual filter of J), or $A = J^+$ (the collection of positive sets). Considering each case, we denote:

$$\begin{aligned} \mathbf{Lc}_J(D, E) &:= \langle D, E, \in^{J^{\perp}} \rangle, & \mathbf{pLc}_J(D, E) &:= \langle D, E, \in^{J^+} \rangle, \\ \mathfrak{sl}_t(D, E, J) &:= \mathfrak{d}_{J^{\perp}}(D, E), & \mathfrak{sl}_e(D, E, J) &:= \mathfrak{d}_{J^+}(D, E), \\ \mathfrak{sl}_t^{\perp}(D, E, J) &:= \mathfrak{b}_{J^{\perp}}(D, E), & \mathfrak{sl}_e^{\perp}(D, E, J) &:= \mathfrak{b}_{J^+}(D, E). \end{aligned} \tag{3.1.1}$$

We call these relational systems *localization* and *pseudo-localization*, respectively. Like in (1), we replace D by b when $D = \prod b$ and, in addition, we omit b when it is the constant sequence ω , i.e., we write $\mathfrak{sl}_e(E, J)$, $\mathfrak{sl}_t(E, J)$. We allow this notation when J is not an ideal.

- (3) For the set E , we consider the following when $D \subseteq \prod b$:

- (3a) $E = \prod \bar{I} = \prod_{n < \omega} I_n$ when $\bar{I} = \langle I_n : n < \omega \rangle$ is a sequence of ideals on ω , or more generally, each $I_n \subseteq \mathcal{P}(b(n))$ for some set $b(n)$ (not necessarily an ideal). In this case, we replace E by \bar{I} in (3.1.1), and by I in case \bar{I} is the constant sequence of I , i.e., we write $\mathfrak{sl}_e(D, I, J)$ and $\mathfrak{sl}_t(D, I, J)$. The most common particular case is the one with $D = {}^\omega \omega$, i.e., $\mathfrak{sl}_e(I, J)$ and $\mathfrak{sl}_t(I, J)$.
- (3b) For some $h \in {}^\omega \omega$, let $E = \mathcal{S}(b, h) := \prod_{n \in \omega} [b(n)]^{\leq h(n)}$. We replace E by h in (3.1.1), i.e., we write $\mathfrak{sl}_e(D, h, J)$ and $\mathfrak{sl}_t(D, h, J)$. We often consider $\mathfrak{sl}_e(h, J)$ and $\mathfrak{sl}_t(h, J)$ with $D = {}^\omega \omega$. Another relevant particular case is

$$\mathfrak{sl}_t(b, h, J) = \mathfrak{sl}_t\left(\prod b, \mathcal{S}(b, h), J\right) \text{ and } \mathfrak{sl}_e(b, h, J) = \mathfrak{sl}_e\left(\prod b, \mathcal{S}(b, h), J\right).$$

When b is the constant sequence of a set a , we write $\mathcal{S}(a, h)$; when b is the constant sequence of ω , we write $\mathcal{S}(h)$. Notice that $\langle D, \mathcal{S}(b, h), \in^A \rangle \cong_{\mathbb{T}} \langle D, \mathcal{S}(a, h), \in^A \rangle$ when a contains $\bigcup_{i < \omega} b(i)$, see [Lemma 3.8](#).

(3c) For some ideal I on ω , or on some set a , consider the collection $\text{ct}(I)$ of constant functions in ${}^\omega I$ (or in ${}^a I$). Denote:

$$\begin{aligned} \mathbf{L}_{I,J}(D) &:= \mathbf{Lc}_J(D, \text{ct}(I)), & \mathbf{pL}_{I,J}(D) &:= \mathbf{pLc}_J(D, \text{ct}(I)), \\ \mathfrak{l}_D(I, J) &:= \mathfrak{sl}_t(D, \text{ct}(I), J), & \mathfrak{p}_D(I, J) &:= \mathfrak{sl}_e(D, \text{ct}(I), J). \end{aligned} \quad (3.1.2)$$

Like in (1), for the relational systems we omit D when it is ${}^\omega\omega$, but for the cardinal characteristics $\mathfrak{l}_D(I, J)$ and $\mathfrak{p}_D(I, J)$, we use a different notation, usually associated with some property: in the case $D = {}^\omega\omega$, we denote these numbers by $\mathfrak{l}_K(I, J)$ and $\mathfrak{p}_K(I, J)$, respectively (in connection with the Katětov ordering); in the case that D is the set of all finite-to-one functions from ω into ω , we write $\mathfrak{l}_{KB}(I, J)$ and $\mathfrak{p}_{KB}(I, J)$ (in connection with the Katětov-Blass ordering); and when D is the set of all one-to-one functions from ω into ω , we write $\mathfrak{l}_{1-1}(I, J)$ and $\mathfrak{p}_{1-1}(I, J)$, respectively. This notation appears in [BF12, Š23, BSZ23].

We sometimes extend the notation presented above for arbitrary families I and J instead of ideals and consider similar definitions where the domain of the slaloms is some other set instead of ω . Likewise for the slalom number defined below.

A more general approach to define slalom numbers like $\mathfrak{d}_A(D, E)$ is the following: for some collection (or property) \mathcal{P} of sets of functions with domain ω , define

$$\mathfrak{d}_A(D, \mathcal{P}) := \min\{|S| : S \text{ satisfies } \mathcal{P} \text{ and } (\forall x \in D)(\exists s \in S) x \in {}^A s\}.$$

When \mathcal{P} is “ $S \subseteq E$ ”, the cardinal above is just $\mathfrak{d}_A(D, E)$. Note that, in general, we do not have a relational system for this more general setting. In relation with (2), we denote

$$\mathfrak{sl}_t(D, \mathcal{P}, J) := \mathfrak{d}_{J^d}(D, \mathcal{P}), \quad \mathfrak{sl}_e(D, \mathcal{P}, J) := \mathfrak{d}_{J^+}(D, \mathcal{P})$$

and, like in (1), we use b or omit D when it is ${}^\omega\omega$. Two relevant properties are \star and \mathcal{P}_{ct} :

- A set S satisfies \star if $S \subseteq \prod b$ and, for any $i < \omega$, the collection $\{s(i) : s \in S\}$ has the FUP in $b(i)$.
- A set S satisfies \mathcal{P}_{ct} if $S \subseteq {}^\omega \mathcal{P}(a)$ is a set of constant ω -sequences and S satisfies \star in a .

In particular, we get definitions for $\mathfrak{sl}_t(D, \star, J)$, $\mathfrak{sl}_e(D, \star, J)$, $\mathfrak{sl}_t(b, \star, J)$, $\mathfrak{sl}_e(b, \star, J)$, $\mathfrak{sl}_t(\star, J)$, $\mathfrak{sl}_e(\star, J)$, and, in relation with (3c), we denote

$$\mathfrak{l}_D(\star, J) := \mathfrak{sl}_t(D, \mathcal{P}_{\text{ct}}, J), \quad \mathfrak{p}_D(\star, J) := \mathfrak{sl}_e(D, \mathcal{P}_{\text{ct}}, J).$$

The latter slalom numbers are easy to characterize.

Lemma 3.2. *Let a be an infinite set and $D \subseteq {}^\omega a$. Then*

$$\mathfrak{d}_A(D, \mathcal{P}_{\text{ct}}) = \min\{\mathfrak{d}_A(D, \text{ct}(I)) : I \text{ is an ideal on } a\}.$$

In particular, whenever $J \subseteq \mathcal{P}(\omega)$,

$$\begin{aligned} \mathfrak{p}_D(\star, J) &= \min\{\mathfrak{p}_D(I, J) : I \text{ is an ideal on } a\}, \\ \mathfrak{l}_D(\star, J) &= \min\{\mathfrak{l}_D(I, J) : I \text{ is an ideal on } a\}. \end{aligned}$$

Proof. Notice that, for any set S of constant ω -sequences with value in $\mathcal{P}(a)$, S satisfies property \star iff there is some ideal I on a such that $S \subseteq \text{ct}(I)$. This fact allows us to easily prove the result. \square

In the following section, we prove similar results for $\mathfrak{sl}_t(\star, J)$ and $\mathfrak{sl}_e(\star, J)$.

Remark 3.3. We list some notation used in other references.

1. *Austria–Israel notation*, see [GS93, Kel08, KS09, KS12, KM22, CKM24]:

$$\begin{aligned} \mathfrak{c}_{b,h}^\forall &= \mathfrak{sl}_t(b, h, \text{Fin}), & \mathfrak{c}_{b,h}^\exists &= \mathfrak{sl}_e(b, h, \text{Fin}), \\ \mathfrak{b}_{b,h}^\forall &= \mathfrak{sl}_t^\perp(b, h, \text{Fin}), & \mathfrak{b}_{b,h}^\exists &= \mathfrak{sl}_e^\perp(b, h, \text{Fin}). \end{aligned}$$

2. *Higher cardinal characteristics notation*, see [BBFM18, BS23, vdV25]:

$$\begin{aligned} \mathfrak{d}_h(\epsilon^*) &= \mathfrak{sl}_t(h, \text{Fin}), & \mathfrak{b}_h(\epsilon^*) &= \mathfrak{sl}_t^\perp(h, \text{Fin}) \\ \mathfrak{d}_\omega^{b,h}(\epsilon^*) &= \mathfrak{sl}_t(b, h, \text{Fin}), & \mathfrak{b}_\omega^{b,h}(\epsilon^*) &= \mathfrak{sl}_t^\perp(b, h, \text{Fin}) \\ \mathfrak{d}_\omega^{b,h}(\aleph^\infty) &= \mathfrak{sl}_e(b, h, \text{Fin}), & \mathfrak{b}_\omega^{b,h}(\aleph^\infty) &= \mathfrak{sl}_e^\perp(b, h, \text{Fin}). \end{aligned}$$

3. *Colombian-expats notation*, see [CM19, CM23, Car23]:

$$\begin{aligned} \mathfrak{d}_{b,h}^{\text{Lc}} &= \mathfrak{sl}_t(b, h, \text{Fin}), & \mathfrak{b}_{b,h}^{\text{aLc}} &= \mathfrak{sl}_e(b, h, \text{Fin}), \\ \mathfrak{b}_{b,h}^{\text{Lc}} &= \mathfrak{sl}_t^\perp(b, h, \text{Fin}), & \mathfrak{d}_{b,h}^{\text{aLc}} &= \mathfrak{sl}_e^\perp(b, h, \text{Fin}). \end{aligned}$$

4. *Earlier Slovak notation*,⁷ see [Šup16, ŠŠ19, Rep21a, Rep21b]:

$$\begin{aligned} \mathfrak{k}_{I,J} &= \mathfrak{p}_K(I, J), & \lambda(I, J) &= \mathfrak{sl}_e(I, J), \\ \mathfrak{k}_{I,J}^* &= \mathfrak{p}_{\text{KB}}(I, J). \end{aligned}$$

We obtain general connections and inequalities as follows.

Lemma 3.4. *Let D, D', E, E' be sets of functions with domain ω , let \mathcal{P} and \mathcal{P}' be properties of sets of functions with domain ω , and let A and A' be subsets of $\mathcal{P}(\omega)$.*

(a) *If $D \subseteq D'$ then $\langle D, E, \epsilon^A \rangle \leq_T \langle D', E, \epsilon^A \rangle$.*

In particular, $\mathfrak{d}_A(D, E) \leq \mathfrak{d}_A(D', E)$ and $\mathfrak{b}_A(D', E) \leq \mathfrak{b}_A(D, E)$, even more $\mathfrak{d}_A(D, \mathcal{P}) \leq \mathfrak{d}_A(D', \mathcal{P})$.

(b) *If $E \subseteq E'$ then $\langle D, E', \epsilon^A \rangle \leq_T \langle D, E, \epsilon^A \rangle$.*

In particular, $\mathfrak{d}_A(D, E') \leq \mathfrak{d}_A(D, E)$ and $\mathfrak{b}_A(D, E) \leq \mathfrak{b}_A(D, E')$.

(c) *If $\mathcal{P} \subseteq \mathcal{P}'$ then $\mathfrak{d}_A(D, \mathcal{P}') \leq \mathfrak{d}_A(D, \mathcal{P})$.*

(d) *If $A \subseteq A'$ then $\langle D, E, \epsilon^{A'} \rangle \leq_T \langle D, E, \epsilon^A \rangle$. Even more, $\mathfrak{d}_{A'}(D, \mathcal{P}) \leq \mathfrak{d}_A(D, \mathcal{P})$.*

Proof. The inclusion maps $\text{id}_D: D \rightarrow D'$ and $\text{id}_E: E \rightarrow E'$, as well as identity maps, can be used to construct the Tukey connections for (a), (b) and (d). For the latter, note that $A \subseteq A'$ implies that $x \in^A s \Rightarrow x \in^{A'} s$. The inequalities using \mathcal{P} and (c) are easy to check. \square

Corollary 3.5. *Let $J \subseteq \mathcal{P}(\omega)$.*

(a) $\mathbf{Lc}_J(D, I) \leq_T \mathbf{L}_{I,J}(D)$, in particular, $\mathfrak{sl}_t(D, I, J) \leq \mathfrak{l}_D(I, J)$.

(b) $\mathbf{pLc}_J(D, I) \leq_T \mathbf{pL}_{I,J}(D) \leq_T \mathbf{L}_{I,J}(D)$, in particular, $\mathfrak{sl}_e(D, I, J) \leq \mathfrak{p}_D(I, J) \leq \mathfrak{l}_D(I, J)$.

(c) $\mathbf{pLc}_J(D, E) \leq_T \mathbf{Lc}_J(D, E)$, in particular, $\mathfrak{sl}_e(D, E, J) \leq \mathfrak{sl}_t(D, E, J)$. Even more, $\mathfrak{sl}_e(D, \mathcal{P}, J) \leq \mathfrak{sl}_t(D, \mathcal{P}, J)$ for any property \mathcal{P} . \square

Notation 3.6. Let $J \subseteq \mathcal{P}(\omega)$ (typically an ideal).

⁷The *current* Slovak notation is the one we use in this paper.

(1) For two sets D and D' of functions with domain ω , write

$$D \sqsubseteq^J D' \text{ iff } (\forall x \in D)(\exists x' \in D') x' =^{J^d} x.$$

(2) For two sets E and E' of functions with domain ω , write

$$E \sqsubseteq^J E' \text{ iff } (\forall s \in E)(\exists s' \in E') s \subseteq^{J^d} s'.$$

(3) Let \mathcal{P} and \mathcal{P}' be two properties for sets of functions with domain ω . We write $\mathcal{P} \Rightarrow^J \mathcal{P}'$ if, for any S satisfying \mathcal{P} , there is some S' satisfying \mathcal{P}' such that $S \subseteq^J S'$.

We use the previous notation to improve [Lemma 3.4](#) when using ideals.

Lemma 3.7. *Let D, D', E, E' be sets of functions with domain ω , let \mathcal{P} and \mathcal{P}' be properties for sets of functions with domain ω , and let J be an ideal on ω .*

(a) *If $D \sqsubseteq^J D'$ then*

$$\begin{aligned} \mathbf{Lc}_J(D, E) &\leq_{\mathbf{T}} \mathbf{Lc}_J(D', E), & \mathbf{pLc}_J(D, E) &\leq_{\mathbf{T}} \mathbf{pLc}_J(D', E), \\ \mathfrak{sl}_t(D, \mathcal{P}, J) &\leq \mathfrak{sl}_t(D', \mathcal{P}, J), & \mathfrak{sl}_e(D, \mathcal{P}, J) &\leq \mathfrak{sl}_e(D', \mathcal{P}, J). \end{aligned}$$

(b) *If $E \sqsubseteq^J E'$ then*

$$\begin{aligned} \mathbf{Lc}_J(D, E') &\leq_{\mathbf{T}} \mathbf{Lc}_J(D, E), & \mathbf{pLc}_J(D, E') &\leq_{\mathbf{T}} \mathbf{pLc}_J(D, E), \\ \mathfrak{sl}_t(D, E', J) &\leq \mathfrak{sl}_t(D, E, J), & \mathfrak{sl}_e(D, E', J) &\leq \mathfrak{sl}_e(D, E, J). \end{aligned}$$

(c) *If $\mathcal{P} \Rightarrow^J \mathcal{P}'$ and \mathcal{P}' is \subseteq -downward closed then $\mathfrak{sl}_t(D, \mathcal{P}', J) \leq \mathfrak{sl}_t(D, \mathcal{P}, J)$ and $\mathfrak{sl}_e(D, \mathcal{P}', J) \leq \mathfrak{sl}_e(D, \mathcal{P}, J)$.*

(d) *If $J \subseteq J' \subseteq \mathcal{P}(\omega)$ then⁸*

$$\begin{aligned} \mathbf{Lc}_{J'}(D, E) &\leq_{\mathbf{T}} \mathbf{Lc}_J(D, E), & \mathbf{pLc}_J(D, E) &\leq_{\mathbf{T}} \mathbf{pLc}_{J'}(D, E), \\ \mathfrak{sl}_t(D, \mathcal{P}, J') &\leq \mathfrak{sl}_t(D, \mathcal{P}, J), & \mathfrak{sl}_e(D, \mathcal{P}, J) &\leq \mathfrak{sl}_e(D, \mathcal{P}, J'). \end{aligned}$$

Proof. When $D \sqsubseteq^J D'$ and $E \sqsubseteq^J E'$, define the maps $f: D \rightarrow D'$ and $g: E \rightarrow E'$ such that, for $x \in D$ and $s \in E$, $f(x) =^{J^d} x$ and $s \subseteq^{J^d} g(s)$. These maps, along with identity maps, yield the Tukey connections for [\(a\)](#) and [\(b\)](#). The inequalities at the bottom of [\(b\)](#) follow by [Corollary 2.3 \(b\)](#).

We show the inequalities at the bottom of [\(a\)](#). Let S be a witness of $\mathfrak{sl}_t(D', \mathcal{P}, J)$, so S satisfies property \mathcal{P} . If $x \in D$ then $f(x) \in D'$, so $f(x) \in^{J^d} s$ for some $s \in S$. Since $x =^{J^d} f(x)$, we get that $x \in^{J^d} s$. Hence, S satisfies the properties of the definition of $\mathfrak{sl}_t(D, \mathcal{P}, J)$, so $\mathfrak{sl}_t(D, \mathcal{P}, J) \leq |S| = \mathfrak{sl}_t(D', \mathcal{P}, J)$. A similar argument guarantees $\mathfrak{sl}_e(D, \mathcal{P}, J) \leq \mathfrak{sl}_e(D', \mathcal{P}, J)$, just note that $f(x) \in^{J^+} s$ implies $x \in^{J^+} s$.

[\(c\)](#): Assume $\mathcal{P} \Rightarrow^J \mathcal{P}'$ and \mathcal{P}' is \subseteq -downward closed. Let S be a witness of $\mathfrak{sl}_t(D, \mathcal{P}, J)$. Since S has property \mathcal{P} , there is some S' with property \mathcal{P}' and some map $g': S \rightarrow S'$ such that $s \subseteq^{J^d} g'(s)$ for all $s \in S$. Since \mathcal{P}' is \subseteq -downward closed, we can assume that $S' = g'[S]$ and hence $|S'| \leq |S|$. If $x \in D$ then $x \in^{J^d} s$ for some $s \in S$, which implies that $x \in^{J^d} g'(s)$. Therefore, S' satisfies the properties of the definition of $\mathfrak{sl}_t(D, \mathcal{P}', J)$, so $\mathfrak{sl}_t(D, \mathcal{P}', J) \leq |S'| \leq |S| = \mathfrak{sl}_t(D, \mathcal{P}, J)$. The case for \mathfrak{sl}_e is similar, just note that $x \in^{J^+} s$ implies $x \in^{J^+} g'(s)$.

[\(d\)](#): Note that $J \subseteq J'$ implies $J^d \subseteq J'^d$ and $J'^c \subseteq J^c$, so the result follows by [Lemma 3.4 \(d\)](#). \square

⁸Here, there is no need to assume that J and J' are ideals.

In connection with [Lemma 3.7 \(b\)](#), we obtain:

Lemma 3.8. *If $D \subseteq \prod_{n < \omega} b(n)$, E is a set of functions with domain ω , and $A \subseteq \mathcal{P}(\omega)$, then $\langle D, E, \in^A \rangle \cong_{\mathbb{T}} \langle D, E', \in^A \rangle$ where E' is the collection of all slaloms of the form $\langle s(n) \cap b(n) : n < \omega \rangle$ for some $s \in E$.*

Proof. Abusing notation, notice that $E' \subseteq^{\{\emptyset\}} E$, so the proof of [Lemma 3.7 \(b\)](#) can be used to show that $\langle D, E, \in^A \rangle \leq_{\mathbb{T}} \langle D, E', \in^A \rangle$. The converse Tukey connection is obtained by using the identity map of D and $s \mapsto \langle s(n) \cap b(n) : n < \omega \rangle$. \square

In the following section, we are going to review some order of ideals like the *Katetov order* and the *Katetov-Blass order*, with some variations, and study its effect on the slalom numbers. The following results are general facts that derive these effects as corollaries appearing in the next section.

Lemma 3.9. *Let $f : \omega \rightarrow \omega$, denote $a_n := f^{-1}[\{n\}]$ for $n \in \omega$, and let J and J' be ideals on ω . Assume:*

- (i) *D and D' are two sets of functions with domain ω such that, whenever $x' \in D'$, $x' \circ f \in D$.*
- (ii) *E and E' are two sets of functions with domain ω such that, for any $s \in E$, there is some function $s' \in E'$ such that $\{n < \omega : \bigcup_{k \in a_n} s(k) \subseteq s'(n)\} \in J^{\text{d}}$.*

Then:

- (a) *Whenever $J' \subseteq f^{\rightarrow}(J)$, $\mathbf{pLc}_{J'}(D', E') \leq_{\mathbb{T}} \mathbf{pLc}_J(D, E)$, so $\mathfrak{sl}_e(D', E', J') \leq \mathfrak{sl}_e(D, E, J)$.*
- (b) *Whenever $f^{\rightarrow}(J) \subseteq J'$, $\mathbf{Lc}_{J'}(D', E') \leq_{\mathbb{T}} \mathbf{Lc}_J(D, E)$, so $\mathfrak{sl}_t(D', E', J') \leq \mathfrak{sl}_t(D, E, J)$.* \square

[Lemma 3.9](#) is a particular case of the following result when $F = \{f\}$.

Lemma 3.10. *Let $F \subseteq {}^{\omega}\omega$, let A and A_f for $f \in F$ be \subseteq -upwards closed subsets of $\mathcal{P}(\omega)$, let J and J_f for $f \in F$ be ideals on ω , and let D, D_f, E, E_f for $f \in F$ be sets of functions with domain ω . Denote*

$$A_F = \left\{ a \cap b : a \in J^{\text{d}} \text{ and } b \in \bigcap_{f \in F} f^{\rightarrow}(A_f) \right\} \quad \text{and}$$

$$E_F = \left\{ t_{\bar{s}} : \bar{s} \in \prod_{f \in F} E_f \right\}, \quad \text{where } t_{\bar{s}}(n) = \bigcup_{f \in F} \bigcup_{k \in f^{-1}[\{n\}]} s_f(k),$$

*and assume that $E_F \subseteq^J E$ and, for all $f \in F$, $\{x \circ f : x \in D\} \sqsubseteq^{J_f} D_f$ and $a \cap b \in A_f$ for all $a \in J_f^{\text{d}}$ and $b \in A_f$.*⁹

- (a) *If $A_F \subseteq A$, then $\langle D, E, \in^A \rangle \leq_{\mathbb{T}} \bigotimes_{f \in F} \langle D_f, E_f, \in^{A_f} \rangle$.*
- (b) *If $\bigcap_{f \in F} f^{\rightarrow}(J_f) \subseteq J$, then $\mathbf{Lc}_J(D, E) \leq_{\mathbb{T}} \bigotimes_{f \in F} \mathbf{Lc}_{J_f}(D_f, E_f)$; in particular,*

$$\mathfrak{sl}_t(D, E, J) \leq \prod_{f \in F} \mathfrak{sl}_t(D_f, E_f, J_f).$$

- (c) *If $J \subseteq \bigcup_{f \in F} f^{\rightarrow}(J_f)$, then $\mathbf{pLc}_J(D, E) \leq_{\mathbb{T}} \bigotimes_{f \in F} \mathbf{pLc}_{J_f}(D_f, E_f)$; in particular, $\mathfrak{sl}_e(D, E, J) \leq \prod_{f \in F} \mathfrak{sl}_e(D_f, E_f, J_f)$.*

Proof. (a): We define $G_- : D \rightarrow \prod_{f \in F} D_f$ and $G_+ : \prod_{f \in F} E_f \rightarrow E$ as follows: For every $x \in D$, $f \in F$ and $\bar{s} \in \prod_{f \in F} E_f$ fix $x_f \in D_f$ and $u_{\bar{s}} \in E$ such that $x_f = {}^{J_f^{\text{d}}} x \circ f$ and $t_{\bar{s}} \subseteq^{J^{\text{d}}} u_{\bar{s}}$. Define $G_-(x) := \langle x_f : f \in F \rangle$ and $G_+(\bar{s}) := u_{\bar{s}}$. We prove that for every $x \in D$ and $\bar{s} \in \prod_{f \in F} E_f$, $G_-(x) \sqsubset^{\otimes} \bar{s}$ implies $x \in^A G_+(\bar{s})$.

⁹The latter assumption “for all $f \in F, \dots$ ” can be replaced by $D \sqsubseteq^J \{x \in {}^{\omega}\omega : (\forall f \in F) x \circ f \in D_f\}$ and the proof is similar.

Let $x \in D$ and $\bar{s} \in \prod_{f \in F} E_f$ and assume that $x_f \in^{A_f} s_f$ for all $f \in F$, i.e., $\|x_f \in s_f\| \in A_f$. Since $\|x_f = x \circ f\| \in J_f^d$, we get that $\|x \circ f \in s_f\| \in A_f$. We claim that $\|x \circ f \in s_f\| \subseteq f^{-1}[\|x \in t_{\bar{s}}\|]$. Indeed, if $x(f(k)) \in s_f(k)$ then, for $n = f(k)$, $x(n) \in \bigcup_{i \in f^{-1}[\{n\}]} s_f(i) \subseteq t_{\bar{s}}(n)$ because $k \in f^{-1}[\{n\}]$. Then $f^{-1}[\|x \in t_{\bar{s}}\|] \in A_f$ because A_f is \subseteq -upwards closed, so $\|x \in t_{\bar{s}}\| \in f^{\rightarrow}(A_f)$. We have seen that $\|x \in t_{\bar{s}}\| \in \bigcap_{f \in F} f^{\rightarrow}(A_f)$. Since $\|t_{\bar{s}} \subseteq u_{\bar{s}}\| \cap \|x \in t_{\bar{s}}\| \subseteq \|x \in u_{\bar{s}}\|$, $\|t_{\bar{s}} \subseteq u_{\bar{s}}\| \in J^d$ and A is \subseteq -upwards closed, we get $\|x \in u_{\bar{s}}\| \in A$, i.e., $x \in^A G_+(\bar{s})$.

(b)–(c): Apply (a) to $A_f = J_f^d$ and $A = J^d$ in case (b) and to $A_f = J_f^+$ and $A = J^+$ in case (c). \square

Lemma 3.11. *Let $f \in {}^\omega\omega$, let J and J' be ideals on ω , let $A, A' \subseteq \mathcal{P}(\omega)$, and let D, D', E, E' be sets of functions with domain ω . Denote*

$$\begin{aligned} D_f &= \{x_f : x \in D\} & \text{where } x_f(n) &= x \upharpoonright f^{-1}[\{n\}], n \in \omega, \text{ and} \\ E'^f &= \{s^f : s \in E'\} & \text{where } s^f(k) &= \{t(k) : t \in s(f(k)) \text{ is a function and } k \in \text{dom}(t)\}, k \in \omega, \end{aligned}$$

and assume that $D_f \subseteq D'$ and $E'^f \subseteq E$.

- (a) *If $A' \subseteq f^{\rightarrow}(A)$ and A is \subseteq -upwards closed, then $\langle D, E, \in^A \rangle \leq_{\mathbb{T}} \langle D', E', \in^{A'} \rangle$; in particular, $\mathfrak{d}_A(D, E) \leq \mathfrak{d}_{A'}(D', E')$.*
- (b) *If $J' \subseteq f^{\rightarrow}(J)$ then $\mathbf{Lc}_J(D, E) \leq_{\mathbb{T}} \mathbf{Lc}_{J'}(D', E')$ and $\mathfrak{sl}_t(D, E, J) \leq \mathfrak{sl}_t(D', E', J')$.*
- (c) *If $f^{\rightarrow}(J) \subseteq J'$ then $\mathbf{pLc}_J(D, E) \leq_{\mathbb{T}} \mathbf{pLc}_{J'}(D', E')$ and $\mathfrak{sl}_e(D, E, J) \leq \mathfrak{sl}_e(D', E', J')$.*

Proof. (a): Define $G_- : D \rightarrow D'$ and $G_+ : E' \rightarrow E$ by $G_-(x) := x_f$ and $G_+(s) := s^f$. We show that (G_-, G_+) is the desired Tukey connection. Let $x \in D$, $s \in E'$, and assume that $G_-(x) \in^{A'} s$, i.e., $\|x_f \in s\| \in A'$. Then $f^{-1}[\|x_f \in s\|] \in A$. Note that $x_f(f(k)) \in s(f(k))$ implies $x(k) \in s^f(k)$ because $k \in f^{-1}[\{f(k)\}] = \text{dom}(x_f(f(k)))$. Therefore $f^{-1}[\|x_f \in s\|] \subseteq \|x \in s^f\|$. Then $\|x \in s^f\| \in A$ (because A is \subseteq -upwards closed), i.e., $x \in^A G_+(s)$.

(b) follows directly by (a) applied to $A = J^d$ and $A' = J'^d$, and (c) follows by (a) applied to $A = J^+$ and $A' = J'^+$. \square

For the following results, we fix the following notation.

Notation 3.12. When $\bar{f} = \langle f_n : n < \omega \rangle$ is a sequence of functions and x is a function with domain ω , let $\bar{f} * x$ be the function whose domain are those $n < \omega$ such that $x(n) \in \text{dom } f_n$, and $(\bar{f} * x)(n) := f_n(x(n))$. Also let $\bar{f} \otimes x$ be the function with domain ω such that $(\bar{f} \otimes x)(n) := f_n^{-1}[x(n)]$.

Let F be a set of sequences \bar{f} as above, and let $\bar{s} = \langle s_{\bar{f}} : \bar{f} \in F \rangle$ be a sequence of functions with domain ω . Then define the function $F \otimes \bar{s}$ with domain ω , such that

$$(F \otimes \bar{s})(n) := \bigcap_{\bar{f} \in F} \bigcup h_n^{-1}[\|s_{\bar{f}}(n)\|].$$

We also allow the notation $\bar{f} * D := \{\bar{f} * x : x \in D\}$ and $F \otimes E := \{F \otimes \bar{s} : \bar{s} \in E\}$ when D is a set of functions with domain ω and E is a set of sequences of the form $\bar{s} = \langle s_{\bar{f}} : \bar{f} \in F \rangle$ as above. Likewise for $\bar{f} \otimes D$.

When f is a function, denote $f * D := \{f \circ x : x \in D\}$.

Lemma 3.13. *Let D, D', E, E' be sets of functions with domain ω , and $\bar{f} = \langle f_n : n < \omega \rangle$ a sequence of functions. Assume that $\bar{f} * D \subseteq D'$ and $\bar{f} \otimes E' \subseteq E$. Then $\langle D, E, \in^A \rangle \leq_{\mathbb{T}} \langle D', E', \in^A \rangle$, in particular, $\mathfrak{d}_A(D, E) \leq \mathfrak{d}_A(D', E')$.*

Proof. Define $F: D \rightarrow D'$ and $G: E' \rightarrow E$ such that $F(x) := \bar{f} * x$ and $G(s') := \bar{f} \otimes s'$. It is clear that (F, G) is the desired Tukey connection. \square

Lemma 3.14. *Let F be a finite set of sequences $\bar{f} = \langle f_n : n < \omega \rangle$, where each f_n is a function, let $D, D_{\bar{f}}, E, E_{\bar{f}}$ ($\bar{f} \in F$) be sets of functions with domain ω , and let J be an ideal on ω . If for every $\bar{f} \in F$, $\bar{f} * D \sqsubseteq^J D_{\bar{f}}$,¹⁰ and $F \otimes \prod_{\bar{f} \in F} E_{\bar{f}} \subseteq^J E$, then $\mathbf{Lc}_J(D, E) \leq_T \otimes_{\bar{f} \in F} \mathbf{Lc}_J(D_{\bar{f}}, E_{\bar{f}})$; in particular, $\mathfrak{sl}_t(D, E, J) \leq \prod_{\bar{f} \in F} \mathfrak{sl}_t(D_{\bar{f}}, E_{\bar{f}}, J)$.*

Moreover, when $F = \{\bar{f}\}$, we also obtain $\mathbf{pLc}_J(D, E) \leq_T \mathbf{pLc}_J(D_{\bar{f}}, E_{\bar{f}})$ and $\mathfrak{sl}_e(D, E, J) \leq \mathfrak{sl}_e(D_{\bar{f}}, E_{\bar{f}}, J)$.

Proof. Define $\Phi_-: D \rightarrow \prod_{\bar{f} \in F} D_{\bar{f}}$ and $\Phi_+: \prod_{\bar{f} \in F} E_{\bar{f}} \rightarrow E$ as follows: For $x \in D$ choose $\Phi_-(x) = \langle x_{\bar{f}} : \bar{f} \in F \rangle \in \prod_{\bar{f} \in F} D_{\bar{f}}$ so that $\bar{f} * x = {}^{J^d} x_{\bar{f}}$ for every $\bar{f} \in F$. For $\bar{s} \in \prod_{\bar{f} \in F} E_{\bar{f}}$ choose $\Phi_+(\bar{s}) = t_{\bar{s}} \in E$ such that $F \otimes \bar{s} \subseteq {}^{J^d} t_{\bar{s}}$. Assume that $\Phi_-(x) \sqsubseteq^{\otimes} \bar{s}$, i.e., for every $\bar{h} \in F$, $\|x_{\bar{h}} \in s_{\bar{h}}\| \in J^d$. Then $a_{\bar{h}} := \|\bar{h} * x = x_{\bar{h}}\| \cap \|x_{\bar{h}} \in s_{\bar{h}}\| \in J^d$ and $a_{\bar{h}} \subseteq \left\{ n < \omega : x(n) \in \bigcup_{\bar{f} \in F} h_n^{-1}[\|s_{\bar{f}}(n)\|] \right\}$. Since F is finite, $\bigcap_{\bar{h} \in F} a_{\bar{h}} \in J^d$ and so $x \in {}^{J^d} F \otimes \bar{s}$. Then $x \in {}^{J^d} \Phi_+(\bar{s})$ because $F \otimes \bar{s} \subseteq {}^{J^d} t_{\bar{s}}$.

When $F = \{\bar{f}\}$, we also obtain $\mathbf{pLc}_J(D, E) \leq_T \mathbf{pLc}_J(D_{\bar{f}}, E_{\bar{f}})$ with the same proof (just noting that $a_{\bar{f}} \in J^+$). \square

As a consequence of the previous, we can infer:

Corollary 3.15. *Let F and J be as before, and let $\bar{I}^{\bar{f}} = \langle I_n^{\bar{f}} : n < \omega \rangle$ ($\bar{f} \in F$) and $\bar{I}' = \langle I'_n : n < \omega \rangle$ be sequences of families of sets.¹¹ If $\bar{f} * D \sqsubseteq^J D_{\bar{f}}$ for all $\bar{f} \in F$ and, for all $n < \omega$ and $\bar{a} \in \prod_{\bar{f} \in F} I_n^{\bar{f}}$, $\bigcap_{\bar{h} \in F} h_n^{-1}[\bigcup_{\bar{f} \in F} a_{\bar{f}}] \in I'_n$, then $\mathbf{Lc}_J(D', \bar{I}') \leq_T \otimes_{\bar{f} \in F} \mathbf{Lc}_J(D_{\bar{f}}, \bar{I}^{\bar{f}})$. In particular, $\mathfrak{sl}_t(D', \bar{I}', J) \leq \prod_{\bar{f} \in F} \mathfrak{sl}_t(D_{\bar{f}}, \bar{I}^{\bar{f}}, J)$.*

In addition, when $F = \{\bar{f}\}$, $\mathbf{pLc}_J(D', \bar{I}') \leq_T \mathbf{pLc}_J(D_{\bar{f}}, \bar{I}^{\bar{f}})$ and $\mathfrak{sl}_e(D', \bar{I}', J) \leq \mathfrak{sl}_e(D_{\bar{f}}, \bar{I}^{\bar{f}}, J)$. \square

Corollary 3.16. *Let F and J be as before, and $\bar{I} = \langle I_n : n < \omega \rangle$ and $\bar{I}' = \langle I'_n : n < \omega \rangle$ sequences of families of sets where each I_n is an ideal on some $b(n)$. If $\bar{f} * D \sqsubseteq^J D_{\bar{f}}$ for all $\bar{f} \in F$ and $I_n \subseteq \{a \subseteq b(n) : \bigcap_{\bar{h} \in F} h_n^{-1}[a] \in I'_n\}$ for all $n < \omega$, then $\mathbf{Lc}_J(D', \bar{I}') \leq_T \otimes_{\bar{f} \in F} \mathbf{Lc}_J(D_{\bar{f}}, \bar{I})$. In particular, $\mathfrak{sl}_t(D', \bar{I}', J) \leq \prod_{\bar{f} \in F} \mathfrak{sl}_t(D_{\bar{f}}, \bar{I}, J)$.*

In addition, when $F = \{\bar{f}\}$, $\mathbf{pLc}_J(D', \bar{I}') \leq_T \mathbf{pLc}_J(D_{\bar{f}}, \bar{I})$ and $\mathfrak{sl}_e(D', \bar{I}', J) \leq \mathfrak{sl}_e(D_{\bar{f}}, \bar{I}, J)$. \square

Corollary 3.17. *Let F be a finite set of functions with domain ω , J an ideal on ω , and let I' and I_f ($f \in F$) be families of sets. If $f * D \sqsubseteq^J D_f$ for all $f \in F$ and, for all $\bar{a} \in \prod_{f \in F} I_f$, $\bigcap_{h \in F} h^{-1}[\bigcup_{f \in F} a_f] \in I'$, then $\mathbf{Lc}_J(D', I') \leq_T \otimes_{f \in F} \mathbf{Lc}_J(D_f, I_f)$ and $\mathbf{L}_{I', J}(D) \leq_T \otimes_{f \in F} \mathbf{L}_{I_f, J}(D_f)$. In particular, $\mathfrak{sl}_t(D', I', J) \leq \prod_{f \in F} \mathfrak{sl}_t(D_f, I_f, J)$ and $\mathfrak{l}_{D'}(I', J) \leq \prod_{d \in F} \mathfrak{l}_{D_f}(I_f, J)$.*

In addition, when $F = \{f\}$, $\mathbf{pLc}_J(D', I') \leq_T \mathbf{pLc}_J(D_f, I_f)$, $\mathbf{pL}_{I', J}(D') \leq_T \mathbf{pL}_{I_f, J}(D_f)$, $\mathfrak{sl}_e(D', I', J) \leq \mathfrak{sl}_e(D_f, I, J)$ and $\mathfrak{p}_{D'}(I', J) \leq \mathfrak{p}_{D_f}(I_f, J)$. \square

Corollary 3.18. *Let F, J , and I' be as before, and let I be an ideal on some set a_* . If $f * D \sqsubseteq^J D_f$ for all $f \in F$ and $I \subseteq \{a \subseteq a_* : \bigcap_{h \in F} h^{-1}[a] \in I'\}$, then $\mathbf{Lc}_J(D', I') \leq_T \otimes_{f \in F} \mathbf{Lc}_J(D_f, I)$ and $\mathbf{L}_{I', J}(D) \leq_T \otimes_{f \in F} \mathbf{L}_{I, J}(D_f)$. In particular, $\mathfrak{sl}_t(D', I', J) \leq \prod_{f \in F} \mathfrak{sl}_t(D_f, I, J)$ and $\mathfrak{l}_{D'}(I', J) \leq \prod_{f \in F} \mathfrak{l}_{D_f}(I, J)$.*

In addition, when $F = \{f\}$, $\mathbf{pLc}_J(D', I') \leq_T \mathbf{pLc}_J(D_f, I)$, $\mathbf{pL}_{I', J}(D') \leq_T \mathbf{pL}_{I, J}(D_f)$, $\mathfrak{sl}_e(D', I', J) \leq \mathfrak{sl}_e(D_f, I, J)$ and $\mathfrak{p}_{D'}(I', J) \leq \mathfrak{p}_{D_f}(I, J)$. \square

¹⁰So $\bar{f} * x$ has domain ω for all $\bar{f} \in F$ and $x \in D$.

¹¹In most cases, sequences of ideals.

We close this section with a general result that uses point-wise intersections of slaloms. This will be used in [Theorem 5.7](#).

Lemma 3.19. *Let E_0, E_1 and E be sets of slaloms and assume that, for any $s \in E_0$ and $s' \in E_1$, $s \wedge s' := \langle s(n) \cap s'(n) : n < \omega \rangle \in E$. Let D be a set of functions with domain ω and J an ideal on ω . Then:*

(a) $\mathbf{Lc}_J(D, E) \leq_T \mathbf{Lc}_J(D, E_0) \otimes \mathbf{Lc}_J(D, E_1)$.

(b) $\mathbf{pLc}_J(D, E) \leq_T \mathbf{Lc}_J(D, E_0) \otimes \mathbf{pLc}_J(D, E_1)$.

(c) *Assume that $D \subseteq {}^\omega a$ and, for any $s' \in E_1$, there is some $s'' \in E_1$ such that $s' \subseteq^{\text{Fin}^d} s''$ and $s''(n) \subseteq s''(n+1)$ for all $n < \omega$. Then $\mathfrak{sl}_e(D, E, \text{Fin}) \leq \mathfrak{sl}_e(D, E_0, \text{Fin}) \cdot \mathfrak{sl}_e({}^\omega a, E_1, \text{Fin})$.*

Proof. The maps $x \mapsto (x, x)$ and $(s, s') \mapsto s \wedge s'$ gives the Tukey connections for (a) and (b).

(c): Assume that $S_0 \subseteq E_0$ and $S_1 \subseteq E_1$ are witnesses of $\mathfrak{sl}_e(D, E_0, \text{Fin})$ and $\mathfrak{sl}_e({}^\omega a, E_1, \text{Fin})$, respectively. By the assumption, we can also assume that, for every $s' \in S_1$, $s'(n) \subseteq s'(n+1)$ for all $n \in \omega$. Then $\{s \wedge s' : s \in S_0, s' \in S_1\}$ is dominating in $\mathbf{pLc}_{\text{Fin}}(D, E)$. Indeed, for every $x \in D$ there is an $s \in S_0$ such that $x \in^{\text{Fin}^+} s$. Pick an increasing function $g \in {}^\omega \omega$ such that $x(g(k)) \in s(g(k))$ for all $k \in \omega$. Then, there is an $s' \in S_1$ such that $x \circ g \in^{\text{Fin}^+} s'$. However, $s'(k) \subseteq s'(g(k))$ for each $k \in \omega$. Hence, $x \circ g \in^{\text{Fin}^+} s' \circ g$, and so $x \in^{\text{Fin}^+} s \wedge s'$ as well.

A dual argument shows that $\min\{\mathfrak{sl}_e^\perp(D, E_0, \text{Fin}), \mathfrak{sl}_e^\perp({}^\omega a, E_1, \text{Fin})\} \leq \mathfrak{sl}_e^\perp(D, E, \text{Fin})$. \square

Remark 3.20. Except for [Lemma 3.19 \(c\)](#), ω is immaterial for the development of the theory and results of this section. In general, the sets of functions and slaloms we have dealt with can have domain some infinite (possibly uncountable) set w , and J can be assumed to be an ideal on w .

4. Partial orderings of ideals

We shall be interested mainly in the particular cases of slalom invariants $\mathfrak{sl}_e(I, J)$, $\mathfrak{sl}_t(I, J)$, $\mathfrak{sl}_e(\star, J)$, $\mathfrak{sl}_t(\star, J)$, $\mathfrak{sl}_e(b, h, J)$, and $\mathfrak{sl}_t(b, h, J)$ (with special attention to $\prod b = {}^\omega \omega$ where I and J are ideals on ω and $h \in {}^\omega \omega$). Let us recall that

$$\begin{aligned} \text{cov}^*(I) &= \min\{|A| : A \subseteq I \text{ and } (\forall a \in [\omega]^\omega)(\exists b \in A) |a \cap b| = \omega\} = \mathfrak{d}([\omega]^{\aleph_0}, I, \perp^{\text{Fin}}), \\ \text{non}^*(I) &= \min\{|E| : E \subseteq [\omega]^{\aleph_0} \text{ and } (\forall b \in I)(\exists a \in E) |a \cap b| < \aleph_0\} = \mathfrak{b}([\omega]^{\aleph_0}, I, \perp^{\text{Fin}}), \\ \mathfrak{b}_J &= \mathfrak{b}({}^\omega \omega, {}^\omega \omega, \leq^{J^d}), \text{ and} \\ \mathfrak{d}_J &= \mathfrak{d}({}^\omega \omega, {}^\omega \omega, \leq^{J^d}), \end{aligned}$$

where $a \perp^{\text{Fin}} b$ iff $a \cap b$ is finite. Observe that $\text{cov}^*(I) = \mathfrak{p}_K(I, \text{Fin})$, $\mathfrak{b}_J = \mathfrak{sl}_e(\text{Fin}, J)$, and $\mathfrak{d}_J = \mathfrak{sl}_t(\text{Fin}, J)$, even more, $\langle [\omega]^{\aleph_0}, I, \perp^{\text{Fin}} \rangle \cong_T \mathbf{pL}(I, \text{Fin})$ and $\langle {}^\omega \omega, {}^\omega \omega, \leq^{J^d} \rangle \cong_T \mathbf{Lc}_J(\text{Fin}) \cong_T \mathbf{pLc}_J(\text{Fin})^\perp$. The obvious inequalities (which follow from [Lemma 3.4](#) and [Corollary 3.5](#)) between the studied slalom numbers are summarized in the following diagram in which \rightarrow denotes \leq and $h \geq^* 1$ in ${}^\omega \omega$:

$$\begin{array}{ccccccccc} \mathfrak{sl}_t(\star, J) & \rightarrow & \mathfrak{sl}_t(I, J) & \rightarrow & \mathfrak{d}_J & \rightarrow & \mathfrak{sl}_t(h, J) & & \mathfrak{sl}_t(I, J) & \rightarrow & \mathfrak{l}_K(I, J) \\ & & \uparrow & & \uparrow & & \uparrow & & \uparrow & & \uparrow \\ \mathfrak{sl}_e(\star, J) & \rightarrow & \mathfrak{sl}_e(I, J) & \rightarrow & \mathfrak{b}_J & \rightarrow & \mathfrak{sl}_e(h, J) & & \mathfrak{sl}_e(I, J) & \rightarrow & \mathfrak{p}_K(I, J) \end{array}$$

All these cardinals are uncountable as a consequence of [Theorem 4.8 \(c\)](#), even above the *pseudo-intersection number* \mathfrak{p} (see also [Theorem 4.7](#), [Lemma 4.12 \(b\)](#) and [Figure 6](#)), and below \mathfrak{c} when well-defined. The only cardinals that may not be well-defined are $\mathfrak{p}_K(I, J)$ and $\mathfrak{l}_K(I, J)$, see [Lemma 4.2](#) and [4.10](#).

Definition 4.1. Let a and a' be sets, $I \subseteq \mathcal{P}(a)$ and $J \subseteq \mathcal{P}(a')$ (usually ideals). The family of all J -to-one functions in $a'a$ is denoted by $(a'a)^J$, i.e., $f \in (a'a)^J$ iff $f: a' \rightarrow a$ and $f^{-1}[\{n\}] \in J$ for all $n \in a$. We consider the following partial quasi-orderings (usually between ideals):¹²

$$\begin{aligned}
I \leq_{\text{RK}} J &\text{ iff } (\exists f \in a'a) I = f^{\rightarrow}(J) && \text{(Rudin-Keisler),} \\
I \leq_{\text{K}} J &\text{ iff } (\exists f \in a'a) I \subseteq f^{\rightarrow}(J) && \text{(Katětov),} \\
I \leq_{\overline{\text{K}}} J &\text{ iff } (\exists f \in a'a) f^{\rightarrow}(I) \subseteq J && \text{(dual Katětov),} \\
I \leq_{\text{RB}} J &\text{ iff } (\exists f \in (a'a)^{\text{Fin}}) I = f^{\rightarrow}(J) && \text{(Rudin-Blass),} \\
I \leq_{\text{KB}} J &\text{ iff } (\exists f \in (a'a)^{\text{Fin}}) I \subseteq f^{\rightarrow}(J) && \text{(Katětov-Blass),} \\
I \leq_{\overline{\text{KB}}} J &\text{ iff } (\exists f \in (a'a)^{\text{Fin}}) f^{\rightarrow}(I) \subseteq J && \text{(dual Katětov-Blass).}
\end{aligned}$$

Note that if $a = a'$ and $I \subseteq J$ then $I \leq_{\text{KB}} J$ and $I \leq_{\overline{\text{KB}}} J$, witnessed by the identity map. Moreover, $\leq_{\text{RB}} \subseteq \leq_{\text{KB}} \subseteq \leq_{\text{K}}$ and $\leq_{\text{RB}} \subseteq \geq_{\overline{\text{KB}}}$. In addition, to present some monotonicity results we shall need the following partial ordering.

$$I \leq_{\overline{\text{K}}} J \text{ iff } (\exists F \in [a'a]^{<\omega}) I \subseteq \{w \subseteq a : \bigcap_{f \in F} f^{-1}[\{w\}] \in J\}.$$

It is clear that $\leq_{\text{K}} \subseteq \leq_{\overline{\text{K}}}$, i.e., $\leq_{\overline{\text{K}}}$ is a generalization of \leq_{K} . Notice that $\leq_{\overline{\text{K}}}$ is a preorder.

We write $J' \approx_{\text{K}} J$ if $J' \leq_{\text{K}} J$ and $J \leq_{\text{K}} J'$, similarly for $\approx_{\overline{\text{K}}}$, $\approx_{\overline{\text{K}}}$, etc.

It follows from the definitions that $\mathfrak{p}_{\text{K}}(I, J)$ is undefined iff $I \leq_{\text{K}} J$. In general:

Lemma 4.2. *Let a be a set, $D \subseteq \omega a$, $I \subseteq \mathcal{P}(a)$ and $J \subseteq \mathcal{P}(\omega)$. Then:*

(a) $\mathfrak{p}_D(I, J)$ is undefined iff $I \subseteq f^{\rightarrow}(J)$ for some $f \in D$.

(b) $\mathfrak{l}_D(I, J)$ is undefined iff $I \subseteq f^{\rightarrow}(J^{\text{dc}})$ for some $f \in D$. □

We have the following general result for \leq_{K} .

Lemma 4.3. *Let $I \subseteq \mathcal{P}(a)$, $I' \subseteq \mathcal{P}(a')$, $A \subseteq \mathcal{P}(\omega)$ and let $D \subseteq \omega a$ and $D' \subseteq \omega a'$. Further, assume that $I' \leq_{\text{K}} I$ is witnessed by an $f: a \rightarrow a'$ and $f \circ x \in D'$ for every $x \in D$. Then $\langle D, \omega I, \in^A \rangle \leq_{\text{T}} \langle D', \omega I', \in^A \rangle$ and $\langle D, \text{ct}(I), \in^A \rangle \leq_{\text{T}} \langle D', \text{ct}(I'), \in^A \rangle$. In particular, $\mathfrak{d}_A(D, \omega I) \leq \mathfrak{d}_A(D', \omega I')$ and $\mathfrak{d}_A(D, \text{ct}(I)) \leq \mathfrak{d}_A(D', \text{ct}(I'))$.*

Proof. This is a particular case of [Lemma 3.13](#). □

If M is a class, \sqsubseteq is a relation on M , and $\lambda(I)$ is a cardinal invariant depending on some parameter $I \in M$ then we say that $\lambda(I)$ is \sqsubseteq -decreasing (\sqsubseteq -increasing) if $\lambda(I_1) \leq \lambda(I_0)$ ($\lambda(I_0) \leq \lambda(I_1)$) whenever $I_0 \sqsubseteq I_1$. In a similar way, when $\mathbf{R}(I)$ is a relational system depending on $I \in M$, we say that $\mathbf{R}(I)$ is \sqsubseteq -increasing if $\mathbf{R}(I_0) \leq_{\text{T}} \mathbf{R}(I_1)$ whenever $I_0 \sqsubseteq I_1$ (and decreasing is defined naturally). For example, the previous lemma indicates that $\langle \omega a, I, \in^A \rangle$ and $\langle \omega a, \text{ct}(I), \in^A \rangle$ are \leq_{K} -decreasing on I , and so are $\mathfrak{d}_A(\omega a, I)$ and $\mathfrak{d}_A(\omega a, \text{ct}(I))$ as a consequence.

A more concrete example:

Lemma 4.4. *Let J be an ideal on ω . Then¹³*

(a) $\mathfrak{p}_{\text{Lc}_J}(I)$ and $\mathfrak{p}_{\text{L}_{I,J}}$ are \leq_{K} -decreasing on $I \subseteq \mathcal{P}(\omega)$. Consequently, $\mathfrak{sl}_e(I, J)$ and $\mathfrak{p}_{\text{K}}(I, J)$ are \leq_{K} -decreasing on I . In particular, $\text{cov}^*(I)$ is \leq_{K} -decreasing on I .

¹²See [\[GM23\]](#) for applications of the dual Katětov-Blass ordering $\leq_{\overline{\text{KB}}}$.

¹³The fact about $\mathfrak{sl}_e(I, J)$ has been shown in [\[Šup16\]](#). Moreover, the \leq_{K} -monotonicity only requires $J \subseteq \mathcal{P}(\omega)$.

(b) $\mathbf{Lc}_J(I)$ and $\mathbf{L}_{I,J}$ are \leq_K -decreasing on $I \subseteq \mathcal{P}(\omega)$, and $\mathfrak{sl}_t(I, J)$ and $\mathfrak{l}_K(I, J)$ are \leq_K^{\square} -decreasing on ideals I on ω .

Proof. (a) and (b) for \leq_K are immediate consequences of Lemma 4.3. For the remaining part of (b): Let $I' \leq_K^{\square} I$ be witnessed by a set $F \subseteq {}^\omega\omega$. By applying Corollary 3.18 to $D = D' = {}^\omega\omega$, we obtain $\mathbf{Lc}(I', J) \leq_T^F \mathbf{Lc}(I, J)$ and $\mathbf{L}_{I',J} \leq_T^F \mathbf{L}_{I,J}$, so the result follows (also because $\mathfrak{sl}_t(I, J)$ and $\mathfrak{l}_K(I, J)$ are infinite, the latter possibly with value ∞). \square

The previous results are enough to characterize the slalom numbers $\mathfrak{sl}_e(\star, J)$ and $\mathfrak{sl}_t(\star, J)$. We first generalize (part of) Lemma 4.4 as follows.

Lemma 4.5. *Let $b = \langle b(n) : n < \omega \rangle$ and $b' = \langle b'(n) : n < \omega \rangle$ be sequences of non-empty sets, $\bar{I} = \langle I_n : n < \omega \rangle$ and $\bar{I}' = \langle I'_n : n < \omega \rangle$ such that $I_n \subseteq \mathcal{P}(b(n))$ and $I'_n \subseteq \mathcal{P}(b'(n))$ for all $n < \omega$, let $A \subseteq \mathcal{P}(\omega)$, and let $D \subseteq \prod b$ and $D' \subseteq \prod b'$. Assume that, for $n < \omega$, $I'_n \leq_K I_n$ witnessed by a function $f_n: b(n) \rightarrow b'(n)$. Further assume that, for any $x \in D$, $x' \in D'$ where x' is the function defined by $x'(n) := f_n(x(n))$. Then $\langle D, \bar{I}, \in^A \rangle \leq_T \langle D', \bar{I}', \in^A \rangle$, in particular $\mathfrak{d}_A(D, \bar{I}) \leq \mathfrak{d}_A(D', \bar{I}')$.*

Proof. Immediate from Lemma 3.13. \square

Theorem 4.6. *For $A \subseteq \mathcal{P}(\omega)$,*¹⁴

$$\begin{aligned} \mathfrak{d}_A(\star) &= \min\{\mathfrak{d}_A(\bar{I}) : \bar{I} \text{ is a sequence of ideals on } \omega\} \\ &= \min\{\mathfrak{d}_A(I) : I \text{ is an ideal on } \omega\}. \end{aligned}$$

Proof. The first equality is clear: on one hand, for any sequence \bar{I} of ideals on ω , any $S \subseteq \prod \bar{I}$ satisfies property \star , so $\mathfrak{d}_A(\star) \leq \mathfrak{d}_A(\bar{I})$ follows; on the other hand, if S witnesses $\mathfrak{d}_A(\star)$, since it satisfies property \star , then $S \subseteq \prod \bar{I}$ for some sequence \bar{I} of ideals on ω , so $\mathfrak{d}_A(\bar{I}) \leq \mathfrak{d}_A(\star)$.

For the second equality, \leq is clear. For the converse, if \bar{I} is a sequence of ideals, then there is some ideal I on ω such that $I_n \leq_K I$ for all $n < \omega$, see [Mez09, BF12]. Hence, by Lemma 4.5, $\mathfrak{d}_A(I) \leq \mathfrak{d}_A(\bar{I})$. \square

As a consequence:

Theorem 4.7. *Let J be an ideal on ω . Then*

$$\begin{aligned} \mathfrak{sl}_e(\star, J) &= \min\{\mathfrak{sl}_e(\bar{I}, J) : \bar{I} \text{ is a sequence of ideals on } \omega\} \\ &= \min\{\mathfrak{sl}_e(I, J) : I \text{ is an ideal on } \omega\} \end{aligned}$$

and

$$\begin{aligned} \mathfrak{sl}_t(\star, J) &= \min\{\mathfrak{sl}_t(\bar{I}, J) : \bar{I} \text{ is a sequence of ideals on } \omega\} \\ &= \min\{\mathfrak{sl}_t(I, J) : I \text{ is an ideal on } \omega\}. \end{aligned}$$

Proof. Immediate from Theorem 4.6 applied to $A = J^+$ and $A = J^d$, respectively. \square

Concerning the case $J = \text{Fin}$, it is known that:

Theorem 4.8 ([ŠŠ19, Š23]).

(a) $\mathfrak{sl}_e(I, \text{Fin}) = \min\{\text{cov}^*(I), \mathfrak{b}\}$.

¹⁴This can be generalized to $\mathfrak{d}_A({}^\omega a, \star) = \min\{\mathfrak{d}_A({}^\omega a, I) : I \text{ is an ideal on } a\}$ for any infinite set a .

(b) $\mathfrak{p}_K(\star, \text{Fin}) = \min\{\text{cov}^*(I) : I \text{ is an ideal on } \omega\} = \mathfrak{p}$.

(c) $\mathfrak{sl}_e(\star, \text{Fin}) = \mathfrak{p}$. □

The equality $\mathfrak{sl}_t(\star, \text{Fin}) = \text{cov}(\mathcal{M})$ is proved in [Š23] by applying topological selection principles. Here, we provide a direct combinatorial proof.

Theorem 4.9. $\mathfrak{sl}_t(\star, \text{Fin}) = \mathfrak{sl}_t(\mathcal{P}(\omega) \setminus \{\omega\}, \text{Fin}) = \text{cov}(\mathcal{M})$.

Proof. Recall that $\text{cov}(\mathcal{M})$ is the smallest size of an eventually different family in ${}^\omega\omega$ (see Theorem 4.20 (a) for $h = 1$), i.e., of a family $D \subseteq {}^\omega\omega$ such that

$$(\forall x \in {}^\omega\omega)(\exists y \in D)(\exists m < \omega)(\forall n \geq m) x(n) \neq y(n).$$

We show that such a D allows to construct a localizing set of slaloms with property \star . This guarantees $\mathfrak{sl}_t(\star, \text{Fin}) \leq \text{cov}(\mathcal{M})$. Instead of ${}^\omega\omega$, we look at $\prod_{n < \omega} W_n$ where $W_n := \text{Fn}(w_n, \omega)$, $\{w_n : n < \omega\}$ is a partition of ω into infinite sets and $\text{Fn}(A, B)$ denotes the set of finite partial functions from A into B . For $y \in {}^\omega\omega$, define $s_y \in \prod_{n < \omega} \mathcal{P}(W_n)$ by

$$s_y(n) := \{p \in W_n : (\forall m \in \text{dom } p) p(m) \neq y(m)\}.$$

We show that $S := \{s_y : y \in D\}$ is a localizing family with property \star . Indeed, if $z \in \prod_{n < \omega} W_n$, then we can find some $x \in {}^\omega\omega$ such that $z(n) \subseteq x$ for all $n < \omega$. Hence, there is some $y \in {}^\omega\omega$ eventually different with x , so $z(n) \in s_y(n)$ for all but finitely many $n < \omega$.

It remains to show that S satisfies property \star . Let $\{y_i : i < k\} \subseteq D$ and $n < \omega$, and we show that $\bigcup_{i < k} s_{y_i}(n)$ is co-infinite. We may assume that $k \neq 0$. For any $c := \{m_i : i < k\} \subseteq w_n$ (one-to-one enumeration), we can define $p \in W_n$ with domain c such that $p(m_i) := y_i(m_i)$, so $p \notin \bigcup_{i < k} s_{y_i}(n)$. This guarantees that $\bigcup_{i < k} s_{y_i}(n)$ is co-infinite.

The inequality $\text{cov}(\mathcal{M}) \leq \mathfrak{sl}_t(\star, \text{Fin})$ is easier to show. By Lemma 3.7 (c), $\mathfrak{sl}_t(\mathcal{P}(\omega) \setminus \{\omega\}, \text{Fin}) \leq \mathfrak{sl}_t(\star, \text{Fin})$, so it is enough to show that $\text{cov}(\mathcal{M}) \leq \mathfrak{sl}_t(\mathcal{P}(\omega) \setminus \{\omega\}, \text{Fin})$. We even have the Tukey connection $\langle {}^\omega\omega, \mathcal{M}, \in \rangle \leq_T \mathbf{Lc}_{\text{Fin}}(\mathcal{P}(\omega) \setminus \{\omega\})$ because, for $s \in {}^\omega(\mathcal{P}(\omega) \setminus \{\omega\})$, we have that $\{x \in {}^\omega\omega : x \in^{\text{Fin}^d} s\}$ is F_σ meager. Moreover, we actually have that $\mathbf{Lc}_{\text{Fin}}(\mathcal{P}(\omega) \setminus \{\omega\}) \cong_T \langle {}^\omega\omega, {}^\omega\omega, \neq^{\text{Fin}^+} \rangle$. □

Concerning $\mathfrak{l}_K(\star, \text{Fin})$, we have:

Lemma 4.10. *If J is an ideal on ω and there is an infinite partition of ω into J -positive sets, then $\mathfrak{l}_K(\star, J) = \mathfrak{l}_K(I, J) = \infty$ (i.e., undefined) for every ideal I on ω .*

Proof. Choose a partition $\{a_n : n \in \omega\} \subseteq J^+$ of ω and define $x(k) = n$ for $k \in a_n$ and $n \in \omega$. If $a \in I$, then $x^{-1}[[a]] \notin J^d$ because $x^{-1}[[a]] \subseteq \omega \setminus a_n \notin J^d$ for any $n \in \omega \setminus a$. This indicates that $x \notin^{J^d} s$ for any $s \in \text{ct}(I)$. □

We show in Section 5 that the above is the only case when $\mathfrak{l}_K(\star, J)$ is undefined.

To look at more monotonicity results, we generalize the orderings of Definition 4.1 as follows.

Definition 4.11. For $I \subseteq \mathcal{P}(a)$ and $J \subseteq \mathcal{P}(a')$, define

$$\begin{aligned} I \leq_{\mathbb{K}}^{\sqcup} J &\text{ iff } I \subseteq \left\{ w \subseteq a : \bigcup_{f \in F} f^{-1}[[w]] \in J \right\} \text{ for some non-empty } F \in [a']^{<\omega}, \\ I \leq_{\mathbb{K}}^{\sqcup} J &\text{ iff } \left\{ w \subseteq a' : \bigcup_{f \in F} f^{-1}[[w]] \in I \right\} \subseteq J \text{ for some non-empty } F \in [a']^{<\omega}, \\ I \leq_{\mathbb{RK}}^{\sqcup} J &\text{ iff } \left\{ w \subseteq a : \bigcup_{f \in F} f^{-1}[[w]] \in J \right\} = I \text{ for some non-empty } F \in [a']^{<\omega}. \end{aligned}$$

The orderings $\leq_{\mathbb{KB}}^{\sqcup}$, $\leq_{\mathbb{KB}}^{\sqcup}$ and $\leq_{\mathbb{RB}}^{\sqcup}$ are obtained by demanding that all functions in F are finite-to-one. We have $\leq_{\mathbb{K}} \subseteq \leq_{\mathbb{K}}^{\sqcup}$, $\leq_{\mathbb{K}} \subseteq \leq_{\mathbb{K}}^{\sqcup}$, $\leq_{\mathbb{KB}} \subseteq \leq_{\mathbb{KB}}^{\sqcup}$, $\leq_{\mathbb{KB}} \subseteq \leq_{\mathbb{KB}}^{\sqcup}$, $\leq_{\mathbb{RB}} \subseteq \leq_{\mathbb{RB}}^{\sqcup}$. We define $\approx_{\mathbb{K}}^{\sqcup}$, etc., in the natural way.

Lemma 4.12. *Let I be an ideal on ω . In the results below, J runs on ideals on ω .*

- (a) $\mathbf{pL}_{I,J}$ is $\leq_{\mathbb{K}}$ -increasing on J and $\mathbf{L}_{I,J}$ is $\leq_{\mathbb{K}}^{\sqcup}$ -decreasing on J . Also, $\mathbf{pK}(I, J)$ and $\mathbf{pK}(\star, J)$ are $\leq_{\mathbb{K}}$ -increasing¹⁵ and $\mathbf{l}_{\mathbb{K}}(I, J)$ and $\mathbf{l}_{\mathbb{K}}(\star, J)$ are $\leq_{\mathbb{K}}^{\sqcup}$ -decreasing on the parameter J .
- (b) $\mathbf{pLc}_J(I)$ is $\leq_{\mathbb{KB}}$ -increasing and $\mathbf{Lc}_J(I)$ is $\leq_{\mathbb{KB}}^{\sqcup}$ -decreasing on J . Also, $\mathbf{sl}_e(I, J)$ and $\mathbf{sl}_e(\star, J)$ are $\leq_{\mathbb{KB}}$ -increasing and $\mathbf{sl}_t(I, J)$ and $\mathbf{sl}_t(\star, J)$ are $\leq_{\mathbb{KB}}^{\sqcup}$ -decreasing on the parameter J .

Proof. (a): We apply [Lemmas 3.9](#) and [3.10](#) to $D = D' = {}^\omega\omega$ and $E = E' = \text{ct}(I)$. When $J' \leq_{\mathbb{K}} J$, the hypotheses of [Lemma 3.9 \(a\)](#) (with $s' := s$) are satisfied, where f is a function witnessing $J' \leq_{\mathbb{K}} J$, so $\mathbf{pL}_{I,J'} \leq_{\mathbb{T}} \mathbf{pL}_{I,J}$.

When $J \leq_{\mathbb{K}}^{\sqcup} J'$, the hypotheses of [Lemma 3.10 \(b\)](#), with F witnessing $J \leq_{\mathbb{K}}^{\sqcup} J'$, are satisfied, so we get that $\mathbf{L}_{I,J'} \leq_{\mathbb{T}}^F \mathbf{L}_{I,J}$.

(b): We apply [Lemmas 3.9](#) and [3.10](#) to $D = D' = {}^\omega\omega$ and $E = E' = {}^\omega I$. Since they satisfy the hypotheses of [Lemma 3.9](#), where f is a function witnessing either $J' \leq_{\mathbb{KB}} J$ or $J \leq_{\mathbb{KB}}^{\sqcup} J'$, we get that $\mathbf{pLc}_{J'}(I) \leq_{\mathbb{T}} \mathbf{pLc}_J(I)$ in the first case, and $\mathbf{Lc}_{J'}(I) \leq_{\mathbb{T}} \mathbf{Lc}_J(I)$ in the second.

The monotonicity result for $\leq_{\mathbb{KB}}^{\sqcup}$ follows by [Lemma 3.10 \(b\)](#) in a similar way. \square

In particular, when $I = \text{Fin}$:

Corollary 4.13. *On the parameter J , $\langle {}^\omega\omega, {}^\omega\omega, \leq^{J^d} \rangle$ is $\leq_{\mathbb{KB}}$ -decreasing and $\leq_{\mathbb{KB}}^{\sqcup}$ -decreasing. Moreover:*

- (a) \mathbf{b}_J is $\leq_{\mathbb{KB}}$ -increasing and $\leq_{\mathbb{KB}}^{\sqcup}$ -increasing.
- (b) \mathbf{d}_J is $\leq_{\mathbb{KB}}$ -decreasing and $\leq_{\mathbb{KB}}^{\sqcup}$ -decreasing. \square

We compile our results below in terms of equivalences.

Theorem 4.14. *Let I, J and J' be ideals on ω . Then*

- (a) *If $J' \approx_{\mathbb{K}} J$, then $\mathbf{pL}_{\mathbb{K}}(I, J) \cong_{\mathbb{T}} \mathbf{pL}_{\mathbb{K}}(I, J')$. In particular, $\mathbf{pK}(I, J') = \mathbf{pK}(I, J)$ and $\mathbf{pK}(\star, J') = \mathbf{pK}(\star, J)$.*
- (b) *If $J' \approx_{\mathbb{K}}^{\sqcup} J$, then $\mathbf{L}_{\mathbb{K}}(I, J) \cong_{\mathbb{T}} \mathbf{L}_{\mathbb{K}}(I, J')$,¹⁶ and whenever $J' \approx_{\mathbb{K}}^{\sqcup} J$, $\mathbf{l}_{\mathbb{K}}(I, J') = \mathbf{l}_{\mathbb{K}}(I, J)$ and $\mathbf{l}_{\mathbb{K}}(\star, J') = \mathbf{l}_{\mathbb{K}}(\star, J)$.*

¹⁵Up to here, it is not required that I is an ideal.

¹⁶Up to here (including (a)), there is no need that I is an ideal.

- (c) If $J' \approx_{\text{KB}} J$, then $\langle \omega\omega, \omega\omega, \leq^{J^d} \rangle \cong_{\text{T}} \langle \omega\omega, \omega\omega, \leq^{J'^d} \rangle$ and $\mathbf{pLc}(I, J) \cong_{\text{T}} \mathbf{pLc}(I, J')$. In particular, $\mathfrak{b}_{J'} = \mathfrak{b}_J$, $\mathfrak{d}_{J'} = \mathfrak{d}_J$, $\mathfrak{sl}_e(I, J') = \mathfrak{sl}_e(I, J)$, and $\mathfrak{sl}_e(\star, J') = \mathfrak{sl}_e(\star, J)$.
- (d) If $J' \approx_{\overline{\text{KB}}} J$, then $\langle \omega\omega, \omega\omega, \leq^{J^d} \rangle \cong_{\text{T}} \langle \omega\omega, \omega\omega, \leq^{J'^d} \rangle$ and $\mathbf{Lc}(I, J) \cong_{\text{T}} \mathbf{Lc}(I, J')$. Moreover, if $J' \approx_{\overline{\text{KB}}} J$, then $\mathfrak{b}_{J'} = \mathfrak{b}_J$, $\mathfrak{d}_{J'} = \mathfrak{d}_J$, $\mathfrak{sl}_t(I, J') = \mathfrak{sl}_t(I, J)$, and $\mathfrak{sl}_t(\star, J') = \mathfrak{sl}_t(\star, J)$.
- (e) If J is an ideal with the Baire property, then $\mathbf{L}_{I, J} \cong_{\text{T}} \mathbf{L}_{I, \text{Fin}}$, $\langle \omega\omega, \omega\omega, \leq^{J^d} \rangle \cong_{\text{T}} \langle \omega\omega, \omega\omega, \leq^{\text{Fin}^d} \rangle$ and $\mathbf{Lc}(I, J) \cong_{\text{T}} \mathbf{Lc}(I, \text{Fin})$. In particular, $\mathfrak{l}_K(I, J) = \mathfrak{l}_K(\star, J) = \infty$, $\mathfrak{b}_J = \mathfrak{b}$, $\mathfrak{d}_J = \mathfrak{d}$,¹⁷ $\mathfrak{sl}_t(I, J) = \mathfrak{sl}_t(I, \text{Fin})$, and $\mathfrak{sl}_t(\star, J) = \mathfrak{sl}_t(\star, \text{Fin})$.

Proof. (a)–(d) follow by Lemma 4.12 and Corollary 4.13.

(e): Clearly, $\mathfrak{l}_K(I, \text{Fin}) = \mathfrak{l}_K(\star, \text{Fin}) = \infty$ by Lemma 4.10. Since J has the Baire property, $\text{Fin} \leq_{\text{RB}} J$ by Jalali–Naini and Talagrand theorem and $\text{Fin} \leq_{\overline{\text{KB}}} J$ because $\text{Fin} \subseteq J$. Therefore $J \approx_{\overline{\text{KB}}} \text{Fin}$ and all Tukey equivalences are consequences of (b) and (d). \square

To compare the assumptions of Theorem 4.14 (d)–(e) note that

$$\text{“}J \text{ has the Baire property”} \Leftrightarrow \text{Fin} \leq_{\text{RB}} J \Leftrightarrow J \leq_{\overline{\text{KB}}} \text{Fin} \Leftrightarrow \text{Fin} \approx_{\overline{\text{KB}}} J.$$

Consequently, if J' has the Baire property, then

$$\text{“}J \text{ has the Baire property”} \Leftrightarrow J \leq_{\overline{\text{KB}}} J' \Leftrightarrow J' \approx_{\overline{\text{KB}}} J.$$

We now turn to slalom numbers of the form $\mathfrak{sl}_t(b, h, J) = \mathfrak{d}_{J^d}(\prod b, \mathcal{S}(b, h))$ and $\mathfrak{sl}_e(b, h, J) = \mathfrak{d}_{J^d}(\prod b, \mathcal{S}(b, h))$ for $h \in \omega\omega$ and $b = \langle b(i) : i < \omega \rangle$ with $b(i)$ non-empty for all $i < \omega$. In the case when all $b(i)$ are countable, it is enough to study the case $b(i) \in \omega \cup \{\omega\}$ for all $i < \omega$ thanks to the following result.

Lemma 4.15. *Let J be an ideal on ω . If $\{i < \omega : |b'(i)| \leq |b(i)|\} \in J^d$ and $h \leq^{J^d} h'$, then $\mathbf{Lc}_J(b', h') \leq_{\text{T}} \mathbf{Lc}_J(b, h)$ and $\mathbf{pLc}_J(b', h') \leq_{\text{T}} \mathbf{pLc}_J(b, h)$. In particular, $\mathfrak{sl}_e(b', h', J) \leq \mathfrak{sl}_e(b, h, J)$ and $\mathfrak{sl}_t(b', h', J) \leq \mathfrak{sl}_t(b, h, J)$.*

Proof. Let $w := \{i < \omega : |b'(i)| \leq |b(i)| \text{ and } h(i) \leq h'(i)\} \in J^d$. For each $i \in w$, pick a one-to-one function $f_i: b'(i) \rightarrow b(i)$, and for $i \in \omega \setminus w$ pick any $f_i: b'(i) \rightarrow b(i)$. Apply Lemma 3.14 to $\bar{f} := \langle f_i : i < \omega \rangle$ and $F := \{\bar{f}\}$. \square

We first look at monotonicity results.

Lemma 4.16. *If $J \subseteq J' \subseteq \mathcal{P}(\omega)$, then $\mathbf{Lc}_{J'}(b, h) \leq_{\text{T}} \mathbf{Lc}_J(b, h)$ and $\mathbf{pLc}_J(b, h) \leq_{\text{T}} \mathbf{pLc}_{J'}(b, h)$. In particular, $\mathfrak{sl}_t(b, h, J') \leq \mathfrak{sl}_t(b, h, J)$ and $\mathfrak{sl}_e(b, h, J) \leq \mathfrak{sl}_e(b, h, J')$.*

Proof. Immediate from Lemma 3.7 (d). \square

Lemma 4.17. *Let $f \in \omega\omega$ be a finite-to-one function and let J and J' be ideals on ω . For $n < \omega$, denote $a_n^f := f^{-1}[\{n\}]$. Let $h \in \omega\omega$, and consider functions $h_f^-, h_f' \in \omega\omega$ such that*

$$\left\{ n \in \omega : \text{whenever } a_n^f \neq \emptyset, h_f^-(n) \leq \min_{k \in a_n^f} h(k) \text{ and } \sum_{k \in a_n^f} h(k) \leq h_f'(n) \right\} \in J'^d.$$

¹⁷The equalities $\mathfrak{b}_J = \mathfrak{b}$, $\mathfrak{d}_J = \mathfrak{d}$ are well-known, see the introduction for the appropriate references.

Let $b = \langle b(n) : n < \omega \rangle$, $b_f^- = \langle b_f^-(n) : n < \omega \rangle$ and $b'_f = \langle b'_f(n) : n < \omega \rangle$ be sequences of non-empty sets such that

$$\left\{ n < \omega : \left| \prod_{k \in a_n^f} b(k) \right| \leq |b_f^-(n)| \right\} \in J'^d \text{ and } \{k \in \omega : |b(f(k))| \leq |b'_f(k)|\} \in J^d.$$

Then:

- (a) If f witnesses that $J' \leq_{\text{KB}} J$ then $\mathbf{Lc}_J(b, h) \leq_{\text{T}} \mathbf{Lc}_{J'}(b_f^-, h_f^-)$ and $\mathbf{pLc}_{J'}(b, h'_f) \leq_{\text{T}} \mathbf{pLc}_J(b'_f, h)$. In particular, $\mathfrak{sl}_t(b, h, J) \leq \mathfrak{sl}_t(b_f^-, h_f^-, J')$ and $\mathfrak{sl}_e(b, h'_f, J') \leq \mathfrak{sl}_e(b'_f, h, J)$.
- (b) If f witnesses $J \leq_{\overline{\text{KB}}} J'$ then $\mathbf{pLc}_J(b, h) \leq_{\text{T}} \mathbf{pLc}_{J'}(b_f^-, h_f^-)$ and $\mathbf{Lc}_{J'}(b, h'_f) \leq_{\text{T}} \mathbf{Lc}_J(b'_f, h)$. In particular, $\mathfrak{sl}_e(b, h, J) \leq \mathfrak{sl}_e(b_f^-, h_f^-, J')$ and $\mathfrak{sl}_t(b, h'_f, J') \leq \mathfrak{sl}_t(b'_f, h, J)$.

Furthermore, let $F \subseteq {}^\omega \omega$ be a finite set of finite-to-one functions and consider $b'_f : \omega \rightarrow \omega + 1 \setminus \{0\}$ and h'_f for $f \in F$ as before, and define $h'_F \in {}^\omega \omega$ by $h'_F(n) := \sum_{f \in F} h'_f(n)$.

- (c) If F witnesses that $J \leq_{\overline{\text{KB}}} J'$ then $\mathbf{Lc}_{J'}(b, h'_F) \leq_{\text{T}} \bigotimes_{f \in F} \mathbf{Lc}_J(b'_f, h)$. In particular, $\mathfrak{sl}_t(b, h'_F, J') \leq \prod_{f \in F} \mathfrak{sl}_t(b'_f, h, J)$.

Proof. Thanks to [Lemma 4.15](#), we may assume that, for $n < \omega$, $b(n)$ is a non-zero cardinal number,

$$b_f^-(n) = \prod_{k \in a_n^f} b(k), \quad b'_f(n) = b(f(n)),$$

and, whenever $a_n^f \neq \emptyset$,

$$h_f^-(n) = \min_{k \in a_n^f} h(k) \text{ and } h'_f(n) = \sum_{k \in a_n^f} h(k).$$

- (a): For \mathbf{Lc} , it follows by [Lemma 3.11 \(b\)](#) applied to $D = \prod b$, $D' = \prod b_f^-$, $E = \mathcal{S}(b, h)$ and $E' = \mathcal{S}(b_f^-, h_f^-)$; for \mathbf{pLc} , it follows by [Lemma 3.9 \(a\)](#) applied to $D' = \prod b$, $D = \prod b'_f$, $E = \mathcal{S}(b'_f, h)$ and $E' = \mathcal{S}(b, h'_f)$.
- (b): For \mathbf{pLc} , it follows by [Lemma 3.11 \(c\)](#) applied to $D = \prod b$, $D' = \prod b_f^-$, $E = \mathcal{S}(b, h)$ and $E' = \mathcal{S}(b_f^-, h_f^-)$; for \mathbf{Lc} , it follows by [Lemma 3.9 \(b\)](#) applied to $D' = \prod b$, $D = \prod b'_f$, $E = \mathcal{S}(b'_f, h)$ and $E' = \mathcal{S}(b, h'_f)$.
- (c): It follows by [Lemma 3.10 \(b\)](#) applied to $D_f = \prod b'_f$, $D = \prod b$, $E_f = \mathcal{S}(b'_f, h)$ and $E = \mathcal{S}(b, h'_F)$. \square

In the case when $\prod b = {}^\omega \omega$, the previous result applies to $\prod b_f^- = \prod b'_f = {}^\omega \omega$. As a consequence:

Lemma 4.18. *Let $h \in {}^\omega \omega$ and J and J' be ideals on ω .*

- (a) If $J' \leq_{\text{KB}} J$ then there are $h^-, h' \in {}^\omega \omega$ such that $\mathbf{Lc}_J(h) \leq_{\text{T}} \mathbf{Lc}_{J'}(h^-)$ and $\mathbf{pLc}_{J'}(h') \leq_{\text{T}} \mathbf{pLc}_J(h)$, in particular, $\mathfrak{sl}_t(h, J) \leq \mathfrak{sl}_t(h^-, J')$ and $\mathfrak{sl}_e(h', J') \leq \mathfrak{sl}_e(h, J)$.
- (b) If $J \leq_{\overline{\text{KB}}} J'$ then there are $h^-, h' \in {}^\omega \omega$ such that $\mathbf{pLc}_J(h) \leq_{\text{T}} \mathbf{pLc}_{J'}(h^-)$ and $\mathbf{Lc}_{J'}(h') \leq_{\text{T}} \mathbf{Lc}_J(h)$. In particular, $\mathfrak{sl}_e(h, J) \leq \mathfrak{sl}_e(h^-, J')$ and $\mathfrak{sl}_t(h', J') \leq \mathfrak{sl}_t(h, J)$.
- (c) If $J' \leq_{\text{RB}} J$ then there are $h^-, h' \in {}^\omega \omega$ satisfying the statements in (a) and (b).
- (d) If $J \leq_{\overline{\text{KB}}} J'$ then there is some $h' \in {}^\omega \omega$ such that $\mathbf{Lc}_{J'}(h') \leq_{\text{T}} {}^n \mathbf{Lc}_J(h)$ for some $0 < n < \omega$, in particular, $\mathfrak{sl}_t(h', J') \leq \mathfrak{sl}_t(h, J)$.

Moreover, if h diverges to infinity, h^- can be found diverging to infinity, and when $h \geq^* 1$, h^- can be found such that $h^- \geq^* 1$. On the other hand, h' can be found diverging to infinity (and as increasing as desired).

Proof. If $f: \omega \rightarrow \omega$ is a finite-to-one function witnessing the relation between J and J' indicated in (a)–(c), then $h^- = h_{\bar{f}}$ and $h' = h'_f$ can be defined by

$$h^-(n) := \begin{cases} \min_{k \in a_n^f} h(k), & \text{if } a_n^f \neq \emptyset, \\ n, & \text{otherwise,} \end{cases} \quad h'(n) := \begin{cases} \sum_{k \in a_n^f} h(k), & \text{if } a_n^f \neq \emptyset, \\ n, & \text{otherwise,} \end{cases}$$

where $a_n^f := f^{-1}[\{n\}]$. Then (a) and (b) follows by Lemma 4.17, (c) follows by (a) and (b), and (d) follows by Lemma 4.17 (c).

It is clear that h^- and h' diverge to ∞ when h does, and that $h \geq^* 1$ implies $h^- \geq^* 1$ and $h' \geq^* 1$. But thanks to Lemma 4.15, h' can be enlarged as desired. \square

Although $\mathfrak{sl}_t(h, J)$ and $\mathfrak{sl}_e(h, J)$ are well-defined and uncountable when $h \geq^d 1$, with the additional parameter b we get cases when $\mathfrak{sl}_t(b, h, J)$ is finite, likewise for $\mathfrak{sl}_e(b, h, J)$.

Lemma 4.19. *Let $b = \langle b(n) : n < \omega \rangle$ be a sequence of non-empty sets and $h \in {}^\omega \omega$.*

- (a) $\mathfrak{sl}_e(b, h, J)$ is well-defined iff $\|h \geq 1\| \in J^+$, and $\mathfrak{sl}_t(b, h, J)$ is well-defined iff $\|h \geq 1\| \in J^d$.
- (b) For $0 < k < \omega$, $\mathfrak{sl}_e(b, h, J) \leq k$ iff $\{n < \omega : |b(n)| \leq k h(n)\} \in J^+$.
- (c) $\mathfrak{sl}_e(b, E, J) \neq \aleph_0$ for any set of slaloms E .
- (d) For $0 < k < \omega$, if $\mathfrak{sl}_t(b, h, J) \leq k$ then $\{n < \omega : |b(n)| > k h(n)\} \in J$.
- (e) $\mathfrak{sl}_t(b, h, J) = 1$ iff $\{n < \omega : |b(n)| > h(n)\} \in J$.
- (f) $\mathfrak{sl}_t(b, h, J) = 2$ iff $\{n < \omega : |b(n)| > 2h(n)\} \in J$, $a := \{n < \omega : h(n) < |b(n)| \leq 2h(n)\} \in J^+$ and $J \cap \mathcal{P}(a)$ is a maximal ideal on a .
- (g) For any set of slaloms E , either $\mathfrak{sl}_t(b, E, \text{Fin}) = 1$ or $\mathfrak{sl}_t(b, E, \text{Fin}) > \aleph_0$.

Proof. Let $c_k := \{n < \omega : |b(n)| \leq k h(n)\}$ for $0 < k < \omega$. For $n \in c_k$, let $\langle s_\ell^k(n) : \ell < k \rangle \subseteq [b(n)]^{\leq h(n)}$ be a covering of $b(n)$, and let $s_\ell^k(n) := \emptyset$ for $n \in \omega \setminus c_k$. This defines $s_\ell^k \in \mathcal{S}(b, h)$ for $\ell < k$.

(a): If $\|h \geq 1\| \in J^+$ then, for any $x \in \prod b$, there is some $s \in \mathcal{S}(b, h)$ such that $x(n) \in s(n)$ for all $n \in \|h \geq 1\|$, namely $s(n) := \{x(n)\}$ when $n \in \|h \geq 1\|$, and $s(n) := \emptyset$ otherwise, so $x \in^{J^+} s$; and if $\|h \geq 1\| \in J$ then $x \notin^{J^+} s$ for all $x \in \prod b$ and $s \in \mathcal{S}(b, h)$, since $n \notin \|h \geq 1\|$ implies that $s(n) = \emptyset$. A similar argument works for $\mathfrak{sl}_t(b, h, J)$.

(b): If $c_k \in J^+$ then, for any $x \in \prod b$, there is some $\ell < k$ such that $x \in^{J^+} s_\ell^k$, so $\mathfrak{sl}_e(b, h, J) \leq k$. Conversely, if $c_k \in J$ then, for any $S \subseteq \mathcal{S}(b, h)$ of size $\leq k$ and $n \in \omega \setminus c_k$, $\bigcup_{s \in S} s(n) \subsetneq b(n)$, so there is some $x(n) \in b(n)$ outside this union. Then $x(n) \notin s(n)$ for all $n \in \omega \setminus c_k$ and $s \in S$, i.e., $x \notin^{J^+} s$.

(c): Let $S = \{s^\ell : \ell < \omega\} \subseteq E$ and assume that $\mathfrak{sl}_e(b, E, J)$ is infinite. For each $m < \omega$, we can find some $x^m \in \prod b$ and a set $a_m \in J^d$ such that $x^m(n) \notin s^\ell(n)$ for all $n \in a_m$ and $\ell \leq m$. By taking intersections if necessary, we may assume that $a_{m+1} \subseteq a_m$. Define $x \in \prod b$ such that, for any $n \in a_0$, $x(n) := x^{m_n}(n)$ where $m_n := \max\{m \leq n : n \in a_m\}$. Fix $\ell < \omega$. For $n \in a_\ell \setminus \ell$, $m_n \geq \ell$, so $x(n) = x^{m_n}(n) \notin s^\ell(n)$, hence $x \notin^{J^+} s^\ell$.

(d): Assume that $\omega \setminus c_k \in J^+$. Then, like in the second part of the proof of (b), for any $S \subseteq \mathcal{S}(b, h)$ of size $\leq k$ we can find some $x \in \prod b$ such that $x \notin^{J^d} s$ for all $s \in S$.

(e): One implication follows from (d). For the converse, if $\omega \setminus c_1 \in J$, i.e., $c_1 \in J^d$, then there is some $s \in \mathcal{S}(b, h)$ such that $s(n) = b(n)$ for all $n \in c_1$. Then $x \in^{J^d} s$ for all $x \in \prod b$.

(f): First note that $a = c_2 \setminus c_1$. Assume that $\mathfrak{sl}_t(b, h, J) = 2$ witnessed by $\{t^0, t^1\}$. Then, by (d) and (e), $\omega \setminus c_1 \in J^+$, $c_2 \in J^d$ and $a \in J^+$. Without loss of generality we may assume that, for $n \in c_1$, $t^0(n) =$

$t^1(n) = b(n)$ and, for $n \in c_2$, $t^0(n) \cup t^1(n) = b(n)$ (because $\{n \in \omega : t^0(n) \cup t^1(n) \neq b(n)\} \in J$). Now let $a' \subseteq a$. Define $x \in \prod b$ such that, for $n \in a$, $x(n) \in t^1(n) \setminus t^0(n)$ when $n \in a'$, and $x(n) \in t^0(n) \setminus t^1(n)$ when $n \in a \setminus a'$. Then, $\|x \in t^e\| \in J^d$ for some $e \in \{0, 1\}$. If $e = 0$ then $\|x \in t^0\| \cap a' = \emptyset$, so $a' \in J$; and if $e = 1$, $\|x \in t^1\| \cap a \subseteq a'$, so $a \setminus a' \in J$. This shows that $J \cap \mathcal{P}(a)$ is a maximal ideal on a .

For the converse, assume that $c_2 \in J^d$, $a \in J^+$ and $J \cap \mathcal{P}(a)$ is a maximal ideal on a . Then, by (e), $\mathfrak{sl}_t(b, h, J) > 1$. So it remains to show that $\{s_0^2, s_1^2\}$ witnesses that $\mathfrak{sl}_t(b, h, J) = 2$ by further assuming that $s_0^2(n) = s_1^2(n) = b(n)$ for $n \in c_1$. Let $x \in \prod b$ and $a' := \{n \in a : x(n) \in s_0^2(n)\}$. Since $J \cap \mathcal{P}(a)$ is a maximal ideal on a , either $a' \in J$ or $a \setminus a' \in J$. The first case implies $x \in J^d s_1^2$, while the second implies $x \in J^d s_0^2$.

(g): Let $S = \{s^\ell : \ell < \omega\} \subseteq E$ and assume that $\mathfrak{sl}_t(b, E, \text{Fin}) > 1$. For each $\ell < \omega$, we can find some $x^\ell \in \prod b$ and a set $a_\ell \in [\omega]^{\aleph_0}$ such that $x^\ell(n) \notin s^\ell(n)$ for all $n \in a_\ell$. We can easily construct a $x \in \prod b$ such that, for any $\ell < \omega$, $x(n) = x^\ell(n)$ for infinitely many $n \in a_\ell$, so $x \notin \text{Fin}^d s^\ell$. \square

It looks harder to characterize $\mathfrak{sl}_t(b, h, J) = k$ when $3 \leq k < \omega$.

The slalom numbers of the form $\mathfrak{sl}_t(h, \text{Fin})$ are very well-known as they characterize other classical cardinal characteristics of the continuum.

Theorem 4.20. *Let $g, h \in {}^\omega\omega$. Then*

- (a) (Bartoszyński [Bar87] and Miller [Mil82], see also [CM23, Thm. 5.1 and 3.17]) $\text{non}(\mathcal{M}) = \mathfrak{sl}_e(h, \text{Fin})$ and $\text{cov}(\mathcal{M}) = \mathfrak{sl}_e^\perp(h, \text{Fin})$ when $h \geq^{\text{Fin}^+} 1$, moreover, $\mathbf{pLc}_{\text{Fin}}(h) \cong_{\mathbf{T}} \mathbf{pLc}_{\text{Fin}}(1)$.
- (b) (Bartoszyński [Bar84], see also [CM23, Thm. 4.2]) $\mathbf{Lc}_{\text{Fin}}(g) \cong_{\mathbf{T}} \mathcal{N}$ when $\lim_{n \rightarrow \infty} g(n) = \infty$. As a consequence, $\mathfrak{sl}_t(g, \text{Fin}) = \text{cof}(\mathcal{N})$ and $\mathfrak{sl}_t^\perp(g, \text{Fin}) = \text{add}(\mathcal{N})$. \square

As a consequence of this theorem and Lemma 4.15, we get that $\text{non}(\mathcal{M}) \leq \mathfrak{sl}_e(h, J)$ and $\mathfrak{sl}_t(g, J) \leq \text{cof}(\mathcal{N})$ for any ideal J on ω when $h \geq^{J^+} 1$ and g diverges to ∞ . On the other hand, $\mathfrak{sl}_e(1, J_*) = \mathfrak{sl}_t(1, J_*) = \mathfrak{c}$ when J_* is a maximal ideal on ω (because of the size of an ultrapower of ω , see [For10, Prop. 5.44]). Also recall that $\mathfrak{sl}_t(h, \text{Fin}) = \mathfrak{c}$ and $\mathfrak{sl}_t^\perp(h, \text{Fin})$ is finite when $h \geq^* 1$ and h does not diverge to infinity (see [CM23, Thm. 3.12]).

The ideal Fin in Theorem 4.20 can be replaced by any ideal with the Baire property:

Theorem 4.21. *Let J be an ideal on ω with the Baire property and let $h, g \in {}^\omega\omega$ be such that $h \geq^* 1$ and $\lim_{n \in \omega} g(n) = \infty$. Then $\mathbf{pLc}_J(h) \cong_{\mathbf{T}} \mathbf{pLc}_{\text{Fin}}(1)$ and $\mathbf{Lc}_J(g) \cong_{\mathbf{T}} \mathcal{N}$, in particular $\mathfrak{sl}_e(h, J) = \text{non}(\mathcal{M})$, $\mathfrak{sl}_t(g, J) = \text{cof}(\mathcal{N})$, $\mathfrak{sl}_t^\perp(g, J) = \text{add}(\mathcal{N})$ and $\mathfrak{sl}_e^\perp(h, J) = \text{cov}(\mathcal{M})$.¹⁸*

Proof. Note that $\text{Fin} \leq_{\text{RB}} J$ (by Jalali-Naini and Talagrand, see e.g. [Far00]). Hence, by Lemma 4.18 (c), there are $g', g^-, h', h^- \in {}^\omega\omega$ such that $\mathbf{Lc}_{\text{Fin}}(g') \leq_{\mathbf{T}} \mathbf{Lc}_J(g) \leq_{\mathbf{T}} \mathbf{Lc}_{\text{Fin}}(g^-)$ and $\mathbf{pLc}_{\text{Fin}}(h') \leq_{\mathbf{T}} \mathbf{pLc}_J(h) \leq_{\mathbf{T}} \mathbf{pLc}_{\text{Fin}}(h^-)$, even more, g' and g^- can be found diverging to infinity and $h', h^- \geq^* 1$. Therefore, by Theorem 4.20, $\mathbf{Lc}_J(g) \cong_{\mathbf{T}} \mathcal{N}$ and $\mathbf{pLc}_J(h) \cong_{\mathbf{T}} \mathbf{pLc}_{\text{Fin}}(1)$. \square

Figure 6 summarizes the inequalities between slalom numbers of the form $\mathfrak{sl}_t(I, J)$ and $\mathfrak{sl}_e(I, J)$ with other cardinals from Cichoń's diagram. These are consequences of our results so far (including monotonicity). The upper part of the diagram can be obtained via Tukey connections, see Figure 7, which implies Figure 8.

5. Disjoint sum of ideals

In this section, we look at the slalom numbers associated with the disjoint sum of ideals. They have a nice behavior and are very useful to prove consistency results as in Section 7. Applications are also available in [GM23].

¹⁸The first equality is shown in [Šot20].

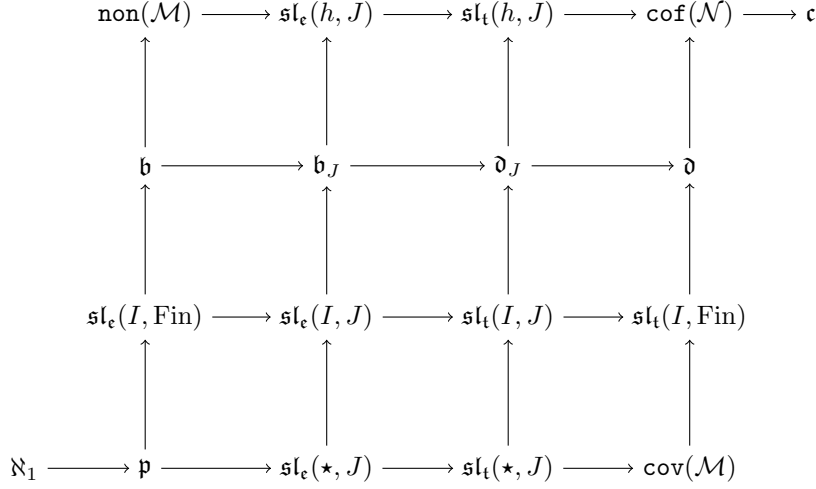

Figure 6: Inequalities among particular cases of slalom numbers for ideals I and J on ω and $h \rightarrow \infty$. An arrow denotes \leq . When $h \geq^* 1$ and h does not diverge to ∞ , $\text{cof}(\mathcal{N})$ should be replaced by $\mathfrak{sl}_t(h, \text{Fin}) = \mathfrak{c}$.

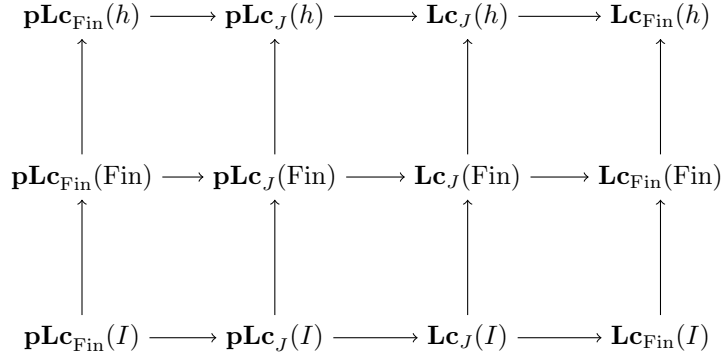

Figure 7: Diagram of Tukey connections for ideals I and J on ω and $h \geq^* 1$. An arrow denotes \leq_T .

Definition 5.1.

- (1) For sets a_0 and a_1 , denote $a_0 \oplus a_1 = (a_0 \times \{0\}) \cup (a_1 \times \{1\})$. When A_0 and A_1 are families of sets, define

$$A_0 \oplus A_1 = \{w_0 \oplus w_1 : w_0 \in A_0 \text{ and } w_1 \in A_1\}.$$

When I_0 and I_1 are ideals on a_0 and a_1 , respectively, we refer to $I_0 \oplus I_1$ as a *disjoint sum of ideals*, which is an ideal on $a_0 \oplus a_1$.

- (2) For arbitrary two functions f_0 and f_1 , define the function $f_0 \oplus f_1$ with domain $\text{dom } f_0 \oplus \text{dom } f_1$ by $(f_0 \oplus f_1)(n, i) = f_i(n)$. Conversely, to every function f with domain $a_0 \oplus a_1$ assign two functions $(f)_0$ and $(f)_1$ with domain a_0 and a_1 , respectively, such that $f = (f)_0 \oplus (f)_1$.
- (3) If D_0 and D_1 are sets of functions, we define¹⁹

$$D_0 \oplus D_1 := \{f_0 \oplus f_1 : f_0 \in D_0, f_1 \in D_1\}.$$

¹⁹There will not be confusion with (1) from the context.

$$\begin{array}{ccccccc}
\text{non}(\mathcal{M}) & \longrightarrow & \mathfrak{sl}_e(h, J) & \longrightarrow & \mathfrak{sl}_t(h, J) & \longrightarrow & \text{cof}(\mathcal{N}) \longrightarrow \mathbf{c} \\
\uparrow & & \uparrow & & \uparrow & & \uparrow \\
\mathbf{b} & \longrightarrow & \mathbf{b}_J & \longrightarrow & \mathbf{d}_J & \longrightarrow & \mathbf{d} \\
\uparrow & & \uparrow & & \uparrow & & \uparrow \\
\text{add}(\mathcal{N}) & \longrightarrow & \mathfrak{sl}_t^\perp(h, J) & \longrightarrow & \mathfrak{sl}_e^\perp(h, J) & \longrightarrow & \text{cov}(\mathcal{M})
\end{array}$$

Figure 8: Inequalities among particular cases of slalom numbers for ideals I and J on ω and $h \rightarrow \infty$. An arrow denotes \leq . When $h \geq^* 1$ and h does not diverge to ∞ , $\text{cof}(\mathcal{N})$ should be replaced by $\mathfrak{sl}_t(h, \text{Fin}) = \mathbf{c}$ and $\text{add}(\mathcal{N})$ by $\mathfrak{sl}_t^\perp(h, \text{Fin})$, which is finite.

Note that, When $I_0 \subseteq \mathcal{P}(a_0)$ and $I_1 \subseteq \mathcal{P}(a_1)$, $(I_0 \oplus I_1)^d = I_0^d \oplus I_1^d$ and $(I_0 \oplus I_1)^c = (I_0^c \oplus \mathcal{P}(a_1)) \cup (\mathcal{P}(a_0) \oplus I_1^c)$.

Lemma 5.2. *Let I_0 and I_1 be ideals on a set a . Then*

- (a) $I_0 \cap I_1 \leq_{\text{RB}} I_0 \oplus I_1$, $I_0 \leq_{\text{RB}} I_0 \oplus I_0$ and $I_0 \approx_{\text{RB}} I_0 \oplus \mathcal{P}(a) \approx_{\text{RB}} \mathcal{P}(a) \oplus I_0$.
- (b) $I_0 \oplus I_1 \leq_{\text{KB}} I_0, I_1$.
- (c) $I_0 \oplus I_1 \leq_{\text{KB}}^\perp I_0 \cap I_1$ and $I_0 \oplus I_0 \leq_{\text{RB}}^\perp I_0$.

Proof. The mappings $(n, i) \rightarrow n$, $n \rightarrow (n, 0)$ and $n \rightarrow (n, 1)$ can be used to prove the relations in (a)–(c). For example, (c) uses the set of the last two maps. \square

From now on, in our slalom relational systems we may consider that the domain of an ideal and of the functions and slaloms in consideration may not be ω but some other countable set like $\omega \oplus \omega$, so that we can discuss slalom numbers for ideals of the form, e.g. $J_0 \oplus J_1$ (see also Remark 3.20). The same conventions fixed in Definition 3.1 apply, for example, omitting D when $D = \omega \oplus \omega$.

For sums of ideals, we have the following general result.

Lemma 5.3. *Let D_0, D_1, E_0, E_1 be sets of functions with domain ω , and let $J_0, J_1 \subseteq \mathcal{P}(\omega)$. Then*

- (a) $\mathbf{Lc}_{J_0 \oplus J_1}(D_0 \oplus D_1, E_0 \oplus E_1) \cong_{\text{T}} \mathbf{Lc}_{J_0}(D_0, E_0) \otimes \mathbf{Lc}_{J_1}(D_1, E_1)$. In particular,
$$\max\{\mathfrak{sl}_t(D_0, E_0, J_0), \mathfrak{sl}_t(D_1, E_1, J_1)\} \leq \mathfrak{sl}_t(D_0 \oplus D_1, E_0 \oplus E_1, J_0 \oplus J_1) \leq \mathfrak{sl}_t(D_0, E_0, J_0) \cdot \mathfrak{sl}_t(D_1, E_1, J_1).$$
- (b) $\mathbf{pLc}_{J_0 \oplus J_1}(D_0 \oplus D_1, E_0 \oplus E_1) \cong_{\text{T}} \mathbf{pLc}_{J_0}(D_0, E_0) \boxtimes \mathbf{pLc}_{J_1}(D_1, E_1)$. In particular,
$$\mathfrak{sl}_e(D_0 \oplus D_1, E_0 \oplus E_1, J_0 \oplus J_1) = \min\{\mathfrak{sl}_e(D_0, E_0, J_0), \mathfrak{sl}_e(D_1, E_1, J_1)\}.$$

Proof. The Tukey connections are constructed using the canonical bijections $F: D_0 \times D_1 \rightarrow D_0 \oplus D_1$ and $G: E_0 \times E_1 \rightarrow E_0 \oplus E_1$. Note that

$$\begin{aligned}
F(x_0, x_1) \in^{(J_0 \oplus J_1)^d} G(y_0, y_1) & \text{ iff } x_0 \in^{J_0^d} y_0 \text{ and } x_1 \in^{J_1^d} y_1, \\
F(x_0, x_1) \in^{(J_0 \oplus J_1)^c} G(y_0, y_1) & \text{ iff } x_0 \in^{J_0^c} y_0 \text{ or } x_1 \in^{J_1^c} y_1.
\end{aligned}$$

The rest follows by Fact 2.5. \square

We start looking at more particular cases. As a direct consequence of the previous result:

Fact 5.4. *Let $J_0, J_1 \subseteq \mathcal{P}(\omega)$, b_0 and b_1 functions with domain ω and $h_0, h_1 \in {}^\omega\omega$. Then:*

$$\begin{aligned} \mathbf{Lc}_{J_0 \oplus J_1}(b_0 \oplus b_1, h_0 \oplus h_1) &= \mathbf{Lc}_{J_0 \oplus J_1} \left(\prod b_0 \oplus \prod b_1, \mathcal{S}(b_0, h_0) \oplus \mathcal{S}(b_1, h_1) \right) \\ &\cong_{\mathbf{T}} \mathbf{Lc}_{J_0}(b_0, h_0) \otimes \mathbf{Lc}_{J_1}(b_1, h_1), \\ \mathbf{pLc}_{J_0 \oplus J_1}(b_0 \oplus b_1, h_0 \oplus h_1) &= \mathbf{pLc}_{J_0 \oplus J_1} \left(\prod b_0 \oplus \prod b_1, \mathcal{S}(b_0, h_0) \oplus \mathcal{S}(b_1, h_1) \right) \\ &\cong_{\mathbf{T}} \mathbf{pLc}_{J_0}(b_0, h_0) \boxtimes \mathbf{pLc}_{J_1}(b_1, h_1). \end{aligned}$$

In particular,

$$\begin{aligned} \max\{\mathfrak{sl}_t(b_0, h_0, J_0), \mathfrak{sl}_t(b_1, h_1, J_1)\} &\leq \mathfrak{sl}_t(b_0 \oplus b_1, h_0 \oplus h_1, J_0 \oplus J_1) \leq \mathfrak{sl}_t(b_0, h_0, J_0) \cdot \mathfrak{sl}_t(b_1, h_1, J_1), \\ \mathfrak{sl}_e(b_0 \oplus b_1, h_0 \oplus h_1, J_0 \oplus J_1) &= \min\{\mathfrak{sl}_e(b_0, h_0, J_0), \mathfrak{sl}_e(b_1, h_1, J_1)\}. \quad \square \end{aligned}$$

Lemma 5.5. *Let J_0 and J_1 be ideals on ω , b_0 and b_1 functions with domain ω into the non-zero cardinal numbers, and $h_0, h_1 \in {}^\omega\omega$. Then:*

(a) $\mathbf{Lc}_{J_0 \cap J_1}(\inf\{b_0, b_1\}, h_0 + h_1) \leq_{\mathbf{T}} \mathbf{Lc}_{J_0 \oplus J_1}(b_0 \oplus b_1, h_0 \oplus h_1) \leq_{\mathbf{T}} \mathbf{Lc}_{J_0 \cap J_1}(b_0 \cdot b_1, \inf\{h_0, h_1\})$ and likewise for \mathbf{pLc} . In particular,

$$\begin{aligned} \mathfrak{sl}_t(\inf\{b_0, b_1\}, h_0 + h_1, J_0 \cap J_1) &\leq \mathfrak{sl}_t(b_0 \oplus b_1, h_0 \oplus h_1, J_0 \oplus J_1) \leq \mathfrak{sl}_t(b_0 \cdot b_1, \inf\{h_0, h_1\}, J_0 \cap J_1) \\ \mathfrak{sl}_e(\inf\{b_0, b_1\}, h_0 + h_1, J_0 \cap J_1) &\leq \mathfrak{sl}_e(b_0 \oplus b_1, h_0 \oplus h_1, J_0 \oplus J_1) \leq \mathfrak{sl}_e(b_0 \cdot b_1, \inf\{h_0, h_1\}, J_0 \cap J_1). \end{aligned}$$

(b) $\mathbf{Lc}_{J_0 \cap J_1}(b_0, 2h_0) \leq_{\mathbf{T}} \mathbf{Lc}_{J_0 \oplus J_1}(b_0 \oplus b_0, h_0 \oplus h_0) \leq_{\mathbf{T}} \mathbf{Lc}_{J_0 \cap J_1}(b_0^2, h_0)$ and likewise for \mathbf{pLc} . In particular,

$$\begin{aligned} \mathfrak{sl}_t(b_0, 2h_0, J_0 \cap J_1) &\leq \mathfrak{sl}_t(b_0 \oplus b_0, h_0 \oplus h_0, J_0 \oplus J_1) \leq \mathfrak{sl}_t(b_0^2, h_0, J_0 \cap J_1) \\ \mathfrak{sl}_e(b_0, 2h_0, J_0 \cap J_1) &\leq \mathfrak{sl}_e(b_0 \oplus b_0, h_0 \oplus h_0, J_0 \oplus J_1) \leq \mathfrak{sl}_e(b_0^2, h_0, J_0 \cap J_1). \end{aligned}$$

Proof. (a): Consider the function $\pi: \omega \oplus \omega \rightarrow \omega$ defined by $\pi(n, i) := n$ and note that $J_0 \cap J_1 = \pi^{-1}(J_0 \oplus J_1)$, so $J_0 \cap J_1 \leq_{\mathbf{RB}} J_0 \oplus J_1$ (see Lemma 5.2 (a)). Also notice that $\pi^{-1}[\{n\}] = \{(n, 0), (n, 1)\}$. Lemma 4.17 can be applied: we can use

$$\begin{aligned} b_{\pi}^{-}(n) &:= \prod_{u \in \pi^{-1}[\{n\}]} (b_0 \oplus b_1)(u) = b_0(n) \cdot b_1(n), \\ h_{\pi}^{-}(n) &:= \min\{(h_0 \oplus h_1)(u) : u \in \pi^{-1}[\{n\}]\} = \min\{h_0(n), h_1(n)\}, \\ h'_{\pi}(n) &:= \sum_{u \in \pi^{-1}[\{n\}]} (h_0 \oplus h_1)(u) = h_0(n) + h_1(n). \end{aligned}$$

We also require a function b with domain ω that allows $b'_{\pi} = b_0 \oplus b_1$ when applying Lemma 4.17, i.e., satisfying $|b(\pi(n, i))| \leq (b_0 \oplus b_1)(n, i)$ for all $(n, i) \in \omega \oplus \omega$. This is equivalent to $|b(n)| \leq b_e(n)$ for all $n < \omega$ and $e \in \{0, 1\}$, so $b(n) := \min\{b_0(n), b_1(n)\}$ works.

(b): Immediate from (a) applied to $b_1 := b_0$ and $h_1 := h_0$. □

As a direct consequence, we get:

Corollary 5.6. *Let J_0 and J_1 be ideals on ω and $h_0, h_1 \in {}^\omega\omega$. Then*

(a) $\mathbf{Lc}_{J_0 \oplus J_1}(h_0 \oplus h_1) \cong_{\mathbf{T}} \mathbf{Lc}_{J_0}(h_0) \otimes \mathbf{Lc}_{J_1}(h_1)$ and $\mathbf{pLc}_{J_0 \oplus J_1}(h_0 \oplus h_1) \cong_{\mathbf{T}} \mathbf{pLc}_{J_0}(h_0) \boxtimes \mathbf{pLc}_{J_1}(h_1)$. In particular,

$$\begin{aligned} \mathfrak{sl}_t(h_0 \oplus h_1, J_0 \oplus J_1) &= \max\{\mathfrak{sl}_t(h_0, J_0), \mathfrak{sl}_t(h_1, J_1)\}, \\ \mathfrak{sl}_t^{\perp}(h_0 \oplus h_1, J_0 \oplus J_1) &= \min\{\mathfrak{sl}_t^{\perp}(h_0, J_0), \mathfrak{sl}_t^{\perp}(h_1, J_1)\}, \\ \mathfrak{sl}_e(h_0 \oplus h_1, J_0 \oplus J_1) &= \min\{\mathfrak{sl}_e(h_0, J_0), \mathfrak{sl}_e(h_1, J_1)\}, \\ \mathfrak{sl}_e^{\perp}(h_0 \oplus h_1, J_0 \oplus J_1) &= \max\{\mathfrak{sl}_e^{\perp}(h_0, J_0), \mathfrak{sl}_e^{\perp}(h_1, J_1)\}. \end{aligned}$$

(b) $\mathbf{Lc}_{J_0 \cap J_1}(h_0 + h_1) \leq_T \mathbf{Lc}_{J_0 \oplus J_1}(h_0 \oplus h_1) \leq_T \mathbf{Lc}_{J_0 \cap J_1}(\inf\{h_0, h_1\})$ and likewise for \mathbf{pLc} . In particular,

$$\begin{aligned} \mathfrak{sl}_t(h_0 + h_1, J_0 \cap J_1) &\leq \mathfrak{sl}_t(h_0 \oplus h_1, J_0 \oplus J_1) \leq \mathfrak{sl}_t(\inf\{h_0, h_1\}, J_0 \cap J_1) \\ \mathfrak{sl}_e(h_0 + h_1, J_0 \cap J_1) &\leq \mathfrak{sl}_e(h_0 \oplus h_1, J_0 \oplus J_1) \leq \mathfrak{sl}_e(\inf\{h_0, h_1\}, J_0 \cap J_1). \end{aligned}$$

(c) $\mathbf{Lc}_{J_0 \cap J_1}(2h_0) \leq_T \mathbf{Lc}_{J_0 \oplus J_1}(h_0 \oplus h_0) \leq_T \mathbf{Lc}_{J_0 \cap J_1}(h_0)$ and likewise for \mathbf{pLc} . In particular,

$$\begin{aligned} \mathfrak{sl}_t(2h_0, J_0 \cap J_1) &\leq \mathfrak{sl}_t(h_0 \oplus h_0, J_0 \oplus J_1) \leq \mathfrak{sl}_t(h_0, J_0 \cap J_1) \\ \mathfrak{sl}_e(2h_0, J_0 \cap J_1) &\leq \mathfrak{sl}_e(h_0 \oplus h_0, J_0 \oplus J_1) = \mathfrak{sl}_e(h_0, J_0 \cap J_1). \end{aligned}$$

Proof. Immediate from Lemma 5.5 except $\mathfrak{sl}_e(h_0, J_0 \cap J_1) \leq \mathfrak{sl}_e(h_0 \oplus h_0, J_0 \oplus J_1)$ in (c). This follows because, by (a), $\mathfrak{sl}_e(h_0 \oplus h_0, J_0 \oplus J_1) = \min\{\mathfrak{sl}_e(h_0, J_0), \mathfrak{sl}_e(h_0, J_1)\}$, and both $\mathfrak{sl}_e(h_0, J_0)$ and $\mathfrak{sl}_e(h_0, J_1)$ are above $\mathfrak{sl}_e(h_0, J_0 \cap J_1)$ by Lemma 4.16. \square

We now look at the slalom numbers coming from $\mathbf{Lc}_J(I)$, $\mathbf{pLc}_J(I)$, $\mathbf{L}_{I,J}$ and $\mathbf{pL}_{I,J}$.

Theorem 5.7. *Let I, I_0, I_1 , and J be ideals on ω . Then*

(a) $\mathbf{Lc}_J(I \oplus \mathcal{P}(\omega)) \cong_T \mathbf{Lc}_J(I \oplus I) \cong_T \mathbf{Lc}_J(I)$, likewise for \mathbf{pLc} , \mathbf{L} and \mathbf{pL} . In particular,

$$\begin{aligned} \text{(a1)} \quad \mathfrak{sl}_t(I \oplus \mathcal{P}(\omega), J) &= \mathfrak{sl}_t(I \oplus I, J) = \mathfrak{sl}_t(I, J); & \text{(a3)} \quad \mathfrak{l}_K(I \oplus \mathcal{P}(\omega), J) &= \mathfrak{l}_K(I \oplus I, J) = \mathfrak{l}_K(I, J); \\ \text{(a2)} \quad \mathfrak{sl}_e(I \oplus \mathcal{P}(\omega), J) &= \mathfrak{sl}_e(I \oplus I, J) = \mathfrak{sl}_e(I, J); & \text{(a4)} \quad \mathfrak{p}_K(I \oplus \mathcal{P}(\omega), J) &= \mathfrak{p}_K(I \oplus I, J) = \mathfrak{p}_K(I, J). \end{aligned}$$

(b) For $e \in \{0, 1\}$, $\mathbf{Lc}_J(I_e) \leq_T \mathbf{Lc}_J(I_0 \oplus I_1) \leq_T \mathbf{Lc}_J(I_0 \cap I_1) \leq_T \mathbf{Lc}_J(I_0) \otimes \mathbf{Lc}_J(I_1)$ and $\mathbf{pLc}_J(I_e) \leq_T \mathbf{pLc}_J(I_0 \oplus I_1) \leq_T \mathbf{pLc}_J(I_0 \cap I_1) \leq_T \mathbf{Lc}_J(I_e) \otimes \mathbf{pLc}_J(I_{1-e})$, likewise for \mathbf{L} and \mathbf{pL} replacing \mathbf{Lc} and \mathbf{pLc} , respectively. In particular,

$$\begin{aligned} \text{(b1)} \quad \max\{\mathfrak{sl}_t(I_0, J), \mathfrak{sl}_t(I_1, J)\} &= \mathfrak{sl}_t(I_0 \oplus I_1, J) = \mathfrak{sl}_t(I_0 \cap I_1, J); \\ \text{(b2)} \quad \max\{\mathfrak{sl}_e(I_0, J), \mathfrak{sl}_e(I_1, J)\} &\leq \mathfrak{sl}_e(I_0 \oplus I_1, J) \leq \mathfrak{sl}_e(I_0 \cap I_1, J) \leq \min\{\max\{\mathfrak{sl}_t(I_0, J), \mathfrak{sl}_t(I_1, J)\}, \\ &\quad \max\{\mathfrak{sl}_e(I_0, J), \mathfrak{sl}_e(I_1, J)\}\}; \\ \text{(b3)} \quad \max\{\mathfrak{l}_K(I_0, J), \mathfrak{l}_K(I_1, J)\} &= \mathfrak{l}_K(I_0 \oplus I_1, J) = \mathfrak{l}_K(I_0 \cap I_1, J); \\ \text{(b4)} \quad \max\{\mathfrak{p}_K(I_0, J), \mathfrak{p}_K(I_1, J)\} &\leq \mathfrak{p}_K(I_0 \oplus I_1, J) \leq \mathfrak{p}_K(I_0 \cap I_1, J) \leq \min\{\max\{\mathfrak{l}_K(I_0, J), \mathfrak{p}_K(I_1, J)\}, \\ &\quad \max\{\mathfrak{p}_K(I_0, J), \mathfrak{l}_K(I_1, J)\}\}. \end{aligned}$$

(c) $\mathfrak{sl}_e(I_0 \oplus I_1, \text{Fin}) = \mathfrak{sl}_e(I_0 \cap I_1, \text{Fin}) = \max\{\mathfrak{sl}_e(I_0, \text{Fin}), \mathfrak{sl}_e(I_1, \text{Fin})\} = \min\{\mathfrak{b}, \max\{\text{cov}^*(I_0), \text{cov}^*(I_1)\}\}$.

(d) $\text{cov}^*(I_0 \oplus I_1) = \text{cov}^*(I_0 \cap I_1) = \max\{\text{cov}^*(I_0), \text{cov}^*(I_1)\}$.

Proof. (a) and (b) follow by Lemma 4.4 and Lemma 3.19 (a)–(b) since, by Lemma 5.2 we have $I \oplus \mathcal{P}(\omega) \approx_K I \oplus I \approx_K I$ and $I_0 \cap I_1 \leq_K I_0 \oplus I_1 \leq_K I_0, I_1$.

(c): Immediate by (b2), Lemma 3.19 (c), and Theorem 4.8 (a).

(d): Immediate by (b4) and Lemma 3.19 (c). \square

Theorem 5.8. *Let I, I_0, J_0 , and J_1 be ideals on ω . Then*

(a) $\mathbf{Lc}_{J \oplus \mathcal{P}(\omega)}(I) \cong_T \mathbf{Lc}_{J \oplus J}(I) \cong_T \mathbf{Lc}_J(I)$, similarly for \mathbf{pLc} , \mathbf{L} and \mathbf{pL} . In particular,

$$\begin{aligned} \mathfrak{sl}_t(I, J \oplus \mathcal{P}(\omega)) &= \mathfrak{sl}_t(I, J \oplus J) = \mathfrak{sl}_t(I, J), & \mathfrak{sl}_e(I, J \oplus \mathcal{P}(\omega)) &= \mathfrak{sl}_e(I, J \oplus J) = \mathfrak{sl}_e(I, J), \\ \mathfrak{l}_K(I, J \oplus \mathcal{P}(\omega)) &= \mathfrak{l}_K(I, J \oplus J) = \mathfrak{l}_K(I, J), & \mathfrak{p}_K(I, J \oplus \mathcal{P}(\omega)) &= \mathfrak{p}_K(I, J \oplus J) = \mathfrak{p}_K(I, J). \end{aligned}$$

(b) $\mathbf{Lc}_{J_e}(I) \leq_{\mathbf{T}} \mathbf{Lc}_{J_0 \cap J_1}(I) \leq_{\mathbf{T}} \mathbf{Lc}_{J_0 \oplus J_1}(I) \cong_{\mathbf{T}} \mathbf{Lc}_{J_0}(I) \otimes \mathbf{Lc}_{J_1}(I)$ for $e \in \{0, 1\}$, likewise for \mathbf{L} . In particular,

$$\begin{aligned} \mathfrak{sl}_t(I, J_0 \cap J_1) &= \mathfrak{sl}_t(I, J_0 \oplus J_1) = \max\{\mathfrak{sl}_t(I, J_0), \mathfrak{sl}_t(I, J_1)\}, \\ \mathfrak{l}_K(I, J_0 \cap J_1) &= \mathfrak{l}_K(I, J_0 \oplus J_1) = \max\{\mathfrak{l}_K(I, J_0), \mathfrak{l}_K(I, J_1)\}. \end{aligned}$$

(c) $\mathbf{aLc}_{J_0 \cap J_1}(I) \leq_{\mathbf{T}} \mathbf{aLc}_{J_0 \oplus J_1}(I) \cong_{\mathbf{T}} \mathbf{aLc}_{J_0}(I) \boxtimes \mathbf{aLc}_{J_1}(I)$, likewise for \mathbf{pL} . In particular,

$$\begin{aligned} \mathfrak{sl}_e(I, J_0 \cap J_1) &\leq \mathfrak{sl}_e(I, J_0 \oplus J_1) = \min\{\mathfrak{sl}_e(I, J_0), \mathfrak{sl}_e(I, J_1)\}, \\ \mathfrak{p}_K(I, J_0 \cap J_1) &\leq \mathfrak{p}_K(I, J_0 \oplus J_1) = \min\{\mathfrak{p}_K(I, J_0), \mathfrak{p}_K(I, J_1)\}. \end{aligned}$$

(d) $\mathfrak{sl}_t(\star, J_0 \oplus J_1) = \max\{\mathfrak{sl}_t(\star, J_0), \mathfrak{sl}_t(\star, J_1)\}$ and $\mathfrak{sl}_e(\star, J_0 \oplus J_1) = \min\{\mathfrak{sl}_e(\star, J_0), \mathfrak{sl}_e(\star, J_1)\}$.

(e) $\mathfrak{p}_K(\star, J_0 \oplus J_1) = \min\{\mathfrak{p}_K(\star, J_0), \mathfrak{p}_K(\star, J_1)\}$ and $\mathfrak{l}_K(\star, J_0 \oplus J_1) = \max\{\mathfrak{l}_K(\star, J_0), \mathfrak{l}_K(\star, J_1)\}$.

(f) $\mathfrak{sl}_t(\star, J_0 \cap J_1) = \max\{\mathfrak{sl}_t(\star, J_0), \mathfrak{sl}_t(\star, J_1)\}$ and $\mathfrak{l}_K(\star, J_0 \cap J_1) = \max\{\mathfrak{l}_K(\star, J_0), \mathfrak{l}_K(\star, J_1)\}$.

Proof. (a): It follows by [Theorem 4.14](#) because, by [Lemma 5.2](#), we have $J \oplus \mathcal{P}(\omega) \approx_{\mathbf{RB}} J \oplus J \approx_{\mathbf{RB}} J$.

(b): The Tukey equivalence follows by [Lemma 5.3](#) because ${}^\omega I \oplus {}^\omega I = {}^{\omega \oplus \omega} I$ and $\text{ct}(I) \oplus \text{ct}(I)$ is the set of constant functions from $\omega \oplus \omega$ into I ; and $\leq_{\mathbf{T}}$ follows by [Lemma 4.12](#) because $J_0 \oplus J_1 \leq_{\mathbf{KB}} J_0 \cap J_1 \subseteq J_e$ by [Lemma 5.2](#).

(c): The Tukey equivalence follows by [Lemma 5.3](#) and $\leq_{\mathbf{T}}$ follows by [Lemma 4.12](#) because $J_0 \cap J_1 \leq_{\mathbf{RB}} J_0 \oplus J_1$.

(d) By [Theorem 4.7](#), $\mathfrak{sl}_e(\star, J_0 \oplus J_1) = \min\{\mathfrak{sl}_e(\star, J_0), \mathfrak{sl}_e(\star, J_1)\}$ is immediate from (c), and

$$\mathfrak{sl}_t(\star, J_0 \oplus J_1) = \min_I \mathfrak{sl}_t(I, J_0 \oplus J_1) = \min_I \max\{\mathfrak{sl}_t(I, J_0), \mathfrak{sl}_t(I, J_1)\} \geq \max\{\mathfrak{sl}_t(\star, J_0), \mathfrak{sl}_t(\star, J_1)\}$$

follows by (b). On the other hand, by also using [Lemma 5.3](#),

$$\begin{aligned} \max\{\mathfrak{sl}_t(\star, J_0), \mathfrak{sl}_t(\star, J_1)\} &= \max \left\{ \min_{I_0} \mathfrak{sl}_t(I_0, J_0), \min_{I_1} \mathfrak{sl}_t(I_1, J_1) \right\} = \min_{I_0, I_1} \max\{\mathfrak{sl}_t(I_0, J_0), \mathfrak{sl}_t(I_1, J_1)\} \\ &= \min_{I_0, I_1} \mathfrak{sl}_t({}^\omega I_0 \oplus {}^\omega I_1, J_0 \oplus J_1) \geq \min_{\bar{I}} \mathfrak{sl}_t(\bar{I}, J_0 \oplus J_1) = \mathfrak{sl}_t(\star, J_0 \oplus J_1), \end{aligned}$$

which concludes the proof.

(e): The equation for $\mathfrak{p}_K(\star, J_0 \oplus J_1)$ is immediate from (c) and [Lemma 3.2](#). For $\mathfrak{l}_K(\star, J_0 \oplus J_1)$, and in the proof above for $\mathfrak{sl}_t(\star, J_0 \oplus J_1)$ we can show that $\mathfrak{l}_K(\star, J_0 \oplus J_1) \geq \max\{\mathfrak{l}_K(\star, J_0), \mathfrak{l}_K(\star, J_1)\}$. For the converse, by [Lemma 3.2](#), there are two ideals I_0 and I_1 on ω such that $\mathfrak{l}_K(\star, J_e) = \mathfrak{l}_K(I_e, J_e)$ for $e \in \{0, 1\}$. As in the proof of [Theorem 4.6](#), find an ideal I on ω such that $I_e \leq_{\mathbf{K}} I$ for $e \in \{0, 1\}$. Hence, by [Lemma 4.4 \(b\)](#),

$$\max_{e \in \{0, 1\}} \mathfrak{l}_K(\star, J_e) = \max_{e \in \{0, 1\}} \mathfrak{l}_K(I_e, J_e) \geq \max_{e \in \{0, 1\}} \mathfrak{l}_K(I, J_e) = \mathfrak{l}_K(I, J_0 \oplus J_1) \geq \mathfrak{l}_K(\star, J_0 \oplus J_1),$$

where the last equality holds by (b).

(f): The proof is similar to (d) and (e) using (b) (for $J_0 \cap J_1$). □

A direct application of (b) to $I = \text{Fin}$ (while using $\mathfrak{b}_J = \mathfrak{sl}_t^\perp(\text{Fin}, J)$) yields:

Corollary 5.9. *Let J, J_0 , and J_1 be ideals on ω . Then*

$$(a) \ \mathfrak{b} \leq \mathfrak{b}_{J \oplus \mathcal{P}(\omega)} = \mathfrak{b}_{J \oplus J} = \mathfrak{b}_J \leq \mathfrak{d}_{J \oplus \mathcal{P}(\omega)} = \mathfrak{d}_{J \oplus J} = \mathfrak{d}_J \leq \mathfrak{d}.$$

$$(b) \ \mathfrak{b}_{J_0 \cap J_1} = \mathfrak{b}_{J_0 \oplus J_1} = \min\{\mathfrak{b}_{J_0}, \mathfrak{b}_{J_1}\} \text{ and } \mathfrak{d}_{J_0 \cap J_1} = \mathfrak{d}_{J_0 \oplus J_1} = \max\{\mathfrak{d}_{J_0}, \mathfrak{d}_{J_1}\}. \quad \square$$

Thanks to [Theorem 5.8](#), we can characterize the ideals J on ω for which $\mathfrak{l}_K(\star, J)$ is well defined.

Theorem 5.10. *Let J be an ideal on ω . Then, the following statements are equivalent.*

- (i) $\mathfrak{l}_K(\star, J)$ is well-defined.
- (ii) ω cannot be partitioned into infinitely many J -positive sets.
- (iii) J is the disjoint sum of finitely many maximal ideals on ω .

Proof. (i) \Rightarrow (ii) follows by [Lemma 4.10](#). Now assume (ii). This means that the poset $\mathbb{P} := \mathcal{P}(\omega) \setminus J$, ordered by \subseteq , does not contain maximal antichains, i.e., it is ω -cc. This implies that the set of atoms of this poset is dense. Hence, it contains a maximal antichain formed by atoms, which should be finite by the ω -cc property. This implies that we can partition ω into finitely many atoms $\{a_k : k < n\}$ in \mathbb{P} , i.e., $a_k \in J^+$ and $J_k := \mathcal{P}(a_k) \cap J$ is a maximal ideal on a_k for all $k < n$. Hence, J is the disjoint sum of $\{J_k : k < n\}$. This shows (ii) \Rightarrow (iii).

Now assume (iii). By [Theorem 5.8 \(b\)](#) and [Lemma 4.2](#), it is enough to show that, whenever $\{J_k : k < n\}$ is a finite set of maximal ideals on ω , there is some maximal ideal I on ω such that $I \not\ll_K J_k$ for all $k < n$. This is clear because there are at most \mathfrak{c} many maximal ideals Katětov-below one ideal, but there are a total of $2^{\mathfrak{c}}$ many maximal ideals on ω . This shows (iii) \Rightarrow (i). \square

As a consequence of [Theorem 5.8 \(e\)](#), it is enough to study $\mathfrak{l}_K(\star, J_*)$ for all maximal ideals J_* on ω to understand $\mathfrak{l}_K(\star, J)$ for any ideal J on ω .

By counting maximal ideals as in the proof of (iii) \Rightarrow (i), $\mathfrak{p}_K(\star, J_*)$ is well-defined for any maximal ideal J_* and hence, by [Lemma 3.7](#), $\mathfrak{p}_D(\star, J)$ is well-defined for any $D \subseteq {}^\omega\omega$ and any ideal J on ω .

6. Selection principles

The current section is devoted to the study of selection principles and their connection to slalom numbers. First, we develop a framework where our generalized slalom number is the uniformity number of a topological property. Afterward, we show that topological spaces possessing most of the studied selection principles are singular.²⁰ Throughout the section, we assume that all topological spaces are Hausdorff. The letter X is reserved to denote a (Hausdorff) topological space.

Definition 6.1. Fix a Hausdorff space X , a non-empty set a , and $H \subseteq \mathcal{P}(a)$. A sequence $\langle V_m : m \in a \rangle$ of subsets of X is *non-trivial (in X)* if $V_m \neq X$ for all $m \in a$. Otherwise, we say that it is trivial. We use this terminology in connection with (open) covers of X . Trivial sequences cover X , so we usually refer to them as *trivial covers*.

We say that $\langle V_m : m \in a \rangle$ is an *H - γ -cover of X* if it is a sequence in X such that $\{m \in a : x \notin V_m\} \in H$ for each $x \in X$. We sometimes distinguish between trivial and non-trivial H - γ -covers in the sense of the previous paragraph. The family of all open H - γ -covers of a topological space X is denoted by $H\text{-}\Gamma(X)$, or shortly $H\text{-}\Gamma$.

Remark 6.2. When $a \notin H$, it is clear that any H - γ -cover of X actually covers X . However, when $a \in H$, there may be H - γ -covers that are not necessarily covers of X , e.g., when $H = \mathcal{P}(a)$, any sequence of subsets of X indexed by a is an H - γ -cover. We allow this pathology for practicality as in [Lemma 6.7](#), but in practice $a \notin H$ (and also $\emptyset \in H$ and H is \subseteq -downwards closed), excluding pathological “covers”.

We shall concentrate on the following situation.

²⁰For the meaning of *singular* in this context, see [[Kur66](#), §40], [[Mil84](#)], and [[Buk11](#), Ch. 8].

(H1) For a constant $q \in \omega$, H is the family of all finite subsets of ω with cardinality at most q , i.e., $H = [\omega]^{\leq q}$. The family $[\omega]^{\leq q}\text{-}\Gamma$, denoted by Γ^q shortly, is then the family of all (countable) open γ_q -covers of X , studied in [Sot20], i.e., a sequence $\langle U_m : m \in \omega \rangle$ is called a γ_q -cover of X if it is a cover of X satisfying $|\{m \in \omega : x \notin U_m\}| \leq q$ for each $x \in X$.

Furthermore, let us emphasize that no monotone increasing cover $\langle U_m : m < \omega \rangle$ can be a non-trivial γ_q -cover, otherwise, it will be a trivial γ_q -cover where $U_m = X$ for all $m \geq q$.

(H2) We expand (H1) as follows. For a constant $q \in \omega$ and a set a (maybe finite), H is the family of all finite subsets of a with cardinality at most q , i.e., $H = [a]^{\leq q}$. The family $[a]^{\leq q}\text{-}\Gamma$, denoted shortly $\Gamma^{a,q}$, is then the family of all open $\gamma_{a,q}$ -covers of X , where a sequence $\langle U_m : m \in a \rangle$ is called a $\gamma_{a,q}$ -cover of X if $|\{m \in a : x \notin U_m\}| \leq q$ for each $x \in X$.

When $1 \leq q < |a|$, a non-trivial open $\gamma_{a,q}$ -cover exists iff $q|X| \geq |a|$. Indeed, if $|a| \leq q|X|$, there is some injection $f: a \rightarrow q \times X$, so $\langle U_m : m \in a \rangle$ is an open $\gamma_{a,q}$ -cover where $U_m := X \setminus \{f_1(m)\}$ and $f(m) = (f_0(m), f_1(m))$. For the converse, if $\langle V_m : m \in a \rangle$ is a non-trivial open $\gamma_{a,q}$ -cover then, for any map $g: a \rightarrow X$ such that $g(m) \notin V_m$, $|g^{-1}[\{x\}]| \leq q$ for all $x \in X$, so $|a| = |\bigcup_{x \in X} g^{-1}[\{x\}]| \leq |X|q$.

When $|a| \leq q$, $a \in [a]^{\leq q}$, so any sequence $\langle V_m : m \in a \rangle$ is a $\gamma_{a,q}$ -cover. On the other hand, the only $\gamma_{a,0}$ -cover is the trivial cover composed by X alone.

Clearly, $q \leq q' < \omega$ implies $\Gamma^{a,q} \subseteq \Gamma^{a,q'}$.

(H3) H is the family of all finite subsets of ω , i.e., $H = \text{Fin} = [\omega]^{< \omega}$. The family $\text{Fin-}\Gamma$, denoted shortly Γ , is then the family of all (countable) open γ -covers of X .

(H4) H is an ideal I on ω , i.e., $H = I$. The family $I\text{-}\Gamma$ is then the family of all open I - γ -covers of X . As in (H2), there exists a non-trivial open I - γ -cover of X iff X is infinite.

(H5) H is the family $I^{\text{dc}} \subseteq \mathcal{P}(\omega)$ of sets not in the filter I^{d} when I is an ideal on ω . The family $H\text{-}\Gamma$, denoted by $I\text{-}\Lambda$, is then the family of all open I -large covers of X , see [DKC16]. When $|X| \geq 2$ and I is not a maximal ideal, there is a non-trivial open I -large cover of X .

(H6) H is the family $\mathcal{P}(\omega) \setminus \{\omega\}$. The family $H\text{-}\Gamma$, denoted by \mathcal{O} , is the family of all countable open covers of X , see [Sch96].

(H7) H is the family $\mathcal{P}(a) \setminus \{a\}$. Here $H\text{-}\Gamma$ is the family of all open covers of X indexed by a , which we denote by \mathcal{O}^a , or by just \mathcal{O} when clear from the context.

The notions above are usually defined in the literature for non-trivial covers, but we allow trivial covers in this paper for reasons we discuss later in Lemma 6.5, 6.6 and 6.10.

We also consider the notion of ω -cover: recall that a non-trivial sequence $\langle V_m : m \in a \rangle$ is an ω -cover of X if, for any finite $F \subseteq X$, $F \subseteq V_m$ for some $m \in a$. Note that a non-trivial sequence $\langle V_m : m \in a \rangle$ is an ω -cover if it is an I - γ -cover for some ideal $I \subseteq \mathcal{P}(a)$, which is equivalent to the fact that $\{m \in a : F \subseteq V_m\}$ is infinite for all finite $F \subseteq X$. We use this to extend the notion of ω -cover to trivial covers: regardless of whether $\langle V_m : m \in a \rangle$ is trivial, we say that it is an ω -cover if $\{m \in a : F \subseteq V_m\}$ is infinite for all finite $F \subseteq X$, which is equivalent to being an I - γ -cover for some ideal $I \subseteq \mathcal{P}(a)$.

Denote by Ω^a the collection of open ω -covers indexed by a , and $\Omega := \Omega^\omega$. Notice that there are no ω -covers indexed by a finite set and that finite spaces cannot have non-trivial ω -covers.

It is clear that $H \subseteq H'$ implies $H\text{-}\Gamma \subseteq H'\text{-}\Gamma$. In particular, when I is an ideal on ω ,

$$\Gamma^q \subseteq \Gamma \subseteq I\text{-}\Gamma \subseteq I\text{-}\Lambda \subseteq \mathcal{O} \text{ and } I\text{-}\Gamma \subseteq \Omega. \quad (6.2.1)$$

We shall also deal with sequences of covers.

Definition 6.3. Let us consider a set $E \subseteq \prod_{i < \omega} \mathcal{P}(b(i))$ for a sequence $b = \langle b(n) : n \in \omega \rangle$ of non-empty sets. The family $E\text{-}\Gamma(X)$, or shortly $E\text{-}\Gamma$, is the family of sequences $\langle \langle V_{n,m} : m \in b(n) \rangle : n \in \omega \rangle$ such that

each $V_{n,m}$ is open in X and $\langle\langle m \in b(n) : x \notin V_{n,m} \rangle\rangle : n \in \omega \in E$ for each $x \in X$. In particular, when E is the product $\prod_{n \in \omega} H_n$, we denote

$$E\text{-}\Gamma = \prod_{n \in \omega} (H_n\text{-}\Gamma).$$

We shall concentrate on the following situation.

- (P1) E is the family ${}^\omega H$ for some $H \subseteq \mathcal{P}(a)$ as in [Definition 6.1](#) (so $b(n) = a$ for all n). In such a case, we keep the notation $H\text{-}\Gamma$ instead of using $({}^\omega H)\text{-}\Gamma$. When $H = \mathcal{P}(a) \setminus \{a\}$, we just use \mathcal{O}^a , or \mathcal{O} ; when $a = \omega$ and $H = \text{Fin}$, we just use Γ .
- (P2) E is the family $\text{ct}(H)$ of constant sequences in ${}^\omega H$, where H is as before. Notice that $\langle\langle V_{n,m} : m \in a \rangle\rangle : n \in \omega \in \text{ct}(H)\text{-}\Gamma$ iff for $m \in a$ and $n, n' < \omega$, $V_{n,m} = V_{n',m}$ (is open in X), i.e., a sequence is in $\text{ct}(H)\text{-}\Gamma$ iff it is the constant sequence of an open H - γ -cover of X .
- (P3) E is the family $\mathcal{S}(b, h)$ for $h \in {}^\omega \omega$. The family $\mathcal{S}(b, h)\text{-}\Gamma$ will be denoted by $\Gamma_{b,h}$, shortly.
- (P4) E is the family $\mathcal{S}(\omega, h)$. The family $\mathcal{S}(\omega, h)\text{-}\Gamma$ is denoted by Γ_h in [[Šot20](#)].

In particular, we have $\Gamma_h \subseteq {}^\omega \text{Fin}\text{-}\Gamma \subseteq {}^\omega I\text{-}\Gamma \subseteq {}^\omega (I\text{-}\Lambda)$.

In the more general framework of [Section 3](#), the invariant $\mathfrak{d}_A(D, \mathcal{P})$ is defined for \mathcal{P} being a property of families of functions with domain ω , or equivalently, a collection of families of functions with domain ω . As in the previous notion, we use \mathcal{P} to define a collection of sequences as follows.

Definition 6.4. In the following, we are given a sequence $b = \langle b(n) : n \in \omega \rangle$ of non-empty sets and $\mathcal{P} \subseteq \mathcal{P}(\prod_{i < \omega} \mathcal{P}(b(i)))$. We shall introduce the family $\mathcal{P}\text{-}\Gamma$ for sequences of sequences of open sets associated with \mathcal{P} as well. Indeed, $\mathcal{P}\text{-}\Gamma(X)$, or shortly $\mathcal{P}\text{-}\Gamma$, is the family of $\langle\langle V_{n,m} : m \in b(n) \rangle\rangle : n \in \omega$ such that each $V_{n,m}$ is open in X and

$$\{\langle\langle m \in b(n) : x \notin V_{n,m} \rangle\rangle : n \in \omega : x \in X\} \in \mathcal{P} \text{ (has property } \mathcal{P}\text{)}.$$

We shall concentrate on the following situation.

- (P5) \mathcal{P} is the family $\mathcal{P}(E)$ with E being a set containing functions with domain ω . Here, $\mathcal{P}\text{-}\Gamma$ is $E\text{-}\Gamma$, in accordance with the previously adopted notation.
- (P6) \mathcal{P} is the family of all collections of functions in $\prod b$ with the coordinate-wise finite union property (i.e., property \star from [Definition 3.1](#)), which we also abbreviate by *FUPC*. The family $\mathcal{P}\text{-}\Gamma$ corresponds to the family of all sequences of ω -covers. Hence $\mathcal{P}\text{-}\Gamma = \prod_{n < \omega} \Omega^{b(n)}$, so we shall keep the notation Ω for sequences of ω -covers as well.
- (P7) \mathcal{P} is property \mathcal{P}_{ct} (see [Definition 3.1](#)). Then, $\mathcal{P}_{\text{ct}}\text{-}\Gamma$ is the collection of constant sequences of ω -covers. For $D \subseteq \prod b$ and $R \subseteq \mathcal{P}(\omega)$, we say that a Hausdorff topological space X is an $S_1^D(\mathcal{P}\text{-}\Gamma, R\text{-}\Gamma)$ -space if, for each $\langle\langle V_{n,m} : m \in b(n) \rangle\rangle : n \in \omega \in \mathcal{P}\text{-}\Gamma$, there is a $d \in D$ such that $\langle V_{n,d(n)} : n \in \omega \rangle$ is an R - γ -cover of X (which could be trivial). We focus on the following situation:

- (S1) For the family D :
 - (a) If $D = \prod b$ then we just write b in the notation, i.e., $S_1^b(\mathcal{P}\text{-}\Gamma, R\text{-}\Gamma)$.
 - (b) If b is the constant sequence of a set a , then we just keep a , i.e., $S_1^a(\mathcal{P}\text{-}\Gamma, R\text{-}\Gamma)$.
 - (c) If $D = {}^\omega \omega$ (a is ω in previous item), then we write $S_1(\mathcal{P}\text{-}\Gamma, R\text{-}\Gamma)$.
- (S2) For the family R :
 - (a) If $R = J$ then we write $S_1^D(\mathcal{P}\text{-}\Gamma, J\text{-}\Gamma)$.
 - (b) If $R = J^{\text{dc}}$ then we write $S_1^D(\mathcal{P}\text{-}\Gamma, J\text{-}\Lambda)$.

(S3) For the family \mathcal{P} :

- (a) If $\mathcal{P} = \mathcal{P}(\prod \bar{H}) = \mathcal{P}(\prod_{n < \omega} H_n)$ when $\bar{H} = \langle H_n : n < \omega \rangle$ is a sequence of families $H_n \subseteq \mathcal{P}(b(n))$, then we use $S_1^D(\bar{H}-\Gamma, R-\Gamma)$.
- (b) If $H \subseteq \mathcal{P}(a)$ (here $b(n) = a$ for all n) and $\mathcal{P} = \mathcal{P}({}^\omega H)$ then we use $S_1^D(H-\Gamma, R-\Gamma)$.
- (c) If $\mathcal{P} = \mathcal{P}(\text{ct}(H))$ for some $H \subseteq \mathcal{P}(a)$ then we use $S_1^D(\text{ct}(H)-\Gamma, R-\Gamma)$ or $[H-\Gamma, R-\Gamma]_D$, the latter as in [ŠŠ19, Š23, BŠZ23]. Here, $D \subseteq {}^\omega a$. Notice that X is an $[H-\Gamma, R-\Gamma]_D$ -space iff, for any open H - γ -cover $\langle V_m : m \in a \rangle$, there is some $d \in D$ such that $\langle V_{d(n)} : n < \omega \rangle$ is an R - γ -cover. In the cited literature all covers are non-trivial, but equivalence with our proposed version holds in the interesting cases, see Lemma 6.10.
- (d) If \mathcal{P} is property \star , then we use $S_1^D(\Omega, R-\Gamma)$.
- (e) If \mathcal{P} is property \mathcal{P}_{ct} , we also use $[\Omega, R-\Gamma]_D$. Notice that X is an $[\Omega, R-\Gamma]_D$ -space if, for any open ω -cover $\langle V_m : m < \omega \rangle$ (possibly trivial), there is some $d \in D$ such that $\langle V_{d(n)} : n < \omega \rangle$ is an R - γ -cover (possibly trivial), see [Š23, BŠZ23]. Traditionally, trivial covers are excluded, but we have equivalence with our proposed version in the interesting cases, see Lemma 6.10.
- (f) If $\mathcal{P} = \mathcal{P}(\mathcal{S}(\omega, h))$ then we use $S_1^D(\Gamma_h, R-\Gamma)$. Accordingly, we use $S_1^D(\Gamma_q, R-\Gamma)$ for the family $\mathcal{S}(\omega, q)$, where q is the function with constant value equal to $q \in \omega$.
- (g) If $\mathcal{P} = \mathcal{P}(\mathcal{S}(b, h))$ then we use $S_1^D(\Gamma_{b,h}, R-\Gamma)$.

We can define $S_1^D(\mathcal{P}-\Gamma, \Omega)$ similarly.

Define the cardinal number $\text{non}(S_1^D(\mathcal{P}-\Gamma, R-\Gamma))$ as the smallest size of a Hausdorff space that is not an $S_1^D(\mathcal{P}-\Gamma, R-\Gamma)$ -space, which is known as the *uniformity* or *critical cardinality* of $S_1^D(\mathcal{P}-\Gamma, R-\Gamma)$ -spaces. We define $\text{non}(S_1^D(\mathcal{P}-\Gamma, \Omega))$ similarly.

We say that X is a *traditional* $S_1^D(\mathcal{P}-\Gamma, R-\Gamma)$ -space if it satisfies the principle $S_1^D(\mathcal{P}-\Gamma, R-\Gamma)$ but forbidding trivial covers.

Unless otherwise indicated, for the rest of this section, a is a non-empty set and b, \mathcal{P}, D , and R are as in Definition 6.4.

The reason we allow trivial coverings in Definition 6.3 is that this does not affect the well-known instances of the traditional principle $S_1^D(\mathcal{P}-\Gamma, R-\Gamma)$, i.e., forbidding trivial covers (as it has been traditionally studied). We justify this with a series of results.

Lemma 6.5. *If a Hausdorff space X is an $S_1^D(\mathcal{P}-\Gamma, R-\Gamma)$ -space then it is a traditional $S_1^D(\mathcal{P}-\Gamma, R-\Gamma)$ -space. \square*

The converse holds in certain situations.

Lemma 6.6. *The converse of Lemma 6.5 holds when $D = \prod b$, R is downwards \subseteq -closed, \mathcal{P} is as in (P5) with $E = \prod_{n < \omega} H_n$ for some $H_n \subseteq \mathcal{P}(b(n))$ and, for any $n < \omega$, X has a non-trivial H_n - γ -cover. The latter requirement holds when X is infinite and $[b(n)]^{\leq 1} \subseteq H_n$ for all $n < \omega$.*

The above is also valid when considering $\Omega^{b(n)}$ in the place of H_n - γ -covers for some desired $n < \omega$, and also Ω in the place of $R-\Gamma$. In particular, \mathcal{P} can be as in (P6).

Proof. Assume that, for $n < \omega$, $\langle V_{n,m} : m \in b(n) \rangle$ is an H_n - γ cover. Let $a := \{n < \omega : \forall m \in b(n) (V_{n,m} \neq X)\}$. For $n \in \omega \setminus a$, choose some non-trivial H_n - γ -cover $\langle V'_{n,m} : m \in b(n) \rangle$ of X ; for $n \in a$ and $m \in b(n)$ let $V'_{n,n} := V_{n,m}$, so we can apply the traditional $S_1^D(E-\Gamma, R-\Gamma)$ (for non-trivial covers) to get some $d' \in \prod b$ such that $\langle V'_{n,d'(n)} : n < \omega \rangle$ is an R - γ -cover. Define $d \in \prod b$ by $d(n) := d'(n)$ when $n \in a$, otherwise choose $d(n) \in b(n)$ such that $V_{n,d(n)} = X$. Then, for $x \in X$, $\{n < \omega : x \notin V_{n,d(n)}\} = \{n \in a : x \notin V_{n,d(n)}\} \subseteq \{n < \omega : x \notin V'_{n,d(n)}\} \in R$, so $\{n < \omega : x \notin V_{n,d(n)}\} \in R$. \square

We analyze the situation when X may not have a non-trivial H_n - γ -cover for some $n < \omega$ as follows.

Lemma 6.7. *Let D, R, \mathcal{P}, E and $\langle H_n : n < \omega \rangle$ be as in Lemma 6.6. Let X be a Hausdorff space and let w be the set of all $n < \omega$ such that X has a non-trivial H_n - γ -cover, and assume that $\emptyset \in R$. Then:*

- (a) *If $w \neq \omega$ then X is (vacuously) a traditional $S_1^b(E-\Gamma, R-\Gamma)$ -space.*
- (b) *X is an $S_1^b(E-\Gamma, R-\Gamma)$ -space iff it is an $S_1^{b \uparrow w}(E \uparrow w-\Gamma, \mathcal{P}(w) \cap R-\Gamma)$ -space²¹, which is in turn equivalent to being a traditional $S_1^{b \uparrow w}(E \uparrow w-\Gamma, \mathcal{P}(w) \cap R-\Gamma)$ -space. However, \Rightarrow needs $H_n \neq \emptyset$ for $n \in \omega \setminus w$.*
- (c) *If $w \in R$ then X is an $S_1^{b \uparrow w}(E \uparrow w-\Gamma, \mathcal{P}(w) \cap R-\Gamma)$ -space.*

The above is also valid when considering $\Omega^{b(n)}$ in the place of H_n - γ -covers for some desired $n < \omega$, as long as $b(n)$ is infinite.

Proof. (a): Since there is no sequence in $E-\Gamma$ of non-trivial sequences (i.e., any member of $E-\Gamma$ contains a trivial cover at any $n \in \omega \setminus w$), the traditional principle holds vacuously.

(b): By Lemma 6.6, X is an $S_1^{b \uparrow w}(E \uparrow w-\Gamma, \mathcal{P}(w) \cap R-\Gamma)$ -space iff it is a traditional $S_1^{b \uparrow w}(E \uparrow w-\Gamma, \mathcal{P}(w) \cap R-\Gamma)$ -space. On the other hand, if X is an $S_1^b(E-\Gamma, R-\Gamma)$ -space, then we can use a suitable trivial cover at any $n \in \omega \setminus w$ to check that X is an $S_1^{b \uparrow w}(E \uparrow w-\Gamma, \mathcal{P}(w) \cap R-\Gamma)$ -space. The converse is easy to check.

(c): Trivial because $w \in \mathcal{P}(w) \cap R = \mathcal{P}(w)$, so any sequence $\langle U_n : n \in w \rangle$ is a $\mathcal{P}(w)$ - γ -cover. □

Similar proofs yield the case when $R-\Gamma$ is replaced by Ω .

Lemma 6.8. *Under the same assumptions of Lemma 6.7 (excluding R):*

- (a) *If $w \neq \omega$ then X is (vacuously) a traditional $S_1^b(E-\gamma, \Omega)$ -space.*
- (b) *If $|\omega \setminus w| = \aleph_0$ then X is an $S_1^b(E-\gamma, \Omega)$ -space.*
- (c) *If X is an $S_1^{b \uparrow w}(E \uparrow w-\Gamma, \Omega^w)$ -space then it is an $S_1^b(E-\gamma, \Omega)$ -space.*
- (d) *The converse of (c) holds when $\omega \setminus w$ is finite and $H_n \neq \emptyset$ for $n \in \omega \setminus w$.*
- (e) *If w is finite then X is not an $S_1^{b \uparrow w}(E \uparrow w-\Gamma, \Omega^w)$ -space.*

The above is also valid when considering $\Omega^{b(n)}$ in the place of H_n - γ -covers for some desired $n < \omega$, as long as $b(n)$ is infinite.

Proof. (b): Any $d \in \prod b$ picking X from a trivial cover at each $n \in \omega \setminus w$ produces a trivial ω -cover.

(e): Clear because there are no ω -covers indexed by finite sets. □

The non-traditional selection principle has the following interesting effect on the slalom numbers.

Lemma 6.9. *If there is some $S_1^D(\mathcal{P}-\Gamma, R-\Gamma)$ -space X then $\mathfrak{d}_{R^c}(D, \mathcal{P}) > 1$. In addition, if either this X is finite, or $S \cup \{\overline{\emptyset}\} \in \mathcal{P}$ for any $S \in \mathcal{P}$ (where $\overline{\emptyset}$ is the infinite constant sequence formed by the empty set), then $\mathfrak{d}_{R^c}(D, \mathcal{P}) \geq \min\{\aleph_0, |X| + 1\}$.*

Proof. First assume that $S \cup \{\overline{\emptyset}\} \in \mathcal{P}$ for any $S \in \mathcal{P}$. To check $\mathfrak{d}_{R^c(D, \mathcal{P})} \geq \min\{\aleph_0, |X| + 1\}$, assume that $F \subseteq X$ is finite and $\{\varphi_x : x \in F\} \in \mathcal{P}$. For $n < \omega$ and $m \in b(n)$, define $V_{n,m} := X \setminus \{x \in F : m \in \varphi_x(n)\}$, which is clearly open in X (but $V_{n,m} = X$ when $m \notin \varphi_x(n)$ for all $x \in F$). For $n < \omega$ and $x \in X$, $\{m \in b(n) :$

²¹The version of $S_1^b(E-\Gamma, R-\Gamma)$ by indexing the sequences of covers with w instead of ω .

$x \notin V_{n,m}$ is $\varphi_x(n)$ when $x \in F$, and empty otherwise. Hence, $\langle \langle V_{n,m} : m \in b(n) \rangle : n < \omega \rangle$ satisfies \mathcal{P} (because $\{\varphi_x : x \in F\} \cup \{\emptyset\} \in \mathcal{P}$). Since X is an $S_1^D(\mathcal{P}\text{-}\Gamma, R\text{-}\Gamma)$ -space, there is some $d \in D$ such that $\{V_{n,d(n)} : n < \omega\}$ is an $R\text{-}\gamma$ -cover. Then, for $x \in F$, $\|d \in \varphi_x\| = \{n < \omega : x \notin V_{n,d(n)}\} \in R$, i.e., $d \notin^{R^c} \varphi_x$.

When X is finite and $0 < k \leq |X|$, we can partition X into closed sets $\langle C_i : i < k \rangle$. For $n < \omega$ and $m \in b(n)$ define $V_{n,m} := X \setminus \bigcup_{i < k} \{x \in C_i : m \in \varphi_i(n)\}$ and proceed like above. Since the previous partition is possible for $k = 1$, we can conclude $\mathfrak{d}_{R^c}(D, \mathcal{P}) > 1$ without the additional assumption. \square

It is also worth to compare the traditional versions of $[H\text{-}\Gamma, R\text{-}\Gamma]_D$ with the current one.

Lemma 6.10. *Let a be a non-empty set, $D \subseteq {}^\omega a$, $H \subseteq \mathcal{P}(a)$, $R \subseteq \mathcal{P}(\omega)$ downwards \subseteq -closed, and let X be a Hausdorff space. In each of the following cases, X is a traditional $[H\text{-}\Gamma, R\text{-}\Gamma]_D$ -space implies that it is an $[H\text{-}\Gamma, R\text{-}\Gamma]_D$ -space.*

- (1) $|X| \geq |a|$ and $z \cup c \in H$ for all $z \in H$ and $c \in [a]^{<\aleph_0}$. When $|X| < |a|$ and X is finite, the implication holds when $H = I$ or $H = I^{\text{dc}}$ for some ideal I on a , and $\mathfrak{p}_D(H, R) > 1$.²²
- (2) $H = \mathcal{P}(a) \setminus \{a\}$ and $\mathfrak{p}_D(H, R) > 1$. The latter is equivalent to $(\forall m \in a)(\exists d \in D) \|d \neq m\| \in R$.
- (3) In the case of $[\Omega^a, R\text{-}\Gamma]_D$, it requires that either a is finite or $\mathfrak{p}_D([a]^{<\aleph_0})^{\text{dc}}, R) > 1$.

The same holds for when replacing $R\text{-}\Gamma$ by Ω , and R by Fin in $\mathfrak{p}_D(\cdot, R)$.

Proof. To proceed with the proof of all the items, we fix an open $H\text{-}\gamma$ cover (or ω -cover) $\langle V_m : m \in a \rangle$, and let $w := \{m \in a : V_m \neq X\}$. When $w = a$ we can apply the traditional principle, so the problem is when $w \neq a$. In the case $w \in H$, it is enough to deal with the case when $V_m = \emptyset$ for all $m \in w$, in which we can appeal to $\mathfrak{p}_D(H, R) > 1$ for finding some $d \in D$ such that, for $x \in X$, $\{n < \omega : x \notin V_{n,d(n)}\} = \{n < \omega : d(n) \in w\} \in R$. We analyze each case below.

(1): When $|X| \geq |a|$, we can define an open $H\text{-}\gamma$ -cover $\{V'_m : m \in a\}$ such that $V'_m := V_m$ for $m \in w$, otherwise $V'_m := X \setminus \{x_m\}$, where $\{x_m : m \in a \setminus w\}$ is a chosen one-to-one sequence in X . Therefore, the traditional principle can be applied.

When X is finite and $H = I$ or $H = I^{\text{dc}}$, in the case $w \in H$ we appeal to $\mathfrak{p}_D(H, R) > 1$. So consider the case when $w \notin H$. If $H = I$ then X must be infinite, indicating that $w \in I$ when X is finite; if $H = I^{\text{dc}}$ then $w \in I^{\text{d}}$, so we can define an $I^{\text{dc}}\text{-}\gamma$ -cover $\langle V''_m : m \in a \rangle$ where $V''_m := V_m$ when $m \in w$, and $V''_m := \emptyset$ otherwise. Then, the traditional principle can be applied.

(2): If $w \neq a$ then already $w \in H = \mathcal{P}(a) \setminus a$, so we can appeal to $\mathfrak{p}_D(H, R) > 1$.

(3): If a is finite then there are no ω -covers, so both $[\Omega^a, R\text{-}\Gamma]_D$ and its traditional version hold vacuously. So assume that a is infinite. If $a \setminus w$ is finite then the sequence $\langle V''_m : m \in a \rangle$ defined in the proof of (1) is an ω -cover and the traditional principle can be applied. Otherwise $w \in ([a]^{<\aleph_0})^{\text{dc}}$, so we appeal to $\mathfrak{p}_D([a]^{<\aleph_0})^{\text{dc}}, R) > 1$.

The same arguments can be used when replacing $R\text{-}\Gamma$ by Ω . \square

The flexibility to allow trivial covers allows us to look at finite spaces X , which is reasonable in the context of this section because there will be cases when $\text{non}(S_1^D(\mathcal{P}\text{-}\Gamma, R\text{-}\Gamma))$ is finite.

The slalom numbers of the form $\mathfrak{d}_A(D, \mathcal{P})$ characterize $\text{non}(S_1^D(\mathcal{P}\text{-}\Gamma, R\text{-}\Gamma))$ as follows. This characterization is one of the main results in this section.

Theorem 6.11. *If \mathcal{P} is a family of sets of functions with domain ω and $A \subseteq \mathcal{P}(\omega)$, then*

$$\mathfrak{d}_A(D, \mathcal{P}) = \text{non}(S_1^D(\mathcal{P}\text{-}\Gamma, A^c\text{-}\Gamma)).$$

²²Note that $\mathfrak{d}_{R^c}(D, \text{ct}(H)) = \mathfrak{p}_D(H, R)$, always.

In particular, if E is a family of functions with domain ω then $\mathfrak{d}_A(D, E) = \text{non}(S_1^D(E-\Gamma, A^c-\Gamma))$.

This result is immediate from the following two lemmata.

Lemma 6.12. *Let \mathcal{P} be a family of families of functions with domain ω , and let X be a topological space. If $|X| < \mathfrak{d}_A(D, \mathcal{P})$ then X is an $S_1^D(\mathcal{P}-\Gamma, A^c-\Gamma)$ -space.*

Proof. Let $|X| < \mathfrak{d}_A(D, \mathcal{P})$ and $\mathcal{V} = \langle \langle V_{n,m} : m \in b(n) \rangle : n \in \omega \rangle \in \mathcal{P}-\Gamma$. For $x \in X$, we define the sequence $x_{\mathcal{V}}$ by $x_{\mathcal{V}}(n) = \{m \in b(n) : x \notin V_{n,m}\}$ (the set of exceptions of the n -th cover), and set $E_0 := \{x_{\mathcal{V}} : x \in X\}$. Then $E_0 \in \mathcal{P}$ since $\mathcal{V} \in \mathcal{P}-\Gamma$. By the assumption, there is a $d \in D$ such that, for all $x \in X$, $\|d \in x_{\mathcal{V}}\| \in A^c$. However, $\{n \in \omega : x \notin V_{n,d(n)}\} = \|d \in x_{\mathcal{V}}\|$, so $\langle V_{n,d(n)} : n \in \omega \rangle$ is an A^c - γ -cover. \square

In the next lemma, we shall assume that $E_0 \in \mathcal{P}$ is equipped with a topology such that $\{p \in E_0 : m \notin p(n)\}$ is open for each m, n . For instance, this is the case of the discrete topology on E_0 , or the topology on E_0 inherited from the Tychonoff product topology of $\prod_{n < \omega} \mathcal{P}(b(n))$ when $E_0 \subseteq \prod_{n < \omega} \mathcal{P}(b(n))$ and $\mathcal{P}(b(n))$ is considered with the product topology of ${}^b(n)2$ (with $2 = \{0, 1\}$ discrete). In the latter case, when each $b(n)$ is countable, E_0 is homeomorphic to a set of reals.

Lemma 6.13. *Let \mathcal{P} be a family of sets of functions with domain ω , $A \subseteq \mathcal{P}(\omega)$, and let $E_0 \in \mathcal{P}$. If E_0 is an $S_1^D(\mathcal{P}-\Gamma, A^c-\Gamma)$ -space then there is a $d \in D$ such that $d \notin^A p$ for each $p \in E_0$.*

Proof. We consider the sequence $\mathcal{V}_{E_0} = \langle \langle V_{n,m} : m \in b(n) \rangle : n \in \omega \rangle$ defined by $V_{n,m} := \{p \in E_0 : m \notin p(n)\}$. Note that $\langle \{m \in b(n) : p \notin V_{n,m}\} : n \in \omega \rangle = p$, hence, we have $\langle \langle V_{n,m} : m \in b(n) \rangle : n \in \omega \rangle \in \mathcal{P}-\Gamma$. Observe that, for any $d \in D$ and any $p \in E_0$, we have $\{n \in \omega : d(n) \in p(n)\} = \{n \in \omega : p \notin V_{n,d(n)}\}$. Hence, $d \notin^A p$ for all $p \in E_0$ if and only if $\langle V_{n,d(n)} : n \in \omega \rangle$ is an A^c - γ -cover of E_0 . \square

The case $A = \text{Fin}^d$ is quite special.

Lemma 6.14.

- (a) *If $H \subseteq \mathcal{P}(a)$ then the principles $S_1(H-\Gamma, \text{Fin}-\Lambda)$ and $S_1(H-\Gamma, \mathcal{O})$ are equivalent.*
- (b) *Assume $H_n \subseteq \mathcal{P}(b(n))$ and $\bigcup H_n = b(n)$ for $n < \omega$. If $D \subseteq \prod b$ and $\mathfrak{d}_{\text{Fin}^d}(D, \bar{H}) \geq \kappa := \sum_{n < \omega} |b(n)|$, then $\text{non}(S_1^D(\bar{H}-\Gamma, \text{Fin}-\Lambda)) = \text{non}(S_1^D(\bar{H}-\Gamma, \mathcal{O}))$.*

Proof. Any $S_1(\mathcal{P}-\Gamma, \text{Fin}-\Lambda)$ -space is $S_1(\mathcal{P}-\Gamma, \mathcal{O})$, hence $\text{non}(S_1(\mathcal{P}-\Gamma, \text{Fin}-\Lambda)) \leq \text{non}(S_1(\mathcal{P}-\Gamma, \mathcal{O}))$. We show the converse in the situation above.

(a): Assume that X is an $S_1(H-\Gamma, \mathcal{O})$ -space. For $n < \omega$, let $\mathcal{V}_n = \langle V_{n,m} : m \in a \rangle \in H-\Gamma$. Partition ω into infinite sets $\langle W_k : k < \omega \rangle$. By applying the principle $S_1(H-\Gamma, \mathcal{O})$ to $\langle \mathcal{V}_n : n \in W_k \rangle$, we can find some $d_k \in {}^{W_n}a$ such that $\langle V_{n,d_k(n)} : n \in W_k \rangle$ covers X . Set $d := \bigcup_{k < \omega} d_k$. Hence, $\langle V_{n,d(n)} : n < \omega \rangle \in \text{Fin}-\Lambda$.

(b): By [Theorem 6.11](#) it is enough to show that $\mathfrak{d}_{\text{Fin}^d}(D, \bar{H}) = \mathfrak{d}_{\{\omega\}}(D, \bar{H})$. The inequality \leq is clear; for the converse, notice that, for any $\mathbf{Lc}_{\text{Fin}^d}(D, \bar{H})$ -dominating $Y \subseteq \prod \bar{H}$, the set of finite modifications of members of Y within \bar{H} is $\langle D, \prod \bar{H}, \in^{\{\omega\}} \rangle$ -dominating (because $b(n) = \bigcup H_n$ for all $n < \omega$), thus $\mathfrak{d}_{\text{Fin}^d}(D, \bar{H}) \leq \mathfrak{d}_{\{\omega\}}(D, \bar{H}) \leq \max\{\kappa, \mathfrak{d}_{\text{Fin}^d}(D, \bar{H})\}$. But $\mathfrak{d}_{\text{Fin}^d}(D, \bar{H}) \geq \kappa$, so $\mathfrak{d}_{\{\omega\}}(D, \bar{H}) = \mathfrak{d}_{\text{Fin}^d}(D, \bar{H})$. \square

As a consequence of [Theorem 6.11](#), [6.14](#), and the results of [Section 4](#), we obtain:

Corollary 6.15. *Let I, J be ideals on ω and let $g, h \in {}^\omega\omega$ be such that $\lim_{n \in \omega} g(n) = \infty$ and $h \geq^* 1$.*

$$\begin{array}{ll}
\text{non}(S_1(\Gamma_h, \Gamma)) &= \text{non}(\mathcal{M}), & \text{non}(S_1(\Gamma_g, \text{Fin-}\Lambda)) &= \text{cof}(\mathcal{N}), \\
\text{non}(S_1(\Gamma_h, J\text{-}\Gamma)) &= \mathfrak{sl}_\epsilon(h, J), & \text{non}(S_1(\Gamma_h, J\text{-}\Lambda)) &= \mathfrak{sl}_t(h, J), \\
\text{non}(S_1(\Gamma_{b,h}, J\text{-}\Gamma)) &= \mathfrak{sl}_\epsilon(b, h, J), & \text{non}(S_1(\Gamma_{b,h}, J\text{-}\Lambda)) &= \mathfrak{sl}_t(b, h, J), \\
\text{non}(S_1(\Gamma, J\text{-}\Gamma)) &= \mathfrak{b}_J, & \text{non}(S_1(\Gamma, J\text{-}\Lambda)) &= \mathfrak{d}_J, \\
\text{non}(S_1(I\text{-}\Gamma, J\text{-}\Gamma)) &= \mathfrak{sl}_\epsilon(I, J), & \text{non}(S_1(I\text{-}\Gamma, J\text{-}\Lambda)) &= \mathfrak{sl}_t(I, J), \\
\text{non}(S_1(\Omega, J\text{-}\Gamma)) &= \mathfrak{sl}_\epsilon(\star, J), & \text{non}(S_1(\Omega, J\text{-}\Lambda)) &= \mathfrak{sl}_t(\star, J).
\end{array}$$

Even more, when $J = \text{Fin}$, $J\text{-}\Lambda$ can be replaced by \mathcal{O} in the right side column, as long as g and h are non-zero everywhere and $h(n) < |b(n)|$ for infinitely many $n < \omega$. \square

The equalities in the bottom three lines of [Corollary 6.15](#) have been proven in [[ŠŠ19](#), [Š23](#)]. The equalities for $\mathfrak{sl}_\epsilon(h, J)$ and $\mathfrak{sl}_t(h, J)$ were obtained in [[Šot20](#)]. We visualize [Corollary 6.15](#) in [Figure 9](#) and [10](#). In fact, the rows using a function h in the latter diagram were not considered in [[ŠŠ19](#), [Š23](#)] and are new to this work.

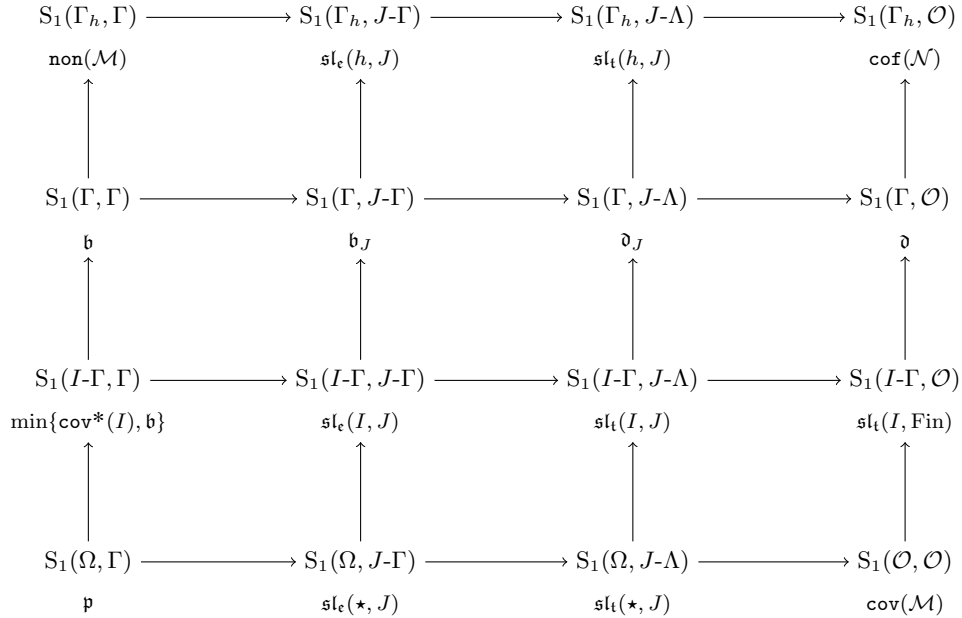

Figure 9: Critical cardinality of selection principles when $h \rightarrow \infty$. If $h \geq^* 1$ and $h \rightarrow \infty$, $\text{cof}(\mathcal{N})$ is replaced by \mathfrak{c} .

Recall from [[Sch96](#)] that $S_1(\Omega, \mathcal{O})$ and $S_1(\mathcal{O}, \mathcal{O})$ are equivalent principles.

Strict inequalities between two cardinal characteristics reflect the existence of spaces satisfying one selection principle but not the other.

Corollary 6.16. *If $\text{non}(S_1^{D'}(\mathcal{P}'\text{-}\Gamma, R'\text{-}\Gamma)) < \text{non}(S_1^D(\mathcal{P}\text{-}\Gamma, R\text{-}\Gamma))$ then there is an $S_1^D(\mathcal{P}\text{-}\Gamma, R\text{-}\Gamma)$ -space which is not an $S_1^{D'}(\mathcal{P}'\text{-}\Gamma, R'\text{-}\Gamma)$ -space. \square*

Another application of [Corollary 6.15](#) is the following consequence for cardinal invariants.

Corollary 6.17. *Let $h \geq^* 1$. Then, $\min\{\mathfrak{sl}_\epsilon(h, J), \text{cov}^*(J)\} \leq \text{non}(\mathcal{M})$.*

Proof. If a topological space X is both an $S_1(\Gamma_h, J\text{-}\Gamma)$ -space and a $[J\text{-}\Gamma, \Gamma]$ -space, then X is an $S_1(\Gamma_h, \Gamma)$ -space. This implies that the minimum of the critical cardinalities of $S_1(\Gamma_h, J\text{-}\Gamma)$ and $[J\text{-}\Gamma, \Gamma]$ is below

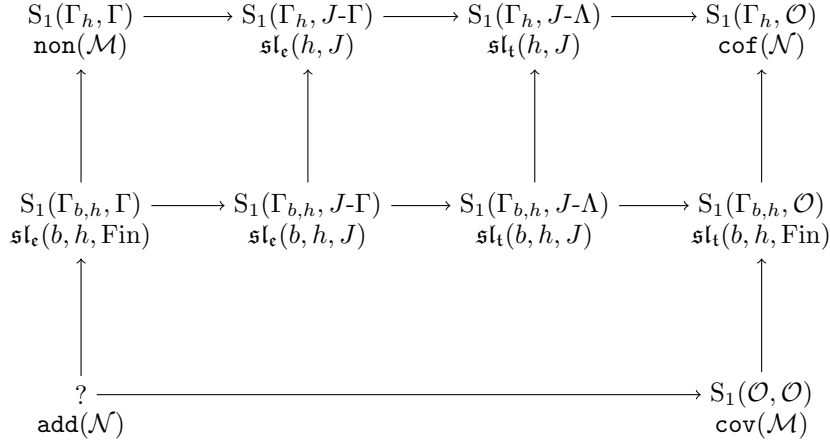

Figure 10: Selection principles for slaloms bounded by a function b . The question mark indicates that it is not known which selection principle has $\text{add}(\mathcal{N})$ as its critical cardinality. When $h \rightarrow \infty$, replace $\text{cof}(\mathcal{N})$ by \mathfrak{c} .

$\text{non}(S_1(\Gamma_h, \Gamma))$. On the other hand, by [Corollary 6.15](#) $\text{non}(S_1(\Gamma_h, J\text{-}\Gamma)) = \mathfrak{sl}_\epsilon(h, J)$, $\text{non}(S_1(\Gamma_h, \Gamma)) = \text{non}(\mathcal{M})$, and $\text{non}([J\text{-}\Gamma, \Gamma]) = \mathfrak{p}_K(J, \text{Fin}) = \text{cov}^*(J)$ (the latter was directly proved in [\[ŠŠ19\]](#)).

We also present a combinatorial proof. Since $\mathfrak{sl}_\epsilon(h, J) \leq \mathfrak{sl}_\epsilon(1, J)$, it is enough to work with $h = 1$. We use that $\text{non}(\mathcal{M})$ and $\text{cov}(\mathcal{M})$ are the \mathfrak{b} and \mathfrak{d} -numbers, respectively, of the relational system $\mathbf{Ed}^* := \langle {}^\omega\omega, [{}^\omega]^{<\omega} \times {}^\omega\omega, = \rangle$, where $x = (w, y)$ means that $x(i) \neq y(i)$ for all but finitely many $i \in w$ (see [\[BJ95\]](#) and [\[CM23, Thm. 5.3\]](#)). So let $F \subseteq {}^\omega\omega$ of size $< \min\{\mathfrak{sl}_\epsilon(1, J), \text{cov}^*(J)\}$. Then, we can find some $y \in {}^\omega\omega$ such that $a_x := \|x = y\| \in J$ for all $x \in F$. Since $|F| < \text{cov}^*(J)$, we can find some $w \in [{}^\omega]^{<\omega}$ such that $w \cap a_x$ is finite for all $x \in F$, which implies $x = (w, y)$.

The latter argument can be easily modified to show that $\text{cov}(\mathcal{M}) \leq \max\{\mathfrak{sl}_\epsilon^\perp(1, J), \text{non}^*(J)\}$. \square

The rest of this section is devoted to studying topological properties of $S_1^D(\mathcal{P}\text{-}\Gamma, R\text{-}\Gamma)$ -spaces, in particular, we show that in most cases these spaces are totally imperfect, i.e., they do not contain a subspace homeomorphic with the Cantor space. These results are generalizations of results obtained in [\[Šot20\]](#).

For $H \subseteq \mathcal{P}(a)$, we say that a sequence $\langle V_m : m \in a \rangle$ of sets is *H-wise disjoint* if $\bigcap_{m \in w} V_m = \emptyset$ for any $w \in \mathcal{P}(a) \setminus H$. In the case $H = [a]^{<q}$ for some $0 < q < \omega$, we say that an $[a]^{<q}$ -wise disjoint sequence is *q-wise disjoint*, i.e., $\bigcap_{m \in w} V_m = \emptyset$ for any $w \subseteq a$ of size q .

Proposition 6.18. *Let $H \subseteq \mathcal{P}(a)$ and let X be a topological space. A sequence $\langle U_m : m \in a \rangle$ of open subsets of X is an H - γ -cover of X if and only if $\{X \setminus U_m : m \in a\}$ is an H -wise disjoint sequence of closed subsets of X . In particular, for $q < \omega$, $\langle U_m : m \in a \rangle$ is a γ_q -cover if and only if $\{X \setminus U_m : m \in a\}$ is a $q + 1$ -wise disjoint sequence of closed subsets of X .*

Proof. Assume that $\langle U_m : m \in a \rangle$ is an H - γ -cover of X . For $x \in X$, $\{m \in a : x \in X \setminus U_m\} = \{m \in a : x \notin U_m\} \in H$, so $\bigcap_{m \in w} X \setminus U_m = \emptyset$ for any $w \subseteq a$ not in H .

Conversely, assume that $\{X \setminus U_m : m \in a\}$ is an H -wise disjoint sequence of closed sets. Let $x \in X$ and $v := \{m \in a : x \notin U_m\}$. Then $x \in \bigcap_{m \in v} (X \setminus U_m)$, so $v \in H$. Thus, the sequence $\langle U_m : m \in a \rangle$ is an H - γ -cover of X . \square

Continuous mappings preserve H - γ -covers.

Lemma 6.19. *Let X and Y be two topological spaces, $H \subseteq \mathcal{P}(a)$, and let $f: X \rightarrow Y$ be a continuous mapping. If $\langle U_m : m \in a \rangle$ is an open H - γ -cover of Y , then $\langle f^{-1}[[U_m]] : m \in a \rangle$ is an H - γ -cover of X .*

Proof. Let $\langle U_m : m \in a \rangle$ be an open H - γ -cover of Y . Fix $x \in X$. Since f is continuous, $f^{-1}[[U_m]]$ is open for each $m \in a$ and $\{m \in a : x \notin f^{-1}[[U_m]]\} = \{m \in a : f(x) \notin U_m\} \in H$. Thus $\langle f^{-1}[[U_m]] : m \in a \rangle$ is an H - γ -cover of X . \square

Since being an ω -cover is equivalent to being an I - γ -cover for some ideal I , it follows that:

Corollary 6.20. *If $f: X \rightarrow Y$ is continuous and $\langle U_m : m \in a \rangle$ is an open ω -cover of Y , then $\langle f^{-1}[[U_m]] : m \in a \rangle$ is an ω -cover of X .* \square

The selection principle $S_1^D(\mathcal{P}\text{-}\Gamma, R\text{-}\Gamma)$ is preserved under continuous images and closed subsets.

Lemma 6.21. *Assume that X is an $S_1^D(\mathcal{P}\text{-}\Gamma, R\text{-}\Gamma)$ -space.*

(a) *If $f: X \rightarrow Y$ is a continuous surjection then Y is an $S_1^D(\mathcal{P}\text{-}\Gamma, R\text{-}\Gamma)$ -space.*

(b) *If $S \cup \{\overline{\emptyset}\} \in \mathcal{P}$ for all $S \in \mathcal{P}$ and $Z \subseteq X$ is closed, then Z is an $S_1^D(\mathcal{P}\text{-}\Gamma, R\text{-}\Gamma)$ -space.*

The same is valid when $R\text{-}\Gamma$ is replaced by Ω .

Proof. (a): Let $\langle \langle U_{n,m} : m \in b(n) \rangle : n \in \omega \rangle \in \mathcal{P}\text{-}\Gamma(Y)$. Notice that

$$\begin{aligned} \{\langle \{m \in b(n) : x \notin f^{-1}[[U_{n,m}]]\} : n < \omega \rangle : x \in X\} &= \{\langle \{m \in b(n) : f(x) \notin U_{n,m}\} : n < \omega \rangle : x \in X\} \\ &= \{\langle \{m \in b(n) : y \notin U_{n,m}\} : n < \omega \rangle : y \in Y\} \in \mathcal{P}, \end{aligned}$$

so $\langle \langle f^{-1}[[U_{n,m}]] : m \in b(n) \rangle : n \in \omega \rangle \in \Gamma\text{-}\mathcal{P}(X)$. Consequently, since X is an $S_1^D(\mathcal{P}\text{-}\Gamma, R\text{-}\Gamma)$ -space, there is some $d \in D$ such that $\langle f^{-1}[[U_{n,d(n)}]] : n \in \omega \rangle \in R\text{-}\Gamma(X)$. For $y \in Y$, if $x \in X$ and $y = f(x)$, then

$$\{n \in \omega : y \notin U_{n,d(n)}\} = \{n \in \omega : x \notin f^{-1}[[U_{n,\varphi(n)}]]\} \in R.$$

Thus $\langle U_{n,d(n)} : n \in \omega \rangle$ is an R - γ -cover of Y .

(b): Let $\langle \langle U_{n,m} : m \in b(n) \rangle : n \in \omega \rangle \in \Gamma\text{-}\mathcal{P}(Z)$. Set $V_{n,m} := U_{n,m} \cup (X \setminus Z)$, which is open in X . Then,

$$\{\langle \{m \in b(n) : x \notin V_{n,m}\} : n < \omega \rangle : x \in X\} = \{\langle \{m \in b(n) : x \notin U_{n,m}\} : n < \omega \rangle : x \in Z\} \cup \{\overline{\emptyset}\} \in \mathcal{P}.$$

Since X is an $S_1^D(\mathcal{P}, R\text{-}\Gamma)$ -space, there is some $d \in D$ such that $\langle V_{n,d(n)} : n \in \omega \rangle \in R\text{-}\Gamma(X)$. Then, for $x \in Z$,

$$\{n < \omega : x \notin V_{n,d(n)}\} = \{n < \omega : x \notin U_{n,d(n)}\} \in R.$$

Thus $\langle U_{n,d(n)} : n \in \omega \rangle$ is an R - γ -cover of Z . \square

As a particular case, we emphasize the weakest versions of our selection principles, given by $S_1(\Gamma_h, \Gamma)$, $S_1(\Gamma_h, \mathcal{O})$ and with $h = q$ constant. These principles are related as in [Figure 11](#).

$$\begin{array}{ccccc} S_1(\Gamma_q, \Gamma) & \longrightarrow & S_1(\Gamma_1, \Gamma) & \longrightarrow & S_1(\Gamma_1, \mathcal{O}) \\ \uparrow & & \uparrow & & \uparrow \\ S_1(\Gamma, \Gamma) & \longrightarrow & S_1(\Gamma_h, \Gamma) & \longrightarrow & S_1(\Gamma_h, \mathcal{O}) \end{array}$$

Figure 11: Relations with respect to the well-known $S_1(\Gamma, \Gamma)$ -space.

J. Gerlits and Zs. Nagy [\[GN82\]](#) have introduced the notion of a γ -set, i.e., a topological space with every ω -cover having a γ -subcover. They have shown that a topological space X is a γ -set if and only if X is

an $S_1(\Omega, \Gamma)$ -space. Hence, all γ -sets are examples of $S_1(\Gamma_h, \Gamma)$ -spaces. On the other hand, we show that topological spaces satisfying the selection principle are totally imperfect. Notice that $S_1(\Gamma_1, \mathcal{O})$ is the weakest among all the interesting selection principles. In fact, if \mathcal{P} is \subseteq -downwards closed, $\mathcal{S}(b, 1) \in \mathcal{P}$ and $\omega \notin R$, then any $S_1^D(\mathcal{P}\text{-}\Gamma, R\text{-}\Gamma)$ -space is $S_1(\Gamma_1, \mathcal{O})$ (likewise if replacing $R\text{-}\Gamma$ by Ω).

Theorem 6.22.

- (a) *The Cantor space is not $S_1(\Gamma_1, \mathcal{O})$.*
- (b) *Any Hausdorff $S_1(\Gamma_1, \mathcal{O})$ -space is totally imperfect.*
- (c) *No uncountable Polish space is $S_1(\Gamma_1, \mathcal{O})$.*

Proof. (a): Fix a bijection $f: \omega \times \omega \rightarrow \omega$. For $n, m < \omega$, define closed set

$$F_{n,m} = \{x \in {}^\omega 2 : x(f(n, m)) = 1, x(f(n, i)) = 0 \text{ for all } i \neq m\}.$$

The sequence $\langle {}^\omega 2 \setminus F_{n,m} : m \in \omega \rangle$ is a γ_1 -cover for any $n \in \omega$. Assume that $d \in {}^\omega \omega$ and define $x \in {}^\omega 2$ by

$$x(i) = \begin{cases} 1 & \text{if } \exists n \in \omega (f(n, \varphi(n)) = i), \\ 0 & \text{otherwise.} \end{cases}$$

It is clear that $x \in F_{n,d(n)}$ for each $n \in \omega$, thus $\langle {}^\omega 2 \setminus F_{n,d(n)} : n \in \omega \rangle$ does not cover ${}^\omega 2$.

(b): It follows from the fact that no $S_1(\Gamma_1, \mathcal{O})$ contains a subspace isomorphic with the Cantor space by Lemma 6.21 and (a).

(c): By (b) because no uncountable Polish space is totally imperfect. □

7. Consistency results

This section aims to show the behavior of our slalom numbers in forcing models. We focus on models constructed via finite support iteration and pay special attention to the effect of adding Cohen reals.

As usual in forcing arguments, we work in a ground model V unless otherwise indicated. For two posets \mathbb{P} and \mathbb{Q} , $\mathbb{P} \subseteq \mathbb{Q}$ means that the inclusion map is a complete embedding from \mathbb{P} into \mathbb{Q} . When $\langle \mathbb{P}_\alpha : \alpha \leq \beta \rangle$ is a \subseteq -increasing sequence of posets (like an iteration) and G is \mathbb{P}_β -generic over V , we denote, for $\alpha \leq \beta$, $G_\alpha := \mathbb{P}_\alpha \cap G$ and $V_\alpha := V[G_\alpha]$. If $\mathbb{P}_{\alpha+1}$ is obtained by a two-step iteration $\mathbb{P}_\alpha * \dot{\mathbb{Q}}_\alpha$, $G(\alpha)$ denotes the $\dot{\mathbb{Q}}_\alpha$ -generic set over V_α such that $V_{\alpha+1} = V_\alpha[G(\alpha)]$ (i.e., $G_{\alpha+1} = G_\alpha * G(\alpha)$). We use \Vdash_α to denote the forcing relation on \mathbb{P}_α , and \leq_α to denote its order relation (although we use \leq when clear from the context).

7.1. Effect of Cohen reals

Recall the following well-known result from Canjar.

Lemma 7.1 (Canjar [Can88]). *Let $J \subseteq \mathcal{P}(\omega)$ be a family with the FUP. If $c \in {}^\omega \omega$ is Cohen over V , then*

$$J \cup \{\{i < \omega : c(i) < x(i)\} : x \in {}^\omega \omega \cap V\} \text{ has the FUP.}$$

As a consequence, $x \leq^{J^d} c$ for all $x \in {}^\omega \omega \cap V$, where J' is the ideal on ω generated by the family above. Moreover, any J -positive set in V is J' -positive, i.e., $J' \cap V = J$. □

We extend this result in connection to slalom numbers. First, fix some notation.

Notation 7.2. Let J be an ideal on ω . We say that a function $h \in {}^\omega\omega$ is J -unbounded if the set $\{n < \omega : h(n) \geq k\}$ is not in J for all $k < \omega$, and that $\lim^J h = \infty$ if $\{n < \omega : h(n) < k\} \in J$ for all $k < \omega$.

Lemma 7.3. Let J be an ideal on ω (or just a family with the FUP) and let $h \in {}^\omega\omega$ such that h is J -unbounded. If $c \in \prod_{n \in \omega} [\omega]^{\leq h(n)}$ is Cohen over V , then $V[c] \models J \cup \{\{n < \omega : x(n) \notin c(n)\} : x \in {}^\omega\omega \cap V\}$ has the FUP. In particular, this set generates an ideal J' such that $x \in J'^{\text{d}}$ c for all $x \in {}^\omega\omega \cap V$. Moreover, $\lim^{J'} h = \infty$ and, whenever $\lim^J h = \infty$, $J' \cap V = J$.

Proof. In this proof, we consider Cohen forcing \mathbb{C} as the set of conditions $p \in \prod_{i \in u} [\omega]^{\leq h(i)}$ for some $u \in \text{Fin}$, ordered by \supseteq . We denote the name of its generic real by \dot{c} .

Working in V , suppose that $F \subseteq {}^\omega\omega$ is finite, $a \in J$, $k < \omega$ and $p \in \mathbb{C}$. It is enough to prove that there is a $q \leq p$ and an $m \in \omega \setminus a$ such that $h(m) \geq k$ and $q \Vdash (\forall x \in F) x(m) \in \dot{c}(m)$. Since h is J -unbounded, there is an $m \in \omega \setminus (a \cup \text{dom } p)$ such that $\max\{k, |F|\} \leq h(m)$. Next, define a function $q \supseteq p$ such that $\text{dom } q := \text{dom } p \cup \{m\}$ and $q(m) := \{x(m) : x \in F\}$. Note that $|q(m)| \leq |F| \leq h(m)$, so $q \in \mathbb{C}$ and $q \leq p$. It is clear that q forces what we want.

By using the constant functions in ${}^\omega\omega$, since c dominates ${}^\omega\omega \cap V$, we can conclude that $\lim^{J'} h = \infty$. Concretely, for each $n \in \omega$ and $k \leq n$, $\|k \in c\| \in J'^{\text{d}}$, so $\|n \subseteq c\| \in J'^{\text{d}}$, which implies that $\|n \leq h\| \in J'^{\text{d}}$ because $c \in \mathcal{S}(\omega, h)$.

In the case when $\lim^J h = \infty$, the proof above can be modified to find $m \in a' \setminus a$ for any given $a' \in J^+$. Since $J \subseteq J'$ in $V[c]$, it is clear that $\lim^{J'} h = \infty$. \square

Lemma 7.4. Let $\mathcal{S} \in V$ be a set of slaloms with the FUPC and let J be an ideal on ω (or just a family with the FUP). If $c \in {}^\omega\omega$ is Cohen over V then, in $V[c]$, $J \cup \{\{i < \omega : c(i) \in S(i)\} : S \in \mathcal{S}\}$ has the FUP. In particular, this generates an ideal J' such that $c \notin J'^{\text{d}}$ S for all $S \in \mathcal{S}$. Moreover, $J' \cap V = J$.

Proof. Consider Cohen forcing \mathbb{C} as the set of finite partial functions $\omega \rightarrow \omega$, ordered by \supseteq .

Let $\mathcal{F} \subseteq \mathcal{S}$ be finite, $a \in J$, $a' \in J^+$ and $p \in \mathbb{C}$. It is enough to show that there are $i \in a' \setminus a$ and $q \leq p$ such that $q \Vdash (\forall S \in \mathcal{F}) c(i) \notin S(i)$. Pick any $i \in a' \setminus (a \cup \text{dom } p)$. By the FUPC of \mathcal{S} , $\bigcup_{S \in \mathcal{F}} S(i) \neq \omega$, so choose $k \in \omega \setminus \bigcup_{S \in \mathcal{F}} S(i)$. Any $q \leq p$ such that $q(i) = k$ is as required. \square

As a consequence of these results, adding Cohen reals strongly affects slalom numbers with ideals. Recall from [Figure 6](#) and [Figure 8](#) that many slalom numbers are between $\mathfrak{sl}_t(\star, J)$ and $\mathfrak{sl}_t(h, J)$, and between $\mathfrak{sl}_t^\perp(h, J)$ and $\mathfrak{sl}_t(h, J)$.

Theorem 7.5. Let π be an ordinal with uncountable cofinality, J_0 an ideal on ω and let $\langle \mathbb{P}_\alpha : \alpha \leq \pi \rangle$ be an \subseteq -increasing sequence of posets such that $\mathbb{P}_\pi = \bigcup_{\alpha < \pi} \mathbb{P}_\alpha$. Assume that \mathbb{P}_π has $\text{cf}(\pi)$ -cc and that $\mathbb{P}_{\alpha+1}$ adds a Cohen real over V_α for all $\alpha < \pi$. Let $\lambda := |\pi|$. Then:

- (a) \mathbb{P}_π forces that, for any J_0 -unbounded $h : \omega \rightarrow \omega$, there is a (maximal) ideal $J \supseteq J_0$ such that $\mathfrak{sl}_t^\perp(h, J) = \mathfrak{sl}_t(h, J) = \text{cf}(\pi)$ and h is J -unbounded.

For the following items, further assume that $\Vdash \mathfrak{c} = \lambda$ and that λ divides π , i.e., $\pi = \lambda\delta$ for some ordinal δ .²³

- (b) \mathbb{P}_π forces that there is an ideal $J \supseteq J_0$ such that $\mathfrak{sl}_t^\perp(h, J) = \mathfrak{sl}_t(h, J) = \text{cf}(\pi)$ for any J -unbounded $h : \omega \rightarrow \omega$. This implies that J is maximal.
- (c) Let $\theta \leq \text{cf}(\pi)$ be a cardinal. If $\lambda^{<\theta} = \lambda$ then \mathbb{P}_π forces that there is a maximal ideal $J \supseteq J_0$ such that $\theta \leq \mathfrak{sl}_t(\star, J) \leq \mathfrak{sl}_t^\perp(h, J) = \mathfrak{sl}_t(h, J) = \text{cf}(\pi)$ for any J -unbounded $h : \omega \rightarrow \omega$.

²³We must have $\delta < \lambda^+$, otherwise \mathbb{P}_π would add too many Cohen reals and force $\lambda > \mathfrak{c}$.

(d) If $\lambda^{<\text{cf}(\pi)} = \lambda$ then \mathbb{P}_π forces that there is a maximal ideal $J \supseteq J_0$ such that $\mathfrak{sl}_t(*, J) = \mathfrak{sl}_t^\perp(h, J) = \mathfrak{sl}_t(h, J) = \text{cf}(\pi) \leq \mathfrak{pk}(*, J)$ for any J -unbounded $h: \omega \rightarrow \omega$.

Proof. (a): Fix a J_0 -unbounded $h \in {}^\omega\omega \cap V_\pi$, so $h \in V_\alpha$ for some $\alpha < \pi$. In the following argument, it does not hurt to consider $\alpha = 0$.

For any $\zeta < \pi$, denote by c_ζ a Cohen real in $\mathcal{S}(\omega, h)$ that $\mathbb{P}_{\zeta+1}$ adds over V_ζ . In $V_{\zeta+1}$, define $A_\zeta := \{\{n < \omega : x(n) \notin c_\zeta(n)\} : x \in {}^\omega\omega \cap V_\zeta\}$. By employing [Lemma 7.3](#), we can prove by recursion on $\zeta \leq \pi$ that, in V_ζ , the family $J_\zeta = J_0 \cup \bigcup_{\xi < \zeta} \mathcal{A}_\xi$ has the FUP. Lastly, in V_π , let J be the ideal generated by J_π . Therefore, $\{c_\zeta : \zeta \in K\}$ is a witness for $\mathfrak{sl}_t(h, J)$ for any cofinal $K \subseteq \pi$, so $\mathfrak{sl}_t(h, J) \leq \text{cf}(\pi)$. On the other hand, any $F \subseteq {}^\omega\omega$ of size $< \text{cf}(\pi)$ is ε^{J^\perp} -bounded by some c_ζ , hence $\text{cf}(\pi) \leq \mathfrak{sl}_t^\perp(h, J)$. Moreover, $\lim^J h = \infty$ (because $\lim^{J_1} h = \infty$ after the first application of [Lemma 7.3](#), where J_1 is the ideal generated by J_1). Notice that we can extend J to a maximal ideal without affecting the result.

(b): This proof is similar to (a), but we need a book-keeping to find one J that works for all h . Let $j: \lambda \rightarrow \lambda \times \lambda$ be a bijection such that $j(\varepsilon) = (\xi, \xi')$ implies that $\xi \leq \varepsilon$. On the other hand, for $\alpha < \delta$, let $I_\alpha := [\lambda\alpha, \lambda(\alpha + 1))$, which is an interval of order type λ . Note that $\langle I_\alpha : \alpha < \theta \rangle$ is an interval partition of π .

We define a \mathbb{P}_ζ -name \dot{J}_ζ of an ideal on ω by recursion on $\zeta \leq \pi$ as follows. We start with $\dot{J}_0 := J_0$ and, for limit ζ , \dot{J}_ζ is a \mathbb{P}_ζ -name of the ideal generated by $\bigcup_{\eta < \zeta} \dot{J}_\eta$, so we are left with the induction step $\zeta = \eta + 1$. Pick $\alpha < \theta$ such that $\eta \in I_\alpha$ (which is unique), so $\eta = \lambda\alpha + \rho$ for some unique $\rho < \lambda$. Enumerate all the nice \mathbb{P}_η -names of \dot{J}_η -unbounded functions in ${}^\omega\omega$ by $\{\dot{h}_{\xi'}^\eta : \xi' < \lambda\}$ (which is possible because $\Vdash_\pi \mathfrak{c} = \lambda$). For convenience, we also denote $\dot{h}_{\rho, \xi'}^\alpha := \dot{h}_{\xi'}^\eta$.

Let us define \dot{J}_ζ by cases: we let \dot{J}_ζ be a \mathbb{P}_ζ -name of the ideal generated by $\dot{J}_\eta \cup \{\{n < \omega : x(n) \in \dot{c}_\eta(n)\} : x \in {}^\omega\omega \cap V_\eta\}$ where \dot{c}_η is the $\mathbb{P}_{\eta+1}$ -name of a Cohen real in $\mathcal{S}(\omega, \dot{h}_{j(\varepsilon)}^\alpha)$ over V_η in the case when \mathbb{P}_η forces that $\dot{h}_{j(\varepsilon)}^\alpha$ is \dot{J}_η -unbounded (if $j(\varepsilon) = (\xi, \xi')$ then $\xi \leq \varepsilon$, so $\dot{h}_{j(\varepsilon)}^\alpha = \dot{h}_{\xi, \xi'}^\alpha$ was already defined at step $\lambda\alpha + \xi \leq \eta$), otherwise let \dot{J}_ζ be a \mathbb{P}_ζ -name of the ideal generated by \dot{J}_η . Thanks to [Lemma 7.3](#), each \dot{J}_ζ is forced to have the FUP.

Let $\dot{J} := \dot{J}_\pi$. We prove that \dot{J} is forced as required, i.e., $\Vdash_\pi \mathfrak{sl}_t^\perp(\dot{h}, \dot{J}) = \mathfrak{sl}_t(\dot{h}, \dot{J}) = \text{cf}(\pi)$ for any (nice) \mathbb{P}_π -name \dot{h} of a \dot{J} -unbounded function in ${}^\omega\omega$. Since $\text{cf}(\pi) > \omega$ and \mathbb{P}_π is $\text{cf}(\pi)$ -cc, there is some $\zeta_0 < \pi$ such that \dot{h} is a \mathbb{P}_{ζ_0} -name. Then, for any $\zeta_0 \leq \zeta < \pi$, \dot{h} appears in the enumeration $\{\dot{h}_{\xi'}^\zeta : \xi' < \lambda\}$, meaning that there is some cofinal subset $K \subseteq \pi$ where the Cohen real \dot{c}_η described in the successor step of the construction of \dot{J} is in $\mathcal{S}(\omega, \dot{h})$. Therefore, as in (a), \mathbb{P}_π forces $\mathfrak{sl}_t^\perp(\dot{h}, \dot{J}) = \mathfrak{sl}_t(\dot{h}, \dot{J}) = \text{cf}(\pi)$.

We now prove that \mathbb{P}_π forces that \dot{J} is maximal. In V_π , let $J := \dot{J}[G_\pi]$, so $\mathfrak{sl}_t(h, J) = \text{cf}(\pi)$ for any J -unbounded $h \in {}^\omega\omega$. If J is not maximal, we can find some J -unbounded $h \in {}^\omega\omega$ such that $\|h = 0\| \in J^+$, but this implies that $\mathfrak{sl}_t(h, J)$ is undefined, a contradiction.

(c): The construction of the ideal is similar to (b), so we keep the same notation from there, e.g. the book-keeping function j and the interval I_α .

For each $\zeta < \pi$, enumerate $\{\dot{\mathcal{S}}_{\xi'}^\zeta : \xi' < \lambda\}$ the nice \mathbb{P}_ζ -names of all sets of slaloms in V_ζ with the FUPC of size $< \theta$ (this is possible by the assumption $\lambda^{<\theta} = \lambda$ and $\Vdash_\pi \mathfrak{c} = \lambda$). Note that $\{\dot{\mathcal{S}}_\xi^\zeta : \zeta < \pi, \xi' < \lambda\}$ enumerates all the nice \mathbb{P}_π -names of all sets of slaloms in V_π with the FUPC of size $< \theta$.

For each $\zeta \leq \pi$ we define a \mathbb{P}_ζ -name \dot{J}_ζ of a family with the FUP as follows: $\dot{J}_0 := J_0$ and, for limit ζ , $\dot{J}_\zeta := \bigcup_{\xi < \zeta} \dot{J}_\xi$, so we are left with the induction step $\zeta = \eta + 1$. Pick $\alpha < \delta$ and $\rho < \lambda$ such that $\eta = \lambda\alpha + \rho$. As before, enumerate all the nice \mathbb{P}_η -names of \dot{J}_η -unbounded functions in ${}^\omega\omega$ by $\{\dot{h}_{\xi'}^\eta : \xi' < \lambda\}$. For convenience, we also denote $\dot{h}_{\rho, \xi'}^\alpha := \dot{h}_{\xi'}^\eta$ and $\dot{\mathcal{S}}_{\rho, \xi'}^\alpha := \dot{\mathcal{S}}_{\xi'}^\eta$.

Let us define \dot{J}_ζ as a \mathbb{P}_ζ -name of the ideal generated by each family as in the following by cases:

$$\begin{aligned} \dot{J}_\eta \cup \{\{n < \omega : x(n) \in \dot{c}_\eta(n)\} : x \in {}^\omega\omega \cap V_\eta\} & \text{ when } \rho = 2\varepsilon \text{ and } \mathbb{P}_\eta \Vdash \dot{h}_j^\alpha(\varepsilon) \text{ is } \dot{J}_\eta\text{-unbounded,} \\ \dot{J}_\eta & \text{ when } \rho = 2\varepsilon \text{ and } \mathbb{P}_\eta \not\Vdash \dot{h}_j^\alpha(\varepsilon) \text{ is } \dot{J}_\eta\text{-unbounded,} \\ \dot{J}_\eta \cup \left\{ \{i < \omega : \dot{c}_\eta(i) \in S(i)\} : S \in \dot{\mathcal{S}}_{j(\varepsilon)}^\alpha \right\} & \text{ when } \rho = 2\varepsilon + 1. \end{aligned}$$

In the last case, \dot{c}_η is a Cohen real in ${}^\omega\omega$ over V_η (added by $\mathbb{P}_{\eta+1}$), while in the first case \dot{c}_η is a Cohen real in $\mathcal{S}(\omega, \dot{h}_{j(\varepsilon)}^\alpha)$. Thanks to [Lemma 7.3](#) and [7.4](#), we obtain that the families in the cases above have the FUP.

Let $\dot{J} := \dot{J}_\pi$. It can be proved as in (b) that $\Vdash_\pi \mathfrak{sl}_t^\perp(\dot{h}, \dot{J}) = \mathfrak{sl}_t(\dot{h}, \dot{J}) = \text{cf}(\pi)$ for any \mathbb{P}_π -name \dot{h} of a \dot{J} -unbounded function. On the other hand, in V_π , every \mathcal{S} with the FUPC of size $< \theta$ is $\dot{J}[G_\pi]$ -evaded by some Cohen real, hence $\theta \leq \mathfrak{sl}_c(*, \dot{J}[G_\pi])$. It is clear that $\dot{J}[G_\pi]$ is a maximal ideal.

(d): Apply (c) to $\theta := \text{cf}(\pi)$. □

As a consequence of the foregoing result, we derive:

Corollary 7.6. *Let π be a limit ordinal of uncountable cofinality, and let $\mathbb{P}_\pi = \langle \mathbb{P}_\xi, \dot{\mathbb{Q}}_\xi : \xi < \pi \rangle$ be a FS iteration of non-trivial $\text{cf}(\pi)$ -cc posets. Let $\lambda := |\pi|$. Then \mathbb{P}_π satisfies (a) of [Theorem 7.5](#), and also (b)–(d) when λ divides π and $\Vdash_\xi |\dot{\mathbb{Q}}_\xi| \leq \lambda$ for all $\xi < \pi$.*

Proof. The sequence $\langle \mathbb{P}_{\omega_\alpha} : \alpha \leq \pi \rangle$ is as required since FS iterations of non-trivial posets add Cohen reals at limit steps. □

Let I be a set. Denote by \mathbb{C}_I be the poset that adds Cohen reals indexed by I . Recall that $\mathfrak{b}_J = \mathfrak{b}$ and $\mathfrak{d}_J = \mathfrak{d}$ when J is a meager ideal on ω . On the other hand, M. Canjar [[Can88](#)] has shown that in $V^{\mathbb{C}_\lambda}$, if $\mu \leq \lambda$ is regular then there is a maximal ideal I_μ such that $\mathfrak{b}_{I_\mu} = \mu$. This result is extended as follows.

Theorem 7.7. *Let $\kappa \geq \aleph_1$ be regular and λ an infinite cardinal such that $\lambda^{<\kappa} = \lambda$. Then \mathbb{C}_λ forces $\text{non}(\mathcal{M}) = \aleph_1$, $\text{cov}(\mathcal{M}) = \mathfrak{c} = \lambda$ and that, for any regular $\aleph_1 \leq \kappa_1 \leq \kappa_2 \leq \kappa$:*

- (a) *There is a maximal ideal J on ω such that $\mathfrak{sl}_c(*, J) = \mathfrak{sl}_t^\perp(h, J) = \mathfrak{sl}_t(h, J) = \kappa_1$ for all J -unbounded $h \in {}^\omega\omega$ (see [Figure 5](#)).*
- (b) *There is an ideal J on ω such that $\mathfrak{sl}_c(*, J) = \mathfrak{sl}_t^\perp(h, J) = \mathfrak{sl}_t(h, J) = \kappa_1 \leq \mathfrak{sl}_e(*, J) = \mathfrak{sl}_e^\perp(h, J) = \mathfrak{sl}_t(h, J) = \kappa_2$ for any $h \in {}^\omega\omega$ such that $\lim^J h = \infty$ (see [Figure 5](#)).*

By weakening the assumption $\lambda^{<\kappa} = \lambda$ to $\kappa \leq \lambda$, we can force the above by removing $\mathfrak{sl}_e(, J)$ and $\mathfrak{sl}_t(*, J)$. In particular, it is consistent that $\mathfrak{b} < \mathfrak{b}_J < \mathfrak{d}_J < \mathfrak{d}$ for some ideal J on ω .*

Proof. It is well-known that \mathbb{C}_λ forces $\mathfrak{b} = \text{non}(\mathcal{M}) = \aleph_1$, and $\mathfrak{d} = \text{cov}(\mathcal{M}) = \mathfrak{c} = \lambda$ (see e.g. [[CM22](#)]).

(a): For any regular $\aleph_1 \leq \kappa_1 \leq \kappa$, since $\mathbb{C}_\lambda \cong \mathbb{C}_{\lambda\kappa_1}$ and $\mathbb{C}_{\lambda\kappa_1}$ can be obtained by a FS iteration of \mathbb{C} of length $\lambda\kappa_1$, by [Corollary 7.6](#) we obtain that \mathbb{C}_λ forces that there is a maximal ideal J such that $\mathfrak{sl}_c(*, J) = \mathfrak{sl}_t^\perp(h, J) = \mathfrak{sl}_t(h, J) = \kappa_1$ for all J -unbounded $h \in {}^\omega\omega$.

(b): By using (a), in $V^{\mathbb{C}_\lambda}$, there are maximal ideals J_1, J_2 such that $\mathfrak{sl}_c(*, J_1) = \mathfrak{sl}_t^\perp(h_1, J_1) = \mathfrak{sl}_t(h_1, J_1) = \kappa_1$ and $\mathfrak{sl}_t(*, J_2) = \mathfrak{sl}_e^\perp(h_2, J_2) = \mathfrak{sl}_t(h_2, J_2) = \kappa_2$ for any J_e -unbounded $h_e \in {}^\omega\omega$ and $e \in \{1, 2\}$. By letting $J := J_1 \oplus J_2$ (with suitable modifications of J_1 and J_2), any $h \in {}^\omega\omega$ can be written as $h = h_1 \oplus h_2$, and $\lim^J h = \infty$ iff $\lim^{J_1} h_1 = \lim^{J_2} h_2 = \infty$. We obtain, by [Corollary 5.6](#) and [Theorem 5.8](#), that

$$\begin{aligned} \mathfrak{sl}_c(*, J) &= \min\{\mathfrak{sl}_c(*, J_1), \mathfrak{sl}_c(*, J_2)\} = \kappa_1, & \mathfrak{sl}_t(*, J) &= \max\{\mathfrak{sl}_t(*, J_1), \mathfrak{sl}_t(*, J_2)\} = \kappa_2, \\ \mathfrak{sl}_e(h, J) &= \min\{\mathfrak{sl}_e(h_1, J_1), \mathfrak{sl}_e(h_2, J_2)\} = \kappa_1, & \mathfrak{sl}_e^\perp(h, J) &= \max\{\mathfrak{sl}_e^\perp(h_1, J_1), \mathfrak{sl}_e^\perp(h_2, J_2)\} = \kappa_2, \\ \mathfrak{sl}_t^\perp(h, J) &= \min\{\mathfrak{sl}_t^\perp(h_1, J_1), \mathfrak{sl}_t^\perp(h_2, J_2)\} = \kappa_1, & \mathfrak{sl}_t(h, J) &= \max\{\mathfrak{sl}_t(h_1, J_1), \mathfrak{sl}_t(h_2, J_2)\} = \kappa_2. \end{aligned} \quad \square$$

7.2. Applications of ccc models

We present several ccc forcing constructions to force constellations of [Figure 6](#) by application of [Theorem 7.5](#) and [Corollary 7.6](#). We skip details in the proofs when they can be found in the cited references.

Theorem 7.8 (cf. [[GKMS21](#), Sec. 6]). *Let $\lambda_0 \leq \lambda_1 \leq \lambda_2 \leq \lambda_3$ be uncountable regular cardinals and let λ_4 be a cardinal such that $\lambda_3 \leq \lambda_4 = \lambda_4^{<\lambda_3}$. Also assume that either $\lambda_1 = \lambda_2$, or λ_2 is \aleph_1 -inaccessible²⁴ and $2^{<\lambda_1} < \lambda_2$. Then there is some poset forcing that there is a maximal ideal J satisfying the constellation in [Figure 12](#) and $\mathfrak{s}_t^\perp(h, J) = \lambda_3$ for any J -unbounded $h \in {}^\omega\omega$.*

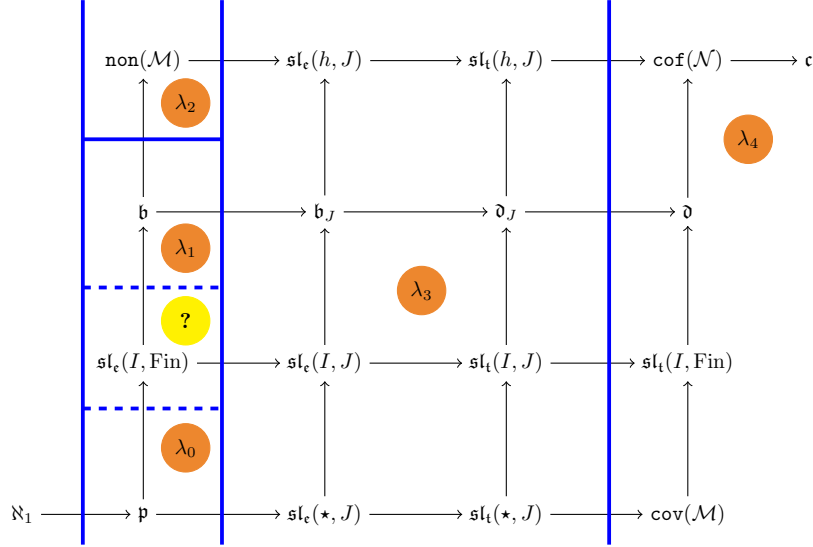

Figure 12: Constellation forced in [Theorem 7.8](#) for any J -unbounded h . As indicated in [Figure 6](#), an arrow represents that ZFC proves “ \leq ”; the thicker lines divide the diagram in regions where the cardinal characteristics take a value λ_i (for example, the cardinal characteristics in the central region take the value λ_3); The dotted lines indicate regions where the forced value is unclear, in this case that $\lambda_0 \leq \mathfrak{s}_e(I, \text{Fin}) \leq \lambda_1$ and that the exact value is unclear, although $\mathfrak{s}_e(I, \text{Fin}) = \lambda_0$ when I is a maximal ideal.

Proof. Construct a finite support iteration $\mathbb{P}_\pi = \langle \mathbb{P}_\alpha, \dot{Q}_\alpha : \alpha < \lambda_4 \rangle$ of length $\pi := \lambda_4 \lambda_3$ as in [[GKMS21](#), Subsec. 6B], with book-keeping arguments, of the following ccc posets:

- restrictions of \mathbb{E} (the standard σ -centered poset adding an eventually different real) of size $< \lambda_2$;
- all σ -centered posets of size $< \lambda_0$; and
- all σ -centered subposets of Hechler forcing of size $< \lambda_1$.

Then, \mathbb{P}_π forces $\mathfrak{p} = \mathfrak{s} = \lambda_0$, $\mathfrak{b} = \lambda_1$, $\text{non}(\mathcal{M}) = \lambda_2$ and $\text{cov}(\mathcal{M}) = \mathfrak{c} = \lambda_4$. On the other hand, since the cofinality of π is λ_3 , by using [Corollary 7.6](#), \mathbb{P}_π forces that there is a maximal ideal J such that $\mathfrak{s}_t(\star, J) = \mathfrak{s}_t^\perp(h, J) = \mathfrak{s}_t(h_1, J) = \lambda_3$ for any J -unbounded $h \in {}^\omega\omega$. On the other hand, by [Theorem 4.8 \(a\)](#), we know that $\mathfrak{s}_e(I, \text{Fin}) = \min\{\text{cov}^*(I), \mathfrak{b}\}$ for any ideal I on ω . In particular, when I is maximal, $\text{cov}^*(I) \leq \mathfrak{s}$ by [[BS99](#)], so \mathbb{P}_π forces that $\mathfrak{s}_e(I, \text{Fin}) = \lambda_0$ for any maximal ideal I on ω . \square

²⁴This means that $\mu^{\aleph_0} < \lambda_2$ for any cardinal $\mu < \lambda_2$.

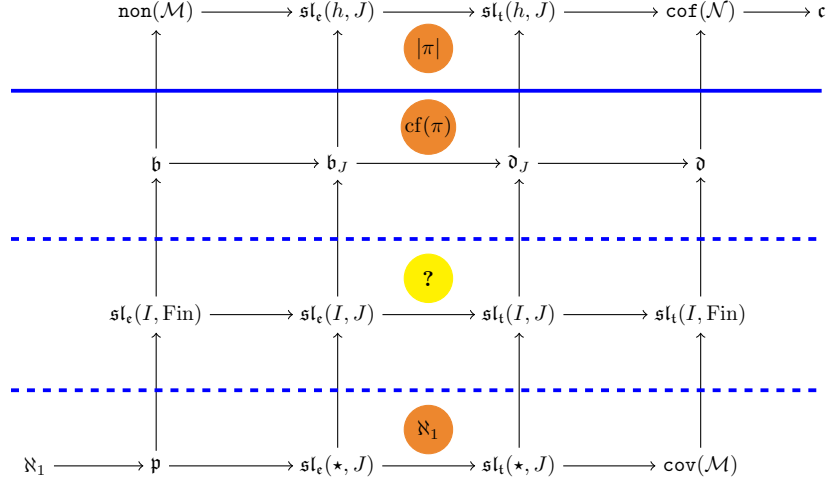

Figure 13: Constellation forced in [Theorem 7.9](#). The cardinals between the dotted lines lie between \aleph_1 and $\text{cf}(\pi)$, but their exact values are unclear. However, $\text{sl}_e(I, \text{Fin}) = \aleph_1$ for any maximal ideal I on ω .

Theorem 7.9. *Let π be an ordinal of uncountable cofinality, $\lambda := |\pi|$ and assume that $\lambda^{\aleph_0} = \lambda$. Then, the FS iteration of Hechler forcing of length π followed by the random algebra adding λ -many random reals forces the constellation of [Figure 13](#) and $\text{sl}_e^\perp(h, J) = \aleph_1$ for any $h \geq^* 1$ and any ideal J on ω .*

Proof. It is well-known that the first iteration of the Hechler poset forces $\mathfrak{p} = \text{add}(\mathcal{N}) = \text{cov}(\mathcal{N}) = \aleph_1$, $\text{add}(\mathcal{M}) = \text{cof}(\mathcal{M}) = \text{cf}(\pi)$ and $\text{non}(\mathcal{N}) = \mathfrak{c} = |\pi|$ (see e.g. [\[Mej13, Thm. 5\]](#)). After further adding λ -many random reals by using the random algebra, the generic extension satisfies $\text{non}(\mathcal{N}) = \aleph_1$, $\mathfrak{b} = \mathfrak{d} = \text{cf}(\pi)$, and $\text{cov}(\mathcal{N}) = \mathfrak{c} = |\pi|$ (details can be found in [\[GKMS22, Sec. 5\]](#)). As a consequence, $\text{sl}_e^\perp(h, J) = \text{sl}_t^\perp(*, J) = \aleph_1$ and $\text{sl}_e(h, J) = \mathfrak{c}$ for any ideal J on ω and $h \in {}^\omega\omega$ with $h \geq^* 1$. On the other hand, when I is a maximal ideal, $\text{cov}^* I \leq \mathfrak{s} \leq \text{non}(\mathcal{N}) = \aleph_1$ by [\[BS99\]](#), so $\text{sl}_e(I, \text{Fin}) = \min\{\text{cov}^* I, \mathfrak{b}\} = \aleph_1$. \square

7.3. Several values

Using the method of coherent systems from [\[Mej19\]](#), we force constellations of [Figure 6](#) with many different values of cardinal invariants parametrized with ideals. The method is reviewed as follows.

Definition 7.10 (cf. [\[FFMM18, Def. 3.2\]](#)). A simple coherent system (of FS iterations) \mathfrak{s} is composed of the following objects:

- (I) a partially ordered set $I^{\mathfrak{s}}$ with a maximum i^* , an ordinal $\pi^{\mathfrak{s}}$,
- (II) a function $\Delta^{\mathfrak{s}}: \pi^{\mathfrak{s}} \setminus \{0\} \rightarrow I^{\mathfrak{s}}$,
- (III) for each $i \in I^{\mathfrak{s}}$, a FS iteration $\mathbb{P}_{i, \pi^{\mathfrak{s}}}^{\mathfrak{s}} = \langle \mathbb{P}_{i, \xi}^{\mathfrak{s}}, \dot{\mathbb{Q}}_{i, \xi}^{\mathfrak{s}} : \xi < \pi^{\mathfrak{s}} \rangle$ such that,
 - (i) $\mathbb{P}_{i, 1}^{\mathfrak{s}} \subseteq \mathbb{P}_{j, 1}^{\mathfrak{s}}$ whenever $i \leq j$ in $I^{\mathfrak{s}}$, and
 - (ii) for any $0 < \xi < \pi^{\mathfrak{s}}$, there is some $\mathbb{P}_{\Delta^{\mathfrak{s}}(\xi), \xi}^{\mathfrak{s}}$ -name of a poset $\dot{\mathbb{Q}}_{\xi}^{\mathfrak{s}}$, with a maximum element 1_{ξ} living in V (not just a name) such that, for any $i \in I^{\mathfrak{s}}$,

$$\dot{\mathbb{Q}}_{i, \xi}^{\mathfrak{s}} = \begin{cases} \dot{\mathbb{Q}}_{\xi}^{\mathfrak{s}}, & \text{if } i \geq \Delta^{\mathfrak{s}}(\xi), \\ \{1_{\xi}\}, & \text{otherwise.} \end{cases}$$

According to this notation, $\mathbb{P}_{i,0}^{\mathbf{s}}$ is the trivial poset and $\mathbb{P}_{i,1}^{\mathbf{s}} = \dot{\mathbb{Q}}_{i,0}^{\mathbf{s}}$. We often refer to $\langle \mathbb{P}_{i,1}^{\mathbf{s}} : i \in I^{\mathbf{s}} \rangle$ as the *base of the coherent system* \mathbf{s} . Note that (III) implies that $\mathbb{P}_{i,\xi}^{\mathbf{s}} \subset \mathbb{P}_{j,\xi}^{\mathbf{s}}$ whenever $i \leq j$ in $I^{\mathbf{s}}$ and $\xi \leq \pi^{\mathbf{s}}$ (see details in [FFMM18]).

For $j \in I^{\mathbf{s}}$ and $\eta \leq \pi^{\mathbf{s}}$ we write $V_{j,\eta}^{\mathbf{s}}$ for the $\mathbb{P}_{j,\eta}^{\mathbf{s}}$ -generic extensions. Concretely, when G is $\mathbb{P}_{j,\eta}^{\mathbf{s}}$ -generic over V , $V_{j,\eta}^{\mathbf{s}} := V[G]$ and $V_{i,\xi}^{\mathbf{s}} := V[\mathbb{P}_{i,\xi}^{\mathbf{s}} \cap G]$ for all $i \leq j$ in $I^{\mathbf{s}}$ and $\xi \leq \eta$. Note that $V_{i,\xi}^{\mathbf{s}} \subseteq V_{j,\eta}^{\mathbf{s}}$ and $V_{i,0}^{\mathbf{s}} = V$ (see Figure 14).

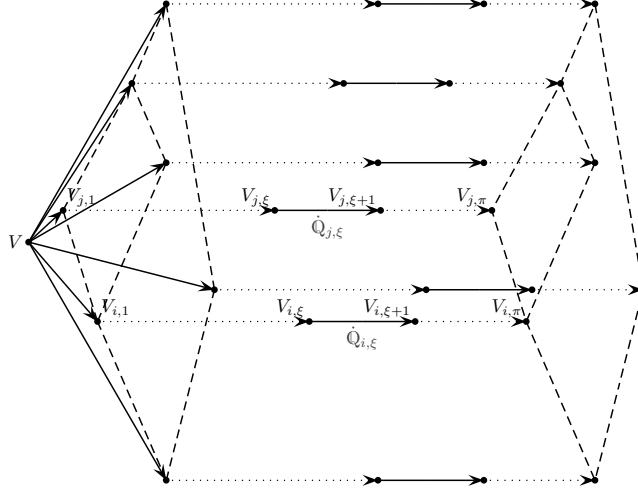

Figure 14: Coherent system of FS iterations. FS iterations of length π for each $i \in I$ produce a sequence of generic extensions $\langle V_{i,\xi} : i \in I, \xi \leq \pi \rangle$, increasing on i and ξ , starting with $V_{i,0} = V$ (the ground model). Each arrow denotes “ \subseteq ” and the figures in dashed lines represent the ‘shape’ of the partial order $\langle I, \leq \rangle$, i.e. $i \leq j$ in I implies $V_{i,\xi} \subseteq V_{j,\xi}$ for all $\xi \leq \pi$.

We say that the coherent system \mathbf{s} has the θ -cc if, additionally, $\mathbb{P}_{i,\xi}^{\mathbf{s}}$ forces that $\dot{\mathbb{Q}}_{i,\xi}^{\mathbf{s}}$ has the θ -cc for each $i \in I^{\mathbf{s}}$ and $\xi < \pi^{\mathbf{s}}$. This implies that $\mathbb{P}_{i,\xi}^{\mathbf{s}}$ has the θ -cc for all $i \in I^{\mathbf{s}}$ and $\xi \leq \pi^{\mathbf{s}}$.

For a coherent system \mathbf{s} and a set $J \subseteq I^{\mathbf{s}}$, $\mathbf{s}|_J$ denotes the coherent system with $I^{\mathbf{s}|_J} = J$, $\pi^{\mathbf{s}|_J} = \pi^{\mathbf{s}}$ and the FS iterations corresponding to (III) defined as for \mathbf{s} ,²⁵ if $\eta \leq \pi^{\mathbf{s}}$, $\mathbf{s} \upharpoonright \eta$ denotes the coherent system with $I^{\mathbf{s} \upharpoonright \eta} = I^{\mathbf{s}}$, $\pi^{\mathbf{s} \upharpoonright \eta} = \eta$ and the iterations for (III) defined up to η as for \mathbf{s} . Also, for $i_0 \in I$, denote $J_{<i_0} := \{i \in J : i < i_0\}$. The set $J_{\leq i_0}$ is defined similarly.

In particular, the upper indices \mathbf{s} are omitted when there is no risk of ambiguity.

Recall that, whenever $\langle I, \leq \rangle$ is a directed partial order (i.e., for all $i, j \in I$ there is some $j' \in I$ above them) and $\langle \mathbb{P}_i : i \in I \rangle$ is a sequence of posets such that $\mathbb{P}_i \subset \mathbb{P}_j$ whenever $i \leq j$ in I , the *direct limit* of $\langle \mathbb{P}_i : i \in I \rangle$ is $\mathbb{P} := \bigcup_{i \in I} \mathbb{P}_i$.

Lemma 7.11 (cf. [Mej19, Lem. 2.7]). *Let θ be an uncountable regular cardinal and let \mathbf{s} be a θ -cc simple coherent system. Assume:*

- (i) $i^* \notin \text{ran } \Delta$, $\mathfrak{b}(I_{<i^*}^{\mathbf{s}}) \geq \theta$ and
- (ii) whenever $\pi > 0$, $\mathbb{P}_{i^*,1}$ is the direct limit of $\langle \mathbb{P}_{i,1} : i \in I_{<i^*}^{\mathbf{s}} \rangle$.

²⁵It could happen that $\Delta(\xi) \notin J$ for some ξ , but this is not a problem because, in this case, all iterands at ξ are $\{1_\xi\}$.

Then, for every $\xi \leq \pi$:

- (a) $\mathbb{P}_{i^*,\xi}$ is the direct limit of $\langle \mathbb{P}_{i,\xi} : i \in I_{<i^*}^s \rangle$ and
- (b) for any $\mathbb{P}_{i^*,\xi}$ -name of a function \dot{x} with domain $\gamma < \theta$ into $\bigcup_{i \in I_{<i^*}^s} V_{i,\xi}$, there is some $i \in I_{<i^*}^s$ such that \dot{x} is (forced to be equal to) a $\mathbb{P}_{i,\xi}$ -name.

Proof. We first prove (a) \Rightarrow (b). Let \dot{x} be a $\mathbb{P}_{i^*,\xi}$ -name as in (b). For each $\alpha < \gamma$, there is some maximal antichain $A_\alpha \subseteq \mathbb{P}_{i^*,\xi}$ such that, for each $p \in A_\alpha$, there are some $i_{\alpha,p} \in I_{<i^*}^s$ and some $\mathbb{P}_{i_{\alpha,p},\xi}$ -name $\dot{x}_{\alpha,p}$ such that $p \Vdash \dot{x}(\alpha) = \dot{x}_{\alpha,p}$. Since $\mathbb{P}_{i^*,\xi}$ is θ -cc, $|A_\alpha| < \theta$, so $A := \bigcup_{\alpha < \gamma} A_\alpha$ has size $< \theta$ because θ is regular. Since $\mathfrak{b}(I_{<i^*}^s) \geq \theta$, by (a) there is some $i \in I_{<i^*}^s$ such that $A \subseteq \mathbb{P}_{i,\xi}$ and $i_{\alpha,p} \leq i$ for all $\alpha < \gamma$ and $p \in A_\alpha$. Then, each A_α is a maximal antichain in $\mathbb{P}_{i,\xi}$ and each $\dot{x}_{\alpha,p}$ is a $\mathbb{P}_{i,\xi}$ -name. So we can define a $\mathbb{P}_{i,\xi}$ -name \dot{y} of a function with domain γ such that, for any $\alpha < \gamma$ and $p \in A_\alpha$, $p \Vdash_{\mathbb{P}_{i,\xi}} \dot{y}(\alpha) = \dot{x}_{\alpha,p}$. Therefore, $\Vdash_{\mathbb{P}_{i^*,\xi}} \dot{x} = \dot{y}$.

We now prove (a) by induction on $\xi \leq \pi$. The case $\xi \in \{0, 1\}$ is trivial. For the successor step $\xi \rightarrow \xi + 1$ with $\xi \geq 1$, assume that (a) holds for ξ , so (b) is implied for ξ . Let $p \in \mathbb{P}_{i^*,\xi+1}$. Without loss of generality, assume that $\xi \in \text{dom } p$, so $p \restriction \xi \in \mathbb{P}_{i^*,\xi}$ and $\Vdash_{\mathbb{P}_{i^*,\xi}} p(\xi) \in \dot{Q}_\xi = \dot{Q}_{\Delta(\xi),\xi} \subseteq V_{\Delta(\xi),\xi}$. By (a) and (b) for ξ , we can find $i_0, i_1 \in I_{<i^*}^s$ such that $p \restriction \xi \in \mathbb{P}_{i_0,\xi}$ and $p(\xi)$ is a $\mathbb{P}_{i_1,\xi}$ -name (for the latter, consider a name for the function with domain 1 sending 0 to $p(\xi)$). Since $\mathfrak{b}(I_{<i^*}^s)$ is infinite, find some $i \in I_{<i^*}^s$ above $\Delta(\xi)$, i_0 and i_1 . Then, $p \in \mathbb{P}_{i,\xi}$.

For the limit step, assume that ξ is limit. If $p \in \mathbb{P}_{i^*,\xi}$ then $p \in \mathbb{P}_{i^*,\xi_0}$ for some $\xi_0 < \xi$, hence, by induction hypothesis, $p \in \mathbb{P}_{i,\xi_0}$ for some $i \in I_{<i^*}^s$. Clearly, $p \in \mathbb{P}_{i,\xi}$. \square

Theorem 7.12. *Let θ be an uncountable regular cardinal and let \mathfrak{s} be a θ -cc simple coherent system. Assume:*

- (i) $i_0 < i_1$ in I^s and $0 < \pi$,
- (ii) $I^0 \subseteq I^s$ and either $i_0 \in I^0$, or $\mathfrak{b}(I_{<i_0}^0) \geq \theta$ and $i_0 \notin \text{ran } \Delta$,
- (iii) $\mathbb{P}_{i_0,1}$ is the direct limit of $\langle \mathbb{P}_{i,1} : i \in I_{\leq i_0}^0 \rangle$,²⁶ and
- (iv) $\mathbb{P}_{i_1,1}$ adds a real \dot{c} such that, for any $i \in I_{\leq i_0}^0$, $\mathbb{P}_{i_1,1}$ forces that \dot{c} is Cohen over $V_{i,1}$.

Then, $\mathbb{P}_{i_1,\pi}$ forces that \dot{c} is Cohen over $V_{i_0,\pi}$.

To proceed with the proof of the theorem, we need to review some facts about the preservation of \mathbf{R} -unbounded reals (property defined below) when $\mathbf{R} = \langle X, Y, \sqsubset \rangle$ is a *Polish relational system*. We use [CM19, §4.3] as a reference. We do not define Polish relational systems since we do not require the details, but we just mention that X is a perfect Polish space, Y is an analytic subset of some Polish space, and \sqsubset is a very well-defined relation (concretely, F_σ), which allow many absoluteness arguments. We are interested in using a Polish relational system \mathbf{M} that is Tukey equivalent with \mathbf{C}_M . There are many examples, one is $\mathbf{M} = \langle \omega^2, \omega^2 \times \mathbb{I}, \sqsubset^m \rangle$ where \mathbb{I} denotes the collection of all interval partitions $I = \langle I_n : n < \omega \rangle$ of ω and

$$x \sqsubset^m (y, I) \text{ iff } (\forall^\infty n < \omega)(\exists \ell \in I_n) x(\ell) \neq y(\ell).$$

A pair (y, I) is typically known as a *matching real*. The proof of $\mathbf{M} \cong_T \mathbf{C}_M$ can be found in, e.g. [Bla10].

Given a relational system $\mathbf{R} = \langle X, Y, \sqsubset \rangle$ and a transitive model N of ZFC, a real $c \in X$ is \mathbf{R} -unbounded over N if $c \not\sqsubset y$ for all $y \in Y^N$. Note that $c \in \omega^2$ is \mathbf{M} -unbounded over N iff c is a Cohen real over N .

We say that \mathfrak{s} is a *simple coherent pair* if it is a simple coherent system with $I^s = \{i_0, i_1\}$ and $i_0 < i_1$. We use the following results about the preservation of \mathbf{R} -unbounded reals for coherent pairs, where $\mathbf{R} = \langle X, Y, \sqsubset \rangle$ is a Polish relational system (in particular, \mathbf{M}).

²⁶This is trivial when $i_0 \in I^0$.

Lemma 7.13 ([CM19, Lem. 4.29]). *Let $M \subseteq N$ be transitive models of ZFC such that \mathbf{R} can be defined in M (and hence, in N). Assume that $c \in X^N$ is \mathbf{R} -unbounded over M . If $\mathbb{P} \in M$ is a poset and G is \mathbb{P} -generic over N , then c is \mathbf{R} -unbounded over $M[G]$. \square*

Lemma 7.14 ([CM19, Cor. 4.31]). *Let \mathbf{s} be a simple coherent pair of length a limit ordinal π , wlog $I^{\mathbf{s}} = \{0, 1\}$. Assume that \dot{c} is a $\mathbb{P}_{1,1}$ -name of a member of X such that, for any $\xi < \pi$, $\mathbb{P}_{1,\xi}$ forces that \dot{c} is \mathbf{R} -unbounded over $V_{0,\xi}$. Then $\mathbb{P}_{1,\pi}$ forces that \dot{c} is \mathbf{R} -unbounded over $V_{0,\pi}$. \square*

Proof of Theorem 7.12. Let \dot{y} and \dot{I} be $\mathbb{P}_{i_0,\pi}$ -names of members of ${}^\omega 2$ and \mathbb{I} , respectively. It suffices to show that $\mathbb{P}_{i_1,\pi}$ forces $\dot{c} \sqsubset^m (\dot{y}, \dot{I})$. By hypothesis, in the case $i_0 \notin I^0$, we can apply Lemma 7.11 to $\mathbf{s}|_{I^0_{\leq i_0}}$ and get some $i \in I^0_{< i_0}$ such that \dot{y} and \dot{I} are $\mathbb{P}_{i,\pi}$ -names. When $i_0 \in I^0$, set $i := i_0$. In any case, $i \in I^0_{\leq i_0}$.

It is enough to show, by induction on $1 \leq \eta \leq \pi$, that $\mathbb{P}_{i_1,\eta}$ forces that \dot{c} is \mathbf{M} -unbounded (i.e., Cohen) over $V_{i,\eta}$. The case $\eta = 1$ is clear by (iv), and the limit step is immediate from Lemma 7.14. So we deal with the successor step $\eta = \xi + 1 > 1$. We consider two cases: if $\Delta(\xi) \leq i$ then $\dot{Q}_{i,\xi} = \dot{Q}_{i_1,\xi} = \dot{Q}_\xi$, so we can apply Lemma 7.13; but if $\Delta(\xi) \not\leq i$ then $\dot{Q}_{i,\xi} = \{0\}$ (the trivial poset), so $V_{i,\xi+1} = V_{i,\xi}$ and $\mathbb{P}_{i_1,\xi}$ already forces that \dot{c} is \mathbf{M} -unbounded over $V_{i,\xi}$ (and so does $\mathbb{P}_{i_1,\xi+1}$). \square

Theorem 7.15. *Let θ be an uncountable regular cardinal and let \mathbf{s} be a θ -cc simple coherent system. Assume:*

- (i) $\text{ran } \Delta \subseteq I^0 \subseteq I^s_{< i^*}$ and, for every $i \in I^s \setminus I^0$, $\mathfrak{b}(I^0_{< i}) \geq \theta$, and
- (ii) For every $i_0 \in I^s \setminus I^0$, $\mathbb{P}_{i_0,1}$ is the direct limit of $\langle \mathbb{P}_{i,1} : i \in I^0_{< i_0} \rangle$.

Then:

- (a) For every $i_0 \in I^s$, $\mathbb{P}_{i_0,\pi}$ is the direct limit of $\langle \mathbb{P}_{i,\pi} : i \in I^0_{\leq i_0} \rangle$.
- (b) If $\langle i_\zeta : \zeta < \delta \rangle$ is an increasing sequence in $I^s_{< i^*}$ such that, for any $i \in I^0$, there is some $\zeta < \delta$ such that $i \leq i_\zeta$, then $\mathbb{P}_{i^*,\pi}$ is the direct limit of $\langle \mathbb{P}_{i_\zeta,\pi} : \zeta < \delta \rangle$.
- (c) Further assume that $\lambda := |I^s|$, ν is a regular cardinal, $\theta \leq \nu \leq \lambda$, $|\mathbb{P}_{i^*,\pi}| \leq \lambda$, $\lambda^{< \nu} = \lambda$, and there is some strictly increasing sequence $\langle i_\zeta : \zeta < \lambda \nu \rangle$ in $I^s_{< i^*}$ as in (b) and such that, for any $\zeta < \lambda \nu$, $\mathbb{P}_{i_{\zeta+1},1}$ adds a Cohen real over $V_{i_\zeta,1}$. Then, $\mathbb{P}_{i^*,\pi}$ forces that there is some maximal ideal J_ν^* on ω such that $\mathfrak{sl}_e(\star, J_\nu^*) = \mathfrak{sl}_t^\perp(h, J_\nu^*) = \mathfrak{sl}_t(h, J_\nu^*) = \nu$ for any J_ν^* -unbounded $h \in {}^\omega \omega$. If we remove the assumption $\lambda^{< \nu} = \lambda$, then we can remove $\mathfrak{sl}_e(\star, J_\nu^*)$ in the result.

Proof. (a) is a direct consequence of Lemma 7.11 when $i_0 \in I^s \setminus I^0$, otherwise it is trivial. (b) follows directly by (a).

To see (c): By Theorem 7.12, for any $\zeta < \lambda \nu$, $\mathbb{P}_{i_{\zeta+1},\pi}$ adds a Cohen real over $V_{i_\zeta,\pi}$. Then, by (b), $\mathbb{P}_{i^*,\pi}$ is the direct limit of $\langle \mathbb{P}_{i_\zeta,\pi} : \zeta < \lambda \nu \rangle$ and, thus, this sequence satisfies the hypothesis of Theorem 7.5. Hence, $\mathbb{P}_{i^*,\pi}$ forces that there is some maximal ideal J_ν^* satisfying $\mathfrak{sl}_e(\star, J_\nu^*) = \mathfrak{sl}_t^\perp(h, J_\nu^*) = \mathfrak{sl}_t(h, J_\nu^*) = \nu$ for any J_ν^* -unbounded $h \in {}^\omega \omega$. \square

We now proceed with the applications. We use models established in [Mej19, BCM21] and omit the details that can be found in the references.

Theorem 7.16 (cf. [Mej19, Thm. 4.4]). *Let λ_0 be an uncountable regular cardinal, and let $\lambda_3 \leq \lambda_4$ be cardinals such that $\text{cof}([\lambda_3]^{< \lambda_0}) = \lambda_3$ and $\lambda_4 = \lambda_4^{< \lambda_0}$. Then there is a ccc poset forcing $\mathfrak{p} = \text{non}(\mathcal{M}) = \lambda_0$, $\text{cov}(\mathcal{M}) = \mathfrak{d} = \lambda_3$, $\text{cof}(\mathcal{N}) = \mathfrak{c} = \lambda_4$, and:*

- (a) For any regular cardinal λ such that $\lambda_0 \leq \lambda \leq \lambda_3$ and $\lambda_4^{< \lambda} = \lambda_4$, there is some maximal ideal J such that $\mathfrak{sl}_e(\star, J) = \mathfrak{sl}_t^\perp(h, J) = \mathfrak{sl}_t(h, J) = \lambda$ for any J -unbounded $h \in {}^\omega \omega$ (see Figure 15). When the assumption $\lambda_4^{< \lambda} = \lambda_4$ is removed, we can remove $\mathfrak{sl}_e(\star, J)$.

- (b) For any regular cardinals λ_1 and λ_2 such that $\lambda_0 \leq \lambda_1 \leq \lambda_2 \leq \lambda_3$ and $\lambda_4^{<\lambda_2} = \lambda_4$, there is some ideal J' satisfying $\mathfrak{sl}_e(\star, J') = \mathfrak{sl}_t^\perp(h, J') = \mathfrak{sl}_e(h, J') = \lambda_1$ and $\mathfrak{sl}_t(\star, J') = \mathfrak{sl}_e^\perp(h, J') = \mathfrak{sl}_t(h, J') = \lambda_2$ for any $h \in {}^\omega\omega$ such that $\lim^{J'} h = \infty$ (see Figure 15). When the assumption $\lambda_4^{<\lambda_2} = \lambda_4$ is removed, we can remove $\mathfrak{sl}_e(\star, J')$ and $\mathfrak{sl}_t(\star, J')$.

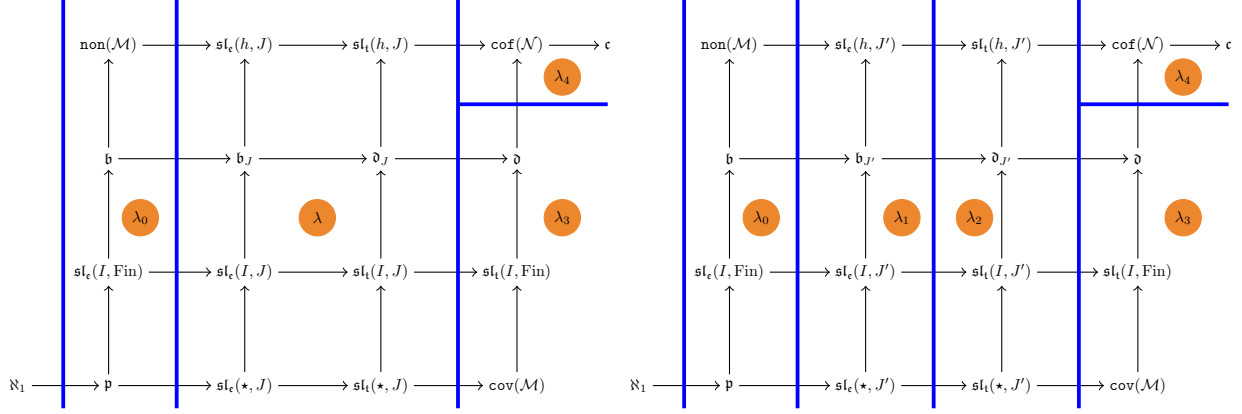

Figure 15: Constellations forced in Theorem 7.16.

Proof. Construct a simple coherent system on $I^s := \mathcal{P}(\lambda_4)$ (ordered by \subseteq) of FS iterations of length $\pi := \lambda_4\lambda_3$, where $\mathbb{P}_{A,1} := \mathbb{C}_A$ for all $A \subseteq \lambda_4$. To proceed with the construction, we fix a cofinal family $C \subseteq [\lambda_3]^{<\lambda_0}$ of size λ_3 and a function $t: \lambda_3 \rightarrow C$ such that $|t^{-1}[\{w\}]| = \lambda_3$ for all $w \in C$. Partition λ_4 into sets $\langle S_\zeta : \zeta < \lambda_3 \rangle$ of size λ_4 and, for $w \subseteq \lambda_3$, set $S_w^* := \bigcup_{\zeta \in w} S_\zeta$. For $0 < \alpha < \lambda_3$ and $\rho < \lambda_4$, define $\Delta(\lambda_4\alpha + \rho) := S_{t(\alpha)}^*$ and $\Delta(\rho) := S_{t(0)}^*$, the latter when $\rho > 0$.

The iteration is constructed at each interval $[\lambda_4\alpha, \lambda_4(\alpha + 1))$ as follows. Using the Δ defined above, define $\mathbb{Q}_{\lambda_4\alpha} := \mathbb{D}^{V_{\Delta(\lambda_4\alpha), \lambda_4\alpha}}$ when $\alpha > 0$, where \mathbb{D} denotes Hechler forcing. Also allowing $\alpha = 0$, enumerate all the nice $\mathbb{P}_{S_{t(\alpha)}^*, \lambda_4\alpha}$ -names $\langle \mathbb{Q}_\xi : \lambda_4\alpha < \xi < \lambda_4(\alpha + 1) \rangle$ of all the σ -centered posets with domain contained in λ_4 of size $< \lambda_0$. This is possible by the assumption $\lambda_4^{<\lambda_0} = \lambda_4$, as it is always forced that $\mathfrak{c} \leq \lambda_4$. At each $\lambda_4\alpha < \xi < \lambda_4(\alpha + 1)$ we use \mathbb{Q}_ξ for the successor step (considering the value of $\Delta(\xi)$ as well). This finishes the forcing construction.

Define $I^0 := \{A \subseteq \lambda_4 : (\exists w \in C) A \subseteq S_w^*\}$. Notice that $\text{ran } \Delta = \{S_w^* : w \in C\}$ is cofinal in I^0 . Also, for any $B \in \mathcal{P}(\lambda_4) \setminus I^0$, $\mathfrak{b}(I_{\subseteq B}^0) = \lambda_0$ and $\mathbb{P}_{B,1} = \mathbb{C}_B$ is the direct limit of $\langle \mathbb{P}_{A,1} : A \in I_{\subseteq B}^0 \rangle$. Therefore, Theorem 7.12 can be applied to conclude that, for any $B \subsetneq B' \subseteq \lambda_4$, $\mathbb{P}_{B',\pi}$ adds a Cohen real over $V_{B,\pi}$. On the other hand, for any limit ordinal $\delta < \lambda_4^+$ of cofinality between λ_0 and λ_3 , we can construct an strictly increasing sequence $\langle B_\zeta^\delta : \zeta < \delta \rangle$ in $\mathcal{P}(\lambda_4)$ such that any $A \in I^0$ is contained in some B_ζ^δ . To see this, pick an increasing cofinal sequence $\langle \delta_\gamma : \gamma < \text{cf}(\delta) \rangle$ in δ and a \subsetneq -increasing sequence $\langle w_\gamma : \gamma < \text{cf}(\delta) \rangle$ such that $\bigcup_{\gamma < \text{cf}(\delta)} w_\gamma = \lambda_3$ (the latter is possible because $\text{cf}(\delta) \leq \lambda_3$). For each $\gamma < \delta$, since $|\delta_{\gamma+1} \setminus \delta_\gamma| \leq \lambda_4$ (because $\delta < \lambda_4^+$), we can find a \subsetneq -increasing sequence $\langle B_\zeta^\delta : \delta_\gamma \leq \zeta < \delta_{\gamma+1} \rangle$ such that $B_{\delta_\gamma}^\delta = S_{w_\gamma}^*$ and $B_\zeta^\delta \subseteq S_{w_{\gamma+1}}^*$. Now, for any $w \in C$, since $\text{cf}(\delta) \geq \lambda_0$, there is some $\gamma < \text{cf}(\delta)$ such that $w \subseteq w_\gamma$. Therefore, $S_w^* \subseteq B_{\delta_\gamma}^\delta$.

Thus, by Theorem 7.15, $\mathbb{P}_{\lambda_4,\pi}$ is the direct limit of $\langle \mathbb{P}_{B_\zeta^\delta,\pi} : \zeta < \delta \rangle$. As a consequence, $\mathbb{P}_{\lambda_4,\pi}$ forces $\text{non}(\mathcal{M}) \leq \lambda_0$ by using the sequence $\langle B_\zeta^{\lambda_0} : \zeta < \lambda_0 \rangle$, and it forces $\lambda_3 \leq \text{cov}(\mathcal{M})$ by using the sequence $\langle B_\zeta^{\lambda_3} : \zeta < \lambda_3 \rangle$.

The small σ -centered iterands ensure that $\mathbb{P}_{\lambda_4,\pi}$ forces $\lambda_0 \leq \mathfrak{p}$, while the Hechler posets ensure $\mathfrak{d} \leq \lambda_3$. See the cited reference for $\text{cof}(\mathcal{N}) = \mathfrak{c} = \lambda_4$.

(a): Assume $\lambda_0 \leq \lambda \leq \lambda_3$ regular and $\lambda_4^{<\lambda} = \lambda_4$. By considering the sequence $\langle B_\zeta^{\lambda_4\lambda} : \zeta < \lambda_4\lambda \rangle$, we can use Theorem 7.5 to get that $\mathbb{P}_{\lambda_4,\pi}$ forces that there is a maximal ideal J such that $\mathfrak{sl}_e(\star, J) = \mathfrak{sl}_t^\perp(h, J) =$

$$\mathfrak{sl}_t(h, J) = \lambda.$$

(b): By (a) applied to λ_1 and λ_2 , in $V_{\lambda_4, \pi}$ there are maximal ideals J_1 and J_2 such that $\mathfrak{sl}_e(\star, J_1) = \mathfrak{sl}_t^\perp(h_1, J_1) = \mathfrak{sl}_t(h_1, J_1) = \lambda_1$ and $\mathfrak{sl}_e(\star, J_2) = \mathfrak{sl}_t^\perp(h_2, J_2) = \mathfrak{sl}_t(h_2, J_2) = \lambda_2$ for any J_i -unbounded h_i and $i \in \{1, 2\}$. Let $J' := J_1 \oplus J_2$. As any $h: \omega \oplus \omega \rightarrow \omega$ with $\lim^{J'} h = \infty$ has the form $h = h_1 \oplus h_2$ with $\lim^{J_1} h_1 = \lim^{J_2} h_2 = \infty$, by [Corollary 5.6](#) we conclude that $\mathfrak{sl}_e(\star, J') = \mathfrak{sl}_t^\perp(h, J') = \mathfrak{sl}_e(h, J') = \lambda_1$ and $\mathfrak{sl}_t(\star, J') = \mathfrak{sl}_e^\perp(h, J') = \mathfrak{sl}_t(h, J') = \lambda_2$. \square

Theorem 7.17 (cf. [\[Mej19, Thm. 4.6 \(e\)\]](#)). *Let $\lambda_0 \geq \aleph_1$ be a regular cardinal and $\lambda_3 \leq \lambda_4$ cardinals such that $\text{cof}([\lambda_3]^{<\lambda_0}) = \lambda_3$ and $\lambda_4 = \lambda_4^{<\lambda_0}$. Then there is a ccc poset forcing that $\mathfrak{p} = \text{non}(\mathcal{M}) = \lambda_0$, $\text{cov}(\mathcal{M}) = \text{cof}(\mathcal{N}) = \lambda_3$, $\lambda_4 = \mathfrak{c}$, and:*

- (a) *For any regular cardinal λ such that $\lambda_0 \leq \lambda \leq \lambda_3$ and $\lambda_4^{<\lambda} = \lambda_4$, there is some maximal ideal J such that $\mathfrak{sl}_e(\star, J) = \mathfrak{sl}_t^\perp(h, J) = \mathfrak{sl}_t(h, J) = \lambda$ for any J -unbounded $h \in {}^\omega\omega$ (see [Figure 16](#)). We can remove $\mathfrak{sl}_e(\star, J)$ when the assumption $\lambda_4^{<\lambda} = \lambda_4$ is removed.*
- (b) *For any regular cardinals λ_1 and λ_2 such that $\lambda_0 \leq \lambda_1 \leq \lambda_2 \leq \lambda_3$ and $\lambda_4^{<\lambda_2} = \lambda_4$, there is some ideal J' satisfying $\mathfrak{sl}_e(\star, J') = \mathfrak{sl}_t^\perp(h, J') = \mathfrak{sl}_e(h, J') = \lambda_1$ and $\mathfrak{sl}_t(\star, J') = \mathfrak{sl}_e^\perp(h, J') = \mathfrak{sl}_t(h, J') = \lambda_2$ for any $h \in {}^\omega\omega$ such that $\lim^{J'} h = \infty$ (see [Figure 16](#)). We can remove $\mathfrak{sl}_e(\star, J')$ and $\mathfrak{sl}_t(\star, J')$ when the assumption $\lambda_4^{<\lambda_2} = \lambda_4$ is removed.*

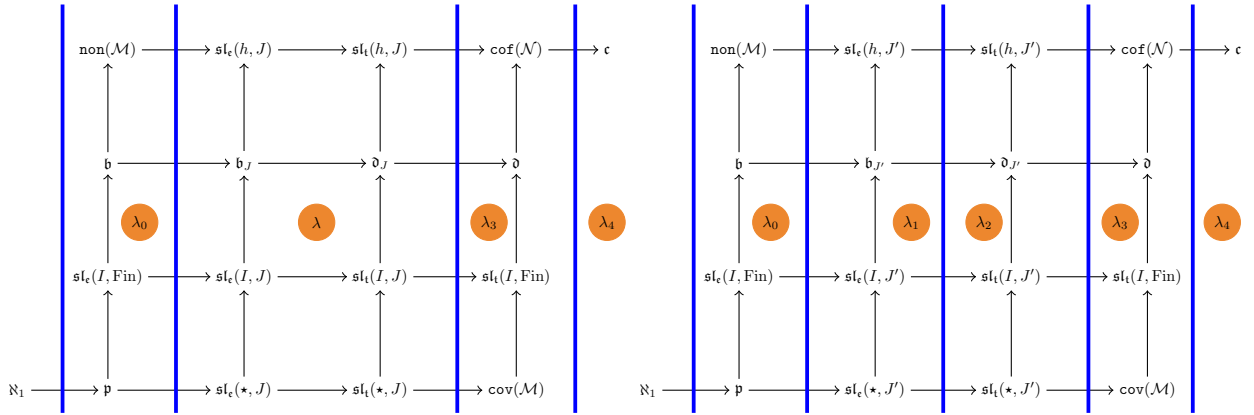

Figure 16: Constellation forced in [Theorem 7.17](#).

Proof. Proceed exactly as in the proof of [Theorem 7.16](#), but use amoeba forcing instead of \mathbb{D} to guarantee that $\text{cof}(\mathcal{N}) \leq \lambda_3$. \square

Theorem 7.18 (cf. [\[BCM21, Thm. 5.3\]](#)). *Let $\lambda_0 \leq \lambda_1 \leq \lambda_2$ be uncountable regular cardinals and let λ_3 be a cardinal such that $\lambda_2 \leq \lambda_3 = \lambda_3^{<\lambda_2}$. Then there is some ccc poset forcing that $\mathfrak{p} = \mathfrak{b} = \lambda_0$, $\text{non}(\mathcal{M}) = \lambda_1$, $\text{cov}(\mathcal{M}) = \lambda_2$, $\mathfrak{d} = \text{cof}(\mathcal{N}) = \mathfrak{c} = \lambda_3$, and:*

- (a) *there is some maximal ideal J_1 such that $\mathfrak{sl}_e(\star, J_1) = \mathfrak{sl}_t^\perp(h, J_1) = \mathfrak{sl}_t(h, J_1) = \lambda_1$ for any J_1 -unbounded h (see [Figure 17](#)),*
- (b) *there is some maximal ideal J_2 such that $\mathfrak{sl}_e(\star, J_2) = \mathfrak{sl}_t^\perp(h, J_2) = \mathfrak{sl}_t(h, J_2) = \lambda_2$ for any J_2 -unbounded h (see [Figure 17](#)), and*
- (c) *there is some ideal J such that $\mathfrak{sl}_e(\star, J) = \mathfrak{sl}_t^\perp(h, J) = \mathfrak{sl}_e(h, J) = \lambda_1$ and $\mathfrak{sl}_t(\star, J) = \mathfrak{sl}_e^\perp(h, J) = \mathfrak{sl}_t(h, J) = \lambda_2$ for any $h \in {}^\omega\omega$ such that $\lim^J h = \infty$ (see [Figure 18](#)).*

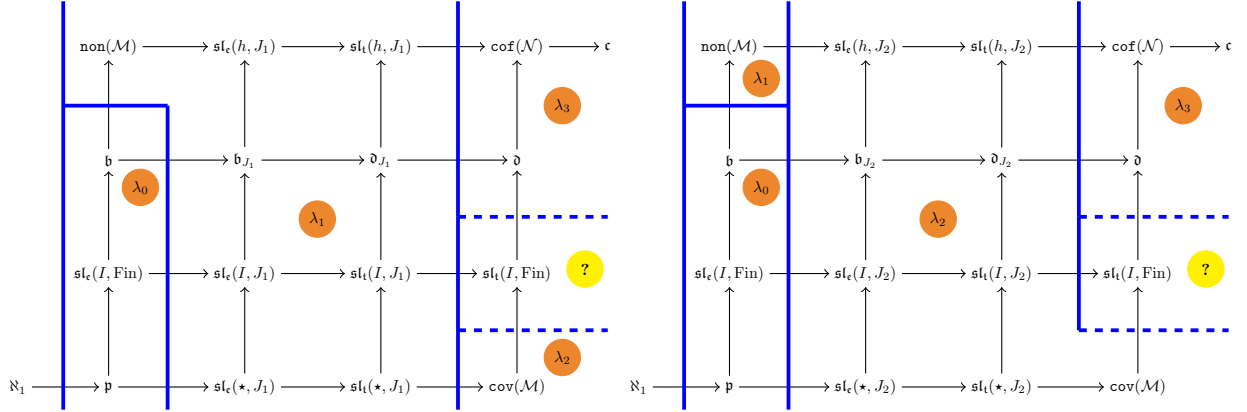

Figure 17: Two separations of the cardinals for the two idelals J_1 and J_2 in [Theorem 7.18](#). On the left, we have the constellation of (a), and on the right the constellation of (b). The dotted lines indicate that $\lambda_2 \leq \mathfrak{sl}_t(I, \text{Fin}) \leq \lambda_3$, whose exact value is unclear.

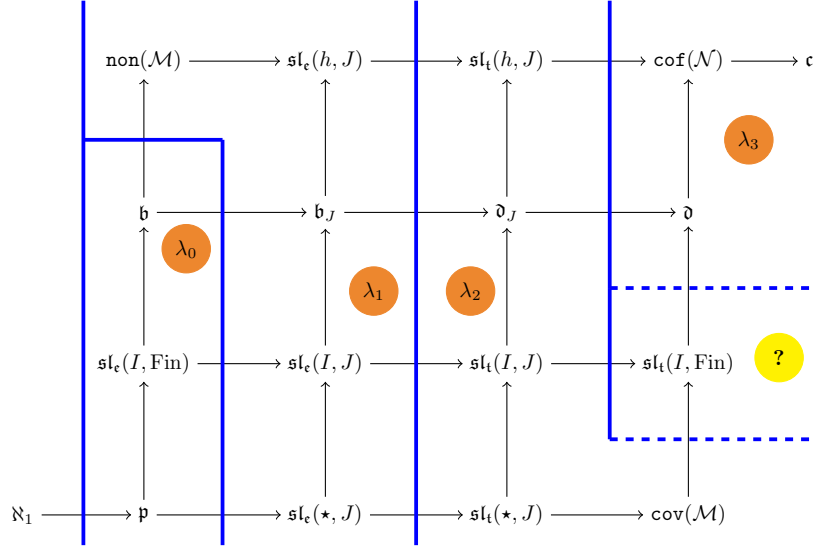

Figure 18: Constellation forced in [Theorem 7.18 \(c\)](#). The dotted lines indicate that $\lambda_2 \leq \mathfrak{sl}_t(I, \text{Fin}) \leq \lambda_3$, whose exact value is unclear.

Proof. Construct a simple coherent system on $I^s = \lambda_3\lambda_2 + 1$, ordered by \leq , of FS iterations of length $\pi := \lambda_3\lambda_2\lambda_1$ (ordinal product), where $\mathbb{P}_{\eta,1} := \mathbb{C}_\eta$ for all $\eta \leq \lambda_3\lambda_2$, whose iterands for $0 < \xi < \pi$ are determined by:

- all σ -centered posets of size $< \lambda_0$;
- all σ -centered subsets of Hechler forcing of size $< \lambda_1$; and
- $\dot{\mathbb{Q}}_\xi := \mathbb{E}^{V_{\Delta(\xi), \xi}}$.

The iteration is constructed via book-keeping as in [\[BCM21, Thm. 5.3\]](#) and the previous proofs. Then $\mathbb{P}_{\lambda_3\lambda_2, \pi}$ forces $\mathfrak{p} = \mathfrak{b} = \lambda_0$, $\text{non}(\mathcal{M}) = \lambda_1$, $\text{cov}(\mathcal{M}) = \lambda_2$, and $\mathfrak{d} = \text{cof}(\mathcal{N}) = \mathfrak{c} = \lambda_3$ (details can be found in the cited reference). Since $\mathbb{P}_{\lambda_3\lambda_2, \pi}$ is obtained by the FS iteration $\langle \mathbb{P}_{\lambda_3\lambda_2, \xi}, \dot{\mathbb{Q}}_{\lambda_3\lambda_2, \xi} : \xi < \pi \rangle$ and $\text{cf}(\pi) = \lambda_1$, by applying [Corollary 7.6](#) we obtain that $\mathbb{P}_{\lambda_3\lambda_2, \pi}$ forces that there is a maximal ideal J_1 such that $\mathfrak{sl}_e(\star, J_1) = \mathfrak{sl}_t^\perp(h, J_1) = \mathfrak{sl}_t(h, J_1) = \lambda_1$ for any J_1 -unbounded $h \in {}^\omega\omega$.

(b): For each $\zeta < \lambda_3 \lambda_2$, $\mathbb{P}_{\lambda_3 \lambda_2, \zeta+1}$ adds a Cohen real over $V_{\lambda_3 \lambda_2, \zeta+1}$. Then, by [Theorem 7.15](#) applied to $\langle \zeta : \zeta < \lambda_3 \lambda_2 \rangle$, we have that $\mathbb{P}_{\lambda_3 \lambda_2, \pi}$ forces that there is a maximal ideal J_2 on ω such that $\mathfrak{sl}_e(\star, J_2) = \mathfrak{sl}_t^\perp(h, J_2) = \mathfrak{sl}_t(h, J_2) = \lambda_2$ for any J_2 -unbounded $h \in {}^\omega \omega$.

(c): Use $J = J_1 \oplus J_2$ exactly as in the previous results. □

8. Discussions and open problems

By [Theorem 4.14](#) and [Theorem 4.21](#), if J has the Baire property then J does not affect the values of many slalom numbers, i.e., a slalom number with J is equal to the one with Fin . For instance, if h is reasonable, then $\mathfrak{sl}_e(h, J) = \mathfrak{sl}_e(h, \text{Fin})$ and $\mathfrak{sl}_t(h, J) = \mathfrak{sl}_t(h, \text{Fin})$. However, for two instances of slalom numbers, we were not able to settle such an equality.

Question 8.1. *Do we have that $\mathfrak{sl}_e(I, J) = \mathfrak{sl}_e(I, \text{Fin})$ and $\mathfrak{sl}_e(\star, J) = \mathfrak{sl}_e(\star, \text{Fin})$ when J has the Baire property?*

From [Lemma 4.19](#), we have a good understanding on when $\mathfrak{sl}_e(b, h, J)$ is finite or not, and that it can never be \aleph_0 . However, the situation for $\mathfrak{sl}_t(b, h, J)$ is unclear.

Question 8.2. *Do we have examples of b, h and J such that $\mathfrak{sl}_t(b, h, J) = \aleph_0$?*

Question 8.3. *Is there a suitable characterization of $\mathfrak{sl}_t(b, h, J) = k$ for any natural number $k \geq 3$?*

Concerning [Fact 5.4](#), we wonder about the following problem. It has a positive answer when either $\mathfrak{sl}_t(b_0, h_0, J_0)$ or $\mathfrak{sl}_t(b_1, h_1, J_1)$ is infinite, but it is unclear when both are finite (and larger than 1).

Question 8.4. *Do we have $\mathfrak{sl}_t(b_0 \oplus b_1, h_0 \oplus h_1, J_0 \oplus J_1) = \mathfrak{sl}_t(b_0, h_0, J_0) \cdot \mathfrak{sl}_t(b_1, h_1, J_1)$?*

More open problems about the results of [Section 5](#) are:

Question 8.5. *Let J_0 and J_1 be ideals on ω .*

- (1) *For which $h_0 \in {}^\omega \omega$ do we have $\mathfrak{sl}_e(h_0 \oplus h_0, J_0 \oplus J_1) = \mathfrak{sl}_e(h_0, J_0 \cap J_1)$? Likewise, we ask when inequalities in [Corollary 5.6 \(c\)](#) are equalities.*
- (2) *Are $\mathfrak{sl}_e(I_0 \oplus I_1, J_0) = \mathfrak{sl}_e(I_0 \cap I_1, J_0) = \max\{\mathfrak{sl}_e(I_0, J_0), \mathfrak{sl}_e(I_1, J_0)\}$ and $\mathfrak{pk}(I_0 \oplus I_1, J_0) = \mathfrak{pk}(I_0 \cap I_1, J_0) = \max\{\mathfrak{pk}(I_0, J_0), \mathfrak{pk}(I_1, J_0)\}$ for any ideals I_0 and I_1 on ω ?*
- (3) *Are $\mathfrak{sl}_e(I, J_0 \cap J_1) = \mathfrak{sl}_e(I, J_0 \oplus J_1)$, $\mathfrak{pk}(I, J_0 \cap J_1) = \mathfrak{pk}(I, J_0 \oplus J_1)$, $\mathfrak{sl}_e(\star, J_0 \cap J_1) = \mathfrak{sl}_e(\star, J_0 \oplus J_1)$, and $\mathfrak{pk}(\star, J_0 \cap J_1) = \mathfrak{pk}(\star, J_0 \oplus J_1)$ for any ideal I on ω ?*

By [Corollary 6.15](#), slalom numbers are uniformity numbers of certain selection principles. It is not known whether, in many cases, selection principles with equal critical cardinalities must be equivalent, for instance:

Question 8.6. *Is $S_1(\Gamma_h, J\text{-}\Gamma)$ equivalent to $S_1(\Gamma_h, \Gamma)$ when J has the Baire property? The same applies to $S_1(I\text{-}\Gamma, J\text{-}\Lambda)$, $S_1(\Omega, J\text{-}\Lambda)$, $S_1(\Gamma_h, J\text{-}\Lambda)$, and $S_1(\Gamma, J\text{-}\Gamma)$.*

In [Lemma 6.14](#), we show that many selection principles with \mathcal{O} in the second argument are equivalent to those with $\text{Fin}\text{-}\Lambda$ in the second argument. The same applies to their uniformity numbers. However, the following is still not clear.

Question 8.7. *Are $S_1(\Gamma_g, \mathcal{O})$ and $S_1(\Gamma_g, \text{Fin}\text{-}\Lambda)$ equivalent?*

A positive answer to the following question solves [Question 8.7](#).

Question 8.8. Are $S_1(\Gamma_g, \mathcal{O})$ and $S_1(\Gamma_{g'}, \mathcal{O})$ equivalent principles for two functions g and g' diverging to infinity? Are $S_1(\Gamma_h, \Gamma)$ and $S_1(\Gamma_1, \Gamma)$ equivalent principles when $h \geq^* 1$?

As shown in [Section 7](#), many instances of slalom numbers can be distinguished. By [Corollary 6.15](#), the same applies to the corresponding selection principles assuming inequalities between cardinal invariants. On the other hand, we do not know what happens under assumptions compatible with **CH**.

Question 8.9. If **CH** holds, is there an $S_1(\Gamma_h, \mathcal{O})$ -space which is not an $S_1(\Gamma_h, \Gamma)$ -space? The same applies to many pairs of selection principles in [Figure 9](#) and [10](#).

Any $S_1(\Gamma_1, \mathcal{O})$ -space is totally imperfect by [Theorem 6.22](#). We may ask about its further topological properties, i.e., properties of an $S_1(\Gamma_1, \mathcal{O})$ -space and even an $S_1(\Gamma_1, \Gamma)$ -space. For instance, by [\[JMSS96\]](#), any $S_1(\Gamma, \Gamma)$ -space X of reals is perfectly meager,²⁷ i.e., for any perfect set P of reals, the intersection $X \cap P$ is meager in the subspace P .

Question 8.10. Is an $S_1(\Gamma_1, \Gamma)$ -space of reals perfectly meager?

We also wonder whether we can express other classical cardinal characteristics, like $\text{add}(\mathcal{N})$, as the critical cardinality of some selection principle or other similar topological property.

Regarding [Theorem 7.9](#), we ask:

Question 8.11. Is there any model where all four rows of [Figure 6](#) are different for some pair I, J ?

It is possible to force a similar model as in [Theorem 7.9](#) but with $\aleph_1 < \mathfrak{b} < \mathfrak{d} < \text{cov}(\mathcal{N})$ (see [\[GKMS22, Sec. 5\]](#)). However, we do not know what is the effect on \mathfrak{b}_J and \mathfrak{d}_J after forcing with a random algebra. On the other hand, Canjar [\[Can88\]](#) has studied the effect on co-initialities of ultrapowers of ω after forcing with a random algebra.

Question 8.12. Can we force a constellation like in [Figure 13](#) but with $\aleph_1 < \mathfrak{b} < \mathfrak{b}_J < \mathfrak{d}_J < \mathfrak{d} < \text{cov}(\mathcal{N})$?

We still need to explore the behavior of slalom numbers in generic extensions not adding (too many) Cohen reals. Very few forcing techniques for large continuum work for this, for instance, large products of creature forcing. However, such constructions are ${}^\omega\omega$ -bounding in practice, which force $\mathfrak{d} = \aleph_1$ (over a model of **CH**). For this reason, this technique could only be used to separate cardinals on the top row of [Figure 6](#). In [\[CKM24\]](#), continuum many different values were forced for cardinals of the form $\mathfrak{sl}_t(b, h, \text{Fin})$, $\mathfrak{sl}_e(b, h, \text{Fin})$, $\mathfrak{sl}_t^\perp(b, h, \text{Fin})$, and $\mathfrak{sl}_e^\perp(b, h, \text{Fin})$. We wonder if similar results can be forced for several ideals on ω instead of Fin .

As a consequence of [Theorem 7.7](#), we can force continuum many cardinals of the form $\mathfrak{sl}_t(h, J)$, $\mathfrak{sl}_e(h, J)$, $\mathfrak{sl}_t^\perp(h, J)$ and $\mathfrak{sl}_e^\perp(h, J)$, even for any fixed h diverging to ∞ . However, we do not know whether the same is possible for fixed J and varying h .

References

- [Bar84] Tomek Bartoszyński. Additivity of measure implies additivity of category. *Trans. Amer. Math. Soc.*, 281(1):209–213, 1984.
- [Bar87] Tomek Bartoszyński. Combinatorial aspects of measure and category. *Fund. Math.*, 127(3):225–239, 1987.
- [BBFM18] Jörg Brendle, Andrew Brooke-Taylor, Sy-David Friedman, and Diana Carolina Montoya. Cichoń’s diagram for uncountable cardinals. *Israel J. Math.*, 225(2):959–1010, 2018.
- [BCM21] Jörg Brendle, Miguel A. Cardona, and Diego A. Mejía. Filter-linkedness and its effect on preservation of cardinal characteristics. *Ann. Pure Appl. Logic*, 172(1):Paper No. 102856, 30, 2021.

²⁷The notion was discovered in [\[Luz14\]](#) and is called always of the first category as well.

- [BF12] Piotr Borodulin-Nadzieja and Barnabás Farkas. Cardinal coefficients associated to certain orders on ideals. *Arch. Math. Logic*, 51(1-2):187–202, 2012.
- [BJ95] Tomek Bartoszyński and Haim Judah. *Set theory. On the structure of the real line*. A K Peters, Ltd., Wellesley, MA, 1995.
- [Bla10] Andreas Blass. Combinatorial cardinal characteristics of the continuum. In *Handbook of Set Theory. Vols. 1, 2, 3*, pages 395–489. Springer, Dordrecht, 2010.
- [BM99] Andreas Blass and Heike Mildnerberger. On the cofinality of ultrapowers. *J. Symbolic Logic*, 64(2):727–736, 1999.
- [BM14] Jörg Brendle and Diego Alejandro Mejía. Rothberger gaps in fragmented ideals. *Fund. Math.*, 227(1):35–68, 2014.
- [BS99] Jörg Brendle and Saharon Shelah. Ultrafilters on ω —their ideals and their cardinal characteristics. *Trans. Amer. Math. Soc.*, 351(7):2643–2674, 1999.
- [BS23] Jörg Brendle and Corey Bacal Switzer. Higher dimensional cardinal characteristics for sets of functions II. *J. Symb. Log.*, 88(4):1421–1442, 2023.
- [BŠZ23] Serhii Bardyla, Jaroslav Šupina, and Lyubomyr Zdomskyy. Ideal approach to convergence in functional spaces. *Trans. Amer. Math. Soc.*, 376(12):8495–8528, 2023.
- [Buk11] Lev Bukovský. *The Structure of the Real Line*, volume 71 of *Instytut Matematyczny Polskiej Akademii Nauk. Monografie Matematyczne (New Series) [Mathematics Institute of the Polish Academy of Sciences. Mathematical Monographs (New Series)]*. Birkhäuser/Springer Basel AG, Basel, 2011.
- [Buk19] Lev Bukovský. Selection principle S_1 and combinatorics of open covers. *Topology Appl.*, 258:239–250, 2019.
- [Can88] Michael Canjar. Countable ultrapowers without CH. *Ann. Pure Appl. Logic*, 37(1):1–79, 1988.
- [Car23] Miguel A. Cardona. A friendly iteration forcing that the four cardinal characteristics of \mathcal{E} can be pairwise different. *Colloq. Math.*, 173(1):123–157, 2023.
- [CKM24] Miguel A. Cardona, Lukas Daniel Klausner, and Diego A. Mejía. Continuum many different things: localisation, anti-localisation and Yorioka ideals. *Ann. Pure Appl. Logic*, 175(7):Paper No. 103453, 58, 2024.
- [CM19] Miguel A. Cardona and Diego A. Mejía. On cardinal characteristics of Yorioka ideals. *Math. Log. Q.*, 65(2):170–199, 2019.
- [CM22] Miguel A. Cardona and Diego A. Mejía. Forcing constellations of Cichoń’s diagram by using the Tukey order. *Kyōto Daigaku Sūrikaiseki Kenkyūsho Kōkyūroku*, 2213:14–47, 2022. [arXiv:2203.00615](https://arxiv.org/abs/2203.00615).
- [CM23] Miguel A. Cardona and Diego A. Mejía. Localization and anti-localization cardinals. *Kyōto Daigaku Sūrikaiseki Kenkyūsho Kōkyūroku*, 2261:47–77, 2023. [arXiv:2305.03248](https://arxiv.org/abs/2305.03248).
- [CM25] Miguel A. Cardona and Diego A. Mejía. More about the cofinality and the covering of the ideal of strong measure zero sets. *Ann. Pure Appl. Logic*, 176(4):Paper No. 103537, 31, 2025.
- [DKC16] Pratulananda Das, Ljubiša D. R. Kočinac, and Debraj Chandra. Some remarks on open covers and selection principles using ideals. *Topology Appl.*, 202:183–193, 2016.
- [Far00] Ilijas Farah. Analytic quotients: theory of liftings for quotients over analytic ideals on the integers. *Mem. Amer. Math. Soc.*, 148(702):xvi+177, 2000.
- [FFMM18] Vera Fischer, Sy D. Friedman, Diego A. Mejía, and Diana C. Montoya. Coherent systems of finite support iterations. *J. Symb. Log.*, 83(1):208–236, 2018.
- [FK22] Rafał Filipów and Adam Kwela. Yet another ideal version of the bounding number. *J. Symb. Log.*, 87(3):1065–1092, 2022.
- [For10] Matthew Foreman. Ideals and generic elementary embeddings. In *Handbook of set theory. Vols. 1, 2, 3*, pages 885–1147. Springer, Dordrecht, 2010.
- [FS09] Barnabás Farkas and Lajos Soukup. More on cardinal invariants of analytic P -ideals. *Comment. Math. Univ. Carolin.*, 50(2):281–295, 2009.
- [GKMS21] Martin Goldstern, Jakob Kellner, Diego A. Mejía, and Saharon Shelah. Preservation of splitting families and cardinal characteristics of the continuum. *Israel J. Math.*, 246(1):73–129, 2021.
- [GKMS22] Martin Goldstern, Jakob Kellner, Diego A. Mejía, and Saharon Shelah. Controlling classical cardinal characteristics while collapsing cardinals. *Colloq. Math.*, 170(1):115–144, 2022.
- [GM23] Viera Gavalová and Diego Alejandro Mejía. Lebesgue measure zero modulo ideals on the natural numbers. *J. Symb. Log.*, pages 1–30, 2023. Published online, [doi:10.1017/jsl.2023.97](https://doi.org/10.1017/jsl.2023.97).
- [GN82] J. Gerlits and Zs. Nagy. Some properties of $C(X)$. I. *Topology Appl.*, 14(2):151–161, 1982.
- [GS93] Martin Goldstern and Saharon Shelah. Many simple cardinal invariants. *Arch. Math. Logic*, 32(3):203–221, 1993.
- [HH07] Fernando Hernández-Hernández and Michael Hrušák. Cardinal invariants of analytic P -ideals. *Canad. J. Math.*, 59(3):575–595, 2007.
- [Hru11] Michael Hrušák. Combinatorics of filters and ideals. In *Set theory and its applications*, volume 533 of *Contemp. Math.*, pages 29–69. Amer. Math. Soc., Providence, RI, 2011.
- [HST22] Karen Bakke Haga, David Schrittesser, and Asger Törnquist. Maximal almost disjoint families, determinacy, and forcing. *J. Math. Log.*, 22(1):Paper No. 2150026, 42, 2022.
- [JMSS96] Winfried Just, Arnold W. Miller, Marion Scheepers, and Paul J. Szeptycki. The combinatorics of open covers. II. *Topology Appl.*, 73(3):241–266, 1996.
- [Kel08] Jakob Kellner. Even more simple cardinal invariants. *Arch. Math. Logic*, 47(5):503–515, 2008.
- [KM22] Lukas Daniel Klausner and Diego Alejandro Mejía. Many different uniformity numbers of Yorioka ideals. *Arch. Math. Logic*, 61(5-6):653–683, 2022.
- [KO14] Shizuo Kamo and Noboru Osuga. Many different covering numbers of Yorioka’s ideals. *Arch. Math. Logic*, 53(1-2):43–56, 2014.
- [KS09] Jakob Kellner and Saharon Shelah. Decisive creatures and large continuum. *J. Symbolic Logic*, 74(1):73–104,

- 2009.
- [KS12] Jakob Kellner and Saharon Shelah. Creature forcing and large continuum: the joy of halving. *Arch. Math. Logic*, 51(1-2):49–70, 2012.
 - [Kur66] K. Kuratovskii. *Topology. Volume I*. Izdat. “Mir”, Moscow, 1966. Translated from the English by M. Ja. Antonovskii, With a preface by P. S. Aleksandrov.
 - [Luz14] N.N. Luzin. Sur un problème de M. Baire. *C. R. Acad. Sci. Paris*, 158:1258–1261, 1914.
 - [Mej13] Diego Alejandro Mejía. Matrix iterations and Cichoń’s diagram. *Arch. Math. Logic*, 52(3-4):261–278, 2013.
 - [Mej19] Diego A. Mejía. Matrix iterations with vertical support restrictions. In *Proceedings of the 14th and 15th Asian Logic Conferences*, pages 213–248. World Sci. Publ., Hackensack, NJ, 2019. [arXiv:1803.05102](#).
 - [Mez09] David Meza Alcántara. *Ideals and filters on countable sets*. PhD thesis, Universidad Nacional Autónoma de México, 2009.
 - [Mil82] Arnold W. Miller. A characterization of the least cardinal for which the Baire category theorem fails. *Proc. Amer. Math. Soc.*, 86(3):498–502, 1982.
 - [Mil84] Arnold W. Miller. Special subsets of the real line. In *Handbook of set-theoretic topology*, pages 201–233. North-Holland, Amsterdam, 1984.
 - [Osi18] Alexander V. Osipov. Classification of selectors for sequences of dense sets of $C_p(X)$. *Topology Appl.*, 242:20–32, 2018.
 - [Paw85] Janusz Pawlikowski. Powers of transitive bases of measure and category. *Proc. Amer. Math. Soc.*, 93(4):719–729, 1985.
 - [Rep21a] Miroslav Repický. Spaces not distinguishing ideal convergences of real-valued functions. *Real Anal. Exchange*, 46(2):367–394, 2021.
 - [Rep21b] Miroslav Repický. Spaces not distinguishing ideal convergences of real-valued functions, II. *Real Anal. Exchange*, 46(2):395–421, 2021.
 - [RS23] Dilip Raghavan and Juris Steprāns. The almost disjointness invariant for products of ideals. *Topology Appl.*, 323:Paper No. 108295, 11, 2023.
 - [Sch96] Marion Scheepers. Combinatorics of open covers. I. Ramsey theory. *Topology Appl.*, 69(1):31–62, 1996.
 - [Šot19] Viera Šottová. Cardinal invariant $\lambda(\mathcal{S}, \mathcal{J})$. *Geyser Math. Cass.*, 1:64–72, 2019. (Šottová is the second author’s maiden name).
 - [Šot20] Viera Šottová. *The role of ideals in topological selection principles*. PhD thesis, Pavol Jozef Šafárik University in Košice, Faculty of Science, 2020.
 - [ŠŠ19] Viera Šottová and Jaroslav Šupina. Principle $S_1(\mathcal{P}, \mathcal{R})$: ideals and functions. *Topology Appl.*, 258:282–304, 2019.
 - [Šup16] Jaroslav Šupina. Ideal QN-spaces. *J. Math. Anal. Appl.*, 435(1):477–491, 2016.
 - [TZ08] Boaz Tsaban and Lyubomyr Zdomskyy. Scales, fields, and a problem of Hurewicz. *J. Eur. Math. Soc. (JEMS)*, 10(3):837–866, 2008.
 - [vdV25] Tristan van der Vlugt. Cardinal characteristics on bounded generalised Baire spaces. *Ann. Pure Appl. Logic*, 176(7):Paper No. 103582, 57, 2025.
 - [Š23] Jaroslav Šupina. Pseudointersection numbers, ideal slaloms, topological spaces, and cardinal inequalities. *Arch. Math. Logic*, 62(1-2):87–112, 2023.