

String Field Theory: A Review

Ashoke Sen[†] and Barton Zwiebach^{*}

[†] *International Centre for Theoretical Sciences – TIFR,
Bengaluru - 560089, India*

^{*} *Center for Theoretical Physics,
Massachusetts Institute of Technology,
Cambridge MA 02139, USA*

ashoke.sen@icts.res.in, zwiebach@mit.edu

Abstract

As of today there exist consistent, gauge-invariant string field theories describing all string theories: bosonic open and closed strings, open superstrings, heterotic strings and type II strings. The construction of these theories require algebraic ingredients, such as A_∞ and L_∞ homotopy algebras, geometric ingredients, relevant to the building of moduli spaces of Riemann surfaces and the distribution of picture changing operators, and field-theoretic ingredients, involving two-dimensional CFT's and BCFT's and Batalin-Vilkovisky quantization. Applications of string field theory include the description of non-perturbative phenomena such as tachyon condensation and classical solutions, and the resolution of a number of ambiguities that bedevil the world-sheet formulation of perturbative string theory. It also allows, given a proper definition of contours of integration for momenta, for a proof of unitarity and a clear understanding of the ultraviolet finiteness of the theory. In this article we review these developments.

This is an expanded version of the review written for the “Handbook of Quantum Gravity”, eds. C. Bambi, L. Modesto and I. Shapiro.

Contents

1	Introduction	2
2	Glossary of symbols	5
3	Background material	7
3.1	World-sheet conventions	7
3.2	Bosonic string amplitudes and their off-shell generalization	14
3.3	Amplitudes in closed superstring theories	19
3.4	Amplitudes in open-closed string theory	22
3.5	Signs of forms in $\widehat{\mathcal{P}}_{g,b,n_c,n_o}$	27
3.6	Batalin-Vilkovisky formalism	30
4	Bosonic and superstring field theories	32
4.1	Closed bosonic string field theory	33
4.2	Type II superstring field theory	37
4.3	Heterotic string field theory	40
4.4	Tree-level open string field theory	40
4.5	Open-closed string field theory	44
4.6	Kinetic term for massless open string fields	49
4.7	Kinetic term for massless closed string fields	51
5	Properties of string field theory	55
5.1	World-sheet string amplitudes from string field theory	55
5.2	Results for special amplitudes	59
5.3	1PI effective action	61
5.4	Wilsonian effective action	63
5.5	Equivalence of different string field theories	65
5.6	Background independence	66
5.7	Dilaton theorem	67
6	Algebraic structures underlying string field theories	72
6.1	A_∞ algebras and classical open string field theory	73
6.2	Relation between different classical open SFT formalisms	77
6.3	L_∞ algebras and classical closed string field theory	79
6.4	From A_∞ to L_∞	82
6.5	Quantum L_∞ algebra	83
6.6	Open-closed string field theory	84
6.7	Homotopy transfer	85
7	String vertices	88
7.1	BV structures on moduli spaces	89
7.2	BV structures on CFT	93
7.3	Geometric BV master equation and string field theory master equation	95
7.4	Deligne-Mumford compactification, noded surfaces and Feynman diagrams	97
7.5	Existence of string vertices	99

7.6	Uniqueness of string vertices up to canonical transformations	100
7.7	Open-closed vertices and their main identity	102
7.8	Minimal area string vertices: Witten vertex and closed string polyhedra	104
7.9	String vertices from hyperbolic metrics	113
7.10	String vertices for open superstring field theory	116
7.11	Some subtleties in quantum closed superstring field theory	119
8	Superstring field theories in the large Hilbert space	120
8.1	Berkovits open superstring field theory in the NS sector	120
8.2	Heterotic string field theory in the NS sector	123
8.3	Type II string field theory in the NS–NS sector	125
8.4	Open superstring field theory in the Ramond sector	126
9	Applications of string field theory	127
9.1	Tachyon condensation	128
9.2	Tachyon vacuum solution and the $\mathcal{K}bc$ algebra.	131
9.3	Mass renormalization and vacuum shift	137
9.4	D-instanton contribution to string amplitudes	143
9.5	D-instanton induced effective action	150
9.6	Unitarity and crossing symmetry	152
9.7	UV finiteness	156
10	Some future directions	157

1 Introduction

The modern era of string field theory began in 1984, when Warren Siegel was able to write Lorentz-covariant, gauge-fixed, free field theories for open and closed bosonic strings [1]. His work used the previously discussed BRST first-quantization of the string by Kato and Ogawa [2]. String field theories in the light-cone gauge had been formulated in the seventies by Kaku and Kikkawa [3] based on the interacting string picture developed by Mandelstam [4]. Siegel’s work was the starting point in the formulation of gauge-invariant string field theory – modern string field theory. As of 2024, gauge-invariant string field theory has been studied for forty years.

The first challenge in this subject, of course, was the formulation of the various string field theories. For bosonic strings, this includes classical open string field theory, classical and quantum closed string field theory, and open-closed string field theory – by definition a quantum theory. For supersymmetric strings, there were separate complications with the Neveu-Schwarz (NS) and the Ramond (R) sectors. Classical open superstrings have both sectors. Heterotic strings also have both sectors, and type II strings combine these two sectors to form NS–NS, NS–R, R–NS, and R–R sectors. Much had to be learned to accomplish the construction of the various string field theories. Fully interacting, quantum *bosonic* string field theories were essentially complete by 1993. Superstrings brought new challenges. By 2015, however, we have had consistent gauge-invariant string field theories for all supersymmetric closed strings. The construction of open-closed superstring field theory was completed a few years later. This is not to say these formulations are final – there are a number of works with partial success in different alternative directions, but the complete theories we now have pass all known consistency checks.

One of the explicit goals of string field theory was to provide a non-perturbative definition of string theory. While this goal still remains to be attained, there was a notable success in describing tachyon condensation in open string field theory, a non-perturbative phenomenon that had been a mystery since the tachyon instability had been noticed. There has also been impressive progress in the construction of analytic solutions in open string field theory – another non-perturbative construction. Admittedly, to date, string field theory has done little to help understand holography, black holes, and a number of dualities.¹ One may have also expected string field theory to provide a background independent definition of string theory. It has been proven that string field theory *has* the property of background independence, at least for backgrounds that are nearby. This property, however, is not yet *manifest* in the present formulations, and it seems that a significant new idea may be required to obtain manifestly background independent formulations. In the meantime, background independent structures have been identified in string field theory that could play an important role in future developments.

String field theory work began at the time when the rules of first-quantized string theory seemed adequate to describe perturbative string theory. Subsequent work, however, demonstrated that first-quantized rules are lacking and are sometimes ambiguous. In particular, in *first quantization* there is no systematic way to deal with infrared divergences. Additionally, there is no systematic way to deal with S-matrix elements for states that undergo mass or wave-function renormalization. String field theory, in fact, provides the first *complete* definition of string perturbation theory. This is a significant success for the theory. We will review the way in which string field theory deals with infrared divergences and mass renormalization. With the understanding that string field theory is a quantum field theory, albeit with some novel properties, it has been possible to consider in a precise way some of the usual claims about string theory. We will discuss unitarity of superstring amplitudes, reviewing the prescription for dealing with the integration contour for internal loop energies, an important recent development. Finally, string field theory puts the claim of perturbative ultraviolet finiteness of string theory in a solid footing. This is important, since the original reason for considering string theory was the hope that it would be a finite theory of quantum gravity.

Investigations into string field theory have also had an impact on mathematics. The remarkable efficiency of Batalin-Vilkovisky (BV) quantization in dealing with (most versions of) string field theory has been extended to a discovery of BV algebras at the level of Riemann surfaces, which are the counterpart of the similar structures that exist on the state space of conformal field theories. Another subject is homotopy algebras. The cubic bosonic open string field theory [5] is based on an associative vertex, but this only works for the classical theory and no cubic version seems to exist for open superstrings. The general framework for open string theory is that of homotopy-associative A_∞ algebras, where the cubic vertex fails to associate and that failure is repaired by higher vertices. Closed string field theory, at the classical level, provided the first explicit discussion of L_∞ algebras and their defining identities [6]. In this case, a Jacobi-like identity would guarantee a cubic gauge-invariant closed string field theory, but no such theory exists. For open-closed bosonic string field theory, constructed in [7–9], a new structure arises from the interplay between A_∞ and L_∞ structures. Homotopy algebras play an important role in some recent developments, helping, for example, construct effective actions via *homotopy transfer*. Finally, string field theory has helped the understanding of moduli spaces of Riemann surfaces, since the Feynman rules of the theory must build such spaces. Canonical choices of string vertices (for open and closed strings) arise via

¹In this context, one should keep in mind that the action of $\mathcal{N} = 4$ supersymmetric Yang-Mills theory also has not been used to prove the S-duality of the theory. But this does not mean that such an action is not useful.

minimal area problems, which tie the theory of quadratic differentials on Riemann surfaces, and have contributed to the understanding of systolic geometry. String vertices also arise canonically in hyperbolic geometry, where they have a particularly simple definition.

A full book would be needed to give a self-contained overview of string field theory, and in fact, an instructive introductory book has been written by H. Erbin [10]. Additionally, there are a number of reviews on various aspects of string field theory [11–18]. In this work we have tried to focus on key ideas, while dealing briefly with matters for which a number of other references exist. This review aims to be readable by graduate students, post-docs, faculty and physicists that have had exposure to string theory (bosonic strings and superstrings) and to two-dimensional conformal field theory.

In section 2 we give a glossary of the various symbols used in this review. This review begins in section 3 with background information on CFT, world-sheet fields, and the construction of string amplitudes in first quantization, both for bosonic strings and superstrings. We also sketch the basic setup of the Batalin-Vilkovisky formalism. This section reviews key facts that are needed throughout. In section 4 we attempt to give the main story of string field theory, with some of the explanation and justification postponed to later sections. So we briefly go over the full set of complete string field theories, all the bosonic ones and all the superstrings. This includes the use of an auxiliary string field that allows for the construction of consistent string field theories for the heterotic and type II theories [19,20]. This auxiliary field turns out to represent free propagating degrees of freedom; they are needed to write the action, but have no effect on the S-matrix of the interacting string fields. An auxiliary open string field is also used for the open string sector in the construction of the open-closed superstring theory given in [21]. This section concludes with very explicit calculations aimed to make some of the discussion more concrete and intuitive. We compute in detail the quadratic part of the action for the massless sector of open bosonic strings and for the massless sector of closed bosonic strings.

In section 5 we discuss some key facts and properties of string field theory. These include the construction of string amplitudes from string field theory, with particular attention to the propagators and their role in building forms on the moduli spaces of Riemann surfaces. We give a detailed discussion of the normalization of forms for integration over moduli spaces of Riemann surfaces, with particular attention to the case of open-closed string field theory, which is somewhat delicate [22]). We then discuss one-particle irreducible effective actions, and Wilsonian actions. We review how different constructions of the moduli spaces of Riemann surfaces lead to string field theories related by field redefinitions. This is followed by a brief discussion of the proof of background independence of string field theory and the dilaton theorem.

While sections 4 and 5 review the practical approach to string theory, sections 6 and 7 go into some depth on the basic mathematical tools needed to write the string field theories. The first, section 6, goes over the A_∞ construction of open string theory. For closed strings, at the classical level, we develop the structure of L_∞ algebras. We show how to pass from A_∞ to L_∞ algebras and therefore how to give an L_∞ presentation of open string field theory. At the quantum level, the L_∞ structure of the classical theory is modified to give a new structure that has been called a ‘quantum L_∞ algebra’. Open-closed structures show a nontrivial interplay between the A_∞ and L_∞ structures, with open-closed vertices allowing one to interpret the open string fields as spaces carrying a representation of the L_∞ algebra, similar to the way in which matter fields can represent the action of diffeomorphisms in general relativity. Finally, we give the homotopy algebra background to the idea of Wilsonian effective actions. The tool, called ‘homotopy transfer’ which we explain both for A_∞ and L_∞ structures, has had a number of applications. The second, section 7, focuses on the moduli

spaces $\mathcal{M}_{g,n}$ of Riemann surfaces of genus g with n punctures and the bundle $\widehat{\mathcal{P}}_{g,n}$ that includes local coordinates, defined up to a constant phase about each of the punctures. The constraint on the string vertices is the geometric version of the BV master equation, and consistent vertices generate the correct string amplitudes. We review both the string vertices that arise from a minimal area problem, resulting at genus zero in surfaces build with flat metrics and curvature singularities, as well as the string vertices that can be defined via surfaces with hyperbolic metrics. We discuss an approach to open superstring theory in which the vertices incorporate canonical insertions of picture changing operators (PCO's).

Superstring theory in the so called ‘large’ Hilbert space of the superghost CFT is the subject of section 8. The large Hilbert space is one that includes the zero mode ξ_0 of the ξ field in the construction of states. The ‘small’ Hilbert space, which does not contain such anticommuting zero mode, is the conventional state space of the theory, and all states are annihilated by η_0 , the anticommuting zero mode of the η field, with $\{\eta_0, \xi_0\} = 1$. We focus on the NS sector of open superstring, the formulation that was developed in [23,24]. The simplicity of the action, which takes a Wess-Zumino-Witten (WZW) form, lies in that no insertion of picture changing operators are needed. The string field is of picture number zero and the required picture number is supplied by η_0 (of picture number minus one) that enters the action in the same way as the BRST operator does. The NS sector of heterotic strings also admits a relatively simple construction in the large Hilbert space, using as a building block a pure gauge field of *bosonic* closed string field theory [25,26]. For type II superstrings, a construction of the NS–NS sector has been given in [27]. This work uses as an ingredient a pure gauge field of NS *heterotic strings* in an L_∞ formulation in the small Hilbert space. Such a formulation, with canonical insertion of PCO's has been given in [28] – the simpler case of an A_∞ canonical construction of open string field theory is reviewed here. We briefly consider the inclusion of the Ramond sector in this formalism [29,30].

Section 9 discusses some applications of string field theory. We examine tachyon condensation solutions – both numerical solutions using level truncation and analytical solutions using the picture of dressed surface states and the so-called Kbc algebra. We show how string field theory deals with mass renormalization and vacuum shifts. We give an introduction to the subject of D-instantons, as they are dealt with in string field theory. This is also a subject where first-quantization cannot resolve the ambiguities in D-instanton corrections to perturbative scattering amplitudes. Finally, we review the analysis of the unitarity of the string theory S-matrix, and explain the way in which string field theory makes a precise claim on the finiteness of string theory. This review concludes with Section 10, where we discuss what may be fruitful research directions in string field theory.

Throughout (most of) this review, we shall work setting $\alpha' = 1$.

2 Glossary of symbols

In this section we give a glossary of widely used symbols.

- $|0\rangle$ $SL(2, \mathbb{C})$ invariant vacuum for closed strings, $SL(2, \mathbb{R})$ invariant vacuum for open strings.
- $\langle \dots \rangle'$ correlator normalized as in (3.11)
- $\{\cdot, \cdot\}$ Batalin-Vilkovisky antibracket (3.96), antibracket for general complex (7.3)
- $\{\cdot, \cdot\}_c$ antibracket on moduli spaces via closed strings (4.8),
- $\{\cdot, \cdot\}_o$ antibracket on moduli spaces via open strings (4.41), (4.60)
- $\{\cdot, \cdot, \dots, \cdot\}$ multilinear function of string fields (4.11), (4.42), (4.61)

- $[\cdot, \cdot, \dots; \cdot, \cdot, \dots, \cdot]_c$ multilinear product of string fields giving a closed string state (4.65)
- $[\cdot, \cdot, \dots; \cdot, \cdot, \dots, \cdot]_o$ multilinear product of string fields giving an open string state (4.65)
- $[\cdot, \cdot, \dots, \cdot]$ either $[\cdot, \cdot, \dots; \cdot, \cdot, \dots, \cdot]_c$ or $[\cdot, \cdot, \dots; \cdot, \cdot, \dots, \cdot]_o$ for only closed or only open strings
- $b_0^\pm \equiv b_0 \pm \bar{b}_0$
- $|\mathbf{b}\rangle$ state inserted to create a boundary (3.81)
- $\mathcal{B}[\frac{\partial}{\partial u^i}]$ antighost insertion (3.43), (3.66)
- \mathbf{b} nilpotent operator in A_∞ and L_∞ algebras (6.4), (6.5), (6.28), (6.34)
- B the integral of the b -ghost field over the left half of the open string (9.17)
- $c_0^\pm \equiv \frac{1}{2}(c_0 \pm \bar{c}_0)$
- $d_{g,n}$ real dimension of $\mathcal{M}_{g,n}$ (3.39)
- d_{g,b,n_c,n_o} real dimension of $\mathcal{M}_{g,b,n_c,n_o}$ (3.61)
- $\chi_{g,n}$ Euler number of surfaces of type (g, n) (3.40)
- χ_{g,b,n_c,n_o} Euler number of surfaces of type (g, b, n_c, n_o) (3.62)
- Δ Batalin-Vilkovisky delta operator (3.96), (7.1), (7.10) more generally
- Δ_c delta operator for moduli spaces of surfaces via closed strings (4.8)
- Δ_o delta operator for moduli spaces of surfaces via open strings on different boundaries (4.60)
- Δ'_o delta operator for moduli spaces via open strings on the same boundary (4.60)
- $\eta^{\mu\nu} = \text{diag}(-1, 1, \dots, 1)$ Minkowski metric
- $\eta_c = -\frac{1}{2\pi i}$ constant in the normalization of forms.
- $\mathcal{F}_{g,n}$ subspace of $\widehat{\mathcal{P}}_{g,n}$ usually with $\mathcal{F}_{g,n} \rightarrow \mathcal{M}_{g,n}$ a map of degree one.
- $\mathcal{F}_{g,n}^s$ subspace of $\widehat{\mathcal{P}}_{g,n}^s$ usually with $\mathcal{F}_{g,n}^s \rightarrow \mathcal{M}_{g,n}$ a map of degree one.
- $\mathcal{F}_{g,b,n_c,n_o}^s$ subspace of $\widehat{\mathcal{P}}_{g,b,n_c,n_o}^s$ usually with $\mathcal{F}_{g,b,n_c,n_o}^s \rightarrow \mathcal{M}_{g,b,n_c,n_o}$ a map of degree one.
- g_o open string coupling (4.42)
- g_s string coupling (4.11)
- \mathcal{H}_c state space of closed string theory (4.4), (4.26), (4.36), (4.59)
- $\widetilde{\mathcal{H}}_c$ auxiliary state space of closed string theory (4.27), (4.37)
- \mathcal{H}_o state space of open string theory (4.56)
- $\widetilde{\mathcal{H}}_o$ auxiliary state space of open string theory (4.57)
- h_b, h_f the L_0 eigenvalues of bosonic, fermionic open string states on D-instanton (9.48)
- \mathcal{I} identity string field Ω_0
- K normalization constant (3.12) of the open string vacuum, related to D-brane tension (5.34)
- \mathcal{K} the integral of the stress tensor over the left half of the open string (9.15)
- $L_0^\pm \equiv L_0 \pm \bar{L}_0$
- \mathbf{L} same as \mathbf{b} for L_∞ algebra
- ℓ same as $\mathbf{L} - Q$
- $\mathcal{M}_{g,n}$ moduli space of Riemann surfaces of genus g with n punctures
- $\overline{\mathcal{M}}_{g,n}$ Deligne-Mumford compactification of $\mathcal{M}_{g,n}$
- $\mathcal{M}_{g,b,n_c,n_o}$ moduli space of surfaces of genus g , b boundaries, n_c/n_o closed/open string punctures

- \mathbf{M} same as \mathbf{b} for A_∞ algebra
- \mathbf{m} same as $\mathbf{M} - Q$
- N_{g,b,n_c,n_o} normalization constant for open-closed string forms (3.69), (3.70), (3.79)
- N exponential of the annulus partition function on the D-instanton (9.48), (9.50), (9.54)
- \mathcal{N} overall normalization for the D-instanton amplitudes given by $e^{-\mathcal{T} N}$
- $\Omega_p^{(g,n)}$ p -forms on $\widehat{\mathcal{P}}_{g,n}$ or $\widehat{\mathcal{P}}_{g,n}^s$ (3.44), (3.58)
- $\Omega_p^{(g,b,n_c,n_o)}$ p -forms on $\widehat{\mathcal{P}}_{g,b,n_c,n_o}$ or $\widehat{\mathcal{P}}_{g,b,n_c,n_o}^s$ (3.69) (3.79)
- $\widehat{\Omega}_p^{(g,b,n_c,n_o)}$ canonically normalized forms on $\widehat{\mathcal{P}}_{g,b,n_c,n_o}$ (3.68)
- $|\Omega_\alpha\rangle$ wedge state of width α Fig. 17
- $\widehat{\mathcal{P}}_{g,n}$ bundle over $\mathcal{M}_{g,n}$ with fibers giving local coordinates up to phases.
- $\widehat{\mathcal{P}}_{g,n}^s$ bundle over $\widehat{\mathcal{P}}_{g,n}$ with fibers giving locations of PCO's.
- $\widehat{\mathcal{P}}_{g,b,n_c,n_o}$ bundle over $\mathcal{M}_{g,b,n_c,n_o}$ with fibers giving local coordinates up to phases.
- $\widehat{\mathcal{P}}_{g,b,n_c,n_o}^s$ bundle over $\widehat{\mathcal{P}}_{g,b,n_c,n_o}$ with fibers giving positions for PCO's.
- Q BRST operator (3.1), (3.23), (4.86) (4.107)
- $\Psi/\widetilde{\Psi}$ closed string field/auxiliary field (4.1), (4.26), (4.27), (4.36), (4.37)
- $\Psi_o/\widetilde{\Psi}_o$ open string field in open-closed theory/auxiliary field (4.59)
- $\psi_o/\widetilde{\psi}_o$ open string field for classical bosonic theory (4.42) and classical open superstrings (4.58)
- \mathcal{T} D-brane tension (4.44), relation to K (5.34)
- $T(V)$ tensor co-algebra for A_∞ algebras (6.2)
- $T(W)$ symmetrized tensor co-algebra for L_∞ algebras (6.31)
- $\mathcal{V}_{g,n}$ string vertices for closed string theory (4.9)
- $\mathcal{V}_{g,b,n_c,n_o}$ string vertices for open-closed string theory (7.55)
- $\mathcal{X}(z), \overline{\mathcal{X}}(\bar{z})$ Grassmann even PCO's (3.24)
- $\mathcal{X}_0, \overline{\mathcal{X}}_0$ zero modes of PCO's (4.29)

3 Background material

In this section we shall review some background information on world-sheet string theory, string amplitudes and their off-shell generalization. We do this both for bosonic strings and for superstrings. This includes the definition of suitable forms for integration over the moduli spaces of Riemann surfaces, the subtleties that arise due to the inclusion of picture changing operators in superstring theory, and the issues with normalization and signs of open-closed string amplitudes. We also review the Batalin-Vilkovisky (BV) formalism that will be useful in the formulation of string field theory.

3.1 World-sheet conventions

In this subsection we shall describe the world-sheet conventions that we shall use in our analysis. The world-sheet of bosonic string theory has a matter conformal field theory (CFT) of central charge 26 and b, c, \bar{b}, \bar{c} ghost system carrying total central charge -26 . The BRST operator is given by

$$Q = \oint_0 j_B(z) dz + \oint_0 \bar{j}_B(\bar{z}) d\bar{z}, \quad (3.1)$$

where

$$j_B = c T_m + b c \partial c, \quad \bar{j}_B = \bar{c} \bar{T}_m + \bar{b} \bar{c} \bar{\partial} \bar{c}, \quad (3.2)$$

with the products $b c \partial c$ and $\bar{b} \bar{c} \bar{\partial} \bar{c}$ appropriately normal ordered. Here, T_m, \bar{T}_m denote the matter stress tensor, and \oint_0 denotes integration around the closed contour around the origin, normalized so that

$$\oint_0 \frac{dz}{z} = 1, \quad \oint_0 \frac{d\bar{z}}{\bar{z}} = 1. \quad (3.3)$$

Using the operator product expansions of the ghost fields,

$$b(z)c(w) \simeq \frac{1}{z-w}, \quad \bar{b}(\bar{z})\bar{c}(\bar{w}) \simeq \frac{1}{\bar{z}-\bar{w}}, \quad (3.4)$$

and those of the matter stress tensor,

$$\begin{aligned} T_m(z)T_m(w) &\simeq \frac{26}{2} \frac{1}{(z-w)^4} + \frac{2}{(z-w)^2} T_m(w) + \frac{1}{z-w} \partial_w T_m(w), \\ \bar{T}_m(\bar{z})\bar{T}_m(\bar{w}) &\simeq \frac{26}{2} \frac{1}{(\bar{z}-\bar{w})^4} + \frac{2}{(\bar{z}-\bar{w})^2} \bar{T}_m(\bar{w}) + \frac{1}{\bar{z}-\bar{w}} \bar{\partial}_w \bar{T}_m(\bar{w}), \end{aligned} \quad (3.5)$$

one can show that Q defined in (3.1) squares to zero: $Q^2 = \frac{1}{2}\{Q, Q\} = 0$. The ghost conformal field theory also has stress tensors T_{bc} , and $\bar{T}_{\bar{b}\bar{c}}$ given by

$$T_{bc}(z) = -\partial b c - 2b \partial c, \quad \bar{T}_{\bar{b}\bar{c}}(\bar{z}) = -\bar{\partial} \bar{b} \bar{c} - 2\bar{b} \bar{\partial} \bar{c}. \quad (3.6)$$

Although for much of our analysis we shall not need the form of the matter part of the world-sheet CFT, for a space-time interpretation we shall take the theory to be a direct sum of D free scalars X^μ describing flat, non-compact directions and a CFT of central charge $(26 - D)$. The X^μ 's satisfy the operator product expansion,

$$\partial X^\mu(z) \partial X^\nu(w) = -\frac{\eta^{\mu\nu}}{2(z-w)^2}, \quad \bar{\partial} X^\mu(\bar{z}) \bar{\partial} X^\nu(\bar{w}) = -\frac{\eta^{\mu\nu}}{2(\bar{z}-\bar{w})^2}. \quad (3.7)$$

We work in the mostly plus convention with $\eta^{\mu\nu} = \text{diag}(-1, 1, \dots, 1)$. They contribute to the matter stress tensor as follows

$$T(z) = -\eta_{\mu\nu} \partial X^\mu \partial X^\nu, \quad \bar{T}(\bar{z}) = -\eta_{\mu\nu} \bar{\partial} X^\mu \bar{\partial} X^\nu. \quad (3.8)$$

We can now define the ‘vacuum’ carrying momentum k via

$$|k\rangle \equiv e^{ik \cdot X}(0)|0\rangle, \quad (3.9)$$

where $|0\rangle$ is the $\text{SL}(2, \mathbb{C})$ invariant vacuum. We also have the out vacuum with momentum k given by $\langle k| \equiv \langle 0|I_c \circ e^{ik \cdot X}(0)$, where $I_c(z) = 1/z$ is the BPZ conjugation operator for closed strings and for any function $f(z)$ and operator O , we write $f \circ O$ for the conformal transform of O under f . We shall normalize the $\text{SL}(2, \mathbb{C})$ invariant vacuum such that

$$\langle k|c_{-1}\bar{c}_{-1}c_0\bar{c}_0c_1\bar{c}_1|k'\rangle = -(2\pi)^D \delta^{(D)}(k+k'). \quad (3.10)$$

Due to the state/operator correspondence there is one-to-one correspondence between the states $|\phi\rangle$ of the CFT and the local operators $\phi(z, \bar{z})$ in the CFT via $|\phi\rangle = \phi(0)|0\rangle$. Often times, the symbol Ψ may be used interchangeably to denote a state or a local operator in the CFT.

If the background in which we formulate string theory contains D-branes then the spectrum also contains open string states. In this case the world-sheet may also contain boundaries lying on the D-branes. The open string states are in one to one correspondence to local operators on the boundary of the world-sheet. The BRST operator for open string is obtained by restricting the integrals in (3.1) to run over the semi-circles lying in the upper half plane. Using the doubling trick that maps the anti-holomorphic fields in the upper half plane to holomorphic fields in the lower half plane, it can be expressed as only the first term on the right hand side of (3.1). In the upper half plane the boundary condition relates the oscillators of the anti-holomorphic field to those of the holomorphic fields.

When dealing with open string amplitudes on a disk we can normalize the $SL(2, \mathbb{R})$ invariant open string vacuum so that

$$\langle k|c_{-1}c_0c_1|k'\rangle' = -(2\pi)^{p+1}\delta^{(p+1)}(k+k'), \quad (3.11)$$

where $p+1$ is the number of non-compact space-time directions spanned by the D-brane and now $\langle k| = \langle 0|I_o \circ e^{ik \cdot X}(0)$ where $I_o(z) = -1/z$. We added the superscript $'$ for the following reason. The normalization chosen here is convenient to write classical open string field theory, but when considering the string field theory of open *and* closed strings, it will be more natural to use a different normalization. To see this consider the closed string one-point function on the disk using the normalization given in (3.11). The result for the one-point function of D-dimensional gravitons will be insensitive to the boundary condition along the compact directions since the graviton vertex operator only involves the scalar fields of the non-compact coordinates. On the other hand this one point function is expected to be governed by the D-brane tension which does depend on the boundary condition along the compact direction, *e.g.* our Dp brane with Neumann or Dirichlet boundary conditions along a compact dimension are different D-branes with different tensions and must give different results for the graviton one-point function. For this reason, to construct open-closed string field theory we introduce a new inner product where we multiply the right hand side of (3.11) by a constant K that is to be determined in terms of the D-brane tension:

$$\langle k|c_{-1}c_0c_1|k'\rangle = -(2\pi)^{p+1} K\delta^{(p+1)}(k+k'). \quad (3.12)$$

This overlap has no prime superscript. The precise relation between K and the D-brane tension will be discussed in section 5.2. While discussing disk correlation functions, we shall use the $\langle \rangle'$ if we use the normalization (3.11) and $\langle \rangle$ if we use the normalization (3.12).

Since $Q^2 = 0$, we can introduce the notion of BRST cohomology. We take the space of states that are annihilated by Q and declare two states to be equivalent if they differ by a state of the form $Q|s\rangle$, for some state $|s\rangle$. The states spanning such space are the elements of the BRST cohomology. For open bosonic strings, the physical states are in one to one correspondence with the elements of the BRST cohomology at ghost number one.

For closed bosonic strings the relevant state space is not the original CFT space \mathcal{H}' but rather a restricted subspace $\mathcal{H}_c \subset \mathcal{H}'$ spanned by states satisfying the ‘level-matching’ conditions:

$$|s\rangle \in \mathcal{H}_c \quad \text{iff} \quad b_0^-|s\rangle = 0, \quad L_0^-|s\rangle = 0, \quad (3.13)$$

where

$$b_0^\pm = b_0 \pm \bar{b}_0, \quad L_0^\pm = L_0 \pm \bar{L}_0, \quad c_0^\pm = (c_0 \pm \bar{c}_0)/2. \quad (3.14)$$

These constraints are needed to define consistent off-shell amplitudes for the states. The *physical* closed string states are in one to one correspondence to the cohomology of Q in \mathcal{H}_c at ghost number

two. For generic momentum this agrees with the cohomology in the full unconstrained space \mathcal{H}' , but there are important differences at zero momentum. In particular, the zero-momentum dilaton is a cohomology class in \mathcal{H}_c but happens to be trivial in \mathcal{H}' . For generic momentum, the representative elements of BRST cohomology can be taken to be of the form $c\bar{c}W$ where W is a dimension (1,1) primary operator in the matter CFT. It is not necessary to choose it this way, however, and the procedure for computing string theory amplitudes that we shall describe in section 3.2 does not rely on this choice.

Recall that in any CFT we have the bilinear BPZ inner product. To define it one needs the notion of the BPZ dual state: associated to a state $|B\rangle = B(0)|0\rangle$, obtained by acting with the $B(z)$ operator on the ‘past’ $SL(2, \mathbb{C})$ vacuum $|0\rangle$ at $z = 0$, we have the BPZ dual state $\langle B| \equiv \langle 0|I_c \circ B(0)$ acting on the ‘future’ $SL(2, \mathbb{C})$ vacuum $\langle 0|$ at $z = \infty$, with insertion of the operator $B(z)$ using the inversion map $I_c(z) = 1/z$. The bilinear BPZ inner product of two states $|A\rangle$ and $|B\rangle$ is simply the overlap $\langle A|B\rangle$. In any conformal field theory this inner product is non-degenerate: if $\langle A|B\rangle = 0$ for all $|A\rangle$, then $|B\rangle = 0$. In particular, the BPZ inner product is non-degenerate in \mathcal{H}' . For future reference we note that for open strings we have a similar definition of BPZ inner product except that the map $I_c(z)$ is replaced by $I_o(z) = -1/z$ in order to ensure that it is an $SL(2, R)$ transformation.

If both $|A\rangle$ and $|B\rangle$ are annihilated by b_0^- , the dual states $\langle A|$ and $\langle B|$ are also annihilated by b_0^- and then we find $\langle A|B\rangle = 0$. Indeed, noticing that $\{c_0^-, b_0^-\} = 1$, we have $\langle A|B\rangle = \langle A|(c_0^- b_0^- + b_0^- c_0^-)|B\rangle = 0$, with the first term killing the ket and the second term killing the bra. This deficiency is fixed by defining an alternative bilinear inner product $\langle \cdot, \cdot \rangle$ suitable for \mathcal{H}_c :

$$\langle A, B \rangle \equiv \langle A|c_0^-|B\rangle \quad A, B \in \mathcal{H}_c. \quad (3.15)$$

Note that any $|A'\rangle \in \mathcal{H}'$ can be written as $|A'\rangle = |A\rangle + c_0^-|a\rangle$, with $|A\rangle, |a\rangle \in \mathcal{H}_c$. Moreover $\langle A', B \rangle = \langle A, B \rangle$, because the part of the state A' not annihilated by b_0^- drops out. We claim that the above inner product is non-degenerate in the constrained space \mathcal{H}_c . We see this as follows. Suppose $\langle A, B \rangle = 0$ for *all* $|A\rangle$ killed by b_0^- , and for $b_0^-|B\rangle = 0$. By the above remark, this means that $\langle A', B \rangle = 0$ for *all* $|A'\rangle \in \mathcal{H}'$. By the non-degeneracy of the BPZ inner product on \mathcal{H}' , this implies $c_0^-|B\rangle = 0$. Acting on this with b_0^- and since $b_0^-|B\rangle = 0$, we conclude that $|B\rangle = 0$. This establishes the claimed non-degeneracy on \mathcal{H}_c .

For open strings we do not need any c_0^- insertion in the definition of the inner product, it is simply the BPZ inner product. For uniformity of notation, however, we shall define

$$\langle A, B \rangle' \equiv \langle A|B\rangle', \quad \langle A, B \rangle \equiv \langle A|B\rangle. \quad (3.16)$$

It should be possible to tell from the context if one is doing open or closed string theory.

In the type IIA or IIB string theory, we also have $\beta, \gamma, \bar{\beta}, \bar{\gamma}$ bosonic ghosts and the matter part of the world-sheet CFT has central charge 15. We shall describe some of the properties of the holomorphic sector of the world-sheet CFT, keeping in mind that an identical set of relations hold also for the anti-holomorphic fields. We can bosonize the β, γ system in terms of a pair of fermions (ξ, η) and a scalar ϕ as [31]

$$\gamma = \eta e^\phi, \quad \beta = \partial\xi e^{-\phi}, \quad \delta(\gamma) = e^{-\phi}, \quad \delta(\beta) = e^\phi. \quad (3.17)$$

We recall that the conformal dimensions of these fields are as follows:

$$[\gamma] = -\frac{1}{2}, \quad [\beta] = \frac{3}{2}, \quad [\eta] = 1, \quad [\xi] = 0, \quad [\phi] = 0, \quad [e^{q\phi}] = -\frac{1}{2}q(q+2). \quad (3.18)$$

The basic operator products are:

$$\xi(z)\eta(w) \simeq \frac{1}{z-w}, \quad \partial\phi(z)\partial\phi(w) \simeq -\frac{1}{(z-w)^2}, \quad e^{q_1\phi}(z)e^{q_2\phi}(w) \simeq (z-w)^{-q_1q_2}e^{(q_1+q_2)\phi}(w). \quad (3.19)$$

The energy momentum tensor of the (β, γ) system is:

$$T_{\beta\gamma} = \frac{3}{2}\beta\partial\gamma + \frac{1}{2}\gamma\partial\beta = T_{\xi\eta} + T_\phi, \quad T_{\xi\eta} = -\eta\partial\xi, \quad T_\phi = -\frac{1}{2}\partial\phi\partial\phi - \partial^2\phi. \quad (3.20)$$

In the matter sector, besides the stress tensor T_m , we also have the dimension 3/2 superpartner T_F of the stress tensor, satisfying the operator product expansion:

$$\begin{aligned} T_m(z)T_m(w) &\simeq \frac{15}{2} \frac{1}{(z-w)^4} + \frac{2}{(z-w)^2}T_m(w) + \frac{1}{z-w} \partial_w T_m(w), \\ T_F(z)T_F(w) &\simeq \frac{5}{2} \frac{1}{(z-w)^3} + \frac{1}{2} \frac{1}{z-w} T_m(w), \\ T_m(z)T_F(w) &\simeq \frac{3}{2} \frac{1}{(z-w)^2} T_F(w) + \frac{1}{z-w} T_F(w). \end{aligned} \quad (3.21)$$

When we have D non-compact flat directions, the matter sector contains D free bosons X^μ as in the case of bosonic string theory and also D free fermions ψ^μ with operator product expansion:

$$\psi^\mu(z)\psi^\nu(w) \simeq -\frac{\eta^{\mu\nu}}{2(z-w)}. \quad (3.22)$$

The BRST current is modified to

$$j_B = c(T_m + T_{\beta\gamma}) + bc\partial c + \gamma T_F - \frac{1}{4}\gamma^2 b. \quad (3.23)$$

The Grassmann even picture changing operator (PCO) field $\mathcal{X}(z)$ is defined as

$$\mathcal{X}(z) = \{Q, \xi(z)\} = c\partial\xi + e^\phi T_F - \frac{1}{4}\partial\eta e^{2\phi} b - \frac{1}{4}\partial(\eta e^{2\phi} b). \quad (3.24)$$

We assign various quantum numbers to the fields as follows:

1. We assign ghost number to the fields as follows:

$$\begin{aligned} \text{gh}(c) &= \text{gh}(\eta) = \text{gh}(\gamma) = 1, \\ \text{gh}(b) &= \text{gh}(\xi) = \text{gh}(\beta) = -1. \end{aligned} \quad (3.25)$$

The matter fields X^μ, ψ^μ , as well as the ϕ field have ghost number zero. Note that the PCO has ghost number zero, and so do the stress tensor T and the superpartner T_F . The assignment in the anti-holomorphic sector is analogous.

2. We assign holomorphic picture number ‘pic’ as follows

$$\text{pic}(\eta) = -1, \quad \text{pic}(\xi) = 1, \quad \text{pic}(e^{q\phi}) = q, \quad \text{pic}(\mathcal{X}) = 1. \quad (3.26)$$

All matter fields, as well as the (β, γ) ghosts have zero picture number. The stress tensors T and the superpartners T_F also have zero picture number. There is separate anti-holomorphic picture number defined for the anti-holomorphic fields.

3. Associated to the world-sheet fermion number F operator with integer eigenvalues, there is a GSO (Gliozzi-Scherk-Olive) operator $(-1)^F$. An operator \mathcal{O} such that $(-1)^F \mathcal{O} = \mathcal{O}(-1)^F$ is said to be GSO even, and an operator for which $(-1)^F \mathcal{O} = -\mathcal{O}(-1)^F$ is said to be GSO odd. We have:

$$\text{GSO odd fields: } \beta, \gamma, \psi^\mu, T_F. \quad (3.27)$$

The operator $e^{q\phi}$ has GSO parity $(-1)^q$ for integer q , namely, $(-1)^F e^{q\phi} = (-1)^q e^{q\phi} (-1)^F$. The rest of the fields introduced above, including $X^\mu, c, b, \eta, \xi, j_B, \mathcal{X}$, are GSO even.

4. NS sector vertex operators are obtained by taking the product of $e^{q\phi}$ for $q \in \mathbb{Z}$ and a regular vertex operator constructed from the ghosts b, c, β, γ and the matter fields. Ramond sector vertex operators are obtained by taking the product of $e^{q\phi}$ for $q \in \mathbb{Z} + \frac{1}{2}$ and a ‘spin field’ whose operator product with the GSO even NS sector fields are single valued but whose operator product with GSO odd NS sector fields have square root branch point singularities. The GSO projection rules in the R sector have a two-fold ambiguity since a given spin field may be declared to be GSO odd or even, but once a choice has been made for one such spin field, the GSO parity of the rest of the operators are chosen to be such that if V is a GSO even operator in the R-sector then the operator product of V with any GSO odd (even) operator in the NS sector will only generate GSO odd (even) operators in the R sector. Type IIA and IIB theories differ in the specification of which half of the states are declared as GSO even in the R sector.

In type IIA or type IIB superstring theories we have separate GSO operators in the left and right-moving sectors and we require the state to be invariant under each of these GSO operators. There are also versions of superstring theory without space-time supersymmetry, known as type 0A and type 0B theories, where we require the states to be invariant under the combined operation of left and right GSO operation. As in bosonic string theory, the physical states in all these theories are taken to be the BRST cohomology classes. The picture number, however, is fixed. We require picture -1 for the NS sector and picture $-1/2$ for R sector.

We define momentum states for closed and open strings, respectively,

$$|k; m, n\rangle \equiv e^{ik \cdot X}(0) e^{m\phi}(0) e^{n\bar{\phi}}(0) |0\rangle, \quad |k; m\rangle \equiv e^{ik \cdot X}(0) e^{m\phi}(0) |0\rangle. \quad (3.28)$$

In the first definition $|0\rangle$ is the $\text{SL}(2, \mathbb{C})$ invariant closed string vacuum, while in the second definition $|0\rangle$ is the $\text{SL}(2, \mathbb{R})$ invariant open string vacuum. The analog of the normalization conditions (3.10), (3.11) are:

$$\langle k; 0, 0 | c_{-1} \bar{c}_{-1} c_0 \bar{c}_0 c_1 \bar{c}_1 e^{-2\phi} e^{-2\bar{\phi}} | k'; 0, 0 \rangle = -(2\pi)^D \delta^{(D)}(k + k'), \quad (3.29)$$

and

$$\langle k; 0 | c_{-1} c_0 c_1 e^{-2\phi} | k'; 0 \rangle' = (2\pi)^{p+1} \delta^{(p+1)}(k + k'), \quad (3.30)$$

where the locations of the operators $e^{-2\phi}$, $e^{-2\bar{\phi}}$ on the world-sheet are irrelevant since they are dimension zero vertex operators.² Note the ‘ \prime ’ on the correlator in (3.30); in open closed string field theory we have to define a more general inner product analogously to (3.12) with a constant K on the right hand side.

²The difference in sign between (3.11) and (3.30) was chosen so that we can use a uniform sign for the string field theory action in different theories. Indeed, consider a physical -1 picture vertex operator $e^{-\phi} V$ where V is a GSO odd, dimension $1/2$ matter sector primary, normalized as $V(z)V(w) \simeq (z-w)^{-1}$. Then $e^{-\phi}(z)V(z)e^{-\phi}(w)V(w) \simeq -(z-w)^{-2}e^{-2\phi}(w)$, with a minus sign that is compensated by changing the sign of the overlap.

For heterotic string theory, the left chiral (anti-holomorphic) sector is like the bosonic string theory and the right chiral sector is like the type II string theory. In this theory there is only one GSO operator and we include in the spectrum only those states that are invariant under this GSO operator. The vacuum is normalized as

$$\langle k; 0 | c_{-1} c_0 c_1 e^{-2\phi} | k'; 0 \rangle = (2\pi)^D \delta^{(D)}(k + k'), \quad (3.31)$$

with the difference in sign relative to (3.29) having the same origin as described in footnote 2.

In the construction of the interaction terms in string field theory, correlation functions of local operators on various Riemann surfaces will play an important role. These will depend on the moduli of the Riemann surfaces and the locations of the vertex operators, these insertion points are called ‘punctures’ of the surface. We shall collectively call these the moduli of punctured Riemann surfaces. Since general vertex operators are not invariant under arbitrary conformal transformations, these correlation functions also depend on a choice of a *local coordinate* system w_i in which the i -th vertex operator V_i is inserted on the Riemann surface at $w_i = 0$. On a Riemann surface no local coordinate system is preferred, so a choice must be made of a local coordinate at each puncture. If z denotes a coordinate system on the Riemann surface Σ and if z is related to w_i via $z = f_i(w_i)$ near $w_i = 0$ then the correlation function \mathcal{C} may be written as

$$\mathcal{C} = \left\langle \prod_i f_i \circ V_i(0) \right\rangle_{\Sigma}, \quad (3.32)$$

where $f \circ V(w)$ denotes the conformal transform of V by the map f and the subscript Σ indicates that the correlation function is being computed on the surface Σ . If V is a dimension (\bar{h}, h) primary operator then

$$f \circ V(w) = (f'(w))^h (\bar{f}'(\bar{w}))^{\bar{h}} V(f(w)). \quad (3.33)$$

For general operators the transformation laws are more complicated. The object $f \circ V(w)$ is in fact $V(w)$ rewritten as an operator in the z plane using $z = f(w)$. Indeed, from the transformation of the primary V , one has

$$V(w) (dw)^h (d\bar{w})^{\bar{h}} = V(z) (dz)^h (d\bar{z})^{\bar{h}} \rightarrow V(w) = V(z(w)) \left(\frac{dz}{dw} \right)^h \left(\frac{d\bar{z}}{d\bar{w}} \right)^{\bar{h}}. \quad (3.34)$$

With $z = f(w)$ the above right-hand side coincides with the right-hand side of (3.33). This is why the correlation function \mathcal{C} above is sometimes written as

$$\mathcal{C} = \left\langle \prod_i V_i(w_i = 0) \right\rangle_{\Sigma}. \quad (3.35)$$

The expression (3.32) will be thought as an *off-shell* correlation function. An on-shell correlation function is one where the vertex operators are all conformal invariant, and therefore the conformal maps by the functions f_i have no effect.

Throughout our analysis we shall assume that the CFT correlation functions on Riemann surfaces, introduced above, follow the gluing axioms as described by G. Segal in [32]. For closed string punctures this means the following. Suppose we have a pair of closed string punctures P_1 and P_2 , either on the same Riemann surface or on two different Riemann surfaces and let w_1 and w_2 be the local coordinates at those punctures, Let $\{|\chi_r\rangle\}$ and $\{|\chi_r^c\rangle\}$ be a pair of complete set of basis states, satisfying

$$\langle \chi_s^c | \chi_r \rangle = \delta_{rs} \quad \Leftrightarrow \quad \sum_r |\chi_r\rangle \langle \chi_r^c| = I, \quad (3.36)$$

where I is the identity operator. Let us suppose that we insert at the first puncture the state χ_r and at the second puncture the state χ_r^c , place χ_r to the extreme right and χ_r^c to the extreme left of the correlation function (picking up signs if needed) and sum over r . Then this is equivalent to computing the correlation function on a new Riemann surface without the punctures P_1 and P_2 , and identifying the local coordinates w_1 and w_2 via the relation

$$w_1 w_2 = 1. \quad (3.37)$$

Inside the correlator we preserve the original order of the rest of the operators, and in the case of gluing two different Riemann surfaces, place all the operators on the Riemann surface associated with the first puncture to the left of all the operators on the Riemann surface associated with the second puncture.

For open strings we have a similar relation except that (3.37) is replaced by

$$w_1 w_2 = -1, \quad (3.38)$$

to account for the difference in the BPZ conjugate operator in the two theories, i.e. $I_c(z) = 1/z$ and $I_o(z) = -1/z$.

For heterotic string and superstrings the construction is similar with one important difference. When we glue two punctures on two different Riemann surfaces, the picture numbers of χ_r and χ_r^c are fixed by picture number conservation. However when the two punctures lie on the same Riemann surface, the picture number (p_r, \bar{p}_r) of χ_r can be arbitrary and that of χ_r^c is fixed to be $(2 - p_r, 2 - \bar{p}_r)$. In this case, instead of summing over all picture number states, we only sum over states carrying a fixed picture number. The canonical choice is picture number -1 in the NS sector and $-1/2$ for χ_r and $-3/2$ for χ_r^c (or vice versa) for the R sector, since only in these sectors the L_0 eigenvalue is bounded from below. In contrast, both in the bosonic and the superstring theories we sum over χ_r of all ghost numbers.

3.2 Bosonic string amplitudes and their off-shell generalization

In this subsection we shall describe the procedure for constructing amplitudes in closed bosonic string theory. The g loop n -point amplitude of BRST invariant external states with vertex operators V_1, \dots, V_n may be expressed as an integral of an appropriate correlation function of these vertex operators over the moduli space $\mathcal{M}_{g,n}$ of Riemann surfaces of genus g with n punctures. The real dimension of this moduli space is:

$$d_{g,n} \equiv \dim_{\mathbb{R}}(\mathcal{M}_{g,n}) = 6g - 6 + 2n. \quad (3.39)$$

Moreover, we also note that the Euler number $\chi_{g,n}$ of the surfaces in this moduli space is:

$$\chi_{g,n} = 2 - 2g - n. \quad (3.40)$$

If we take generic representatives of the BRST cohomology that are not dimension zero primary fields, then the correlation function depends not only on the moduli of the Riemann surface but also on the choice of local coordinates at the punctures. Therefore a precise description of the string amplitude requires us to go beyond the moduli space $\mathcal{M}_{g,n}$ of Riemann surfaces [33].

Let $\widehat{\mathcal{P}}_{g,n}$ be a fiber bundle whose base is the moduli space $\mathcal{M}_{g,n}$ and whose fiber gives the choice of local coordinates at the punctures up to phases. On a punctured Riemann surface, a local coordinate

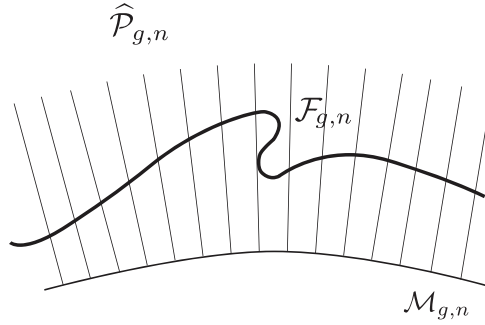

Figure 1: A subspace $\mathcal{F}_{g,n}$ of $\hat{\mathcal{P}}_{g,n}$ for which the map to the base $\mathcal{M}_{g,n}$ is a degree one map is all that is required to compute string amplitudes. The space $\mathcal{F}_{g,n}$, as shown, need not be a section of this bundle.

w at a puncture can be described as an analytic map from a round disk $|w| \leq 1$ to a disk domain surrounding the puncture, with $w = 0$ mapping to the puncture. The map induces a parameterization of the boundary of the disk domain. By the Riemann mapping theorem, the coordinate map between the two disks is uniquely fixed by the (unparameterized) boundary of the disk domain if we state which is the point in the disk domain boundary that corresponds to $w = 1$. The position of this point on the disk domain is equivalent to specifying the phase of the local coordinate, or the ‘origin’ of the closed string. Thus, a local coordinate at a puncture, up to a phase, is determined simply by drawing an arbitrary disk domain surrounding the puncture.

In the $\hat{\mathcal{P}}_{g,n}$ bundle, the projection operator down to the base consists in forgetting the local coordinates. The phase ambiguity of the local coordinates in $\hat{\mathcal{P}}_{g,n}$, happily, does not affect the correlation functions of states due to the conditions (3.13). There are sections $\mathcal{S}_{g,n}$ of this bundle, thanks to the phase ambiguity, – there would be no sections if the fiber contained information on the phase of the local coordinates. The inability to fix the phase of the local coordinates continuously over the moduli space is the geometrical basis for the condition $L_0^- = 0$ satisfied by the off-shell states. The related $b_0^- = 0$ condition is needed for the construction of differential forms to be integrated over moduli space.

In bosonic string theory amplitudes can be computed using sections, but more flexibility is useful, keeping in mind the generalization of this construction to superstrings. We can use a subspace $\mathcal{F}_{g,n}$ of the bundle such that the projection map $\mathcal{F}_{g,n} \rightarrow \mathcal{M}_{g,n}$ is a map of degree one.³ This means that a generic surface is counted once *with multiplicity*. The situation is sketched in Figure 1. It is worth considering even more general situations where $\mathcal{F}_{g,n}$ is not a submanifold but rather a *singular chain* describing an element of the homology group $H_{6g-6+2n}(\hat{\mathcal{P}}_{g,n})$. This takes care of situations where $\mathcal{F}_{g,n}$ could have self-intersections or may be a formal weighted sum of disconnected spaces [34]. The replacement of subspaces for chains is no problem for the construction of amplitudes because forms are naturally integrated over chains. In this more general case we will simply say that $\mathcal{F}_{g,n}$ is a *chain* (and so will be string vertices $\mathcal{V}_{g,n}$ when we discuss string field theory). The condition of a map of

³The degree of a continuous mapping between two compact oriented manifolds of the same dimension is an integer that represents the number of times the domain manifold wraps around the range manifold under the map. For any regular point x on the range manifold, the preimage in the domain manifold is a set of points $\{x_1, x_2, \dots, x_n\}$, such that the map from a neighborhood of each x_i to a neighborhood of x is a diffeomorphism. The degree of the map is the number x_i ’s for which the map is orientation preserving minus the number of x_j ’s for which the map is orientation reversing. That degree must be independent of the point x on the range manifold. Any map of degree different from zero must be surjective. An example of a degree one map that is not a section has been illustrated in Fig. 1.

degree one, for the case of a chain $\mathcal{F}_{g,n}$ means that when pushed forward to $\mathcal{M}_{g,n}$, it represents the fundamental homology class of $\mathcal{M}_{g,n}$.

The g -loop, n -point amplitude $\mathcal{A}_g(V_1, \dots, V_n)$ of the BRST invariant operators is now given by

$$\mathcal{A}_g(V_1, \dots, V_n) = (g_s)^{-\chi_{g,n}} \int_{\mathcal{F}_{g,n}} \Omega_{6g-6+2n}^{(g,n)}(V_1, \dots, V_n), \quad (3.41)$$

where g_s is the string coupling constant, and $\Omega_p^{(g,n)}(V_1, \dots, V_n)$ denotes a properly *normalized* p -form on $\widehat{\mathcal{P}}_{g,n}$. The form in the above amplitude is of degree $d_{g,n}$. We will now explain how, more generally, we define the form $\Omega_p^{(g,n)}(A_1, \dots, A_n)$ with A_i arbitrary vertex operators in \mathcal{H}_c .

Given a Riemann surface $\Sigma_{g,n}$ of genus g carrying n punctures, we first decompose it into a collection of n disjoint disks D_1, \dots, D_n , one around each puncture, and $(2g-2+n)$ spheres S_1, \dots, S_{2g-2+n} , each with three holes. The $3(2g-2+n)$ boundaries of the spheres and the n boundaries of the disks, which we shall call gluing circles, are glued pairwise at $(3g-3+2n)$ circles $C_1, \dots, C_{3g-3+2n}$. An example of such a decomposition has been shown in Fig. 2. We choose some complex coordinate system w_a on the disk D_a such that the a -th puncture is situated at $w_a = 0$. These are the local coordinates at the punctures (but note that the boundary of the disk is not necessarily the locus of $|w_a| = 1$). We also choose some complex coordinate system z_i on the sphere S_i . Here $a = 1, \dots, n$ and $i = 1, \dots, 2g-2+n$.

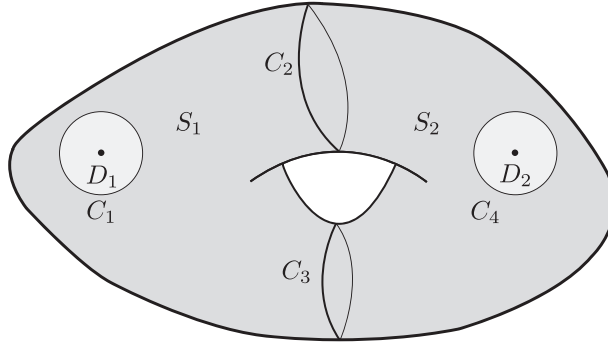

Figure 2: Decomposition of a genus one surface with two punctures, denoted by dots, into two disks D_1 and D_2 and two three-holed spheres S_1 and S_2 , joined across four gluing circles C_1, C_2, C_3, C_4 .

We denote by σ_s and τ_s the complex coordinate system on the left and right of the gluing circle C_s , respectively, for some given choice of orientation of C_s . There are two possible gluing patterns: disk to sphere, where one out of (σ_s, τ_s) is a w_a and the other is a z_i , and sphere to sphere, where one out of (σ_s, τ_s) is a z_i and the other a z_j , with i and j different or the same. The moduli of the Riemann surface $\Sigma_{g,n}$ and the local coordinate system at the punctures are fixed by the transition functions relating σ_s and τ_s . Two sets of transition functions are declared equivalent if they can be related by reparametrization of w_a keeping the puncture at $w_a = 0$ fixed, and/or reparametrization of the coordinates z_i . The space of inequivalent transition functions gives the moduli space $\mathcal{M}_{g,n}$. On the other hand, the bigger space $\widehat{\mathcal{P}}_{g,n}$ arises when two sets of transition functions are declared equivalent if they can be related by reparametrization of the coordinates z_i keeping the w_a 's fixed up to phase rotations. Therefore, if u stands for the set of coordinates of $\widehat{\mathcal{P}}_{g,n}$, we can write the transition functions as follows,

$$\sigma_s = F_s(\tau_s, u). \quad (3.42)$$

For a given tangent vector $\partial/\partial u^i$ of $\widehat{\mathcal{P}}_{g,n}$, we introduce the world-sheet operator $\mathcal{B}\left[\frac{\partial}{\partial u^i}\right]$ defined as a sum of contour integrals along all the gluing circles C_s :

$$\mathcal{B}\left[\frac{\partial}{\partial u^i}\right] \equiv \sum_s \left[\oint_{C_s} \frac{\partial F_s}{\partial u^i} d\sigma_s b(\sigma_s) + \oint_{C_s} \frac{\partial \bar{F}_s}{\partial u^i} d\bar{\sigma}_s \bar{b}(\bar{\sigma}_s) \right], \quad (3.43)$$

where \oint is normalized as in (3.3) and, as mentioned above, the orientation of C_s is such that σ_s is to the left of the contour and τ_s is to the right of the contour. The contraction of $\Omega_p^{(g,n)}(A_1, \dots, A_n)$ with p tangent vectors of $\widehat{\mathcal{P}}_{g,n}$ is now defined as

$$\Omega_p^{(g,n)}(A_1, \dots, A_n) \left[\frac{\partial}{\partial u^{j_1}}, \dots, \frac{\partial}{\partial u^{j_p}} \right] \equiv \left(-\frac{1}{2\pi i} \right)^{3g-3+n} \left\langle \mathcal{B}\left[\frac{\partial}{\partial u^{j_1}}\right] \cdots \mathcal{B}\left[\frac{\partial}{\partial u^{j_p}}\right] A_1 \cdots A_n \right\rangle_{\Sigma_{g,n}}, \quad (3.44)$$

where $\langle \rangle_{\Sigma_{g,n}}$ denotes correlation function on the n -punctured Riemann surface $\Sigma_{g,n}$ and the vertex operators A_1, \dots, A_n are inserted at the punctures $w_1 = 0, \dots, w_n = 0$ using the local coordinates w_1, \dots, w_n (see (3.35)). As anticipated, we shall take (3.44) to be the definition of $\Omega_p^{(g,n)}(A_1, \dots, A_n)$ for any $A_i \in \mathcal{H}_c$, not necessarily just for BRST invariant A_i 's. The origin of the normalization prefactor $(-\frac{1}{2\pi i})^{3g-3+n}$ chosen above will be explained in section 5.1 (see (5.13)). In writing (3.44) we have assumed that the orientation of the integration measure in (3.41) is the canonical one inherited from the complex structure in $\mathcal{M}_{g,n}$, i.e. if $u = u_x + iu_y$ is a complex coordinate the $du \wedge d\bar{u} = -2idu_x \wedge du_y$ with the integral of $du_x \wedge du_y$ yielding a positive result.

The above formalism, where antighost insertions can be supported on all gluing circles, represents an extension of the Schiffer variation formalism used in the operator formulation of CFT's [33,35,36] as well as in formulation of closed string field theory and a number of computations in this theory [6,37]. As befits the operator formulation of CFT, the antighost insertions are all supported only on the gluing circles that surround the punctures where the external states are inserted. All tangents on $\widehat{\mathcal{P}}_{g,n}$ can be represented by deformations of the gluing relations on those circles [38]. Thus, all the u moduli appear in transition functions relating w_a and z_i . The Schiffer vector v_a^u , defined on a neighborhood of the gluing circle for the $w_a = 0$ puncture, enters the antighost insertion in the form $\oint dw_a b(w_a) v_a^u(w)$, plus antiholomorphic parts.

It is instructive to see how our prescription converts an unintegrated vertex operator $\bar{c}cV$, with V a dimension $(1,1)$ primary operator in the matter sector, to a two-form operator $dy \wedge d\bar{y}V(y)$ that can be integrated. For this let w be the local coordinate at the puncture situated at $w = 0$, and z be the coordinate system in a patch of the surface that encloses the open set covered by the w coordinate. On the curve separating the patches labelled by z and w coordinates, let z and w be related via

$$z = F(w, u), \quad (3.45)$$

where $u = (u^1, u^2)$ are a pair of real coordinates that label the location of the puncture in the z coordinate. We shall assume that $F(w, u)$ is analytic in the patch covered by the w coordinate system, so that it can be used to extend the z coordinate into this patch. In that case, if we define

$$y(u) = F(0, u), \quad (3.46)$$

then y can be viewed as the location of the puncture in the z coordinate system, extended by (3.45) into the full patch covered by the w coordinate system. Comparing with (3.42), we see that z plays

the role of σ_s and w plays the role of τ_s . Thus, up to additional insertions (denoted by dots) that we do not focus on, the effect of inserting the vertex operator $c\bar{c}V$ is represented by the two-form

$$\Omega_2(c\bar{c}V) = \left(-\frac{1}{2\pi i}\right) du^1 \wedge du^2 \left\langle \cdots \mathcal{B} \left[\frac{\partial}{\partial u^1} \right] \mathcal{B} \left[\frac{\partial}{\partial u^2} \right] c\bar{c}V(w=0) \right\rangle, \quad (3.47)$$

where it is understood that $V(w)$ means that V is inserted using the w coordinate system. We have included the extra factor of $-1/(2\pi i)$, consistent with (3.44), having increased the number of punctures by one. Using (3.43) we now get

$$\begin{aligned} \mathcal{B} \left[\frac{\partial}{\partial u^1} \right] \mathcal{B} \left[\frac{\partial}{\partial u^2} \right] &= \left[\oint b(z) dz \frac{\partial F(w, u)}{\partial u^1} + \oint \bar{b}(\bar{z}) d\bar{z} \frac{\partial \overline{F(w, u)}}{\partial u^1} \right] \\ &\left[\oint b(z) dz \frac{\partial F(w, u)}{\partial u^2} + \oint \bar{b}(\bar{z}) d\bar{z} \frac{\partial \overline{F(w, u)}}{\partial u^2} \right], \end{aligned} \quad (3.48)$$

where the contours are along the boundary separating the patches covered by the z and w coordinate systems, i.e. surrounding the insertion at $w = 0$. Each of the contours runs clockwise so that they keep the z coordinate system to the left, but since we have product of two such contours, we can take them to be anti-clockwise. Since $c\bar{c}V$ is a dimension zero primary, we can express $c\bar{c}V(w = 0)$ as $c\bar{c}V(z = y)$. We carry out the integration over z, \bar{z} by deforming the contours towards $z = y$ and picking up residues from the operator products $b(z) c\bar{c}V(z = y)$ and $\bar{b}(\bar{z}) c\bar{c}V(z = y)$. After using $y = F(0, u)$, we get

$$\Omega_2(c\bar{c}V) = -\left(-\frac{1}{2\pi i}\right) du^1 \wedge du^2 \left(\frac{\partial y}{\partial u^1} \frac{\partial \bar{y}}{\partial u^2} - \frac{\partial y}{\partial u^2} \frac{\partial \bar{y}}{\partial u^1} \right) \langle \cdots V(z = y) \rangle. \quad (3.49)$$

Furthermore we have

$$du^1 \wedge du^2 \left(\frac{\partial y}{\partial u^1} \frac{\partial \bar{y}}{\partial u^2} - \frac{\partial y}{\partial u^2} \frac{\partial \bar{y}}{\partial u^1} \right) = dy \wedge d\bar{y}. \quad (3.50)$$

Using this in (3.49) we thus find that

$$\Omega_2(c\bar{c}V) = \frac{1}{2\pi i} \langle \cdots (dy \wedge d\bar{y} V(z = y)) \rangle. \quad (3.51)$$

As expected, (3.44) builds a two-form ready for integration starting from an unintegrated vertex operator.

Using conformal field theory Ward identities, one can show that the action of the BRST operator on the states that enter the form $\Omega_p^{(g,n)}$ maps to an action of the exterior derivative on the form of one degree less [6, 33]:

$$\begin{aligned} \Omega_p^{(g,n)}(QA_1, A_2, \cdots, A_n) + \cdots + (-1)^{A_1 + \cdots + A_{n-1}} \Omega_p^{(g,n)}(A_1, A_2, \cdots, QA_n) \\ = (-1)^p d\Omega_{p-1}^{(g,n)}(A_1, \cdots, A_n), \end{aligned} \quad (3.52)$$

where $(-1)^A$ is defined to be 1 if A has even ghost number and -1 if A has odd ghost number. Using this identity one can *formally* show as follows that the amplitude is independent of the choice of the subspace $\mathcal{F}_{g,n}$. Let $\mathcal{F}'_{g,n}$ be another subspace of $\hat{\mathcal{P}}_{g,n}$, with $\mathcal{F}'_{g,n} \rightarrow \mathcal{M}_{g,n}$ also of degree one, and let $\mathcal{R}_{g,n}$ be any $6g - 5 + 2n$ dimensional space that interpolates between $\mathcal{F}_{g,n}$ and $\mathcal{F}'_{g,n}$, so that $\partial\mathcal{R}_{g,n} = \mathcal{F}'_{g,n} - \mathcal{F}_{g,n}$. Then we have

$$\int_{\mathcal{F}'_{g,n}} \Omega_{6g-6+2n}^{(g,n)}(V_1, \cdots, V_n) - \int_{\mathcal{F}_{g,n}} \Omega_{6g-6+2n}^{(g,n)}(V_1, \cdots, V_n) = \int_{\mathcal{R}_{g,n}} d\Omega_{6g-5+2n}^{(g,n)}(V_1, \cdots, V_n). \quad (3.53)$$

Since $QV_i = 0$ for each i , the integrand on the right-hand side vanishes by (3.52), and thus the right-hand side vanishes.

Equation (3.52) also can be used to give a *formal* proof that the BRST exact states have vanishing amplitude as long as all the other external states are BRST invariant. For this let us suppose that $V_1 = QW_1$ and V_2, \dots, V_n are BRST invariant. Then using (3.52) we can write

$$\Omega_{6g-6+2n}^{(g,n)}(QW_1, V_2, \dots, V_n) = d\Omega_{6g-7+2n}^{(g,n)}(W_1, V_2, \dots, V_n). \quad (3.54)$$

When we integrate this over $\mathcal{F}_{g,n}$, we get a vanishing result.

Both these arguments are valid up to a subtlety with special ‘divisors’, sets where the corresponding surfaces in the moduli space $\mathcal{M}_{g,n}$ degenerate. More precisely, one works with the Deligne-Mumford compactification $\bar{\mathcal{M}}_{g,n}$ of the moduli space, where there is no boundary, and the divisors are represented by nodal surfaces (see Section 7.3.) The nodal surfaces are sets of real codimension two in the moduli space. The complication is that the integrand $\Omega^{(g,n)}$ for string amplitudes can diverge as we approach the divisors. One option to deal with this problem is to complexify the moduli space and deform the integration contour in this complexified moduli space such that the form $\Omega_{6g-7+2n}^{(g,n)}$ appearing on the right-hand side of (3.54) vanishes as we approach the end point of the integration region [39,40]. This is equivalent to using the $i\epsilon$ prescription in quantum field theory and works when the momentum flowing through the node is generic, but fails when the momentum is forced to be on-shell due to conservation laws. As we shall describe, one of the applications of string field theory will be to make sense of these divergences and extract finite, unambiguous answers from them. This also allows us to evaluate the integral of (3.54) and show that it indeed vanishes.

3.3 Amplitudes in closed superstring theories

The amplitudes in superstring theory are defined similarly, but with a few differences. First of all, each physical state has infinite number of representatives, one in each integer picture number for NS sector states and one in each integer + half picture number for R sector states. We choose picture -1 to represent NS sector states and picture $-1/2$ to represent R sector states. If we denote by \mathcal{H}_c the space of closed string states carrying these picture numbers and satisfying the subsidiary conditions (3.13), then the physical closed string states are elements of the BRST cohomology in \mathcal{H}_c carrying ghost number two.

Consider now a genus g correlation function. This correlation function vanishes unless the total picture number of all the operators is $(2g-2)$, separately in the holomorphic and the anti-holomorphic sectors. Hence we need to add some picture changing operators on the Riemann surfaces. Let $n_{p,q}$ is the number of vertex operators A_i with picture number (p, q) . Given the picture number assignment for the separate NS and R sectors, the possible n ’s are:

$$n_{-1,-1}, \quad n_{-1,-1/2}, \quad n_{-1/2,-1}, \quad n_{-1/2,-1/2}. \quad (3.55)$$

The numbers N_L and N_R of PCOs that we need on the left and the right sectors respectively, are obtained from the sum rules

$$\begin{aligned} 2g-2 &= N_L - n_{-1,-1} - n_{-1,-1/2} - \frac{1}{2}n_{-1/2,-1} - \frac{1}{2}n_{-1/2,-1/2}, \\ 2g-2 &= N_R - n_{-1,-1} - n_{-1/2,-1} - \frac{1}{2}n_{-1,-1/2} - \frac{1}{2}n_{-1/2,-1/2}. \end{aligned} \quad (3.56)$$

Let y_1, \dots, y_{N_R} and $\bar{y}_1, \dots, \bar{y}_{N_L}$, collectively denoted as y_α, \bar{y}_α , be the positions where we will insert right and left sector operators that change picture number. The operators to be inserted will be

either $(-\partial\xi)$ or the standard PCO \mathcal{X}_0 for the holomorphic sector (right) and either $(-\bar{\partial}\bar{\xi})$ or the standard PCO $\bar{\mathcal{X}}_0$ for the anti-holomorphic sector (left). The coordinates y_α, \bar{y}_α are taken to be in the w_a or z_i coordinate system depending on whether they lie on the disk D_a or the sphere S_i . No local coordinate is needed at the location of the PCO insertions because these are primary fields of dimension zero. No local coordinate will be needed for the $(-\partial\xi)$ and $(-\bar{\partial}\bar{\xi})$ insertions because, they are dimension one, but appear as invariant one forms.

We regard these positions y_α, \bar{y}_α as extra fiber data to be added to $\widehat{\mathcal{P}}_{g,n}$ to form a new bundle $\widehat{\mathcal{P}}_{g,n}^s$, with $s = N_L + N_R$. Now a point of $\widehat{\mathcal{P}}_{g,n}^s$ is a Riemann surface $\Sigma_{g,n}$ with local coordinates (up to phases) at the punctures, and a choice of s positions for the insertion of operators that change picture number.⁴ Therefore $\widehat{\mathcal{P}}_{g,n}^s$, in addition to the familiar bosonic moduli tangent vectors $\partial/\partial u^i$, now has tangent vectors $\partial/\partial y_\alpha$ and $\partial/\partial \bar{y}_\beta$ associated with changing the position of the operators that change picture number. A p form $\Omega_p^{(g,n)}$ acts on k moduli vectors, ℓ tangent vectors for right sector picture changing insertions and $\bar{\ell}$ tangent vector for left sector picture changing insertions, with

$$p = k + \ell + \bar{\ell}. \quad (3.57)$$

We define

$$\begin{aligned} & \Omega_p^{(g,n)}(A_1, \dots, A_n) \left[\frac{\partial}{\partial u^{j_1}}, \dots, \frac{\partial}{\partial u^{j_k}}, \frac{\partial}{\partial y_{\alpha_1}}, \dots, \frac{\partial}{\partial y_{\alpha_\ell}}, \frac{\partial}{\partial \bar{y}_{\beta_1}}, \dots, \frac{\partial}{\partial \bar{y}_{\beta_{\bar{\ell}}}} \right] \\ \equiv & \left(-\frac{1}{2\pi i} \right)^{3g-3+n} \left\langle \mathcal{B} \left[\frac{\partial}{\partial u^{j_1}} \right] \cdots \mathcal{B} \left[\frac{\partial}{\partial u^{j_k}} \right] (-\partial\xi(y_{\alpha_1})) \cdots (-\partial\xi(y_{\alpha_\ell})) \right. \\ & \left. (-\bar{\partial}\bar{\xi}(\bar{y}_{\beta_1})) \cdots (-\bar{\partial}\bar{\xi}(\bar{y}_{\beta_{\bar{\ell}}})) \prod_{\alpha=l+1}^{N_R} \mathcal{X}(y_\alpha) \prod_{\beta=\bar{l}+1}^{N_L} \bar{\mathcal{X}}(\bar{y}_\beta) A_1 \cdots A_n \right\rangle_{\Sigma_{g,n}}. \end{aligned} \quad (3.58)$$

Of course, the insertions of $\partial\xi$ and $\bar{\partial}\bar{\xi}$ each carry as much picture number as a PCO. Each insertion $(-\partial\xi(y_\alpha))$ appearing above, is associated with the form $(-\partial\xi(y_\alpha))dy_\alpha$, and is conformal invariant. Note that only the positions that have no associated tangent vector in the form have a PCO insertion.

The bundle $\widehat{\mathcal{P}}_{g,n}^s$ admits subspaces $\mathcal{F}_{g,n}^s$, with $\mathcal{F}_{g,n}^s \rightarrow \mathcal{M}_{g,n}$ a degree one map, that one could hope to integrate $\Omega_{6g-6+2n}^{(g,n)}$ over to define the string amplitude. We also need to sum over spin structures – different choices of boundary conditions on GSO odd fields along homologically non-trivial cycles of the Riemann surface. It will be understood that integration over $\mathcal{F}_{g,n}^s$ includes sum over spin structures. An additional complication, however, arises because the correlation functions of vertex operators on a Riemann surface suffer from spurious poles *away* from degeneration of the Riemann surface. These could arise for example when a pair of PCOs collide but, more surprisingly, can also arise on complex codimension one subspaces of the moduli space where no operators are coincident [41]. Therefore the loci of the spurious poles span complex codimension one subspaces of $\widehat{\mathcal{P}}_{g,n}^s$. It is not clear how to choose an $\mathcal{F}_{g,n}^s$ that avoids these spurious poles. One simplification arises because the location of these poles is independent of the type of vertex operators inserted at the punctures, except for their picture numbers. Thus a choice that avoids these poles will avoid them for all amplitudes. We shall now introduce the notion of *vertical integration* [42, 43] that is used to avoid the loci of all spurious poles and then comment on the nature of the resulting space $\tilde{\mathcal{F}}_{g,n}^s$ for integration.

⁴The subscript n in $\widehat{\mathcal{P}}_{g,n}^s$ should really be thought of as the collection $(n_{-1,-1}, n_{-1,-1/2}, n_{-1/2,-1}, n_{-1/2,-1/2})$. The locations y_α, \bar{y}_β can be chosen independently for each choice of $(n_{-1,-1}, n_{-1,-1/2}, n_{-1/2,-1}, n_{-1/2,-1/2})$, even in cases when the (N_L, N_R) computed from (3.56) are equal for such choices.

As a first step one divides $\mathcal{F}_{g,n}^s$ into small cells, and then within each cell, if there are spurious poles, one modifies the PCO locations to avoid them. This can always be done. As a result of this modification, however, the positions of the PCO's will typically fail to agree at the boundaries between two cells. The boundaries we are speaking about are of dimension $(\dim \mathcal{M}_{g,n} - 1)$; they are codimension one boundaries.

Consider now a boundary between two cells. As a second step, one interpolates between the choice of PCO's by using a 'vertical segment' – a one-dimensional space erected over each point on the boundary between the cells. It is called vertical since along such a segment the PCO locations change keeping the moduli of the Riemann surface and the local coordinates around the punctures fixed [42]. In other words, along such a segment we move on a fiber of $\widehat{\mathcal{P}}_{g,n}^s$ that projects to the same point in $\widehat{\mathcal{P}}_{g,n}^s$.

The vertical segment is constructed by dividing it into several segments, such that along each segment only one of the PCO locations change, keeping the other PCOs fixed. This makes the vertical segment one dimensional. Thus, for example, if (y_1, y_2) are the locations of two PCOs in one cell and (y'_1, y'_2) are the locations of the PCOs in a neighboring cell, then the vertical segment interpolating between them could consist of the segments $(y_1, y_2) \rightarrow (y'_1, y_2)$ and $(y'_1, y_2) \rightarrow (y'_1, y'_2)$, or it could consist of the segments $(y_1, y_2) \rightarrow (y_1, y'_2)$ and $(y_1, y'_2) \rightarrow (y'_1, y'_2)$. Since $\Omega_p^{(g,n)}$ is a differential form in $\widehat{\mathcal{P}}_{g,n}^s$, we can formally integrate it along the vertical segments. In particular, since along the vertical segment only one of the PCOs change, keeping all the other PCOs and moduli fixed, it follows from (3.58) that the integration along the vertical direction along which the α 'th PCO changes from y_α to y'_α , produces a factor of

$$- \int_{y_\alpha}^{y'_\alpha} \partial \xi(y) dy = \xi(y_\alpha) - \xi(y'_\alpha). \quad (3.59)$$

This, of course, has to be further integrated along the $(\dim \mathcal{M}_{g,n} - 1)$ dimensional boundary between the cells. We now see from (3.59) that since the result depends on the PCO locations at the two endpoints, even if there is a spurious pole along the way from y_α to y'_α , it is not seen and it does not affect the amplitude. For this argument it is important that the correlation functions involving ξ are single valued. This follows from the results of [41].

The process does not stop here, however. When a pair of real codimension one cell boundaries meet on a real codimension two subspace, the two vertical segments over each point on the codimension two-subspace may not match and we have to fill the gap further by erecting two dimensional vertical segments. The procedure continues to higher codimension until all the gaps are filled. A systematic procedure for doing this has been described in [43]. The end result, of course, is a space $\widetilde{\mathcal{F}}_{g,n}^s$ that is not a section in $\widehat{\mathcal{P}}_{g,n}^s$, even if the original space $\mathcal{F}_{g,n}^s$ was.

It is possible that the space $\widetilde{\mathcal{F}}_{g,n}^s$ can have 'spurious' boundaries. As we move a PCO from one point y_α to a point y'_α on a fixed Riemann surface, the curve between the two points defines the vertical segment, and thus enters the description of $\widetilde{\mathcal{F}}_{g,n}^s$. On a Riemann surface there are infinitely many homotopically inequivalent curves joining the two points. It can therefore happen that the choice of such curve (*i.e.*, the choice of a vertical segment) cannot be done continuously over $\widehat{\mathcal{P}}_{g,n}$. In that case we get boundaries in $\widetilde{\mathcal{F}}_{g,n}^s$, corresponding to the unmatched vertical segments. Nevertheless, because of (3.59), these are spurious boundaries: as far as the amplitudes are concerned the boundaries are effectively matched. There are no amplitude discontinuities.

The amplitudes in the heterotic string theory combine the features of bosonic string theory on the left-moving sector of the world-sheet and that of type II string theory on the right-moving sector

of the world-sheet. This means that the additional fiber coordinates of $\widehat{\mathcal{P}}_{g,n}^s$ are only the holomorphic locations y_α of the operators changing the picture. Therefore in (3.58) we drop the factors involving $\bar{\mathcal{X}}(\bar{y}_\alpha)$ and $\bar{\partial}\bar{\xi}(\bar{y}_\alpha)$. Otherwise the expressions remain the same. For a p form, with $p = k + \ell$ we have

$$\begin{aligned} & \Omega_p^{(g,n)}(A_1, \dots, A_n) \left[\frac{\partial}{\partial u^{j_1}}, \dots, \frac{\partial}{\partial u^{j_k}}, \frac{\partial}{\partial y_{\alpha_1}}, \dots, \frac{\partial}{\partial y_{\alpha_\ell}} \right] \\ &= \left(-\frac{1}{2\pi i} \right)^{3g-3+n} \left\langle \mathcal{B} \left[\frac{\partial}{\partial u^{j_1}} \right] \cdots \mathcal{B} \left[\frac{\partial}{\partial u^{j_k}} \right] (-\partial\xi(y_{\alpha_1})) \cdots (-\partial\xi(y_{\alpha_\ell})) \prod_{\alpha=l+1}^{N_R} \mathcal{X}(y_\alpha) A_1 \cdots A_n \right\rangle_{\Sigma_{g,n}} . \end{aligned} \quad (3.60)$$

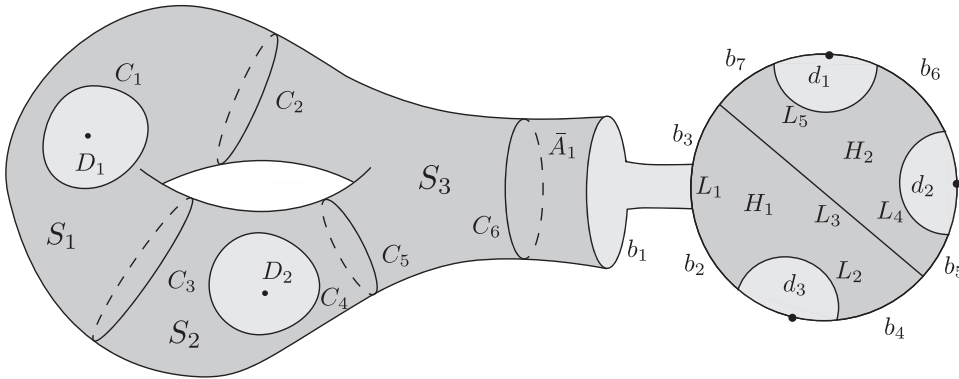

Figure 3: A genus one surface with one boundary, two closed string punctures ($n_c = 2$) and three open string punctures ($n_o = 3$). It is built with two disks D_1, D_2 , three half-disks d_1, d_2, d_3 , three spheres S_1, S_2, S_3 , one annulus \bar{A}_1 , and two hexagonal disks H_1, H_2 . These pieces are joined across six gluing circles C_1, \dots, C_6 and five gluing segments L_1, \dots, L_5 . The single boundary is composed by b_i 's as well as the segments of d_i 's containing the open string punctures (This figure is from [22].)

3.4 Amplitudes in open-closed string theory

When open strings are present in the theory there are some additional details to consider. First of all, we have to include Riemann surfaces with boundaries. Let us denote by $\mathcal{M}_{g,b,n_c,n_o}$ the moduli space of Riemann surfaces of genus g with b boundaries, n_c closed string punctures and n_o open string punctures (punctures lying on boundary components). The real dimensionality d_{g,b,n_o,n_c} of $\mathcal{M}_{g,b,n_c,n_o}$ is given by

$$d_{g,b,n_c,n_o} \equiv \dim_{\mathbb{R}}(\mathcal{M}_{g,b,n_c,n_o}) = 6g - 6 + 3b + 2n_c + n_o. \quad (3.61)$$

Moreover, the Euler number of the type (g, b, n_c, n_o) surfaces is

$$\chi_{g,b,n_c,n_o} = 2 - 2g - n_c - b - \frac{1}{2}n_o, \quad (3.62)$$

As before, since operators to be inserted need not be conformal invariant, we have to introduce the space $\widehat{\mathcal{P}}_{g,b,n_c,n_o}$ with local coordinates around all closed string punctures and all open string punctures. We discussed local coordinates around closed string punctures above. A local coordinate w at an open string puncture can be described as an analytic map from a half disk $|w| \leq 1, \text{Im}(w) \geq 0$ to a domain on the Riemann surface surrounding the puncture, with $w = 0$ mapping to the puncture and

the real interval $-1 \leq w \leq 1$ mapping to a piece of the boundary of the Riemann surface that contains the puncture. Second, even for fixed g, b, n_c, n_o , the moduli space $\mathcal{M}_{g,b,n_c,n_o}$ contains disconnected components, differing from each other in the distribution of the n_o open string vertex operators among the different boundaries, and their cyclic ordering on any given boundary. Consequently, there will also be disconnected components of $\widehat{\mathcal{P}}_{g,b,n_c,n_o}$.

The construction of forms in the presence of the open string punctures requires some new ingredients. In addition to having disks D_a around closed string punctures with gluing circles as boundaries, the relevant surfaces have half-disks d_α around open string punctures whose diameters form part of a boundary of the Riemann surface and whose semi-circular circumference gives a ‘gluing segment’. Furthermore, in addition to having spheres S_i with three holes whose boundaries are three gluing circles, we also have hexagonal disks H_β with three boundary segments and three gluing segments arranged alternatively, annuli A_γ with one gluing circle and one boundary circle and annuli \bar{A}_δ with one gluing circle, and the other circle comprising one boundary segment and one gluing segment. These components are joined across gluing circles C_s and gluing segments L_m to form the Riemann surface. We shall denote the numbers of various constituents of a Riemann surface by $\#D$, $\#S$, $\#d$, $\#H$, $\#A$, $\#\bar{A}$, $\#C$ and $\#L$. Of these $\#D$ is equal to the number n_c of external closed string punctures and $\#d$ is equal to the number n_o of external open string punctures. An example of such a construction has been shown in Fig. 3.

There are some constraints on the various numbers. From the Euler number of the surfaces we find that:⁵

$$\#S + \frac{1}{2}\#H + \frac{1}{2}\#\bar{A} = -\chi_{g,b,n_c,n_o}. \quad (3.63)$$

On the left hand side each term is (minus) the contribution to the Euler number from each component of the surface. Furthermore, since each gluing circle C_i is shared by two components (or two gluing circles of the same components), we have

$$2\#C = 3\#S + n_c + \#A + \#\bar{A}. \quad (3.64)$$

A similar result holds for gluing segments:

$$2\#L = 3\#H + n_o + \#\bar{A}. \quad (3.65)$$

As a simple check, for surfaces without boundaries and thus no open string punctures, one quickly sees that $\#S = 2g - 2 + n_c$ and that $\#C = 3g - 3 + 2n_c$, familiar results from closed string field theory. It should be noted that for open-closed theory a given surface may be built with different number of ingredient regions. For example, an annulus with one open string puncture can be built with either $\{A_1, \bar{A}_1, d_1\}$ or with $\{H_1, d_1\}$.

In this case the antighost insertion (3.43) will have additional contributions in the form of integrals

⁵For the purpose of computing the Euler number, we can replace a gluing circle by a closed string puncture and a gluing segment by an open string puncture. For example, a three holed sphere S can be regarded as a sphere with three closed string punctures, a hexagon H can be regarded as a disk with three open string punctures, an annulus A can be regarded as a disk with one closed string puncture, an annulus \bar{A} can be regarded as a disk with one closed string puncture and one open string puncture, a disk D can be regarded as a sphere with two closed string punctures and a half-disk d can be regarded as a disk with two open string punctures. This gives the Euler numbers of S to be -1 , H to be $-1/2$, \bar{A} to be $-1/2$ and A , D and d to be zero.

over gluing segments L_m separating the different coordinate patches:

$$\begin{aligned} \mathcal{B} \left[\frac{\partial}{\partial u^i} \right] \equiv & \sum_s \left[\oint_{C_s} \frac{\partial F_s}{\partial u^i} d\sigma_s b(\sigma_s) + \oint_{C_s} \frac{\partial \bar{F}_s}{\partial u^i} d\bar{\sigma}_s \bar{b}(\bar{\sigma}_s) \right] \\ & + \sum_m \left[\int_{L_m} \frac{\partial G_m}{\partial u^i} d\sigma_m b(\sigma_m) + \int_{L_m} \frac{\partial \bar{G}_m}{\partial u^i} d\bar{\sigma}_m \bar{b}(\bar{\sigma}_m) \right], \end{aligned} \quad (3.66)$$

where we define transition functions

$$\sigma_m = G_m(\tau_m, u^i), \quad (3.67)$$

that express the complex coordinate σ_m to the *left* of L_m in terms of the complex coordinate τ_m to the *right* of L_m , given the orientation of L_m that goes into the definition of the integral in (3.66). This choice defines signs in explicit calculations. With this understanding, for given set of n_c closed string states and n_o open string states we can introduce a p form $\Omega_p^{(g,b,n_c,n_o)}$ on $\widehat{\mathcal{P}}_{g,b,n_c,n_o}$ as in (3.44), for the case of bosonic open-closed amplitudes, and as in (3.58), for the case of open-closed superstring amplitudes. However some care is needed to specify the normalization of these forms since they are somewhat more involved than in the case of purely closed string amplitudes. For reference, we shall discuss the bosonic string p -forms with n_c closed string vertex operators and n_o open string vertex operators. We first define the *canonical* forms $\widehat{\Omega}_p^{(g,b,n_c,n_o)}(A_1^c, \dots, A_{n_c}^c; A_1^o, \dots, A_{n_o}^o)$ denoted with a hat. The contraction of $\widehat{\Omega}_p^{(g,b,n_c,n_o)}(A_1^c, \dots, A_{n_c}^c; A_1^o, \dots, A_{n_o}^o)$ with p tangent vectors of $\widehat{\mathcal{P}}_{g,b,n_c,n_o}$ is taken to be:

$$\begin{aligned} & \widehat{\Omega}_p^{(g,b,n_c,n_o)}(A_1^c, \dots, A_{n_c}^c; A_1^o, \dots, A_{n_o}^o) \left[\frac{\partial}{\partial u^{j_1}}, \dots, \frac{\partial}{\partial u^{j_p}} \right] \\ & \sim \left\langle \mathcal{B} \left[\frac{\partial}{\partial u^{j_1}} \right] \cdots \mathcal{B} \left[\frac{\partial}{\partial u^{j_p}} \right] A_1^c \cdots A_{n_c}^c; A_1^o \cdots A_{n_o}^o \right\rangle_{\Sigma_{g,b,n_c,n_o}}, \end{aligned} \quad (3.68)$$

where \sim denotes equality up to sign. Here the surface Σ_{g,b,n_c,n_o} has b boundary components, with the n_o punctures distributed among them as (n_o^1, \dots, n_o^b) so that $\sum_{i=1}^b n_o^i = n_o$. The $\widehat{\Omega}$'s defined above suffer from sign ambiguities, there being no canonical choice for the sign of the integration measure $du^{j_1} \wedge \cdots \wedge du^{j_p}$. We shall fix this problem in section 3.5 by choosing a specific convention for the sign of the integration measure and specific arrangement of the operators \mathcal{B} , A_i^c and A_i^o inside the correlator that will also depend on the Grassmann parities of the operators A_i^c and A_i^o . The normalized forms $\Omega_p^{(g,b,n_c,n_o)}(A_1^c, \dots, A_{n_c}^c; A_1^o, \dots, A_{n_o}^o)$ are then given by the canonical forms $\widehat{\Omega}$ multiplied by a normalization factor:

$$\Omega_p^{(g,b,n_c,n_o)}(A_1^c, \dots, A_{n_c}^c; A_1^o, \dots, A_{n_o}^o) \equiv N_{g,b,n_c,n_o} \widehat{\Omega}_p^{(g,b,n_c,n_o)}(A_1^c, \dots, A_{n_c}^c; A_1^o, \dots, A_{n_o}^o). \quad (3.69)$$

The normalization constants N_{g,b,n_c,n_o} are the analogs of the $(-\frac{1}{2\pi i})^{3g-3+n}$ factors in (3.44). With the specific prescription for the signs of $\widehat{\Omega}$ discussed in section 3.5, the result for N_{g,b,n_c,n_o} is given by

$$N_{g,b,n_c,n_o} = \eta_c^{3g-3+n_c+\frac{3}{2}b+\frac{3}{4}n_o}, \quad \eta_c \equiv -\frac{1}{2\pi i} = \frac{i}{2\pi}. \quad (3.70)$$

The form (3.69) for $p = d_{g,b,n_c,n_o}$ has to be integrated over a subspace $\mathcal{F}_{g,b,n_c,n_o}$ for which the projection to the moduli space $\mathcal{M}_{g,b,n_c,n_o}$ is a degree one map. The space $\mathcal{F}_{g,b,n_c,n_o}$ consists of disconnected components, one for each disconnected component of $\widehat{\mathcal{P}}_{g,b,n_c,n_o}$. Only after summing over the contributions from these disconnected components with appropriate relative signs can we

recover an amplitude that is symmetric under the exchange of external open string states. The amplitude $\mathcal{A}_{g,b}$ takes the form:

$$\begin{aligned} \mathcal{A}_{g,b}(A_1^c, \dots, A_{n_c}^c; A_1^o, \dots, A_{n_o}^o) \\ = (g_s)^{-\chi_{g,b,n_c,n_o}} \int_{\mathcal{F}_{g,b,n_c,n_o}} \Omega_{d_{g,b,n_c,n_o}}^{(g,b,n_c,n_o)}(A_1^c, \dots, A_{n_c}^c; A_1^o, \dots, A_{n_o}^o), \end{aligned} \quad (3.71)$$

where the integral over $\mathcal{F}_{g,b,n_c,n_o}$ is understood to include the sum over disconnected components of $\mathcal{F}_{g,b,n_c,n_o}$.

An exception to (3.68) arises for the closed string one-point function on the disk where we have a conformal Killing vector. Here we take, for Grassmann even A^c , and without sign ambiguity

$$\widehat{\Omega}_0^{(0,1,1,0)}(A^c) = \eta_c \langle c_0^- A^c \rangle, \quad (3.72)$$

where $c_0^- A^c$ is inserted in a local coordinate system w in which the disk boundary is at $|w| = e^\Lambda$ for some positive constant Λ . Consequently the form of (3.69) gives:

$$\Omega_0^{(0,1,1,0)}(A^c) = \eta_c N_{0,1,1,0} \langle c_0^- A^c \rangle. \quad (3.73)$$

We could have included the η_c factor in $N_{0,1,1,0}$, but in the form given above, (3.70) will also hold for $N_{0,1,1,0}$.

From the forms defined above we can derive a result similar to (3.51) for open string amplitudes. Let us define

$$c_o \equiv N_{g,b,n_c,n_o+1}/N_{g,b,n_c,n_o}. \quad (3.74)$$

We see from (3.70) that c_o does not depend on g, b, n_c, n_o . Let us now study the effect of inserting an on-shell open string state of the form cV_o to some given amplitude. For this let w be the local coordinate at the puncture where the open string is inserted, with the puncture situated at $w = 0$, and

$$z = G(w, u), \quad (3.75)$$

be the coordinate system in a patch of the surface that encloses the open set covered by the w coordinate. We shall assume that $G(w, u)$ is analytic in the half disk covered by the w coordinate. Then the location y of the puncture in the z coordinate system is $y = G(0, u)$. Up to additional insertions (denoted by dots) that we do not focus on, the effect of inserting the vertex operator cV_o is represented by the one-form

$$\Omega_1(cV_o) = c_o du \left\langle \dots \mathcal{B} \left[\frac{\partial}{\partial u} \right] cV_o(w=0) \right\rangle. \quad (3.76)$$

We now use the doubling trick to express the sum of the holomorphic and anti-holomorphic integrals along open contours in \mathcal{B} into integration over a closed contour surrounding the puncture at $w = 0$ or equivalently at $z = y$. Since cV_o is a dimension zero primary we have $cV_o(w=0) = cV_o(z=y)$ and therefore we have

$$\Omega_1(cV_o) = c_o du \left\langle \dots \oint b(z) dz \frac{\partial G(w, u)}{\partial u} cV_o(z=y) \right\rangle. \quad (3.77)$$

Since we have prescribed that the w coordinate system must be to the right of the contour, the contour is oriented clock-wise around the position of the puncture. The integral then gives

$$\Omega_1(cV_o) = -c_o du \frac{\partial y}{\partial u} \langle \dots V_o(z=y) \rangle = -c_o dy \langle \dots V_o(y) \rangle. \quad (3.78)$$

Here $V_o(y)$ is to be understood as the vertex operator at $z = y$ using the local coordinate $(z - y)$ vanishing at that insertion point.

In arriving at the last expression in (3.78) we had the operator \mathcal{B} in (3.76) placed immediately to the left of the vertex operator cV_o . In general, however, we have to move the \mathcal{B} through various other vertex operators and other \mathcal{B} 's, leading to additional factors of -1 . Therefore (3.78) is valid up to a sign. This is not a serious limitation since in any case the sign of N_{g,b,n_c,n_o} , and hence of c_o , is ambiguous until we fix the sign conventions for $\widehat{\Omega}$, and we shall fix this convention in section 3.5. This issue was absent in the case of closed string punctures since there the combination that appeared is $\mathcal{B}[\partial/\partial u]\mathcal{B}[\partial/\partial \bar{u}]$, and no extra sign appears as we move this combined operator through other operators.

Finally, note that a general background in string theory may contain multiple D-branes of the same type or different type and the spectrum and interaction of open strings will depend on that data. In our description of open-closed string amplitudes, we have implicitly assumed (and will continue to assume) that there is a single D-brane on which the open strings live. This, however, this can be easily generalized to the case of multiple D-branes. For example, if we have multiple D-branes of the same type then the external open strings will carry Chan-Paton factors and we have to take the trace of the product of Chan-Paton factors, separately for every boundary of the world-sheet. When there are different types of D-branes the analysis is a bit more complicated but follows the same route. For example the constant K appearing in (3.12) may now have different values for different open string sectors. We can take this effect into account by regarding K as a matrix instead of a number, and in computing the correlator, we have to have a factor of K inserted into the trace for each boundary separately.

Turning now briefly to open-closed superstring field theory, the relevant forms are a straightforward generalization of the expressions written before. We have

$$\begin{aligned} & \Omega_p^{(g,b,n_c,n_o)}(A_1^c, \dots, A_{n_c}^c; A_1^o, \dots, A_{n_o}^o) \left[\frac{\partial}{\partial u^{j_1}}, \dots, \frac{\partial}{\partial u^{j_k}}, \frac{\partial}{\partial y_{\alpha_1}}, \dots, \frac{\partial}{\partial y_{\alpha_\ell}}, \frac{\partial}{\partial \bar{y}_{\beta_1}}, \dots, \frac{\partial}{\partial \bar{y}_{\beta_\ell}} \right] \\ & \sim N_{g,b,n_c,n_o} \left\langle \mathcal{B} \left[\frac{\partial}{\partial u^{j_1}} \right] \cdots \mathcal{B} \left[\frac{\partial}{\partial u^{j_k}} \right] (-\partial \xi(y_{\alpha_1})) \cdots (-\partial \xi(y_{\alpha_\ell})) \right. \\ & \quad \left. (-\bar{\partial} \bar{\xi}(\bar{y}_{\beta_1})) \cdots (-\bar{\partial} \bar{\xi}(\bar{y}_{\beta_\ell})) \prod_{\alpha=l+1}^{N_R} \mathcal{X}(y_\alpha) \prod_{\beta=l+1}^{N_L} \bar{\mathcal{X}}(\bar{y}_\beta) A_1^c \cdots A_{n_c}^c A_1^o \cdots A_{n_o}^o \right\rangle_{\Sigma_{g,b,n_c,n_o}}, \quad (3.79) \end{aligned}$$

where the normalization constants N_{g,b,n_c,n_o} turn out to be the same as those for bosonic string theory and \sim denotes equivalence up to sign. One point that we need to keep in mind is that once we have Riemann surfaces with boundaries, the picture numbers in the holomorphic and anti-holomorphic sectors are not separately conserved, only the total picture number is conserved. The total picture number must add to $2(2g - 2 + b)$, consistent with total picture -2 for a disk and -4 for a sphere. The total number N of PCO insertions, as seen in the above formula is $N = N_R + N_L$. In the notation of (3.56), N is fixed by

$$2(2g - 2 + b) = N - 2n_{-1,-1} - \frac{3}{2}(n_{-1,-1/2} + n_{-1/2,-1}) - n_{-1/2,-1/2} - n_{-1} - \frac{1}{2}n_{-1/2}. \quad (3.80)$$

New here on the right-hand side are n_{-1} and $n_{-1/2}$ that denote, respectively, the number of NS and R (open string) vertex operators. Therefore, for a given set of punctures on a Riemann surface we have a choice of how to distribute the N PCOs into $N_R \geq 0$ holomorphic and $N_L \geq 0$ anti-holomorphic

PCOs. This information also constitutes data along the fiber of $\widehat{\mathcal{P}}_{g,b,n_c,n_o}^s$. For the closed string one-point function in open-closed superstrings an expression similar to (3.73) holds. The factor $(-\frac{1}{2\pi i})$ is also there, but the correlator includes picture changing operators for RR states in $\widetilde{\mathcal{H}}_c$ (see (4.62)).

3.5 Signs of forms in $\widehat{\mathcal{P}}_{g,b,n_c,n_o}$

In this subsection we shall discuss a specific choice of sign convention for the $\widehat{\Omega}_p^{(g,b,n_c,n_o)}$'s that is compatible with the normalization constants N_{g,b,n_c,n_o} appearing in (3.69). We shall consider the case $p = d_{g,b,n_c,n_o}$ and take the arguments A_i^c and A_j^o of $\widehat{\Omega}$ to be Grassmann even and Grassmann odd respectively, since this is what enters the construction of the string field theory action. To avoid cluttering, we shall drop the subscript d_{g,b,n_c,n_o} from $\widehat{\Omega}^{(g,b,n_c,n_o)}$. We shall briefly comment on the other cases later.

We begin by discussing the origin of the sign ambiguities. Unlike in the case of a closed string amplitude that contains the product $\mathcal{B}[\partial/\partial u]\mathcal{B}[p/\partial \bar{u}]$ which is Grassmann even, the open string amplitude contains $\mathcal{B}[\partial/\partial u]$ which is Grassmann odd. The vertex operators of open string states are also Grassmann odd. Therefore we can pick up additional minus signs when we move these operators through other Grassmann odd operators and the sign will depend on the relative arrangement of the \mathcal{B} 's and the vertex operators inside the correlator. We have already seen an example of this in the manipulations leading to (3.78). A related issue is that unlike closed string moduli $m = m_R + im_I$ that are complex and hence define a natural orientation via $dm \wedge d\bar{m} = -2i dm_R \wedge dm_I$ with the integral of $dm_R \wedge dm_I$ taken to be positive, for open strings the moduli are real and there is no natural choice of what constitutes positive integration measure. So the expression for $\widehat{\Omega}_p^{(g,b,n_c,n_o)}$ makes sense only after we have specified the positions of the \mathcal{B} 's inside the correlator and the orientation of the moduli space measure. For this reason, we shall now specify these rules. There is nothing sacred about these rules, – they give one definition of $\widehat{\Omega}^{(g,b,n_c,n_o)}$ appearing in (3.68) and the orientation of the moduli space integral, without which the sign of N_{g,b,n_c,n_o} will not be meaningful. For more details, we refer the reader to [22]. We shall describe these rules in the context of bosonic string theory, but generalization of these rules to superstring theory, that produce the same values of N_{g,b,n_c,n_o} as those given in (3.84), is straightforward.

1. First we shall describe the procedure for adding a boundary to a given amplitude. We take the expression for the form $\widehat{\Omega}^{(g,b+1,n_c,n_o)}$ to be the one that is obtained by starting with the form $\widehat{\Omega}^{(g,b,n_c+1,n_o)}$ with one more closed string puncture, and inserting into the extra puncture the one-form state $|\mathbf{b}\rangle$ given by

$$|\mathbf{b}\rangle = -\frac{dq_r}{q_r} (e^{-\Lambda} q_r)^{L_0 + \bar{L}_0} b_0^+ |B\rangle, \quad q_r \in [0, 1], \quad (3.81)$$

where $|B\rangle$ is the boundary state defined as follows. For any closed string state $|\chi\rangle$, $\langle B|\chi\rangle$ gives the one-point function of χ on the unit disk, with χ inserted at $w = 0$ using the local coordinate system w in which the disk takes the form $|w| \leq 1$. Since the one-point function of χ on the disk is non-vanishing only when χ has ghost number three and $\langle B|\chi\rangle$ is non-vanishing only when the ghost numbers of B and χ add up to six, we conclude that $|B\rangle$ has ghost number three. Hence $b_0^+ |B\rangle$ is a Grassmann even state and we can insert it anywhere inside the correlation function. One can also show that the state $|B\rangle$ is annihilated by b_0^- and L_0^- . The orientation of q_r integration is along the direction of increasing q_r , i.e. in the integral the upper limit should be larger than the lower limit. Λ is an arbitrary positive constant, – the same constant that

appears in the choice of the local coordinate on the disk in (3.72). With this understanding, the above relation fully fixes the form $\widehat{\Omega}^{(g,b+1,n_c,n_o)}$ once $\widehat{\Omega}^{(g,b,n_c+1,n_o)}$ is given. The parameter q_r , together with the location of the $(n_c + 1)$ -th puncture, comprise the three extra moduli that appear when we add a hole to the Riemann surface. This prescription can be used iteratively to add arbitrary number of boundaries starting with a Riemann surface with closed string punctures but no boundaries.

2. Next we shall describe the \mathcal{B} 's associated with the moduli describing location of open string punctures. For this suppose that we have some amplitude involving external closed and open strings and we want to insert one more external open string state. We shall first describe this for on-shell open strings with vertex operator cV_o since this is sufficient for specifying the sign. In this case, we insert into the original correlator the operator

$$dy V_o(y), \quad (3.82)$$

where y is the location of the operator on a boundary, and the integration along y is carried out along the boundary keeping the surface to the left. Here $V_o(y)$ has to be interpreted in the sense described below (3.78). It follows from the analysis described there that the prescription (3.82) is equivalent to inserting $(-\mathcal{B}[\partial/\partial u])$ immediately to the left of the unintegrated vertex operator $cV_o(u)$ (or equivalently, inserting $\mathcal{B}[\partial/\partial u]$ immediately to the right of the vertex operator). In this form, the prescription holds for any external open string states, not necessarily on-shell. Since the inserted operator is Grassmann even, there is no sign ambiguity arising from the location of the operator inside the correlation function.

3. The prescriptions described in items 1 and 2 above hold as long as all the open string vertex operators can be inserted in integrated form and we are allowed to integrate over the sizes of all the boundaries. This holds for $g > 0$ and $g = 0, n_c + b \geq 3$, since we can fix the locations of three of the closed string vertex operators and/or boundaries and integrate over all the open string positions and boundary sizes. However, for $g = 0, n_c + b < 3$ this is not possible, *e.g.* for open string amplitudes on the disk we need to use three unintegrated open string vertex operators.

The cases to consider here are

- $b = 1, n_c = 0$. These are disk amplitudes with $n_o \geq 3$. Here we shall use the convention that the three unintegrated vertex operators are placed inside the correlator in the order they appear as we travel along the boundary keeping the Riemann surface to the left and the rest of the open string operators are inserted following the prescription (3.82). Note that with three Grassmann odd unintegrated vertex operators there is no further sign ambiguity due to cyclicity.
- $b = 1, n_c = 1$. For the disk two-point function of one open and one closed strings there is no ambiguity since the closed string vertex operator is even and hence the open string vertex operator can be placed anywhere inside the correlator. However, we prescribe that in this case the correlator comes with an extra sign, *i.e.* for on-shell vertex operators we use [22]

$$\widehat{\Omega}^{(0,1,1,1)}(c\bar{c}V_c; cV_o) = -\langle cV_o c\bar{c}V_c \rangle. \quad (3.83)$$

Any further open string insertion can be treated using (3.82). This extra sign is surprising, but it is needed for compatibility with the general prescription for inserting integrated open string vertex operator as given in (3.82) [22].

- $b = 2, n_c = 0$. In this case we shall follow the prescription of replacing the closed string state in the open-closed disk amplitude (3.83) by the one-form state (3.81) keeping the open string position unintegrated. Any further open string insertion can be treated using (3.82).

It has been shown in [22] that with this definition of $\widehat{\Omega}^{(g,b,n_c,n_o)}$, the normalization constants N_{g,b,n_c,n_o} are given by,

$$N_{g,b,n_c,n_o} = \eta_c^{3g-3+n_c+\frac{3}{2}b+\frac{3}{4}n_o}. \quad (3.84)$$

where we have defined the constant η_c

$$\eta_c \equiv -\frac{1}{2\pi i} = \frac{i}{2\pi}, \quad (3.85)$$

and have used the freedom of redefining g_s to ensure that the closed string three point coupling has no extra normalization factor, i.e. $N_{0,0,3,0} = 1$.

We end this subsection with a few comments:

1. The solution for the N 's given in (3.84) holds for the choice of arrangement of the b 's inside the correlator as described earlier in this subsection. Starting from the prescription given above, we can move the b 's to wherever we like and/or modify the definition of the orientation of the integral over moduli spaces, at the cost of picking up additional signs. We shall absorb these signs into the definition of $\widehat{\Omega}$ itself, so that (3.84) is not affected.
2. In the specification of the signs, we have worked with $\Omega_{d_{g,b,n_c,n_o}}^{(g,b,n_c,n_o)}$ and taken the arguments A_i^c to be Grassmann even and A_j^o to be Grassmann odd. This will be sufficient to define the string field theory action. However, for intermediate steps in our analysis we need $\Omega_{d_{g,b,n_c,n_o}}^{(g,b,n_c,n_o)}$ for arguments with wrong Grassmann parity. Since these do not appear in the description of the string field theory action, we can choose them in any way we like and modify the intermediate steps of the analysis accordingly, but for definiteness we shall adopt the following prescription. Starting with the expression for $\widehat{\Omega}$ given above for even A_i^c 's and odd A_j^o 's, we first rearrange the operators inside the correlator so that they appear in the order $A_1^c, \dots, A_{n_c}^c, A_1^o, \dots, A_{n_o}^o$ followed by the b -ghost and boundary state insertions, picking up appropriate signs along the way. We then declare that this formula is valid for arbitrary choice of Grassmann parities of A_i^c 's and A_j^o 's. Once we have defined $\widehat{\Omega}_{d_{g,b,n_c,n_o}}^{(g,b,n_c,n_o)}$ for arbitrary Grassmann parities of A_i^c and A_j^o 's, the form $\Omega_{d_{g,b,n_c,n_o}}^{(g,b,n_c,n_o)}$ is declared to be given by (3.69) with N_{g,b,n_c,n_o} given by (3.84).
3. We also use $\widehat{\Omega}_p^{(g,b,n_c,n_o)}$ for $p \neq d_{g,b,n_c,n_o}$ during the intermediate steps of the analysis since we use identities of type (3.52). Since these do not appear in the form of the string field theory action, how we define them is up to us. One simple choice is provided by demanding that $\widehat{\Omega}$ satisfies the analog of (3.52), i.e. we have

$$\begin{aligned} & \widehat{\Omega}_p^{(g,b,n_c,n_o)}(QA_1^c, \dots, A_{n_c}; A_1^o, \dots, A_{n_o}^o) + \dots \\ & + (-1)^{A_1^c + \dots + A_n^c + A_1^o + \dots + A_{n_o}^o - 1} \widehat{\Omega}_p^{(g,b,n_c,n_o)}(A_1^c, \dots, A_{n_c}; A_1^o, \dots, QA_{n_o}^o) \\ & = (-1)^p d\widehat{\Omega}_{p-1}^{(g,b,n_c,n_o)}(A_1^c, \dots, A_{n_c}; A_1^o, \dots, A_{n_o}^o), \end{aligned} \quad (3.86)$$

and then declare that $\Omega_p^{(g,b,n_c,n_o)}(A_1^c, \dots, A_{n_c}; A_1^o, \dots, A_{n_o}^o)$ is given by (3.69) with the same normalization constants N_{g,b,n_c,n_o} as given in (3.84).

3.6 Batalin-Vilkovisky formalism

The usual approach to quantizing gauge theories begins with a classical action and its gauge invariance. We then choose some gauge, introduce Faddeev-Popov ghost fields and carry out the path integral over the original classical fields as well as the ghost fields to compute correlation functions of gauge invariant observables. There is a different but equivalent approach to quantizing gauge theories based on the Batalin-Vilkovisky (BV) formalism [44–46]. While for ordinary gauge theories it gives the same result as the Faddeev-Popov procedure, it has more general applicability and is particularly suited for string field theory. In this subsection we shall give a very short review of the BV formalism.

Let us suppose that we have a set of classical fields and some gauge transformations that leave the classical action invariant. Then fields that enter the BV formalism are as follows:

1. For every local gauge transformation parameter, we introduce a ghost field that carries Grassmann parity opposite to that of the parameters. Therefore Grassmann even gauge transformation parameters will lead to Grassmann odd ghost fields and vice versa.
2. If the gauge transformation itself has gauge transformations then we also introduce ghosts for these gauge transformation parameters. The Grassmann parity of these ghosts will be opposite to those of the ghosts associated with the original gauge transformation parameters. For example, if we have a bosonic p -form field Φ_p with gauge invariance under $\Phi_p \rightarrow \Phi_p + d\Lambda_{p-1}$ for some $(p-1)$ -form Λ_{p-1} , then we introduce Grassmann odd ghost fields $C_{p-1}^{(1)}$. But the gauge transformation parameter has its own gauge invariance under $\Lambda_{p-1} \rightarrow \Lambda_{p-1} + d\chi_{p-2}$ for some $(p-2)$ -form χ_{p-2} . So we need to introduce Grassmann even ghost fields $C_{p-2}^{(2)}$. This will continue until we reach zero-form ghost fields.
3. Once we have all the classical fields and the ghost fields, we call them collectively *fields*. For every field ψ_m , we introduce an anti-field ψ_m^* with opposite Grassmann parity.

Given two functionals F and G of the fields and the *anti-fields*, we define their anti-bracket as follows:

$$\{F, G\} = \frac{\partial_r F}{\partial \psi_m} \frac{\partial_\ell G}{\partial \psi_m^*} - \frac{\partial_r F}{\partial \psi_m^*} \frac{\partial_\ell G}{\partial \psi_m}, \quad (3.87)$$

where the sum over m also includes integration over the space-time coordinates and the subscripts ℓ and r of ∂ denotes left and right derivatives respectively. Note that left and right derivatives of an object A of Grassmanality $(-1)^A$ are related as follows

$$\frac{\partial_r A}{\partial \psi} = (-1)^{\psi(A+1)} \frac{\partial_\ell A}{\partial \psi}, \quad (3.88)$$

with ψ in the exponent equal to one, if ψ is odd, and zero, if even. The anti-bracket has a surprising exchange property:

$$\{F, G\} = -(-1)^{(F+1)(G+1)} \{G, F\}. \quad (3.89)$$

It is symmetric for even entries, and antisymmetric for odd ones. We also define a second-order differential operator Δ acting on a functional F of fields and anti-fields:

$$\Delta F = (-1)^{\psi_m} \frac{\partial_\ell}{\partial \psi_m} \frac{\partial_\ell F}{\partial \psi_m^*} = (-1)^{\psi_m F} \frac{\partial_r}{\partial \psi_m} \left(\frac{\partial_\ell F}{\partial \psi_m^*} \right). \quad (3.90)$$

The operator Δ is odd: ΔF and F have opposite Grassmanality. It also has a very important property: $\Delta^2 = 0$, as can be quickly verified with the above formula. In the geometrical description of BV quantization [47], this odd Laplacian Δ squaring to zero and a pointwise multiplication of functions are the starting point for the formulation, with the anti-bracket a derived concept. We will see how this works in section 7.1.

The classical BV master action S_{cl} is a functional of the fields and anti-fields that reduces to the original classical action when all the anti-fields are set to zero. It must also satisfy the classical BV master equation,

$$\{S_{cl}, S_{cl}\} = 0. \quad (3.91)$$

This actually guarantees that the classical master action is invariant under a set of gauge transformations that includes the gauge transformations of the original classical action. The quantum BV master action S satisfies the BV master equation:

$$\frac{1}{2}\{S, S\} + \Delta S = 0, \quad (3.92)$$

or, equivalently,

$$\Delta e^S = 0. \quad (3.93)$$

If g_s is the coupling constant of the theory, then tree-level n -point functions are of order g_s^{n-2} while g -loop n -point functions are of order g_s^{2g+n-2} . Using this we can see that the term proportional to $\{S, S\}$ dominates the term proportional to ΔS in the limit of small g_s . An action that satisfies the quantum BV equation admits consistent gauge fixing, and the theory has well-defined observables; the S-matrix of the theory is independent of the gauge-fixing conditions.

Gauge fixing in this theory is done as follows. One chooses an arbitrary Grassmann odd functional Ψ of the fields, sets the antifields to

$$\psi_m^* = \frac{\partial_\ell \Psi}{\partial \psi_m}, \quad (3.94)$$

and then carries out path integral over the set of fields $\{\psi_m\}$ weighted by e^S for calculation of the correlation functions. A somewhat singular gauge choice is $\Psi = 0$. This sets all the anti-fields to zero and the master action reduces to the classical action up to corrections that are suppressed by factors of order g_s^2 relative to their classical counterparts. The integration over the classical fields can be interpreted as the original path integral. Since ghosts have opposite statistics compared to the gauge transformation parameters, the integration over the ghost fields can be regarded as division by the volume of the gauge group. This is not suitable, however, for perturbation expansion since the kinetic operators for gauge fields are not invertible and therefore propagators cannot be defined. More familiar choices of gauge correspond to other choices of Ψ .

Even though we introduced the anti-fields in a way that seems to put them on a different footing than the fields, we can make field redefinitions that mix the fields and anti-fields preserving the anti-bracket, i.e. the anti-brackets computed using the new fields and anti-fields must give us back the original result. For example it is easy to check that with new tilde fields and tilde anti-fields given by

$$\tilde{\psi}_m^* = \psi_m^* - \frac{\partial_\ell \Psi}{\partial \psi_m}, \quad \tilde{\psi}_m = \psi_m, \quad (3.95)$$

the antibracket is left invariant. Therefore the gauge fixing described in (3.94) can also be regarded as setting the new anti-fields to zero. To make this freedom of redefining the fields and anti-fields

manifest, one often combines the fields and the anti-fields into a single set of fields ψ^i and introduces a symplectic pairing ω^{ij} between fields of opposite Grassmann parity, in terms of which we can write,

$$\begin{aligned} \{F, G\} &= \frac{\partial_r F}{\partial \psi^i} \omega^{ij} \frac{\partial_l G}{\partial \psi^j}, & \omega^{ij} &= -\omega^{ji}, \\ \Delta F &= \frac{1}{2} (-1)^{\psi^i} \frac{\partial_l}{\partial \psi^i} \left(\omega^{ij} \frac{\partial_l F}{\partial \psi^j} \right) = \frac{1}{2} (-1)^{\psi^i F} \frac{\partial_r}{\partial \psi^i} \left(\omega^{ij} \frac{\partial_l F}{\partial \psi^j} \right). \end{aligned} \quad (3.96)$$

4 Bosonic and superstring field theories

The main goal of this section is to give a quick overview of all the bosonic and superstring field theories. The detailed mathematical structure behind these constructions will be described in the later sections. We shall first describe various closed string field theories (bosonic, type II, and heterotic) and then turn to tree-level open string field theory and open-closed string field theory. We write explicitly the kinetic terms for the massless sector of the free bosonic string field theories. The free string field theories require the BRST operator of the conformal field theory and the BPZ inner product reviewed in the previous section, which is supplemented with a c_0^- insertion for the closed string theory. Such free field theories were first considered in the early work on covariant string theory [48–51]. Some of the early approaches to covariant string field theory used the light-cone version of the string vertices, with an auxiliary string length parameter [52–54]. This Kyoto group formulation was consistent for the classical theories, but had complications at the quantum level.⁶

We begin with preliminary comments on the string field. The original ingredient is the (complex) vector space of a CFT or some well-defined subspace of this vector space. We call this vector space \mathcal{H} , and view it as the space spanned by a set of local vertex operators. In this vector space there is a grading, a degree usually related to ghost number that determines the Grassmannality of the operators. Let the vertex operator φ_i be a basis vector in \mathcal{H} of definite Grassmannality. For every such basis vector we introduce a target-space field ψ^i with Grassmannality correlated to that of the operator φ_i ; opposite Grassmannality for open strings, the same Grassmannality for closed strings. The string field vertex operator Ψ is obtained by summing over all basis vectors the product of the basis vector times the associated target-space field:

$$\Psi = \sum_i \varphi_i \psi^i. \quad (4.1)$$

The Grassmannality of each term in the above sum is the sum of the Grassmannality of the basis vector φ_i and that of the target space field ψ^i . Given the above stated correlations, the bosonic open string field vertex operator is odd and the bosonic closed string field vertex operator is even. With the target space fields ψ^i being Grassmann objects (and not plain complex numbers), string fields are not just elements of the complex vector space \mathcal{H} but rather elements of a G -module \mathcal{H}_G , where the G is for Grassmann [56]. The string field action itself is an element of the Grassmann algebra, a function of the target space fields. Having noted this, in what follows we will identify (with a little abuse of notation) the vector space \mathcal{H} with the module \mathcal{H}_G . One consequence of this is that the Grassmannality of an element of \mathcal{H} is no longer determined only by its ghost number.

It is sometimes convenient to work with a string field state $|\Psi\rangle = \Psi(0)|0\rangle$, obtained by letting the string field vertex operator act on the vacuum. Writing $|\varphi_i\rangle = \varphi_i(0)|0\rangle$, and letting equation (4.1)

⁶An approach to a covariantized light-cone version with a physical string length was discussed by T. Kugo (see [55]).

act on the vacuum we have

$$|\Psi\rangle = \sum_i (-1)^{\psi^i \epsilon_0} |\varphi_i\rangle \psi^i, \quad (4.2)$$

where ψ^i in the exponent is even (odd) if ψ^i is Grassmann even (odd), and ϵ_0 is even (odd) if $|0\rangle$ is Grassmann even (odd). Note that when the Grassmanality of the vacuum is even, both Ψ and $|\Psi\rangle$ have the same Grassmanality. When the Grassmanality of the vacuum is odd, Ψ and $|\Psi\rangle$ have opposite Grassmanality. As we will see, it is sometimes useful for open strings to use a Grassmann odd vacuum. For closed strings the Grassmanality of the vacuum is chosen to be even, so both the vertex operator and state picture of the string field have the same Grassmanality and the sign factor in the above equation is not needed. When stating the Grassmanality of the string field below, we are referring to the vertex operator string field, unless noted otherwise.

4.1 Closed bosonic string field theory

We begin with the closed bosonic string field theory, mostly following [6] and references cited there, with the perspective that later developments have given. The formulation of closed bosonic string field theory involves the following ingredients:

1. A string field $|\Psi\rangle$ taking value in the space of states of the world-sheet conformal field theory of matter and ghost fields, satisfying the level-matching conditions

$$b_0^- |\Psi\rangle = 0, \quad L_0^- |\Psi\rangle = 0. \quad (4.3)$$

We have called \mathcal{H}_c this subspace of the world-sheet conformal field theory, and thus we have

$$\Psi \in \mathcal{H}_c. \quad (4.4)$$

As discussed in section 3.1, the natural non-degenerate bilinear inner product $\langle A, B \rangle$ in \mathcal{H}_c is given by (3.15):

$$\langle A, B \rangle \equiv \langle A | c_0^- | B \rangle \quad |A\rangle, |B\rangle \in \mathcal{H}_c. \quad (4.5)$$

and satisfies

$$\langle A, B \rangle = (-1)^{(A+1)(B+1)} \langle B, A \rangle, \quad (4.6)$$

as well as

$$\langle \lambda A, B \eta \rangle = \lambda \langle A, B \rangle \eta, \quad (4.7)$$

for λ, η constants of arbitrary Grassmanality.

2. The string field vertex operator Ψ is Grassmann even, i.e. if ζ is a Grassmann odd number then $\zeta\Psi = \Psi\zeta$. The state $|\Psi\rangle$ is also even. If we expand Ψ as a linear combination of vertex operators, then the coefficient of vertex operators of even ghost number must be Grassmann even and the coefficient of the vertex operator of odd ghost number must be Grassmann odd.
3. The background independent geometric content of the theory is encapsulated by string ‘vertices’ $\mathcal{V}_{g,n}$ which are $6g - 6 + 2n$ dimensional chains in $\widehat{\mathcal{P}}_{g,n}$, symmetric under the permutations of the punctures and satisfying the geometric form of the BV master equation:

$$\partial \mathcal{V}_{g,n} = -\Delta_c \mathcal{V}_{g-1,n+2} - \frac{1}{2} \sum_{\substack{g_1+g_2=g \\ n_1+n_2=n+2}} \{\mathcal{V}_{g_1,n_1}, \mathcal{V}_{g_2,n_2}\}_c. \quad (4.8)$$

We shall explain the various terms in this equation below. First of all, the $\mathcal{V}_{g,n}$ exist for the following values of g and n :

$$\text{General collection of } \mathcal{V}_{g,n} = \begin{cases} \mathcal{V}_{0,n}, & n \geq 3, \\ \mathcal{V}_{1,n}, & n \geq 1, \\ \mathcal{V}_{g,n}, & n \geq 0, \quad g \geq 2. \end{cases} \quad (4.9)$$

Of course, it may be that the $\mathcal{V}_{g,n}$ are parts of sections over $\widehat{\mathcal{P}}_{g,n}$, or if not, subspaces of $\widehat{\mathcal{P}}_{g,n}$ mapping with degree one to the image on $\mathcal{M}_{g,n}$. But the general case is when the $\mathcal{V}_{g,n}$ are chains, which, of course include the simpler possibilities. The Δ_c and $\{\cdot\}_c$ operations on the chains in $\widehat{\mathcal{P}}_{g,n}$ are defined as follows. First let us consider $\{\mathcal{V}_{g_1,n_1}, \mathcal{V}_{g_2,n_2}\}_c$. Let us pick Riemann surfaces Σ_{g_1,n_1} and Σ_{g_2,n_2} , equipped with local coordinates at the punctures, corresponding to particular points in \mathcal{V}_{g_1,n_1} and \mathcal{V}_{g_2,n_2} respectively. We now pick one puncture of Σ_{g_1,n_1} and another puncture of Σ_{g_2,n_2} and call their local coordinates w_1 and w_2 respectively. Due to the symmetry of the vertices under the permutation of the punctures, it does not matter which punctures we choose. We now glue the Riemann surfaces Σ_{g_1,n_1} and Σ_{g_2,n_2} by identifying the local coordinates w_1 and w_2 via,

$$w_1 w_2 = e^{i\theta}, \quad 0 \leq \theta \leq 2\pi. \quad (4.10)$$

This *twist gluing* operation generates a one parameter family of Riemann surfaces of genus $g_1 + g_2$ and $n_1 + n_2 - 2$ punctures, labelled by θ . Furthermore, the local coordinates at the punctures on Σ_{g_1,n_1} and Σ_{g_2,n_2} give local coordinates at the $(n_1 + n_2 - 2)$ punctures of the new Riemann surfaces. Repeating this process for each pair of points in \mathcal{V}_{g_1,n_1} and \mathcal{V}_{g_2,n_2} , we generate a $(6g_1 - 6 + 2n_1) + (6g_2 - 6 + 2n_2) + 1$ dimensional chain in $\widehat{\mathcal{P}}_{g_1+g_2,n_1+n_2-2}$. This chain is defined to be $\{\mathcal{V}_{g_1,n_1}, \mathcal{V}_{g_2,n_2}\}_c$.

The definition of $\Delta_c \mathcal{V}_{g,n}$ is similar; we pick a surface $\Sigma_{g,n}$ corresponding to a point in $\mathcal{V}_{g,n}$ and identify the local coordinates of two punctures on $\Sigma_{g,n}$ as in (4.10). This is repeated for every surface in $\mathcal{V}_{g,n}$. As a result, the Δ_c operation increases the genus by one and reduces the number of punctures by two, producing a $6g - 6 + 2n + 1$ dimensional chain of $\widehat{\mathcal{P}}_{g+1,n-2}$.

4. We define a set of multilinear maps from $\mathcal{H}_c^{\otimes n}$ to the space of complex numbers or, more precisely when using string fields, to the Grassmann algebra of target space fields. The maps, denoted as $\{A_1, \dots, A_n\}$, with $n \geq 1$ are defined as follows:⁷

$$\begin{aligned} \{A_1, \dots, A_n\} &\equiv \sum_{g=0}^{\infty} (g_s)^{-\chi_{g,n}} \{A_1, \dots, A_n\}_g \\ &\equiv \sum_{g=0}^{\infty} g_s^{2g+n-2} \int_{\mathcal{V}_{g,n}} \Omega_{d_{g,n}}^{(g,n)}(A_1, \dots, A_n). \end{aligned} \quad (4.11)$$

Here, $\mathcal{V}_{g,n}$ are the string vertices introduced above, and $\Omega_p^{(g,n)}$ is the p -form in $\widehat{\mathcal{P}}_{g,n}$ defined in (3.44). For $n = 1, 2$ the above sum over genus begins at $g = 1$. The products $\{A_1, \dots, A_n\}$ are graded commutative.

⁷We are using the same symbol $\{\dots\}$ to denote the multilinear map from product of \mathcal{H}_c to the Grassmann algebra and anti-brackets. Which one we are using should be clear from the context.

5. We also define multilinear string products $[A_1, \dots, A_n]$ that map $\mathcal{H}_c^{\otimes n}$ to \mathcal{H}_c , using the multilinear maps to the complex numbers and the bilinear inner product:

$$\langle A_0, [A_1, \dots, A_n] \rangle = \{A_0, \dots, A_n\}, \quad \forall A_0 \in \mathcal{H}_c. \quad (4.12)$$

Just like the multilinear maps to the complex numbers are sums of contributions over genus, we have

$$[A_1, \dots, A_n] \equiv \sum_{g=0}^{\infty} g_s^{2g+n-1} [A_1, \dots, A_n]_g. \quad (4.13)$$

Due to the Grassmann odd c_0^- factor in the definition of the inner product given in (3.15), $[A_1, \dots, A_n]$ has opposite Grassmann parity compared to the sum of the Grassmann parities of the A_i 's (the product carries intrinsic degree one). At a practical level we can implement this by declaring that while moving a Grassmann odd number through $[$ we pick an extra minus sign, i.e. $[$ acts as a Grassmann odd object. The other property that will be useful is that if A_1, \dots, A_n are Grassmann even, then $[A_1, \dots, A_n]$ is Grassmann odd and $\{A_1, \dots, A_n\}$ is Grassmann even.

6. As a consequence of the geometric recursion (4.8) and the CFT Ward identities (3.52), we have the *main identity* [6],

$$\begin{aligned} & \sum_{i=1}^N \{A'_1 \dots A'_{i-1} (QA'_i) A'_{i+1} \dots A'_N\} \\ = & -\frac{1}{2} \sum_{\substack{\ell, k \geq 0 \\ \ell + k = N}} \sum_{\substack{\{i_a; a=1, \dots, \ell\} \\ \{j_b; b=1, \dots, k\} \\ \{i_a\} \cup \{j_b\} = \{1, \dots, N\}}} \{A'_{i_1} \dots A'_{i_\ell} \varphi_s\} \{\varphi_r A'_{j_1} \dots A'_{j_k}\} \langle \varphi_s^c, \varphi_r^c \rangle \\ & -\frac{1}{2} \{A'_1 \dots A'_N \varphi_s \varphi_r\} \langle \varphi_s^c, \varphi_r^c \rangle, \end{aligned} \quad (4.14)$$

where $A'_i = \epsilon_i A_i$ (without any sum over i) where ϵ_i is a Grassmann even (odd) c-number if A_i is Grassmann even (odd). Therefore the A'_i 's are always Grassmann even. The sum over i_k 's and j_k 's run over inequivalent sets, *e.g.* we do not sum over different permutations of i_k 's or different permutations of j_k 's. However, in the second line we do sum over the sets related by the exchange of $\{i_1, \dots, i_\ell\}$ and $\{j_1, \dots, j_k\}$, – this is cancelled by the factor of 1/2 multiplying the sum. The states $\{|\varphi_r\rangle\}$ and $\{|\varphi_r^c\rangle\}$ are both complete set of basis states in \mathcal{H}_c , satisfying,

$$\langle \varphi_r^c, \varphi_s \rangle = \langle \varphi_s, \varphi_r^c \rangle = \delta_{rs}. \quad (4.15)$$

The first equality follows because for any non-vanishing inner product of vertex operators the two operators must have opposite Grassmanality, and therefore symmetry follows from the exchange relation (4.6). Therefore we also have

$$\langle \varphi_i, \varphi_j \rangle = \langle \varphi_j, \varphi_i \rangle, \quad \text{and} \quad \langle \varphi_i^c, \varphi_j^c \rangle = \langle \varphi_j^c, \varphi_i^c \rangle. \quad (4.16)$$

Note also that any non-vanishing overlap is necessarily a commuting number. Of course, the two basis vectors are related, for example, $\varphi_j = \sum_k \langle \varphi_j, \varphi_k \rangle \varphi_k^c$. We shall not give a detailed proof of (4.14), but the logic behind the proof can be found in section 7.3, where we shall give a direct proof of the fact that the string field theory action satisfies the BV master equation.

We can strip off the products of ϵ_i 's from both sides of (4.14) by moving them to the extreme left using the properties mentioned below (4.13) and write the identity in terms of the original variables A_i by keeping track of the signs of various terms that arise while making the rearrangement of the ϵ_i 's. Note that this main identity, with N arbitrary but fixed, contains a number of identities relating multilinear products at various genera. These are obtained by expansion of all terms in powers of g_s , with independent equalities holding for each power of g_s .

7. The main identity (4.14) given above can also be expressed in terms of the products [] as follows:

$$Q[A'_1 \cdots A'_N] = - \sum_{i=1}^N [A'_1 \cdots A'_{i-1} (QA'_i) A'_{i+1} \cdots A'_N] \quad (4.17)$$

$$- \sum_{\substack{\ell, k \geq 0 \\ \ell + k = N}} \sum_{\substack{\{i_a; a=1, \dots, \ell\} \\ \{j_b; b=1, \dots, k\} \\ \{i_a\} \cup \{j_b\} = \{1, \dots, N\}}} [A'_{i_1} \cdots A'_{i_\ell} [A'_{j_1} \cdots A'_{j_k}]] - \frac{1}{2} [A'_1 \cdots A'_N \varphi_s \varphi_r] \langle \varphi_s^c, \varphi_r^c \rangle.$$

As we shall explain in section 6.3, (4.17) without the last term defines an L_∞ algebra. With the last term, it is a 'quantum' version of the L_∞ algebra.

8. The BV master action of closed bosonic string field theory is given by,

$$S = \frac{1}{2} \langle \Psi, Q\Psi \rangle + \sum_{n=1}^{\infty} \frac{1}{n!} \{\Psi^n\}. \quad (4.18)$$

As will be explained in (7.37), this action satisfies the BV master equation (3.92) with the anti-bracket and Δ defined as in (3.96), with the following definition of ω^{ij} . Let us expand the string field Ψ in the complete set of basis states φ_r as

$$\Psi = \sum_r \varphi_r \psi^r \quad \rightarrow \quad \delta\Psi = \sum_r \varphi_r \delta\psi^r, \quad (4.19)$$

where we noted the expression for a first order variation of the string field. Let F and G be two functions of the string field Ψ , i.e. functions of the coefficients ψ^r of expansion of Ψ is some basis in \mathcal{H}_c . We use their variations to define string fields F_R and G_L :

$$\delta F = \sum_k \frac{\partial^r F}{\partial \psi^k} \delta \psi^k = \langle F_R, \delta\Psi \rangle \quad \rightarrow \quad \frac{\partial^r F}{\partial \psi^k} = \langle F_R, \varphi_k \rangle,$$

$$\delta G = \sum_k \delta \psi^k \frac{\partial^l G}{\partial \psi^k} = \langle \delta\Psi, G_L \rangle \quad \rightarrow \quad \frac{\partial^l G}{\partial \psi^k} = (-1)^{\varphi_k} \langle \varphi_k, G_L \rangle, \quad (4.20)$$

where φ_k in the exponent denotes the ghost number of φ_k . Then we define the anti-bracket of F and G to be,

$$\{F, G\} = -\langle F_R, G_L \rangle. \quad (4.21)$$

Then we have, comparing (3.96) and (4.21)

$$\omega^{rs} = (-1)^{\varphi_s+1} \langle \varphi_r^c, \varphi_s^c \rangle, \quad \omega_{rs} = (-1)^{\varphi_r+1} \langle \varphi_r, \varphi_s \rangle, \quad (4.22)$$

where ω_{rs} is the matrix inverse of ω^{rs} . Using (4.22) one can check that among an infinite number of choices, the following decompositions into fields and anti-fields are possible and particularly useful:

- (a) Up to signs, the coefficients of the states of ghost number ≥ 3 can be regarded as anti-fields and the coefficients of the states of ghost number ≤ 2 can be regarded as fields.
- (b) Up to signs, the coefficients of the states annihilated by c_0^+ can be regarded as anti-fields and the coefficients of the states annihilated by b_0^+ can be regarded as fields.

Note that, as required, for such choices ω_{rs} does not couple fields to fields, nor does it couple antifields with antifields.

Requiring that the variation of the string action (4.18) under first order variation of Ψ vanishes and using the non-degeneracy of the inner product, we get the string field equation. This can be expressed in terms of string products as follows:

$$Q\Psi + \sum_{n=1}^{\infty} \frac{1}{n!} [\Psi^n] = 0. \quad (4.23)$$

If in the definition of $\{\dots\}$ and $[\dots]$ we include only the genus zero contribution to the correlators, then they will satisfy an identity of the form (4.14) (or (4.17)) with only genus zero contributions, and without a contribution from the last term in the identity. Indeed, at genus zero the multilinear form has the power g_s^{N-2} with N the number of string fields. Therefore the first term in (4.14) has a power of g_s^{N-2} , the term in the second line has a power of $g_s^{\ell+1-2} g_s^{k+1-2} = g_s^{\ell+k-2} = g_s^{N-2}$, but the last term has a power $g_s^{N+2-2} = g_s^N$, so it does not contribute to the relation. The action S , restricted also to genus zero contribution, is the classical master action

$$S_{\text{cl}} = \frac{1}{2} \langle \Psi, Q\Psi \rangle + \sum_{n=3}^{\infty} \frac{1}{n!} \{\Psi^n\}_0. \quad (4.24)$$

This satisfies the classical master equation (3.91) on account of the genus zero main identity. Moreover, one can show that this classical master action is invariant under an infinitesimal gauge transformation,

$$\delta\Psi = Q\Lambda + \sum_{n=1}^{\infty} \frac{1}{n!} [\Lambda, \Psi^n]_0 = Q\Lambda + [\Lambda, \Psi]_0 + \frac{1}{2!} [\Lambda, \Psi, \Psi]_0 + \frac{1}{3!} [\Lambda, \Psi, \Psi, \Psi]_0 + \dots, \quad (4.25)$$

where $|\Lambda\rangle$ is an arbitrary Grassmann odd state in \mathcal{H}_c .

String fields of ghost number two are known as classical string fields. Other fields have the interpretation of ghost fields and the anti-fields of the classical string fields and the ghost fields. The classical action is obtained by setting to zero all fields of ghost number $\neq 2$ in the action (4.24). This action is invariant under a gauge transformation of the form given in (4.25) with $|\Lambda\rangle$ restricted to be a state of ghost number one. The full BV master action can be regarded as a tool to quantize this classical string field theory.

4.2 Type II superstring field theory

In this section we follow the approach of [19, 20]. In closed superstring field theory we still use a state space \mathcal{H}_c spanned by states that are annihilated by b_0^- and L_0^- . Moreover, we have to describe four subsectors; the NS-NS, NS-R, R-NS, and R-R sectors of the state space. For each of these subsectors we define string fields as elements of \mathcal{H}_c with fixed holomorphic and antiholomorphic picture numbers.

As in the case of closed bosonic string field theory, the Grassmannality of a closed superstring field is the Grassmanality of the vertex operator plus that of the target space field. That full

Grassmanality is even for the closed superstring field in all four subsectors. This means that the Grassmanality of the vertex operator and that of its target space field are always the same. The usual spin-statistics relation holds, *e.g.* the classical target space fields (bosons) in the R-R and NS-NS sectors are Grassmann even whereas the classical target space string fields (fermions) in the R-NS and NS-R sectors are Grassmann odd. This follows because the relevant NS vertex operators are even, while the relevant R vertex operators are odd.

The canonical choice is picture number -1 in the NS sector and picture number $-1/2$ or $-3/2$ in the R sector. This is natural because these are the only picture numbers for which the spectrum of the L_0 operator is bounded from below. In other picture numbers, the vacuum fails to be annihilated by one or more β_n or γ_n oscillators with positive n , and by repeatedly applying them on the vacuum we can get states of arbitrarily negative L_0 eigenvalue.

The formulation of string field theory that we are going to describe makes use of the -1 picture states for the NS sector, and of *both* $-1/2$ and $-3/2$ picture number states in the Ramond sector. Let $\mathcal{H}_{p,q} \subset \mathcal{H}_c$ denote the space of string states of anti-holomorphic picture number p and holomorphic picture number q . Perhaps surprisingly, we introduce two string fields, Ψ and $\tilde{\Psi}$, each a direct sum over the four sectors of the theory:

$$\text{Type II string fields:} \quad \Psi \in \mathcal{H}_c \equiv \mathcal{H}_{-1,-1} \oplus \mathcal{H}_{-1,-1/2} \oplus \mathcal{H}_{-1/2,-1} \oplus \mathcal{H}_{-1/2,-1/2}, \quad (4.26)$$

$$\tilde{\Psi} \in \tilde{\mathcal{H}}_c \equiv \mathcal{H}_{-1,-1} \oplus \mathcal{H}_{-1,-3/2} \oplus \mathcal{H}_{-3/2,-1} \oplus \mathcal{H}_{-3/2,-3/2}. \quad (4.27)$$

Note that Ψ uses the $-1/2$ picture for the R sectors and $\tilde{\Psi}$ uses the $-3/2$ picture for the R sectors. Since the BPZ inner product between a pair of states requires the picture numbers of the states to add up to $(-2, -2)$, it pairs states in \mathcal{H}_c and $\tilde{\mathcal{H}}_c$. Both Ψ and $\tilde{\Psi}$ are Grassmann even.

The construction of the action below only requires multilinear maps to the Grassmann algebra for string fields in \mathcal{H}_c . We thus define $\{A_1, \dots, A_n\}$ for $A_i \in \mathcal{H}_c$ in the same way as (4.11), with $\Omega^{(g,n)}$ given by (3.58) and $\mathcal{V}_{g,n}$ possibly containing vertical segments. $\mathcal{V}_{g,n}$ is required to satisfy a relation similar to (4.8), but with a somewhat different definitions of Δ_c and $\{, \}_c$. For this, recall that $\{, \}_c$ denotes the result of gluing two punctures on two Riemann surfaces using the identification $w_1 w_2 = e^{i\theta}$ and Δ_c denotes the result of gluing two punctures on the same Riemann surface. For superstring theory there are four different kinds of punctures – they can be of type NSNS, NSR, RNS and RR, depending on what type of vertex operator is inserted at the puncture. The gluing operations do not mix those different kinds of punctures. If the punctures are of NSNS type then we continue to use the same definition of $\{, \}_c$ and Δ_c as in the case of bosonic string theory. If the punctures are of RNS, NSR or RR type, then we insert respectively a uniform average of the PCO $\bar{\mathcal{X}}$, \mathcal{X} or both along the gluing circle $|w_1| = 1$. As a result, the identity (4.14) is now replaced by

$$\begin{aligned} & \sum_{i=1}^N \{A'_1 \dots A'_{i-1} (Q A'_i) A'_{i+1} \dots A'_N\} \\ &= -\frac{1}{2} \sum_{\substack{\ell, k \geq 0 \\ \ell + k = N}} \sum_{\substack{\{i_a; a=1, \dots, \ell\} \\ \{j_b; b=1, \dots, k\} \\ \{i_a\} \cup \{j_b\} = \{1, \dots, N\}}} \{A'_{i_1} \dots A'_{i_\ell} \varphi_s\} \{\varphi_r A'_{j_1} \dots A'_{j_k}\} \langle \varphi_s^c, \mathcal{G} \varphi_r^c \rangle \\ & \quad - \frac{1}{2} \{A'_1 \dots A'_N \varphi_s \varphi_r\} \langle \varphi_s^c, \mathcal{G} \varphi_r^c \rangle, \end{aligned} \quad (4.28)$$

where $|\varphi_s\rangle$ are now basis states in \mathcal{H}_c and $|\varphi_s^c\rangle$ are the basis states in $\tilde{\mathcal{H}}_c$. The \mathcal{G} operator is defined as follows. We first define the zero modes of the PCOs:

$$\mathcal{X}_0 = \oint \frac{dz}{z} \mathcal{X}(z), \quad \bar{\mathcal{X}}_0 = \oint \frac{d\bar{z}}{\bar{z}} \bar{\mathcal{X}}(\bar{z}). \quad (4.29)$$

Then \mathcal{G} is defined by:

$$\mathcal{G} = \begin{cases} \mathbf{1} & \text{on } \mathcal{H}_{-1,-1} \\ \mathcal{X}_0 & \text{on } \mathcal{H}_{-1,-3/2} \\ \bar{\mathcal{X}}_0 & \text{on } \mathcal{H}_{-3/2,-1} \\ \mathcal{X}_0 \bar{\mathcal{X}}_0 & \text{on } \mathcal{H}_{-3/2,-3/2}. \end{cases} \quad (4.30)$$

Here $\mathbf{1}$ is the identity operator. The effect of \mathcal{X}_0 acting on a state inserted at $w = 0$ is precisely to insert a uniform average of a PCO insertion along the circle $|w| = 1$. Note that the operator \mathcal{G} maps $\tilde{\mathcal{H}}_c$ to \mathcal{H}_c by changing appropriately the picture numbers.

In this notation the BV master action of superstring field theory takes the form:⁸

$$S = -\frac{1}{2} \langle \tilde{\Psi}, Q \mathcal{G} \tilde{\Psi} \rangle + \langle \tilde{\Psi}, Q \Psi \rangle + \sum_{n=1}^{\infty} \frac{1}{n!} \{ \Psi^n \}. \quad (4.31)$$

Note that $\tilde{\Psi}$ appears only in the quadratic terms in the action. For this reason it describes a free field. Therefore even though we start with double the number of physical string states, half of these states do not take part in the interaction. The other half describes the interacting field theory of type II strings. It is possible to set $\tilde{\Psi} = \Psi$ in the NSNS sector without changing the interacting part of the theory, but we shall proceed by treating $\tilde{\Psi}$ and Ψ as independent variables in all four sectors.

The action in (4.31) satisfies the BV master equation with the definition of ω^{ij} that we give now implicitly as follows. For an arbitrary function $F(\Psi, \tilde{\Psi})$, let us express the first order variation of F under arbitrary variation of $\Psi, \tilde{\Psi}$ as

$$\delta F = \langle F_R, \delta \tilde{\Psi} \rangle + \langle \tilde{F}_R, \delta \Psi \rangle = \langle \delta \tilde{\Psi}, F_L \rangle + \langle \delta \Psi, \tilde{F}_L \rangle. \quad (4.32)$$

Then the anti-bracket of F and G is defined as [19]

$$\{F, G\} = -\langle F_R, \tilde{G}_L \rangle - \langle \tilde{F}_R, G_L \rangle - \langle \tilde{F}_R, \mathcal{G} \tilde{G}_L \rangle. \quad (4.33)$$

This implicitly defines ω^{rs} via (3.96), once we write the expansions $\Psi = \sum_r \varphi_r \psi^r$ and $\tilde{\Psi} = \sum_r \varphi_r^c \tilde{\psi}^r$, where φ_r and φ_r^c are the basis states satisfying (4.15). Note however that the use of the basis φ_r for Ψ and φ_r^c for $\tilde{\Psi}$ is purely a matter of convenience. We could use any other basis for the expansion and the explicit forms of ω^{rs} and ω_{rs} will be different in another basis.

We can also generalize (4.12) to define multilinear products of elements in \mathcal{H}_c :

$$\langle A_1, [A_1, \dots, A_n] \rangle = \{A_1, \dots, A_n\}. \quad (4.34)$$

It follows from picture number conservation rules that $[A_1, \dots, A_n] \in \tilde{\mathcal{H}}_c$ for $A_1, \dots, A_n \in \mathcal{H}_c$. This was expected since the bilinear form couples \mathcal{H}_c to $\tilde{\mathcal{H}}_c$.

As in the case of bosonic string field theory, the classical action is obtained by setting to zero all string fields of ghost number other than two and including contribution from only the genus zero interaction terms. The corresponding action is invariant under the gauge transformation,

$$\delta |\tilde{\Psi}\rangle = Q |\tilde{\Lambda}\rangle + \sum_{n=2}^{\infty} \frac{1}{n!} [\Lambda \Psi^n]_0, \quad \delta |\Psi\rangle = Q |\Lambda\rangle + \sum_{n=2}^{\infty} \frac{1}{n!} \mathcal{G} [\Lambda \Psi^n]_0, \quad (4.35)$$

where $|\Lambda\rangle \in \mathcal{H}_c$, and $|\tilde{\Lambda}\rangle \in \tilde{\mathcal{H}}_c$ are arbitrary ghost number one Grassmann odd states. If we relax the constraint on the ghost number but continue to use genus zero interaction terms we get the classical BV master action satisfying classical BV master equation. The corresponding action has gauge invariance given in (4.35) with no constraint on the ghost number of Λ .

⁸In the NSNS sector we could set $\tilde{\Psi} = \Psi$ and work with only one set of fields, but having two sets of fields in all sectors allows us to use a uniform notation.

4.3 Heterotic string field theory

The construction of heterotic string field theory is very similar [19, 20]. Since only the holomorphic sector of the closed string theory has picture number, we have \mathcal{H}_{-1} for NS states and $\mathcal{H}_{-1/2}$ for R states in \mathcal{H}_c , and we have \mathcal{H}_{-1} for NS states and $\mathcal{H}_{-3/2}$ for R states in $\tilde{\mathcal{H}}_c$. As in all closed string field theories, the Grassmannality of the target space field is taken to be the same as that of the vertex operator that it multiplies, resulting in a Grassmann even string field. Again, we use two string fields Ψ and $\tilde{\Psi}$:

$$\text{Heterotic string fields:} \quad \Psi \in \mathcal{H}_c \equiv \mathcal{H}_{-1} \oplus \mathcal{H}_{-1/2}, \quad (4.36)$$

$$\tilde{\Psi} \in \tilde{\mathcal{H}}_c \equiv \mathcal{H}_{-1} \oplus \mathcal{H}_{-3/2}. \quad (4.37)$$

The operator \mathcal{G} acting on $\tilde{\mathcal{H}}$ is defined as identity on \mathcal{H}_{-1} and \mathcal{X}_0 on $\mathcal{H}_{-3/2}$:

$$\mathcal{G} = \begin{cases} \mathbf{1} & \text{on } \mathcal{H}_{-1}, \\ \mathcal{X}_0 & \text{on } \mathcal{H}_{-3/2}. \end{cases} \quad (4.38)$$

The action takes the same form as (4.31):

$$S = -\frac{1}{2} \langle \tilde{\Psi}, Q\mathcal{G}\tilde{\Psi} \rangle + \langle \tilde{\Psi}, Q\Psi \rangle + \sum_{n=1}^{\infty} \frac{1}{n!} \{\Psi^n\}. \quad (4.39)$$

The anti-bracket also has the same form as (4.32), (4.33). These can be used to write down the anti-brackets between the component fields once we use expansions of the string fields analogous to those of the superstring, $\Psi = \sum_r \varphi_r \psi^r$ and $\tilde{\Psi} = \sum_r \varphi_r^c \tilde{\psi}^r$.

4.4 Tree-level open string field theory

So far we have discussed closed string field theory. In the presence of D-branes, string theory also contains open strings whose ends are constrained to move on the D-brane. The dynamics of these open strings is described by open string field theory that we shall now describe. We begin with open bosonic string field theory and we then briefly note how matters change for open superstring field theory, both at tree level. Useful references for this section are [5, 9, 21, 56].

Bosonic open string field theory. At the tree level, the procedure for constructing open string field theory is similar to that for closed string field theory with a few differences. A general open string field ψ_o is taken to be an arbitrary open string state without any constraint of type (4.3), and the inner product $\langle A, B \rangle$ is simply the BPZ inner product $\langle A|B \rangle$. We denote the space of open string states by \mathcal{H}_o . There is one subtlety with signs: due to the normalization condition (3.11) or (3.12), the vacuum expectation value of a product of Grassmann odd operators is Grassmann even. Therefore we cannot treat both the bra and ket vacuum to be Grassmann even, one of them must be Grassmann odd. We take $|0\rangle$ to be odd and $\langle 0|$ to be even. So if ψ_o denotes the vertex operator representation of the string field, then ψ_o and $|\psi_o\rangle = \psi_o(0)|0\rangle$ have opposite Grassmann parity. This can be encoded in the rule that when a Grassmann odd number passes through \rangle , it picks up a minus sign. ψ_o is taken to be a Grassmann odd vertex operator, which means $|\psi_o\rangle$ is a Grassmann even state. In the procedure that we shall follow below to manipulate Grassmann numbers, we shall never need to pass a Grassmann odd number through \rangle .

The analog of the fiber bundle $\hat{\mathcal{P}}_{0,n}$ relevant to classical closed string field theory is a fiber bundle $\mathcal{P}_{0,n}^o$ whose base is the moduli space of the upper-half plane with n punctures on the boundary and

whose fiber labels the choice of local coordinates at the boundary punctures. We define a $(n-3)$ -form $\Omega_{n-3}^{o(0,n)}$ on $\mathcal{P}_{0,n}^o$ as,

$$\Omega_{n-3}^{o(0,n)}(A_1, \dots, A_n) \equiv K^{-1} \widehat{\Omega}_{n-3}^{(0,1,0,n)}(A_1, \dots, A_n), \quad (4.40)$$

where $\widehat{\Omega}_{n-3}^{(0,1,0,n)}$ is the form defined in (3.68) following the sign convention described in section 3.5, and the explicit factor of K^{-1} implies that the correlators are effectively computed using the normalization (3.11). Also we have dropped the normalization constant $N_{0,1,0,n}$. These differences can be traced to the use of an *open string coupling constant* g_o introduced below instead of $g_s^{1/2}$ used in (3.71). More discussion on this can be found in section 5.2.

Next, in analogy with (4.8), we introduce $(n-3)$ dimensional chains $\mathcal{V}_{0,n}^o$ of $\mathcal{P}_{0,n}^o$, satisfying

$$\partial \mathcal{V}_{0,n}^o = -\frac{1}{2} \sum_{\substack{n_1, n_2 \\ n_1 + n_2 = n+2}} \{\mathcal{V}_{0,n_1}^o, \mathcal{V}_{0,n_2}^o\}_o. \quad (4.41)$$

The definition of $\{\mathcal{V}_{0,n_1}^o, \mathcal{V}_{0,n_2}^o\}_o$ is similar to the one given below (4.8), except that the punctures that are glued are boundary punctures, and (4.10) is replaced by $w_1 w_2 = -1$. We now define $\{A_1, \dots, A_n\}$ as in (4.11):

$$\{A_1, \dots, A_n\} \equiv g_o^{n-2} \int_{\mathcal{V}_{0,n}^o} \Omega_{n-3}^{o(0,n)}(A_1, \dots, A_n), \quad (4.42)$$

which uses an open string coupling g_o , and write the open string field theory action as:

$$S_o = \frac{1}{2} \langle \psi_o, Q \psi_o \rangle' + \sum_{n=3}^{\infty} \frac{1}{n!} \{\psi_o^n\}. \quad (4.43)$$

Q now denotes the BRST charge in the open string theory and g_o is the open string coupling constant. Its relation to the closed string coupling constant g_s depends on the specific D-brane we consider, but a general relation was derived in [57]:

$$\mathcal{T} = \frac{1}{2\pi^2 g_o^2}, \quad (4.44)$$

where \mathcal{T} is the tension of the D-brane. We shall give a different derivation of this result in section 5.2.

As discussed at the end of section 3.2, the chain $\mathcal{V}_{0,n}^o$ appearing in (4.42) has disconnected components that differ from each other by different cyclic ordering of the vertex operators A_1, \dots, A_n on the boundary. We have to add the contribution from these disconnected components with appropriate relative signs such that for Grassmann odd open string vertex operators A_i 's, $\{A_1 \dots A_N\}$ is symmetric under arbitrary permutation of the A_i 's. If it is anti-symmetric under the exchange of any pair of A_i 's, the interaction terms in the action (4.43) will vanish identically. The rules for $A_i \leftrightarrow A_j$ for other choice of statistics can be found by multiplying the even A_i 's by Grassmann odd variables and then applying the rules for odd A_i . This gives

$$\{A_1 \dots A_i A_{i+1} \dots A_n\} = (-1)^{A_i A_{i+1} + 1} \{A_1 \dots A_{i+1} A_i \dots A_n\}. \quad (4.45)$$

We can also write down the analog of the closed string main identity (4.14) as follows. Given $A_1, \dots, A_N \in \mathcal{H}_o$ carrying arbitrary Grassmann parity, we first define $A'_i = \epsilon_i A_i$ where ϵ_i 's are chosen so that each A'_i is Grassmann odd. The main identity now takes the form:

$$\begin{aligned} Q[A'_1 \dots A'_N] &= \sum_{i=1}^N (-1)^{i-1} [A'_1 \dots A'_{i-1} (Q A'_i) A'_{i+1} \dots A'_N] \\ &+ \sum_{\substack{\ell, k \geq 0 \\ \ell + k = N}} \sum_{\substack{\{i_a; a=1, \dots, \ell\} \\ \{j_b; b=1, \dots, k\} \\ \{i_a\} \cup \{j_b\} = \{1, \dots, N\}}} [[A'_{j_1} \dots A'_{j_k}] A'_{i_1} \dots A'_{i_\ell}], \end{aligned} \quad (4.46)$$

with products $[A_1, \dots, A_n]$ defined analogously to (4.12):

$$\langle A_0, [A_1, \dots, A_n] \rangle' = \{A_0, A_1, \dots, A_n\}. \quad (4.47)$$

These products, just as the multilinear functions $\{\dots\}$ defined above, include sums over different cyclic orderings.

Unlike in the case of closed strings (see remark 5, section 4.1), for open strings $[$ is Grassmann even. This may appear counterintuitive since from (3.68) it would seem that a Grassmann odd number multiplying the A_i 's have to pass through the \mathcal{B} insertions before it can come out to the left, picking additional signs. However we recall the sign prescription for $\widehat{\Omega}$ given at the end of section 3.5: namely that we start with operators carrying the 'correct' Grassmann parity, arrange the operators inside the correlation function so that all the vertex operators appear on the extreme left followed by the \mathcal{B} insertions, picking up any signs that may appear from the rearrangement, and then declare that the same form of $\widehat{\Omega}$ is valid even when the operators have 'wrong' Grassmann parity. Since the vertex operators appear on the extreme left, it follows that no extra sign appears while passing a grassmann odd element to the left, other than those from having to pass it through some of the A_i 's. The same logic tells us that we can move a Grassmann odd operator through $\{$ without picking up any extra sign. The other useful information is that if A_1, \dots, A_n are Grassmann odd, then $[A_1, \dots, A_n]$ is Grassmann even. With this knowledge, we can find the identity (4.46) for A_i 's of arbitrary Grassmann parity by moving the ϵ_i 's to the left and picking up the signs we encounter on the way.

The action (4.43) satisfies the classical BV master equation under the following definition of the anti-bracket. If for an arbitrary function $F(\Psi^o)$, one expresses the first order variation as

$$\delta F = \langle F_R^o, \delta\psi_o \rangle' = \langle \delta\psi_o, F_L^o \rangle', \quad (4.48)$$

then the anti-bracket of F and G is defined as

$$\{F, G\} = - \langle F_R^o, G_L^o \rangle'. \quad (4.49)$$

At the level of target space fields, the above expressions lead to concrete expressions for the antibracket when using the string field expansion $\psi_o = \sum_r \hat{\varphi}_r \psi^r$, with the $\hat{\varphi}_r$ forming a complete basis of states of the BCFT.

The classical master action also has a gauge invariance analogous to (4.25). The infinitesimal gauge transformations leaving the action invariant use a Grassmann even string field gauge-parameter Λ . The gauge transformation takes the form

$$\delta\Phi = Q\Lambda + [\Lambda\Phi] + \frac{1}{2!} [\Lambda, \Phi, \Phi] + \dots. \quad (4.50)$$

Classical string field corresponds to an open string state of ghost number one and the corresponding gauge transformation laws are generated by open string states of ghost number zero.

The action (4.43) does not satisfy the quantum BV master equation (3.92) since the term involving the Δ operation is missing in the geometric equation (4.41). There is one exception to this, provided by Witten's cubic open string field theory. This can be regarded as a special case of the theory described above, where

$$[A_1, A_2] = A_1 \star A_2 - (-1)^{A_1 A_2} A_2 \star A_1. \quad (4.51)$$

Here, the *star product* $A_1 \star A_2$ is a particular map from the tensor product of two open string state spaces to the open string state space and A_i in the exponent is zero (one) if A_i carries even (odd)

ghost number. The difference between $[A_2, A_3]$ and $A_2 \star A_3$ is that when we take the inner product with another state A_1 , the former gives the full contribution to the disk three-point function of A_1 , A_2 and A_3 with some particular choice of local coordinates at the punctures while the latter gives the contribution to the disk three-point function of A_1 , A_2 and A_3 for a particular cyclic ordering. It can be shown that we can define $A_1 \star A_2$ with appropriate choice of local coordinates on the three-string vertex $\mathcal{V}_{0,3}^o$ so that [5]

$$A_1 \star (A_2 \star A_3) = (A_1 \star A_2) \star A_3. \quad (4.52)$$

As will become clear in section 7, geometrically this translates to the statement that $\{\mathcal{V}_{0,3}^o, \mathcal{V}_{0,3}^o\}_o$ vanishes, and we can solve (4.41) by setting $\mathcal{V}_{0,n}^o$ to zero for $n \geq 4$. Therefore we have

$$[A_1, A_2, \dots, A_n] = 0 \quad \text{for } n \geq 3, \quad (4.53)$$

and the action terminates at the cubic order. As we discuss below, formally ΔS_o also vanishes and the action satisfies the full quantum BV master equation, but this requires dropping boundary contributions from degenerate Riemann surfaces.

In the notation explained at the end of section 3.1, the star product can be defined via the relation

$$\langle A_1, A_2 \star A_3 \rangle' = \langle f_1 \circ A_1(0) f_2 \circ A_2(0) f_3 \circ A_3(0) \rangle'_{\text{UHP}}, \quad (4.54)$$

where the subscript UHP indicates that the correlation function is computed on the upper half plane and the maps f_i can be written as follows:

$$\begin{aligned} f_1(w_1) &= h^{-1} \left(e^{2\pi i/3} (h(w_1))^{2/3} \right) \\ f_2(w_2) &= h^{-1} \left((h(w_2))^{2/3} \right), \quad h(u) \equiv \frac{1+iu}{1-iu}, \\ f_3(w_3) &= h^{-1} \left(e^{-2\pi i/3} (h(w_3))^{2/3} \right). \end{aligned} \quad (4.55)$$

More discussion on these maps can be found around (7.71).

An interesting application of the cubic open string field theory for computing the energy of the rolling tachyon solution can be found in [58]. Other applications will be discussed in section 9.

Open superstring field theory: The construction of tree-level open superstring field theory, describing open string dynamics on a D-brane of superstring theory, is similar. As we did in closed string theory, we introduce two sets of string fields $\psi_o \in \mathcal{H}_o$ and $\tilde{\psi}_o \in \tilde{\mathcal{H}}_o$, each with an NS and R sector. Here \mathcal{H}_o contains open string states of picture number -1 or $-1/2$ and $\tilde{\mathcal{H}}_o$ contains open string states of picture number -1 or $-3/2$:

$$\text{Open superstring classical fields: } \quad \psi_o \in \mathcal{H}_o \equiv \mathcal{H}_{-1} \oplus \mathcal{H}_{-1/2}, \quad (4.56)$$

$$\tilde{\psi}_o \in \tilde{\mathcal{H}}_o \equiv \mathcal{H}_{-1} \oplus \mathcal{H}_{-3/2}. \quad (4.57)$$

The construction of $\{A_1, \dots, A_n\}$ follows a procedure that combines the features of open bosonic string field theory and closed superstring field theory, with insertion of picture changing operators, and the tree-level open superstring field theory action is given by,

$$S = -\frac{1}{2} \langle \tilde{\psi}_o, Q \mathcal{G} \tilde{\psi}_o \rangle' + \langle \tilde{\psi}_o, Q \psi_o \rangle' + \sum_{n=1}^{\infty} \frac{1}{n!} \{ \psi_o^n \}. \quad (4.58)$$

As usual, \mathcal{G} is defined as the identity operator on the NS sector states and as the zero mode \mathcal{X}_0 of the PCO on the R sector states.

Unlike bosonic open string field theory, there is no known version of classical open superstring field theory where the action terminates at the cubic order and satisfies the classical BV master equation. Higher order interactions are needed for this. As discussed below, the full open-closed string field theory, with its higher genus contributions are needed to satisfy the quantum BV master equation.

If we are working in the NS sector and are willing to use the full freedom of choosing the local coordinates at the punctures and possibly use vertical integration, there are many non-canonical choices of PCO insertions that will lead to the construction of $\{A_1 \cdots A_n\}$ and $[A_1 \cdots A_n]$ satisfying (4.46), (4.47). The construction of [59,60], giving a canonical choice of PCO locations, can be regarded as a simplification of this more general class of theories. This will be reviewed in section 7.10. For the R sector, however, we need the doubling of fields to write an action.

Having discussed quantum closed string field theory and classical open string field theory, we can ask: What is the quantum version of the classical open string field theory? Since, as claimed, this classical action S satisfies $\{S, S\} = 0$, we ask: Does S satisfy $\Delta S = 0$ as well, making it suitable for a quantum theory? The answer, in general, is no, it does not. This is clear geometrically in the versions of classical open-string field theory with higher products.

When one considers the associative bosonic open string field theory of Witten, the answer is less clear. When one computes open string amplitudes using this theory, no additional vertices are needed to cover the moduli spaces of higher genus surfaces with one or more boundaries. This would suggest that for the associative vertex $\mathcal{V}_{0,3}^o$, one has $\Delta \mathcal{V}_{0,3}^o = 0$, formally. This claim is somewhat surprising since $\Delta \mathcal{V}_{0,3}^o$ is a degenerate surface, being the boundary of the (real) one-dimensional moduli space of an annulus with one open-string puncture. The degenerate surface is one with two disks touching at an interior node, the first disk with one boundary puncture and the other disk with no puncture. In fact, it has been argued that ΔS is actually singular [61,62].

The question is how to supplement classical open string field theory in order to get a theory that manifestly solves the master equation. The physical intuition points the way. Open strings can close by joining their endpoints and becoming closed strings. Therefore the states of closed strings must be added to the open string theory. The closed string states will have self interactions – those of closed string field theory, as well as interactions with open strings. Open strings will also have higher order interactions among themselves. All these interactions belong to the quantum theory. This is the quantum open-closed string field theory that we shall discuss next.

4.5 Open-closed string field theory

As the name suggests, open-closed string field theory is the field theory of closed and open strings. This describes the full quantum theory in the presence of D-branes. The construction of the theory combines the ingredients already described in the previous sections. We shall describe the construction in superstring field theory; the result for the bosonic string theory can be obtained by setting $\tilde{\Psi}$ equal to Ψ in the final formula. Useful references for this section are [7–9, 21], the first three of which are in the context of bosonic string theory.

In the closed string sector we have two sets of string fields, Ψ_c and $\tilde{\Psi}_c$, and we also have two set

of string fields Ψ_o and $\tilde{\Psi}_o$ in the open string sector:

$$\begin{aligned} \text{Open-closed string fields: } \quad \Psi_c \in \mathcal{H}_c, \quad \tilde{\Psi}_c \in \tilde{\mathcal{H}}_c, \\ \Psi_o \in \mathcal{H}_o, \quad \tilde{\Psi}_o \in \tilde{\mathcal{H}}_o. \end{aligned} \tag{4.59}$$

Here, $(\mathcal{H}_c, \tilde{\mathcal{H}}_c)$ are those as in type II in (4.26), (4.27), and $(\mathcal{H}_o, \tilde{\mathcal{H}}_o)$ are those as in classical open superstring theory in (4.56), (4.57). The relevant surfaces have boundaries and carry closed and open string punctures. As defined before, $\mathcal{M}_{g,b,n_c,n_o}$ is the moduli spaces of Riemann surfaces of genus g and b boundaries, with n_c closed string punctures and n_o open string punctures. It has real dimension d_{g,b,n_c,n_o} , given in (3.61).

We define $\hat{\mathcal{P}}_{g,b,n_c,n_o}^s$ to be a fiber bundle whose base is $\mathcal{M}_{g,b,n_c,n_o}$ and whose fiber contains information on the local coordinate system at the punctures and the PCO locations. The relevant p -form $\Omega_p^{(g,b,n_c,n_o)}(A_1^c, \dots, A_{n_c}^c; A_1^o, \dots, A_{n_o}^o)$ on $\hat{\mathcal{P}}_{g,b,n_c,n_o}^s$ is given in (3.79). We also construct d_{g,b,n_c,n_o} -dimensional chains $\mathcal{V}_{g,b,n_c,n_o}$ in $\hat{\mathcal{P}}_{g,b,n_c,n_o}^s$, satisfying

$$\begin{aligned} \partial \mathcal{V}_{g,b,n_c,n_o} &= -\Delta_c \mathcal{V}_{g-1,b,n_c+2,n_o} - \Delta'_o \mathcal{V}_{g,b-1,n_c,n_o+2} - \Delta_o \mathcal{V}_{g-1,b+1,n_c,n_o+2} \\ &\quad - \frac{1}{2} \sum_{\substack{g_1+g_2=g, \quad b_1+b_2=b \\ n_{c1}+n_{c2}=n_c+2, \quad n_{o1}+n_{o2}=n_o}} \{ \mathcal{V}_{g_1,b_1,n_{c1},n_{o1}}, \mathcal{V}_{g_2,b_2,n_{c2},n_{o2}} \}_c \\ &\quad - \frac{1}{2} \sum_{\substack{g_1+g_2=g, \quad b_1+b_2=b+1 \\ n_{c1}+n_{c2}=n_c, \quad n_{o1}+n_{o2}=n_o+2}} \{ \mathcal{V}_{g_1,b_1,n_{c1},n_{o1}}, \mathcal{V}_{g_2,b_2,n_{c2},n_{o2}} \}_o. \end{aligned} \tag{4.60}$$

Here Δ_c and $\{, \}_c$, with c for closed, denote the usual twist gluing of closed string punctures described below (4.8) while Δ'_o , Δ_o and $\{, \}_o$ denote gluing of open string punctures via $w_1 w_2 = -1$. Δ'_o glues two open string punctures on the same boundary, increasing the number of boundary components by one, whereas Δ_o glues two open string punctures lying on different boundaries, decreasing the number of boundary components by one and increasing the genus by one (the pictorial representation of the above identity is given in Figure 5, section 7.3). We now define the multilinear functions

$$\begin{aligned} \{A_1^c, \dots, A_{n_c}^c; A_1^o, \dots, A_{n_o}^o\} &= \sum_{g=0}^{\infty} \sum_{b=0}^{\infty} \{A_1^c, \dots, A_{n_c}^c; A_1^o, \dots, A_{n_o}^o\}_{g,b}, \\ \{A_1^c, \dots, A_{n_c}^c; A_1^o, \dots, A_{n_o}^o\}_{g,b} &= (g_s)^{-\chi_{g,b,n_c,n_o}} \int_{\mathcal{V}_{g,b,n_c,n_o}} \Omega_{d_{g,b,n_c,n_o}}^{(g,b,n_c,n_o)}(A_1^c, \dots, A_{n_c}^c; A_1^o, \dots, A_{n_o}^o). \end{aligned} \tag{4.61}$$

Note that in defining the above multilinear functions we are using the closed string coupling g_s . The open string coupling g_o we used to write classical open string field does not appear here, even for the purely open string couplings on a disk. This is possible because $g_o \sim \sqrt{g_s}$. At the end of this subsection we shall discuss how to recover the classical open string field theory action of section 4.4 from the open closed string field theory action discussed here. There we shall also determine the relation between g_s and g_o .

There is one more quantity that requires special attention – the disk one-point function of a closed string. Before dealing with the details of this, let us recall from section 3.5 that the boundary state $|B\rangle$ is defined such that $\langle B|\chi\rangle$ gives the disk one-point function of a closed string state χ . If we take a closed string state $|\phi\rangle$ satisfying (4.3), and consider the one-point function of $c_0^-|\phi\rangle$ on the unit disk as above, then the disk one-point function is given by $\langle B|c_0^-|\phi\rangle = \langle B, \phi\rangle = \langle \phi, B\rangle$.

The disk one-point function is special for two reasons. First of all, of all the interaction vertices of open-closed string field theory, this is the only one that has a conformal Killing vector. If the closed string vertex operator is taken to be at the center of the disk then this is just the rotation about the center. Second, if we take the closed string state to be in \mathcal{H}_c so that the RR sector states have picture number $(-1/2, -1/2)$ then we get a total picture number -1 from the vertex operator after combining the contribution from the left and the right sector. Since on the disk a non-vanishing amplitude must have total picture number -2 , we will need to insert an inverse picture changing operator carrying picture number -1 to get a non-vanishing result. However the zero mode of the inverse picture changing operator does not have nice properties, – in particular it does not commute with b_0^- . For this reason we use the vertex operators corresponding to the string field $\tilde{\Psi} \in \tilde{\mathcal{H}}_c$ truncated to the NS-NS and RR sectors ($\mathcal{H}_{-1,-1} \oplus \mathcal{H}_{-3/2,-3/2}$) to construct the disk one-point function, and define

$$\{\tilde{A}^c\}_D = \Omega_0^{(0,1,1,0)}(\tilde{A}^c) \equiv -\frac{1}{2\pi i} N_{0,1,1,0} \langle \hat{\mathcal{G}} \tilde{A}^c | c_0^- e^{-\Lambda(L_0 + \bar{L}_0)} | B \rangle, \quad (4.62)$$

where $\Lambda \geq 0$ is an arbitrary parameter, that already appeared in (3.81) in the context of bosonic string amplitudes, $|B\rangle$ is the boundary state describing the D-brane, $N_{0,1,1,0}$ is a constant that has been given in (3.84), and

$$\hat{\mathcal{G}} \equiv \begin{cases} 1 & \text{on } \mathcal{H}_{-1,-1}, \\ \frac{1}{2}(\mathcal{X}_0 + \bar{\mathcal{X}}_0) & \text{on } \mathcal{H}_{-3/2,-3/2}. \end{cases} \quad (4.63)$$

Note that the boundary state is a linear combination of states with picture numbers $(q, -2-q)$ for all integer and half-integer q , since for the disk one-point function of a closed string vertex operator, the picture number conservation only requires the sum of the left and right-handed picture numbers to be 2. Since the disk one-point functions of closed string states are proportional to the normalization constant K appearing in (3.12), the state $|B\rangle$ is proportional to K . As shown in (5.34), this in turn is proportional to the tension of the D-brane. The parameter Λ appearing in (4.62) reflects the freedom of scaling the local coordinate at the closed string puncture. Its value depends on the strategy used to produce string vertices that generate a cover of the moduli space.

For clarity, we note that for bosonic open-closed theory the disk one-point function, going into the action is

$$\{A^c\}_D = \Omega_0^{(0,1,1,0)}(A^c) \equiv -\frac{1}{2\pi i} N_{0,1,1,0} \langle A^c | c_0^- e^{-\Lambda(L_0 + \bar{L}_0)} | B \rangle. \quad (4.64)$$

We can also define multilinear *products* $[\dots]_c$ and $[\dots]_o$ via the relations [21]:

$$\begin{aligned} \langle A_0^c | c_0^- | [A_1^c \dots A_N^c; A_1^o \dots A_M^o]_c \rangle &= \{A_0^c A_1^c \dots A_N^c; A_1^o \dots A_M^o\}, \quad \forall |A_0^c\rangle \in \mathcal{H}_c, \\ \langle A_0^o | [A_1^c \dots A_N^c; A_1^o \dots A_M^o]_o \rangle &= \{A_1^c \dots A_N^c; A_0^o A_1^o \dots A_M^o\}, \quad \forall |A_0^o\rangle \in \mathcal{H}_o, \\ \langle \tilde{A}^c | c_0^- | [\]_c \rangle &= \{\tilde{A}^c\}_D, \end{aligned} \quad (4.65)$$

where for convenience we have chosen A_i^c 's to be even and A_i^o 's to be odd. Note that $[\dots]_c$ is a closed string vertex operator while $[\dots]_o$ is an open string vertex operator. Following our earlier discussion we can conclude that in $[\dots]_c$, $[$ is Grassmann odd while in $[\dots]_o$, $[$ is Grassmann even. In $\{\dots\}$ we do not have separate labels for closed and open strings, and $\{$ is always Grassmann even. The other useful information is that if A_1^c, \dots, A_N^c are Grassmann even and A_1^o, \dots, A_M^o are Grassmann odd, then $[A_1^c \dots A_N^c; A_1^o \dots A_M^o]_c$ is Grassmann odd and $[A_1^c \dots A_N^c; A_1^o \dots A_M^o]_o$ is Grassmann even.

For Grassmann even $\tilde{A}^c \in \tilde{\mathcal{H}}_c$, $A_i^c \in \mathcal{H}_c$ and Grassmann odd $A_i^o \in \mathcal{H}_o$, the main identities take the form:

$$\{(Q\tilde{A}^c)\}_D = 0, \quad (4.66)$$

and,

$$\begin{aligned}
& \sum_{i=1}^N \{A_1^c \cdots A_{i-1}^c (QA_i^c) A_{i+1}^c \cdots A_N^c; A_1^o \cdots A_M^o\} \\
& \quad + \sum_{j=1}^M \{A_1^c \cdots A_N^c; A_1^o \cdots A_{j-1}^o (QA_j^o) A_{j+1}^o \cdots A_M^o\} (-1)^{j-1} \\
= & -\frac{1}{2} \sum_{k=0}^N \sum_{\ell=0}^M \sum_{\substack{\{i_1, \dots, i_k\} \subset \{1, \dots, N\} \\ \{j_1, \dots, j_\ell\} \subset \{1, \dots, M\}}} \left(\{A_{i_1}^c \cdots A_{i_k}^c \mathcal{B}^c; A_{j_1}^o \cdots A_{j_\ell}^o\} + \{A_{i_1}^c \cdots A_{i_k}^c; \mathcal{B}^o A_{j_1}^o \cdots A_{j_\ell}^o\} \right) \\
& - \{[A_1^c \cdots A_N^c; A_1^o \cdots A_M^o]_c\}_D \\
& - \frac{1}{2} \{A_1^c \cdots A_N^c \varphi_s \varphi_r; A_1^o \cdots, A_M^o\} \langle \varphi_s^c, \mathcal{G} \varphi_r^c \rangle \\
& - \frac{1}{2} (-1)^{\hat{\varphi}_s} \{A_1^c \cdots A_N^c; \hat{\varphi}_s \hat{\varphi}_r A_1^o \cdots, A_M^o\} \langle \hat{\varphi}_s^c, \mathcal{G} \hat{\varphi}_r^c \rangle.
\end{aligned} \tag{4.67}$$

In here, \mathcal{B}^c and \mathcal{B}^o are open and closed string states, respectively, given by

$$\begin{aligned}
\mathcal{B}^c & \equiv \mathcal{G}[A_{i_1}^c \cdots A_{i_{N-k}}^c; A_{j_1}^o \cdots A_{j_{M-\ell}}^o]_c, \quad \mathcal{B}^o \equiv \mathcal{G}[A_{i_1}^c \cdots A_{i_{N-k}}^c; A_{j_1}^o \cdots A_{j_{M-\ell}}^o]_o, \\
\{i_1, \dots, i_k\} \cup \{\bar{i}_1, \dots, \bar{i}_{N-k}\} & = \{1, \dots, N\}, \quad \{j_1, \dots, j_\ell\} \cup \{\bar{j}_1, \dots, \bar{j}_{M-\ell}\} = \{1, \dots, M\},
\end{aligned} \tag{4.68}$$

and $\{\hat{\varphi}_s\}$ and $\{\hat{\varphi}_s^c\}$ each represent complete basis of open string states satisfying condition similar to (4.15) and $(-1)^{\hat{\varphi}_s}$ represents Grassmann parity of the vertex operator $\hat{\varphi}_s$. For other choices of Grassmann parities of A_i^c or A_j^o , we first multiply the odd A_i^c 's and even A_j^o 's by Grassmann odd elements so that (4.67) holds and then move these Grassmann odd parameters to the extreme left on both sides of the equation using the rules described earlier.

We are now in a position to write down the BV master action of open-closed string field theory action. It is given by,

$$\begin{aligned}
S & = -\frac{1}{2} \langle \tilde{\Psi}_c, Q \mathcal{G} \tilde{\Psi}_c \rangle + \langle \tilde{\Psi}_c, Q \Psi_c \rangle - \frac{1}{2} \langle \tilde{\Psi}_o, Q \mathcal{G} \tilde{\Psi}_o \rangle + \langle \tilde{\Psi}_o, Q \Psi_o \rangle \\
& \quad + \{\tilde{\Psi}_c\}_D + \sum_{N=0}^{\infty} \sum_{M=0}^{\infty} \frac{1}{N!M!} \{(\Psi_c)^N; (\Psi_o)^M\}.
\end{aligned} \tag{4.69}$$

The action (4.69) satisfies the BV master equation with the following definition of the antibracket. If for an arbitrary function $F(\Psi_c, \tilde{\Psi}_c, \Psi_o, \tilde{\Psi}_o)$, one expresses the first order variation as

$$\begin{aligned}
\delta F & = \langle F_R^c, \delta \tilde{\Psi}_c \rangle + \langle \tilde{F}_R^c, \delta \Psi_c \rangle + \langle F_R^o, \delta \tilde{\Psi}_o \rangle + \langle \tilde{F}_R^o, \delta \Psi_o \rangle \\
& = \langle \delta \tilde{\Psi}_c, F_L^c \rangle + \langle \delta \Psi_c, \tilde{F}_L^c \rangle + \langle \delta \tilde{\Psi}_o, F_L^o \rangle + \langle \delta \Psi_o, \tilde{F}_L^o \rangle,
\end{aligned} \tag{4.70}$$

then the anti-bracket of F and G is defined as

$$\begin{aligned}
\{F, G\} & = -\left(\langle F_R^c, \tilde{G}_L^c \rangle + \langle \tilde{F}_R^c, G_L^c \rangle + \langle \tilde{F}_R^c, \mathcal{G} \tilde{G}_L^c \rangle \right) \\
& \quad - \left(\langle F_R^o, \tilde{G}_L^o \rangle + \langle \tilde{F}_R^o, G_L^o \rangle + \langle \tilde{F}_R^o, \mathcal{G} \tilde{G}_L^o \rangle \right).
\end{aligned} \tag{4.71}$$

For the record, we shall also write down the open-closed bosonic string field theory action, obtained by setting $\tilde{\Psi}$ to Ψ and \mathcal{G} to 1 in (4.69):

$$S = \frac{1}{2} \langle \Psi_c, Q \Psi_c \rangle + \frac{1}{2} \langle \Psi_o, Q \Psi_o \rangle + \{\Psi_c\}_D + \sum_{N=0}^{\infty} \sum_{M=0}^{\infty} \frac{1}{N!M!} \{(\Psi_c)^N; (\Psi_o)^M\}. \tag{4.72}$$

In the open-closed string field theory action, one can ask which are the terms that belong to the classical theory, and which terms are to be considered quantum. This is obtained by taking the $g_s \rightarrow 0$ limit with some combination of the fields and g_s fixed and then identifying the leading order terms in the action as the classical action. The limit clearly depends on which combination of fields we keep fixed as we take the $g_s \rightarrow 0$ limit. It is reasonable to take the limit in a way so as to include the kinetic term of open strings and the open string interactions on disks in the classical action; this is after all, the classical open string field theory. We also desire that the closed string kinetic term should be part of the classical action since it is the sum of these two BRST operators, open and closed, that acts as a boundary operator in moduli space and the two of them should appear at the same order in a g_s expansion. To this end let us define new string fields $\chi_c = g_s^{1/2} \Psi_c$, $\chi_o = g_s^{1/2} \Psi_o$ and take the small g_s limit keeping χ_c and χ_o fixed. In this case the kinetic terms of both the open and the closed string will acquire factors of g_s^{-1} and an interaction term in the action proportional to $\chi_c^{n_c} \chi_o^{n_o}$ will get an additional factor of $g_s^{-(n_c+n_o)/2}$. Using (4.61) we see that the net power of g_s in an interaction term is given by g_s^{p-1} with $p = 2g + b + \frac{n_c}{2} - 1$. The leading terms have $p = 0$, and these terms appear in the action with an overall factor of $1/g_s$. Since this is the same order as the kinetic terms, we can interpret them as part of the classical action, with the overall $1/g_s$ factor playing the role of $1/\hbar$ factor that usually accompanies the classical action. It is clear that $p > 0$ unless $g = 0$, $b = 1$ and $n_c = 0$. So none of the interactions, except for open strings on a disk, are part of the classical open-closed string field theory. The classical open string field theory and free closed strings form the classical open-closed string field theory [7].

Before ending this section, we shall discuss the relation between the open-closed string field theory discussed here and the tree-level open string field theory action (4.43). From the bosonic version of the open-closed SFT action (4.72), restricted to tree-level open string theory, we have

$$\begin{aligned} S_{oc} &= \frac{1}{2} \langle \Psi_o, Q \Psi_o \rangle + \sum_{n=3}^{\infty} \frac{1}{n!} g_s^{(n-2)/2} \int \Omega_{n-3}^{(0,1,0,n)}(\Psi_o, \dots, \Psi_o) \\ &= \frac{1}{2} K \langle \Psi_o, Q \Psi_o \rangle' + \sum_{n=3}^{\infty} \frac{1}{n!} g_s^{(n-2)/2} N_{0,1,0,n} K \int \Omega_{n-3}^{o(0,n)}(\Psi_o, \dots, \Psi_o), \end{aligned} \quad (4.73)$$

where in the last step we used (3.69) and (4.40). On the other hand, the classical open string field theory action given in (4.42), (4.43) gives

$$S_o = \frac{1}{2} \langle \psi_o, Q \psi_o \rangle' + \sum_{n=3}^{\infty} \frac{1}{n!} g_o^{n-2} \int \Omega_{n-3}^{o(0,n)}(\psi_o, \dots, \psi_o). \quad (4.74)$$

To compare the actions we let

$$\Psi_o = K^{-1/2} \psi_o, \quad (4.75)$$

in (4.73) and use (3.84) to get

$$S_{oc} = \frac{1}{2} \langle \psi_o, Q \psi_o \rangle' + \sum_{n=3}^{\infty} \frac{1}{n!} g_s^{(n-2)/2} K^{(2-n)/2} \eta_c^{3(n-2)/4} \int \Omega_{n-3}^{o(0,n)}(\psi_o, \dots, \psi_o). \quad (4.76)$$

With the kinetic terms of the open SFT and open-closed SFT now matching, we compare the interaction terms in (4.74) and (4.76) and see that they agree if we take

$$g_o = g_s^{1/2} K^{-1/2} \eta_c^{3/4}. \quad (4.77)$$

Squaring we get

$$g_o^2 = (g_s/K) \eta_c^{3/2}. \quad (4.78)$$

This is the relation between the open and closed string field theory couplings. In section 5.2 we shall relate K to the D-brane tension.

4.6 Kinetic term for massless open string fields

For the conventional classical action, we restrict the sum over states in the expansion of $|\psi_o\rangle$ to those of ghost number one. That action inherits the gauge invariance of the master action, when we consider a ghost number zero string field gauge parameter $|\epsilon\rangle$. We now illustrate the basics of the bosonic open string field theory by evaluating the kinetic term for the massless sector of the open string field theory formulated on the BCFT that represents the (unstable) space-filling D-brane.

For the purpose of illustration, we shall keep the factors of α' in this and the next subsection, setting $\alpha' = 1$ elsewhere (unless explicitly noted). For this

$$\textit{The coupling constants } g_o \textit{ and } g_s \textit{ are taken to be unit-free pure numbers.} \quad (4.79)$$

Moreover, for simplicity we declare the string fields $|\Psi\rangle = \sum_i |\varphi_i\rangle \psi^i$, to also be unit-free, with both the component target space fields ψ^i , and the basis states $|\varphi_i\rangle$ unit free:

$$\textit{The string field } |\Psi\rangle, \textit{ basis states } |\varphi_i\rangle, \textit{ and target space fields } \psi^i \textit{ are all unit free.} \quad (4.80)$$

Note that the BRST operator Q is also unit free, and with these conventions the string field theory actions are unit free. In order to incorporate α' factors, we need to accompany every power of momentum by $(\alpha')^{1/2}$ and every power of coordinate by $(\alpha')^{-1/2}$.

For the massless sector, the string field is constructed with the following requirements. We define the number operator \hat{N} to be the one that counts the L_0 eigenvalues of matter and ghost oscillators and take a string field with zero \hat{N} eigenvalue. Moreover, the state must have ghost number one. Recalling that $c_n|0\rangle = 0$ for $n \geq 2$ and $b_n|0\rangle = 0$ for $n \geq -1$, we have, on a D- $(d-1)$ brane,

$$|\psi_o\rangle = (\alpha')^{(p+1)/2} \int \frac{d^{p+1}k}{(2\pi)^{p+1}} \left(A_\mu(k) c_1 \alpha_{-1}^\mu - i \sqrt{\frac{1}{2}} B(k) c_0 \right) |k\rangle, \quad (4.81)$$

with $|k\rangle = e^{ik \cdot X} |0\rangle$ and α_{-n} being the oscillators of $i \sqrt{\frac{2}{\alpha'}} \partial X$. We have two fields here, a gauge field A_μ and an auxiliary scalar field B (both unit-free). No antighost oscillator can appear here, because it would have to be a b_{-2} carrying number two, or an oscillator with an even larger number, and if present we cannot achieve zero number, since only c_1 reduces the number by one, but it cannot appear twice. The linearized gauge transformations take the form $\delta|\psi_o\rangle = Q|\epsilon\rangle$, with $|\epsilon\rangle$ a ghost number zero field, also with total number $\hat{N} = 0$. There is just one such state

$$|\epsilon\rangle = (\alpha')^{(p+1)/2} \int \frac{d^{p+1}k}{(2\pi)^{p+1}} \frac{i}{\sqrt{2}} \epsilon(k) |k\rangle. \quad (4.82)$$

The signs have been included in the string field and gauge parameter for convenience. When passing from momentum to coordinate space, our conventions for Fourier transformation are

$$\phi(x) = (\alpha')^{(p+1)/2} \int \frac{d^{p+1}k}{(2\pi)^{p+1}} \tilde{\phi}(k) e^{ikx}, \quad \text{so that} \quad ik_\mu \leftrightarrow \partial_\mu, \quad (4.83)$$

allowing for both ϕ and $\tilde{\phi}$ to be unit-free. To calculate the action we need the BPZ dual of the string field. We first note that the BPZ dual of $|k\rangle$ is $\langle k|$. Moreover, for any oscillator ϕ_n arising from a dimension d conformal field $\phi = \sum_n \frac{\phi_n}{z^{n+d}}$, its BPZ dual is

$$\text{bpz}(\phi_n) = (-1)^{n+d} \phi_{-n}. \quad (4.84)$$

This result follows from the conformal transformation implementing the BPZ map: $z \rightarrow -1/z$ which maps the infinite past $z = 0$ to the infinite future $z \rightarrow \infty$ in the UHP. All in all, the BPZ dual string field is found to be

$$\langle \psi_o | = (\alpha')^{(p+1)/2} \int \frac{d^{p+1}k}{(2\pi)^{p+1}} \langle k | \left(A_\mu(k) c_{-1} \alpha_1^\mu + i \sqrt{\frac{1}{2}} B(k) c_0 \right), \quad (4.85)$$

The computation below requires the BRST operator (3.1), which in oscillator form is given by:

$$Q = \sum_n c_n (L_{-n}^m - \delta_{n,0}) + \frac{1}{2} \sum_{m,n} (m-n) : c_m c_n b_{-n-m} :, \quad (4.86)$$

where $::$ denotes normal ordering in which all the oscillators carrying positive mode number (negative eigenvalue of the number operator) are placed to the right of all the oscillators carrying negative mode number (positive eigenvalue of the number operator). Here the matter Virasoro operators are

$$L_n^m = \frac{1}{2} \sum_m \alpha_m \cdot \alpha_{n-m}, \quad (n \neq 0), \quad L_0^m = \frac{1}{2} \alpha_0^2 + \sum_{n \geq 1} \alpha_{-n} \cdot \alpha_n, \quad \alpha_0^\mu = \sqrt{2\alpha'} k^\mu. \quad (4.87)$$

We have a ‘level expansion’ of the BRST operator, starting with level zero, and going up. In that expansion, a term of level n is one where the labels of the positively moded oscillators add up to n (while the negatively moded labels add up to $-n$, of course). We have

$$\begin{aligned} Q &= c_0 (\alpha' k^2 - 1) \\ &\quad + c_0 (\alpha_{-1} \cdot \alpha_1 + b_{-1} c_1 + c_{-1} b_1) \\ &\quad + \sqrt{2\alpha'} k_\mu (\alpha_{-1}^\mu c_1 + c_{-1} \alpha_1^\mu) - 2b_0 c_{-1} c_1 \\ &\quad + \dots \end{aligned} \quad (4.88)$$

The first line above is the level zero contribution to Q and the next two lines contain the level one contributions. Higher level terms in Q , represented by the dots, will kill the string field we are using. We have the following action of the BRST operator on states:

$$\begin{aligned} Q c_1 \alpha_{-1}^\mu |k\rangle &= (\alpha' k^2 c_0 c_1 \alpha_{-1}^\mu + \sqrt{2\alpha'} k^\mu c_{-1} c_1) |k\rangle \\ Q c_0 |k\rangle &= (\sqrt{2\alpha'} k_\mu \alpha_{-1}^\mu c_1 c_0 - 2 c_{-1} c_1) |k\rangle, \\ Q |k\rangle &= (\alpha' k^2 c_0 + \sqrt{2\alpha'} k_\mu \alpha_{-1}^\mu c_1) |k\rangle. \end{aligned} \quad (4.89)$$

The basic correlator (3.11) with the proper factor of α' inserted reads:

$$\langle k | c_{-1} c_0 c_1 | k' \rangle' = -(2\pi)^{p+1} (\alpha')^{-(p+1)/2} \delta^{(p+1)}(k+k'). \quad (4.90)$$

This correlator enables us to compute the free action, the first term in (4.43). Using the above action of Q , a bit of calculation gives

$$\begin{aligned} S_2 &= \frac{1}{2} \langle \psi_o | Q | \psi_o \rangle' \\ &= (\alpha')^{(p+1)/2} \int \frac{d^{p+1}k}{(2\pi)^{p+1}} \left(-\frac{1}{2} A^\mu(-k) \alpha' p^2 A_\mu(k) - \sqrt{\alpha'} A^\mu(-k) i k_\mu B(k) - \frac{1}{2} B(-k) B(k) \right). \end{aligned} \quad (4.91)$$

In coordinate space this gives

$$S_2 = (\alpha')^{-(p+1)/2} \int d^{p+1}x \left(\frac{\alpha'}{2} A^\mu \square A_\mu - \sqrt{\alpha'} A^\mu \partial_\mu B - \frac{1}{2} B^2 \right). \quad (4.92)$$

The linearized gauge transformations take the form $\delta|\psi_o\rangle = Q|\epsilon\rangle$ and give

$$\delta A_\mu(k) = i\sqrt{\alpha'} k_\mu \epsilon(k), \quad \delta B(k) = -\alpha' k^2 \epsilon(k). \quad (4.93)$$

In coordinate space we have

$$\delta A_\mu = \sqrt{\alpha'} \partial_\mu \epsilon, \quad \delta B = \alpha' \square \epsilon. \quad (4.94)$$

It is quickly verified that the gauge transformations leave the action invariant (up to total derivatives). Elimination of the auxiliary field B via its equation of motion gives $B = \sqrt{\alpha'} \partial \cdot A$ and we then get

$$\begin{aligned} S &= (\alpha')^{-(p-1)/2} \int d^{p+1}x \left(\frac{1}{2} A_\mu \square A^\mu + \frac{1}{2} (\partial \cdot A)^2 \right) = (\alpha')^{-(p-1)/2} \int d^{p+1}x \left(-\frac{1}{2} \partial_\mu A_\nu \partial^\mu A^\nu + \frac{1}{2} \partial_\mu A_\nu \partial^\nu A^\mu \right) \\ &= (\alpha')^{-(p-1)/2} \int d^{p+1}x \left(-\frac{1}{4} F^{\mu\nu} F_{\mu\nu} \right), \end{aligned} \quad (4.95)$$

which, with $F_{\mu\nu} \equiv \partial_\mu A_\nu - \partial_\nu A_\mu$, is the familiar free gauge-invariant action for a Maxwell field. The gauge transformation is $\delta A_\mu = \sqrt{\alpha'} \partial_\mu \epsilon$.

4.7 Kinetic term for massless closed string fields

We shall begin by relating the coefficients of expansion of the string field with the degrees of freedom of the metric. For this we observe that in the presence of a background target space string metric $g_{\mu\nu}$, the world-sheet action S_{ws} associated with the non-compact coordinates takes the form

$$S_{\text{ws}} = -\frac{1}{4\pi\alpha'} \int dx dy g_{\mu\nu} (\partial_x X^\mu \partial_x X^\nu + \partial_y X^\mu \partial_y X^\nu) = -\frac{1}{\pi\alpha'} \int dx dy g_{\mu\nu} \partial X^\mu \bar{\partial} X^\nu, \quad z \equiv x + iy. \quad (4.96)$$

with x, y real coordinates on the world-sheet, and ∂ and $\bar{\partial}$ derivatives with respect to z and \bar{z} , respectively. Writing

$$g_{\mu\nu} = \eta_{\mu\nu} + h_{\mu\nu}, \quad (4.97)$$

we see that to first order in $h_{\mu\nu}$, the deformation by $h_{\mu\nu}$ corresponds to the insertion of the operator

$$S_{\text{ws}}|_h = -\frac{1}{\pi\alpha'} \int dx dy h_{\mu\nu} \partial X^\mu \bar{\partial} X^\nu, \quad (4.98)$$

in the world-sheet correlator. On the other hand, it follows from (3.51) and (4.11) that if we deform the background string field by $\mathcal{O} = c\bar{c}V$ for some dimension (1,1) matter primary V , it corresponds to inserting into the world-sheet correlator a term

$$-g_s \frac{1}{\pi} \int dx dy V. \quad (4.99)$$

From the last two equations we can read V and see that in order to turn on a metric deformation $h_{\mu\nu}$, we need to turn on a string field background $\mathcal{O}_h = ccV$ given by:

$$\mathcal{O}_h = \frac{1}{g_s \alpha'} h_{\mu\nu} c\bar{c} \partial X^\mu \bar{\partial} X^\nu = \frac{1}{g_s} \left(-\frac{1}{2} h_{\mu\nu} \right) c\bar{c} i\sqrt{\frac{2}{\alpha'}} \partial X^\mu i\sqrt{\frac{2}{\alpha'}} \bar{\partial} X^\nu. \quad (4.100)$$

Recalling that α_{-n} are the oscillators of $i\sqrt{\frac{2}{\alpha'}}\partial X$, and similarly for the barred oscillators, this suggests that we take the closed string field for the massless bosonic fields is given as:

$$|\Psi\rangle = (\alpha')^{D/2} \frac{1}{g_s} \int \frac{d^D k}{(2\pi)^D} \left(-\frac{1}{2} e_{\mu\nu}(k) \alpha_{-1}^\mu \bar{\alpha}_{-1}^\nu c_1 \bar{c}_1 + e(k) c_1 c_{-1} + \bar{e}(k) \bar{c}_1 \bar{c}_{-1} \right. \\ \left. + i\sqrt{\frac{1}{2}} (f_\mu(k) c_0^+ c_1 \alpha_{-1}^\mu + \bar{f}_\mu(k) c_0^+ \bar{c}_1 \bar{\alpha}_{-1}^\mu) \right) |k\rangle. \quad (4.101)$$

Here we can identify $h_{\mu\nu}$ as the symmetric part of $e_{\mu\nu}$, and the antisymmetric tensor field $b_{\mu\nu}$ as the antisymmetric part of $e_{\mu\nu}$:

$$e_{\mu\nu} = h_{\mu\nu} + b_{\mu\nu}, \quad \text{with} \quad h_{\mu\nu} = h_{\nu\mu}, \quad b_{\mu\nu} = -b_{\nu\mu}. \quad (4.102)$$

The above string field has $\hat{N} = \hat{\bar{N}} = 0$, where both these number operators are defined so that $|p\rangle$ has number zero. It follows that the level-matching constraint $L_0 - \bar{L}_0 = 0$ is satisfied. Moreover, $c_0^\pm \equiv \frac{1}{2}(c_0 \pm \bar{c}_0)$, and we also define $b_0^\pm \equiv b_0 \pm \bar{b}_0$, so that the non-vanishing anticommutators are $\{c_0^\pm, b_0^\pm\} = 1$. As required, $b_0^- |\Psi\rangle = 0$ because $b_0^- |k\rangle = 0$ and the ghost oscillator c_0^- does not appear in $|\Psi\rangle$. This expansion of the string field features five momentum-space component fields: $e_{\mu\nu}, e, \bar{e}, f$, and \bar{f} . In terms of the \pm ghost zero modes, the basic correlator (3.10) becomes:

$$\langle k | c_{-1} \bar{c}_{-1} c_0^- c_0^+ c_1 \bar{c}_1 | k' \rangle = -\frac{1}{2} (\alpha')^{-D/2} (2\pi)^D \delta^{(D)}(k + k'). \quad (4.103)$$

For closed strings BPZ conjugation can be implemented with the map $z \rightarrow 1/z$ (without the minus signs of open strings), and the result is that for the oscillators of a dimension d field we have [6]

$$\text{bpz}(\phi_n) = (-1)^d \phi_{-n}, \quad (4.104)$$

all oscillators transforming with the same sign prefactor, independent of the mode number. It then follows that BPZ conjugate of the above string field, needed for the construction of the kinetic term in the action, is given by

$$\langle \Psi | = (\alpha')^{D/2} \frac{1}{g_s} \int \frac{d^D k}{(2\pi)^D} \langle k | \left(-\frac{1}{2} e_{\mu\nu}(k) \alpha_1^\mu \bar{\alpha}_1^\nu c_{-1} \bar{c}_{-1} + e(k) c_{-1} c_1 + \bar{e}(k) \bar{c}_{-1} \bar{c}_1 \right. \\ \left. - i\sqrt{\frac{1}{2}} (f_\mu(k) c_0^+ c_{-1} \alpha_1^\mu + \bar{f}_\mu(k) c_0^+ \bar{c}_{-1} \bar{\alpha}_1^\mu) \right). \quad (4.105)$$

We wish to construct the quadratic term of the bosonic string action (4.18), given by

$$S^{(2)} = \frac{1}{2} \langle \Psi | c_0^- Q | \Psi \rangle. \quad (4.106)$$

Here Q is the (ghost-number one) BRST operator of the conformal field theory. The BRST operator (3.1) is the sum of a holomorphic part, that we used for the open bosonic string in (4.86) and (4.87), and the analogous antiholomorphic part. This time, however $\alpha_0 = \bar{\alpha}_0 = \sqrt{\frac{\alpha'}{2}} k$. The level expansion of the BRST operator now gives:

$$Q = c_0^+ \left(\frac{\alpha'}{2} k^2 - 2 \right) \\ + c_0^+ \left(\alpha_{-1} \cdot \alpha_1 + b_{-1} c_1 + c_{-1} b_1 + \bar{\alpha}_{-1} \cdot \bar{\alpha}_1 + \bar{b}_{-1} \bar{c}_1 + \bar{c}_{-1} \bar{b}_1 \right) \\ + \sqrt{\frac{\alpha'}{2}} k \cdot (\alpha_{-1} c_1 + c_{-1} \alpha_1) + \sqrt{\frac{\alpha'}{2}} k \cdot (\bar{\alpha}_{-1} \bar{c}_1 + \bar{c}_{-1} \bar{\alpha}_1) \\ - b_0^+ (c_{-1} c_1 + \bar{c}_{-1} \bar{c}_1) + \dots \quad (4.107)$$

where we have dropped terms proportional to $L_0 - \bar{L}_0$ and b_0^- that annihilate any string field. Note that acting on the present string field the ‘-2’ on the first line cancels with the contributions from the second line. This gives

$$S^{(2)} = (\alpha')^{-D/2} \frac{1}{8g_s^2} \int d^D x \left[\frac{\alpha'}{4} e^{\mu\nu} \square e_{\mu\nu} + 2\alpha' \bar{e} \square e - f^\mu f_\mu - \bar{f}^\mu \bar{f}_\mu \right. \\ \left. - \sqrt{\alpha'} f^\mu (\partial^\nu e_{\mu\nu} - 2\partial_\mu \bar{e}) + \sqrt{\alpha'} \bar{f}^\nu (\partial^\mu e_{\mu\nu} + 2\partial_\nu e) \right]. \quad (4.108)$$

The gauge parameter $|\Lambda\rangle$ for the linearised gauge transformations is

$$|\Lambda\rangle = (\alpha')^{D/2} \frac{1}{g_s} \int \frac{d^D k}{(2\pi)^D} \left(\frac{i}{\sqrt{2}} \lambda_\mu(k) \alpha_{-1}^\mu c_1 - \frac{i}{\sqrt{2}} \bar{\lambda}_\mu(k) \bar{\alpha}_{-1}^\mu \bar{c}_1 + \mu(k) c_0^+ \right) |k\rangle. \quad (4.109)$$

The string field Λ has ghost number one and is annihilated by b_0^- . It encodes two vectorial gauge parameters λ_μ and $\bar{\lambda}_\mu$ and one scalar gauge parameter μ . The quadratic string action (4.106) is invariant under the gauge transformations

$$\delta|\Psi\rangle = Q|\Lambda\rangle. \quad (4.110)$$

Expanding this equation gives the following gauge transformations of the component fields:

$$\begin{aligned} \delta e_{\mu\nu} &= \sqrt{\alpha'} (\partial_\mu \bar{\lambda}_\nu + \partial_\nu \lambda_\mu), \\ \delta f_\mu &= -\frac{1}{2} \alpha' \square \lambda_\mu + \sqrt{\alpha'} \partial_\mu \mu, \\ \delta \bar{f}_\nu &= \frac{1}{2} \alpha' \square \bar{\lambda}_\nu + \sqrt{\alpha'} \partial_\nu \mu, \\ \delta e &= -\frac{1}{2} \sqrt{\alpha'} \partial \cdot \lambda + \mu, \\ \delta \bar{e} &= \frac{1}{2} \sqrt{\alpha'} \partial \cdot \bar{\lambda} + \mu. \end{aligned} \quad (4.111)$$

This can be confirmed to be a symmetry of the action (4.108).

We can now introduce fields d and χ by

$$d = \frac{1}{2} (e - \bar{e}), \quad \text{and} \quad \chi = \frac{1}{2} (e + \bar{e}). \quad (4.112)$$

The gauge transformations of d and χ are

$$\begin{aligned} \delta d &= -\frac{1}{4} \sqrt{\alpha'} (\partial \cdot \lambda + \partial \cdot \bar{\lambda}), \\ \delta \chi &= -\frac{1}{4} \sqrt{\alpha'} (\partial \cdot \lambda - \partial \cdot \bar{\lambda}) + \mu. \end{aligned} \quad (4.113)$$

We can use μ to make the gauge choice

$$\chi = 0. \quad (4.114)$$

After this choice is made, gauge transformations with arbitrary λ and $\bar{\lambda}$ require compensating μ transformations to preserve $\chi = 0$. These do not affect d or $e_{\mu\nu}$ as neither transforms under μ gauge transformations. It does change the gauge transformations of f and \bar{f} , but this is of no concern here as these auxiliary fields will be eliminated using their equations of motion. Therefore, we set $e = d$ and $\bar{e} = -d$ in (4.108) and eliminate the auxiliary fields f_μ and \bar{f}_ν using their equations of motion:

$$f_\mu = -\frac{1}{2} \sqrt{\alpha'} (\partial^\nu e_{\mu\nu} - 2\partial_\mu \bar{e}), \quad \bar{f}_\nu = \frac{1}{2} \sqrt{\alpha'} (\partial^\mu e_{\mu\nu} + 2\partial_\nu e). \quad (4.115)$$

The result is the following quadratic action

$$S^{(2)} = (\alpha')^{-(D-2)/2} \frac{1}{8g_s^2} \int d^D x \left[\frac{1}{4} e_{\mu\nu} \square e^{\mu\nu} + \frac{1}{4} (\partial^\nu e_{\mu\nu})^2 + \frac{1}{4} (\partial^\mu e_{\mu\nu})^2 - 2 d \partial^\mu \partial^\nu e_{\mu\nu} - 4 d \square d \right]. \quad (4.116)$$

The gauge transformations are

$$\begin{aligned} \delta e_{\mu\nu} &= \sqrt{\alpha'} (\partial_\nu \lambda_\mu + \partial_\mu \bar{\lambda}_\nu), \\ \delta d &= -\frac{1}{4} \sqrt{\alpha'} (\partial \cdot \lambda + \partial \cdot \bar{\lambda}), \end{aligned} \quad (4.117)$$

The action (4.116) and the associated gauge transformations are completely general.

With $e_{\mu\nu} = h_{\mu\nu} + b_{\mu\nu}$, the action (4.116) then gives

$$S^{(2)} = (\alpha')^{-(D-2)/2} \frac{1}{8g_s^2} \int d^D x L[h, b, d], \quad (4.118)$$

where

$$L[h, b, d] = \frac{1}{4} h^{\mu\nu} \partial^2 h_{\mu\nu} + \frac{1}{2} (\partial^\nu h_{\mu\nu})^2 - 2 d \partial^\mu \partial^\nu h_{\mu\nu} - 4 d \partial^2 d + \frac{1}{4} b^{\mu\nu} \partial^2 b_{\mu\nu} + \frac{1}{2} (\partial^\nu b_{\mu\nu})^2. \quad (4.119)$$

To appreciate this result, we recall the standard low-energy effective string action S_{st} for gravity, Kalb-Ramond, and dilaton fields:

$$S_{\text{st}} = \frac{1}{2\kappa^2} \int d^D x \sqrt{-g} e^{-2\phi} \left[R - \frac{1}{12} H^2 + 4(\partial\phi)^2 \right]. \quad (4.120)$$

We expand to quadratic order in fluctuations using

$$g_{\mu\nu} = \eta_{\mu\nu} + h_{\mu\nu}, \quad \phi = d + \frac{1}{4} \eta^{\mu\nu} h_{\mu\nu}, \quad H_{\mu\nu\rho} = \partial_\mu b_{\nu\rho} + \dots, \quad (4.121)$$

and after a long but familiar calculation involving the expansion of R , we find

$$S_{\text{st}}^{(2)} = \frac{1}{2\kappa^2} \int d^D x L[h, b, d], \quad (4.122)$$

the exact same result we had for the string field quadratic action, provided we make the identification

$$\kappa = (\alpha')^{(D-2)/4} (2g_s). \quad (4.123)$$

This also relates the string field fluctuations to the fluctuations of the metric, Kalb-Ramond field, and dilaton.

We now turn to the symmetries. The linearized version of the standard action (4.122) is invariant under linearized diffeomorphisms, with parameter ϵ_μ and antisymmetric tensor gauge transformations with parameter $\tilde{\epsilon}_\nu$:

$$\begin{aligned} \delta h_{\mu\nu} &= \partial_\mu \epsilon_\nu + \partial_\nu \epsilon_\mu, \\ \delta b_{\mu\nu} &= -\partial_\mu \tilde{\epsilon}_\nu + \partial_\nu \tilde{\epsilon}_\mu, \\ \delta d &= -\frac{1}{2} \partial \cdot \epsilon, \end{aligned} \quad (4.124)$$

Note that the scalar dilaton $\phi \equiv d + \frac{1}{4} \eta^{\mu\nu} h_{\mu\nu}$ is invariant under linearized diffeomorphisms. The gauge symmetries (4.117) of the SFT action coincide with the familiar ones above if we let

$$\epsilon_\mu \equiv \frac{1}{2} \sqrt{\alpha'} (\lambda_\mu + \bar{\lambda}_\mu), \quad \tilde{\epsilon}_\mu \equiv \frac{1}{2} \sqrt{\alpha'} (\lambda_\mu - \bar{\lambda}_\mu). \quad (4.125)$$

This shows that the quadratic string field theory action has all the requisite properties. Part of this action involving the graviton and the dilaton field was obtained in [63]. A closely related action was derived in setting up double field theory [64].

5 Properties of string field theory

In this section we shall describe some properties of string field theory developed in section 4. In this analysis we assume that the conformal field theory correlation functions follow the gluing axioms mentioned at the end of 3.1. We will discuss the propagators for the various theories and how, at least formally, the world-sheet amplitudes arise from string field theory. We then turn to the sign convention of forms, focusing on the case of open-closed string field theory. We continue with a discussion of the 1PI and Wilsonian effective action for string field theory, and justify the equivalence of theories using different string vertices using field redefinitions. The property of background independence of string field theory is reviewed next, followed by the dilaton theorem.

5.1 World-sheet string amplitudes from string field theory

One of the consistency conditions that any version of string field theory needs to satisfy is that the perturbative amplitudes computed from string field theory should formally agree with the ones described in section 3.2 in first quantized string field theory. Here we use the word ‘formally’ because the integration over moduli spaces of Riemann surfaces for the world-sheet amplitudes in section 3.2 often diverges as we approach noded surfaces and must be regulated by using insights from string field theory. This will be discussed later in section 9.3. In this section we shall discuss how the formal equivalence between string field theory amplitudes and the world-sheet amplitudes arises.

We shall first discuss this formal equivalence in the context of closed bosonic string theory. Note that with the normalization convention in (3.10), S is the Lorentzian action since the quadratic terms of physical fields with momentum p are proportional to $-p^2$. We shall compute the amplitudes in the Euclidean theory in order to avoid factors of i . The Euclidean action is given by $S_E = -S$, with S evaluated using the Euclidean metric and the normalization conditions like (3.10) retaining their form with momenta replaced by Euclidean momenta. The minus sign is needed because S_E should have terms proportional to p^2 with positive sign. Therefore the path-integral weight factor is $e^{-S_E} = e^S$. We shall use this convention to derive the Feynman rules discussed below. As a result the kinetic operator K will be the *negative* of the operator that appears in the quadratic term in the action. For example, for a scalar field we have $S = \int (-\frac{1}{2}\phi K\phi)$ with K the kinetic operator.

In order to compute the amplitudes via a path integral, we need to first fix a gauge. As discussed in section 3.6, this corresponds to setting the anti-fields to zero after suitable symplectic transformation. It follows from the discussion below (4.22) that one such choice is to set to zero the coefficients of the basis states annihilated by c_0^+ . Since the rest of the basis states are annihilated by b_0^+ , the gauge condition can also be written as

$$b_0^+|\Psi\rangle = 0. \quad (5.1)$$

This is known as the Siegel gauge. In this gauge the action (4.18) takes the form:

$$S = \frac{1}{2}\langle\Psi|c_0^-c_0^+L_0^+|\Psi\rangle + \sum_{n=1}^{\infty} \frac{1}{n!}\{\Psi^n\}. \quad (5.2)$$

The kinetic operator here is $K = -c_0^-c_0^+L_0^+$. The bosonic string propagator \mathcal{P}_b is obtained by inverting the kinetic operator term, $\mathcal{P}_b K = \mathbf{1}$ on the space of states annihilated by b_0^+ . This gives

$$\mathcal{P}_b = -b_0^+b_0^-(L_0 + \bar{L}_0)^{-1}\delta_{L_0, \bar{L}_0}. \quad (5.3)$$

The operator \mathcal{P}_b is to be regarded as acting on the full CFT state space \mathcal{H}' ; this is why we have put the last factor δ_{L_0, \bar{L}_0} to explicitly impose the constraint (4.3) that the string field satisfies. Since $L_0 - \bar{L}_0$ takes integer values in the full CFT state space, this can be written as

$$\mathcal{P}_b = -\frac{1}{2\pi} b_0^+ b_0^- \int_0^{2\pi} d\theta \int_0^\infty ds e^{-s(L_0 + \bar{L}_0)} e^{i\theta(L_0 - \bar{L}_0)} = \frac{1}{\pi} b_0 \bar{b}_0 \int_{|q| \leq 1} \frac{d^2 q}{|q|^2} q^{L_0} \bar{q}^{\bar{L}_0}, \quad (5.4)$$

where we have defined

$$q \equiv e^{-s+i\theta}, \quad d^2 q = d\theta ds |q|^2 \equiv \frac{i}{2} dq \wedge d\bar{q}, \quad (5.5)$$

The two-form $d^2 q$ is the exact analog of $d^2 z \equiv dx \wedge dy$ for the real plane, with $z = x + iy$. It is the ‘area’ form giving a positive result acting on a basis with the standard orientation.

We can give the following geometric interpretation to the contribution from a Feynman diagram where a pair of interaction vertices are connected by a propagator. Associated with each interaction vertex we have a chain \mathcal{V}_{g_i, n_i} of $\hat{\mathcal{P}}_{g_i, n_i}$ for $i = 1, 2$. Let us pick a particular point in \mathcal{V}_{g_i, n_i} for each of the two vertices. This gives a particular Riemann surface with punctures and a choice of local coordinate (up to a phase) at each of the punctures. Now in the Feynman diagram one of the punctures at each of the vertices is connected to the internal propagator. If we denote by w_1 and w_2 the local coordinates at these punctures, then one can show, using properties of CFT on Riemann surfaces, that for a given value of q in (5.4), the contribution from the Feynman diagram can be expressed as correlation function on a new Riemann surface of genus $g_1 + g_2$ and $n_1 + n_2 - 2$ punctures, obtained by gluing the original pair of Riemann surfaces using the relation [65, 66]⁹

$$w_1 w_2 = q. \quad (5.6)$$

If we now span the whole range $|q| \leq 1$, and also consider the collection of all points in the chains \mathcal{V}_{g_i, n_i} , we get a chain in $\hat{\mathcal{P}}_{g_1+g_2, n_1+n_2-2}$ of dimension:

$$(6g_1 - 6 + 2n_1) + (6g_2 - 6 + 2n_2) + 2, \quad (5.7)$$

where the last additive contribution of 2 represents the two dimensional space spanned by q . This has the correct dimension $6(g_1 + g_2) - 6 + 2(n_1 + n_2 - 2)$ that is needed to describe a string amplitude at genus $g_1 + g_2$ with $n_1 + n_2 - 2$ external legs. Since $dq \wedge d\bar{q} = -2id^2 q$, the propagator can be written as

$$\mathcal{P}_b = \int_{|q| \leq 1} \left[\left(-\frac{1}{2\pi i} \right) b_0 \bar{b}_0 \frac{dq \wedge d\bar{q}}{|q|^2} \right] q^{L_0} \bar{q}^{\bar{L}_0}. \quad (5.8)$$

The term inside the square bracket define the two-form $\Omega_{\mathcal{P}_b}$

$$\Omega_{\mathcal{P}_b} = -\frac{1}{2\pi i} b_0 \bar{b}_0 \frac{dq \wedge d\bar{q}}{|q|^2}. \quad (5.9)$$

Let us compare this with the result we shall get if we had followed the procedure used in defining the canonical forms $\hat{\Omega}$ given in (3.68), restricted to purely closed string amplitudes on surfaces without boundaries for which there is no sign ambiguity. For the above gluing $w_1 w_2 = q$ we have $w_1 = F(w_2, q)$ and the derivatives

$$\frac{\partial F}{\partial q} = \frac{1}{w_2} = \frac{w_1}{q}, \quad \frac{\partial \bar{F}}{\partial q} = 0; \quad \frac{\partial F}{\partial \bar{q}} = 0, \quad \frac{\partial \bar{F}}{\partial \bar{q}} = \frac{\bar{w}_1}{\bar{q}}. \quad (5.10)$$

⁹In doing this identification explicitly we must choose the phase of the coordinates w_1 and w_2 . This can't be done globally in a continuous way, but no difficulty arises since the propagator actually integrates over all twist angles.

This means that the canonical form $\widehat{\Omega}_b$ arising from the gluing operation is

$$\widehat{\Omega}_b = \mathcal{B}\left[\frac{\partial}{\partial q}\right] \mathcal{B}\left[\frac{\partial}{\partial \bar{q}}\right] dq \wedge d\bar{q} = \frac{1}{q} \oint w_1 b(w_1) dw_1 \times \frac{1}{\bar{q}} \oint \bar{w}_1 \bar{b}(\bar{w}_1) d\bar{w}_1 \times dq \wedge d\bar{q} = \frac{b_0}{q} \frac{\bar{b}_0}{\bar{q}} dq \wedge d\bar{q}. \quad (5.11)$$

We then see that the propagator two form $\Omega_{\mathcal{P}_b}$ is simply related to the canonical form

$$\Omega_{\mathcal{P}_b} = -\frac{1}{2\pi i} \widehat{\Omega}_b. \quad (5.12)$$

The numerical factor is the normalization factor of the propagator form. We now confirm the consistency of the normalization factors. When we use the propagator to glue a form on $\widehat{\mathcal{P}}_{g_1, n_1}$ to a form in $\widehat{\mathcal{P}}_{g_2, n_2}$ the normalization factors must give the normalization factor of $\widehat{\mathcal{P}}_{g_1+g_2, n_1+n_2-2}$. They do indeed:

$$\left(-\frac{1}{2\pi i}\right)^{3g_1-3+n_1} \left(-\frac{1}{2\pi i}\right)^{3g_2-3+n_2} \left(-\frac{1}{2\pi i}\right)^1 = \left(-\frac{1}{2\pi i}\right)^{3(g_1+g_2)-3+(n_1+n_2-2)}, \quad (5.13)$$

where we used (3.44). This is in fact the origin of the normalization factor in (3.44). The normalization factors also work out when the propagator connects two lines from the same vertex.

By repeated use of the propagator one can show that each Feynman diagram contributing to an n -point amplitude at order g_s^{2g-2+n} gives an integral of the form (3.41) that runs over a chain. For example the elementary g -loop, n -point vertex gives integration over $\mathcal{V}_{g, n}$. The geometric BV master equation(4.8) guarantees that the boundaries of these chains fit together so that the sum over all Feynman diagrams gives integration over the full chain $\mathcal{F}_{g, n}$. This reproduces the amplitude (3.41) given in the world-sheet formalism.

The analysis for type II or heterotic string theory is similar. In the Siegel gauge $b_0^+|\Psi\rangle = 0$, $b_0^+|\tilde{\Psi}\rangle = 0$, the action (4.31) takes the form:

$$S = -\frac{1}{2} \langle \tilde{\Psi} | c_0^- c_0^+ L_0^+ \mathcal{G} | \tilde{\Psi} \rangle + \langle \tilde{\Psi} | c_0^- c_0^+ L_0^+ | \Psi \rangle + \sum_{n=1}^{\infty} \frac{1}{n!} \{\Psi^n\}. \quad (5.14)$$

Therefore the kinetic operator K_0 in $(\tilde{\Psi}, \Psi)$ space takes the form:

$$K_0 = c_0^- c_0^+ L_0^+ \begin{pmatrix} \mathcal{G} & -1 \\ -1 & 0 \end{pmatrix}, \quad (5.15)$$

and the superstring propagator \mathcal{P}_s , given by the inverse of K_0 , is,

$$\mathcal{P}_s = -b_0^+ b_0^- (L_0 + \bar{L}_0)^{-1} \delta_{L_0, \bar{L}_0} \begin{pmatrix} 0 & 1 \\ 1 & \mathcal{G} \end{pmatrix}. \quad (5.16)$$

Since $\tilde{\Psi}$ does not appear in the interaction vertex, the only internal propagator needed for the computation of the Feynman diagrams is the Ψ - Ψ propagator. One can now analyze the Feynman diagrams as in the case of bosonic string field theory. The only difference is that the propagator contains the factor of \mathcal{G} . As a result, for a Feynman diagram with two elementary vertices joined by a propagator, the associated form in $\widehat{\mathcal{P}}_{g_1+g_2, n_1+n_2-2}$ has PCO insertions \mathcal{X}_0 and/or $\bar{\mathcal{X}}_0$ for R sector propagators. The boundary of this chain still coincides with part of the boundary of $\mathcal{V}_{g_1+g_2, n_1+n_2-2}$ since, as discussed above (4.28), the boundary of $\mathcal{V}_{g, n}$ has exactly the same PCO insertions. The rest of the analysis proceeds as before, and one can show that the sum of all the Feynman diagrams gives the integral of $\Omega_{6g-6+2n}^{(g, n)}$ over a chain $\tilde{\mathcal{G}}_{g, n}$ of $\widehat{\mathcal{P}}_{g, n}^s$ that when pushed to $\mathcal{M}_{g, n}$ represents its fundamental homology class, thus reproducing the amplitude (3.41) given in the world-sheet formalism.

The computation of amplitudes in theories that include open strings also includes Feynman diagrams with open string propagators. In the Siegel gauge $b_0|\Psi_o\rangle = 0$ the kinetic operator is $K = -c_0L_0$ and therefore open string propagator \mathcal{P}_o , satisfying $\mathcal{P}_oK = \mathbf{1}$ on the space of states annihilated by b_0 , is given by

$$\mathcal{P}_o = -b_0L_0^{-1} = -b_0 \int_0^1 \frac{dq_o}{q_o} q_o^{L_0} = \int_0^1 \left[(-b_0) \frac{dq_o}{q_o} \right] q_o^{L_0}. \quad (5.17)$$

Here q_o is a real integration variable. The term inside the square bracket defines the one-form $\Omega_{\mathcal{P}_o}$

$$\Omega_{\mathcal{P}_o} = -b_0 \frac{dq_o}{q_o}. \quad (5.18)$$

Geometrically, when we connect two open string punctures by an open string propagator, the local coordinates w_1 and w_2 around the open string punctures get identified via

$$w_1w_2 = -q_o, \quad q_o \in [0, 1]. \quad (5.19)$$

We can now identify w_1 as σ_s and w_2 as τ_s in the language of section 3.2. Then we have $w_1 = G(w_2, q_o)$, with $\frac{\partial G}{\partial q_o} = w_1/q_o$. The canonical form in this open string case is

$$\hat{\Omega}_o = \mathcal{B} \left[\frac{\partial}{\partial q_o} \right] dq_o, \quad (5.20)$$

where

$$\mathcal{B} \left[\frac{\partial}{\partial q_o} \right] = \int dw_1 b(w_1) \frac{w_1}{q_o} + \int d\bar{w}_1 \bar{b}(\bar{w}_1) \frac{\bar{w}_1}{q_o} = \frac{1}{q_o} \oint_C dw_1 b(w_1) w_1, \quad (5.21)$$

where in the last step we have used the doubling trick. Now according to the prescription given in section 3.2, on the glued Riemann surface, the integration contour C must keep the region covered by the w_1 coordinate system to the left. If we take the gluing to be on the line $|w_1| = |w_2| = q_o^{1/2}$, then the w_1 coordinate system will cover the region $|w_1| \geq q_o^{1/2}$. This leads to C being a clockwise contour around $w_1 = 0$, as indicated by the \oint_C symbol. We can now identify $\oint_C dw_1 b(w_1) w_1$ as $-b_0$ and get,

$$\mathcal{B} \left[\frac{\partial}{\partial q_o} \right] = -\frac{1}{q_o} b_0, \quad \hat{\Omega}_o = -b_0 \frac{dq_o}{q_o}. \quad (5.22)$$

Comparing this with (5.18) we get the relation:

$$\Omega_{\mathcal{P}_o} = \hat{\Omega}_o. \quad (5.23)$$

When we connect two vertices by an open string propagator then the corresponding contribution to the amplitude is obtained by gluing the $\mathcal{V}_{g,b,n_c,n_o}$ corresponding to the vertices by the gluing operation (5.19) picking one open string puncture from each vertex. Using this we can carry out the analog of the computation (5.13) for the open string propagator. Consider the effect of joining a pair of surfaces of type $(g_1, b_1, n_{c1}, n_{o1})$ and $(g_2, b_2, n_{c2}, n_{o2})$ via an open string propagator to construct a surface of type $(g_1 + g_2, b_1 + b_2 - 1, n_{c1} + n_{c2}, n_{o1} + n_{o2} - 2)$. (5.23) tells us that we must have

$$N_{g_1, b_1, n_{c1}, n_{o1}} N_{g_2, b_2, n_{c2}, n_{o2}} \sim N_{g_1+g_2, b_1+b_2-1, n_{c1}+n_{c2}, n_{o1}+n_{o2}-2}, \quad (5.24)$$

where \sim denotes equality up to a sign arising from rearrangement of the ghost insertions and vertex operators inside the correlation function and possible mismatch between the orientations in the

integration measure over the moduli space. Our N 's in (3.84) indeed satisfy this. Similar tests can be performed when the open string propagator connects two punctures on the same surface, either on the same boundary or on two different boundaries, leading to the conditions

$$N_{g,b,n_c,n_o} \sim N_{g,b+1,n_c,n_o+2}, \quad N_{g,b,n_c,n_o} \sim N_{g+1,b-1,n_c,n_o+2}. \quad (5.25)$$

In open closed string field theory, similar results associated with closed string propagators will also have sign ambiguities, since even though the ghost insertions associated with the propagator is Grassmann even, after gluing we may have to rearrange the ghost insertions and vertex operators on the original Riemann surface(s) to bring them to the desired arrangement on the final Riemann surface. This leads to the relations

$$\begin{aligned} \eta_c N_{g_1,b_1,n_{c1},n_{o1}} N_{g_2,b_2,n_{c2},n_{o2}} &\sim N_{g_1+g_2,b_1+b_2,n_{c1}+n_{c2}-2,n_{o1}+n_{o2}}, \\ \eta_c N_{g-1,b,n_c+2,n_o} &\sim N_{g,b,n_c,n_o}. \end{aligned} \quad (5.26)$$

In section 3.5 we have described the prescription for the signs of $\widehat{\Omega}$ for which (5.24), (5.25) and (5.26) hold exactly including signs, with \sim replaced by $=$, and as a result (3.84) also holds exactly. For a proof of this statement, we ask the readers to consult [22]. This analysis determines the normalization of $\Omega_p^{(g,b,n_c,n_o)}$ when the degree p is equal to the dimensionality of $\mathcal{M}_{g,b,n_c,n_o}$, since these are the forms that appear directly in the expression for amplitudes. Indirectly, however, it determines the normalization of forms of different degree using (3.52), suitably generalized to include open strings.

With the Feynman rules derived above, the tree amplitudes of tree-level open string field theory described in section 4.4 reproduce the disk amplitudes of the world-sheet theory with external open strings. On the other hand the full set of Feynman diagrams in the open-closed string field theory discussed in section 4.5, which now contain both open and closed string propagators, reproduce the full amplitudes given by the world-sheet theory of open and closed strings.

If we compute loop amplitudes with the vertices and propagators of tree-level open string field theory, we find that as in the case of closed string theory, the Feynman diagrams constructed from tree level vertices and propagator cover only a part of the moduli space and we need to add new contributions to fill the missing regions. However unlike in the case of tree-level closed string field theory, where all higher genus vertices contain only regular Riemann surfaces, in the case of tree-level open string field theory the missing regions include nodal Riemann surfaces associated with closed string degeneration. To avoid singular vertices, we must also add the closed strings to the theory and consider a field theory of open and closed strings, in which these singular regions can arise from Feynman diagrams with closed string propagators. The only exception to this is the bosonic cubic open SFT where the loop amplitudes constructed from the tree-level Feynman rules reproduce all the loop amplitudes [67, 68].

5.2 Results for special amplitudes

In this subsection we shall derive some specific results for specific string amplitudes. This includes analysis of the disk one-point function of closed strings to find the relation between the constant K and the D-brane tension \mathcal{T} , the effect of insertion of a closed string or an open string to a given string amplitude, the disk two-point function of one open and one closed string and the disk two-point function of two closed strings.

We shall first find the relation between the constant K appearing in (3.12) and the tension \mathcal{T} of the corresponding D-brane. For this we consider a string field of the form (4.100)

$$\mathcal{O}_h = \frac{1}{g_s} h_{\mu\nu} c \bar{c} \partial X^\mu \bar{\partial} X^\nu, \quad (5.27)$$

with constant $h_{\mu\nu}$, with μ, ν , directions along the world-volume of the D-brane, and setting $\alpha' = 1$. Comparison with the string field (4.101) shows that this corresponds to setting $e_{\mu\nu}$ to $h_{\mu\nu}$ and $e, \bar{e}, f_\mu, \bar{f}_\mu$ equal to zero. From (4.112) we now see that this corresponds to setting the string dilaton d to zero and hence from (4.121) we get

$$g_{\mu\nu} = \eta_{\mu\nu} + h_{\mu\nu}, \quad \phi = \frac{1}{4} \eta^{\mu\nu} h_{\mu\nu}. \quad (5.28)$$

On the other hand, the action S_p of a Dp -brane in this background is given by:

$$S_p = -\mathcal{T} \int d^{p+1}x e^{-\phi} \sqrt{-g}. \quad (5.29)$$

With the help of (5.28), the terms linear in $h_{\mu\nu}$ in this expression can be written as

$$S_p|_h = -\mathcal{T} \left\{ \frac{1}{2} \eta^{\mu\nu} h_{\mu\nu}^\parallel(x_\perp = 0) - \phi(x_\perp = 0) \right\} \int d^{p+1}x = -\frac{\mathcal{T}}{4} \eta^{\mu\nu} (h_{\mu\nu}^\parallel - h_{\mu\nu}^\perp) (2\pi)^{p+1} \delta^{(p+1)}(0), \quad (5.30)$$

where $h_{\mu\nu}^\parallel$ and $h_{\mu\nu}^\perp$ denotes the component of $h_{\mu\nu}$ along the D-brane and transverse to the D-brane respectively. This should be compared to the term in the open-closed string field theory linear in the string field due to the disk one-point function of closed strings. Using (4.64) and (3.84) we see that one point disk amplitude of a closed string state A is given by

$$\Omega_0^{(0,1,1,0)}(A) = -\frac{1}{2\pi i} \eta_c^{-1/2} \langle c_0^- A \rangle = \eta_c^{1/2} \langle c_0^- A \rangle. \quad (5.31)$$

For the closed string state given in (5.27), this becomes:

$$\Omega_0^{(0,1,1,0)}(\mathcal{O}_h) = \eta_c^{1/2} \frac{1}{g_s} h_{\mu\nu} \langle c_0^- c \bar{c} \partial X^\mu \bar{\partial} X^\nu \rangle. \quad (5.32)$$

We can evaluate the correlator using the operator product expansion (3.7), the normalization condition (3.12) and the fact that for Neumann (Dirichlet) boundary condition, \bar{X}^μ can be replaced by ∂X^μ ($-\partial X^\mu$) at the complex conjugate point. This gives the result for the term in the string field theory action

$$\Omega_0^{(0,1,1,0)}(\mathcal{O}_h) = \eta_c^{1/2} \frac{1}{g_s} (h_{\mu\nu}^\parallel - h_{\mu\nu}^\perp) \frac{K}{2} \eta^{\mu\nu} (2\pi)^{p+1} \delta^{(p+1)}(0). \quad (5.33)$$

Comparing (5.30) with (5.33) we get

$$K = -g_s \frac{\mathcal{T}}{2\sqrt{\eta_c}}. \quad (5.34)$$

Note that K is a complex number. We can now use (5.34) and (4.78) to get,

$$g_o^2 = -\frac{2}{\mathcal{T}} \eta_c^2 = \frac{1}{2\pi^2 \mathcal{T}} \quad \rightarrow \quad \mathcal{T} g_o^2 = \frac{1}{2\pi^2}, \quad (5.35)$$

as we quoted in (4.44).

Some specific application of these results have been discussed in [22]. Here we just summarize them, referring to [22] for the details.

1. Let us suppose that we have an amplitude with fixed set of external states, given by an appropriate integral over the moduli space of an appropriate Riemann surface. If we want to insert another closed string state $\Psi_c = c\bar{c}V_c$ into the amplitude, then the net effect of this is to insert into the world-sheet correlation function a factor

$$-\frac{g_s}{\pi} \int dy_R dy_I V_c(y), \quad (5.36)$$

where we used $y = y_R + iy_I$.

2. We can get a similar result for open strings. For every insertion of an open string state $\psi_o = cV_o$ or $\Psi_o = K^{-1/2}cV_o$ into an amplitude for a dimension one matter primary V_o , we insert into the world-sheet correlator a factor of

$$g_o \int dx V_o(x). \quad (5.37)$$

3. The disk one-point function of a closed string state with vertex operator $c\bar{c}V_c$ is given by

$$-g_s \frac{\mathcal{T}}{2} \langle c_0^- c\bar{c}V_c \rangle'. \quad (5.38)$$

4. The disk two-point function of a closed string of vertex operator $c\bar{c}V_c$ and $\Psi_o = K^{-1/2}cV_o$, $\psi_o = cV_o$, is given by

$$-i\pi\mathcal{T} g_s g_o \langle c\bar{c}V_c cV_o \rangle'. \quad (5.39)$$

5. The disk two-point function of a pair of closed string states with vertex operators $\Psi_c^{(1)} = c\bar{c}V_c^{(1)}$ and $\Psi_c^{(2)} = c\bar{c}V_c^{(2)}$ is given by,

$$\frac{i}{2} g_s^2 \mathcal{T} \int dy \langle c\bar{c}V_c^{(1)}(i) (c + \bar{c})V_c^{(2)}(iy) \rangle'. \quad (5.40)$$

It is clear that some of the signs mentioned above can be changed by field redefinition. For example, if we redefine Ψ_c as $-\Psi_c$, it will lead to an extra factor of $(-1)^{n_c}$ in the amplitude and change the minus sign to plus sign on the right hand sides of (5.36), (5.38) and (5.39). Similarly, by replacing Ψ_o by $-\Psi_o$, we can get an extra factor of $(-1)^{n_o}$ in the amplitude. However once a few signs have been chosen this way, the signs of all other amplitudes get fixed according to the analysis given above.

5.3 1PI effective action

In ordinary quantum field theories, the one-particle irreducible (1PI) effective action plays a very useful role. Operationally, the interaction vertices of the 1PI effective action are given by the sum of all Feynman diagrams contributing to an amputated Green's function, with the restriction that it should not be possible to divide the diagram into two disconnected parts by cutting a single internal propagator. Once such an action is constructed, the full Green's functions are obtained by computing *tree* diagrams of the 1PI effective field theory. Furthermore the quantum corrected vacuum is given by a suitable extremum of the 1PI effective action, and the full quantum corrected propagator is given by the tree-level propagator computed from the quadratic part of the 1PI effective action. Therefore, the masses of particles can be read out directly from the zeroes of the kinetic operator of the 1PI effective action. Note that for a quantum field theory that has gauge symmetry, one must

do gauge fixing to compute the Feynman diagrams required for the 1PI action. At the end one may write the result for the action as a sum of a gauge-invariant effective action and a gauge-fixing term.

The 1PI effective action in string field theory can be defined in the same way. Remarkably, using the results of section 5.1, it can also be constructed without explicit reference to gauge fixing, even though we implicitly use the Siegel gauge propagator. The clue is that for a string amplitude for n external closed string states at genus g , one can produce a space $\mathcal{F}_{g,n}$ in $\widehat{\mathcal{P}}_{g,n}$ that ‘covers’ the moduli space $\mathcal{M}_{g,n}$ (in the sense that the projection forgetting the coordinates is a map of degree one) by adding to $\mathcal{V}_{g,n}$, the contributions of gluing lower-order vertices with operations of the form

$$w_1 w_2 = q, \quad |q| \leq 1, \quad (5.41)$$

with w_1, w_2 coordinates at the punctures of the surfaces (or surface) to be glued. These gluing operations follow the diagrammatics of Feynman diagrams. Since q belongs to the full unit disk this ‘disk gluing’ creates surfaces, including degenerations arising for $q \rightarrow 0$ and corresponding to special ‘divisors’ in the moduli space (see section 7.3). To define the 1PI vertex, $\mathcal{V}_{g,n}^{\text{1PI}}$ one adds to the vertex $\mathcal{V}_{g,n}$ the surfaces from diagrams with disk gluing operations, as long as the cutting of any gluing line does not split the Riemann surface into two pieces.

A few facts are simple to understand. At genus zero we have

$$\mathcal{V}_{0,n}^{\text{1PI}} = \mathcal{V}_{0,n}. \quad (5.42)$$

This is because the rest of the relevant space $\mathcal{F}_{0,n}$ in $\widehat{\mathcal{P}}_{0,n}$ arises from tree graphs, thus clearly one-particle reducible. For genus one and one puncture, the full cover $\mathcal{F}_{1,1}$ in $\widehat{\mathcal{P}}_{1,1}$ is produced by adding to $\mathcal{V}_{1,1}$ the surfaces from the one-loop diagram where the three-string vertex $\mathcal{V}_{0,3}$ has two punctures glued together. Since this diagram is 1PI, it is included in the 1PI vertex which is now seen to be the full cover

$$\mathcal{V}_{1,1}^{\text{1PI}} = \mathcal{F}_{1,1}. \quad (5.43)$$

More generally, $\mathcal{V}_{g,n}^{\text{1PI}}$ includes $\mathcal{V}_{g,n}$ plus a subset of surfaces with one disk gluing operation, two disk gluing operations, and so on, with the constraint that cutting along any gluing curve does not split the Riemann surface. The surfaces obtained with one disk-gluing operation clearly takes the vertex $\mathcal{V}_{g-1,n+2}$ and disk-glues two of the punctures. One can also describe explicitly the structure of configurations with two and more disk-gluing operations. While this construction does not refer to gauge-fixing, it should be noted that in Siegel gauge, amplitudes are constructed exactly via disk-gluing. It is thus possible that alternative constructions of the 1PI action could be obtained in other string field theory gauges.

Having constructed the $\mathcal{V}_{g,n}^{\text{1PI}}$, we define the formal sum

$$\mathcal{V}_{\text{1PI}} \equiv \sum_{g,n} \mathcal{V}_{g,n}^{\text{1PI}}. \quad (5.44)$$

This object satisfies the classical version of the geometric master equation, namely,

$$\partial \mathcal{V}_{\text{1PI}} + \frac{1}{2} \{ \mathcal{V}_{\text{1PI}}, \mathcal{V}_{\text{1PI}} \} = 0, \quad (5.45)$$

reflecting that the tree diagrams constructed from the 1PI effective action gives a space $\mathcal{F}_{g,n} \subset \widehat{\mathcal{P}}_{g,n}$ which is a cover of $\mathcal{M}_{g,n}$. To show that the equation above holds we first argue that the surfaces in $\partial \mathcal{V}_{\text{1PI}}$ coincide with those in $\{ \mathcal{V}_{\text{1PI}}, \mathcal{V}_{\text{1PI}} \}$. Surfaces in $\partial \mathcal{V}_{\text{1PI}}$ do not arise from the disk gluing

operation, which does not create boundaries. Indeed, as the disk gluing parameter $q \rightarrow 0$ we get the nodal surfaces, that are a codimension two subspace relative to the vertex dimension. Nor are the surfaces arising from $|q| = 1$ boundaries of the vertex region, for here two vertices join to form a ‘bigger’ vertex whose moduli space will include surfaces where the gluing curve becomes larger. The surfaces in $\partial\mathcal{V}_{1\text{PI}}$ must arise when some vertex within $\mathcal{V}_{1\text{PI}}$ reaches a boundary. When a vertex reaches a boundary, the surface Σ in the vertex must have a curve that acquires the critical length and can play the role of a gluing curve. If cutting the gluing curve does not split the *whole* surface of the diagram, this is not a boundary; this curve can be used for disk-gluing, and a diagram with such gluing is included in the full 1PI vertex. A boundary is genuine only if the curve on the surface Σ , if cut, would split the whole surface in the diagram in two pieces. If this happens, each piece must be 1PI since, otherwise, the whole diagram would have not been 1PI. Such a boundary is precisely reproduced by $\{\mathcal{V}_{1\text{PI}}, \mathcal{V}_{1\text{PI}}\}$. Now we argue that any surface in $\{\mathcal{V}_{1\text{PI}}, \mathcal{V}_{1\text{PI}}\}$ is 1PI at the boundary $\partial\mathcal{V}_{1\text{PI}}$. It is clear that it is 1PI because each piece is, and the only new curve generated by the twist-gluing is not a propagator; it is not disk-gluing. The twist-gluing operation in this bracket creates at the joint a ‘larger’ vertex with a critical length gluing curve that separates. That means, as seen above, that these are surfaces in $\partial\mathcal{V}_{1\text{PI}}$. All in all the two terms in (5.45) contain the same surfaces, and this completes our argument.

The one-particle irreducible vertices can now be used to define multilinear maps to the Grassmann algebra as usual:

$$\{A_1, \dots, A_n\}_{1\text{PI}} = \sum_{g=0}^{\infty} g_s^{2g+n-2} \int_{\mathcal{V}_{g,n}^{1\text{PI}}} \Omega_{6g-6+2n}^{(g,n)}(A_1, \dots, A_n). \quad (5.46)$$

Then the 1PI effective action of heterotic or type II string theory is given by

$$S_{1\text{PI}} = -\frac{1}{2}\langle\tilde{\Psi}, Q\mathcal{G}\tilde{\Psi}\rangle + \langle\tilde{\Psi}, Q\Psi\rangle + \sum_{n=1}^{\infty} \frac{1}{n!} \{\Psi^n\}_{1\text{PI}}. \quad (5.47)$$

The corresponding action for the bosonic string field theory is obtained by setting $\tilde{\Psi} = \Psi$ as well as $\mathcal{G} = 1$.

Since we are supposed to only compute tree amplitudes with the 1PI effective action, we can restrict the string fields to have ghost number corresponding to classical string fields. The corresponding 1PI action will have a gauge invariance analogous to (4.35)

$$\delta|\tilde{\Psi}\rangle = Q|\tilde{\Lambda}\rangle + \sum_{n=1}^{\infty} \frac{1}{n!} [\Lambda\Psi^n]_{1\text{PI}}, \quad \delta|\Psi\rangle = Q|\Lambda\rangle + \sum_{n=1}^{\infty} \frac{1}{n!} \mathcal{G} [\Lambda\Psi^n]_{1\text{PI}}, \quad (5.48)$$

We can also relax the constraint on the ghost number and interpret $S_{1\text{PI}}$ as the 1PI effective action of the full quantum string field. In this case it will satisfy classical BV master equation:

$$\{S_{1\text{PI}}, S_{1\text{PI}}\} = 0. \quad (5.49)$$

5.4 Wilsonian effective action

In quantum field theory we have a notion of effective action, where we integrate out a subset of the fields and write down an effective action involving the remaining fields. A similar construction exists in string field theory [69]. Interestingly, the effective field theory for a selected subset of the fields is

governed by the same algebraic identities as those of the parent string field theory. We shall illustrate this in the context of type II and heterotic string field theory.

The chosen set of fields, the ‘light fields,’ is selected by the use of a projection operator P acting on the \mathcal{H}_c and $\tilde{\mathcal{H}}_c$ subspaces used earlier to formulate the parent string field theory (of type II or heterotic strings). The ‘heavy fields’, are selected by the complementary projector $1 - P$. For consistency of the construction below, the projector P is required to satisfy a number of conditions:

$$[P, L_0^\pm] = 0, \quad [P, b_0^\pm] = 0, \quad [P, c_0^\pm] = 0, \quad [P, Q] = 0, \quad [P, \mathcal{G}] = 0. \quad (5.50)$$

The main ingredient in the construction of the parent string field theory was a set of multilinear maps $\{\dots\}$ to the Grassmann algebra defining vertices for the string field in \mathcal{H}_c . Now we require a new set of multilinear maps defining vertices for the light fields— those in $P\mathcal{H}_c$. We write those as follows:

$$\{A_1, \dots, A_n\}_{\text{eff}}, \quad A_1, \dots, A_n \in P\mathcal{H}_c. \quad (5.51)$$

These effective multilinear maps represent the calculation of a modified version of the off-shell amplitude for the states A_1, \dots, A_n . At each genus g (and n punctures), this amplitude requires contributions from all the surfaces in the moduli space $\mathcal{M}_{g,n}$, with a simple modification. The contribution from the vertex $\mathcal{V}_{g,n}$ is left unchanged. The contribution from the Feynman diagrams using lower-order vertices and internal propagators is changed by inserting the projector $1 - P$ to heavy fields on each propagator. This in effect allows only the heavy fields to run on the internal lines. This is a natural prescription in an effective theory where the kinetic term will only propagate light-fields.

Then the effective action is an action for string fields

$$\Psi \in P\mathcal{H}_c, \quad \tilde{\Psi} \in P\tilde{\mathcal{H}}_c. \quad (5.52)$$

and is given by

$$S_{\text{eff}} = -\frac{1}{2}\langle \tilde{\Psi}, Q\mathcal{G}\tilde{\Psi} \rangle + \langle \tilde{\Psi}, Q\Psi \rangle + \sum_n \frac{1}{n!} \{\Psi^n\}_{\text{eff}}. \quad (5.53)$$

One can show that this action satisfies the quantum BV master equation with the symplectic structure (4.33), restricted to the subspaces $P\mathcal{H}_c$ and $P\tilde{\mathcal{H}}_c$.

For a given state in \mathcal{H}_c , let L'_0, \bar{L}'_0 denote the contribution to L_0, \bar{L}_0 other than the momentum contribution $k^2/4$. Thus, in string theory in flat space-time, L'_0, \bar{L}'_0 are the total number operators. If P is taken to be the projection operator into the $L_0'^+ = 0$ states, it is a projector into states with $L'_0 = 0$ and $\bar{L}'_0 = 0$, due to the (off-shell) vanishing of $L_0^- = L_0'^-$. Thus P is a projector to massless states, and all the massive states are integrated out. The massless states, however, can have high momentum, so the action, as given, is not the familiar Wilsonian effective action. A modification of the vertices, however, can make the action accurately Wilsonian, as we explain now.

Suppose we choose to modify the chains $\mathcal{V}_{g,n}$ in such a way that the local coordinates w at the punctures are scaled by a large positive factor λ , i.e. the new local coordinates \tilde{w} are such that $|\tilde{w}| = 1$ corresponds to $|w| = 1/\lambda$. In that case the contribution from the vertex for off-shell external states acquire suppression factors proportional to λ^{-h_i} , where h_i is the L_0^+ eigenvalue of the i -th external state. For $L_0'^+ = 0$ states this translates to a factor of $\lambda^{-k^2/2}$, showing that the contribution from large k^2 modes are suppressed in the Feynman diagrams. Effectively, the large k^2 modes have been integrated out. This now matches the definition of a Wilsonian effective action, where we integrate out the massive fields and the high momentum modes of the massless fields. Therefore the effective action, obtained after integrating out all the $L_0'^+ > 0$ modes and choosing $\mathcal{V}_{g,n}$ where local

coordinates at the punctures have large scale factors, gives the Wilsonian effective action of string field theory.

The above scaling of local coordinates can be interpreted as the inclusion of *stubs* to the surface. To see this, first note that the local coordinate w , defined for the unit disk $|w| \leq 1$, can be viewed as a semi-infinite cylinder of circumference 2π via the map $z = \ln w$ that takes the disk into the strip $0 \leq \text{Im}(z) \leq 2\pi$ and $\text{Re}(z) \leq 0$ with the horizontal boundaries identified. Then the retraction of the local coordinate disk to $|w| = 1/\lambda$ corresponds to adding to the surface the annulus $1/\lambda < |w| < 1$. In the cylinder picture, we are adding a *stub* of length $\ln \lambda$: a short cylinder of circumference 2π and height $\ln \lambda$. Stubs were introduced in closed string field theory to define local coordinates that made minimal area metrics consistent under the operation of gluing [6], as will be reviewed in section 7.8.

The notion of string theory effective actions have been usefully systematized in the context of *homotopy transfer* [70–74] of A_∞ and L_∞ structures for open and closed string theories, respectively. Under a number of precise conditions, A_∞ and L_∞ algebras on a ‘parent’ state space, give rise to derived A_∞ and L_∞ structures on projected spaces (see section 6.7). Explicit formulae for the products for the derived algebras are available. Applications and extensions of these ideas can be found in [75, 76].

5.5 Equivalence of different string field theories

As we have seen, the construction of the interaction vertices in string field theory enjoys a lot of freedom, encoded in the choice of local coordinates at the punctures, which in turn, determines how the whole moduli space of Riemann surfaces is covered by different Feynman diagrams of string field theory. Given this, one could wonder how the different string field theories are related? The simple answer to this question is that they are all related to each other by field redefinition. In this section we shall briefly describe how one can prove this.

In general a field redefinition will affect the form of the action and also the integration measure, and one needs to keep track of both to show the equivalence between two different formulations of string field theory. To avoid this, we can work with the 1PI irreducible effective action where all the quantum corrections are already included in the action. In this case the proof of equivalence of two different formulations of string field theory just involves the existence of a field redefinition that preserves the anti-bracket and leaves the action invariant [77].

For simplicity we shall focus on closed bosonic string field theory and follow the approach of Hata and one of us [78], which can be generalized to open string theory as well as superstring field theory. Let us consider a 1PI effective string field theory whose vertices are described by $\mathcal{V}_{g,n}^{1\text{PI}} \subset \widehat{\mathcal{P}}_{g,n}$, for various values of the genus g and the number of punctures n . Then the formal sum

$$\mathcal{V}^{1\text{PI}} = \sum_{g,n} g_s^{2g-n+2} \mathcal{V}_{g,n}^{1\text{PI}}, \quad (5.54)$$

satisfies

$$\partial \mathcal{V}^{1\text{PI}} + \frac{1}{2} \{ \mathcal{V}^{1\text{PI}}, \mathcal{V}^{1\text{PI}} \} = 0, \quad (5.55)$$

Let $\mathcal{V}'_{g,n} \subset \widehat{\mathcal{P}}_{g,n}$ be another set of vertices for 1PI effective field theory that are infinitesimally close to the original set of vertices $\mathcal{V}_{g,n}^{1\text{PI}}$. Then the 1PI actions $S_{1\text{PI}}$ and $S'_{1\text{PI}}$ constructed from these two sets of vertices differ by

$$S'_{1\text{PI}} - S_{1\text{PI}} = \sum_{g=0}^{\infty} \sum_{n=1}^{\infty} g_s^{2g-n+2} \left(\int_{\mathcal{V}_{g,n}^{1\text{PI}}} - \int_{\mathcal{V}'_{g,n}} \right) \Omega_{6g-6+2n}^{(g,n)}(\Psi^{\otimes n}). \quad (5.56)$$

In order to show that $S_{1\text{PI}}$ and $S'_{1\text{PI}}$ are related by a field redefinition we need to show that there is a field redefinition that relates the two actions. In other words, under such field redefinition the change in $S_{1\text{PI}}$ should be given by $S'_{1\text{PI}} - S_{1\text{PI}}$.

Such field redefinitions can be constructed explicitly. In order to keep the discussion short, we shall give the result without giving the derivation. Let $\hat{U}_{g,n}$ be an infinitesimal vector in the neighbourhood of $\mathcal{V}_{g,n}^{1\text{PI}}$ in $\hat{\mathcal{P}}_{g,n}$ that takes a point on $\mathcal{V}_{g,n}^{1\text{PI}}$ to a neighbouring point on $\mathcal{V}_{g,n}^{1\text{PI}}$. Clearly $\hat{U}_{g,n}$ is ambiguous, since we can add to $\hat{U}_{g,n}$ a tangent vector of $\mathcal{V}_{g,n}^{1\text{PI}}$, but this ambiguity will not affect our result. Now one can show that under a field redefinition $\Psi \rightarrow \Psi + \delta\Psi$, with $\delta\Psi$ defined via the equation

$$\langle \Phi | c_0^- | \delta\Psi \rangle = - \sum_{g=0}^{\infty} \sum_{n=1}^{\infty} g_s^{2g-n+2} \frac{1}{(n-1)!} \int_{\mathcal{V}_{g,n}^{1\text{PI}}} \Omega_{6g-5+2n}^{(g,n)}(\Phi, \Psi^{\otimes(n-1)})[\hat{U}_{g,n}], \quad (5.57)$$

the change in $S_{1\text{PI}}$ precisely gives (5.56). Here Φ is any state in \mathcal{H}_c defined in (4.3) and $[\hat{U}_{g,n}]$ denotes contraction of the $(6g-5+2n)$ form with the tangent vector $\hat{U}_{g,n}$, resulting in a $(6g-6+2n)$ form to be integrated over the 1PI vertex.

The construction of [78] was at the infinitesimal level, and the uniqueness was shown assuming that the vertices are submanifolds and partial sections of $\hat{\mathcal{P}}_{g,n}$. These limitations were overcome in [79], as explained in detail in [34]. We will touch on this in section 7.3, when discussing the uniqueness of solutions of the geometric master equation.

5.6 Background independence

We have seen that the construction of string field theory requires us to start with a given background, encoded in the world-sheet (super-)conformal field theory underlying the string theory, and then constructing the interaction vertices of string field theory using the correlation functions in that particular world-sheet (super-)conformal field theory. However on physical grounds we expect that string theories constructed around different backgrounds should be related to each other by an appropriate redefinition of the fields.¹⁰ This has been established in string field theory when the backgrounds are related by (infinitesimal) marginal deformation. In this section we shall briefly describe how this is done.

The proof of background independence of the classical theory involves showing that the classical action formulated around two different backgrounds are related by field redefinition. This was proved in [80] following earlier work of [81–83]. The proof of background independence of the quantum theory is more delicate; this time the combination of the action and the integration measure must be shown to be background independent, and this was achieved in [84]. As in section 5.5, we can avoid this complication by using the 1PI effective action, where the steps involved in the proof are simpler to explain. Also, let us first focus on closed bosonic string field theory for definiteness. Under infinitesimal marginal deformation, the BRST operator as well as all correlation functions of the CFT get deformed. This changes the kinetic term and the interaction terms of string field theory. Let us denote the 1PI effective action of string field theory around the deformed background by $S'_{1\text{PI}}$. Then the problem of showing background dependence boils down to showing that there is a deformation $\delta\Psi$ of the string field under which the change in $S_{1\text{PI}}$ is precisely equal to $S'_{1\text{PI}} - S_{1\text{PI}}$. An explicit form of $\delta\Psi$ satisfying this property can be found in [85].

¹⁰The usual lore is that a field redefinition does not change the S-matrix. However, the field redefinition that relates string field theories around different backgrounds involves a shift that changes the vacuum of the theory. As a result the S-matrix changes.

The generalization of the result to open or open-closed bosonic string field theory is straightforward. For superstring field theories there is an additional subtlety. We have seen that the formulation of string field theory for the Ramond sector fields requires doubling the number of degrees of freedom, but one linear combination of the two fields remains free and decouples from the S-matrix. It turns out that if we deform the original world-sheet SCFT by a marginal operator then both the free field part of the equations of motion and the interacting field equations change, since both use the deformed BRST operator at the linearized level, and the interacting part of the field also uses the deformed world-sheet correlation functions. On the other hand if we start with the string field theory formulated in the original background, then by making a suitable redefinition of the fields we can make the interacting part of the field equations agree with the interacting part of the field equations formulated in the deformed CFT, but the free field equations of motion remain unchanged, and continues to use the BRST operator of the original CFT [85]. Therefore the actions formulated around the original background and the deformed background are not related by a field redefinition. However the agreement between the interacting part of the field equations derived from the 1PI action after field redefinition implies that the S-matrix elements computed using string field theory in the deformed background and string field theory in the original background after field redefinition including shift are identical. This can be taken as the statement of background independence of the theory.

The analysis can also be generalized to the case where we have a pair of CFTs connected by a nearly marginal deformation [86,87]. In this case the central charges of the two CFTs differ, but this can be compensated by having a linear dilaton background field.

5.7 Dilaton theorem

The dilaton theorem is the statement that a shift of the zero-momentum dilaton in the string field theory action has the effect of changing the string coupling of the theory. Our discussion here will focus on the bosonic closed string field theory, for which this theorem was proven in [88,89]. The proof applies for any closed string background because the zero momentum dilaton state can be represented by a universal state built up from ghost operators only and thus is always present; this is the so-called ghost dilaton $D(z, \bar{z})$ given by

$$D(z, \bar{z}) = \frac{1}{2}(c\partial^2 c - \bar{c}\bar{\partial}^2 \bar{c}). \quad (5.58)$$

The associated state $|D\rangle$ obtained by acting with this field on the vacuum $|0\rangle$ is

$$|D\rangle = (c_1 c_{-1} - \bar{c}_1 \bar{c}_{-1})|0\rangle. \quad (5.59)$$

Note that this state, carrying general momentum, appeared in section 4.7 as the coefficient of the field d (see equations (4.112) and (4.101)). This zero-momentum state is killed by the BRST operator, and it is not BRST trivial, thus it is a physical state. It also obeys the subsidiary conditions needed to belong to the closed string field theory state space:

$$b_0^- |D\rangle = 0, \quad L_0^- |D\rangle = 0. \quad (5.60)$$

The most direct way to see that the state is BRST invariant is by noticing that

$$|D\rangle = Qc_0^- |0\rangle = -Q|\chi\rangle, \quad |\chi\rangle = -c_0^- |0\rangle. \quad (5.61)$$

Clearly, $Q|D\rangle = 0$, but despite appearances $|D\rangle$ is not trivial because the ‘gauge parameter’ $|\chi\rangle$ does not belong to the closed string field theory state space. Indeed $b_0^-|\chi\rangle = -b_0^-c_0^-|0\rangle = -|0\rangle$ and does not vanish. Another unusual property of the physical state $|D\rangle$ is that it is not primary! In fact, one can verify that

$$L_1|D\rangle = c_0c_1|0\rangle, \quad \bar{L}_1|D\rangle = -\bar{c}_0\bar{c}_1|0\rangle. \quad (5.62)$$

All higher L_n, \bar{L}_n with $n \geq 2$ kill the state $|D\rangle$. Since the state $|D\rangle$ while physical is not a dimension zero primary, its insertion is sensitive to the local coordinates used. The state $|\chi\rangle$ is also not primary: one can verify that $L_1|\chi\rangle = c_1|0\rangle$ and $\bar{L}_1|\chi\rangle = -\bar{c}_1|0\rangle$. The subtleties in dealing with correlators of the non-primary D and χ states were discussed in the context of conformal field theory in [90].

The soft dilaton theorem states that the integral of a dilaton insertion in a correlator of on-shell vertex operators and the $\mathcal{B}[\partial/\partial v^i]$ insertions on a fixed Riemann surface ends up multiplying the correlator by a constant proportional to the Euler number of the surface, plus total derivative terms with respect of the v^i 's that integrate to zero when we integrate over the moduli v^i of the original Riemann surface. Note that we are using v^i to denote the moduli of the original punctured Riemann surface to distinguish it from the moduli u^1, u^2 that we shall introduce shortly to label the location of the dilaton vertex operator on the Riemann surface. First let us review the proof of this result. The strategy is as follows.

1. Let $\Omega_2(D)$ denote the two form that describes the effect of inserting the dilaton into an on-shell amplitude in the same sense as (3.47):

$$\Omega_2(D) = \left(-\frac{1}{2\pi i}\right) du^1 \wedge du^2 \mathcal{B}\left[\frac{\partial}{\partial u^1}\right] \mathcal{B}\left[\frac{\partial}{\partial u^2}\right] D(w=0). \quad (5.63)$$

If $|\chi\rangle$ had been a regular state in \mathcal{H}_c , then using (3.52) we would get

$$\Omega_2(D) = -d\Omega_1(\chi), \quad (5.64)$$

where Ω_1 is the one form associated with χ insertion

$$\Omega_1(\chi) = \left(-\frac{1}{2\pi i}\right) \left(du^1 \mathcal{B}\left[\frac{\partial}{\partial u^1}\right] + du^2 \mathcal{B}\left[\frac{\partial}{\partial u^2}\right] \right) \chi(w=0). \quad (5.65)$$

We note that (5.64) does not hold in general because χ is not an element of \mathcal{H}_c and hence $\Omega_1(\chi)$ is not a well defined one form.¹¹ We shall show that if we consider a region of the moduli space where the dilaton is close to one of the external states, then (5.64) holds in that region up to addition of total derivatives with respect to the moduli v^i of the original Riemann surface, with d interpreted as the exterior derivative in the space spanned by u^1, u^2 . Since we are ignoring the total derivative terms in v^i , this allows us to express the effect of the dilaton insertion as the insertion of

$$\int_M \Omega_2(D) + \int_{\partial M} \Omega_1(\chi), \quad (5.66)$$

where M is the region of the Riemann surface that excludes small disks around other punctures.

2. Next we note that the Euler number $\chi(M)$ of a two-dimensional surface M with boundary ∂M is given by

$$\chi(M) = \frac{1}{2\pi} \int_M K^{(2)} + \frac{1}{2\pi} \int_{\partial M} k^{(1)}. \quad (5.67)$$

¹¹Over domains where the phase of local coordinates is globally well defined, however, the form is well defined.

Here $K^{(2)}$ is the two-form Gaussian curvature, computed from a conformal metric $ds = \rho |dz|$, and written as $K^{(2)} = K \rho^2 dx \wedge dy$, with $z = x + iy$ and K the Gaussian curvature (the scalar curvature is $R = 2K$). Moreover, $k^{(1)}$ is the geodesic curvature one form. More explicitly,

$$\begin{aligned} K^{(2)} &= -2i \partial \bar{\partial} \rho dz \wedge d\bar{z}, \\ k^{(1)} &= d\theta_\gamma - i[dz \partial \log \rho - d\bar{z} \bar{\partial} \log \rho], \end{aligned} \tag{5.68}$$

where the term $d\theta_\gamma$ computes the rotation angle of the tangent vector to the curve $\gamma \in \partial M$. The Euler number of a surface $\Sigma_{g,n}$ of genus g with n boundaries is $\chi_{g,n} = 2 - 2g - n$.

3. Finally, we shall show that

$$\Omega_2(D) = -\frac{1}{2\pi} K^{(2)} \quad \text{and} \quad \Omega_1(\chi) = -\frac{1}{2\pi} k^{(1)}. \tag{5.69}$$

This, together with (5.66) and (5.67) would then establish the soft dilaton theorem for on-shell amplitudes.

Let us begin with the first step, namely that when the dilaton is close to one of the other vertex operators, we can replace $\Omega_2(D)$ by $-d\Omega_1(\chi)$. In the string field theory such contributions come from Feynman diagrams with a three-point function involving D , an on-shell vertex operators $c\bar{c}V$ and an off-shell internal state in \mathcal{H}_c is connected by a propagator to the rest of the Feynman diagram. We can now write $D = -Q\chi$ and deform the BRST contour away from the location of χ and through $c\bar{c}V$ to act on the off-shell vertex operator and hence on the propagator. The commutator of Q with the b_0^+ term in the propagator \mathcal{P}_b in (5.4) brings down a factor of L_0^+ and gives

$$[Q, \mathcal{P}_b] = \frac{1}{2\pi} b_0^- \int_0^{2\pi} d\theta \int_0^\infty ds \frac{\partial}{\partial s} e^{-s(L_0 + \bar{L}_0)} e^{i\theta(L_0 - \bar{L}_0)}. \tag{5.70}$$

This is a total derivative term that we now argue, can be regarded as the insertion of $-d\chi$. The boundary term from $s = \infty$ vanishes since all the states that can contribute have $L_0 > 0$,¹² whereas the boundary term at $s = 0$ is the integral of $\Omega_1(\chi)$ along the part of ∂M associated with the θ integral of the collapsed propagator. The action of Q on the rest of the vertex operators vanishes since all other external states are BRST invariant and the anti-commutator of Q with the $\mathcal{B}[\partial/\partial v^i]$ insertions will generate total derivative with respect to v^i which will eventually integrate to zero after integration over the v^i 's. This shows that $\Omega_2(D)$ can be replaced by $-d\Omega_1(\chi)$ in this region of the moduli space. The same result holds when the dilaton is close to any other other external state vertex operators.

We now turn to the proof of (5.69), following [88]. This is somewhat non-trivial since the dilaton vertex operator is not of the form $c\bar{c}V$ for a dimension (1,1) matter primary V , and hence the procedure described in the paragraph following (3.44) does not work. In particular the form that

¹²There are no tachyonic states since in the matter sector the state that flows along the propagator is a dimension (1,1) primary V or its descendent. In the ghost sector the state has ghost number (0,2) or (2,0) and hence the state $c\bar{c}V$ also cannot propagate. This also shows that instead of writing $D = -Q\chi$ and deforming the BRST contour, we could use the original expression involving D and place an upper cut-off Λ in the integral over s associated with the propagator. Then the large Λ limit of the integral is finite and reproduces the full integral. This would mean that the sum of all the Feynman diagrams can be approximated by the integral of $\Omega_2(D)$ over the original Riemann surface except for small regions around the original punctures. Physically this happens because in string field theory the punctures are represented as semi-infinite cylinders and cutting out small regions around the punctures correspond to cutting out the regions near the far end of the cylinders. Since the cylinders are flat, the integral of $\Omega_2(D)$ from these regions vanish and there is no need to include the $\Omega_1(\chi)$ boundary integrals to recover the Euler number.

needs to be integrated over the moduli space now depends on the choice of local coordinates at the puncture. We will consider some domain on the Riemann surface with a local uniformizer z used to label the points in this domain. We write the relation between z and the local coordinate w around the puncture where the dilaton is inserted as

$$z = F(w; u) = F(w; u^1, u^2), \quad (5.71)$$

where we have parameters $u = (u^1, u^2)$ with u^1 and u^2 real variables encoding the position of the puncture via the complex variable $y(u)$ obtained by setting $w = 0$ in F :

$$y(u) = F(0; u). \quad (5.72)$$

Given this definition, we can write z as a series expansion in w , thus describing a general F as follows:

$$z = F(w; u^1, u^2) = y(u) + a(u)w + \frac{1}{2}b(u)w^2 + \frac{1}{3!}c(u)w^3 + \mathcal{O}(w^4), \quad (5.73)$$

with a, b, c arbitrary complex-valued functions of the parameters u^1 and u^2 .

Let us now determine the antighost insertions

$$\begin{aligned} \mathcal{B} \left[\frac{\partial}{\partial u^i} \right] &= \oint b(z) dz \frac{\partial F}{\partial u^i} + \oint \bar{b}(\bar{z}) d\bar{z} \frac{\partial \bar{F}}{\partial u^i} \\ &= - \oint b(w) dw \left(\frac{\partial F}{\partial w} \right)^{-1} \frac{\partial F}{\partial u^i} - \oint \bar{b}(\bar{w}) d\bar{w} \left(\frac{\partial \bar{F}}{\partial \bar{w}} \right)^{-1} \frac{\partial \bar{F}}{\partial u^i}, \end{aligned} \quad (5.74)$$

where we passed to the w frame so that the insertions act directly on the operator, itself inserted in w frame. Next we use (5.73) to evaluate in a power series in w the expressions inside the above integrals. A short calculation gives

$$\left(\frac{\partial F}{\partial w} \right)^{-1} \frac{\partial F}{\partial u^i} = \alpha_i + \beta_i w + \gamma_i w^2 + \mathcal{O}(w^3), \quad (5.75)$$

where the expansion coefficients are quickly confirmed to be

$$\begin{aligned} \alpha_i &= \frac{1}{a} \frac{\partial y}{\partial u^i}, \\ \beta_i &= \frac{1}{a} \frac{\partial a}{\partial u^i} - \frac{b}{a^2} \frac{\partial y}{\partial u^i}, \\ \gamma_i &= a \frac{\partial}{\partial u^i} \left(\frac{b}{2a^2} \right) + \left(\frac{b^2}{a^3} - \frac{1}{2} \frac{c}{a^2} \right) \frac{\partial y}{\partial u^i}. \end{aligned} \quad (5.76)$$

For the complex conjugate factor in the antighost insertion the result is the same, with all quantities complex conjugated. This means that with the oscillator expansion $b(w) = \sum_n b_n/w^{n+2}$, and the analogous one for $\bar{b}(\bar{w})$, we have

$$\mathcal{B} \left[\frac{\partial}{\partial u^i} \right] = - (\alpha_i b_{-1} + \beta_i b_0 + \gamma_i b_1 + \bar{\alpha}_i \bar{b}_{-1} + \bar{\beta}_i \bar{b}_0 + \bar{\gamma}_i \bar{b}_1 + \dots), \quad (5.77)$$

where the dots indicate terms with oscillators b_n, \bar{b}_n with $n \geq 2$, which are not needed for the dilaton computation. Now we find from (5.63),

$$\begin{aligned} \Omega_2(D) &= \left(-\frac{1}{2\pi i} \right) du^1 \wedge du^2 \mathcal{B} \left[\frac{\partial}{\partial u^1} \right] \mathcal{B} \left[\frac{\partial}{\partial u^2} \right] (c_1 c_{-1} - \bar{c}_1 \bar{c}_{-1}) |0\rangle \\ &= \left(\frac{1}{2\pi i} \right) du^1 \wedge du^2 [\alpha_1 \gamma_2 - \alpha_2 \gamma_1 - (\bar{\alpha}_1 \bar{\gamma}_2 - \bar{\alpha}_2 \bar{\gamma}_1)] |0\rangle, \end{aligned} \quad (5.78)$$

where we note that within the brackets, the second term, in parentheses, is the complex conjugate (c.c.) of the first. Moreover, both terms are antisymmetric in the 1 and 2 labels. Using the values of the α and γ coefficients we find

$$\Omega_2(D) = \left(\frac{1}{2\pi i}\right) du^1 \wedge du^2 \left[\frac{\partial y}{\partial u^1} \frac{\partial}{\partial u^2} \left(\frac{b}{2a^2}\right) - \frac{\partial y}{\partial u^2} \frac{\partial}{\partial u^1} \left(\frac{b}{2a^2}\right) - (\text{c.c.}) \right] |0\rangle \quad (5.79)$$

where terms involving the product $\frac{\partial y}{\partial u^1} \frac{\partial y}{\partial u^2}$ cancel out for the $1 \leftrightarrow 2$ antisymmetry. We then find

$$\Omega_2(D) = \frac{1}{2\pi i} \left[dy \wedge d\left(\frac{b}{2a^2}\right) - d\bar{y} \wedge d\left(\frac{\bar{b}}{2\bar{a}^2}\right) \right] |0\rangle \quad (5.80)$$

which is simply

$$\Omega_2(D) = \frac{1}{2\pi i} dy \wedge d\bar{y} \left[\frac{\partial}{\partial \bar{y}} \left(\frac{b}{2a^2}\right) + \frac{\partial}{\partial y} \left(\frac{\bar{b}}{2\bar{a}^2}\right) \right]. \quad (5.81)$$

This is our final result for the integrated dilaton insertion two-form. Since the vacuum state corresponds to the identity operator, we deleted $|0\rangle$ and effectively this form integrates a function over the surface.

For the χ state one form we have from (5.65) and (5.77),

$$\begin{aligned} \Omega_1(\chi) &= -\frac{1}{2\pi i} \left(-\frac{1}{2} du^1 \mathcal{B} \left[\frac{\partial}{\partial u^1} \right] - \frac{1}{2} du^2 \mathcal{B} \left[\frac{\partial}{\partial u^2} \right] \right) (c_0 - \bar{c}_0) |0\rangle \\ &= -\frac{1}{2\pi i} \left(\frac{1}{2} du^1 (\beta_1 - \bar{\beta}_1) + \frac{1}{2} du^2 (\beta_2 - \bar{\beta}_2) \right) |0\rangle. \end{aligned} \quad (5.82)$$

Using the values of the β_i one readily finds

$$\Omega_1(\chi) = \frac{1}{2\pi i} \left[-\frac{1}{2} d\left(\ln \frac{a}{\bar{a}}\right) + \frac{b}{2a^2} dy - \frac{\bar{b}}{2\bar{a}^2} d\bar{y} \right]. \quad (5.83)$$

This is our final result for the integrated χ one-form. One quickly verifies that $\Omega_2(D) = -d\Omega_1(\chi)$.

Note that in the analysis above we have ignored the possibility of the point y meeting the contours associated with $\mathcal{B}[\partial/\partial v^i]$ insertions. It has been shown in [88] (section 6.1) that there is no extra contribution from these regions of y integration.

At this point, to make these forms compute geometrically recognizable quantities, we now place a condition on an a priori arbitrary conformal metric ρ on the surface. A conformal metric is one where the length element is $ds = \rho|dz|$. We demand that the real and imaginary parts of w function as Riemann normal coordinates at the location of the puncture [91]. To deal with the dilaton, it suffices to demand the lowest order version of the constraint; that the metric ρ^w in the w frame satisfy $\partial_w \rho^w|_{w=0} = \partial_{\bar{w}} \rho^w|_{w=0} = 0$. That is, we are setting the linear parts of the w dependence of the metric to zero. To implement this, we write the metric as $ds = \rho^w |dw|$ in the w coordinate, with

$$\rho^w(w) = \rho \left| \frac{dz}{dw} \right| = \left(\rho(y) + (z-y) \frac{\partial \rho}{\partial z} \Big|_y + (\bar{z}-\bar{y}) \frac{\partial \rho}{\partial \bar{z}} \Big|_y + \dots \right) \left| a + bw + \dots \right| \quad (5.84)$$

where dots represent terms higher order in w that will not be relevant. Noting that at the puncture, where the derivatives are evaluated, z can be traded for y , and to linear order in w, \bar{w} , we have

$$\begin{aligned} \rho^w(w) &= \rho \left| \frac{dz}{dw} \right| = \left(\rho(y) + a w \frac{\partial \rho}{\partial y} \Big|_y + \bar{a} \bar{w} \frac{\partial \rho}{\partial \bar{y}} \Big|_y + \dots \right) |a| \left(1 + \frac{b}{2a} w + \frac{\bar{b}}{2\bar{a}} \bar{w} + \dots \right) \\ &= \rho(y) |a| \left[1 + a w \left(\frac{\partial}{\partial y} \log \rho + \frac{b}{2a^2} \right) + \bar{a} \bar{w} \left(\frac{\partial}{\partial \bar{y}} \log \rho + \frac{\bar{b}}{2\bar{a}^2} \right) + \dots \right]. \end{aligned} \quad (5.85)$$

The condition that first derivatives of ρ^w vanish at y requires the linear terms in w in the above expression to vanish. This sets

$$\frac{b}{2a^2} = -\frac{\partial}{\partial y} \log \rho, \quad \frac{\bar{b}}{2\bar{a}^2} = -\frac{\partial}{\partial \bar{y}} \log \rho. \quad (5.86)$$

With these relations the dilaton and χ forms, become, respectively

$$\begin{aligned} \Omega_2(D) &= \left(\frac{1}{2\pi i}\right) dy \wedge d\bar{y} \left[-2\frac{\partial}{\partial \bar{y}} \frac{\partial}{\partial y} \log \rho\right], \\ \Omega_1(\chi) &= \frac{1}{2\pi i} (-i) \left[d\theta_a - idy \frac{\partial}{\partial y} \log \rho + i d\bar{y} \frac{\partial}{\partial \bar{y}} \log \rho \right], \end{aligned} \quad (5.87)$$

where we set $a = |a|e^{i\theta_a}$, so that θ_a is the phase of the a coefficient ($|a|$ is the so-called mapping radius of the local coordinate). Comparing with the curvature two form and the geodesic curvatures in (5.68) we have

$$\Omega_2(D) = -\frac{1}{2\pi} K^{(2)} \quad \text{and} \quad \Omega_1(\chi) = -\frac{1}{2\pi} k^{(1)}. \quad (5.88)$$

This result confirms the anticipated role of the dilaton D and χ insertions. We integrate the dilaton form over the surface minus the coordinate disks of the punctures, where the other external states are inserted. This prevents the collision of the dilaton and the external states. Having stopped at the boundaries, we must include the integration of the χ one-form over the circles bounding the coordinate disks. Both integrals together give the Euler number of the surface, independent of the fiducial metric ρ used to create the family of local coordinates.

Note that the proof of (5.88) is valid for arbitrary off-shell states A_1, \dots, A_n in the correlation function. This establishes that for a fixed Riemann surface, integrating $\Omega_{6g-6+2n+2}^{(g,n+1)}(D, A_1, \dots, A_n)$ over the surface minus the coordinate disks, with moduli describing the location where D is inserted, supplemented by the integral of $\Omega_{6g-6+2n+1}^{(g,n+1)}(\chi, A_1, \dots, A_n)$ over the boundaries of the coordinate disks, with moduli describing the location where χ is inserted, gives [88]

$$(2 - 2g - n) \Omega_{6g-6+2n}^{(g,n)}(A_1, \dots, A_n). \quad (5.89)$$

This is the result needed for a dilaton shift to change the coupling constant of the theory, for (minus) the Euler number is the power of the coupling constant appearing in the string interactions in the combination $(g_s)^{-\chi_{g,n}} \{A_1, \dots, A_n\}_g$ (see equation (4.11)).

The proof of the dilaton theorem in string field theory uses the above result as a guide to construct the field redefinition that maps the combination of the string field action and the measure with one value of the string coupling, to the same combination with a small variation of the coupling constant. To leading order, there is a shift of the string field by the dilaton $|D\rangle$. This is the first term of a not-quite-legal gauge transformation with gauge parameter $|\chi\rangle$, and the next term in the field redefinition involves the insertion of $|\chi\rangle$ on the three string vertex. But higher order terms in the redefinition need modifications, because the illegality of χ begins to matter. The redefinition is also different from the one in the background independence analysis, because the dilaton is not a primary. The full redefinition is given in [88], section 8, in the language of a ‘Hamiltonian’ that induces the field redefinition via the antibracket.

6 Algebraic structures underlying string field theories

In string field theory, as presently formulated, the string field action S is a functional of a string field. The string field is defined as a general vector in the state space of a suitably chosen conformal or

super-conformal two-dimensional field theory. Most versions of string field theories share a common algebraic structure. For classical open string field theories, the structure on the \mathcal{H}_o space where the string field lives is a cyclic A_∞ algebra of multilinear string field products satisfying a set of relations and endowed with a cyclic inner product [56]. For classical closed string field theories, the structure on \mathcal{H}_c is an L_∞ algebra of multilinear string field products satisfying a set of relations, and a symmetric inner product [6]. Such kind of L_∞ structures also exist for ordinary field theories, as reviewed in detail and elaborated in [92].

In this section we will describe such structures and show how they can be used to construct actions that satisfy the Batalin-Vilkovisky master equation, and are thus guaranteed a consistent quantization. The free string field theories require the definition of the lowest product in the algebra, a product with one input string field, giving an output string field. This is simply a linear operator, identified with the BRST operator of the conformal field theory. The free string field theory also requires the inner product, which also arises naturally from the conformal field theory. The interaction terms in the string field theory require the definition of string vertices, which we will discuss in the following section. For the time being, we simply assume suitable vertices exist that allow one to construct the multilinear string products needed for the A_∞ and L_∞ algebras.

For the quantum closed string field theory the L_∞ structure is modified. While the multilinear products of the classical theory arise from string amplitudes on genus-zero punctured Riemann surfaces, the multilinear products of the quantum theory require punctured Riemann surfaces of genus one and higher. The consistency relations satisfied by the products are also modified for the quantum theory, some authors calling the resulting structure a ‘quantum L_∞ algebra’. For classical open string field theories, a tractable quantum theory requires including closed strings as part of the spectrum. The resulting open-closed string field theories have an algebraic structure in which A_∞ and L_∞ subalgebras are extended to a larger self-consistent structure involving interactions of both open and closed strings.

As discussed in section 4, for open superstrings, heterotic strings, and type II strings, a complete construction in the L_∞ framework involves adding an extra copy of the string field, a copy that is needed to get the action and equations of motion to work out, but that turns out to describe free, decoupled degrees of freedom. There exist some versions of superstring field theories that do not fit the A_∞ or L_∞ structures but are rather based on Wess-Zumino-Witten (WZW) like algebraic structures; these will be reviewed in section 8.

Homotopy algebras are a useful organizing principle in string field theory, and their development was strongly influenced by the string constructions they had to describe. There have also been a number of recent applications of homotopy algebras to ordinary field theory, such as W -algebras, double copy relations, and double field theory [93–97]. Some recent work on homotopy algebras and BV quantization in the context of superstring field theory can be found in [74, 98].

6.1 A_∞ algebras and classical open string field theory

In this section we shall give a formal description of the A_∞ algebra that underlies the formulation of tree-level open string field theory. In the following section we shall discuss the relation between this formal structure and the formulation of open string field theory described in section 4.4.

For this algebraic structure we simply assume that we work with a vector space V with elements with a natural \mathbb{Z} grading, which gives the ‘degree’ of the elements. For most aspects all that matters is the degree modulo two; we have even elements if the degree is zero (mod 2) or odd elements if the

degree is one (mod 2). We shall denote by d_A the degree of the element A . In the analysis in this section, even degree elements will behave as Grassmann even and odd degree elements will behave as Grassmann odd.¹³

We now define the products of the A_∞ algebra. For this we define a set of multilinear maps $b_n : V^{\otimes n} \rightarrow V$ with $n = 1, 2, \dots$. These are products, as they take n vectors in V as input and the output is a vector in V . All products are declared to be of degree minus one, meaning that

$$\deg(b_n(A_1, \dots, A_n)) = -1 + \sum_{i=1}^n d_{A_i}. \quad (6.1)$$

In order to formulate the consistency conditions satisfied by these multilinear maps one forms the larger vector space called the ‘tensor co-algebra’ $T(V)$

$$T(V) \equiv V \oplus (V \otimes V) \oplus (V \otimes V \otimes V) \oplus \dots \quad (6.2)$$

Acting on such a space one can consider the linear operator \mathbf{b} of degree minus one which essentially is the sum of all multilinear maps. When it acts on the $V^{\otimes n}$ subspace of $T(V)$, the operator \mathbf{b} is defined as follows:

$$\mathbf{b} = \sum_{i=1}^n \sum_{j=0}^{n-i} \mathbb{1}^{\otimes j} \otimes b_i \otimes \mathbb{1}^{n-i-j}, \quad \text{on } V^{\otimes n}. \quad (6.3)$$

As one can see, in here, the product b_i acts on all the possible length- i list of consecutive entries in $V^{\otimes n}$. It is possible to unpack this, and to break \mathbf{b} into a sum of linear operators:

$$\mathbf{b} = \sum_{i=1}^{\infty} \mathbf{b}_i = \mathbf{b}_1 + \mathbf{b}_2 + \dots \quad (6.4)$$

Then, consistent with (6.3) we have

$$\mathbf{b}_i = \sum_{j=0}^{n-i} \mathbb{1}^{\otimes j} \otimes b_i \otimes \mathbb{1}^{n-i-j}, \quad \text{on } V^{\otimes n}, \quad \text{for } i \leq n. \quad (6.5)$$

When $i > n$, \mathbf{b}_i acting on $V^{\otimes n}$ is zero. Note that \mathbf{b}_i is an operator on $T(V)$ while b_i is an operator on $V^{\otimes i}$. In fact, an operator like \mathbf{b}_i acting in this fashion on $T(V)$ is called a *coderivation*, and a sum of coderivations, such as \mathbf{b} , is also a coderivation.¹⁴ In fact, the most general coderivation can be specified in terms of multilinear products [99], as we did for \mathbf{b} , which is defined by the collection of b_i 's.

Acting on $V^{\otimes 3}$, for example, \mathbf{b} becomes

$$\mathbf{b} = b_1 \otimes \mathbb{1} \otimes \mathbb{1} + \mathbb{1} \otimes b_1 \otimes \mathbb{1} + \mathbb{1} \otimes \mathbb{1} \otimes b_1 + b_2 \otimes \mathbb{1} + \mathbb{1} \otimes b_2 + b_3, \quad \text{on } V^{\otimes 3}, \quad (6.6)$$

¹³When we apply this to open string field theory, however, this assignment of degree is opposite to that of the Grassmannality of the vertex operator, *e.g.* a vertex operator carrying odd ghost number will correspond to an even degree element of the algebra. To avoid confusion, we have introduced the symbol d_A for degree of A , which is to be distinguished from the Grassmannality of the vertex operators that will be denoted by $(-1)^A$. The relation between the formalism developed in this section and that used in section 4.4 will be explained in section 6.2.

¹⁴To fully define a coderivation one must define a *coproduct* $\bar{\Delta} : T(V) \rightarrow T(V) \otimes' T(V)$, with the prime to distinguish this product from just the tensor product within $T(V)$. The coproduct is a linear operator acting as follows

$$\bar{\Delta}(A_1 \otimes \dots \otimes A_n) = \sum_{k=1}^{n-1} (A_1 \otimes \dots \otimes A_k) \otimes' (A_{k+1} \dots \otimes A_n), \quad n \geq 2, \quad \bar{\Delta}(A_1) = 0.$$

A linear operator \mathbf{a} on $T(V)$ is a coderivation if $\bar{\Delta}\mathbf{a} = (\mathbf{a} \otimes' \mathbf{I} + \mathbf{I} \otimes' \mathbf{a})\bar{\Delta}$, with \mathbf{I} the identity operator on $T(V)$.

and acting on $A \otimes B \otimes C \in V^{\otimes 3}$ we would get

$$\begin{aligned} \mathbf{b}(A \otimes B \otimes C) = & b_1(A) \otimes B \otimes C + (-1)^{d_A} A \otimes b_1(B) \otimes C + (-1)^{d_A+d_B} A \otimes B \otimes b_1(C) \\ & + b_2(A, B) \otimes C + (-1)^{d_A} A \otimes b_2(B, C) + b_3(A, B, C), \end{aligned} \quad (6.7)$$

with the sign factors arising when the odd degree b 's go across the states. Note that the result on the right-hand side is an element of $V \oplus (V \otimes V) \oplus (V \otimes V \otimes V)$.

The (graded) commutator of coderivations is in fact a coderivation, so $\mathbf{b}^2 = \frac{1}{2}\{\mathbf{b}, \mathbf{b}\}$ is a coderivation. The consistency condition on the products is simply the requirement that the coderivation \mathbf{b}^2 vanishes, so that \mathbf{b} has the property of a differential:

$$\mathbf{b}^2 = 0. \quad (6.8)$$

The content of these conditions is fully seen by consideration of the action on the various summands of $T(V)$, namely $V^{\otimes n}$ with $n \geq 1$. On $V^{\otimes n}$ the condition can be expressed as

$$\sum_{i=1}^n \mathbf{b}_i \mathbf{b}_{n+1-i} = 0, \quad \text{on } V^{\otimes n}. \quad (6.9)$$

The product here is composition of the operator action. The A_∞ algebra is simply the vector space V with the products b_n , that when assembled into \mathbf{b} as in (6.4), satisfy (6.8).

The first few cases of the conditions are

$$\begin{aligned} \text{Acting on } V : 0 &= \mathbf{b}_1 \mathbf{b}_1, \\ \text{Acting on } V^{\otimes 2} : 0 &= \mathbf{b}_1 \mathbf{b}_2 + \mathbf{b}_2 \mathbf{b}_1, \\ \text{Acting on } V^{\otimes 3} : 0 &= \mathbf{b}_1 \mathbf{b}_3 + \mathbf{b}_2 \mathbf{b}_2 + \mathbf{b}_3 \mathbf{b}_1. \end{aligned} \quad (6.10)$$

More explicitly, using the string products and the symbol \circ for composition,

$$\begin{aligned} \text{Acting on } V : 0 &= b_1 \circ b_1, \\ \text{Acting on } V^{\otimes 2} : 0 &= b_1 \circ b_2 + b_2 \circ (b_1 \otimes \mathbb{1} + \mathbb{1} \otimes b_1), \\ \text{Acting on } V^{\otimes 3} : 0 &= b_1 \circ b_3 + b_2 \circ (b_2 \otimes \mathbb{1} + \mathbb{1} \otimes b_2), \\ &+ b_3(b_1 \otimes \mathbb{1} \otimes \mathbb{1} + \mathbb{1} \otimes b_1 \otimes \mathbb{1} + \mathbb{1} \otimes \mathbb{1} \otimes b_1). \end{aligned} \quad (6.11)$$

We will write $b_1(A) = QA$, with Q the BRST operator. The product b_2 of the algebra can be written as $b_2(A, B) = AB$. The b_3 product is the first of an infinite series of ‘homotopies’ (b_3, b_4, b_5, \dots). It is written as $b_3(A, B, C) = (A, B, C) \in V$. The three identities above then give, when acting on states:

$$\begin{aligned} 0 &= Q^2 A, \\ 0 &= Q(AB) + (QA)B + (-1)^{d_A} A(QB), \\ 0 &= Q(A, B, C) + (AB)C + (-1)^{d_A} A(BC), \\ &+ (QA, B, C) + (-1)^{d_A} (A, QB, C) + (-1)^{d_A+d_B} (A, B, QC). \end{aligned} \quad (6.12)$$

The first identity is the nilpotency of the BRST operator. The second identity states that Q is an odd derivation of the product. The third identity shows that strict associativity of the product, that is, having $(AB)C = -(-1)^{d_A} A(BC)$ is not required. Here, associativity holds ‘up to homotopy,’ that is, up to terms involving the homotopy b_3 and the BRST operator. In the general framework of classical open string field theory we do not require strict associativity and we have nontrivial products $b_{n \geq 3}$.

Of course, if we have an associative product b_2 all the higher homotopies vanish, and the algebraic structure of the string field theory is simpler, with Q and b_2 being the only ingredients. This is the case for the cubic classical open string field theory formulated by Witten [5].

We shall now introduce a bilinear inner product on the vector space of the algebra. This is a structure that, given two elements of V , gives us a complex number. We thus have a bilinear inner product $V \otimes V \rightarrow \mathbb{C}$ written as $(A, B) \in \mathbb{C}$, for $A, B \in V$. This structure is required to have the following exchange property

$$(A, B) = -(-1)^{d_A d_B} (B, A). \quad (6.13)$$

The bilinear form is *symplectic* in that it is antisymmetric when both vectors are of even degree. It is only symmetric when both vectors are of odd degree. The BRST operator Q satisfies the folding over property

$$(QA, B) = -(-1)^{d_A} (A, QB). \quad (6.14)$$

The inner product implements the cyclicity property of the products. Intuitively, cyclicity is the natural result of open string vertex operators being located on the boundary of a disk. In such situation the ordering of the operators along the boundary matters, but cyclicity reflects the absence of a special ‘first’ operator on the boundary. The axioms require that the bilinear form and the products satisfy

$$(A_1, b_n(A_2, \dots, A_{n+1})) = (-1)^\# (A_2, b_n(A_3, \dots, A_{n+1}, A_1)), \quad (6.15)$$

with $\#$ the sign factor necessary to rearrange the states into the final ordering. Since b_n is odd and degree operates like Grassmanality, we have

$$\# = d_{A_2} + d_{A_1} (1 + d_{A_2} + d_{A_3} + \dots + d_{A_{n+1}}). \quad (6.16)$$

An A_∞ algebra equipped with an inner product satisfying the properties above is called a *cyclic A_∞ algebra*. This concludes the presentation of the algebraic structure and its axioms.

For the application to open string field theory we now note that the general version of this theory requires a Grassmann algebra \mathcal{G} because the target-space theory contains anticommuting fields, such as ghosts. For classical bosonic open string field theory, complex numbers suffice, since the spacetime fields are valued on the complex numbers. As explained at the beginning of section 4, the space V that for open strings would naturally be the vector space \mathcal{H}_o of the BCFT, must be upgraded to a \mathcal{G} module in the quantum theory, which with a bit of abuse of notation we still denote by \mathcal{H}_o . The degree of an element is now the sum of the degrees of the BCFT basis vector and the degree of the associated target space field, given by its Grassmanality. The string field products thus have inputs that are each elements of the module \mathcal{H}_o , and an output that is also an element of the module \mathcal{H}_o . The inner product is then a map from the tensor product of the modules to the Grassmann algebra: $\mathcal{H}_o \otimes \mathcal{H}_o \rightarrow \mathcal{G}$.

The open string field Φ contains Grassmann odd open string vertex operators multiplied by even target space fields, and Grassmann even vertex operators times odd target space fields – thus a Grassmann odd object overall. In this A_∞ picture, however, this string field must be viewed as an even degree object in the algebra: $d_\Phi = 0 \pmod{2}$. The classical master action $S(\Phi)$ for the string field is simply a sum over the various products of the A_∞ algebra. We claim that

$$S(\Phi) = \sum_{n=1}^{\infty} \frac{1}{n+1} (\Phi, b_n(\Phi, \dots, \Phi)), \quad (6.17)$$

is the master action and satisfies the classical master equation. We will show this in the next section by relating the above action to the previously obtained, consistent action (4.43).

One surprising feature of the results given in this subsection is the apparent mismatch between the Grassmannality of a vertex operators and its degree which is taken to be even (odd) for vertex operators carrying odd (even) ghost number. This is visible for example in (6.12) where every time we move Q through an element A of the algebra, we pick a factor of $(-1)^{d_A}$, which is 1 for odd ghost number operators and -1 for even ghost number operators. This can be contrasted with (4.46) where every time we move Q through a Grassmann odd vertex operator inside the product $[\dots]$, we pick up a minus sign. Let us first note that the rules of moving Grassmann odd elements through the vertex operators inside a product could differ if we changed the definition of the product. In (4.46) we were implicitly assuming that the product $[\dots]$ followed the prescription given in section 3.5: inside the correlators we arrange all the vertex operators first, followed by \mathcal{B} and boundary state insertions to the right. However we could have arranged the vertex operators interspersed with \mathcal{B} insertions, in which case every time we move Q from one Grassmann odd vertex operator to the next one, Q also passes through a \mathcal{B} and as a result we do not pick up any sign. A description that could lead to the rules (6.12) is provided by regarding the products $b_n(A_1, \dots, A_n)$ as the result of contraction of a surface state with the ket states $|A_1\rangle, \dots, |A_n\rangle$. As discussed at the beginning of section 4.4, the ket state $|A\rangle$ has opposite Grassmannality to that of the vertex operator A and hence an odd vertex operator will naturally lead to even ket states. In section 6.2 we shall give the explicit relation between the product $[A_1, \dots, A_n]$ introduced in section 4.4 and the product $b_n(A_1, \dots, A_n)$ introduced here for all n .

6.2 Relation between different classical open SFT formalisms

In this section we shall discuss the relation between the various quantities defined in section 4.4 and those introduced in section 6.1. Both deal with classical open string theory.

We begin with the definition of the bilinear inner product. We had the BPZ product $\langle \cdot, \cdot \rangle$ used in section 4.4, and the inner product (\cdot, \cdot) used in the algebraic analysis of section 6.1. These two, we claim, are related as follows:

$$(A, B) = (-1)^{A+1} \langle A, B \rangle'. \quad (6.18)$$

Here A in the exponent is the (mod 2) ghost number of A , which coincides with the Grassmannality of A (A is a vertex operator or a string field vertex operator). To relate this to the degree of A that appeared in section 6.1, we shall make the identification¹⁵

$$A = d_A + 1 \pmod{2}. \quad (6.19)$$

Note that we are assigning opposite Grassmannality to A than what was assigned in the previous subsection. As a consistency check, the exchange property (6.13) for (\cdot, \cdot) follows immediately from the exchange property of the BPZ inner product

$$\langle B, A \rangle' = (-1)^{AB} \langle A, B \rangle', \quad (6.20)$$

the relation between the inner products, and the above Grassmannality/degree relation. Indeed,

$$(B, A) = (-1)^{B+1} \langle B, A \rangle' = (-1)^{AB+B+1} \langle A, B \rangle' = (-1)^{AB+A+B} (A, B) = (-1)^{d_A d_B + 1} (A, B). \quad (6.21)$$

¹⁵In the mathematical literature this kind of relation is called a ‘suspension’. It relates descriptions of the theory in which the effective Grassmannality of all elements is altered.

Next we relate the star product \star to the A_∞ product b_2 . We have

$$A \star B = (-1)^{A+1} b_2(A, B) = (-1)^{A+1} (AB), \quad (6.22)$$

using the definition $(AB) = b_2(A, B)$. This gives, using the second relation in (6.12),

$$Q(A \star B) = (-1)^{A+1} Q(AB) = (-1)^A ((QA)B) - (A(QB)) = (QA) \star B + (-1)^A A \star QB. \quad (6.23)$$

More generally, we relate the product $[A_1 \cdots A_n]$ to $b_n(A_1, \cdots, A_n)$ via:

$$[A_1 \cdots A_n] = (-1)^{n(n+1)/2} \sum_{\sigma} (-1)^{s_{\sigma}} (-1)^{A_{\sigma(1)} + 2A_{\sigma(2)} + \cdots + nA_{\sigma(n)}} b_n(A_{\sigma(1)}, A_{\sigma(2)}, \cdots, A_{\sigma(n)}). \quad (6.24)$$

Here σ is a permutation of $1, \cdots, n$ and $(-1)^{s(\sigma)}$ is the sign factor that we pick up when we rearrange the order of the A_i 's with the rule $A_i A_j = (-1)^{A_i A_j + 1} A_j A_i$.¹⁶ Using the A_∞ relations (6.9) we can now easily verify the main identity (4.46) for the $[\cdots]$ products, for the case of Grassmann odd (i.e. even degree) A_i 's. For the case $n = 2$ the above identity leads to

$$[A_1, A_2] = A_1 \star A_2 - (-1)^{A_1 A_2} A_2 \star A_1. \quad (6.25)$$

Note that we could drop the $(-1)^{n(n+1)/2}$ factor in (6.24) while replacing $A_{\sigma(i)}$ by $d_{A_{\sigma(i)}} = A_{\sigma(i)} + 1$. It also follows from (6.24) that when all the A_i 's are Grassmann odd, i.e. of even degree, we get

$$[A_1 \cdots A_n] = \sum_{\sigma} b_n(A_{\sigma(1)}, A_{\sigma(2)}, \cdots, A_{\sigma(n)}). \quad (6.26)$$

Note that the $(-1)^{s_{\sigma}}$ factor disappears since for odd A_i 's we have $A_i A_j = A_j A_i$ inside $[\]$.

Equation (6.24) provides an implicit definition of $b_n(A_1, \cdots, A_n)$ in terms of world-sheet correlation functions. For this note that we have already defined $[A_1 \cdots A_n]$ in terms of the world-sheet correlation functions in section 4.4. There we summed over all cyclic permutations of the vertex operators to define $\{A_0 \cdots A_n\}$ and then used it to define $[A_1 \cdots A_n]$ via (4.47). To define $b_n(A_1, \cdots, A_n)$, we proceed as follows:

- Define $\{A_0 A_1 \cdots A_n\}^C$ to be that part of $\{A_0 A_1 \cdots A_n\}$ where the vertex operators are arranged in the cyclic order $0, 1, \cdots, n$.
- Define $[A_1 \cdots A_n]^C$ via $\langle A_0, [A_1, \cdots, A_n]^C \rangle' = \{A_0, A_1, \cdots, A_n\}^C$.
- Use (6.24) with $[A_1 \cdots A_n]$ replaced by $[A_1 \cdots A_n]^C$ on the left hand side, and pick only the identity permutation in the sum over σ on the right hand side.

We now argue for the consistency of the A_∞ master action (6.17). It follows immediately from the relation between inner products (6.18) and the relation between products (6.26) that the A_∞ action coincides with the action (4.43). Furthermore, since the main identity (4.46) follows as a consequence of the A_∞ algebra, it is clear that the rest of the results discussed in section 4.4 follow. In particular, the action satisfies the classical BV master equation.

¹⁶This rule can be derived by examining the left hand side, defined in (4.47), whose symmetry follows on account of (4.45).

6.3 L_∞ algebras and classical closed string field theory

We now turn to a discussion of the algebraic structure behind classical closed string field theory. While for open strings the relevant algebraic structures arise from homotopy associative algebras, for closed strings the relevant structures are homotopy Lie algebras. For classical closed string field theory we have an L_∞ algebra. The L_∞ algebra contains an infinite number of products, all of which are graded symmetric.

To work in generality we assume we have a graded vector space W with elements with a natural \mathbb{Z} grading. We write $B_1, B_2, \dots \in W$ for elements of fixed degree. We denote the degree of B by d_B . The products are viewed as brackets, such as the Lie algebra bracket with two entries. In the situation used for the conventional formulation of string field theory, there are products with one input, two inputs, and all numbers of higher inputs:¹⁷

$$b_1(B_1), \quad b_2(B_1, B_2), \quad b_3(B_1, B_2, B_3), \quad \dots, \quad (6.27)$$

etc. Unlike the case of open string field theory, here the relation to the structures introduced in section 4.1 is more straightforward:

$$b_1(B_1) = QB_1, \quad b_1(B_1, B_2) = [B_1, B_2]_0, \quad b_3(B_1, B_2, B_3) = [B_1, B_2, B_3]_0, \quad \dots, \quad (6.28)$$

where Q is a linear operator in W , to be later identified as the BRST operator of the CFT. The subscript 0 on the brackets $[]$ indicates that these will be identified with the genus zero products defined in section 4.1. The products b_n are graded commutative. When exchanging any two inputs in a product, we just get a sign factor corresponding to the exchange of the two objects according to their degree

$$b_n(B_1, \dots, B_k, B_{k+1}, \dots, B_n) = (-1)^{d_{B_k} d_{B_{k+1}}} b_n(B_1, \dots, B_{k+1}, B_k, \dots, B_n). \quad (6.29)$$

The products are defined to be of intrinsic degree minus one, so that

$$\deg(b(B_1, \dots, B_n)) = -1 + \sum_{i=1}^n d_{B_i}, \quad (6.30)$$

in accordance with the comment below (4.13).

In analogy to what we did for the A_∞ algebra, we construct a larger space by adding symmetrized products of the vector space W :

$$T(W) = \sum_{n=1}^{\infty} SW^{\otimes n}. \quad (6.31)$$

The summands in this expression are spaces $SW^{\otimes n}$, with S for symmetrized; their elements are written as

$$B_1 \wedge B_2 \wedge \dots \wedge B_n, \quad (6.32)$$

where the ‘wedge’ simply means that the order of the B ’s can be interchanged with sign factors according to their statistics, just as in the products above. Thus, for example, $B_1 \wedge B_2 = (-1)^{d_{B_1} d_{B_2}} B_2 \wedge B_1$. For a general permutation $\sigma = \{\sigma(1), \dots, \sigma(n)\}$ of the integers $\{1, \dots, n\}$, we define

$$B_1 \wedge \dots \wedge B_n = \epsilon(\sigma; B) B_{\sigma(1)} \wedge \dots \wedge B_{\sigma(n)}, \quad (6.33)$$

¹⁷A product b_0 with no input is just a special state in W . If b_0 is included in the set of products, we have a ‘curved’ L_∞ algebra that can play a role in the formulation of string field theory around backgrounds where the classical theory has terms linear in the field [6, 100].

where $\epsilon(\sigma; B)$ is the so called Koszul sign factor, clearly dependent on the permutation σ and the degree of the B entries.

In order to state the main identity satisfied by the product it is convenient to define the *splitting* of the set of integers $\{1, \dots, n\}$ into a first group $\{i_1, \dots, i_l\}$ of integers and a second group $\{j_1, \dots, j_k\}$ of integers, clearly with $l + k = n$. We ask that $l \geq 1$ but $k \geq 0$. A splitting has a sign factor $\epsilon(\sigma)$, where the permutation is that which turns the ordered set into $\{i_1, \dots, i_l, j_1, \dots, j_k\}$. Two splittings are said to be *equivalent* if their first groups contain the same integers, regardless of their order.

We are now able to write the identities satisfied by the products. For this we define an odd coderivation \mathbf{b} acting on $T(W)$ as follows:¹⁸

$$\mathbf{b}(B_1 \wedge \dots \wedge B_n) = \sum_{l=1}^n \sum_{\sigma'} \epsilon(\sigma', B) (b_l(B_{i_1}, \dots, B_{i_l}) \wedge B_{j_1} \wedge \dots \wedge B_{j_{n-l}}), \quad (6.34)$$

where the sum over σ' denotes the sum over all *inequivalent* splittings of $\{1, \dots, n\}$ into a group with l integers and a group with $n - l$ integers (the prime is to remind the reader that this is a restricted sum). Note that a product is used to collapse the first set of states in the splitting into a single state. Thus, for example, we have

$$\mathbf{b}(B_1) = b_1(B_1), \quad (6.35)$$

since the only allowed splitting of $\{1\}$ is into the sets $\{1\}, \{\emptyset\}$. For the case of two inputs, we first note that there are three splittings of $\{1, 2\}$: into $\{1\}, \{2\}$, into $\{2\}, \{1\}$, and into $\{1, 2\}, \{\emptyset\}$. We therefore have, including the signs,

$$\begin{aligned} \mathbf{b}(B_1 \wedge B_2) &= b_1(B_1) \wedge B_2 + (-1)^{d_{B_1} d_{B_2}} b_1(B_2) \wedge B_1 + b_1(B_1, B_2) \\ &= b_1(B_1) \wedge B_2 + (-1)^{d_{B_1}} B_1 \wedge b_1(B_2) + b_1(B_1, B_2). \end{aligned} \quad (6.36)$$

The identity satisfied by the products is simply the condition that the operator \mathbf{b} squares to zero

$$\mathbf{b}^2 = 0. \quad (6.37)$$

This can be shown to be equivalent to the nilpotence of the BRST operator Q and the main identities (4.17) with the last term set to zero. We shall illustrate this with some examples.

For the action on B_1 , as in (6.35), we find the expected condition of nilpotency of Q :

$$\mathbf{b}^2(B_1) = \mathbf{b} \mathbf{b}(B_1) = \mathbf{b}(QB_1) = Q(QB_1) = 0. \quad (6.38)$$

Acting on $B_1 \wedge B_2$ and using (6.36) we find

$$\mathbf{b}^2(B_1 \wedge B_2) = \mathbf{b}(QB_1 \wedge B_2) + (-1)^{d_{B_1}} \mathbf{b}(B_1 \wedge QB_2) + \mathbf{b}(b_2(B_1, B_2)) = 0. \quad (6.39)$$

Expanding by using (6.36) for the first two terms, (6.35) for the last, and $Q^2 = 0$, we get

$$\begin{aligned} \mathbf{b}^2(B_1 \wedge B_2) &= \left((-1)^{d_{B_1}+1} QB_1 \wedge QB_2 + b_2(QB_1, B_2) \right) \\ &\quad + (-1)^{d_{B_1}} \left(QB_1 \wedge QB_2 + b_2(B_1, QB_2) \right) + Q b_2(B_1, B_2) = 0. \end{aligned} \quad (6.40)$$

The two terms in $SW^{\otimes 2}$ cancel out and give no new condition. The nontrivial condition arises from the part in W on the above right-hand side:

$$Q b_2(B_1, B_2) + b_2(QB_1, B_2) + (-1)^{d_{B_1}} b_2(B_1, QB_2) = 0. \quad (6.41)$$

¹⁸The definition here is given in a form slightly different from the original one in [6] but it is exactly equivalent to it, including all signs.

This is in agreement with (4.17) for $N = 2$. This condition states that Q is a (graded) derivation of the two-product.

Next we turn to the identity that arises from $\mathbf{b}^2(B_1 \wedge B_2 \wedge B_3) = 0$. One gets, from the vanishing of the part in W , the condition

$$\begin{aligned} 0 = & Q b_3(B_1, B_2, B_3) + b_3(QB_1, B_2, B_3) + (-1)^{d_{B_1}} b_3(B_1, QB_2, B_3) + (-1)^{d_{B_1} + d_{B_2}} b_3(B_1, B_2, QB_3) \\ & + b_2(b_2(B_1, B_2), B_3) + (-1)^{d_{B_2} d_{B_3}} b_2(b_2(B_1, B_3), B_2) + (-1)^{d_{B_1} (d_{B_2} + d_{B_3})} b_2(b_2(B_2, B_3), B_1). \end{aligned} \quad (6.42)$$

This is in agreement with (4.17) for $N = 3$. Note the three terms on the last line. If these were set to zero, we would have a graded version of the Jacobi identity for the two-product $b_2(B_1, B_2)$. But in L_∞ , this two-product is not a strict Lie bracket, and therefore it does not satisfy a Jacobi identity. In the L_∞ algebra, the ‘Jacobiator’, namely the sum of those three terms in question, is set equal to the failure of the higher product $b_3(B_1, B_2, B_3)$ to be a derivation of Q .

In general, the action of the second \mathbf{b} in $\mathbf{b}^2(B_1 \wedge \dots \wedge B_n)$ only gives a new identity on account of the vanishing of the terms in W . Thus, making use of (6.34), the general conditions on the products arise by replacing the parenthesis by a bracket:

$$0 = \sum_{l=1}^n \sum_{\sigma'} \epsilon(\sigma', B) b_{n-l+1}(b_l(B_{i_1}, \dots, B_{i_l}), B_{j_1}, \dots, B_{j_{n-l}}). \quad (6.43)$$

Since we have recovered the identity (4.17), with the last term discarded and all products at genus zero, the construction of the classical master action and the proof that it satisfies the BV master equation proceeds as in section 4.1.

Finally, as in the case of A_∞ algebra, we can introduce a bilinear inner product that, given two elements B_1, B_2 of the algebra, gives us an element $(B_1, B_2) \in \mathbb{C}$, obeying the symmetry:

$$(B_1, B_2) = (-1)^{(d_{B_1} + 1)(d_{B_2} + 1)} (B_2, B_1), \quad (6.44)$$

and the folding over property

$$(QB_1, B_2) = (-1)^{d_{B_1}} (B_1, QB_2). \quad (6.45)$$

Furthermore, using the inner product to define multilinear maps to the complex numbers:

$$\{B_1, \dots, B_n\}_{L_\infty} \equiv (B_1, b_{n-1}(B_2, \dots, B_n)), \quad (6.46)$$

we also demand the graded commutativity property:

$$\{B_1, \dots, B_k, B_{k+1}, \dots, B_n\}_{L_\infty} = (-1)^{d_{B_k} d_{B_{k+1}}} \{B_1, \dots, B_{k+1}, B_k, \dots, B_n\}_{L_\infty}. \quad (6.47)$$

For the application to closed string field theory a few remarks are useful. The natural choice for W is the CFT vector space \mathcal{H}_c upgraded to a \mathcal{G} module (still denoted by \mathcal{H}_c) to account for Grassmann even and odd target space fields. As we mentioned before, Q is the BRST operator in \mathcal{H}_c and the products are the genus zero brackets. The inner product (\cdot, \cdot) , taking $\mathcal{H}_c \otimes \mathcal{H}_c \rightarrow \mathcal{G}$ in fact coincides with $\langle \cdot, \cdot \rangle$, defined in (3.15). For closed strings, L_∞ degree and Grassmannality coincide: the full string field Ψ is of even degree, and as a vertex operator multiplied by a target space field it is uniformly Grassmann even. In terms of these quantities the action S satisfying the classical BV master equation can be written as

$$S = \frac{1}{2} (\Psi, Q \Psi) + \sum_{n=3}^{\infty} \frac{1}{n!} \{\Psi^n\}_{L_\infty}, \quad (6.48)$$

where the string field Ψ is an even degree element of the L_∞ algebra.

6.4 From A_∞ to L_∞

In section 4.4 the classical open string field theory was written in terms of products $[\dots]$, which, as we saw in section 6.2, can be also expressed in terms of the A_∞ products. We shall now explain how the action can also be written in terms of L_∞ products that are defined in terms of the A_∞ products.

Let us call b_n the A_∞ products and \bar{b}_n the L_∞ products to be constructed from them. The vector space of states is the same, with elements denoted A_1, A_2, \dots . We have that the first product needs no change:

$$\bar{b}_1(A_1) \equiv b_1(A_1). \quad (6.49)$$

Clearly $\bar{b}_1 \bar{b}_1(A_1) = b_1 b_1(A_1) = 0$, as required. For the second product we take

$$\bar{b}_2(A_1, A_2) \equiv b_2(A_1, A_2) + (-1)^{d_{A_1} d_{A_2}} b_2(A_2, A_1). \quad (6.50)$$

This satisfies the required exchange symmetry $\bar{b}_2(A_1, A_2) = (-1)^{d_{A_1} d_{A_2}} \bar{b}_2(A_2, A_1)$ by construction. A short computation confirms that the desired L_∞ property (see (6.41))

$$\bar{b}_1 \bar{b}_2(A_1, A_2) + \bar{b}_2(\bar{b}_1(A_1), A_2) + (-1)^{d_{A_1}} \bar{b}_2(A_1, \bar{b}_1(A_2)) = 0, \quad (6.51)$$

holds because the exactly same equation holds for b_2 and b_1 (see the second equation in (6.12)). If the A_∞ algebra is in fact associative, there is no b_3 , and we have

$$b_2(b_2(A_1, A_2), A_3) + (-1)^{d_{A_1}} b_2(A_1, b_2(A_2, A_3)) = 0, \quad (6.52)$$

see the third equation in (6.12). This property in fact guarantees the identity

$$\bar{b}_2(\bar{b}_2(A_1, A_2), A_3) + (-1)^{d_{A_2} d_{A_3}} \bar{b}_2(\bar{b}_2(A_1, A_3), A_2) + (-1)^{d_{A_1} (d_{A_2} + d_{A_3})} \bar{b}_2(\bar{b}_2(A_2, A_3), A_1) = 0, \quad (6.53)$$

that must hold for the L_∞ algebra to be a Lie algebra without higher products (see (6.42)).

More generally, if the A_∞ algebra has higher products, the higher products of the L_∞ algebra are obtained as follows:

$$\bar{b}_n(A_1, \dots, A_n) \equiv \sum_{\sigma} \epsilon(\sigma, A) b_n(A_{\sigma(1)}, \dots, A_{\sigma(n)}). \quad (6.54)$$

Here we simply sum over the complete set of permutations of the n inputs, with the Koszul sign computed with the rule $A_i A_j = (-1)^{d_{A_i} d_{A_j}} A_j A_i$. This definition implies that the product \bar{b}_n is graded commutative, as required. We will not present here a proof that the higher L_∞ identities for the \bar{b} products are satisfied on account of the full set of identities for the A_∞ products. Note also that since the open string field has even degree, $\bar{b}_n(\psi_o, \dots, \psi_o) = n! b_n(\psi_o, \dots, \psi_o)$.

Using (6.24) and (6.54) we can find the relation between the L_∞ products \bar{b}_n and the products $[\dots]$ for the open string fields constructed in (6.24). This takes the form

$$[A_1 \dots A_n] = (-1)^{d_{A_1} + 2d_{A_2} + \dots + nd_{A_n}} \bar{b}_n(A_1, \dots, A_n). \quad (6.55)$$

We can also relate the inner products in the L_∞ and A_∞ algebra as follows. Let $\langle \cdot, \cdot \rangle$ denote the inner product in the L_∞ algebra, as introduced at the end of section 6.3. We equate this to the BPZ inner product in the state space and not the inner product (\cdot, \cdot) of the A_∞ algebra, – the two being related by (6.18). Thus we have

$$\langle A_1, A_2 \rangle = \langle A_1, A_2 \rangle' = (-1)^{d_{A_1}} (A_1, A_2). \quad (6.56)$$

The symmetry property (6.44) and (6.45) follow as consequences of (6.13) and (6.14). Equation (6.56) gives, from (6.46),

$$\begin{aligned} \{A_0 A_1 \cdots A_n\}_{L_\infty} &= \langle A_0, \bar{b}_n(A_1 A_2 \cdots A_n) \rangle = (-1)^{d_{A_0}} (A_0, \bar{b}_n(A_1 A_2 \cdots A_n)) \\ &= (-1)^{d_{A_0}} \sum_{\sigma} \epsilon(\sigma, A) (A_0, b_n(A_{\sigma(1)}, \cdots, A_{\sigma(n)})). \end{aligned} \quad (6.57)$$

With some work one can show that the symmetry property (6.47) of the left hand side follows from the symmetry properties (6.15), (6.16).

Since the open string field ψ_o has even degree d_{ψ_o} , we can express the action (6.17) as

$$S(\psi_o) = \sum_{n=1}^{\infty} \frac{1}{n+1} (\psi_o, b_n(\psi_o^n)) = \frac{1}{2} \langle \psi_o, Q\psi_o \rangle + \sum_{n=2}^{\infty} \frac{1}{(n+1)!} \{\psi_o^{n+1}\}_{L_\infty}. \quad (6.58)$$

This agrees structurally with the L_∞ action (6.48) of closed strings.

Equation (6.55) can be given the following interpretation. When all the A_i 's are Grassmann odd (i.e. of even degree) we have

$$[A_1 \cdots A_n] = \bar{b}_n(A_1, \cdots, A_n). \quad (6.59)$$

If some of the A_i 's are Grassmann even (odd degree) then we multiply them by Grassmann odd c -numbers *from the left* and apply (6.59). We can then move all the Grassmann odd c -numbers to the left by picking up a minus sign every time the Grassmann odd c -number passes a Grassmann odd A_i inside $[A_1 \cdots A_n]$ and picking up a minus sign every time the Grassmann odd c -number passes an odd degree A_i inside $\bar{b}_n(A_1, \cdots, A_n)$. It can be easily checked that this prescription leads to (6.55). Thus inside the argument of \bar{b}_n the effective Grassmannality of A_i , defined as whether or not a Grassmann odd c -number passing through A_i generates a minus sign, becomes identical to the degree.

6.5 Quantum L_∞ algebra

Classical closed string field theory must be supplemented by additional terms in order to define the full quantum closed string field theory. The Feynman rules of the classical theory do not produce covers of the higher genus moduli spaces. This happens because the classical master action does not solve the quantum master equation. In order to produce an action that solves the quantum master equation one needs higher genus string products. In the language of L_∞ algebra, the products $b_n(A_1, \cdots, A_n) \in W$ now include contributions from all genus, in general. We now write

$$b_n(B_1, \cdots, B_n) = \sum_{g=0}^{\infty} g_s^{2g+n-1} b_n^g(B_1, \cdots, B_n), \quad n = 0, 1, \cdots, \quad (6.60)$$

where with a little abuse of notation the b_n 's now denote the products with all genus contributions, and the genus zero b_n 's of the original L_∞ algebra are now written as b_n^0 . A few things should be noted. We now have a product $b_0(\)$ without an input, that maps nothing to W . It receives contributions from b_0^g products with $g \geq 1$ ($b_0^0(\) = 0$). In closed string field theory, the inner product of $b_0^g(\)$ with a state $B \in \mathcal{H}_c$ is related to the one-point function of B on genus g Riemann surfaces. Furthermore, the product $b_1(A_1)$ is QA_1 at genus zero, but gets additional contribution from two-point functions on Riemann surfaces of genus $g \geq 1$.

The identity that must be satisfied by the complete set of products is a generalization of (6.43), and it takes the form

$$0 = \sum_{l=1}^n \sum_{\sigma'} \epsilon(\sigma', B) b_{n-l+1}(b_l(B_{i_1}, \dots, B_{i_l}), B_{j_1}, \dots, B_{j_{n-l}}) + \frac{1}{2} b_{n+2}(B_1, \dots, B_n, \varphi_s, \varphi_r) (\varphi_s^c, \varphi_r^c). \quad (6.61)$$

This identity is equivalent to (4.17). It is the identity defining the quantum L_∞ algebra. The term in the second line is of purely quantum origin and was not present in (6.43). Of course, even the first term is different, as it now includes the higher-genus contributions.

The abstract L_∞ algebra introduced in section 6.3 is thus modified to the quantum L_∞ algebra. The main new ingredients are the following.

1. We define \mathbf{b} as in (6.34) with the sum over l starting at 0, and b_i 's now including higher genus contributions satisfying the identity (6.61).
2. We also introduce an operator $\boldsymbol{\theta}$ from $T(W) \rightarrow T(W)$ such that

$$\boldsymbol{\theta}(A_1 \wedge \dots \wedge A_n) = \frac{1}{2} A_1 \wedge \dots \wedge A_n \wedge \varphi_r \wedge \varphi_s (\varphi_r^c, \varphi_s^c). \quad (6.62)$$

The quantum L_∞ algebra identity (6.61) follows from the vanishing of the following operator acting on $T(W)$

$$\boldsymbol{\pi}_1(\mathbf{b}^2 + \mathbf{b}\boldsymbol{\theta}) = 0, \quad (6.63)$$

where $\boldsymbol{\pi}_1$ is the projection from $T(W)$ to W . It is shown by Markl [101] that this condition is equivalent to the conceptually clearer condition

$$(\mathbf{b} + \boldsymbol{\theta})^2 = 0. \quad (6.64)$$

6.6 Open-closed string field theory

In section 4.5 we described a formulation of open-closed string field theory where the open and closed strings appear on similar footing except for some signs, see *e.g.* the $(-1)^{j-1}$ factor in the second line of (4.67). The difference in sign arises because the closed string fields are even while open string fields are odd. However we have seen in section 6.4 that it is possible to reformulate classical open string field theory using the products $\bar{b}_n(A_1, \dots, A_n)$ that satisfy the same L_∞ algebra as classical closed strings. This suggests that a similar change in sign can be used to rewrite the open-closed string field theory in terms of a regular quantum L_∞ algebra without any extra sign. To this end, we define L_∞ -type multilinear functions from the open-closed functions:

$$\{A_1^c, \dots, A_{n_c}^c; A_1^o, \dots, A_{n_o}^o\}_{L_\infty} \equiv (-1)^{d_{A_2^c} + 2d_{A_3^c} + \dots + (n-1)d_{A_n^o}} \{A_1^c, \dots, A_{n_c}^c; A_1^o, \dots, A_{n_o}^o\}, \quad (6.65)$$

with $\{A_1^c, \dots, A_{n_c}^c; A_1^o, \dots, A_{n_o}^o\}$ as defined in (4.61). When restricted to classical open string field theory, this expression reduces to $\{A_1^o, \dots, A_n^o\}_{L_\infty}$ via (6.55)-(6.57). Then the open-closed string field theory action defined in terms of $\{\dots\}_{L_\infty}$ will have the same form as (4.69) since for Grassmann odd open string states there is no difference between $\{\dots\}_{L_\infty}$ and $\{\dots\}$. In terms of the new L_∞ multilinear functions, however, the $(-1)^{j-1}$ factor for open strings will be absent in (4.67) and we can treat open and closed strings on equivalent footing.

The open-closed system is a novel and fascinating structure in terms of homotopy algebras. Much of the novelty is present for the bosonic string case. As Kajiura and Stasheff discuss [102, 103] there are various ways of thinking of the algebraic structure of the open-closed string theory. One can view it as a deformation of the A_∞ structure on the open string state space controlled by the L_∞ algebra on the closed string state space. Physicists note that indeed open-closed string field theory shows how to write classical open string field theories on general closed string backgrounds. Mathematically, one can focus on the L_∞ algebra acting on the open string state space as a graded vector space. This is the homotopy version of a Lie algebra L acting on a vector space M , where M is viewed as a representation of L . There has been renewed work in formulating the open-closed string field theory in the language of coderivations, finding interesting limits, and the implications for constant terms in the action [104–106].

6.7 Homotopy transfer

We considered the Wilsonian effective action in section 5.4. The main takeaway was that starting from a consistent string field theory one could obtain, via a suitable projection of the string field, a subset of fields for which there is a consistent effective field theory. In algebraic terms, and focusing here only on the classical theories, we have the original string field theory with an A_∞ or L_∞ algebra. The procedure to be discussed below, going under the name of *homotopy transfer*, builds an A_∞ or L_∞ algebra on the subset of fields [70, 71, 102, 103, 107]. These algebras thus define the effective field theory of that subset of fields. The construction clarifies the general conditions that must be satisfied in the selection of the projector down to a subset of fields. It also provides explicit formulae for the terms in the effective action.

Homotopy transfer for A_∞ . Consider classical open strings formulated in the framework of A_∞ algebras. The A_∞ algebras will be described by coderivations on the tensor algebra $T(V)$ as we discussed in section 6.1. A slight change of notation is helpful here. We wrote before $\mathbf{b} = \mathbf{b}_1 + \mathbf{b}_2 + \mathbf{b}_3 + \dots$. We will set $\mathbf{M} = \mathbf{b}$, write $\mathbf{Q} = \mathbf{b}_1$, as this is the BRST operator, and define $\mathbf{m} = \mathbf{b}_2 + \mathbf{b}_3 + \dots$. All in all, we have the degree one operator

$$\mathbf{M} = \mathbf{Q} + \mathbf{m}, \quad \mathbf{m} = \sum_{n=2}^{\infty} \mathbf{b}_n. \quad (6.66)$$

The main identity satisfied by the products is $\mathbf{M}^2 = 0$ which implies,

$$\mathbf{Q}^2 = 0, \quad \text{and} \quad \mathbf{Q}\mathbf{m} + \mathbf{m}\mathbf{Q} + \mathbf{m}^2 = 0. \quad (6.67)$$

We now follow the discussion of [72]. We introduce a projector P from V to a subspace \bar{V} , this is the subspace of degrees of freedom we want to write an effective field theory for,

$$P : V \rightarrow \bar{V}, \quad P^2 = P. \quad (6.68)$$

The A_∞ inner product must be consistent with the projector:

$$(A_1, PA_2) = (PA_1, A_2). \quad (6.69)$$

We also demand that P and Q commute

$$QP = PQ. \quad (6.70)$$

We extend this projector to a degree zero operator $\mathbf{P} : T(V) \rightarrow T(\bar{V})$ by defining the action

$$\mathbf{P}(A_1 \otimes A_2 \otimes \cdots \otimes A_n) \equiv PA_1 \otimes PA_2 \otimes \cdots \otimes PA_n, \quad (6.71)$$

so that

$$\mathbf{P}^2 = \mathbf{P}, \quad (6.72)$$

and

$$\mathbf{Q}\mathbf{P} = \mathbf{P}\mathbf{Q}. \quad (6.73)$$

Associated to the projector we can introduce a linear operator h of degree 1 (thus odd) in V satisfying the conditions:

$$hP = Ph = 0, \quad h^2 = 0, \quad Qh + hQ = 1 - P. \quad (6.74)$$

If P projects on to a subspace containing all the $L_0 = 0$ states, for example, then we can take $h = \frac{b_0}{L_0}(1 - P)$.

The next definition tells us how h is promoted to an operator \mathbf{h} acting on $T(V)$. In fact, \mathbf{h} maps $V^{\otimes n}$ to itself as follows:

$$\begin{aligned} h(A_1 \otimes A_2 \otimes \cdots \otimes A_n) \equiv & (hA_1) \otimes PA_2 \otimes \cdots \otimes PA_n \\ & + (-1)^{d_{A_1}} A_1 \otimes hA_2 \otimes \cdots \otimes PA_n \\ & \vdots \qquad \qquad \qquad \vdots \\ & + (-1)^{d_{A_1} + d_{A_2} + \cdots + d_{A_{n-1}}} A_1 \otimes A_2 \otimes \cdots \otimes hA_n. \end{aligned} \quad (6.75)$$

The surprising fact of this definition is that projectors are only inserted to the right of the insertion of h . The sign factors simply indicate that h is odd. The definition is such that the properties (6.74) holding on V get upgraded to identities in $T(V)$:

$$\mathbf{h}\mathbf{P} = \mathbf{P}\mathbf{h} = 0, \quad \mathbf{h}^2 = 0, \quad \mathbf{Q}\mathbf{h} + \mathbf{h}\mathbf{Q} = \mathbf{1} - \mathbf{P}. \quad (6.76)$$

The first three equations are almost obvious, the last one takes more work. It is straightforward to see just by acting on $A_1 \otimes A_2$ that the unusual placement of projectors is needed for the last equation to work out.

We can now state that we have an A_∞ algebra on \bar{V} , although we will describe it as one in V in such a way that any action on the kernel of P is manifestly zero. The homotopy transfer result for A_∞ states that the operator $\bar{\mathbf{M}}$ defining the new products is given by [71, 72]

$$\bar{\mathbf{M}} = \mathbf{P}\mathbf{Q}\mathbf{P} + \mathbf{P}\mathbf{m} \frac{\mathbf{1}}{\mathbf{1} + \mathbf{h}\mathbf{m}} \mathbf{P}, \quad (6.77)$$

and satisfies $\bar{\mathbf{M}}^2 = 0$, as required to define an A_∞ algebra. Additionally, one must show that $\bar{\mathbf{M}}$ is a coderivation in the tensor coalgebra (see, for example [72], section 8.1.3). Finally, the new string products must be cyclic, just as the original ones. The \mathbf{P} to the right of each term on the right-hand side ensures that $\bar{\mathbf{M}}$ acts nontrivially only on $T(\bar{V})$. The \mathbf{P} to the left of each term shows that the range of $\bar{\mathbf{M}}$ is in $T(\bar{V})$. The fraction is defined by its power series expansion

$$\frac{\mathbf{1}}{\mathbf{1} + \mathbf{h}\mathbf{m}} = \mathbf{1} - \mathbf{h}\mathbf{m} + \mathbf{h}\mathbf{m}\mathbf{h}\mathbf{m} - \cdots. \quad (6.78)$$

Let us verify that $\overline{\mathbf{M}}^2 = 0$. The square of the first term vanishes: $\mathbf{P}\mathbf{Q}\mathbf{P}\mathbf{P}\mathbf{Q}\mathbf{P} = \mathbf{P}\mathbf{Q}\mathbf{P}\mathbf{Q}\mathbf{P} = \mathbf{P}\mathbf{Q}\mathbf{Q}\mathbf{P} = 0$ since \mathbf{Q} and \mathbf{P} commute. Given this we have

$$\overline{\mathbf{M}}^2 = \mathbf{P}\left\{\mathbf{Q}, \mathbf{m} \frac{1}{1 + \mathbf{h}\mathbf{m}}\right\}\mathbf{P} + \mathbf{P}\mathbf{m} \frac{1}{1 + \mathbf{h}\mathbf{m}} \mathbf{P}\mathbf{m} \frac{1}{1 + \mathbf{h}\mathbf{m}} \mathbf{P}. \quad (6.79)$$

With a little work the first term is seen to give

$$\begin{aligned} \mathbf{P}\left\{\mathbf{Q}, \mathbf{m} \frac{1}{1 + \mathbf{h}\mathbf{m}}\right\}\mathbf{P} &= \mathbf{P}\{\mathbf{Q}, \mathbf{m}\} \frac{1}{1 + \mathbf{h}\mathbf{m}} \mathbf{P} + \mathbf{P}\mathbf{m} \frac{1}{1 + \mathbf{h}\mathbf{m}} [\mathbf{Q}, 1 + \mathbf{h}\mathbf{m}] \frac{1}{1 + \mathbf{h}\mathbf{m}} \mathbf{P} \\ &= -\mathbf{P}\mathbf{m}^2 \frac{1}{1 + \mathbf{h}\mathbf{m}} \mathbf{P} + \mathbf{P}\mathbf{m} \frac{1}{1 + \mathbf{h}\mathbf{m}} ((1 - \mathbf{P})\mathbf{m} + \mathbf{h}\mathbf{m}^2) \frac{1}{1 + \mathbf{h}\mathbf{m}} \mathbf{P}. \end{aligned}$$

Substituting this back into (6.79) one finds that, indeed $\overline{\mathbf{M}}^2 = 0$.

It is instructive to expand the result (6.77) to write the new products $\overline{\mathbf{M}} = \overline{\mathbf{Q}} + \overline{\mathbf{m}}_2 + \overline{\mathbf{m}}_3 + \dots$. One finds:

$$\begin{aligned} \overline{\mathbf{Q}} &= \mathbf{P}\mathbf{Q}\mathbf{P}, \\ \overline{\mathbf{m}}_2 &= \mathbf{P}\mathbf{m}_2\mathbf{P}, \\ \overline{\mathbf{m}}_3 &= \mathbf{P}[\mathbf{m}_3 - \mathbf{m}_2\mathbf{h}\mathbf{m}_2]\mathbf{P}, \\ \overline{\mathbf{m}}_4 &= \mathbf{P}[\mathbf{m}_4 - \mathbf{m}_2\mathbf{h}\mathbf{m}_3 - \mathbf{m}_3\mathbf{h}\mathbf{m}_2 + \mathbf{m}_2\mathbf{h}\mathbf{m}_2\mathbf{h}\mathbf{m}_2]\mathbf{P}. \end{aligned} \quad (6.80)$$

Acting on string fields A_i , defining $\bar{A}_i = PA_i$, and using $m_2(A \otimes B) = A \star B$, we have for the first three products the explicit action:

$$\begin{aligned} \overline{\mathbf{Q}}A_1 &= P\mathbf{Q}\bar{A}_1, \\ \overline{\mathbf{m}}_2(A_1 \otimes A_2) &= P(\bar{A}_1 \star \bar{A}_2), \\ \overline{\mathbf{m}}_3(A_1 \otimes A_2 \otimes A_3) &= Pm_3(\bar{A}_1, \bar{A}_2, \bar{A}_3) - P(h(\bar{A}_1 \star \bar{A}_2) \star \bar{A}_3 + \bar{A}_1 \star h(\bar{A}_2 \star \bar{A}_3)). \end{aligned} \quad (6.81)$$

We can connect to the results of section 5.4 by identifying h as the propagator of the heavy fields that are being integrated out.

Homotopy transfer for \mathbf{L}_∞ . This case has some new features although the end result takes a similar form; here we will follow [73] with some changes of notation. Again we work with the tensor co-algebra $T(W)$ defined by the sum of symmetrized tensor products $SW^{\otimes n}$. We had before $\mathbf{b} = \mathbf{b}_1 + \mathbf{b}_2 + \mathbf{b}_3 + \dots$. We will set $\mathbf{L} = \mathbf{b}$, write $\mathbf{Q} = \mathbf{b}_1$, and define $\ell = \mathbf{b}_2 + \mathbf{b}_3 + \dots$. All in all, we have the degree one operator \mathbf{L} given by

$$\mathbf{L} = \mathbf{Q} + \ell, \quad \ell = \sum_{n=2}^{\infty} \mathbf{b}_n. \quad (6.82)$$

The main identity satisfied by the products is $\mathbf{L}^2 = 0$ which implies,

$$\mathbf{Q}^2 = 0, \quad \text{and} \quad \mathbf{Q}\ell + \ell\mathbf{Q} + \ell^2 = 0. \quad (6.83)$$

We introduce the projector $P : W \rightarrow \bar{W}$, taking W to the subspace \bar{W} of the effective field theory. We demand that

$$P^2 = P, \quad P\mathbf{Q} = \mathbf{Q}P, \quad (B_1, PB_2) = (PB_1, B_2). \quad (6.84)$$

We extend this projector to a degree zero operator $\mathbf{P} : T(W) \rightarrow T(\bar{W})$. We write:

$$\mathbf{P}(B_1 \wedge B_2 \wedge \dots \wedge B_n) \equiv PB_1 \wedge PB_2 \wedge \dots \wedge PB_n. \quad (6.85)$$

so that $\mathbf{P}^2 = \mathbf{P}$. Moreover it follows from (6.84) that \mathbf{P} and \mathbf{Q} commute $\mathbf{Q}\mathbf{P} = \mathbf{P}\mathbf{Q}$. As before, associated to the projector there is a linear operator h of degree 1 satisfying¹⁹

$$hP = Ph = 0, \quad h^2 = 0, \quad Qh + hQ = 1 - P. \quad (6.86)$$

The only new challenge here is defining \mathbf{h} , the associated odd operator on the symmetrized tensor algebra. This is done recursively. Using the notation $\bar{A} = PA$, we have

$$\begin{aligned} h(A_1 \wedge \dots \wedge A_n) \equiv & \frac{1}{n!} \sum_{\sigma \in \mathcal{S}_n} \epsilon(\sigma; A) \left(h(A_{\sigma(1)} \wedge \dots \wedge A_{\sigma(n-1)}) \wedge A_{\sigma(n)} \right. \\ & \left. + (-1)^{A_{\sigma(1)} + \dots + A_{\sigma(n-1)}} \bar{A}_{\sigma(1)} \wedge \dots \wedge \bar{A}_{\sigma(n-1)} \wedge hA_{\sigma(n)} \right). \end{aligned} \quad (6.87)$$

The reader can check that this gives, for example,

$$h(A_1 \wedge A_2) = \frac{1}{2} (hA_1 \wedge A_2 + hA_1 \wedge \bar{A}_2 + (-1)^{A_1} (\bar{A}_1 \wedge hA_2 + A_1 \wedge hA_2)). \quad (6.88)$$

The definition is such that the properties (6.86) holding on W get upgraded to identities in $T(W)$:

$$\mathbf{h}\mathbf{P} = \mathbf{P}\mathbf{h} = 0, \quad \mathbf{h}^2 = 0, \quad \mathbf{Q}\mathbf{h} + \mathbf{h}\mathbf{Q} = \mathbf{1} - \mathbf{P}. \quad (6.89)$$

Since we have here the same identities on the tensor algebra as in the A_∞ case, the operator $\bar{\mathbf{L}}$ defining the new products is given by the analog of (6.77):

$$\bar{\mathbf{L}} = \mathbf{P}\mathbf{Q}\mathbf{P} + \mathbf{P}\ell \frac{\mathbf{1}}{\mathbf{1} + \mathbf{h}\ell} \mathbf{P}, \quad (6.90)$$

and satisfies $\bar{\mathbf{L}}^2 = 0$, as required to be define L_∞ algebra. Moreover, $\bar{\mathbf{L}}$ is a coderivation in the tensor coalgebra and the new string products are graded symmetric [73].

The analogs of (6.80) hold, in particular, $\bar{\ell}_3 = \mathbf{P}[\ell_3 - \ell_2 \mathbf{h}\ell_2] \mathbf{P}$. Acting on string fields A_i , defining $\bar{A}_i = PA_i$, and $[A_1, A_2] = \ell_2(A_1 \wedge A_2)$, we have

$$\begin{aligned} \bar{Q}A_1 &= QA_1, \\ \bar{\ell}_2(A_1 \wedge A_2) &= P[\bar{A}_1, \bar{A}_2], \\ \bar{\ell}_3(A_1 \wedge A_2 \wedge A_3) &= P\ell_3(\bar{A}_1 \wedge \bar{A}_2 \wedge \bar{A}_3) \\ &\quad - P \left([h[\bar{A}_1, \bar{A}_2], \bar{A}_3] + (-1)^{A_2 A_3} [h[\bar{A}_1, \bar{A}_3], \bar{A}_2] + [\bar{A}_1, h[\bar{A}_2, \bar{A}_3]] \right). \end{aligned} \quad (6.91)$$

The expression for $\bar{\ell}_3$ is relevant to the computation of four-point functions. The last three terms are the contributions from three Feynman diagrams of the original field theory, where, due to h , only the states outside \bar{W} propagate.

7 String vertices

We have studied so far the algebraic structure of the various string field theories. These structures required a number of string products. These string products are defined, in general, using subsets of moduli spaces of Riemann surfaces with punctures and local coordinates at the punctures.

¹⁹We have made a sign change on the right-hand side of the last equation, relative to the one used in [73]. This is in order to have L_∞ results analogous to the A_∞ results.

In this section we will discuss in detail how these subsets of moduli spaces are selected, and how we can introduce coordinates around the punctures. This is the information about the string vertices. The consistency conditions on these choices is an equation quite analogous to the Batalin-Vilkovisky master equation. Equipped with such string vertices we then discuss how such information allows us to write the string field theory interactions.

At the basis of all of this lies the concept of a BV algebra. It begins by defining a complex \mathcal{C} , usually an infinite dimensional vector space, whose elements form a graded-commutative, associative algebra under a simple multiplication called a dot product. Given two elements $X, Y \in \mathcal{C}$ we write the dot product as $X \cdot Y \equiv XY$ belonging to the same complex. Graded commutativity of the dot product means $XY = (-1)^{XY} YX$ where X, Y in the sign factor refer to the Grassmannality of X and Y . On the space \mathcal{C} one introduces an odd operator Δ that squares to zero:

$$\Delta(\Delta X) = \Delta^2 X = 0, \quad \forall X \in \mathcal{C}. \quad (7.1)$$

Moreover, the operator Δ must be a *second order* (super) derivation of the dot product:

$$\begin{aligned} \Delta(XYZ) = & \Delta(XY)Z + (-1)^X X\Delta(YZ) + (-1)^{XY+Y} Y\Delta(XZ) \\ & - \Delta X(YZ) - (-1)^X X(\Delta Y)Z - (-1)^{X+Y} XY\Delta Z, \end{aligned} \quad (7.2)$$

for X, Y , and Z arbitrary elements in \mathcal{C} with definite Grassmannality. These properties define the BV algebra (\mathcal{C}, Δ) . Still, one extra object, the antibracket $\{X, Y\}$ of two elements, can be defined from the above structure as the failure of Δ to be a *first order* derivation:

$$\{X, Y\} \equiv (-1)^X \Delta(XY) - (-1)^X (\Delta X)Y - X\Delta Y. \quad (7.3)$$

There are three properties of the antibracket that follow from the above definition: the exchange property, the Jacobi-like property and the interaction with the dot product. These are quick to verify and read:

$$\begin{aligned} \{X, Y\} &= -(-1)^{(X+1)(Y+1)} \{Y, X\}, \\ 0 &= (-1)^{(X+1)(Z+1)} \{\{X, Y\}, Z\} + \text{cyclic}, \\ \{X, YZ\} &= \{X, Y\}Z + (-1)^{XY+Y} Y\{X, Z\}. \end{aligned} \quad (7.4)$$

We will now explain how this BV structure is defined when \mathcal{C} is built from Riemann surfaces with punctures, carrying a choice of local coordinates at each puncture. Then we will consider how this BV structure exists on functions defined on the vector space of a CFT. Finally, the relation between these structures will be established. This allows one to find an equation for string vertices that implies that the string field theory satisfies the BV master equation.

For simplicity we shall restrict most of our analysis to closed bosonic string field theory, and will describe the results for open closed string field theory at the end. Generalization of this analysis to superstring field theory is straightforward.

7.1 BV structures on moduli spaces

We first introduce the key definitions. We let $\mathcal{M}_{g,n}$ be the moduli space of Riemann surfaces of genus g and n punctures. The punctures are labeled and are thus distinguishable. This moduli space is finite dimensional. The space $\mathcal{P}_{g,n}$ is the moduli space of genus g surfaces and n punctures with a chosen analytic coordinate at each puncture. This space is infinite dimensional for $n > 0$, because

one requires an infinite number of parameters to define an analytic coordinate around a puncture. The space $\mathcal{P}_{g,n}$ is a fibering over $\mathcal{M}_{g,n}$, with a projection that simply forgets about the analytic coordinates at the punctures. For closed string field theory, however, it is necessary to introduce a space $\widehat{\mathcal{P}}_{g,n}$, also fibered over $\mathcal{M}_{g,n}$. This space is obtained from $\mathcal{P}_{g,n}$ by a projection that forgets the phase of the local coordinate at each puncture.

It is worth noting that local coordinate around a puncture is a map from a unit disk $|w| \leq 1$ to the surface, with $w = 0$ mapped to the puncture. The image of $|w| = 1$ under the map is a *coordinate curve*, a simple closed Jordan curve surrounding the puncture and homotopic to it. Specifying the phase of the local coordinate is equivalent to singling out a special point in the coordinate curve, say the image of $w = 1$. The coordinate curve with this special point marked is in fact enough, by the Riemann mapping theorem, to specify the local coordinate at the puncture. The coordinate curve, without any marked point, specifies the local coordinate up to a phase. This phase can be viewed as the marking of a special point on a closed string. We can therefore imagine any element of $\widehat{\mathcal{P}}_{g,n}$ as a Riemann surface of genus g , with n punctures and a coordinate curve around each puncture. A coordinate curve defines a coordinate disk – the disk which is the image of $|w| \leq 1$. The various coordinate disks should not have regions of overlaps. It is possible, however, for their boundaries to touch.

To build the complex \mathcal{C} we consider finite dimensional subspaces $\mathcal{A}_{g,n}$ of $\widehat{\mathcal{P}}_{g,n}$. Note that these subspaces can have any dimension from zero to infinity when $n > 0$. Next we consider spaces of disconnected ‘generalized’ surfaces as follows:

$$\mathcal{A}_{g_1, n_1} \times \dots \times \mathcal{A}_{g_r, n_r}. \quad (7.5)$$

A ‘surface’ in this term is a disconnected one of the form $(\Sigma_{g_1, n_1}, \dots, \Sigma_{g_r, n_r})$, in fact a collection of r surfaces, one from each subspace. Here, the disconnected surface has a total of $N = \sum_{i=1}^r n_i$ punctures. We assign a degree to the subspaces $\mathcal{A}_{g,n}$ by setting it equal to its dimensionality

$$\deg(\mathcal{A}_{g,n}) = \dim(\mathcal{A}_{g,n}) \pmod{2}. \quad (7.6)$$

The order of the factors in the above product matters only up to signs. Thus, for example

$$\mathcal{A}_{g_1, n_1} \times \mathcal{A}_{g_2, n_2} = (-1)^{\mathcal{A}_{g_1, n_1} \cdot \mathcal{A}_{g_2, n_2}} \mathcal{A}_{g_2, n_2} \times \mathcal{A}_{g_1, n_1}. \quad (7.7)$$

An important technical point has to do with labeling of punctures. In an element of \mathcal{C} we need the punctures to be labeled from 1 to N . This is easily done by labeling the punctures successively from left to right; those in the first space from 1 to n_1 , those in the second space from $n_1 + 1$ to $n_1 + n_2$ and so on. Moreover we need the element of \mathcal{C} to be invariant under the exchange of labels – we can call this a symmetric space. This can be implemented above by applying to the surfaces in (7.5) a permutation operator \mathbf{P} in the symmetric group S_N that permutes the N labels of the punctures, and a normalization factor. The result is finally an element of the complex \mathcal{C} , denoted with double brackets $[[\dots]]$:

$$[[\mathcal{A}_{g_1, n_1}, \dots, \mathcal{A}_{g_r, n_r}]] \equiv \frac{1}{n_1! \dots n_r!} \sum_{\sigma \in S_N} \mathbf{P}_\sigma(\mathcal{A}_{g_1, n_1} \times \dots \times \mathcal{A}_{g_r, n_r}) \in \mathcal{C}. \quad (7.8)$$

The normalization factor is such that if the \mathcal{A} spaces are themselves symmetric, the only effect of the permutations is to move labels across the disconnected surfaces. The $[[\dots]]$ are graded symmetric under the exchange of the \mathcal{A} spaces within the brackets. The orientation of these $[[\dots]]$

spaces is induced by the orientation of the \mathcal{A} subspaces. The general element of \mathcal{C} consists of linear superpositions of the above elements multiplied by real numbers.

Having defined \mathcal{C} we must now define the dot product. This is actually easy, we take

$$\left[\left[\mathcal{A}_{g_1, n_1}, \dots, \mathcal{A}_{g_r, n_r} \right] \right] \cdot \left[\left[\mathcal{B}_{g'_1, n'_1}, \dots, \mathcal{B}_{g'_p, n'_p} \right] \right] = \left[\left[\mathcal{A}_{g_1, n_1}, \dots, \mathcal{A}_{g_r, n_r}, \mathcal{B}_{g'_1, n'_1}, \dots, \mathcal{B}_{g'_p, n'_p} \right] \right]. \quad (7.9)$$

This product is graded commutative, as expected, and is also manifestly associative. The unit element of this algebra are surfaces without any connected components, and thus also without any punctures.

To complete the definition of the BV structure we need to define the Δ operator. For this we must make use of *twist gluing* introduced in (4.10). Consider two punctures P_i and P_j on a generalized surface; the punctures may lie on the same surface or on different surfaces. Let w_i and w_j denote the local coordinates around the punctures. Twist gluing of these two punctures means gluing the two punctures via the relation $w_i w_j = e^{i\theta}$, with $\theta \in [0, 2\pi]$. This operation reduces the number of punctures by two and increases the dimensionality by one, by adding the circle associated with the various values of θ . Since we consider the collection of all surfaces labelled by θ , this definition is insensitive to the choice of the phases of the local coordinates w_i , w_j and makes sense as operations on the elements of $\widehat{\mathcal{P}}_{g,n}$.

We now define an operator Δ_{ij} with $i \neq j$ that acts on a product space $\mathcal{A} = \mathcal{A}_1 \times \dots \times \mathcal{A}_r$. We let $\Delta_{ij}\mathcal{A}$ equal $\frac{1}{2}$ times the set of surfaces obtained by twist gluing the punctures P_i and P_j for all the surfaces in \mathcal{A} . When the punctures lie on the same surface, the number of connected components of the generalized surface does not change, but the genus of the surface in question increases by one unit. When the punctures lie on two different surfaces, these are joined by the gluing, and the number of connected components decreases by one. In either case the dimensionality of the space increases by one unit, with the twist angle parametrizing the new dimension. If the number of punctures in \mathcal{A} is one or less, the action of Δ_{ij} gives zero. The orientation of $\Delta_{ij}\mathcal{A}$ is defined by the ordered set of tangent vectors $[\frac{\partial}{\partial\theta}, \{\mathcal{A}\}]$, where $\{\mathcal{A}\}$ is the ordered collection of tangent vectors that define the orientation of \mathcal{A} .

More generally, we can now define the Δ operator as follows using the definition of the elements of \mathcal{C} . For any $X = [[\mathcal{A}_{n_1, g_1}, \dots, \mathcal{A}_{g_r, n_r}]]$ we define²⁰

$$\Delta X \equiv \Delta_{ij} X \equiv \frac{1}{n_1! \dots n_r!} \sum_{\sigma \in S_N} \Delta_{ij} \mathbf{P}_\sigma(\mathcal{A}_{n_1, g_1} \times \dots \times \mathcal{A}_{g_r, n_r}), \quad (7.10)$$

with $i \neq j$ and $1 \leq i, j \leq N$. This definition is independent of the choice of i and j due to the symmetry of the space X .

Let us now understand why the above-defined Δ operation satisfies $\Delta(\Delta X) = 0$. This is actually a matter of signs, and can be understood by considering a generalized surface X with four or more punctures. Indeed, for three or less punctures the first Δ reduces the number of punctures to one or less, and the second Δ simply gives zero. For four or more punctures, we will evaluate $\Delta^2 X$ in two ways, as $\Delta_{12}\Delta_{12}X$ and as $\Delta_{12}\Delta_{34}X$. The independence of Δ on the choice of punctures implies that the two evaluations should be the same. But we will show that they actually differ by a sign.

In calculating with the first option $\Delta_{12}\Delta_{12}X$, consider acting on an element $\Sigma_X \in X$. We first twist glue punctures P_1 and P_2 of Σ_X , then relabel the punctures ($P_3 \dots P_N$) as ($P_1 \dots P_{N-2}$) and twist glue the new P_1 and P_2 punctures. Effectively the second gluing operation is joining the original

²⁰The Δ operator here is what we called Δ_c in section 4.1. Since at this stage we are dealing exclusively with closed strings, we drop the subscript c to avoid cluttering. Later when we consider open closed string field theory, we shall have both Δ_c and Δ_o .

P_3 and P_4 punctures. Therefore, the orientation of the space $\Delta_{12}\Delta_{12}X$ at the subspace $\Delta_{12}(\Delta_{12}\Sigma_X)$ will contain the tangent vectors

$$\Delta_{12}(\Delta_{12}\Sigma_X) \text{ orientation } \left[\frac{\partial}{\partial\theta_{34}}, \frac{\partial}{\partial\theta_{12}}, \{X\} \right], \quad (7.11)$$

where $\frac{\partial}{\partial\theta_{12}}$ is the tangent vector associated with the gluing of punctures one and two and $\frac{\partial}{\partial\theta_{34}}$ is the tangent vector associated with the gluing of punctures three and four. The ordering of the tangent vectors in the above expression is fixed as shown.

In calculating with the second option $\Delta_{12}\Delta_{34}X$, we again focus on the element $\Sigma_X \in X$. We first twist glue punctures P_3 and P_4 of Σ_X , and then twist glue the punctures P_1 and P_2 , which need no relabeling. This time we have

$$\Delta_{12}(\Delta_{34}\Sigma_X) \text{ orientation } \left[\frac{\partial}{\partial\theta_{12}}, \frac{\partial}{\partial\theta_{34}}, \{X\} \right]. \quad (7.12)$$

We see that with this second option we have the opposite orientation as in the first option. Given that the two ways of calculation Δ^2X give answers that differ by a minus sign, we conclude that $\Delta^2X = 0$.

The final property of Δ that must be shown is that it is a second-order derivation of the dot product, as indicated in (7.2). The verification of this relation is a matter of keeping track of the types of surfaces produced by the various terms. For example, we write $\Delta(XYZ) = R_{XX} + R_{YY} + R_{ZZ} + R_{XY} + R_{XZ} + R_{YZ}$, where R_{XX} , for example denotes surfaces where the two punctures glued are in X , and R_{XY} denotes surfaces where one puncture is in X and one is in Y . By tracking surfaces for each term on the right-hand side one can prove that the equation holds. This requires some care with normalization factors and signs (see [108])

We now turn to the antibracket that as written in (7.3) is obtained as the failure of Δ to be a derivation of the dot product.

$$\{X, Y\} \equiv (-1)^X \Delta(XY) - (-1)^X (\Delta X)Y - X\Delta Y. \quad (7.13)$$

For the first term on the right-hand side we write

$$(-1)^X \Delta(XY) = S_{XX} + S_{YY} + S_{XY}, \quad (7.14)$$

where S_{XX} are the surfaces where two punctures in X are glued, S_{YY} are the surfaces where two punctures in Y are glued, and S_{XY} are the surfaces where the punctures glued are one in X and one in Y . All these surfaces have the orientation $(-1)^X \{\partial/\partial\theta, [X], [Y]\} = \{[X], \partial/\partial\theta, [Y]\}$. It also becomes clear that for the other two terms on the right-hand side

$$(-1)^X (\Delta X)Y = S_{XX}, \quad X\Delta Y = S_{YY}, \quad (7.15)$$

with the sign factors manifestly coming from the orientations. We thus see that $\{X, Y\} = S_{XY}$ with orientation $\{[X], \partial/\partial\theta, [Y]\}$; the antibracket glues two punctures, one on the first entry and one on the second entry. In summary, if Σ_X denotes an element of X and Σ_Y denotes an element of Y , then $\{X, Y\}$ consists of surfaces where one puncture of Σ_X is glued to one puncture of Σ_Y , and the final punctured surface is symmetrized on all the remaining punctures. It will often be the case that X and Y are just spaces with one connected component, and thus Σ_X and Σ_Y are just each a Riemann surface with punctures, as opposed to a generalized surface.

Beyond the dot product and the Δ operator, we also have a boundary operator ∂ acting on \mathcal{C} . For any $X \in \mathcal{C}$ we write ∂X for the boundary of X . The boundary operator acting on a space of surfaces simply takes the boundary of the space, giving us another space of surfaces, with an orientation induced by the orientation of the original space²¹. Since ∂ decreases the dimensionality of a space by one unit, it changes degree. The operator ∂ is an odd derivation of the dot product

$$\partial(XY) = (\partial X)Y + (-1)^X X\partial Y. \quad (7.16)$$

Moreover ∂ anticommutes with Δ , as one can see by tracking the ordering of vectors defining the orientations;

$$\Delta\partial X = -\partial\Delta X. \quad (7.17)$$

Finally, using the definition of the antibracket from the Δ operator, one can quickly check that ∂ is an odd derivation of the antibracket:

$$\partial\{X, Y\} = \{\partial X, Y\} + (-1)^{X+1}\{X, \partial Y\}. \quad (7.18)$$

The sign factor in the second term a consequence of the orientation $\{[X], \partial/\partial\theta, [Y]\}$ of $\{X, Y\}$, and to reach Y , ∂ goes ‘across’ the X space and the gluing operation.

7.2 BV structures on CFT

The central point to be discussed here, focused on bosonic closed string field theory, is that for any matter CFT of $c = 26$ coupled to the reparameterization ghosts CFT, we can represent the BV structures discussed above on the space of functions of string fields. We call \mathcal{H} the state space of this complete CFT.

As discussed in section 3.2 this conformal field theory supplies string field valued forms that can be integrated over moduli spaces of Riemann surfaces. More precisely we have objects

$$\langle \Omega_k^{(g,n)} | \in (\mathcal{H}^*)^{\otimes n} \quad (7.19)$$

related to $\Omega_k^{(g,n)}(A_1, \dots, A_n)$ introduced in (3.44) via

$$\langle \Omega_k^{(g,n)} | A_1 \rangle \otimes \dots \otimes | A_n \rangle = \Omega_k^{(g,n)}(A_1, \dots, A_n), \quad (7.20)$$

that are differential forms of degree k in $\widehat{\mathcal{P}}_{g,n}$. These are suitable for integration over k dimensional subspaces $\mathcal{A}_{g,n}^{(k)}$ of $\widehat{\mathcal{P}}_{g,n}$. The forms above satisfy a very nontrivial property involving the BRST operator and the boundary operator on moduli spaces. We have

$$\int_{\mathcal{A}_{g,n}} \langle \Omega_k^{(g,n)} | \sum_{i=1}^n Q^{(i)} = (-1)^k \int_{\partial\mathcal{A}_{g,n}} \langle \Omega_{k-1}^{(g,n)} |. \quad (7.21)$$

Suppose we have a symmetric space $\mathcal{A}_{g,n}^{(k)}$, we then define

$$f(\mathcal{A}_{g,n}^{(k)}) \equiv \frac{1}{n!} \int_{\mathcal{A}_{g,n}^{(k)}} \langle \Omega_k^{(g,n)} | \Psi \rangle_1 \dots | \Psi \rangle_n. \quad (7.22)$$

²¹Given a point $p \in \mathcal{A}$, a set of basis vectors $[v_1, \dots, v_k]$ in $T_p(\partial\mathcal{A})$ defines the orientation of $\partial\mathcal{A}$ if $[n, v_1, \dots, v_k]$, with n an outward pointing basis vector of $T_p\mathcal{A}$, is the orientation of \mathcal{A} at p .

More generally we have

$$f\left(\left[\mathcal{A}_{g_1, n_1}^{(k_1)} \cdots \mathcal{A}_{g_r, n_r}^{(k_r)}\right]\right) \equiv \prod_{i=1}^r \frac{1}{n_i!} \int_{\mathcal{A}_{g_i, n_i}^{(k_i)}} \langle \Omega_{k_i}^{(g_i, n_i)} | \Psi \rangle_1 \cdots | \Psi \rangle_{n_i}. \quad (7.23)$$

This definition makes it clear that

$$f(XY) = f(X)f(Y), \quad X, Y \in \mathcal{C}. \quad (7.24)$$

The operations Δ and $\{\cdot, \cdot\}$ on string functionals are defined as follows. We first define BPZ-implementing states $|R_{12}\rangle$ and $\langle R_{12}|$ via the relations

$${}_1\langle A| {}_2\langle B|R_{12}\rangle = \langle A|B\rangle, \quad \langle R_{12}|A\rangle_1 |B\rangle_2 = \langle A|B\rangle, \quad (7.25)$$

for any pair of states $|A\rangle, |B\rangle$ in the full CFT state space \mathcal{H}' . We then define symplectic forms $\langle \omega|$ and $|S\rangle$ as follows²²

$$\begin{aligned} \langle \omega_{12}| &= \langle R_{12}|c_0^{-(2)}, \\ |S_{12}\rangle &= b_0^{-(1)}|R_{12}\rangle. \end{aligned} \quad (7.26)$$

With these structures we can now express the antibracket of two string functions F and G , defined in (4.20) and (4.21), as

$$\{F, G\} = (-1)^{G+1} \frac{\partial F}{\partial |\Psi\rangle} \frac{\partial G}{\partial |\Psi\rangle} |S\rangle \quad (7.27)$$

Here the ket $|S\rangle$ glues the two state spaces left open by the differentiation with respect to the string field. They are $\langle F_R|c_0^-$ and $\langle G_R|c_0^-$ in the notation of (4.20). There is no need to specify left and right derivatives because the string field is even. The symplectic form can be used to write the kinetic term $S_{0,2}$ of the string field theory.

$$S_{0,2} = \frac{1}{2} \langle \omega_{12}| Q^{(2)} | \Psi \rangle_1 | \Psi \rangle_2. \quad (7.28)$$

For the Δ action on functions we have

$$\Delta F = \frac{1}{2} (-1)^{F+1} \left(\frac{\partial}{\partial |\Psi\rangle} \frac{\partial}{\partial |\Psi\rangle} F \right) |S\rangle. \quad (7.29)$$

We now have a wonderful interplay in which [108]

$$f(\Delta X) = -\Delta f(X), \quad (7.30)$$

where the Δ operation on the left-hand side acts on a space of surfaces and the Δ on the right-hand side is that acting on the space of string field functions. It now follows from the definition of the antibracket in terms of the Δ operators that

$$f(\{X, Y\}) = -\{f(X), f(Y)\}, \quad (7.31)$$

where the antibracket on the right-hand side is that of string functionals.

We also have that the boundary operator is implemented by the antibracket with the kinetic term of the string field theory:

$$\{S_{0,2}, f(X)\} = -f(\partial X). \quad (7.32)$$

²²In [6, 80, 84], the states $|R'_{12}\rangle$ and $\langle R'_{12}|$ defined as projections of $|R_{12}\rangle$ and $\langle R_{12}|$ to the kernel of L_0^- were used in (7.26). This is not needed when the symplecting forms act on states that are already projected, as is the case here.

7.3 Geometric BV master equation and string field theory master equation

The string field theory vertices are, geometrically, collections of Riemann surfaces. The three-string vertex $\mathcal{V}_{0,3}$ of the classical theory is a Riemann sphere with three punctures and local coordinates, up to phases, at each of the punctures. The four-string vertex $\mathcal{V}_{0,4}$ consists of a subset of $\widehat{\mathcal{P}}_{0,4}$, namely a collection of four punctured spheres, each with local coordinates, up to phases, at each of the punctures. In general, for the full quantum theory we have vertices $\mathcal{V}_{g,n} \subset \widehat{\mathcal{P}}_{g,n}$, for various values of the genus g and the number of punctures n . We formally sum these sets of surfaces to form the full string vertex \mathcal{V} defined as follows:

$$\mathcal{V} = \sum_{g,n} g_s^{2g+n-2} \mathcal{V}_{g,n}, \quad \text{with} \quad \begin{cases} n \geq 3, & \text{for } g = 0, \\ n \geq 1, & \text{for } g = 1, \\ n \geq 0, & \text{for } g \geq 2. \end{cases} \quad (7.33)$$

The $g = 0$ vertices, belonging to the classical theory, begin with three punctures. The string vertex does not contain Riemann spheres with two or less punctures. The $g = 1$ vertices, associated with the leading quantum correction to the action, does not contain the surfaces with zero punctures (the plain un-punctured torus). For $g \geq 2$ surfaces with all numbers of punctures, including zero, appear, although the surfaces with no punctures give a constant contributions to the action. As such, they are not relevant in the verification that the action satisfies the master equation. These constant terms, however, are required for the string action to be background independent. Recalling that the Euler number of genus g surfaces with n punctures (viewed as boundaries) is $\chi_{g,n} = 2 - 2g - n$, we see that the moduli spaces enter \mathcal{V} weighted by the factor $(g_s)^{-\chi_{g,n}}$, just as multilinear functions were built in (4.11). Interestingly, the list of vertices above is precisely that for which the surfaces have negative Euler number and thus admit hyperbolic metrics of constant negative curvature. The string vertices are symmetric under the exchange of punctures, a simple condition discussed in the context of our discussion of the BV algebra on moduli spaces.

The $\mathcal{V}_{g,n}$ are often taken to be pieces of *sections* on the bundle $\widehat{\mathcal{P}}_{g,n}$ over $\mathcal{M}_{g,n}$. This condition, if satisfied, makes the construction more canonical, as each underlying Riemann surface in the vertex is constructed once and only once. Examples where this is achieved are the constructions of vertices from minimal area metrics, and the construction using hyperbolic metrics. It is clear, however, that the consistency of the string field theory is satisfied by vertices that are more general and are not strict sections. All that is needed is that $\mathcal{V}_{g,n}$ maps onto its image under the projection $\pi : \widehat{\mathcal{P}}_{g,n} \rightarrow \mathcal{M}_{g,n}$ with degree one. As explained in section 3.2 for the case of the full subspace $\mathcal{F}_{g,n}$, this means that a generic surface is counted once *with multiplicity*. On the left of Fig. 4 we show a string vertex $\mathcal{V}_{g,n}$ that is a piece of a section over $\mathcal{M}_{g,n}$. On the right we have a string vertex $\mathcal{V}_{g,n}$ that is not a piece of a section over $\mathcal{M}_{g,n}$. In both cases the projection π maps $\mathcal{V}_{g,n}$ to its image with degree one. As discussed in section 4, $\mathcal{V}_{g,n}$ is part of $\mathcal{F}_{g,n}$, it consists of Riemann surfaces that are not produced by the Feynman diagrams with one or more propagators.

The string vertices, or just simply \mathcal{V} must satisfy a consistency condition for the resulting string field theory to be consistent. This is a geometric version of the BV master equation and it takes the form

$$\partial\mathcal{V} + \Delta\mathcal{V} + \frac{1}{2}\{\mathcal{V}, \mathcal{V}\} = 0, \quad (7.34)$$

We have discussed the objects in this equation before. We have an antibracket and a Δ operator in the space of surfaces, and the boundary operator ∂ .

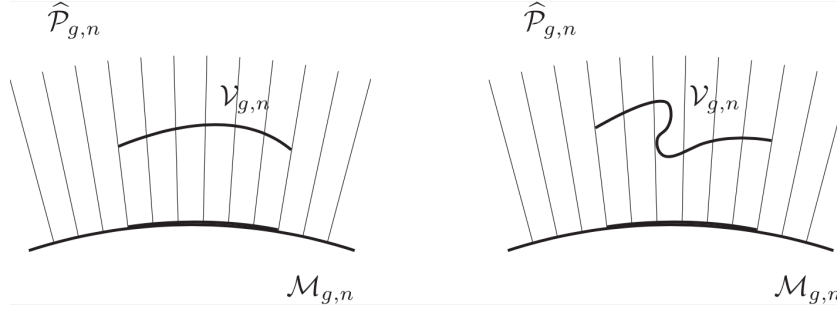

Figure 4: A string vertex $\mathcal{V}_{g,n}$ that is a piece of a section over $\mathcal{M}_{g,n}$ (left), and a string vertex $\mathcal{V}_{g,n}$ that is not a piece of a section over $\mathcal{M}_{g,n}$ (right). In both cases the projection π maps $\mathcal{V}_{g,n}$ to its image in $\mathcal{M}_{g,n}$ with degree one.

We have all the ingredients to show that the above geometric BV equation implies that the string field theory action S constructed using the vertex \mathcal{V} satisfies the BV master equation in the space of string fields. The action is easily written down using the function f of string field constructed in the previous section using spaces of Riemann surfaces. We take

$$S = S_{0,2} + f(\mathcal{V}). \quad (7.35)$$

To verify the master equation we first note that the kinetic term $S_{0,2}$ satisfies a couple of simple properties:

$$\{S_{0,2}, S_{0,2}\} = 0, \quad \Delta S_{0,2} = 0. \quad (7.36)$$

The first follows by direct computation (see, [6]) and the second because the kinetic term couples vertex operators whose ghost numbers add up to four, and those cannot be paired to a field and its associated antifield – in such pairs the ghost numbers of the vertex operators add up to five. With these results, the verification of the master equation reduces to

$$\begin{aligned} 0 &= \frac{1}{2}\{S, S\} + \Delta S \\ &= \{S_{0,2}, f(\mathcal{V})\} + \frac{1}{2}\{f(\mathcal{V}), f(\mathcal{V})\} + \Delta f(\mathcal{V}) \\ &= -f(\partial\mathcal{V}) - \frac{1}{2}f(\{\mathcal{V}, \mathcal{V}\}) - f(\Delta\mathcal{V}) \\ &= -f\left(\partial\mathcal{V} + \frac{1}{2}\{\mathcal{V}, \mathcal{V}\} + \Delta\mathcal{V}\right) = 0, \end{aligned} \quad (7.37)$$

which is thus shown to hold on account of the geometrical BV equation satisfied by \mathcal{V} .

While having the string field action satisfy the BV master equation is the main reason for the geometrical BV equation, there are other aspects to this geometrical equation that are also quite important. In particular, focusing on the boundary $\partial\mathcal{V}_{g,n}$ we have the pictorial representation of the master equation

$$\partial \bigcirc_{\mathcal{V}_{g,n}} = -\frac{1}{2} \sum_{\substack{g_1+g_2=g \\ n_1+n_2=n+2}} \bigcirc_{\mathcal{V}_{g_1,n_1}} - \bigcirc_{\mathcal{V}_{g_2,n_2}} - \frac{1}{2} \bigcirc_{\mathcal{V}_{g-1,n+2}}$$

The first term on the right-hand side shows the gluing pattern of the antibracket, joining two lower vertices whose surfaces, upon gluing, give surfaces of genus g and with n punctures, the same as the

surface on the left-hand side. The second term shows the gluing pattern of the Δ operator acting on single surfaces. Since this operation increases the genus and reduces the number of punctures by two, the surfaces it acts upon belong to $\mathcal{V}_{g-1, n+2}$. The sets of surfaces on both sides of the equation must be the same as elements of $\widehat{\mathcal{P}}_{g,n}$. As an equation the above reads

$$\partial\mathcal{V}_{g,n} = -\Delta\mathcal{V}_{g-1, n+2} - \frac{1}{2} \sum_{\substack{g_1+g_2=g \\ n_1+n_2=n+2}} \{\mathcal{V}_{g_1, n_1}, \mathcal{V}_{g_2, n_2}\} \equiv \mathcal{O}_{g,n}. \quad (7.38)$$

Note that the twist gluing operation of local coordinates w_1, w_2 in $w_1 w_2 = t$, with $|t| = 1$ is a boundary of the gluing operation $w_1 w_2 = t$ with $|t| \leq 1$. The latter creates a set of surfaces that is associated to a propagator joining the legs of the vertex. In this picture, the twist-gluing set represents the collapsed propagator, a propagator that has zero length. The $t = 0$ surface is a degenerate surface, and corresponds to the limit of an infinitely long propagator. The relation displayed above tells us that the boundary of the vertex coincides with the collapsed propagator boundary of the Feynman diagrams built just with one propagator. We write this as

$$\partial\mathcal{V}_{g,n} = -\partial_p R_1, \quad (7.39)$$

here ∂_p denotes collapsed propagator boundary, and R_1 is the set of surfaces built with lower vertices and just one propagator.

7.4 Deligne-Mumford compactification, noded surfaces and Feynman diagrams

It is useful to pause to describe explicitly the degenerate surfaces and their role in the theory. Such surfaces, called *noded surfaces*, are the key element in the Deligne-Mumford compactification $\overline{\mathcal{M}}_{g,n}$ of the moduli space $\mathcal{M}_{g,n}$. A noded surface is a connected complex space where points have neighborhoods complex isomorphic to $\{|z| < 1\}$, in which case they are regular points, or complex isomorphic to the set $\{zw = 0; |z| < 1, |w| < 1\}$ in \mathbb{C}^2 , in which case they are nodes. We imagine a node as the single common point where two separate pieces of surfaces touch. Each component of the complement of the nodes, called a *part* of the noded surface, has negative Euler characteristic. A part can be a three-punctured sphere (counting the node as a puncture) but not, for example, a one or two punctured sphere. Depending on the number of nodes and their configuration the surface can have one or more parts. If a surface has a single node, it may have one or two parts, depending whether the degeneration is separating or non-separating. It is also useful to describe the neighborhoods of the noded surfaces within the compactified space, and so specify the topology of the compactification. For this, we consider the case of a noded surface Σ_0 with a single node, and explain what it means to open up the node. Fix a complex number t with $|t| < \epsilon$ small to remove a neighborhood \mathcal{U} of the node, $\mathcal{U} = \{|z| < |t|, |w| < |t|\}$ and form the identification space $\Sigma_t = (\Sigma_0 - \mathcal{U})/(zw = t)$. This removes the node and connects locally the pieces of surfaces that before just touched via a plumbing fixture (note that the coordinates z and w must be defined all the way to $|z| = 1$ and $|w| = 1$). The surfaces near Σ_0 in the moduli space are: (a) noded surfaces in which the parts are quasi-conformally close to the parts of Σ_0 , and (b) smooth surfaces with small $t \neq 0$ obtained by opening up the node in the surfaces in (a). With this compactification, $\overline{\mathcal{M}}_{g,n}$ is now compact and boundaryless. Note that the string field theory construction of surfaces with propagators and plumbing fixtures $zw = t$ precisely describes the neighborhoods of the noded surfaces, with the limit $t \rightarrow 0$ as the noded surface. The noded surfaces are viewed as divisors in the moduli space.

The vertices in \mathcal{V} must be sufficient to construct, with Feynman rules, all the Riemann surfaces in the various moduli spaces – this is, after all, the way string amplitudes must be generated. In general, after using string vertices together with a propagator to form Feynman graphs of string field theory, the result is some submanifold $\mathcal{F}_{g,n}$ in $\widehat{\mathcal{P}}_{g,n}$. This is clear, because gluing of surfaces in $\widehat{\mathcal{P}}_{g,n}$ gives surfaces in $\widehat{\mathcal{P}}_{g,n}$. It is traditionally required that $\mathcal{F}_{g,n}$ should be a full section of the bundle $\widehat{\mathcal{P}}_{g,n}$, so that the map $\mathcal{F}_{g,n} \rightarrow \mathcal{M}_{g,n}$ is a homeomorphism. As will be discussed in the following sections, this can actually be achieved with minimal area string vertices, and almost surely with hyperbolic string vertices. It is not necessary, however. All that is required is that the map $\mathcal{F}_{g,n} \rightarrow \mathcal{M}_{g,n}$ be of degree one. Such a map is surjective. This is what colloquially would be referred as “covering the moduli space”. This is enough to imply that the integral over $\mathcal{F}_{g,n}$ of any differential form pulled back from $\mathcal{M}_{g,n}$ will be the same as the integral over $\mathcal{M}_{g,n}$. Since the integrand for on-shell string states is a top-form on $\mathcal{M}_{g,n}$, this implies that the amplitude for on-shell string states computed by integrating over $\mathcal{M}_{g,n}$ coincides with that computed using string field theory Feynman rules. More precisely, and for clarity, we work with the compactified moduli space $\overline{\mathcal{M}}_{g,n}$ and we also view $\mathcal{F}_{g,n}$ as a space without boundary. However, as will be discussed shortly, and in more detail in §9, we shall encounter several situations where the degenerate surfaces require special treatment.

In string field theory we build $\mathcal{F}_{g,n}$ as follows

$$\mathcal{F}_{g,n} = \mathcal{V}_{g,n} \oplus R_1 \oplus \cdots \oplus R_{3g-3+n}. \quad (7.40)$$

Here R_I is the set of surfaces built using I propagators. As indicated above, the maximum number of propagators is $3g - 3 + n$. Since $\mathcal{F}_{g,n}$ is boundaryless, a closed chain in mathematical language, the space to the right must be boundaryless. There are two types of boundaries that appear in this construction: (i) the boundaries of the vertices and, (ii) the boundaries from surfaces where the length of a propagator is zero. When the length of the propagators is infinite we approach the divisors; the noded surfaces that are not counted as boundaries. The two kinds of boundaries cancel each other by the geometric master equation. In fact, one can show that the vertex boundaries of R_I cancel against the propagator boundary of R_{I+1} , this being an extension of (7.39). Note also that R_{3g-3+n} has no vertex boundary, as it is a region built by gluing a set of $\mathcal{V}_{0,3}$ that have no moduli.

The infinite length propagators, leading to the noded surfaces require special attention. If the momentum propagating along the propagator is generic and can be varied continuously, then by choosing the momentum appropriately we can make the forms $\Omega_k^{(g,n)}$ fall off sufficiently rapidly near these regions. The amplitudes for other values of momenta for which $\Omega_k^{(g,n)}$ does not fall off near these regions can be defined by analytic continuation. A systematic procedure of carrying out this analytic continuation was described in [39]. There are however cases where the momentum along the propagator is not generic, *e.g.* when it is forced to be either zero or on-shell due to momentum conservation. In such cases the contribution from these regions requires special attention. This will be the subject of our discussion in section 9. In this section we shall proceed by assuming that that $\Omega_k^{(g,n)}$ falls off sufficiently fast near these regions.

It is useful to consider string vertices $\mathcal{V}_{g,n}$ that are not submanifolds $\widehat{\mathcal{P}}_{g,n}$, but rather, more general *singular* chains of degree $6g - 6 + 2n$. By using singular chains, the space $\mathcal{V}_{g,n}$ could be the formal sum of several disjoint spaces, or could have self-intersections, for example. Since the purpose of introducing string vertices is to integrate over them, and there is a well-behaved theory of integration of differential forms on singular chains, these kinds of vertices are allowed. As we will see, due to complications with picture-changing operators in superstring field theory, the string vertices

are often singular chains. In such cases $\mathcal{F}_{g,n}$ is also a singular chain. Because of the symmetry under permutation of the punctures, it is an S_n invariant chain.

The precise statement of covering of moduli space that leads to correct on-shell string amplitudes is that the chain $\mathcal{F}_{g,n}$, constructed as Feynman diagrams using \mathcal{V} and a propagator, when projected via the forgetting of the coordinates, must represent the fundamental homology class of $\overline{\mathcal{M}}_{g,n}$. As discussed in [34], this constraint will be satisfied if the chain \mathcal{V} satisfies the geometric master equation (7.34).

In solving the geometrical master equations to find \mathcal{V} the starting point is the vertex $\mathcal{V}_{0,3}$, the three-punctured sphere. Since all three punctured spheres are conformally equivalent, we just need an assignment of local coordinates at the punctures respecting the symmetry under exchange of punctures. The simplest cases from the geometrical master equation arise from its constraints on vertices of complex dimension one: these are $\mathcal{V}_{0,4}$ and $\mathcal{V}_{1,1}$. We have

$$\partial\mathcal{V}_{0,4} = -\frac{1}{2}\{\mathcal{V}_{0,3}, \mathcal{V}_{0,3}\}, \quad \text{and} \quad \partial\mathcal{V}_{1,1} = -\Delta\mathcal{V}_{0,3}. \quad (7.41)$$

The next step is to find the sets $\mathcal{V}_{0,4}$ and $\mathcal{V}_{1,1}$ that satisfy the above conditions. As we will discuss concretely, this is always possible. One includes in the sets all the surfaces that lie in the interior of the moduli spaces up to the prescribed boundaries. On these surfaces the local coordinates must be chosen as known on the boundaries and continuously within the set.

7.5 Existence of string vertices

While we need explicit solutions of the geometric BV equations in order to do off-shell computations in string field theory, a more basic question is whether there exists a solution to these equations. This was answered in the affirmative by Costello [79], with the full details of this argument given in [34]. We briefly sketch the main points of the inductive argument.

Suppose we have found all the vertices $\mathcal{V}_{g',n'}$ such that $3g' - 3 + n' < 3g - 3 + n$. At this point we need to find $\mathcal{V}_{g,n}$ satisfying

$$\partial\mathcal{V}_{g,n} = \mathcal{O}_{g,n}. \quad (7.42)$$

The right hand side $\mathcal{O}_{g,n}$ of this equation was defined in (7.38), and it is $(6g - 6 + 2n) - 1$ chain on $\widehat{\mathcal{P}}_{g,n}$. It is built entirely from $\mathcal{V}_{g',n'}$ which we have already constructed. By construction, $\mathcal{O}_{g,n}$ is an S_n invariant chain, we require $\mathcal{V}_{g,n}$ to be S_n invariant as well. It is a simple calculation to show that $\partial\mathcal{O}_{g,n} = 0$; it only requires using the master equation for the spaces we have already constructed. This is a consistency condition for the above equation: the chain $\mathcal{O}_{g,n}$ must be closed. But this does not suffice, the chain should be trivial so that we can solve for $\mathcal{V}_{g,n}$. In other words the appropriate homology class of $\mathcal{O}_{g,n}$ must vanish:

$$[\mathcal{O}_{g,n}] \in H_{6g-6+2n-1}(\widehat{\mathcal{P}}_{g,n})^{S_n} \quad \text{must vanish.} \quad (7.43)$$

The first step in proving this is to show that $\widehat{\mathcal{P}}_{g,n}$ is homotopy equivalent to $\mathcal{M}_{g,n}$. This implies that the homology groups of $\widehat{\mathcal{P}}_{g,n}$ and of $\mathcal{M}_{g,n}$ are isomorphic. This step is somewhat technical. One first shows that $\widehat{\mathcal{P}}_{g,n}$ is isomorphic to a space $\widehat{\mathcal{P}}'_{g,n}$ of Riemann surfaces of genus g with n boundary components and an angular coordinate, defined up to rotation, on each boundary. This latter space is actually known to be homotopy equivalent of $\mathcal{M}_{g,n}$, establishing the result.

The second step consists in showing that $H_{6g-6+2n-1}((\mathcal{M}_{g,n})^{S_n})$ is zero. In fact, a stronger result is true: the homology $H_{6g-6+2n-1}(\mathcal{M}_{g,n})$ vanishes for all spaces except for $(g,n) = (0,4)$.

This is shown by identifying $H_{6g-6+2n-1}(\mathcal{M}_{g,n})$, via Poincare duality, with the first cohomology class $H^1(\overline{\mathcal{M}}_{g,n}, \overline{\mathcal{M}}_{g,n}/\mathcal{M}_{g,n})$ of the compactified moduli spaces, relative to the nodal surfaces in the compactification. An exact sequence of relative cohomology groups leads to the desired result. This means that the homology $H_{6g-6+2n-1}((\mathcal{M}_{g,n})^{S_n})$ vanishes as well for these spaces.

In the case of the four-punctured sphere $(g, n) = (0, 4)$, the unrestricted one-dimensional homology group $H_1(\mathcal{M}_{0,4})$ does not vanish, but the S_4 -invariant subgroup does. This is intuitively clear: the first homology group of $\mathcal{M}_{0,4}$ is two dimensional, with representative cycles where the last marked point z_4 moves around 0 (the location of z_1) or moves around 1 (the location of z_2). This is clear: for each of these cycles there is no region of the sphere without a puncture for which the cycle is a boundary. There is no independent cycle where z_4 moves around the point at ∞ (the location of z_3). On the other hand a symmetrized cycle would have to be symmetric also under the S_3 subgroup of S_4 that permutes the first three punctures. This cycle would require three closed curves: one around 0, one around 1, and one around ∞ . They can be chosen not to intersect. It is clear then that there is a region for which this cycle is a boundary, showing that the symmetric homology group vanishes.

Similar results for open-closed bosonic string theory have been discussed in [109] and in heterotic string theory and superstring theory have been discussed in [110].

7.6 Uniqueness of string vertices up to canonical transformations

Solutions of the master equation $\Delta S + \frac{1}{2}\{S, S\} = 0$ are not unique. The infinitesimal canonical transformation

$$\delta S = \Delta \epsilon + \{S, \epsilon\}, \quad (7.44)$$

leaves the master equation unchanged to order ϵ . This new action is equivalent to the original one. We now show that solutions of the geometric BV master equation are also not unique in a similar way. There is a notion of a canonical transformation of the vertex \mathcal{V} that generates a new vertex that also satisfies the geometric master equation. This is relatively simple to verify for infinitesimal canonical transformations, as we do now.

If we have some collection of $(6g - 6 + 2n + 1)$ -chains $\mathcal{W}_{g,n}$ of $\widehat{\mathcal{P}}_{g,n}$, then we can vary the string vertices $\mathcal{V}_{g,n}$ by

$$\delta_{\mathcal{W}} \mathcal{V} = \{\mathcal{V}, \mathcal{W}\} + \Delta \mathcal{W} + \partial \mathcal{W}, \quad (7.45)$$

where, as before, $\mathcal{V} = \sum g_s^{2g+n-2} \mathcal{V}_{g,n}$, $\mathcal{W} = \sum g_s^{2g-n+2} \mathcal{W}_{g,n}$. We claim that the new vertices, obtained by the canonical transformation,

$$\mathcal{V} + \delta_{\mathcal{W}} \mathcal{V} \quad (7.46)$$

satisfy the quantum master equation, to leading order in $\delta_{\mathcal{W}} \mathcal{V}$:²³

$$\begin{aligned} & \frac{1}{2}\{\mathcal{V} + \delta_{\mathcal{W}} \mathcal{V}, \mathcal{V} + \delta_{\mathcal{W}} \mathcal{V}\} + \Delta(\mathcal{V} + \delta_{\mathcal{W}} \mathcal{V}) + \partial(\mathcal{V} + \delta_{\mathcal{W}} \mathcal{V}) \\ & = \{\partial \mathcal{V} + \Delta \mathcal{V} + \frac{1}{2}\{\mathcal{V}, \mathcal{V}\}, \mathcal{W}\} + O((\delta_{\mathcal{W}} \mathcal{V})^2) = 0. \end{aligned} \quad (7.47)$$

Two sets of string vertices which are related by geometric canonical transformations like this yield string field actions related by canonical transformation. Indeed, recalling that $S_{\mathcal{V}} = S_{0,2} + f(\mathcal{V})$, it now follows from that

$$\begin{aligned} S_{\mathcal{V} + \delta_{\mathcal{W}} \mathcal{V}} & = S_{\mathcal{V}} + f(\delta_{\mathcal{W}} \mathcal{V}) = S_{\mathcal{V}} + f(\{\mathcal{V}, \mathcal{W}\} + \Delta \mathcal{W} + \partial \mathcal{W}) \\ & = S_{\mathcal{V}} - \{f(\mathcal{V}), f(\mathcal{W})\} - \Delta f(\mathcal{W}) - \{S_{0,2}, \mathcal{W}\} \\ & = S_{\mathcal{V}} - \{S_{\mathcal{V}}, f(\mathcal{W})\} - \Delta f(\mathcal{W}). \end{aligned} \quad (7.48)$$

²³Useful identities $\Delta\{X, Y\} = \{\Delta X, Y\} + (-1)^{X+1}\{X, \Delta Y\}$ and $(-1)^{(X_1+1)(X_3+1)}\{\{X_1, X_2\}, X_3\} + \text{cyclic} = 0$. All ∂, Δ , and $\{\cdot, \cdot\}$ change degree by one unit.

We see that the variation of the action fits the structure shown in (7.44), with $\epsilon = -f(\mathcal{W})$, showing that the action for the new vertices is obtained by an infinitesimal canonical transformation of the original action.

The converse of the above results are important. We showed that an infinitesimal canonical transformation of \mathcal{V} yields a vertex that also satisfies the master equation. It is possible to show that given any two solutions of \mathcal{V} and \mathcal{V}' of the BV master equation, one can construct a *large* canonical transformation that relates the two [34]. The setup for the proof is as follows.

As a first step, we define ‘large’ canonical transformations as some kind of exponential of small ones. Let \mathcal{V} be a set of string vertices, and \mathcal{W} a collection $\mathcal{W}_{g,n}$ of $(6g - 6 + 2n + 1)$ -dimensional S_n -invariant singular chains in $\widehat{\mathcal{P}}_{g,n}$ which define an infinitesimal canonical transformation. We define a family $\mathcal{V}(t)$ of string vertices by requiring $\mathcal{V}(0) = \mathcal{V}$ and demanding that they satisfy the differential equation

$$\frac{d}{dt}\mathcal{V}(t) = \delta_{\mathcal{W}}\mathcal{V}(t), \quad (7.49)$$

where $\delta_{\mathcal{W}}\mathcal{V}$ was defined above. If \mathcal{V} satisfies the master equation, so does $\mathcal{V}(t)$ for all t . To show this, we write the master equation for $\mathcal{V}(t)$ in the form $M_{\mathcal{V}}(t) = 0$ by defining

$$M_{\mathcal{V}}(t) \equiv \partial\mathcal{V}(t) + \Delta\mathcal{V}(t) + \frac{1}{2}\{\mathcal{V}(t), \mathcal{V}(t)\}. \quad (7.50)$$

Clearly $M_{\mathcal{V}}(0) = 0$ since \mathcal{V} satisfies the master equation. A short calculation using the differential equation (7.49) shows that

$$\frac{dM_{\mathcal{V}}}{dt} = \{M_{\mathcal{V}}(t), \mathcal{W}\}. \quad (7.51)$$

This equation implies that if $M_{\mathcal{V}}(0) = 0$ all derivatives of $M_{\mathcal{V}}(t)$ will vanish at $t = 0$. This shows $M_{\mathcal{V}}(t)$ vanishes at all t . We write the solution of (7.49) for the instantaneous vertices by taking multiple derivatives, evaluating at $t = 0$, and writing the Taylor series. One finds

$$\mathcal{V}(t) = \mathcal{V} + t\delta_{\mathcal{W}}\mathcal{V} + \frac{1}{2}t^2\{\delta_{\mathcal{W}}\mathcal{V}, \mathcal{W}\} + \frac{1}{3!}t^3\{\{\delta_{\mathcal{W}}\mathcal{V}, \mathcal{W}\}, \mathcal{W}\} + \dots. \quad (7.52)$$

We *define* the exponential of the canonical transformation via $\exp(t\delta_{\mathcal{W}})\mathcal{V} \equiv \mathcal{V}(t)$. Note that the series solution does not fit the naive expansion of the exponential; we do not encounter nor define iterated variations $\delta_{\mathcal{W}}\delta_{\mathcal{W}}\mathcal{V}$. The definition implies that

$$\exp(\delta_{\mathcal{W}})\mathcal{V} \equiv \mathcal{V} + \delta_{\mathcal{W}}\mathcal{V} + \frac{1}{2}\{\delta_{\mathcal{W}}\mathcal{V}, \mathcal{W}\} + \frac{1}{3!}\{\{\delta_{\mathcal{W}}\mathcal{V}, \mathcal{W}\}, \mathcal{W}\} + \dots. \quad (7.53)$$

Having defined large canonical transformations, the uniqueness of vertices is argued as follows. Suppose that $\mathcal{V}_{g,n}$ and $\mathcal{V}'_{g,n}$ are two sets of string vertices, both of which satisfy the master equation. The goal is to show that there exists a sequence of S_n -invariant singular chains $\mathcal{W}_{g,n}$ such that their exponentiation—a large canonical transformation—relates the two sets of vertices

$$\exp(\delta_{\mathcal{W}})\mathcal{V} = \mathcal{V}'. \quad (7.54)$$

The construction of \mathcal{W} is done by induction (for details see [34], section 2.3). The initial step deals with the lowest genus zero vertex, the three punctured sphere. Here $\mathcal{V}_{0,3}$ and $\mathcal{V}'_{0,3}$ are both S_3 invariant points in $\widehat{\mathcal{P}}_{0,3}$. Since this space is connected, we let $\mathcal{W}_{0,3}$ be a S_3 -invariant path connecting $\mathcal{V}_{0,3}$ to $\mathcal{V}'_{0,3}$. Viewing $\mathcal{W}_{0,3}$ as a one-chain, we have $\partial\mathcal{W}_{0,3} = \mathcal{V}'_{0,3} - \mathcal{V}_{0,3}$. This implies that we have satisfied (7.54) to leading order. The full induction argument is a bit intricate and uses the vanishing of the homology groups $H_{6g-6+2n}(\widehat{\mathcal{P}}_{g,n})$ for all (g, n) except $(0, 3)$.

$$\partial \begin{pmatrix} g, b \\ n_c, n_o \end{pmatrix} = - \begin{pmatrix} g-1, b \\ n_c+2, n_o \end{pmatrix} - \begin{pmatrix} g, b-1 \\ n_c, n_o+2 \end{pmatrix} - \begin{pmatrix} g-1, b+1 \\ n_c, n_o+2 \end{pmatrix}$$

$$-\frac{1}{2} \begin{pmatrix} g_1, b_1 \\ n_{c1}, n_{o1} \end{pmatrix} \text{---} \begin{pmatrix} g_2, b_2 \\ n_{c2}, n_{o2} \end{pmatrix}$$

$$-\frac{1}{2} \begin{pmatrix} g_1, b_1 \\ n_{c1}, n_{o1} \end{pmatrix} \text{---} \begin{pmatrix} g_2, b_2 \\ n_{c2}, n_{o2} \end{pmatrix}$$

$$(b_1 + b_2 = b + 1)$$

Figure 5: The boundary of a general open-closed vertex coincides with a closed string Δ operator acting on a vertex, two types of open string Δ operators acting on vertices, and closed and open antibrackets of vertices. Wavy lines represent gluing of closed string punctures, continuous lines represent gluing of open string punctures. The heavy dots represent open string boundaries, and external open and closed states are not shown.

7.7 Open-closed vertices and their main identity

The main geometric identity for open-closed string field theory was given in (4.60). The pictorial representation is given in Figure 5, where, on the first line we show the three ways in which two punctures on the same surface can be glued together via the complete Δ operator. This includes Δ_c for closed strings, Δ'_o for open strings on the same boundary component, and Δ_o for open string on different boundary components. The closed string anti-bracket and the open string anti-bracket are on the second and third lines, respectively.

The various open-closed vertices are combined to form the open closed chain \mathcal{V} as follows

$$\mathcal{V} = \sum_{g,b,n_c,n_o} (g_s)^{-\chi_{g,b,n_c,n_o}} \mathcal{V}_{g,b,n_c,n_o}, \quad (7.55)$$

with $\chi_{g,b,n_c,n_o} = 2 - 2g - n_c - b - \frac{1}{2}n_o$, the Euler number of the surfaces in the associated vertex. The surfaces appearing in the above sum are those for which the Euler number is negative, with the exception of the disk with one closed string puncture and the annulus without punctures, both of which have Euler number zero.²⁴ Not included in \mathcal{V} are therefore the spheres ($g = b = 0$) with $n_c \leq 2$, the torus ($g = 1, b = 0$) with $n_c = 0$, both of which are not included in the pure closed string, and the disks ($g = 0, b = 1, n_c = 0$) with $n_o \leq 2$. The above open-closed chain satisfies the familiar

²⁴As in the case of purely closed string theory, the surfaces without punctures give constant contribution to the string field theory action and do not affect any physical quantity computed from the theory.

geometric master equation,

$$\partial\mathcal{V} + \Delta\mathcal{V} + \frac{1}{2}\{\mathcal{V}, \mathcal{V}\} = 0, \quad (7.56)$$

which is formally identical to the one considered for closed string theory. Here, of course, $\Delta = \Delta_c + \Delta'_o + \Delta_o$, as discussed above, and for the anti-bracket we have both closed and open sector contributions: $\{\cdot, \cdot\} = \{\cdot, \cdot\}_c + \{\cdot, \cdot\}_o$.

In this open-closed main identity, we can identify subsets of vertices that satisfy consistent sub-identities under the possible operations [9]. The first two below are ‘obvious’, the others less so.

1. Pure closed string theory. Setting $b = n_o = 0$ in (7.55) we get a chain \mathcal{V}_c containing all closed string vertices that satisfies

$$\partial\mathcal{V}_c + \Delta\mathcal{V}_c + \frac{1}{2}\{\mathcal{V}_c, \mathcal{V}_c\}_c = 0. \quad (7.57)$$

Note that no anti-bracket or delta operation on surfaces with boundaries can produce a surface without boundaries. The chain of classical closed string vertices $\hat{\mathcal{V}}_c = \sum_{n=3}^{\infty} (g_s)^{n-2} \mathcal{V}_{0,n,0,0}$ satisfies

$$\partial\hat{\mathcal{V}}_c + \frac{1}{2}\{\hat{\mathcal{V}}_c, \hat{\mathcal{V}}_c\}_c = 0. \quad (7.58)$$

2. Pure classical open string theory. Setting $g = 0, n_c = 0$ and $b = 1$ in (7.55) we get a chain \mathcal{V}_o that includes disks with three or more open string punctures. Note that the Δ operator in the open string sector cannot produce surfaces in this class: Δ'_o increases the number of boundaries and we cannot begin with $b = 0$, and Δ_o increases genus, so the genus cannot remain zero. It follows that we have

$$\partial\mathcal{V}_o + \frac{1}{2}\{\mathcal{V}_o, \mathcal{V}_o\}_o = 0. \quad (7.59)$$

3. \mathcal{V}_1 consisting of disks with $n_c = 1$ and $n_o \geq 0$. Here $\mathcal{V}_1 = \sum_{n_o=0}^{\infty} (g_s)^{\frac{1}{2}n_o} \mathcal{V}_{0,1,1,n_o}$. Inspection of Figure 5 shows that the boundary of this chain interacts with the classical open string chain \mathcal{V}_o as follows:

$$\partial\mathcal{V}_1 + \{\mathcal{V}_o, \mathcal{V}_1\}_o = 0. \quad (7.60)$$

4. \mathcal{V}_2 consisting of disks with $n_c = 2$ and $n_o \geq 0$. Here $\mathcal{V}_2 = \sum_{n_o=0}^{\infty} (g_s)^{1+\frac{1}{2}n_o} \mathcal{V}_{0,1,2,n_o}$. Inspection of Figure 5 shows that the boundary of this chain interacts with the classical open string chain \mathcal{V}_o , the chain \mathcal{V}_1 and the classical closed string three-vertex $\mathcal{V}_{0,3}$ as follows:

$$\partial\mathcal{V}_2 + \{\mathcal{V}_o, \mathcal{V}_2\}_o + \frac{1}{2}\{\mathcal{V}_1, \mathcal{V}_1\}_o + \{\mathcal{V}_1, \mathcal{V}_{0,3}\}_c = 0. \quad (7.61)$$

The recursion relations (7.60) and (7.61) can be used to discuss global symmetries of classical open string field theory generated by closed string states in the BRST cohomology [9]. An example is Poincare transformations. Such symmetries were first noted and explored by Hata and Nojiri in covariantized light-cone string field theories [111].

5. Define now a chain $\bar{\mathcal{V}}$ of disks with all allowed numbers of open and closed punctures:

$$\bar{\mathcal{V}} \equiv \mathcal{V}_o + \sum_{n=1}^{\infty} \mathcal{V}_n, \quad \mathcal{V}_n \equiv \sum_{n_o=0}^{\infty} (g_s)^{n+\frac{1}{2}n_o-1} \mathcal{V}_{0,1,n,n_o}. \quad (7.62)$$

Note that the definition of \mathcal{V}_n reproduces the earlier definitions for $n = 1, 2$. This time we find that the boundary of this chain mixes with the classical closed string chain $\hat{\mathcal{V}}_c$:

$$\partial\bar{\mathcal{V}} + \frac{1}{2}\{\bar{\mathcal{V}}, \bar{\mathcal{V}}\}_o + \{\bar{\mathcal{V}}, \hat{\mathcal{V}}_c\}_c = 0, \quad (7.63)$$

This relation allows the formulation of a classical open string field theory in a nontrivial closed string background. The action is written with the familiar kinetic term for the open string field plus all the interactions implicit in $\tilde{\mathcal{V}}$ with a closed string field Ψ_0 . The action has open string gauge invariance if Ψ_0 satisfies the classical closed string equations of motion [9].

6. A chain $\tilde{\mathcal{V}}$ that includes all genus zero surfaces with all numbers of boundary components ($b = 0, 1, \dots$) and all allowed numbers of open and closed string punctures:

$$\tilde{\mathcal{V}} = \sum_{n_c, b, n_o} (g_s)^{n_c + b + \frac{1}{2}n_o - 2} \mathcal{V}_{0, b, n_c, n_o}. \quad (7.64)$$

This chain, all by itself, satisfies a simple recursion relation:

$$\partial\tilde{\mathcal{V}} + \frac{1}{2}\{\tilde{\mathcal{V}}, \tilde{\mathcal{V}}\} + \Delta'_o\tilde{\mathcal{V}} = 0 \quad (7.65)$$

Here the antibracket is the full one, including the closed and open contributions. Note the action of Δ'_o in which open strings on the same boundary component are glued together. The other operator Δ_o does not feature as it increases the genus.

This recursion relation has been recently shown to be relevant to the description of the physics of N D-branes in the large N limit [105, 112].

The recursive approach to the construction of string vertices described in the existence proof in this section can be implemented for practical computations involving low-dimensional moduli spaces. One particularly useful set of vertices arises when the starting point, the vertices with no moduli, use local coordinates at the punctures that are related to the global coordinates on the sphere or the upper half plane via $SL(2, \mathbb{C})$ or $SL(2, \mathbb{R})$ maps (projective maps). In this case the construction of $\{\mathcal{V}, \mathcal{V}\}$ and $\Delta\mathcal{V}$ can be done by solving a set of algebraic equations (as opposed to differential equations for more general maps) and we can systematically proceed to construct higher order vertices. Examples of such constructions and their practical applications can be found in [87, 113–115]. As of now, however, there is no uniform description of all the \mathcal{V} 's with projective local coordinates even at genus zero. We shall now describe a few approaches that give uniform description of all the \mathcal{V} 's.

7.8 Minimal area string vertices: Witten vertex and closed string polyhedra

We now turn to the construction of string vertices. In this subsection we shall describe the construction based on the minimal area metric, focussing on the bosonic string theory. The most elementary vertex is the tree-level three point function. For open strings the vertex is a disk with three punctures on the boundary. It is instructive to compare this with closed strings for which the vertex is a sphere with three punctures. For the vertices that will be constructed in this subsection, the two are related. If we view the closed string vertex as a surface with three punctures located on the equatorial circle, the open string vertex can be defined by cutting the surface along that circle and keeping just, say, the northern hemisphere. This is now a disk with three boundary punctures. The local coordinates at the punctures are inherited from the local coordinates at the punctures of the closed string vertex.

We begin with the simplest case: bosonic open string field theory. The vertex constructed by Witten is a special case of the general class of the three open string vertices that we shall consider. As remarked earlier, Witten's open string field theory is cubic, i.e. this theory only needs a three-string vertex satisfying an associativity condition. We shall first describe this construction. The surface can be built by gluing together three half disks – the coordinate half-disks, or patches. These half disks

$\{|w_i| \leq 1, \text{Im } w_i \geq 0\}$, with $i = 1, 2, 3$, can be thought as the world-sheets of the three strings and are shown in the figure below. The points $w_i = 0$ are the punctures. The boundaries $|w_i| = 1$ of the

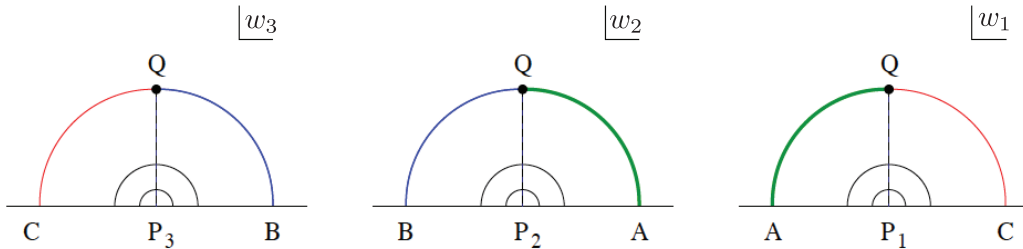

Figure 6: Three half disks representing open string world-sheets. The boundaries are glued as indicated by the color coding, resulting in a disk with three boundary punctures.

three disks are glued as indicated by the coloring of the figure and according to the identifications

$$\begin{aligned} w_1 w_2 &= -1, & \text{for } |w_1| = 1, \text{Re } w_1 \leq 0, \\ w_2 w_3 &= -1, & \text{for } |w_2| = 1, \text{Re } w_2 \leq 0, \\ w_3 w_1 &= -1, & \text{for } |w_3| = 1, \text{Re } w_3 \leq 0. \end{aligned} \tag{7.66}$$

Note that the common interaction point Q , at $w_i = i$ for all three disks, is the midpoint of each ‘open string’ $|w_i| = 1, \text{Im } w_i \geq 0$. The gluing prescription identifies the left half of string one with the right half of string two; the left half of string two with the right half of string three; the left half of string three with the right half of string one, forming a single disk with its boundary comprised by the union of the horizontal boundaries of the three disks.

It is useful to visualize the three open string vertex as a surface with a metric. For this note that we have, on the glued surface a Strebel quadratic differential φ that takes the form

$$\varphi = \phi(w_i) dw_i^2 = -\frac{1}{w_i^2} dw_i^2, \tag{7.67}$$

holding on each of the three coordinate patches. It is crucial that φ is defined globally, because the local expressions above are consistent with the gluing conditions $w_i w_{i+1} = -1$. The *horizontal trajectories*, the lines along which φ is real and positive, represent open strings – one sees that those are the sets $w_i = r e^{i\theta}$ with $r \leq 1$ fixed, and $\theta \in [0, \pi]$, so that $\varphi = (d\theta)^2$. In particular, for $r = 1$ these are the open strings that are being glued together. The quadratic differential has second order poles at the punctures $w_i = 0$, as can be seen directly from the above expression. The quadratic differential has a zero at Q , where three half-neighborhoods of the point i on the disks are glued. Indeed, a well-defined coordinate z vanishing at Q takes the form $z = (w_i - i)^{2/3}$. Therefore, near $w_i = i$, we have $\varphi \simeq dw_i^2 \sim z dz^2$, making the zero at $z = 0$ manifest.

A quadratic differential has a transformation law $\phi(z) dz^2 = \phi(w) dw^2$ under analytic changes of coordinates that implies the existence of a well defined conformal metric

$$ds^2 = |\phi(w_i)| |dw_i|^2. \tag{7.68}$$

If we write $w_i = e^{-T} e^{i\theta}$, the half disk corresponds to $T \in [0, \infty]$ and $\theta \in [0, \pi]$ with flat metric $ds^2 = dT^2 + d\theta^2$. This is a semi-infinite strip of width π . The string vertex can therefore be viewed as the joining of three such strips, with half-string identifications at the edges $T = 0, \theta \in [0, \pi]$. This

requires a bit of folding of the 3 strips along the locus of the open string midpoints. This is shown in Figure 7. We will later explain that this is a minimal area metric on this surface under the condition that any open curve with boundary endpoints, and homotopic to a puncture have length at least π . This picture of the three strips makes the associativity of the string vertex manifest. One can

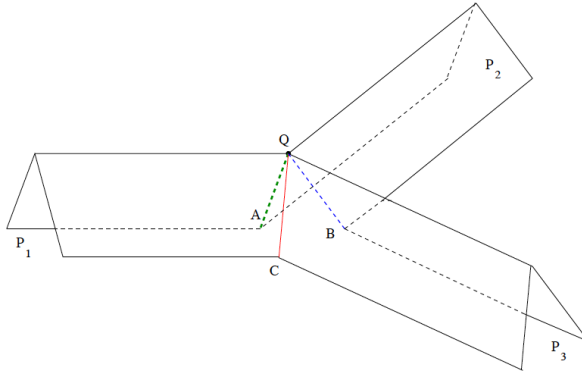

Figure 7: The associative open string vertex, with the half disks mapped into three semi-infinite strips.

view a product $A \star B$ of string fields as the insertion of the state A at the infinite end of one of the vertex strips and B at the infinite end of the strip next to the first. The product is read at the last strip. For nested products we simply add more strips in the same fashion, gluing half strings. Due to the associativity of the \star -product, we have $\{\mathcal{V}_3^o, \mathcal{V}_3^o\} = 0$, implying that there is no need for higher vertices in the classical theory. It also seems clear that $\Delta\mathcal{V}_3^o \neq 0$, the left-hand side being a singular surface. This means that the \mathcal{V}_3^o vertex is problematic at the quantum level [61].

For any explicit calculation of open string couplings we need the vertex described in terms of a single disk $|w| \leq 1$ with the three half-disks embedded inside it. This can be achieved with a sequence of conformal maps, with each half disk going into a 120° wedge of the unit disk. To map w_i to this wedge we first use an $SL(2, \mathbb{C})$ transformation

$$h(u) = \frac{1 + iu}{1 - iu}. \quad (7.69)$$

This maps the unit upper half disk $\{|u| < 1, \text{Im } u \geq 0\}$ to the ‘right’ half disk $\{|h| \leq 1, \text{Re } h \geq 0\}$. It is now simple to apply the h map to the w_i half disks to create the correct wedges by the power map $h^{2/3}$ and then to place the wedges properly in the w disk by global rotations. One then gets that the maps

$$w(w_1) = e^{2\pi i/3}(h(w_1))^{2/3}, \quad w(w_2) = (h(w_2))^{2/3}, \quad w(w_3) = e^{-2\pi i/3}(h(w_3))^{2/3}, \quad (7.70)$$

which indeed take the half disks into wedges fitting the w unit disk as shown in Figure 8 below. A final map to the upper half plane is also quite useful. This is done by composing the above functions with the map $z = h^{-1}(w) = -i\frac{w-1}{w+1}$ taking the unit w disk to the upper half plane, with the punctures on the real axis. We thus get

$$\begin{aligned} z = f_1(w_1) &= h^{-1}(w(w_1)) = \sqrt{3} + \frac{8}{3}w_1 + \frac{16}{9}\sqrt{3}w_1^2 + \frac{248}{81}w_1^3 + \mathcal{O}(w_1^4), \\ z = f_2(w_2) &= h^{-1}(w(w_2)) = \frac{2}{3}w_2 - \frac{10}{81}w_2^3 + \mathcal{O}(w_2^5), \\ z = f_3(w_3) &= h^{-1}(w(w_3)) = -\sqrt{3} + \frac{8}{3}w_3 - \frac{16}{9}\sqrt{3}w_3^2 + \frac{248}{81}w_3^3 + \mathcal{O}(w_3^4). \end{aligned} \quad (7.71)$$

We have included above the power series expansion of the local coordinates. These are needed for explicit calculations. The picture of the vertex in the z upper-half plane is shown below. The image

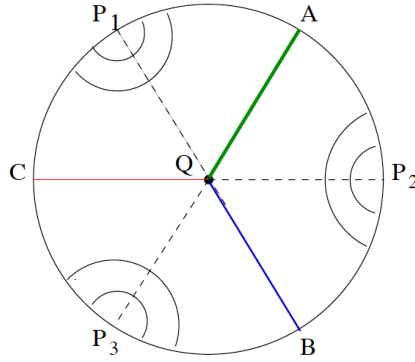

Figure 8: The associative open string vertex presented globally on a $|w| \leq 1$ disk with punctures at P_1, P_2, P_3 and common mid-point Q .

of the three half disks fill the upper half plane. The string midpoint Q now appears at $z = i$ (see Figure 9).

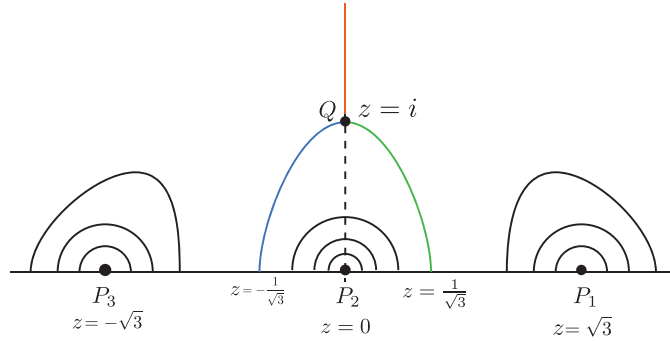

Figure 9: The associative open string vertex represented on the upper-half z -plane. The punctures now lie on the real line, and the three half disks cover the full upper-half plane.

For closed strings the three-string vertex is simply the open string vertex, as described by the above z upper-half plane, extended to the full z plane. The coordinates at the punctures are the same as well. One can visualize the closed string vertex as the result of gluing three semi-infinite cylinders of circumference 2π across the open surfaces. The gluing represents the doubling of the gluing of three semi-infinite strips for the open string vertex. The resulting picture is as shown below. As before, we have a Strebel quadratic differential on this surface, with second order poles at the three punctures. This time there are two zeroes of the quadratic differential, these are the two heavy dots in the figure, representing the location where the three boundaries of the semi-infinite cylinders meet.

As mentioned before we have $\partial\mathcal{V}_{0,4} = -\frac{1}{2}\{\mathcal{V}_{0,3}, \mathcal{V}_{0,3}\}$, and we must now understand what is the four-string vertex $\mathcal{V}_{0,4}$. Physically, the necessity for $\mathcal{V}_{0,4}$ arises because the three Feynman diagrams, formed using two copies of the vertex, do not provide a full cover of the moduli space of four-punctured spheres. These three diagrams are shown in Figure 11. The antibracket actually constructs the boundary of the Feynman regions covered by the three diagrams. If we place three of the labeled punctures at $0, 1$, and ∞ , the Feynman regions, shown in white in Figure 12, are disks around $0, 1$, and ∞ , with boundaries $\mathcal{B}_1, \mathcal{B}_2$, and \mathcal{B}_3 . The vertex $\mathcal{V}_{0,4}$ represents the shaded region of the moduli space. The darker shading shows a fundamental domain, such that the action of the

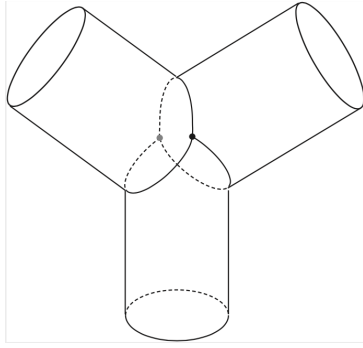

Figure 10: The closed string vertex in closed string field theory is obtained by gluing the edges of three identical semi-infinite cylinders.

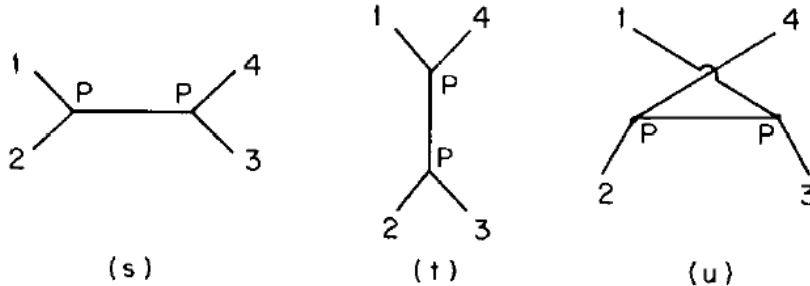

Figure 11: The three Feynman diagrams for four-string scattering, indicated as s, t, u channels.

$SL(2, \mathbb{C})$ transformations that permute the three fixed punctures at $0, 1, \infty$, produces the full shaded region. The local coordinates at the punctures are known over the \mathcal{B}_i sets, and the local coordinates over $\mathcal{V}_{0,4}$ must match these. We shall now describe a natural way to define the local coordinates over $\mathcal{V}_{0,4}$ and give a simple parameterization of the shaded region. Both of these issues can be addressed by considering a theorem of Strebel, showing the existence and uniqueness of a certain type of quadratic differentials. The relevant version of the theorem is easily understood [117, 118]

Any n -punctured Riemann surface can be built uniquely with n identical semi-infinite cylinders, by gluing their boundaries with some set of isometric identifications.

For convenience we will assume that the cylinders have circumference 2π . The resulting surface has a Strebel quadratic differential, which is equal to $\varphi = -\frac{1}{w_i^2} dw_i^2$ on each semi-infinite cylinder, described as the disk $|w_i| \leq 1$, punctured at $w_i = 0$. We can choose the w_i 's as the local coordinates as the punctures, producing a section of $\hat{\mathcal{P}}_{g,n}$. We shall see later that a part of this section for genus zero $\hat{\mathcal{P}}_{0,n}$ can be identified as the classical vertices $\mathcal{V}_{0,n}$. Note that, in fact, the vertex $\mathcal{V}_{0,3}$ was constructed in this fashion. Note also that the boundaries of the cylinders, once glued, define a *critical graph*; this graph has n faces, one for each cylinder, a number of vertices where φ vanishes, and a number of edges, each connecting a pair of vertices. One can see from Fig. 10 that for the three string vertex the critical graph has three faces, three edges and two vertices. If the Strebel differential is known, the local coordinates at the punctures are clearly fixed.

For $\mathcal{V}_{0,4}$, by Strebel's theorem, the surfaces are constructed with four cylinders. The graph indicating the identifications must have four faces. The zeroes of the quadratic differential are trivalent vertices in this graph. These zeroes are points of localized negative curvature, elsewhere the

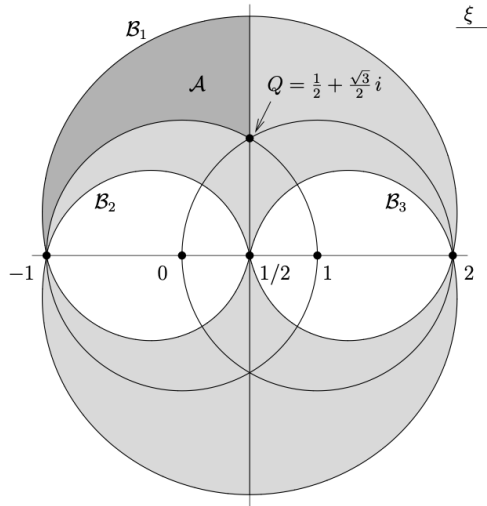

Figure 12: As calculated and plotted by Moeller [116], the shaded region on the ξ plane represents the string vertex $\mathcal{V}_{0,4}$. The boundaries \mathcal{B}_i are obtained from the Feynman region as the propagator length goes to zero.

metric is flat, though each puncture contributes to the total accounting of curvature in the Gauss-Bonnet formula. It turns out that the quadratic differential generically has four zeroes, and thus the critical graph has four vertices. A little thought reveals that the critical graph of Strebel differentials for $\mathcal{V}_{0,4}$ defines a tetrahedron. The graph is determined if we know the lengths of the edges of the tetrahedron. We have six edges and four length conditions, since the edges on each face must add up to 2π . This means two real parameters determine the unique quadratic differential – a fact consistent with $\mathcal{M}_{0,4}$ being a space of complex dimension one. We can work with three real parameters a, b, c that, representing the lengths of the three edges on a face, are all non-negative and add up to 2π : $a + b + c = 2\pi$. It is simple to see that, all four faces have edges of length $a, b,$ and c . Figure 13 shows the tetrahedra, with the two possible inequivalent ways of labeling the faces of the critical graph. For the second configuration we use parameters a', b', c' satisfying $a' + b' + c' = 2\pi$. One must now find

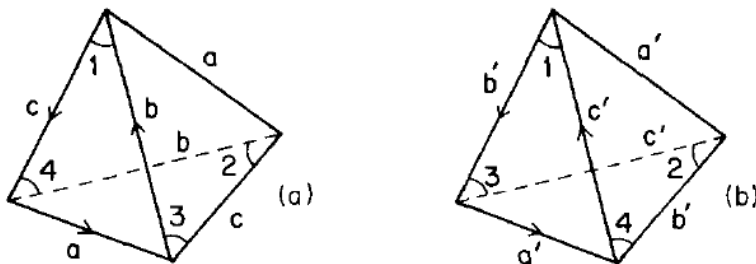

Figure 13: The edges of the four semi-infinite cylinders are glued to each other following the overlap patterns of the above tetrahedra, with one cylinder attached to each face.

the region of $\{a, b, c\}$ parameter space for $\mathcal{V}_{0,4}$. The full parameter space $a + b + c = a' + b' + c' = 2\pi$ would produce all surfaces in $\mathcal{M}_{0,4}$, so we must determine the restricted tetrahedra that correspond to $\mathcal{V}_{0,4}$. It is not difficult to track the tetrahedra obtained from $\{\mathcal{V}_{0,3}, \mathcal{V}_{0,3}\}$, thus determining the boundary of $\mathcal{V}_{0,4}$. In fact, since that tetrahedron comes from the gluing of two $\mathcal{V}_{0,3}$ and twisting, one finds that one length parameter becomes equal to π . It then becomes clear that the regions that

define $\mathcal{V}_{0,4}$ are

$$a, b, c \leq \pi, \quad a', b', c' \leq \pi. \quad (7.72)$$

The region is an interior triangle on the a, b, c parameter space, shown in purple in Figure 14. The other three triangles represent the Feynman regions. A simple change of viewpoint allows a simple

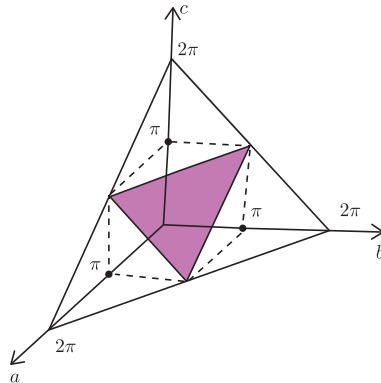

Figure 14: In the two-dimensional parameter space $a + b + c = 2\pi$ with $a, b, c \geq 0$, the vertex region is represented by the (purple) middle triangle.

characterization of the restricted tetrahedra. Consider closed paths, not homotopic to the punctures on the critical graph. On the left tetrahedron of Fig. 13, a path surrounding faces 1 and 2 has length $2(b + c)$. The condition $a \leq \pi$ implies $2\pi - (b + c) \leq \pi$, and thus $b + c \geq \pi$, or equivalently $2(b + c) \geq 2\pi$. The length condition makes this path longer or equal to 2π , the circumference of any cylinder. The length conditions (7.72) are in fact equivalent to the condition that all nontrivial closed paths on the critical graph must be longer than or equal to 2π .

This simple condition in fact works for all $\mathcal{V}_{0,n}$ with $n \geq 4$, that is, for all classical closed string interactions. Indeed, for any fixed n consider the graph with n faces, and introduce length parameters for the gluing of the n semi-infinite cylinder boundaries. We then have [118–120]

The surfaces in $\mathcal{V}_{0,n}$ are those for which the critical graph has no nontrivial closed path shorter than 2π . We call such critical graphs restricted polyhedra.

A relatively straightforward argument allows one to show that the geometric master equation is satisfied for this choice of vertices. There are two elements to that argument as one tries to establish the equality of $\{\mathcal{V}, \mathcal{V}\}$ and $\partial\mathcal{V}$. First, $\partial\mathcal{V} \subset \{\mathcal{V}, \mathcal{V}\}$ follows because the boundary of \mathcal{V} are polyhedra with some closed path reaching the critical length of 2π , and if we cut along this path we obtain two restricted polyhedra. Second, $\{\mathcal{V}, \mathcal{V}\} \subset \partial\mathcal{V}$, because when two restricted polyhedra are glued across a face, we get a restricted polyhedron – this is argued by showing that any closed path that now runs over the whole glued surface is still long enough.

While the regions $\mathcal{V}_{0,n}$ have a very elegant description, the explicit construction of the quadratic differentials is quite challenging. The cases of $\mathcal{V}_{0,4}$ and $\mathcal{V}_{0,5}$ have been considered in some detail by Moeller [116, 121]. A new approach to obtain these quadratic differentials based on machine learning has been recently introduced by Erbin and Firat [122] and could eventually help carry out computations for vertices $\mathcal{V}_{0,n}$ for much larger n . An approach based on Liouville conformal field theory to calculate quadratic differentials has been proposed in [123].

In the regions of moduli spaces not included in the \mathcal{V} vertices, the Strebel quadratic differential still can build the surface but the polyhedron has nontrivial closed paths with length smaller than

2π . The string field theory does not use these quadratic differentials. Instead, these surfaces are built using lower vertices and propagators. Consequently, the associated quadratic differential φ that determines the local coordinates w_i at the punctures via $\varphi = -dw_i^2/w_i^2$ and the condition that $|w_i| = 1$ at the end of the semi-infinite cylinder, is different. It is a Jenkins-Strebel quadratic differential – this means that horizontal trajectories fill the surface. In particular, the surface can contain ring domains, finite cylinders associated to propagators and foliated by horizontal trajectories. Since the propagators have circumference 2π , all nontrivial closed curves will be larger than 2π . Note that a Strebel differential is just a particular class of a Jenkins-Strebel differential.

In order to have a single principle that determines the full section $\mathcal{F}_{0,n}$ in $\widehat{\mathcal{P}}_{0,n}$ we turn to a minimal area problem. In fact this minimal area problem in principle determines the quantum vertices $\mathcal{V}_{g,n}$ and full sections $\mathcal{F}_{g,n}$ in $\widehat{\mathcal{P}}_{g,n}$ [124]:

Minimal area problem: Given a genus g Riemann surface with $n \geq 0$ punctures ($n \geq 3$ for $g = 0$, $n \geq 1$ for $g = 1$) find the metric of minimal (reduced) area under the condition that the length of any nontrivial homotopy closed curve be greater than or equal to 2π .

Here in this problem, a metric means a conformal metric, that is, one has a function ρ such that the length element is $ds = \rho|dz|$. Since the problem involves all nontrivial closed curves in a surface it is ‘modular invariant’ (the set of all nontrivial closed curves is invariant under large diffeomorphisms) and is independent of the labeling of the punctures, thus implementing naturally the symmetry under the exchange of punctures. It is simple to show that any solution to a minimal area problem is unique, this follows from the convexity of the area functional. Uniqueness is the reason we get a section in $\widehat{\mathcal{P}}_{g,n}$. In the minimal area metric one expects semi-infinite cylinders associated to the punctures. The term ‘reduced’ area is used because the area of the semi-infinite cylinders is infinite and requires regularization. One uses *fixed arbitrary* coordinates \tilde{w} around the punctures to remove small disks $|\tilde{w}| \leq \epsilon$ around the puncture and subtract off a logarithmic divergence $\sim -\log \epsilon$ in the area. Under a change of the arbitrary coordinates around the punctures, the reduced area changes by a metric independent constant. This implies that the extremal metric is regulator independent. The regulator also preserves the convexity of the area functional.

We can state what the vertices $\mathcal{V}_{g,n}$ are based on the expected properties of the minimal area metrics. All we need is an algorithm to decide if any surface $\Sigma_{g,n}$ is in $\mathcal{V}_{g,n}$. For this we use the minimal area metric on $\Sigma_{g,n}$ and inspect it searching for ring domains, or annuli, revealing the existence of propagators. A ring domain, or a cylinder of height greater or equal to 2π is declared to be a propagator. $\Sigma_{g,n} \in \mathcal{V}_{g,n}$ if the minimal area metric has no propagators. To fix the local coordinates on $\Sigma_{g,n}$ we look at the semi-infinite cylinders associated to the punctures. These cylinders are well defined in that it must end; there must be a ‘last’ geodesic homotopic to the puncture. That last geodesic must be retracted towards the puncture by a distance π , and this retracted curve becomes the coordinate curve for this puncture. This procedure effectively adds length π stubs to the surface. Equipped with such stubs, one can see that $\Delta\mathcal{V}$ will not produce surfaces with closed curves shorter than 2π : when gluing two coordinate curves in a given surface, the stubs already provide 2π length to any closed curve that goes through the created handle. In fact, we get a solution of the master equation for any stub length greater than π . In the string field theory the change of stub length is realized by a field redefinition. The longer the stub length, the Feynman diagrams produce less of the moduli space and the vertices produce more. Changing the stub length has an interpretation as a renormalization group transformation of the action [125].

We note that as long as we only work with classical closed string field theory, there is no need for

stubs – and the coordinate curves coincide with the faces of the polyhedron. A fair amount of work has been done with this version of the theory, including a somewhat inconclusive effort to identify a tachyon vacuum [63, 126]. It is the full quantum closed string field theory that requires stubs. This is made clear by considering $\Delta\mathcal{V}_{0,3}$, where two coordinate curves of the vertex are twist glued. Without stubs this produces singular surfaces [127]. With length π stubs all nontrivial closed curves remain longer than 2π and one can determine the quantum vertex $\mathcal{V}_{1,1}$ needed to satisfy the master equation.

While the minimal area metrics clearly exist for all genus zero surfaces and across large parts of the moduli space of non-zero genus surfaces, there is still no mathematical proof that they exist in all cases. Perhaps existence is just difficult to prove and the result will be established at some point. All minimal area metrics that arise from quadratic differentials are flat, except for negative curvature singularities at the zeroes of the differential. Moreover on any region of the surface there is just one band of geodesics saturating the length condition. For general surfaces, where the minimal area metric does not arise from a quadratic differential, it has also not been clear if bulk curvature can exist, or lines of curvature can exist. Moreover, it was expected that there would be regions of the surface foliated by multiple bands of geodesics.

Progress on the minimal area problem was made by M. Headrick and Zwiebach [128, 129], using the method of convex optimization. The original minimal-area problem was analyzed in terms of homology (as opposed to homotopy), using calibrations and the max flow - min cut theorem to formulate it as a *local* convex program that is easily implemented numerically. Moreover, a dual program, involving maximization of a concave functional was derived, providing lower bounds for the minimal area. These methods were applied to find (numerically) the minimal area metric for the once-punctured square torus. The solution displays regions covered by intersecting bands of length-saturating geodesics and exhibits both positive and negative bulk curvature. Further work to understand regions with multiple intersecting bands of geodesics was reported by Usman and Zwiebach [130]. It showed that a claim that regions with more than four such bands are flat is simply not true. All in all, these works provide evidence that minimal area metrics exist. The minimal area problem fits in the area of systolic geometry, where a number of important results have been established [131].

The minimal area problem can also be used for open string field theory and for open-closed string field theory. If we consider diagrams with only external open strings, we are looking at Riemann surfaces of all genus, with $b \geq 1$ boundaries and a number m of boundary punctures. One can show that the Witten classical open string field theory produces correctly all the moduli spaces because such diagrams are solutions of a minimal area problem: the surfaces have the minimal area under the condition that any open curve of nontrivial homotopy (and boundary endpoints) have length bigger or equal to π [68]. For open-closed string field theory we need to consider all genus surfaces with arbitrary numbers of open and closed string punctures. Here, a natural minimal area problem requires nontrivial open curves (with boundary endpoints) to be longer or equal to π while nontrivial closed curves are longer or equal to 2π . In writing out this theory one must add length π stubs to all vertices, including those of the open string, and for the boundary state vertex, which represents the one-point function of closed strings in a disk. Thus, the classical open string field theory subsector of the open-closed quantum theory is non-polynomial.

7.9 String vertices from hyperbolic metrics

Much is known about hyperbolic metrics on two dimensional surfaces, metrics of Gaussian curvature -1 . The moduli space of such metrics on an orientable surface of genus g and n punctures coincides with the moduli spaces of conformal structures on the surface, namely, with the moduli space $\mathcal{M}_{g,n}$ of Riemann surfaces – this is a version of the uniformization theorem [132]. It is also interesting to note that the surfaces that must be included in the definition of \mathcal{V} , as written out in equation (7.33), are precisely those for which hyperbolic metrics exist. Indeed, hyperbolic metrics do not exist for spheres with less than three punctures, and for tori without punctures. These facts motivated Pius and Moosavian to explore the construction of closed string field theory using hyperbolic metrics on Riemann surfaces [133, 134]. They considered surfaces with punctures, and that led to a complication. Such metrics have cusps on the punctures. Moreover the cutting and gluing of such metrics is not done along geodesics, and therefore it does not give a hyperbolic metric. These complications mean that the solution of the master equation is only approximate and must be improved.

In a somewhat different approach, Costello and Zwiebach [34] worked with surfaces of genus g and n *boundary* components, which allow for exact solutions of the master equation, as we will explain. On such surfaces we consider hyperbolic metrics in which the n boundaries are geodesics, all of length L . Given any such surface $\Sigma_{g,n}$ with its metric, there is an obvious *grafting* map gr_∞ that takes it to $\widehat{\mathcal{P}}_{g,n}$, that is, a map to the space of Riemann surfaces of genus g with n *punctures* and local coordinates at the punctures. The map

$$\text{gr}_\infty : \Sigma_{g,n} \rightarrow \widehat{\mathcal{P}}_{g,n}, \quad (7.73)$$

simply attaches semi-infinite cylinders of circumference L to each of the boundaries of the surface. The semi-infinite cylinders define the coordinate disks for the punctures in the resulting surface, the two related by the exponential map.

Let us call $\mathcal{M}_{g,n,L}$ the moduli space of hyperbolic metrics on a surface of genus g with n geodesic boundaries, all of length L . The grafting map, followed by the map π forgetting coordinates is then a map

$$\pi \circ \text{gr}_\infty : \mathcal{M}_{g,n,L} \rightarrow \mathcal{M}_{g,n}. \quad (7.74)$$

It is a theorem that this map is in fact a homomorphism, a one-to-one onto map. By considering all the hyperbolic metrics on a genus g surface with n geodesic boundary components we have created a cover of moduli space!

The simplest example of this is $\mathcal{M}_{0,3,L}$, the moduli space of hyperbolic metrics on a sphere with three holes. The hyperbolic metric here is unique, so this moduli space is just a point. This is the familiar pants diagram shown in Figure 15, with the dotted lines representing the flat cylinders that could be attached to the boundaries to create the surface $\mathcal{V}_{0,3} \in \widehat{\mathcal{P}}_{0,3}$. As we will see below this is the closed string vertex for a hyperbolic string field theory.

To proceed, we need one more definition. For a surface Σ with boundaries and equipped with a metric, the *systole* of Σ , called $\text{sys } \Sigma$, is the length of the shortest non-contractible closed geodesic which is not a boundary component. If we have a surface with no geodesics, except for the boundary geodesics of length L , the systole is declared to be L . In general, for a surface in $\mathcal{M}_{g,n,L}$ the systole can be larger than L , equal to L , if the shortest curve which is not a boundary has length exactly equal to the boundary, or shorter than L .

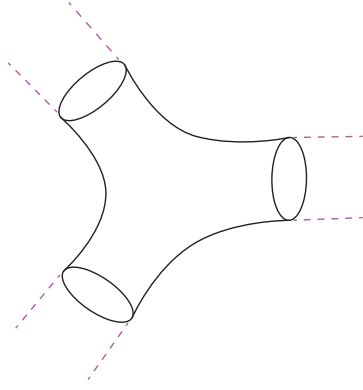

Figure 15: A sketch of a hyperbolic three-closed string vertex. The boundaries are geodesics of equal lengths.

On $\mathcal{M}_{g,n,L}$ we can now select a subset $\tilde{\mathcal{V}}_{g,n}(L)$ that includes those surfaces where the systole is larger than or equal to L :

$$\tilde{\mathcal{V}}_{g,n}(L) \equiv \{\Sigma \in \mathcal{M}_{g,n,L} \mid \text{sys } \Sigma \geq L\}. \quad (7.75)$$

Since the boundary geodesics are of length L the above sets include all surfaces that have no geodesic of length less than L . Even if there are no boundaries ($n = 0$), the definition is sensible: here $\mathcal{M}_{g,0,L} = \mathcal{M}_{g,0}$ and the above defines a certain subset of $\mathcal{M}_{g,0}$. For $\mathcal{M}_{0,3,L}$ the selected subset is a single surface, the pants diagram with boundaries of length L .

The string vertices $\mathcal{V}_{g,n}(L)$ are now defined as the sets $\tilde{\mathcal{V}}_{g,n}(L)$ grafted with semi-infinite cylinders to turn the boundaries into punctures with local coordinates:

$$\mathcal{V}_{g,n}(L) \equiv \text{gr}_\infty(\tilde{\mathcal{V}}_{g,n}(L)). \quad (7.76)$$

The main result of [34] is now simple to state:

The sets $\mathcal{V}_{g,n}(L)$, with $L \leq L_ = 2 \sinh^{-1} 1$, solve the geometric master equation.*

This means we get a solution for boundary lengths that are bounded by the constant $L_* \simeq 1.76275$.

We will not go over the details of the proof that establishes the above result, but the intuition for it comes from familiar facts about collars in hyperbolic metrics (see, for example, [132]). Consider a simple closed geodesic γ on a Riemann surface. The collar $\mathcal{C}(\gamma)$ of width w about γ is the set of all points on the surface whose distance to the curve γ does not exceed $w/2$. For a geodesic on the interior of the surface, the collar extends to the two sides of it. For a geodesic boundary, the collar just extends to one side of it, so that its ‘width’ is in fact $w/2$. Given a collection of simple closed geodesics γ_i of length ℓ_i that do not intersect, we can consider collars of width w_i chosen such that

$$\sinh\left(\frac{1}{2}w_i\right) \sinh\left(\frac{1}{2}\ell_i\right) = 1. \quad (7.77)$$

It is a remarkable result in hyperbolic geometry that such collars are *disjoint* on the surface; they do not intersect! The collars are annuli that exist around each geodesic. The shorter the geodesic, the wider the collar. The width w of the collar equals the length ℓ of the geodesic when both factors in the above left-hand side are equal to one, that is for $\ell = L_* = 2 \sinh^{-1} 1$. It follows that for a geodesic of length $L < L_*$, its collar will have $w_L > L_* > L$, thus:

$$L \leq L_* \quad \rightarrow \quad w \geq L. \quad (7.78)$$

This is why the above subsets $\mathcal{V}_{g,n}(L)$ satisfy the master equation with $L \leq L_*$. In that case, the collars around the geodesic boundaries have width greater than $L/2$, so that when they are glued together, any nontrivial closed curve crossing the seam will have length greater than L , and thus the gluing will result on a surface on the vertex region. Furthermore, since the glued surface now has systole L , realized by the gluing curve, it lies on the boundary of the vertex region. As one can see, the collars here play the role of the stubs in the minimal area problem, whose role was to prevent the creation of short non-contractible closed curves upon gluing.

The above construction of the closed string vertices, is at this point, the only fully rigorous and explicit construction available. Given the wealth of results known about hyperbolic metrics, one would expect that in some way, hyperbolic string field theory could be tractable analytically.

This hyperbolic construction has been extended to open-closed string field theory by Cho [135]. The Riemann surfaces here have *borders*, geodesic closed curves of length L_c where we attach external closed string semi-infinite cylinders, *open-puncture boundaries*, geodesic segments of length L_o where we attach external open string semi-infinite strips, and just plain *boundaries* in the sense of open string theory. Moreover, where boundaries and open-puncture boundaries meet, they are orthogonal. The string vertices for any moduli space (with two exceptions noted below) are the surfaces for which the hyperbolic metric has closed curve systole exceeding or equal to L_c and open curve systole exceeding or equal to L_o . The closed curve systole was defined before. The open curve systole is the length of the shortest noncontractible open curve with endpoints on boundaries that is not itself an open-puncture boundary. For the vertices to satisfy the BV geometric master equation the values of L_c and L_o must satisfy the conditions

$$L_c \leq L'_*, \quad \text{and} \quad \sinh L_c \sinh L_o \leq 1. \quad (7.79)$$

The constant L'_* is defined by the condition $\sinh(L'_*/2) \sinh L'_* = 1$ giving $L'_* \simeq 1.21876$. One can see that for $L_o \leq L'_*/2$, all $L_c \leq L'_*$ work. For $L_o > L'_*/2$ the possible values of L_c have a smaller upper bound. The above rule for vertices does not apply for two moduli spaces: for the disk with one bulk puncture the vertex is just a circle of length L_c (the limit of a cylinder of circumference L_c and vanishing height, with a border and a boundary), and for the annulus without punctures there is no vertex.

The explicit calculation of the local coordinates of the hyperbolic three-string vertex has been done by Firat [136]. This allows for off-shell computations with this vertex. In fact the result gives the coordinates for a general hyperbolic pants diagram, that is, a sphere with three geodesic boundaries of different lengths. This is useful because the Teichmuller moduli space of hyperbolic surfaces has a nice decomposition in terms of the gluing of pants. The Liouville equation for the conformal factor of the metric on the three-holed sphere is solved for by relating it to the monodromy problem for a second order linear ordinary differential equation, a Fuchsian equation on the complex plane.

Hyperbolic vertices for closed string field theory have an interesting limit. As long as we focus on the genus zero theory, the condition $L < L_*$ is not really required and L can be taken as large as one wishes. In fact, when $L \rightarrow \infty$ they hyperbolic vertices approach, up to an overall constant scale factor, the polyhedral vertices of classical string field theory [34]. This has been exploited in [123], showing that indeed the Strebel quadratic differentials associated with the polyhedra arise from hyperbolic vertices as a WKB approximation applied to the Fuchsian equation. This allows for the computation of these quadratic differentials using the tools of Liouville conformal field theory, in particular, their conformal blocks.

Finally, for useful information derived about the properties of off-shell amplitudes in hyperbolic geometry see [133, 134].

7.10 String vertices for open superstring field theory

If we restrict ourselves to the NS sector of the classical open superstring field theory, the original proposal of [137] was to use a string field in the minus one picture, with the standard BRST operator for the kinetic term. The cubic interaction requires a picture changing operator adding one unit of picture number so that the total picture number in the correlator is equal to minus two, as required. Using the associative vertex the PCO was inserted at the string midpoint, but this leads to difficulties: associativity fails to hold as one gets a singular collision of two picture changing operators. While several ways to address this difficulty have been considered, a *canonical* way to insert picture changing operators that does not suffer from singularities was developed by Erler, Konopka and Sachs in [28, 59, 60]. The result is a consistent theory for the NS sector of classical open superstrings, the NS sector of classical heterotic strings, and the NS–NS sector of classical type II superstrings. Our focus here will be on the NS sector of open superstrings discussed in [59]. We will comment on the extension for heterotic strings and for type II superstrings.

For open superstring field theory, the idea is to begin with a series of bosonic open string products $b_{n+1}^{(0)}$, with $n \geq 0$, satisfying the A_∞ axioms. The superscript zero in the products indicates no insertion of picture changing operators; the subscript is the number of states going into the product. An explicit procedure using canonical insertions constructs a new series of open superstring products $b_{n+1}^{(n)}$. Here, the superscript indicates the extra picture number n carried by such insertions, which is appropriate for open superstring interactions of $n + 1$ NS fields, each of picture minus one. These products, by construction, still define an A_∞ algebra, and thus the open superstring action can be written as usual. For convenience of notation we use the ‘bold’ operators $\mathbf{b}_{n+1}^{(0)}$ and $\mathbf{b}_{n+1}^{(n)}$ to denote the extension of the products to act on the tensor co-algebra $T(\mathcal{H}_o)$ (see section 6.1). We define the formal sum of superstring products, an operator of degree one,

$$\mathbf{B}^{[0]}(t) = \sum_{n=0}^{\infty} t^n \mathbf{b}_{n+1}^{(n)}. \quad (7.80)$$

The use of the formal parameter t as opposed to just doing the sum of the products (as we did for open bosonic strings) will be convenient for the later discussion. The superscript [0] indicates that the number of picture changing operators is the correct one for the products, assuming an NS field of picture minus one. Thus the ‘zero’ deficit, denoted by the superscript. These vertices are consistent if they satisfy the A_∞ condition:

$$(\mathbf{B}^{[0]}(t))^2 = 0. \quad (7.81)$$

Additionally, we require that these vertices belong to the ‘small’ Hilbert space: acting on string fields killed by η_0 they give string field killed by η_0 . Defining the associated $\boldsymbol{\eta}_0$ operator acting on the tensor algebra this condition takes the form

$$\{\boldsymbol{\eta}_0, \mathbf{B}^{[0]}(t)\} = 0. \quad (7.82)$$

This just states that η_0 should be a derivation of the superstring products. Of course, η_0 is also a derivation of the bosonic string products; this means that $\{\eta_0, \mathbf{b}_n^{(0)}\} = 0$, for all $n \geq 1$. In order to solve for the $\mathbf{b}_{n+1}^{(n)}$ operators satisfying these conditions, one introduces a larger set of products of

various deficits, so that one can incorporate into a single framework the bosonic products of maximal deficit. For string products with picture number deficit m we have

$$\mathbf{B}^{[m]}(t) = \sum_{n=0}^{\infty} t^n \mathbf{b}_{m+n+1}^{(n)}, \quad m = 0, 1, \dots \quad (7.83)$$

In all generality, we now put together all such products,

$$\mathbf{B}(s, t) = \sum_{m=0}^{\infty} s^m \mathbf{B}^{[m]}(t) = \sum_{m,n=0}^{\infty} s^m t^n \mathbf{b}_{m+n+1}^{(n)}. \quad (7.84)$$

Note that $\mathbf{B}(0, t)$ is the superstring collection of products while $\mathbf{B}(s, 0) = \sum_m s^m \mathbf{b}_{m+1}^{(0)}$ is the bosonic string collection of products. Moreover, one introduces a set of Grassmann even operators $\boldsymbol{\mu}$ that change the picture numbers. We include variable number, greater or equal to two, of input string states and a variable number, greater or equal to one, of picture number insertions:

$$\boldsymbol{\mu}(s, t) = \sum_{m=0}^{\infty} s^m \boldsymbol{\mu}^{[m]}(t) = \sum_{m,n=0}^{\infty} s^m t^n \boldsymbol{\mu}_{m+n+2}^{(n+1)}. \quad (7.85)$$

At this point what is needed is guaranteed if the following equations hold:

$$\{\mathbf{B}(s, t), \mathbf{B}(s, t)\} = 0, \quad \text{and} \quad \{\boldsymbol{\eta}_0, \mathbf{B}(s, t)\} = 0. \quad (7.86)$$

For $t = 0$ these manifestly hold, because they are the constraints satisfied by the bosonic string products. For $s = 0$ these are the relations we need to hold for the superstring products. The insight of [59] is the proposal of a set of recursion relations expressed as a set of differential equations:

$$\frac{\partial}{\partial t} \mathbf{B}(s, t) = [\mathbf{B}(s, t), \boldsymbol{\mu}(s, t)], \quad \frac{\partial}{\partial s} \mathbf{B}(s, t) = [\boldsymbol{\eta}_0, \boldsymbol{\mu}(s, t)]. \quad (7.87)$$

These equations allow for a recursive solution that yields, at the end, the superstring vertices. But, more crucially, they guarantee that the required equations (7.86) hold. Indeed, this follows by taking the t derivatives of the left-hand sides of (7.86), and showing that given that these left-hand sides vanish for $t = 0$, they must vanish for all t . The algorithm to find a solution to these equations was described in [59].

We illustrate the recursive procedure with the lowest order case, the one fixing the first product $\mathbf{b}_2^{(1)}$ of the open superstring. Recalling that $\mathbf{b}_1^{(0)} = \mathbf{Q}$, we write

$$\mathbf{B}(s, t) = \mathbf{Q} + t \mathbf{b}_2^{(1)} + s \mathbf{b}_2^{(0)} + \dots, \quad \boldsymbol{\mu}(s, t) = \boldsymbol{\mu}_2^{(1)} + \dots \quad (7.88)$$

The two differential equations above give, to leading order, two equations

$$\mathbf{b}_2^{(1)} = [\mathbf{Q}, \boldsymbol{\mu}_2^{(1)}], \quad \mathbf{b}_2^{(0)} = [\boldsymbol{\eta}_0, \boldsymbol{\mu}_2^{(1)}]. \quad (7.89)$$

With a little trial and error, the solution for $\boldsymbol{\mu}_2^{(1)}$ can be written in terms of $\boldsymbol{\xi}_0$ and the product $\mathbf{b}_2^{(0)}$:

$$\boldsymbol{\mu}_2^{(1)} = \frac{1}{3}(\boldsymbol{\xi}_0 \mathbf{b}_2^{(0)} - \mathbf{b}_2^{(0)} \boldsymbol{\xi}_0). \quad (7.90)$$

As a two-product this is

$$\boldsymbol{\mu}_2^{(1)}(A \otimes B) = \frac{1}{3}(\boldsymbol{\xi}_0(A, B) - (\boldsymbol{\xi}_0 A, B) - (-1)^A(A, \boldsymbol{\xi}_0 B)). \quad (7.91)$$

This solution for $\mu_2^{(1)}$ is easily confirmed acting on two string fields A, B in the small Hilbert space:

$$\begin{aligned}
[\eta_0, \mu_2^{(1)}](A \otimes B) &= \eta_0 \mu_2^{(1)}(A \otimes B) \\
&= \frac{1}{3} \eta_0 (\xi_0(A, B) - (\xi_0 A, B) - (-1)^A(A, \xi_0 B)) \\
&= \frac{1}{3} (\eta_0 \xi_0(A, B) + (\eta_0 \xi_0 A, B) + (A, \eta_0 \xi_0 B)) \\
&= \frac{1}{3} ((A, B) + (A, B) + (A, B)) = (A, B) = \mathbf{b}_2^{(0)}(A \otimes B).
\end{aligned} \tag{7.92}$$

Finally, we can determine the superstring product

$$\begin{aligned}
(A, B)^* &\equiv \mathbf{b}_2^{(1)}(A \otimes B) = [\mathbf{Q}, \mu_2^{(1)}](A \otimes B) \\
&= \mathbf{Q} \mu_2^{(1)}(A \otimes B) - \mu_2^{(1)}(QA \otimes B) - (-1)^A \mu_2^{(1)}(A \otimes QB) \\
&= \frac{1}{3} Q (\xi_0(A, B) - (\xi_0 A, B) - (-1)^A(A, \xi_0 B)) \\
&\quad - \frac{1}{3} (\xi_0(QA, B) - (\xi_0 QA, B) + (-1)^A(QA, \xi_0 B)) \\
&\quad - \frac{1}{3} (-1)^A (\xi_0(A, QB) - (\xi_0 A, QB) - (-1)^A(A, \xi_0 QB)).
\end{aligned} \tag{7.93}$$

Using the derivation property of Q and $\{Q, \xi_0\} = \mathcal{X}_0$ we quickly get

$$(A, B)^* \equiv \frac{1}{3} (\mathcal{X}_0(A, B) + (\mathcal{X}_0 A, B) + (A, \mathcal{X}_0 B)). \tag{7.94}$$

The calculation of the next product $(A, B, C)^*$ follows a similar line, although it is computationally harder. The construction, however, guarantees that all the higher superstring products exist, are in the small Hilbert space, and satisfy the A_∞ relations. Since the construction guarantees that we get satisfactory vertices, the action takes the expected form. With an open NS string field Φ of ghost number one and picture number minus one, and in the small Hilbert space, the action is

$$S(\Phi) = \frac{1}{2} \langle \Phi, Q\Phi \rangle' + \sum_{n=1}^{\infty} \frac{1}{n+2} \langle \Phi, b_{n+1}^{(n)}(\Phi, \dots, \Phi) \rangle'. \tag{7.95}$$

It should be noted that for open strings the use of ξ_0 is not mandatory. It suffices to use an operator ξ whose anticommutator with η_0 is equal to one.

For heterotic string field theory, an almost identical procedure works. The bosonic closed string products form an L_∞ algebra and the heterotic closed string products, constructed with insertions on the bosonic products, also satisfy the L_∞ algebra while still living in the small Hilbert space. This time it is important to use ξ_0 , since the resulting \mathcal{X}_0 insertions commute with the operators b_0^- and L_0^- . As a result, the new products will still satisfy the required constraints $b_0^- = 0$ and $L_0^- = 0$. The expression for the second product is completely analogous to the one found above for open superstrings:

$$[A, B]^* \equiv \frac{1}{3} (\mathcal{X}_0[A, B] + [\mathcal{X}_0 A, B] + [A, \mathcal{X}_0 B]). \tag{7.96}$$

Here $[A, B]$ is the original bosonic string product. For type II superstrings there are a couple of options in the way one treats left moving and right-moving pictures. Starting with the bosonic products, an asymmetric approach first raises by recursion the left-moving picture number, and then raises the right-moving picture number. A more symmetric approach treats both picture numbers as equivalent. For more details, see [28].

A relation between this approach and the vertical integration introduced in section 3.2 has been discussed in [138]. Inclusion of Ramond sector in this construction is possible but needs some extra ingredients. Ref. [60] generalized the construction of open superstring field theory to describe equations of motion of the R-sector fields. While constructing an action along this line is also possible [139, 140], this requires inclusion of an extra free field as in section 4.2 or using a restricted vector space for Ramond sector fields as will be discussed in section 8.4. Generalizations of such construction to the Ramond sector of heterotic and type II string theory have also been discussed in [141–143].

7.11 Some subtleties in quantum closed superstring field theory

All constructions of $\mathcal{V}_{g,n}$ for bosonic string theory, as described in sections 7.8 and 7.9, have the property that the local coordinates vary continuously as we move in the moduli space. In other words $\mathcal{V}_{g,n}$ describes the piece of a submanifold of $\hat{\mathcal{P}}_{g,n}$. This may not be possible for open and/or closed superstring field theories due to the existence of spurious poles. As reviewed in §3.2, the only known systematic way of choosing the PCO locations as we move in the moduli space is to divide the moduli space into small chambers, choose PCO locations inside a given chamber avoiding spurious poles and then add suitable compensating terms at the boundary between the two chambers. Therefore the choice of $\mathcal{V}_{g,n}$ in string field theory should also reflect this. Given a choice of $(6g - 6 + 2n)$ dimensional subspace $\mathcal{V}_{g,n}$ of $\hat{\mathcal{P}}_{g,n}$ for the bosonic string field theory, we divide it into small chambers, and in each chamber choose the PCO locations such that we avoid the spurious poles. In the $(6g - 7 + 2n)$ dimensional boundary between two chambers we add vertical segments that interpolate between two sets of PCO locations on two sides of the boundary, but the vertical segments themselves must be a union of several segments so that along each of these segments only one PCO location changes. As discussed in §3.2, when such walls meet on a $(6g - 8 + 2n)$ dimensional subspace, we have to add new two dimensional vertical segments. This process continues until we have ensured that the union of the original chambers and the vertical segments fill a ball shaped region in $\hat{\mathcal{P}}_{g,n}$ with no gaps. The rules for carrying out the integrals along the vertical segments to construct the products $\{A_1, \dots, A_n\}$ is the same as for the construction of the amplitudes as discussed in §3.2.

There are however two more subtleties in this construction. First, we cannot construct $\mathcal{V}_{g,n}$ satisfying the geometric master equation (4.8) with a single choice of PCO locations in each chamber, since, as discussed above (4.28), the definition of Δ and $\{, \}$ in (4.8) now involves insertion of the operator \mathcal{G} which, in the R sector, involves averages of PCO locations. Therefore at least close to the boundaries, $\mathcal{V}_{g,n}$'s must also be chains that involve averages of subspaces of $\hat{\mathcal{P}}_{g,n}$. This is also necessary for the interaction vertices $\mathcal{V}_{g,n}$ to be symmetric under the exchange of external punctures. For example, even for the three-point function on the sphere with NS sector external punctures, where we need one PCO for the heterotic theory and one PCO each in the holomorphic and anti-holomorphic sector in type II theories, it is not possible to find a single location that remains invariant under the $SL(2, C)$ transformations that permute the three punctures. So we must take the averages of different choices of PCO locations.

The second subtlety arises as follows. Let us suppose that we have chosen the $\mathcal{V}_{g,n}$'s so that they do not contain spurious poles. Now if we construct a Feynman diagram by joining two of them by a propagator, then it gives a particular choice of PCO locations determined by the plumbing fixture rules. One can now ask: is the configuration of PCOs determined this way free from spurious singularities? Unless the answer is in the affirmative, we run into a problem since in string field

theory we do not have any freedom in choosing the PCO locations in part of $\widehat{\mathcal{P}}_{g,n}$ that is covered by Feynman diagrams with one or more propagators. They are fixed by the choice of PCO locations in the construction of the interaction vertices of the diagram. To answer this question, we need to examine the origin of spurious singularities in a Feynman diagram, assuming that the interaction vertices have been chosen avoiding the spurious poles. For this it will be useful to represent the contribution from such Feynman diagrams as in quantum field theory. In this case we need to sum over infinite number of fields that could propagate along each internal propagator of the Feynman diagram, and this sum could diverge. One can show that this is the source of potential spurious poles in the Feynman diagram. This can be remedied by choosing the local coordinates at the punctures that we use in the construction of $\mathcal{V}_{g,n}$ to have long stubs in the sense described in §7.8. In this case an external state of L_0 eigenvalue h attached to a vertex will produce a factor of λ^{-h} for some large number λ . Since for large h the number of states grow as $e^{C\sqrt{h}}$ for some constant C , we see that the sum over intermediate states in a Feynman diagram can be made convergent by taking λ to be large, and hence the Feynman diagrams with propagators will be free from spurious poles as long as the vertices $\mathcal{V}_{g,n}$ are constructed avoiding the spurious poles. For this argument it is important to ensure that the spectrum of L_0 eigenvalues is bounded from below and that for a given h there are only a finite number of fields so that the sum is finite. The first condition is satisfied by choosing the states in the -1 picture in the NS sector and the $-1/2$ or $-3/2$ picture in the R sector. Both $-1/2$ and $-3/2$ picture R sector states have infinite degeneracies due to the existence of bosonic zero modes γ_0 and β_0 respectively, causing apparent violation of the second condition. However insertion of \mathcal{X}_0 in the R sector propagator guarantees that the matrix element of \mathcal{X}_0 between a pair of states is non-zero only for a finite number of states for any given L_0 eigenvalue [15]. This way the second condition is also satisfied.

8 Superstring field theories in the large Hilbert space

One of the issues we face in the construction of the interaction vertices for superstring field theories is in the choice of the locations of the picture changing operators. While the principle underlying the choice of picture changing operators is known, explicit constructions are more difficult. In this section we shall describe a way to get around this issue by working in the large Hilbert space where we do not require the string field to be annihilated by η_0 . In that case we can write down the gauge invariant string field theory action in terms of the same products that appear in the construction of A_∞ or L_∞ algebras underlying the bosonic open or closed string field theories. The price we pay is that the covering of the moduli space by the sum over Feynman diagrams is no longer obvious, it requires extra effort to establish this.

All our discussion here will be restricted to the tree-level string field theories. We will consider classical open superstrings in the NS sector, classical heterotic strings in the NS sector, and classical type II strings in the NS-NS sector. We conclude with a brief discussion of the Ramond sector of classical open superstrings.

8.1 Berkovits open superstring field theory in the NS sector

The conventional BRST quantization of the open superstring considers states $|\phi\rangle$ that are killed by the BRST operator: $Q|\phi\rangle = 0$. The familiar physical state representatives in the NS sector take the schematic form $|\phi\rangle = c e^{-\phi} V_M(0)|0\rangle$, with V_M a matter operator that is a dimension one-

half primary, $e^{-\phi}$ a dimension one-half primary, and c a dimension minus one primary, all for a dimension zero state. It follows that $|\phi\rangle$ has ghost number one and picture number minus one, the standard assignments of ghost and picture numbers for a NS string field. Correlators on the disk are nonvanishing unless the total picture number of the operators adds to minus two and the ghost numbers add up to three. This means that a kinetic term of the form $\langle\phi, Q\phi\rangle$ is allowed, but a cubic interaction of the string field requires the insertion of a PCO, an operator of ghost number zero and picture number plus one, to get the picture number to work out. As discussed in section 7.10, if one tries to use the associative open string vertex to build the string field action, this approach runs into some complications with collision of PCO's but using more general non-associative vertices a classical theory can be formulated.

Now we discuss a different approach leading to an action without any explicit picture changing operators. This can be done by working in the 'large' Hilbert space of the β, γ conformal field theory. Recall that while 'fermionizing' the β, γ system via $\beta = \partial\xi e^{-\phi}$ and $\gamma = \eta e^{\phi}$, the field ξ appears under a derivative, and thus its zero mode ξ_0 does not feature in the construction of the β, γ fields. Working on the large Hilbert space amounts to including explicitly the anticommuting zero mode operator ξ_0 among the list of operators, thus immediately doubling the number of basis states. In this context, the conventional Hilbert space is called the 'small' Hilbert space, to distinguish it from the 'large' Hilbert space that includes states obtained by the action of ξ_0 on the small Hilbert space. We note that ξ_0 and the zero mode η_0 of the η field satisfy the anticommutator relation

$$\{\eta_0, \xi_0\} = 1. \quad (8.1)$$

The states in the small Hilbert space are those annihilated by η_0 . Of course, the large Hilbert space contains the small Hilbert space as a nontrivial subspace. The BRST operator Q and the η_0 operator are on similar footing in that $QQ = 0$ and $\eta_0\eta_0 = 0$. Moreover, they anticommute,

$$\{Q, \eta_0\} = 0, \quad (8.2)$$

and both have ghost number one. In the following table we indicate the conformal dimension, ghost number, and picture number of the various fields

	dim	gh #	pic #
ξ	0	-1	+1
η	1	1	-1
β	3/2	-1	0
γ	-1/2	+1	0
$\exp(q\phi)$	$-\frac{1}{2}q(q+2)$	0	q

As we will describe now, the NS open string field Φ to be used in the large Hilbert space SFT is Grassmann even, and has both *ghost number zero and picture number zero*. The construction of a fully gauge invariant interacting action is done in analogy to the construction of a Wess-Zumino-Witten theory of scalars on a two-dimensional compact space, nicely written when using complex coordinates z and \bar{z} . The role of the spatial derivatives ∂ and $\bar{\partial}$ is played in the string field theory by the operators Q and η_0 respectively. The action is given by

$$S = \frac{1}{2g^2} \left\langle\left\langle (e^{-\Phi}\eta_0e^{\Phi})(e^{-\Phi}Qe^{\Phi}) + \int_0^1 dt \Phi \{e^{-t\Phi}Qe^{t\Phi}, e^{-t\Phi}\eta_0e^{t\Phi}\} \right\rangle\right\rangle. \quad (8.3)$$

This action is defined by expanding all exponentials in formal Taylor series and preserving the order of operators, letting the multilinear function $\langle\langle \dots \rangle\rangle$ of an ordered set of operators be given by

$$\langle\langle A_1 \dots A_n \rangle\rangle = \left\langle h^{-1} \circ f_1^{(n)} \circ A_1(0) \dots h^{-1} \circ f_n^{(n)} \circ A_n(0) \right\rangle'_L, \quad n \geq 2, \quad (8.4)$$

where the functions $f_k^{(n)}(z)$, prescribing the conformal maps to insert the operators, are

$$f_1^{(n)}(z) = \left(\frac{1+iz}{1-iz} \right)^{2/n}, \quad f_k^{(n)}(z) = e^{2\pi i(k-1)/n} f_1^{(n)}(z), \quad k = 2, \dots, n, \quad (8.5)$$

and h^{-1} is the inverse of the map h defined in (7.69), taking the disk to the upper half plane. The subscript L on the correlator indicates that the upper half plane correlator in the definition of the multilinear product is computed in the large Hilbert space, where we have

$$\langle\langle \xi c \partial c \partial^2 c e^{-2\phi} \rangle\rangle'_L \neq 0, \quad (8.6)$$

telling us that for a nonvanishing correlator of a set of operators the total ghost number must add up to two and the total picture number must add up to minus one. Note that each term in the action has just one Q and one η_0 . This requires a string field of zero picture number and zero ghost number, so that each term has picture number minus one, due to the η_0 , and ghost number two, due to Q and η_0 .

The function $f_1^{(n)}$ maps the upper half disk $|z| \leq 1, \text{Im}(z) > 0$, to the wedge $|\text{Arg}(f_1^{(n)})| \leq \pi/n$, $|f_1^{(n)}| \leq 1$, of a full unit disk, with the puncture $z = 0$ mapped to $f_1^{(n)} = 1$. The maps with $k > 1$ are obtained by a simple rotation of the first wedge. All in all, n non-overlapping wedges, touching along radial lines fully fill the unit disk. This unit disk is further mapped to the upper half plane by the map h^{-1} . For $n = 2$ the multilinear function is in fact the BPZ inner product. For $n = 3$, it is the multilinear product of the associative open string vertex (compare with (7.70)). For $n > 3$, this multilinear map can be thought as an iterated product using the associative open string three-vertex:

$$\langle\langle A_1 \dots A_n \rangle\rangle = \langle A_1, A_2 \star A_3 \star \dots \star A_n \rangle'_L. \quad (8.7)$$

It is therefore cyclic.

One can show that the equation of motion from this nonlinear action takes a surprisingly simple form:

$$\eta_0(e^{-\Phi} Q e^{\Phi}) = 0, \quad (8.8)$$

where all products, obtained after expanding the exponentials, are to be regarded as the usual star product. Moreover, the action is invariant under gauge transformations with parameters Λ and Ω ,

$$\delta e^{\Phi} = (Q\Lambda)e^{\Phi} + e^{\Phi}(\eta_0\Omega). \quad (8.9)$$

The expansion of the action to cubic order (with Q and η_0 killing the constant term in the exponential) gives

$$S = \frac{1}{2g^2} \left\langle\left\langle \frac{1}{2}(Q\Phi)(\eta_0\Phi) + \frac{1}{6}(Q\Phi)(\Phi(\eta_0\Phi) - (\eta_0\Phi)\Phi) \right\rangle\right\rangle + \mathcal{O}(\Phi^3). \quad (8.10)$$

From the above expansion we see that the kinetic term takes the form

$$S_{\text{kin}} \sim \langle\langle (Q\Phi)(\eta_0\Phi) \rangle\rangle = \langle Q\Phi, \eta_0\Phi \rangle'_L, \quad (8.11)$$

with the bilinear function equal to the BPZ inner product. This means that the linearized equation of motion is

$$Q\eta_0|\Phi\rangle = 0. \quad (8.12)$$

Consistent with the full gauge transformations (8.9), we have *two* linearized gauge invariances:

$$\delta\Phi = Q|\Lambda\rangle, \quad \delta\Phi = \eta_0|\Omega\rangle. \quad (8.13)$$

To analyze the free field equation, we expand the string field relative to the zero mode ξ_0 :

$$|\Phi\rangle = |\phi'\rangle + \xi_0|\phi\rangle, \quad \text{with } \eta_0|\phi'\rangle = \eta_0|\phi\rangle = 0. \quad (8.14)$$

Here $|\Phi\rangle$ is in the large Hilbert space, while $|\phi\rangle$ and $|\phi'\rangle$ are in the small Hilbert space. The η_0 gauge symmetry is, explicitly

$$\delta|\Phi\rangle = \eta_0|\Omega\rangle = \eta_0(|\omega\rangle + \xi_0|\omega'\rangle) = |\omega'\rangle. \quad (8.15)$$

This can be used to gauge away $|\phi'\rangle$ in $|\Phi\rangle$ so that we have $|\Phi\rangle = \xi_0|\phi\rangle$. The equation of motion then becomes

$$0 = Q\eta_0|\Phi\rangle = Q\eta_0\xi_0|\phi\rangle = Q\{\eta_0, \xi_0\}|\phi\rangle = Q|\phi\rangle. \quad (8.16)$$

Since $|\phi\rangle$ is in the small NS Hilbert space and satisfies the familiar linearized field equation, we conclude that $|\phi\rangle$ is a state of ghost number one and picture number minus one. Given that the string field $|\Phi\rangle$ is obtained by acting with ξ_0 on $|\phi\rangle$ we have, as expected, that the large Hilbert space NS open string field Φ has ghost and picture number zero.

The NS sector open string field theory described here can be shown to be equivalent to the one described in section 7.10 after partial gauge fixing and appropriate field redefinition [144–147]. BRST quantization of this theory has been discussed in [148].

8.2 Heterotic string field theory in the NS sector

In this theory the holomorphic sector is the NS sector of open superstrings while the anti-holomorphic sector is that of a bosonic open string. We are thus effectively tensoring a string field that is Grassmann even and of ghost and picture number zero (NS large Hilbert space string field) with a string field that is Grassmann odd and of ghost number one (bosonic open string field). As a result, the heterotic string field V will be a *Grassmann odd string field of ghost number one and picture number zero*, annihilated by b_0^- and L_0^- . In vertex operator language, V for physical states would be represented by $\xi c\bar{c}V_M e^{-\phi}$, where V_M is a matter sector primary operator of dimension $(1, 1/2)$. This is clearly an operator carrying zero picture number and ghost number one.

The basic nonvanishing correlator in the large Hilbert space is now

$$\langle \xi c\partial c\bar{\partial}^2 c\bar{c}\bar{\partial}c\bar{\partial}^2 \bar{c} e^{-2\phi} \rangle_L \neq 0, \quad (8.17)$$

showing that operators with a non-vanishing correlator must have total ghost number five and total picture minus one. Since the closed string inner product $\langle A, B \rangle_L$ includes a c_0^- factor, a non-vanishing inner product requires the ghost numbers of A and B to add up to four, and the picture numbers to add up to minus one.

The tree-level action to cubic order in the string field V takes the form [25]:

$$S = 2 \left[\frac{1}{2} \langle \eta_0 V, QV \rangle_L + \frac{\kappa}{3!} \langle \eta_0 V, [V, QV]_0 \rangle_L \right] + \mathcal{O}(V^3), \quad (8.18)$$

where κ is related to g_s by a constant of proportionality that depends on the normalization in (8.17). In the above, the bracket $[\ , \]_0$ is the genus zero contribution to the product. Together with the higher genus zero products appearing below, they represent any consistent solution of the L_∞ axioms in closed bosonic string theory, *e.g.* the products constructed using the minimal area metric or hyperbolic metric. The kinetic term implies a linearized equation of motion $\eta_0 QV = 0$ with *linearized* gauge invariances

$$\delta V = Q\Lambda + \eta_0\Omega, \quad (8.19)$$

The construction of the full nonlinear action and its gauge transformations is somewhat involved. A key ingredient is the generalization of the structure $A_Q \equiv e^{-\Phi} Q e^\Phi$ appearing in the open superstring action. The insight comes from the observation that A_Q is a pure gauge configuration in bosonic open string theory: it is of ghost number one, to leading order it is $Q\Phi$ and it satisfies the cubic equation of motion $QA_Q + A_Q A_Q = 0$. The heterotic string field V of ghost number one and picture zero can play the role of a gauge parameter in bosonic closed string theory. Thus QV is the leading term of a pure gauge configuration in closed string field theory. To find the full nonlinear expression $G(V)$ of the pure gauge we introduce an integration parameter τ and the function $G(\tau V)$ that gives the desired $G(V)$ for $\tau = 1$ and vanishes for $\tau = 0$. Moreover, we require that $G(\tau V + d\tau V)$ and $G(\tau V)$ differ by a gauge transformation with parameter $d\tau V$ applied to $G(\tau V)$. Therefore,

$$G(\tau V + d\tau V) = G(\tau V) + Q(d\tau V) + \sum_{n=1}^{\infty} \frac{\kappa^n}{n!} [G(\tau V)^n, d\tau V]_0 + \mathcal{O}(d\tau^2). \quad (8.20)$$

This gives the differential equation

$$\partial_\tau G(\tau V) = QV + \sum_{n=1}^{\infty} \frac{\kappa^n}{n!} [G(\tau V)^n, V]_0. \quad (8.21)$$

This equation, written more schematically as

$$\partial_\tau G = QV + \kappa[G, V]_0 + \frac{\kappa^2}{2}[G, G, V]_0 + \mathcal{O}(\kappa^3) \quad (8.22)$$

can be solved in a power series expansion

$$G = G^{(0)} + \kappa G^{(1)} + \kappa^2 G^{(2)} + \mathcal{O}(\kappa^3). \quad (8.23)$$

The first few terms are quickly calculated

$$G(V) = QV + \frac{\kappa}{2}[V, QV]_0 + \frac{\kappa^2}{3!}([V, QV, QV]_0 + [V, [V, QV]_0]_0) + \mathcal{O}(\kappa^3). \quad (8.24)$$

Since $G(V)$ is obtained from 0 by a series of infinitesimal gauge transformations, it should be a pure gauge configuration. This can be confirmed by showing that $G(V)$ is a solution of the bosonic closed string field theory equation of motion $F(\Psi) = 0$. This is done by forming a first order linear differential equation for $F(G(\tau V))$, taking the form $\partial_\tau F(G(\tau V)) \sim F(G(\tau V))$. Since $G(\tau V)$ vanishes for $\tau = 0$ we also have $F(G(0)) = 0$ and by uniqueness, the solution of the differential equation is $F(G(\tau V)) = 0$. For $\tau = 1$ this is the claimed property.

The full nonlinear action can be written in a number of equivalent ways, useful for simple derivations of key properties. Perhaps the simplest form is as follows ([26], section 5)²⁵

$$S = 2 \int_0^1 dt \langle \eta_0 V, G(tV) \rangle_L. \quad (8.25)$$

²⁵A similarly simple form of the open string field theory action also exists, and is given in [26], section 2.2.

One can also determine the full nonlinear extensions of the linearized gauge transformations (8.19); for details see [26].

8.3 Type II string field theory in the NS–NS sector

For type II closed string field theory in the NS–NS sector, physical states in the large Hilbert space can be represented by operators of the form $\xi\bar{\xi}\bar{c}\bar{c}e^{-\phi}e^{-\bar{\phi}}V_M$ that have left-moving and right moving ghost numbers equal to zero as well as left-moving and right moving picture numbers equal to zero. Experience with bosonic closed string theory suggests that the string field must have simply zero ghost number, without imposing two separate conditions; the inner product, for example contains the factor c_0^- of indefinite left and right ghost numbers. On the other hand, it seems natural to fix separately the left and right picture numbers. Thus, *the Grassmann even string field Ψ will have ghost number zero and left and right picture numbers zero.*

The basic nonvanishing correlator for type II theory in the large Hilbert space is

$$\langle \xi\bar{\xi} c\bar{c}\partial\bar{\partial}^2 c \bar{c}\bar{\partial}\bar{c}\bar{\partial}^2 \bar{c} e^{-2\phi} e^{-2\bar{\phi}} \rangle_L \neq 0, \quad (8.26)$$

which means that for a nonvanishing correlator of several operators ghost numbers must add up to 4, and both left and right picture numbers must add up to minus one. Therefore, in the bilinear form $\langle A, B \rangle$, the ghost numbers of A and B must add up to three, and the left and right picture numbers must add up to minus one. The kinetic term for the theory consistent with these requirements is

$$S_2 = \frac{1}{2} \langle \eta_0 \Psi, Q \bar{\eta}_0 \Psi \rangle_L. \quad (8.27)$$

The linearized equation of motion is $\eta_0 \bar{\eta}_0 Q \Psi = 0$ with *linearized* gauge invariances

$$\delta \Psi = Q \Lambda + \eta_0 \Omega + \bar{\eta}_0 \bar{\Omega}. \quad (8.28)$$

We can expand the string field $|\Psi\rangle = |\psi_0\rangle + \xi_0 |\psi_1\rangle + \bar{\xi}_0 |\psi_2\rangle + \xi_0 \bar{\xi}_0 |\psi_3\rangle$ with $|\psi_i\rangle$, with $i = 0, \dots, 3$, in the small Hilbert space and thus annihilated by both η_0 and $\bar{\eta}_0$. The Ω gauge invariance can be used to set to zero $|\psi_0\rangle$ and $|\psi_2\rangle$. Then, the $\bar{\Omega}$ gauge invariance can be used to set $|\psi_1\rangle$ to zero. Thus we have $|\Psi\rangle = \xi_0 \bar{\xi}_0 |\psi_3\rangle$, with $|\psi_3\rangle$ in the small Hilbert space and in the minus one, minus one picture. The linearized equation of motion then implies $Q|\psi_3\rangle = 0$, as required.

The cubic term of this theory begins to show some of the complexity. One finds:

$$S_3 = \frac{1}{3!} \langle \eta_0 \Psi, [Q \bar{\eta}_0 \Psi, \bar{\eta}_0 \Psi]^* \rangle_L, \quad (8.29)$$

where the starred two-product must have an insertion of the PCO zero mode $\bar{\mathcal{X}}_0 = \{Q, \bar{\xi}_0\}$ to compensate for the presence of the two $\bar{\eta}_0$ factors. The $\bar{\mathcal{X}}_0$ is inserted on the three legs of the product:

$$[A, B]^* \equiv \frac{1}{3} (\bar{\mathcal{X}}_0 [A, B]_0 + [\bar{\mathcal{X}}_0 A, B]_0 + [A, \bar{\mathcal{X}}_0 B]_0). \quad (8.30)$$

Since $\{Q, \bar{\mathcal{X}}_0\} = 0$, we see that Q is a derivation of the starred product. Since $\{\eta_0, \bar{\mathcal{X}}_0\} = \{\bar{\eta}_0, \bar{\mathcal{X}}_0\} = 0$, both η_0 and $\bar{\eta}_0$ are derivations of the starred product. A full type II action was built by Matsunaga [27] and takes the form

$$S = \int_0^1 dt \langle \eta_0 \Psi_t, \mathcal{G}^*(\Psi(t)) \rangle_L. \quad (8.31)$$

Here, with $\Psi(t) = t\Psi$, we have that the NS–NS $\Psi_t = \Psi + \bar{\eta}_0(\dots)$

$$\Psi_t = \Psi + \frac{\kappa}{2} t [\bar{\eta}_0 \Psi, \Psi]^* + \mathcal{O}(\kappa^2), \quad (8.32)$$

and

$$\mathcal{G}^*(\Psi) = Q\bar{\eta}_0\Psi + \frac{\kappa}{2}t[Q\bar{\eta}_0\Psi, \bar{\eta}_0\Psi]^* + \mathcal{O}(\kappa^2). \quad (8.33)$$

The complete definition of $\mathcal{G}^*(\Psi)$ for the choice $\Psi(t) = t\Psi$ is as follows. Under an infinitesimal change $t \rightarrow t + \delta t$, $\mathcal{G}^*(\Psi(t + \delta t))$ is obtained from $\mathcal{G}^*(\Psi(t))$ by an infinitesimal gauge transformation with parameter $\delta t \bar{\eta}_0\Psi$ in the heterotic string field theory formulated in the *small* Hilbert space in the anti-holomorphic superstring sector. Recall that the string field for the small Hilbert space heterotic string is of ghost number two and picture number minus one. Indeed $(\bar{\eta}_0\Psi)$, playing the role of the gauge parameter in the above equation for \mathcal{G}^* , has ghost number one and picture number minus one. The computation of \mathcal{G}^* uses the L_∞ -type heterotic action discussed in [28], with starred products bearing $\bar{\mathcal{X}}_0$ insertions in rather intricate combinatoric patterns and satisfying the L_∞ constraint equations. The complete definition of Ψ_t is a bit more complicated but can be found in [27].

8.4 Open superstring field theory in the Ramond sector

So far the construction described in this section deals only with the NS sector of string field theory. At the classical level this is a consistent truncation of the full string field theory. Nevertheless even at the classical level, a complete construction of string field theory must include the Ramond sector. In this section we shall describe an extension of the open superstring field theory described in section 8.1 that includes the Ramond sector [29, 30].

The NS sector of this string field theory is identical to the one described in section 8.1. For introducing the Ramond sector fields, we shall work in the small Hilbert space. Let us recall some basic facts about the R-sector. The (β, γ) ghosts admit mode expansions

$$\beta(z) = \sum_{n \in \mathbb{Z}} \beta_n z^{-n-\frac{3}{2}}, \quad \gamma(z) = \sum_{n \in \mathbb{Z}} \gamma_n z^{-n+\frac{1}{2}}, \quad (8.34)$$

with the vacua $|-1/2\rangle = e^{-\phi/2}(0)|0\rangle$, $|-3/2\rangle = e^{-3\phi/2}(0)|0\rangle$ satisfying,

$$\beta_n|-1/2\rangle = 0 \text{ for } n \geq 0, \quad \gamma_n|-1/2\rangle = 0 \text{ for } n \geq 1. \quad (8.35)$$

We denote by G_0^m the zero mode of the matter sector superconformal generator and define,

$$X = -\delta(\beta_0)G_0^m + \delta'(\beta_0)b_0, \quad Y = -c_0\delta'(\gamma_0). \quad (8.36)$$

The R-sector string field Ψ is taken to be a state of ghost number 1 and picture number $-1/2$ subject to the restriction that Ψ must be of the form

$$\Psi = \phi - (\gamma_0 + 2c_0b_0\gamma_0 + c_0G_0^m)\psi, \quad (8.37)$$

with ϕ, ψ satisfying the constraints:

$$b_0\phi = 0, \quad \beta_0\phi = 0, \quad \eta_0\phi = 0, \quad b_0\psi = 0, \quad \beta_0\psi = 0, \quad \eta_0\psi = 0. \quad (8.38)$$

This condition on Ψ may also be expressed as

$$XY\Psi = \Psi, \quad \eta_0\Psi = 0, \quad (8.39)$$

where the second condition just expresses the fact that Ψ is in the small Hilbert space. We have written this condition explicitly since later we shall couple the R-sector fields to the NS sector fields and the latter belong to the large Hilbert space.

The quadratic term in the string field theory action in the R-sector is given by

$$S_R^{(0)} = -\frac{1}{2}\langle\Psi, YQ\Psi\rangle', \quad (8.40)$$

where the absence of the subscript L stands for the fact that the BPZ inner product is computed in the small Hilbert space. The action is invariant under the linearized gauge transformation,

$$\delta|\Psi\rangle = Q|\lambda\rangle, \quad (8.41)$$

where $|\lambda\rangle$ is a ghost number 1, picture number $-1/2$ operator, satisfying.

$$XY\lambda = \lambda, \quad \eta_0\lambda = 0. \quad (8.42)$$

The full interacting tree-level open string field theory involves the R-sector string field Ψ of ghost number one and picture number $-1/2$ in the small Hilbert space satisfying (8.39) and the NS sector string field Φ of ghost number zero and picture number zero in the large Hilbert space. The action is given by

$$S = -\frac{1}{2}\langle\Psi, YQ\Psi\rangle' - \int_0^1 dt \langle A_t(t), QA_\eta(t) + (F(t)\Psi)^2 \rangle'_L, \quad (8.43)$$

where

$$A_\eta(t) = \eta e^{\Phi(t)} e^{-\Phi(t)}, \quad A_t(t) = \partial_t e^{\Phi(t)} e^{-\Phi(t)}, \quad (8.44)$$

and

$$F(t)\Psi = \Theta(\beta_0)\{A_\eta(t), \Theta(\beta_0)\{A_\eta(t), \dots \Theta(\beta_0)\{A_\eta(t), \Psi\} \dots\}\}, \quad (8.45)$$

Θ denotes the Heaviside function and $\Phi(t)$ is subject to the boundary condition that $\Phi(1) = \Phi$. The products of the string fields appearing in this expression (including those obtained by expanding the exponentials) are to be interpreted as star products. One can show that the action (8.43) depends only on Ψ and the boundary value Φ of $\Phi(t)$. The full non-linear gauge symmetries of this action can be found in [29].

Note that the construction described above has two main ingredients: use of the Ramond sector string field in the restricted Hilbert space (8.39) and the construction of the gauge invariant coupling between the R-sector states and the NS sector states in the large Hilbert space. One could choose to use one and not the other and combine this with some other construction to write down gauge invariant string field theory action. This is precisely what was done in [139, 140] where the authors used the R-sector string fields in the restricted Hilbert space and the NS sector string fields in the small Hilbert space to write down a gauge invariant string field theory action with cyclic A_∞ structure. Ref. [149] has formulated a different version of open superstring field theory based on integrals over supermoduli space. We shall not discuss these developments in this review in any further detail.

9 Applications of string field theory

String field theory has had a number of applications that go beyond what the world-sheet formulation of string theory can achieve. In this section we shall review some of these applications. Tachyon condensation, for example involves non-perturbative physics. We will review this subject here, including the construction of the tachyon vacuum solution. There are a number of other important solutions of open string field theory that we will not be able to discuss here [150–156].

We will also consider a number of topics in string perturbation theory that require string field theory to resolve a number of ambiguities in the world-sheet approach to the theory. Indeed, we will consider mass renormalization and vacuum shift. We will also review recent work on D-instanton contributions to closed string amplitudes. Finally, we will sketch the arguments for unitarity, crossing symmetry of string amplitudes, as well as for the ultraviolet finiteness of the theory.

There have been recent efforts to use string field theory to carry out conformal perturbation theory calculations that beyond leading orders become extremely subtle and possibly ambiguous. This is an important area of future research that we will not be able to cover here [87, 157–159].

With encouraging progress to date, it remains a goal to understand or improve string field theory to a degree that it gives a fully non-perturbative formulation of string theory.

9.1 Tachyon condensation

Tachyon condensation is one of the first applications of string theory to problems that cannot be addressed using the standard world-sheet description of scattering amplitudes. Since by now there are plenty of reviews on this subject (see *e.g.* [12] for analytic approaches and [14] for numerical approaches), we shall keep our discussion brief.

Open strings describe the excitations on the D-branes. Many D-branes in string theory have tachyonic excitation in the open string sector – excitations with negative mass-squared. This includes not only the D-branes in the bosonic string theory, but also unstable D-brane systems in superstring theory, *e.g.* a coincident pair of a BPS brane and its anti-brane, or non-BPS D-branes [160].

In perturbative quantum field theory, the existence of a tachyonic excitation is associated with the presence of a scalar field whose potential has a maximum at the background value of the field around which we carry out the perturbation expansion. If we study the theory by assuming that the fluctuations of the fields around this background remain small, we would conclude that there are tachyons in the spectrum. This, however, is not correct because the assumption that the fluctuations of the fields around the maximum of the potential can remain small is clearly wrong. The correct way to study such theories is to first identify a (local) minimum of the potential and then expand the potential around the minimum and quantize the theory. This will describe excitations with non-negative mass-squared. Therefore, in reality there are no tachyonic modes in the spectrum.

It is generally expected that the open string tachyons on D-branes have similar origin, namely that they are the result of attempting to quantize the system by expanding the potential around a maximum. However in the world-sheet description of string theory there is no systematic way to find the minimum of the potential and quantize the system by expanding the potential around the minimum. Nevertheless, using indirect arguments, one could make a guess about various properties of the minimum. These claims are the content of the following conjectures [57, 161]:

1. The minimum of the tachyon potential on an unstable brane system, not protected by any conservation laws, describes a configuration where the brane disappears altogether, leaving just the closed string vacuum. Examples of such systems are D-branes in bosonic string theory and unstable D-branes or brane-anti-brane systems in superstring theory. One immediate consequence of this is that the difference in the height of the potential between the perturbative vacuum describing the original unstable brane system and the minimum of the potential must be equal to the tension of the original brane system.
2. Since the minimum describes a configuration without any D-branes, there are no open string

excitations around the minimum.

3. There are also non-trivial soliton solutions where the tachyon approaches the minimum of the potential asymptotically, but takes a complicated form in the interior. These are expected to describe lower dimensional D-branes. Examples of such solutions are lump solutions in bosonic string D-branes describing lower dimensional D-branes, a kink solution on a type II string non-BPS D-brane describing a BPS D-brane of one lower dimension, vortex solution on a brane-antibrane pair describing a BPS D-brane of two lower dimensions, etc.

In special cases the third conjecture may be studied using conformal field theory (CFT) techniques, since both the initial configuration and the final configuration, being D-branes, have a description in CFT. Studying the first two conjectures is harder since there is no good description of the tachyon vacuum in conformal field theory.²⁶ Open string field theory is well suited for studying all the conjectures since we can simply study classical solutions and their properties in string field theory.

The main difficulty in studying the conjectures arises because the tachyon field is coupled to all the other fields, and so a systematic study requires studying classical equations of motion of a field theory with infinite number of fields. The initial study of this problem [167] was done using the ‘level truncation approach’ a method first tried by Kostelecky and Samuel in open string field theory [168,169] before the tachyon conjectures had been formulated. In level truncation, we truncate the string field to a finite set of fields based on the L_0 eigenvalue of the state that they multiply. We shall illustrate this with the example of unstable D-branes in bosonic string theory. At the leading order we keep just the tachyon field $\phi c_1|0\rangle$ in the expansion of the string field since $c_1|0\rangle$ is the state of lowest L_0 eigenvalue. Also since we are looking for a translationally invariant solution, we keep only the zero momentum state. Substituting this into the cubic open string field theory action one gets,

$$-S = V g_o^{-2} \left[-\frac{1}{2} \phi^2 + \frac{1}{3} \left(\frac{3\sqrt{3}}{4} \right)^3 \phi^3 \right], \quad (9.1)$$

where $V = (2\pi)^D \delta^{(p+1)}(0)$ is the space-time volume of the D-brane. The open string fields appearing in the cubic version of (4.43) have been scaled by a factor of g_o^{-1} to bring out an explicit factor of g_o^{-1} multiplying a g_o independent action. The $(3\sqrt{3}/4)^3$ factor comes from the conformal transformations needed to construct the cubic interaction vertex – these have been given in (4.54), (4.55). On the other hand, as mentioned in (4.44) and proved in (5.35), the open string coupling g_o can be shown to be related to the D-brane tension \mathcal{T} via the relation

$$\mathcal{T} = \frac{1}{2\pi^2 g_o^2}. \quad (9.2)$$

The potential in (9.1) has a local minimum at $\phi = (4/3\sqrt{3})^3$, where it takes value

$$-S = -V g_o^{-2} \frac{1}{6} \left(\frac{16}{27} \right)^3 = -V \mathcal{T} 2\pi^2 \frac{1}{6} \left(\frac{16}{27} \right)^3 \simeq -0.68 V \mathcal{T}. \quad (9.3)$$

According to the first conjecture, the expected result is $-V \mathcal{T}$. So we are not very far from the expected result.

The analysis at higher order is facilitated using the observation that classical open string field theory admits a consistent truncation in which we set to zero all open string fields associated with

²⁶Some understanding of this may be obtained using the boundary string field theory [162–164] formulated in [165, 166]. We shall not discuss this here but refer the reader to the original literature.

excitations on non-trivial matter primary. Such states enter the open string field theory action in pairs and triplets but not singly, and it is therefore consistent to set them to zero. The truncated string field, containing excitations by matter Virasoro generators L_{-n}^m and ghost oscillators acting on the vacuum state, is known as the universal sector. Since the zero momentum tachyon belongs to the universal sector, we can try to extend the solution to higher levels remaining within the universal sector. A further simplification occurs by the use of ‘twist symmetry’ that allows us to restrict to string fields multiplying states with odd L_0 eigenvalue, the tachyon being the one that multiplies a state of L_0 eigenvalue -1 . At the next order, working in the Siegel gauge, we include two more fields, describing the coefficient of $c_1 L_{-2}^m |0\rangle$ and $c_{-1} |0\rangle$. One can construct the open string field theory action with this truncated string field and find the extremum of the action. The result improves dramatically, yielding about 95% of the expected answer [167]. One can also check that even though we construct the solution in the Siegel gauge, it also satisfies the equations of motion of the out of Siegel gauge fields to very good accuracy. This procedure has now been extended to very high level, yielding results very close to the expected result [170, 171]. This procedure has also been generalized to describe tachyon vacuum solution on unstable D-branes of type II string theory using Berkovits formulation of open superstring field theory [172, 173]. One surprising feature of the analysis based on level truncation is that there is no small parameter in which we carry out the expansion, – *a priori* the contribution due to the higher level fields could be as large as that from the lower level fields. Yet the level truncation seems to converge rapidly.

One can also use a slightly modified version of this procedure to describe soliton solutions in open (super-) string field theory describing lower dimensional D-branes [174]. Instead of working with a non-compact world-volume of the parent D-brane, we compactify certain directions that would eventually be transverse to the soliton. Then the momenta carried by the string field in these directions is quantized and the expansion of string fields carrying momenta in these directions also admit a discrete level expansion, with higher level fields multiplying states of higher L_0 eigenvalues. We can now proceed as before to construct classical solutions in level expansion that describe lower dimensional D-branes and check if the action associated with the solution accounts for the difference in the value of the action for the original D-brane and the lower dimension D-branes that we want to construct. In all the cases that have been studied, the results come close to the expected values.

Except for the leading order results, most of the analysis in the level truncation method has been carried out numerically, since analytical solution of algebraic equations of many variables is hard to find. The situation changed dramatically in 2005 when Martin Schnabl [175] wrote down an analytic solution in bosonic open string field theory describing the tachyon vacuum, and showed analytically that the energy density of this solution exactly cancels the tension of the original D-brane. The solution was written down not in the Siegel gauge but in a different gauge that has come to be known as the Schnabl gauge. Since then different versions of the solution, related by gauge transformation to the original solution, have been constructed and the algebraic structure underlying the construction of the solution has been understood [176, 177]. This has been reviewed in detail in [12]. We now also have a systematic procedure for describing any configuration of arbitrary number of static D-branes as a classical solution in the open string field theory on a specific D-brane as long as all of them share the same closed string background [153, 178]. The tools used are surface states, including the so-called wedge states, and the K, b, c algebra of string fields [176], both of which will be discussed below.

At present we do not have a complete understanding of the relation between the Siegel gauge solution using level truncation and Schnabl’s analytic solution. It will definitely be helpful to understand

this relation better.

9.2 Tachyon vacuum solution and the \mathcal{Kbc} algebra.

We give here some of the basic ideas that go into the construction of classical open string field theory solutions, focusing on the tachyon vacuum solution. As mentioned above, this is just one of many solutions known at this point. For more details, consult the references above.

Solutions of OSFT are visualized as surface states dressed with some insertions of CFT operators. Surface states are the basic ingredient, they simply associate a surface with a puncture and a chosen local coordinate at the puncture to a state of the string. In our case, we have a surface Σ which is topologically a disk, a chosen point P on the boundary of Σ , and a local coordinate at P , namely, a map f from a canonical half disk $\text{Im}(w) > 0, |w| \leq 1$, to the surface Σ equipped with a coordinate z . We have $z(P) = f(w = 0)$ and the real boundary of the half disk is mapped to (part of) the boundary of Σ (see Fig. 16). The surface state $\langle \Sigma |$ is defined through overlaps

$$\langle \Sigma | \phi \rangle' = \langle \phi(w = 0) \rangle'_{\Sigma} = \langle f \circ \phi(0) \rangle'_{\Sigma}. \quad (9.4)$$

The state $|\Sigma\rangle$ just follows from BPZ conjugation. The surface in the surface state is best visualized as Σ' , the surface defined as Σ minus the image of the coordinate half disk. This removal induces a parameterized boundary, 'the' open string. Of course Σ' still has part of the standard boundary of Σ , where the open string boundary conditions hold. The left (L) and right (R) parts of the open string, viewed from Σ' , are the images under f of $|w| = 1$ with $\arg(w) \in [0, \pi/2]$ and $\arg(w) \in [\pi/2, \pi]$, respectively. The open string midpoint is Q (Fig. 16).

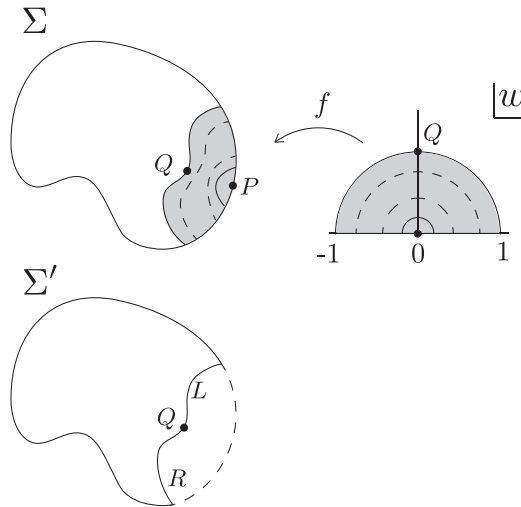

Figure 16: A surface state $|\Sigma\rangle$ associated to the surface Σ which has a puncture P at the boundary and a local coordinate around it. This local coordinate is a map from the ξ upper-half disk to Σ . Shown below is the surface Σ' , with the coordinate patch removed, introducing a new boundary composed by the left and right parts (L and R) of an open string.

The star multiplication of two surface states $|\Sigma_1\rangle$ and $|\Sigma_2\rangle$ is also a surface state $|\Sigma_1 \star \Sigma_2\rangle$. This surface $(\Sigma_1 \star \Sigma_2)'$, is obtained by gluing the R half-string in Σ_1' to the L half-string of Σ_2' . In the surface $(\Sigma_1 \star \Sigma_2)'$ the L part of the string is that of Σ_1' and the R part of the string is that of Σ_2' . With this rule, it is simple to visualize the star product of surface states. If one wishes, one can add

to $(\Sigma_1 \star \Sigma_2)'$ a coordinate half-disk consistent with its L and R parts, in this way getting the full surface $\Sigma_1 \star \Sigma_2$.

There is plenty of flexibility in defining surface states here: we must choose how to present the disk Σ and how to specify the local coordinates. This can be illustrated with the example of ‘wedge states’, surface states characterized by a real parameter $\alpha \geq 0$. The full surface, called $C_{\alpha+1}$, for a cylinder of circumference $\alpha + 1$, is the region in the z UHP with $-\frac{1}{2} \leq \text{Re}(z) \leq \alpha + \frac{1}{2}$ (see Fig. 17). The vertical lines at $-\frac{1}{2}$ and $\alpha + \frac{1}{2}$ are identified via $z \sim z + \alpha + 1$. Viewed as a disk, the ‘center’ is the point at $i\infty$ and the boundary is the real segment $z \in [-\frac{1}{2}, \frac{1}{2} + \alpha]$. The surface is, of course, a semi-infinite cylinder, or just a cylinder. The puncture is at the origin $z = 0$, and the local coordinate patch is the region $-\frac{1}{2} \leq \text{Re}(z) \leq \frac{1}{2}$, a unit width vertical strip, where we can identify the L and R edges of the surface state as the vertical lines $\text{Re}(z) = \frac{1}{2}$ and $\text{Re}(z) = -\frac{1}{2}$, respectively. The local coordinate w on the strip is related to z as follows

$$z = \frac{2}{\pi} \arctan w. \quad (9.5)$$

This indeed maps the w upper-half disk, to the unit width vertical strip, also sending $w = 0$ to $z = 0$, the position of the puncture, and $w = i$ to $z = i\infty$, the position of the open string mid-point. This unit-strip picture of the half disk is sometimes called the sliver frame. The surface Ω'_α is then just the region of width α to the right of the coordinate strip. Its left boundary is the half-string L , and by the identification, its right boundary is the half string R . This is the wedge state Ω'_α or sometimes simply called Ω_α (Fig. 17).

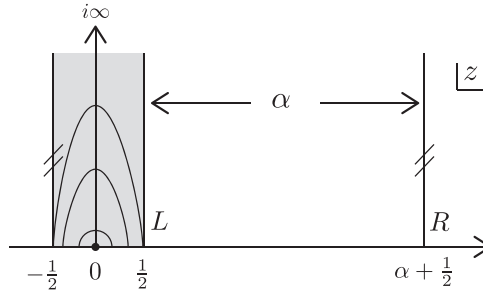

Figure 17: The wedge state Ω_α . The coordinate patch is shown shaded and the left-most and right-most boundaries are identified to form the cylinder $C_{\alpha+1}$. The state Ω'_α has the coordinate patch removed and has boundaries L and R , for the left- and right halves of the open string.

It should now be clear that we have the star product [179]:

$$|\Omega_\alpha\rangle \star |\Omega_\beta\rangle = |\Omega_{\alpha+\beta}\rangle, \quad (9.6)$$

since gluing a region of width α to a region of width β gives a region Σ' of width $\alpha + \beta$. Note that the full surface Σ , obtained by adding the unit-width coordinate strip, is a cylinder of circumference $\alpha + 1$. A few wedge states are easily recognized. The wedge state with $\alpha = 0$ is the identity string field \mathcal{I} , this is clear because the surface Ω'_0 is just a strip of vanishing length, which changes no state by star multiplication. The wedge state for $\alpha = 1$ is actually the $\text{SL}(2, \mathbb{R})$ vacuum $|\Omega_1\rangle = |0\rangle$; this can be seen by mapping the region $-1/2 \leq \text{Re}(z) \leq 3/2$, with the identification $z \equiv z + 2$, to the full upper half w plane via the map (9.5). Finally the state obtained in the limit $\alpha = \infty$ turns out to be well defined and it is called the sliver state $|\Omega_\infty\rangle$. The sliver is a rank one projector of the star algebra, satisfying the expected property $|\Omega_\infty\rangle \star |\Omega_\infty\rangle = |\Omega_\infty\rangle$. A few references that discuss

manipulations involving wedge states and related surface states, with special emphasis on projectors, are [180–184].

The next step in this construction is to understand how to change the width of a wedge state via the action of an operator. For this consider an arbitrary²⁷ local boundary operator ϕ and the overlap

$$\langle \phi, \Omega_\alpha \rangle' = \langle f \circ \phi(0) \rangle'_{C_{\alpha+1}}, \quad (9.7)$$

where $f(w)$ is the map appearing on the right hand side of (9.5). We evaluate the right-hand side by first doing a conformal scaling transformation $z \rightarrow f_\alpha(z) \equiv z/(\alpha + 1)$ that turns the surface into a cylinder of unit circumference

$$\langle \phi, \Omega_\alpha \rangle' = \langle f_\alpha \circ f \circ \phi(0) \rangle'_{C_1}. \quad (9.8)$$

Now note that $f_{\alpha+\delta\alpha}$, a scaling by $1/(1 + \alpha + \delta\alpha)$, can be represented as the composition

$$f_{\alpha+\delta\alpha} = f_{\delta\alpha/(1+\alpha)} \circ f_\alpha. \quad (9.9)$$

Applying (9.8) with α replaced by $\alpha + \delta\alpha$ we find

$$\langle \phi, \Omega_{\alpha+\delta\alpha} \rangle' = \left\langle f_{\delta\alpha/(1+\alpha)} \circ f_\alpha \circ f \circ \phi(0) \right\rangle'_{C_1}. \quad (9.10)$$

The effect of the infinitesimal scaling $f_{\delta\alpha/(1+\alpha)}$ can be reproduced by the insertion of the operator $I - (1 + \alpha)^{-1} \delta\alpha \oint_0 \frac{dz}{2\pi i} zT(z)$, with I the identity operator. Thus we have, using (9.8)

$$\begin{aligned} \langle \phi, \Omega_{\alpha+\delta\alpha} \rangle' &= \langle \phi, \Omega_\alpha \rangle' - \frac{\delta\alpha}{1 + \alpha} \left\langle \oint_0 \frac{dz}{2\pi i} zT(z) f_\alpha \circ f \circ \phi(0) \right\rangle'_{C_1} \\ &= \langle \phi, \Omega_\alpha \rangle' - \frac{\delta\alpha}{1 + \alpha} \left\langle \oint_0 \frac{dz}{2\pi i} zT(z) f \circ \phi(0) \right\rangle'_{C_{\alpha+1}}, \end{aligned} \quad (9.11)$$

where in the last step we have rescaled the cylinder width back to $(1 + \alpha)$, noting that $\oint_0 \frac{dz}{2\pi i} zT(z)$ is invariant under this rescaling. We thus conclude that

$$\left\langle \phi, \frac{d}{d\alpha} \Omega_\alpha \right\rangle' = -\frac{1}{\alpha + 1} \left\langle \oint_0 \frac{dz}{2\pi i} zT(z) f \circ \phi(0) \right\rangle'_{C_{\alpha+1}}. \quad (9.12)$$

At this point, by contour deformation, the integral around the vertex operator is deformed into the sum of two integrals, one on the boundary $\text{Re } z = \alpha + \frac{1}{2}$ going up and one on $\text{Re } z = -\frac{1}{2}$ going down. Of course these edges are identified, so the integrals can be combined into a single integral, say, on the R boundary $\text{Re } z = \alpha + \frac{1}{2}$. A short calculation gives

$$\left\langle \phi, \frac{d}{d\alpha} \Omega_\alpha \right\rangle' = -\left\langle \int_R \frac{dz}{2\pi i} T(z) f \circ \phi(0) \right\rangle'_{C_{\alpha+1}}. \quad (9.13)$$

The right-hand side is in fact the overlap of $\langle \phi |$ with a wedge state acted by the contour integral of T . We write this as

$$\frac{d}{d\alpha} \Omega_\alpha = -\Omega_\alpha \mathcal{K} = -\mathcal{K} \Omega_\alpha, \quad (9.14)$$

where the last equality follows because the insertion could be contour-deformed within the wedge to the left line $\text{Re } z = \frac{1}{2}$. Here \mathcal{K} is a string field, a state, and the products in the above equation are

²⁷We follow the discussion in [12], with a small modification that does not require the operator ϕ to carry definite conformal weight.

star products. The state \mathcal{K} is the surface state of an infinitesimally thin wedge with the insertion of the stress tensor or, equivalently, the identity string field \mathcal{I} acted by the contour integral $\int \frac{dz}{2\pi i} T(z)$ over half the string, written schematically as

$$\mathcal{K} = \left(\int_L T \right) \mathcal{I}. \quad (9.15)$$

Since $\Omega_0 = \mathcal{I}$, the above equation is integrated to find

$$\Omega_\alpha = e^{-\alpha\mathcal{K}}. \quad (9.16)$$

The exponential here is defined through string products ($e^X = \mathcal{I} + X + \frac{1}{2}X \star X + \dots$). This representation of the wedge states allows us to manipulate them effectively, as we shall see below.

Completely analogous to \mathcal{K} we have the state B , defined using the antighost field $b(z)$ instead of $T(z)$:

$$B = \left(\int_L b \right) \mathcal{I}. \quad (9.17)$$

Finally we have the state c , defined an infinitesimal strip with a simple *pointwise* insertion of the operator $c(z)$ at the boundary (the base of the wedge). The $\mathcal{K}bc$ algebra is the set of identities satisfied by the string fields c, B , and \mathcal{K} . Including also the action of the BRST operator Q we have the relations

$$\begin{aligned} c^2 &= 0, & B^2 &= 0, & \{c, B\} &= 1, \\ [\mathcal{K}, B] &= 0, & [\mathcal{K}, c] &= \partial c, \\ Q\mathcal{K} &= 0, & QB &= \mathcal{K}, & Qc &= c\mathcal{K}c. \end{aligned} \quad (9.18)$$

It turns out it is relatively easy to write solutions of the open string field theory using these states. It is harder, however, to tell what the physics of the solution is. Take, for example, the identity-based string field $\Psi = c(1 - \mathcal{K})$ [185, 186]. We see that $Q\Psi = c\mathcal{K}c - c\mathcal{K}c\mathcal{K} = -(c - c\mathcal{K})(c - c\mathcal{K}) = -\Psi^2$, thus Ψ is a solution. The BRST operator at the solution, $Q_\Psi = Q + [\Psi, \cdot]$, actually satisfies $Q_\Psi B = QB + \{c(1 - \mathcal{K}), B\} = \mathcal{K} + \{c, B\} - \{c, B\}\mathcal{K} = \mathcal{I}$. An operator A satisfying $Q_\Psi A = \mathcal{I}$ is called a homotopy operator. Its existence implies that any BRST closed state χ is trivial: if $Q_\Psi \chi = 0$, we have $\chi = Q_\Psi(A \star \chi)$. For this solution B is a homotopy operator and therefore there are no physical states at the resulting configuration. The solution represents the tachyon vacuum but regrettably, it is quite singular; the evaluation of the action for this solution is ill-defined.

A general solution found by Okawa [176] is written for general $F = F(\mathcal{K})$:

$$\Psi = Fc \frac{\mathcal{K}}{1 - F^2} BcF, \quad \text{with } F = F(\mathcal{K}). \quad (9.19)$$

This can be checked with simple computations. First one notices that

$$(1 - FBcF)^{-1} = 1 + \frac{F}{1 - F^2} BcF, \quad (9.20)$$

which is verified by checking that the right-hand side multiplied by $(1 - FBcF)$ is indeed the identity (this requires using $BcBc = Bc$ and $BcFBc = FBc$). Then one checks that

$$\Psi = (1 - FBcF)Q(1 - FBcF)^{-1}. \quad (9.21)$$

In this form, where $\Psi = \xi Q \xi^{-1}$, with $\xi = 1 - FBcF$, it is essentially obvious that the equation of motion is satisfied: $Q\Psi = (Q\xi)(Q\xi^{-1}) = -\Psi^2$ because $\Psi^2 = (\xi Q \xi^{-1})(\xi Q \xi^{-1}) = -\xi[(Q\xi^{-1})\xi]Q\xi^{-1} = \xi[-\xi^{-1}Q\xi]Q\xi^{-1} = (Q\xi)(Q\xi^{-1})$. With a bit more work one can check that there is a homotopy operator

$$A = \frac{1 - F^2}{\mathcal{K}} B, \quad Q_\Psi A = \mathcal{I}. \quad (9.22)$$

Thus, formally, all these solutions are the tachyon vacuum. The question becomes: What are the allowed $F(\mathcal{K})$ for which the solution and the homotopy operator are both well defined? There are two options that are particularly interesting [187]:

1. $F(\mathcal{K}) = e^{-\mathcal{K}/2} = \Omega_{1/2}$.

This corresponds to the original solution by Schnabl and gives

$$\begin{aligned} \Psi &= \Omega_{1/2} c \frac{\mathcal{K}}{1 - \Omega_1} Bc \Omega_{1/2} = \Omega_{1/2} c (1 + \Omega_1 + \Omega_2 + \dots) \mathcal{K} Bc \Omega_{1/2}, \\ &= \Omega_{1/2} c \mathcal{K} Bc \Omega_{1/2} + \Omega_{1/2} c \left(\sum_{n=1}^{\infty} \Omega_n \right) \mathcal{K} Bc \Omega_{1/2}, \end{aligned} \quad (9.23)$$

the last expression representing the solution as a leading ghost term supplemented by an infinite sum of wedge states of growing width, each with two insertions of c and one of B (Fig. 18, left). In this solution the homotopy operator is believed to be well defined. The solution itself, however, has a subtlety: the infinite sum cannot be truncated to evaluate the energy, and, as a result a so-called *phantom* term has to be added to the solution.

2. $F(\mathcal{K}) = \frac{1}{\sqrt{1+\mathcal{K}}}$.

Written by Erler and Schnabl, this is the simplest known regular solution, and it seems to have no subtlety [177]. It is given by

$$\Psi = \frac{1}{\sqrt{1+\mathcal{K}}} c(1+\mathcal{K}) Bc \frac{1}{\sqrt{1+\mathcal{K}}}. \quad (9.24)$$

Recalling that $\Omega_t = e^{-t\mathcal{K}}$, we have the representation

$$\frac{1}{\sqrt{1+\mathcal{K}}} = \frac{1}{\sqrt{\pi}} \int_0^\infty \frac{dt}{\sqrt{t}} e^{-t} \Omega_t, \quad (9.25)$$

and this can be used to rewrite the solution as

$$\Psi = \frac{1}{\pi} \int_0^\infty \int_0^\infty \frac{dt_1}{\sqrt{t_1}} \frac{dt_2}{\sqrt{t_2}} e^{-(t_1+t_2)} \Omega_{t_1} c(1+\mathcal{K}) Bc \Omega_{t_2}. \quad (9.26)$$

We see that this time we have a continuous sum over wedge states that goes from the identity to the sliver. The solution has a width t_1 wedge, with insertions on its right side (two ghosts sandwiching B and $(1+\mathcal{K})$ operators) glued to a width t_2 wedge (Fig. 18, right). Verifying that this solution has the right energy is a relatively short calculation using tools of conformal field theory.

Similar analytical solutions in the open superstring field theory discussed in section 8.1 were found in [188]. Refs. [189–191] use similar techniques for describing solutions associated with marginal deformations of the boundary conformal field theory. Some of these numerical and analytical methods

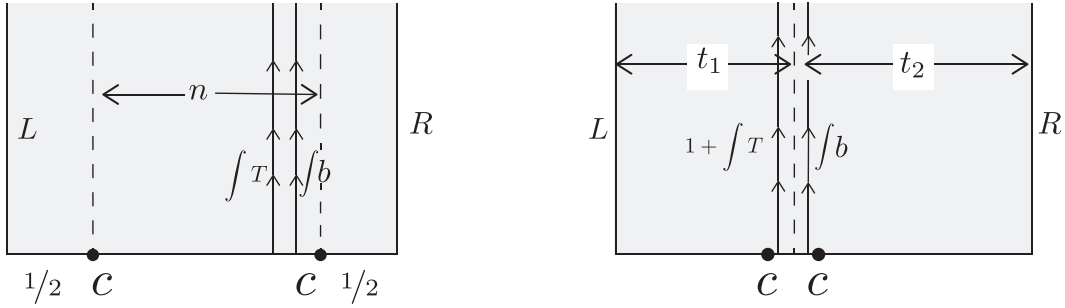

Figure 18: Left: The n -th term in the tachyon vacuum solution by Schnabl, a wedge state of width $n + 1$ with two c insertions and a B insertion. Right: The integrand in the simple tachyon vacuum solution, with left and right wedges of widths t_1 and t_2 , respectively, and insertions in between them.

have also been extended to a discussion of time dependent solutions in open string field theory [192, 193] but we shall not discuss them in this review.

An important question in this area is: Given a particular solution in open string field theory, what is its physical interpretation? For this purpose one can use gauge-invariant observables of open string field theory. The idea for such observables originated from an open-closed vertex arising in the factorization of open string amplitudes in the associative open SFT [194, 195]. In this vertex, the open string is viewed as a semi-infinite strip, with the two halves of the final open string glued together and the closed string state inserted on the conical singularity at the string midpoint.

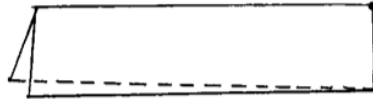

Figure 19: The open-closed vertex used for gauge-invariant observables in OSFT. The open string state is inserted at the infinitely far past of the open string. The closed string state is inserted at the midpoint of the final open string (heavy dot), which has its two halves glued.

Because of the conical singularity, only on-shell closed string states are naturally inserted at this singular open string midpoint, and it was shown in [8] that if the associative OSFT is supplemented by just this interaction, the Feynman rules of the theory provides a cover of all the moduli spaces of surfaces with boundaries and both open and closed string punctures. This covering property suggested the open-string gauge invariance of the open-closed vertex coupling to on-shell closed strings. Such property was noted independently by Hashimoto and Itzhaki [196] and Gaiotto *et.al.* [197], thus providing an observable of the open string field theory.

A key step was made by Ellwood [198] who conjectured and gave evidence that the above gauge invariant observable (now called Ellwood invariant) is related to the closed string boundary state $|B\rangle$. Recall that the boundary state (for bosonic strings) is a ghost-number-three closed string state reproducing the one-point functions of arbitrary closed string operators on a disk as follows: $\langle c_0^- \mathcal{O} \rangle_{\text{disk}} = \langle B | c_0^- | \mathcal{O} \rangle$. Let $\Phi = 0$ represent the open string background used to formulate the OSFT, and $\hat{\Phi}$ be the open string field classical solution that represents a different open string background. Moreover, let $|B_0\rangle$ and $|B_{\hat{\Phi}}\rangle$ denote the boundary state for the original $\Phi = 0$ background and the boundary state for the background represented by $\hat{\Phi}$, respectively. With $\langle E[\mathcal{O}_c] |$ denoting the ghost number two open string state such that $\langle E[\mathcal{O}_c] | \phi_o \rangle$ denotes the disk two-point function of any open

string state ϕ_o and on-shell closed string state \mathcal{O}_c ($Q_c\mathcal{O}_c = 0$) in the open-closed vertex, we have Ellwood's relation:

$$-4\pi i \langle E[\mathcal{O}_c] | \hat{\Phi} \rangle = \langle \mathcal{O}_c | c_0^- | B_{\hat{\Phi}} \rangle - \langle \mathcal{O}_c | c_0^- | B_0 \rangle. \quad (9.27)$$

The \mathcal{O}_c -based Ellwood invariant on the left-hand side computes the difference of one-point functions of \mathcal{O}_c in the final and original open string backgrounds. For additional details on normalization of the various quantities in this relation see, for example, [14]. An extension of Ellwood's construction to deal with general closed string states and thus get all the information of the boundary state was given in [199]. An explicit procedure for constructing the boundary state corresponding to a given solution in open string field theory was given in [200].

9.3 Mass renormalization and vacuum shift

In this section we shall first briefly review where the world-sheet formalism breaks down in dealing with mass renormalization and vacuum shift and then describe how string field theory can be used to resolve these problems.

9.3.1 Issue with mass renormalization

It is commonly believed that the world-sheet formalism for string theory allows us to calculate on-shell amplitudes, i.e. S-matrix elements. This is not strictly true, however. In the world-sheet formalism we define the on-shell states as appropriate representatives of BRST cohomology, normalized according to certain rules, and then compute the S-matrix element as integrals of correlation function of the corresponding vertex operators on the Riemann surfaces. If we translate this to the language of string field theory, it will amount to defining the on-shell states as appropriately normalized solutions to the linearized *classical* equations of motion and computing the S-matrix element as the convolution of these wave-functions with the off-shell Green's functions. However, we know from our study of quantum field theory that except in very special circumstances, this is not the correct procedure for computing the S-matrix. There are two ways this procedure fails:

1. We know that in quantum field theory the masses of various fields can get renormalized. Therefore a state that is on-shell at tree level is no longer on-shell at the loop level. If we ignore this effect and try to compute the convolution of the tree-level wave-function of the state with the Green's function we shall encounter divergences. In perturbation theory these divergences show up as self-energy diagrams on external legs. If we try to evaluate them by setting the external momenta to satisfy the tree-level on-shell condition, then we shall get divergent results since these diagrams will contain on-shell internal propagators. An example of this has been shown in Fig.20 (a) where the internal line carrying momentum k is forced to be on-shell if we require the external state to be on-shell.
2. Even in special cases where the mass renormalization effect is absent, it e.g. for massless gauge particles, Goldstone bosons etc., there may be wave-function renormalization effects that tell us that a correctly normalized state for computing tree-level S-matrix elements may not be correctly normalized at the loop level. If we do not take this into account, we do not get a unitary S-matrix.

We encounter similar issues in the naive world-sheet approach to the computation of the string S-matrix. For example if we take the vertex operators to be elements of the BRST cohomology

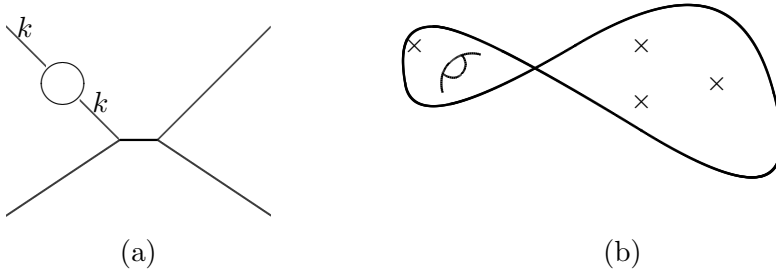

Figure 20: (a) Mass renormalization diagram in quantum field theory. (b) Divergent contribution to string theory amplitudes associated with one loop mass renormalization. The crosses denote vertex operators of external states.

satisfying the tree-level on-shell condition and try to evaluate a one loop amplitude we shall get divergent result from degenerate Riemann surfaces of the kind shown in Fig. 20 (b). The relation to the diagram in Fig. 20 (a) follows from the Schwinger parameter representation of the Siegel gauge propagator that is needed to express string theory Feynman diagrams as world-sheet contribution:

$$\frac{1}{L_0 + \bar{L}_0} \delta_{L_0, \bar{L}_0} = \frac{1}{2\pi} \int_{|q| \leq 1} \frac{d^2 q}{|q|^2} q^{L_0} \bar{q}^{\bar{L}_0}. \quad (9.28)$$

For $L_0 > 0$ this is an identity but for $L_0 < 0$ the right hand side diverges from the $q \simeq 0$ region even though the left hand side is finite. In this case the left hand side can be regarded as the analytic continuation of the right hand side. For $L_0 = 0$, however, both sides are divergent. On the left-hand side such divergences occur from the on-shell internal propagator of string field theory as in the case of Fig.20 (a). On the right hand side such divergences, coming from the $q \simeq 0$ region, are associated with degenerate Riemann surfaces of the kind shown in Fig.20 (b) once we identify q with the plumbing fixture variable.

In the world-sheet theory there is no systematic procedure for dealing with such divergences²⁸ but in string field theory we can use the usual insights from quantum field theory. In particular, the LSZ prescription tells us that instead of dealing with diagrams of the type shown in Fig. 20 (a) in isolation, we need to first compute the off-shell propagator by summing over all self-energy diagrams, locate the poles of the propagator to compute renormalized masses and the residues at the poles to compute the wave-function renormalizations, and then evaluate the amputated Green's function at the (loop corrected) on-shell external momenta, renormalized by the wave-function renormalization factors. Use of amputated Green's function ensures that there are no self-energy insertions on external legs as in Fig.20 (a), and we get a finite result.

Since string field theory can be regarded as a regular quantum field theory, we can follow the same procedure to get finite string amplitudes. An extra complication arises because string theory is

²⁸When mass renormalization is absent and hence there are no divergences, the amplitude in the world-sheet theory may be still ambiguous since the integrals become only conditionally convergent [201]. Working within the conventional world-sheet formalism, [201] showed that these are associated to possible ambiguities in the finite part of the wave-function renormalization. We need to ensure, however, that when the finite part of the wave-function renormalization is fixed in one amplitude, we use the same renormalization prescription for all other amplitudes. To do this one needs string field theory; in the conventional world-sheet description one cannot relate the regulator in one amplitude to a regulator in a different amplitude. A similar remark holds for the situation where tadpoles of massless moduli fields vanish but there is an ambiguity related to redefinition of the moduli fields.

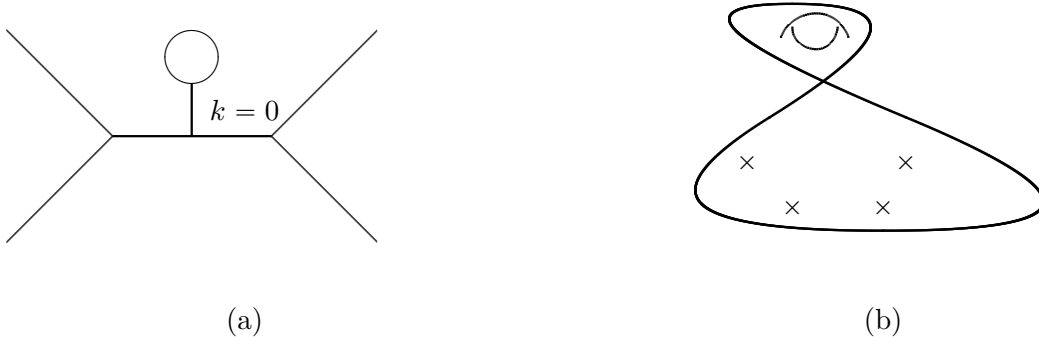

Figure 21: (a) Massless tadpole diagram in quantum field theory. (b) Divergent contribution to string theory amplitudes associated with massless tadpoles. The crosses denote vertex operators of external states.

a gauge theory; not all the poles in the gauge-fixed propagator are physical and we have to carefully sort out the physical poles from the others. This can be done [202, 203] but we shall later describe a way to get around this using the 1PI effective action [77, 204].

9.3.2 Issues with vacuum shift

Consider a massless scalar field theory with action

$$S = - \int d^D x \left[\frac{1}{2} \partial_\mu \phi \partial^\mu \phi + \frac{g_s}{3!} \phi^3 \right]. \quad (9.29)$$

At one loop order this theory develops a tadpole of the ϕ field. If we ignore its presence and try to compute amplitudes using the usual Feynman rules, we run into divergences from internal ϕ propagators that carry zero momentum. An example of this has been shown in Fig.21 (a) where we see an intermediate massless propagator carrying strictly zero momentum due to momentum conservation. As we discussed above, the analogous divergences arise in string theory via degenerate Riemann surfaces of the type shown in Fig.21 (b).

In quantum field theory there is a well defined procedure for dealing with this problem. Tadpole diagrams may be regarded as a contribution to the effective action that is linear in the fields. Therefore the effective action takes the form:

$$S = - \int d^D x \left[\frac{1}{2} \partial_\mu \phi \partial^\mu \phi + \frac{g_s}{3!} \phi^3 + c g_s \phi + \mathcal{O}(\phi^2) \right], \quad (9.30)$$

where c is some constant. Therefore the true extrema of the effective action are at

$$\phi = \pm \sqrt{-2c} + \mathcal{O}(g_s). \quad (9.31)$$

If $c < 0$ then there are two real solutions, one of which is a minimum and the other one is a maximum of the effective potential. In this case we can define perturbative amplitudes by expanding the fields around the minimum. This minimum at non-zero ϕ represents the vacuum shift from $\phi = 0$. Of course the theory is non-perturbatively ill defined since the potential is unbounded from below, but that will not be relevant for our discussion (and can be avoided by adding higher order terms in the

classical potential). If c is positive then there is no extremum at real values of ϕ and the theory is ill defined, at least perturbatively.

In string theory there is no known systematic way to solve the tadpole problem in the world-sheet theory although some suggestions have been made in [205]. The main idea of [205] is similar in spirit to that in quantum field theory, i.e. cancel the loop generated tadpoles against a tadpole generated at tree level by going away from the conformal background. However, both the loop induced tadpole and the tree-level tadpoles involve regulators and *a priori* there is no systematic way of extracting an unambiguous finite answer after cancelling these divergences. In string field theory, on the other hand, we can follow the same procedure as in a regular quantum field theory and arrive at an unambiguous result.²⁹ We shall illustrate this below.

9.3.3 Solution of the vacuum shift problem using string field theory

In the following we shall consider the case of closed superstring theory but the results also hold in other string theories with trivial changes.

The equations of motion derived from the 1PI effective action (5.47) takes the form:

$$\begin{aligned} Q(|\Psi\rangle - \mathcal{G}|\tilde{\Psi}\rangle) &= 0, \\ Q|\tilde{\Psi}\rangle + \sum_{n=0}^{\infty} \frac{1}{n!} [\Psi^n]_{1\text{PI}} &= 0. \end{aligned} \tag{9.32}$$

Our goal will be to look for solution to this equation in perturbation theory, with perturbation parameter the coupling constant g_s . Recall that g_s appears in the above equations through the definition of the product $[\Psi^n]$ where g_s is the expansion parameter for the sum over genus (see, for example, (4.13)).

For a translationally invariant vacuum solution we can work at zero momentum. For simplicity we set the RR fields to zero so that we have only the NS sector fields. In this case $\mathcal{G} = 1$ and we can set

$$|\tilde{\Psi}\rangle = |\Psi\rangle, \tag{9.33}$$

so that the equation takes the form:

$$Q|\Psi\rangle + \sum_{n=0}^{\infty} \frac{1}{n!} [\Psi^n]_{1\text{PI}} = 0. \tag{9.34}$$

We can try to solve this equation iteratively in a power series in g_s , starting with the leading order solution $|\Psi_0\rangle = 0$. We shall assume that the solution can be expanded in integer powers of g_s , but the analysis can be easily extended to the situation where the solution has fractional powers of g_s . If $|\Psi_k\rangle$ denotes the solution with all powers of g_s up to and including g_s^k , then a *formal* iterative solution is given by:

$$|\Psi_{k+1}\rangle = -\frac{b_0^+}{L_0^+} \sum_{n=0}^{k+1} \frac{1}{n!} [\Psi_k^n]_{1\text{PI}} + \mathcal{O}(g_s^{k+2}). \tag{9.35}$$

Since $|\Psi_{k+1}\rangle$ must be a solution up to and including order g_s^{k+1} , terms of $\mathcal{O}(g_s^{k+2})$ can be ignored. This means that the $\mathcal{O}(g_s^{k+2})$ terms arising from the $[\Psi_k^n]$ products (due to the infinite sum over genus) are to be ignored. The state $|\Psi_{k+1}\rangle$ is a solution because one can easily check that the lower

²⁹A hybrid approach, that does not use the full power of string field theory, but uses enough ingredients involving off-shell amplitudes, was used in [206] to address the tadpole problem.

order equations imply that the state $\sum_{n=0}^{k+1} \frac{1}{n!} [\Psi_k^n]_{1\text{PI}}$ is BRST invariant up to corrections of order g_s^{k+2} .

The problem with this formal solution, however, is that $\sum_{n=0}^{k+1} \frac{1}{n!} [\Psi_k^n]_{1\text{PI}}$ may have components along states with $L_0^+ = 0$ and hence $1/L_0^+$ acting on these states is ill defined. To address this we introduce a projection operator \mathbf{P} into the $L_0^+ = 0$ states and write:

$$\begin{aligned} |\Psi_{k+1}\rangle &= -\frac{b_0^+}{L_0^+} (1 - \mathbf{P}) \sum_{n=0}^{k+1} \frac{1}{n!} [\Psi_k^n]_{1\text{PI}} + |\psi_{k+1}\rangle + \mathcal{O}(g_s^{k+2}), \quad \mathbf{P}|\psi_{k+1}\rangle = |\psi_{k+1}\rangle, \\ Q|\psi_{k+1}\rangle &= -\mathbf{P} \sum_{n=0}^{k+1} \frac{1}{n!} [\Psi_k^n]_{1\text{PI}} + \mathcal{O}(g_s^{k+2}). \end{aligned} \tag{9.36}$$

The first line is an ansatz for $|\Psi_{k+1}\rangle$, which introduces an unknown string field $|\psi_{k+1}\rangle$ with components along the subspace of states of vanishing L_0^+ and defined up to irrelevant $\mathcal{O}(g_s^{k+2})$ terms. The equation on the second line is the key one. If it can be solved for $|\psi_{k+1}\rangle$, then one can show that the equation of motion (9.34) is satisfied to $\mathcal{O}(g_s^{k+1})$. This can be checked by applying \mathbf{P} and $(1 - \mathbf{P})$ on (9.34).

There is a possible obstruction to solving for $|\psi_{k+1}\rangle$. As already mentioned, the right-hand side of this equation is BRST invariant to order g_s^{k+1} as long as $|\Psi_k\rangle$ satisfies the equation of motion to order g_s^k . Therefore if the right hand side is BRST trivial, i.e. has the form $Q|s_{k+1}\rangle$ for some state $|s_{k+1}\rangle$, we can simply set $|\psi_{k+1}\rangle = |s_{k+1}\rangle$. However, if the right hand side contains non-trivial elements of the BRST cohomology then this equation cannot be solved, and there is a genuine obstruction to finding a perturbative solution. Another feature of the equation for $|\psi_{k+1}\rangle$ is that when the solution exists, it is not unique since we can add any linear combination of BRST invariant states with coefficients of order g_s^{k+1} to $|\psi_{k+1}\rangle$ and the equation is still satisfied since these terms are killed by Q .

Both these features of the solution have analogs in a conventional quantum field theory whose classical potential has flat directions. Let ϕ denote such a flat direction. If at some order quantum corrections generate a non-zero term on the right hand side of the equation of motion of ϕ , then the equations of motion cannot be solved by an iterative procedure since the equation of motion of ϕ will have a vanishing left hand side but a non-vanishing right hand side. On the other hand if quantum corrections do not generate a non-zero term on the right hand side of the equation of motion of ϕ to a given order (say g_s^k), then at that order the solution will be ambiguous since given a solution, we can always shift ϕ by a term of order g_s^k and still have a solution.

Some time we may be able to use the ambiguity in determining the solution at a given order to fix the problem of lifting of flat directions at a higher order. Indeed, even though we can add to $|\psi_{k+1}\rangle$ any linear combination of BRST invariant states with coefficients of order g_s^{k+1} , at higher order these coefficients may be fixed by the condition that the right hand side of the equation for $|\psi_{k'}\rangle$ at higher order does not have non-trivial elements of the BRST cohomology. An illustration of the procedure outlined here can be found in [207]. This again has its counterpart in quantum field theory where quantum corrections may fix the location of the solution along a flat direction instead of destroying the solution.

This procedure can be generalized to analyze the shift of RR background as well. Examples of this can be found in [208, 209].

9.3.4 Solution of the mass renormalization problem using string field theory

Consider a vacuum solution $|\Psi_v\rangle$ to the equations of motion, as discussed in the previous subsection, with the assumption that the string field is in the NS sector and thus we have $|\tilde{\Psi}\rangle = |\Psi\rangle = |\Psi_v\rangle$. We can study small fluctuations around the vacuum solution to find the renormalized masses. For this we express the string field as:

$$|\Psi\rangle = |\Psi_v\rangle + |\Phi\rangle, \quad |\tilde{\Psi}\rangle = |\Psi_v\rangle + |\tilde{\Phi}\rangle. \quad (9.37)$$

The fluctuations in these two fields are not identical because the result $|\tilde{\Psi}\rangle = |\Psi\rangle$ holds only for the vacuum solution. We work to linear order in the fluctuations $|\Phi\rangle, |\tilde{\Phi}\rangle$. It is easy to check that to linear order the equations of motion for the fluctuating fields are:

$$Q(|\Phi\rangle - \mathcal{G}|\tilde{\Phi}\rangle) = 0, \quad Q|\tilde{\Phi}\rangle + K|\Phi\rangle = 0, \quad (9.38)$$

where K is an operator acting on string fields as follows

$$K|A\rangle \equiv \sum_{n=0}^{\infty} \frac{1}{n!} [\Psi_v^n A], \quad (9.39)$$

for any state $|A\rangle$. Since Q commutes with \mathcal{G} , the two equations can be combined to give:

$$(Q + \mathcal{G}K)|\Phi\rangle = 0. \quad (9.40)$$

This is a *linear* equation for the fluctuation string field. Moreover, using the equations of motion (9.34) for Ψ_v , the operator K can be shown to satisfy the identity

$$QK + KQ + K\mathcal{G}K = 0. \quad (9.41)$$

Our goal will be to find solutions to (9.40) in a series expansion in g_s , starting with a leading order solution representing a BRST invariant state. To do this systematically, we note that at tree level the elements of BRST cohomology occur at $L_0^+ = 0$. The operator L_0^+ , acting on a state with momentum k , is given by

$$2L_0^+ = (k^2 + \hat{M}^2), \quad (9.42)$$

where the operator \hat{M}^2 represents the oscillator contribution to the operator in the noncompact theory, while in a compactified theory it also includes contributions from the CFT associated with the compact directions. \hat{M}^2 has discrete spectrum of degenerate eigenvalues. We shall focus on a set of degenerate eigenstates carrying a particular eigenvalue m^2 of \hat{M}^2 . For states of momentum k and \hat{M}^2 eigenvalue m^2 , the $L_0^+ = 0$ condition now takes the form $k^2 + m^2 = 0$.

We expect that the quantum-corrected equations of motion (9.40) will have a solution at $k^2 + m^2 + \mathcal{O}(g_s) = 0$. We consider states carrying a fixed momentum k satisfying $k^2 + m^2 \simeq \mathcal{O}(g_s)$, and define a projection operator P that projects onto states with $\hat{M}^2 = m^2$. For any such fixed k , this is a finite dimensional vector space V_m .

The algorithm to produce a solution to (9.40) begins by picking an order we want to work to. Assume that we want to work to order g_s^n for some $n \geq 1$. A solution $|\Phi_n\rangle$ to order g_s^n is constructed iteratively as follows:

$$|\Phi_0\rangle = |\phi_n\rangle, \quad |\Phi_{\ell+1}\rangle = -\frac{b_0^+}{L_0^+} (1 - P)\mathcal{G}K|\Phi_\ell\rangle + |\phi_n\rangle, \quad (9.43)$$

with $|\phi_n\rangle$ satisfying,

$$P|\phi_n\rangle = |\phi_n\rangle, \quad Q|\phi_n\rangle = -P\mathcal{G}K|\Phi_{n-1}\rangle + \mathcal{O}(g_s^{n+1}). \quad (9.44)$$

The procedure to solve these equations is as follows:

1. We begin by taking $|\phi_n\rangle$ to be an arbitrary vector in V_m , labelled by a finite number of parameters.
2. We then solve (9.43) for $|\Phi_\ell\rangle$ iteratively, keeping terms up to order g_s^n in the expression for K . Since $k^2 + m^2 = \mathcal{O}(g_s)$, and the projection operator $(1 - P)$ removes states with $\hat{M}^2 = m^2$, the $1/L_0^+$ acting on the state on the right hand side gives finite result without any inverse power of g_s . Repeating this process n -times we arrive at $|\Phi_n\rangle$. However the result depends linearly on the particular vector $|\phi_n\rangle$ that we have chosen in the subspace projected by P .
3. We now substitute the expression for Φ_{n-1} computed in the previous steps into (9.44). This gives a linear equation for $|\phi_n\rangle$. Since $|\phi_n\rangle$ takes value in finite dimensional Hilbert space, these equations can be solved explicitly. The solutions that exist for generic momentum k can be identified as pure gauge states and be discarded. However there will be additional solutions for special values of k^2 close to $-m^2$. These represent physical states and the corresponding values of $-k^2$ give the physical mass² of the states.

To show that this procedure generates a solution to (9.38) to order g_s^n , we can proceed as follows. First of all, using (9.43), (9.44), and the fact that K is of order g_s , one can prove iteratively in ℓ that $(Q + \mathcal{G}K)|\Phi_\ell\rangle$ vanishes to order $g_s^{\ell+1}$, $(1 - P)Q\mathcal{G}K|\Phi_\ell\rangle$ vanishes to order $g_s^{\ell+2}$ and $|\Phi_\ell\rangle$ and $|\Phi_{\ell-1}\rangle$ differ by term of order g_s^ℓ . This gives

$$(Q + \mathcal{G}K)|\Phi_n\rangle = \mathcal{O}(g_s^{n+1}), \quad (9.45)$$

which is the desired result. An explicit demonstration of this procedure for computing renormalized masses of scalars and fermions can be found in [207].

Since for vacuum shift the subtleties arise in sector with $L_0^+ = 0$, we could simplify the presentation by working with an effective action where we have fully integrated out the fields with $L_0^+ \neq 0$, arriving at 1PI effective action of $L_0^+ = 0$ states only. Similarly for mass renormalization the subtleties arise in the sector with $\hat{M}^2 = m^2$ and $k^2 + m^2 = \mathcal{O}(g_s)$. Therefore one could work with an effective action where we integrate out all fields other than in these sectors.

9.4 D-instanton contribution to string amplitudes

D-instantons are D-branes with Dirichlet boundary conditions on all directions in space-time including (Euclidean) time. A Dp brane extends over p spatial dimensions and time. A D0 brane is thus a point in space, extending over all time. A D-instanton can be thought as a D(-1) brane. It has a finite action, which can be obtained either by analyzing the partition function on an annulus with boundaries lying on the instanton³⁰ or by formulating an open string field theory on the background of a Dp brane with $p \geq 0$ and finding a soliton solution representing the instanton. The action \mathcal{T} of

³⁰In CFT the action of the instanton can be obtained by looking at the amplitude for an annulus with D-instanton boundary conditions and examining the factorization in the closed string channel, a procedure used to calculate the tension of branes [210,211]. The familiar formula for the tension of a Dp brane, evaluated for $p = -1$ gives the instanton ‘tension’, which is its action.

that solution is the D-instanton action, and it is of the form $\mathcal{T} = A/g_s$ where A is independent of the string coupling. As a result the D-instanton gives a non-perturbative contribution to the string amplitudes carrying an overall factor $e^{-\mathcal{T}}$. This is to be contrasted with the instanton corrections in quantum field theories which are suppressed by e^{-B/g_s^2} for some g_s independent constant B .

In our analysis we shall use a slightly generalized notion of D-instanton where we allow Neumann boundary condition along some of the compact directions of space-time. These are often referred to as compact Euclidean D-branes. They carry finite action given by the tension of the brane integrated along the D-brane world-volume and play the same role in string theory as ordinary D-instantons. Furthermore the analysis of the contribution from these amplitudes encounter the same subtleties as D-(-1)-branes and hence these systems can be discussed together.

Any generic amplitude in string theory will receive D-instanton contribution, but they are particularly important if the amplitude under consideration vanishes in perturbation theory. Examples are amplitudes in type IIB string theory which respect shift symmetry of the RR scalar field in perturbation theory, but this symmetry is violated by D-instanton induced amplitudes. Another example involves type IIA or type IIB string theory on Calabi-Yau orientifolds where certain terms in the superpotential are prevented from arising in perturbation theory due to the presence of shift symmetry of some scalars, but can arise due to D-instanton effects.

As for all D-branes, the excitations on the D-instanton are open strings with boundaries lying on the instanton. Since instantons are transient objects, however, these open strings are not allowed asymptotic states. Like the modes of an ordinary instanton, they describe fluctuations in (string) fields around a non-trivial saddle point and must be integrated out. The allowed asymptotic states in the theory could be closed strings and/or open strings on other D-branes whose world-volume extends along the time direction.

In principle the D-instanton contribution to an amplitude is obtained by summing over world-sheet diagrams where we allow the world-sheet to have boundaries, with D-instanton boundary condition at the boundaries. In practice such computation runs into divergences from the boundaries of the moduli spaces of Riemann surfaces. As we shall explain below, these divergences have similar origin as the divergences that arise in the study of mass renormalization and vacuum shift.

Since string field theory is designed to formally reproduce the world-sheet results, we can use the appropriate open-closed string field theory to compute D-instanton induced amplitudes. This string field theory has an unusual feature: since the open strings on the D-instanton have Dirichlet boundary condition along all non-compact directions, they do not carry any momentum along non-compact directions. Therefore they represent discrete modes rather than fields. Among them are zero modes with zero L_0 eigenvalues. Therefore in the Siegel gauge their propagator diverges and whenever such modes propagate as an internal state in a Feynman diagram we get a divergent result. As usual, in the world-sheet formalism these divergences arise whenever the Riemann surface degenerates and there is no systematic procedure to regulate them and extract an unambiguous finite answer. In string field theory, however, we can draw insights from quantum field theory and try to follow the same rules that we use while dealing with the zero modes of ordinary instantons.

It turns out that there are two issues in this analysis which need separate discussion: first, the overall normalization of the amplitude, affecting even the leading order result and, second, the higher order corrections to the amplitude. We shall discuss them in turn. While carrying out this analysis we need to keep in mind some specific features of D-instanton contributions to amplitudes that are not present in open-closed string field theory amplitudes in the presence of D-branes that extend along the time direction.

1. All D-instanton amplitudes are multiplied by a factor of $e^{-\mathcal{T}}$ where \mathcal{T} is the ‘tension’ of the D-instanton. This is the usual suppression factor that accompanies the contribution from the non-perturbative saddle points in a path integral. From the world-sheet perspective this can be viewed as the exponential of the disk partition function (with Dirichlet boundary condition), but this will not be important for our analysis.
2. The space-time translation invariance is broken by the Dirichlet boundary condition on the open string along the non-compact directions. Therefore individual world-sheet diagrams do not conserve space-time momenta, although, as will be discussed later, at the end we recover momentum conservation after proper treatment of the zero modes. Non-conservation of the momenta by individual world-sheet diagrams means that disconnected world-sheets are on the same footing as the connected ones. This is to be contrasted with the world-sheet diagrams associated with closed string theory or open-closed string theory in the presence of space filling D-branes, where disconnected world-sheets have separate momentum conservation on each connected component, and as a result such world-sheets contribute only in a codimension one or higher subspace of the full kinematic space.

9.4.1 Overall normalization

Let us consider the D-instanton contribution to an amplitude for a fixed set of external closed strings. Since each disk is accompanied by a factor of $1/g_s$ and each annulus is accompanied by a factor of $g_s^0 = 1$, the leading contribution to an amplitude with n external closed strings comes from n disconnected disks, each carrying a single closed string insertion, and arbitrary number of annuli with no insertions. Note that disks with no insertion are already counted in the $e^{-\mathcal{T}}$ factor.

The sum over different number of annuli can be exponentiated to give the exponential of the annulus partition function. This is a universal factor that appears as an overall multiplicative factor in all amplitudes in a given instanton sector. However, the world-sheet expression for the annulus partition function often diverges. Our goal in this section will be to identify the origin of these divergences and discuss how to rectify them with the help of string field theory.

For simplicity we shall focus on bosonic string theory but the formalism can be generalized to superstring theories as well [212–216]. Generically the exponential of the annulus partition function, denoted by N , takes the form:

$$N \equiv \exp \left[\int_0^\infty \frac{dt}{t} F(t) \right], \quad (9.46)$$

where $F(t)$ has the form:

$$F(t) = \frac{1}{2} \text{Tr} \left\{ (-1)^f e^{-2\pi t L_0} \right\}, \quad (9.47)$$

with the trace running over all the Siegel gauge open string states on the D-instanton. $(-1)^f$ denotes the Grassmann parity of the open string field component multiplying the state in the expansion of the string field. The factor of two in the denominator in (9.47) appears because the annulus has a discrete Z_2 symmetry under which the world-sheet coordinates change sign. The Siegel gauge condition on the states is needed because the annulus has zero modes of b and c ghosts that must be removed, reflecting the fixing of the translation symmetry on the world-sheet.

If $|\phi_b\rangle$ and $|\phi_f\rangle$ denote a basis of states in the Siegel gauge, multiplying Grassmann even and Grassmann odd string fields respectively, and h_b and h_f represent the conformal weights of $|\phi_b\rangle$ and

$|\phi_f\rangle$ respectively, then we can express (9.46) as,

$$N = \exp \left[\int_0^\infty \frac{dt}{2t} \left(\sum_b e^{-2\pi t h_b} - \sum_f e^{-2\pi t h_f} \right) \right]. \quad (9.48)$$

The integral over t can have divergences from the $t = 0$ and the $t = \infty$ ends of the integral. The divergence from the $t = 0$ end can be attributed to the closed string channel, either from closed string tachyons or from massless closed string states. Such divergences, if present, represent genuine problems with the theory or with the choice of vacuum of the theory. In the following we shall assume that such divergences are absent. Examples of such cases are critical bosonic and superstring theories in more than two non-compact dimensions. The divergence from the $t \rightarrow \infty$ end are associated with light open string states on the D-instanton and will be the focus of our analysis.

The absence of a divergence in the $t \rightarrow 0$ limit implies that we have equal number of Grassmann even and Grassmann odd modes, in an appropriately regulated sense. We can now use the identity,

$$\int_0^\infty \frac{dt}{2t} \left(e^{-2\pi h_b t} - e^{-2\pi h_f t} \right) = \ln \sqrt{\frac{h_f}{h_b}}, \quad (9.49)$$

to conclude that

$$N = \prod_{b,f} \sqrt{\frac{h_f}{h_b}} = (\text{sdet}(L_0))^{-1/2}. \quad (9.50)$$

This in turn can be given the following path integral representation in the open string field theory on the D-instanton. Let $\{|\phi_r\rangle\}$ be a basis of open string states in the Siegel gauge, normalized so that

$$\text{sdet} M = 1, \quad \text{with} \quad M_{rs} \equiv \langle \phi_r | c_0 | \phi_s \rangle'. \quad (9.51)$$

Since open strings living on the D-instanton do not carry any continuous momentum, the indices r, s are discrete. We can now give a ‘path integral’ description of N using the identities

$$\int \frac{d\phi_b}{\sqrt{2\pi}} e^{-\frac{1}{2} h_b \phi_b^2} = h_b^{-1/2}, \quad \int dp_f dq_f e^{-h_f p_f q_f} = h_f, \quad (9.52)$$

holding for Grassmann even ϕ_b and Grassmann odd p_f and q_f . If we expand the Siegel gauge open string field as

$$|\psi_o\rangle = \sum_r |\phi_r\rangle \psi_r, \quad (9.53)$$

one can confirm that

$$N = (\text{sdet}(L_0))^{-1/2} = \int \prod_r D\psi_r \exp \left[\frac{1}{2} \langle \psi_o | c_0 L_0 | \psi_o \rangle' \right], \quad (9.54)$$

where the integration measure $D\psi_r$ is defined to be $d\psi_r/\sqrt{2\pi}$ for Grassmann even ψ_r and $d\psi_r$ for Grassmann odd ψ_r . In writing this we have used the result that for any fixed L_0 eigenvalue, the Grassmann odd ψ_r 's always come in pairs since they have even ghost number and in the action a ghost number n state is paired with a ghost number $(2 - n)$ state.

Note that (9.49) holds only when $h_b > 0$ and $h_f \neq 0$, but we shall use (9.54) as the definition of N even when L_0 has negative or vanishing eigenvalues, since from the perspective of string field theory, this is the expression that arises naturally from the one-loop determinant of fluctuations around the

instanton in the Siegel gauge. For negative h_b we need to take the integration contour of ϕ_b along the imaginary axis, which is in fact the steepest descent contour of ϕ_b . This gives us back $h_b^{-1/2}$. For vanishing h_b or h_f we have open string zero modes. Integrations over these zero modes naively diverge for bosonic zero modes and vanish for fermionic zero modes, and we need to understand the physical origin of the zero modes in order to deal with them. This is what we shall discuss now.

In the Siegel gauge there are two types of zero modes. Let us begin with the first type. If we denote by α_n^μ the oscillators associated with the flat directions transverse to the D-instanton, normalized so that $[\alpha_m^\mu, \alpha_n^\nu] = m \eta^{\mu\nu} \delta_{m+n,0}$, then we have $L_0 = 0$ states of the form $c_1 \alpha_{-1}^\mu |0\rangle$. If we denote by ξ_μ the coefficients multiplying these states in the expansion of the open string field, then ξ_μ 's represent Grassmann even zero modes. Physically these are related to the collective coordinates of the D-instanton that correspond to shift δy^μ of the D-instanton position y^μ along the transverse directions. The precise relation between ξ^μ and δy^μ may be found by comparing the coupling of ξ^μ to a set of closed strings carrying total momentum p to the expected coupling of these closed strings to y^μ via the $e^{ip \cdot y}$ term. At the leading order the coupling of ξ^μ to closed strings is via the disk amplitude, and the comparison yields [212, 217],

$$\xi^\mu = \frac{1}{\sqrt{2} \pi g_o} \delta y^\mu, \quad (9.55)$$

where g_o is the open string coupling in the instanton open string field theory, related to its action \mathcal{T} via $\mathcal{T} = 1/(2\pi^2 g_o^2)$. As in the case of collective modes of the instanton in a quantum field theory, we need to carry out integration over these modes at the end. Even though the annulus amplitude does not depend on the D-instanton position, other components of the world-sheet involving external closed strings carrying momentum insertions do depend on y through the $e^{ip \cdot y}$ terms. Therefore after changing variables from ξ^μ to y^μ , the integration over these zero modes will produce the usual momentum conserving delta function $(2\pi)^D \delta^{(D)}(\sum_i p_i)$ where D is the number of non-compact directions.

The other type of zero modes arise from the $L_0 = 0$ Siegel gauge states $|0\rangle$ and $c_1 c_{-1} |0\rangle$. Since these states carry even ghost number, the coefficients p, q multiplying these states in the expansion of the string field are Grassmann odd:

$$|\psi_o\rangle = p|0\rangle + q c_1 c_{-1} |0\rangle + \dots \quad (9.56)$$

To find the physical origin of these modes, let us deform the theory so that the vacuum has conformal weight h . This can be achieved, *e.g.* by putting slightly different boundary conditions on the two boundaries attached to the instanton, or considering a Dp -brane instead of D-instanton so that we can consider momentum carrying states.³¹ For definiteness we shall assume that the two boundaries attached to the instanton are displaced in the 0-direction by a small amount to produce the weight h of the vacuum. With the dimension h vacuum and the string field (9.56), the Euclidean action has a term

$$\frac{1}{2} \langle \psi_o | c_0 L_0 | \psi_o \rangle' = -hpq + \dots, \quad (9.57)$$

and integration over p, q will produce a factor of h as part of $(\text{sdet}(L_0))^{1/2}$.

To find the physical interpretation of the modes p, q , let us consider the classical open string field theory before gauge fixing. In this theory the fields p, q are absent since they multiply string states of

³¹The purpose of this deformation is to see how string field theory and the world-sheet approach give the same results in the absence of zero modes. Eventually we shall set $h = 0$ where the world-sheet formalism breaks down, but string field theory still gives well defined results.

ghost number other than one, but there are additional string field components that multiply states of ghost number one that do not satisfy the Siegel gauge condition. Let us suppose that ϕ is the (bosonic) mode that multiplies the out of Siegel gauge state $c_0|0\rangle$ so that the string field contains the term

$$|\psi_o\rangle = i\phi c_0|0\rangle + \dots \quad (9.58)$$

before gauge fixing. With a bosonic parameter θ , we have $Q\theta|0\rangle = h\theta c_0|0\rangle$, so that under a gauge transformation with gauge parameter $i\theta|0\rangle$ we get

$$\delta\phi = h\theta. \quad (9.59)$$

Therefore if we fix the gauge by setting $\phi = 0$, as in Siegel gauge, we shall get a Jacobian h , which we are supposed to represent as integral over Fadeev-Popov ghosts. Since integration over p, q produces precisely this factor, we see that p, q has the interpretation of Fadeev-Popov ghosts that arise from fixing the gauge transformation generated by $i\theta|0\rangle$ by setting $\phi = 0$. Therefore in the gauge invariant form of the path integral, the integration over p, q can be replaced by:

$$\int dp dq \rightarrow \int d\phi e^{S_{\phi, \xi^0}} / \int d\theta. \quad (9.60)$$

Here S_{ϕ, ξ^0} now stands for the part of the gauge invariant Euclidean action that depends on ϕ and ξ^0 :

$$S_{\phi, \xi^0} = \frac{1}{2} \langle \psi_o | Q | \psi_o \rangle' \Big|_{\phi, \xi^0} = - \left(\phi - \sqrt{\frac{h}{2}} \xi^0 \right)^2. \quad (9.61)$$

This is invariant under the gauge transformation

$$\delta\phi = h, \quad \delta\xi^0 = \sqrt{2h}. \quad (9.62)$$

Note that ξ^0 plays a special role since we have displaced the boundary conditions at the two ends of the open string along the zeroth direction. The other ξ^i 's will just contribute gauge invariant $h(\xi^i)^2/2$ terms. Eventually when we take $h \rightarrow 0$ limit, this special role of the 0 direction will disappear.

For $h = 0$ the gauge fixing procedure breaks down: since ϕ no longer transforms under the gauge transformation generated by θ , $\phi = 0$ is not a good choice of gauge. This is reflected in the vanishing of the Jacobian factor h . However, the gauge invariant form of the path integral given on the right hand side of (9.60) still makes sense and we shall use this to compute N . The integration over ϕ now produces

$$\int d\phi e^{-\phi^2} = \sqrt{\pi}. \quad (9.63)$$

To calculate $\int d\theta$, we note that the gauge transformation parameter θ is the analog of the usual $U(1)$ gauge transformation parameter on a D-brane; however since open strings on a D-instanton do not carry momentum, the gauge transformation is rigid. Let α be the parameter of this rigid $U(1)$ transformation, normalized such that an open string ending on the D-instanton picks up a phase $e^{i\alpha}$ under this transformation. Therefore α has period 2π . Comparing the infinitesimal version of this gauge transformation law to the string field theory gauge transformation by the parameter $i\theta|0\rangle$, we can find the relation between θ and α . At the leading order this takes the form [217]:

$$\theta = \alpha/g_o. \quad (9.64)$$

This gives

$$\int d\theta = 2\pi/g_o. \quad (9.65)$$

(9.55), (9.60), (9.63) and (9.65) now show that the integration over the zero modes ξ^μ, p, q can be replaced by

$$\int dp dq \prod_\mu \frac{d\xi^\mu}{\sqrt{2\pi}} \rightarrow (2\pi\sqrt{\pi} g_o)^{-d} \frac{g_o}{2\pi} \sqrt{\pi} \int \prod_\mu dy^\mu. \quad (9.66)$$

As already mentioned, the integration over y^μ is carried out at the end and produces the momentum conserving delta function. The integration over the $L_0 > 0$ modes of the string field are Gaussian integrals that can be performed explicitly using (9.52). Therefore the normalization constant may be written as

$$N = (2\pi\sqrt{\pi} g_o)^{-d} \frac{g_o}{2\pi} \sqrt{\pi} \prod_b' h_b^{-1/2} \prod_f' h_f^{1/2} (2\pi)^{d\delta^{(d)}} \left(\sum_i p_i \right), \quad (9.67)$$

where the primes on the products indicate that zero modes are excluded from this product.

This formula involves infinite products of h_b 's and h_f 's and is not always easy to use unless there are cancellations. We can simplify this by using (9.49) in reverse, expressing the infinite product as exponentials of an integral for modes with $h_b, h_f > 0$. However we need equal number of Grassmann even and Grassmann odd modes to apply (9.49) since (9.49) pairs a bosonic mode with a fermionic mode. This can be achieved by dividing the set ' into two sets: '' containing a finite number of h_b 's and h_f 's that include all tachyonic modes and possibly some $L_0 > 0$ modes, and ''' containing infinite but equal numbers of strictly positive h_b 's and h_f 's. We can then write

$$\prod_b' h_b^{-1/2} \prod_f' h_f^{1/2} = \prod_b'' h_b^{-1/2} \prod_f'' h_f^{1/2} \exp \left[- \int_0^\infty \frac{dt}{2t} \left(\sum_b''' e^{-2\pi t h_b} - \sum_f''' e^{-2\pi t h_f} \right) \right]. \quad (9.68)$$

The result can be shown to be independent of how we divide the set ' into '' and '''.

A final comment on the normalization factor: sometimes the actual integration contour over the open string modes on the D-instanton does not include the full steepest descent contour spanning the range $(-\infty, \infty)$ in (9.52), but only a fraction f of the steepest descent contour [217]. This usually happens in the presence of tachyonic modes. In such cases the normalization constant N contains an extra factor of f .

The analysis of the normalization for D-instanton amplitudes in superstring theory is similar. The only new feature is that besides having the bosonic zero modes associated with broken translation symmetry, we now also have fermionic zero modes associated with broken supersymmetry. We treat them in the same way as the bosonic zero modes, separating out their contribution and integrating over them at the end. The last step requires inserting vertex operators of the fermionic zero modes, arising in the open string sector, into the correlation functions as if they are external states, even though physically these amplitudes represent scattering amplitudes of external closed string states only [212, 218, 219].

The procedure outlined in this section has been tested against known results from dual descriptions in various examples [212, 214, 215, 217, 220–223].

9.4.2 Higher order corrections to the instanton amplitudes

When we consider higher order corrections to the instanton amplitudes we get additional divergences from degenerate Riemann surfaces. In the language of string field theory these divergences come

from on-shell / tachyonic internal propagators in Feynman diagrams and can be dealt with by using standard quantum field theory methods. For example when there is open string degeneration the divergences are associated with open string zero modes or tachyonic modes propagating in the intermediate channel. For the zero modes we simply remove their contribution to the propagator by hand since we carry out path integral over zero modes at the end, as discussed in section 9.4.1. For the tachyonic modes we replace the world-sheet contribution to their propagator $\int dt e^{-2\pi t L_0}$ by $1/(2\pi L_0)$ even for negative L_0 . This produces manifestly finite results. However to implement this in practice, we need to first express the amplitude as a sum over Feynman diagrams in string field theory, so that we can identify which part of the amplitude is coming from the zero mode or tachyonic mode exchange diagrams and remove only that part from the amplitude. As usual, this depends on the choice of the local coordinates at the punctures used to define the vertex, but the final result is expected to be independent of this choice.

Additional contributions to the higher order terms come from the fact that the relations (9.55) and (9.64) get modified by higher order corrections, since the coupling of the modes ξ^μ to closed strings as well as the string field theory gauge transformation laws generated by the state $\theta|0\rangle$ can receive higher order corrections. The final result for higher order corrections is the combined effect of all these corrections.

The procedure described here has also been tested against known results from a dual description in various examples [114, 219, 224–226]. Finally, note that so far we have only described the contribution to the amplitude due to a single D-instanton. In section 9.5 we shall discuss some aspects of the contribution from more than one instanton.

9.5 D-instanton induced effective action

D-instantons are transient objects and do not support asymptotic states. Instead they are saddle points of the Euclidean path integral that contribute to the Wilsonian effective action of closed string field theory (open-closed string field theory if the background contains D-branes extending in the time direction). We have seen earlier that the perturbative Wilsonian effective action satisfies the quantum BV master equation, just as the parent theory does. Therefore it is natural to ask if the Wilsonian effective action that includes D-instanton contributions also satisfies the same property [227].

In order to address this issue we shall integrate out the open string modes on the D-instanton, regulating the infrared divergences using open string field theory as described in sections 9.4.1 and 9.4.2. We consider first a single D-instanton contribution. As mentioned at the beginning of section 9.4, there are two additional effects that we need to take into account. First, the effective action is accompanied by a constant multiplicative factor $\mathcal{N} = e^{-\mathcal{T}} N$ that includes the $e^{-\mathcal{T}}$ factor associated with the D-instanton action and the normalization factor N associated with the annulus amplitude discussed in section 9.4.1. Second, disconnected world-sheets also contribute to the D-instanton induced effective action with the same overall normalization factor \mathcal{N} . Let us denote by S_1 the single D-instanton contribution to the Wilsonian effective action, but associated only with a single connected world-sheet, so that it does not include the factor of \mathcal{N} . After taking into account the contribution from disconnected world-sheets, the net contribution to the effective action from the one-instanton sector exponentiates and can be written as

$$\mathcal{N} (e^{S_1} - 1) . \tag{9.69}$$

Let S_0 denote the perturbative contribution to the Wilsonian effective action. Then the net

contribution to the Wilsonian effective action may be written as

$$S = S_0 + \mathcal{N} (e^{S_1} - 1) + \mathcal{O}(\mathcal{N}^2), \quad (9.70)$$

where terms of order \mathcal{N}^2 or higher represent the contribution from two or more instantons. Note that we have assumed for simplicity that there is only one kind of instanton, but this analysis can be easily be generalized to the cases where the theory contains different kinds of instantons.

We shall now verify that S given in (9.70) satisfies the BV master equation. First we recall that the perturbative contribution S_0 satisfies the quantum BV master equation:

$$\frac{1}{2}\{S_0, S_0\} + \Delta S_0 = 0. \quad (9.71)$$

The action $S_0 + S_1$ will also satisfy the BV master equation since it is obtained by starting with the master action of the Wilsonian effective action of the conventional open-closed string field theory, treating the D-instantons as conventional D-branes so that there is no multiplicative factor \mathcal{N} and no disconnected diagram contribution. This gives

$$\frac{1}{2}\{S_0 + S_1, S_0 + S_1\} + \Delta(S_0 + S_1) = 0. \quad (9.72)$$

Combining (9.71) and (9.72) we get

$$\{S_0, S_1\} + \frac{1}{2}\{S_1, S_1\} + \Delta S_1 = 0. \quad (9.73)$$

Using (9.70) we now write

$$\frac{1}{2}\{S, S\} = \frac{1}{2}\{S_0, S_0\} + \mathcal{N}\{S_0, S_1\}e^{S_1} + \mathcal{O}(\mathcal{N}^2), \quad (9.74)$$

and

$$\Delta S = \Delta S_0 + \mathcal{N}\Delta e^{S_1} = \Delta S_0 + \mathcal{N}\left(\frac{1}{2}\{S_1, S_1\} + \Delta S_1\right)e^{S_1} \quad (9.75)$$

Using (9.71) and (9.73) we now get

$$\frac{1}{2}\{S, S\} + \Delta S = \mathcal{O}(\mathcal{N}^2). \quad (9.76)$$

Thus S satisfies the BV master equation to order \mathcal{N} . We shall now show that the order \mathcal{N}^2 terms cancel once we take into account two instanton contribution to the effective action [227].

For two identical instantons, there can be different kinds of connected world-sheets:

1. World-sheets with no boundaries on the instantons: These contribute to S_0 .
2. Connected world-sheets with boundaries, but with all the boundaries lying on one of the two instantons: This contribution can be identified as $2S_1$, with the factor of 2 representing that the boundary can lie on one of the two D-instantons.
3. Connected world-sheets with boundaries with at least one boundary lying on the first instanton and at least one boundary lying on the second instanton. We denote its contribution to the effective action by S_2 .

For the same reasons explained above for the case of $S_0 + S_1$, the action $S_0 + 2S_1 + S_2$ will satisfy the standard BV master equation:

$$\frac{1}{2}\{S_0 + 2S_1 + S_2, S_0 + 2S_1 + S_2\} + \Delta(S_0 + 2S_1 + S_2) = 0. \quad (9.77)$$

Combining this with (9.71) and (9.73) we get,

$$\{S_0, S_2\} + 2\{S_1, S_2\} + \{S_1, S_1\} + \frac{1}{2}\{S_2, S_2\} = 0. \quad (9.78)$$

The actual contribution to the Wilsonian effective action at the two instanton order differs from $S_0 + 2S_1 + S_2$ due to the following reasons. First of all we have to include contributions from disconnected world-sheets, but at least one connected world-sheet with one boundary on the first instanton and one boundary on the second instanton. Otherwise the contribution to the amplitude can be regarded as second order term induced by the single instanton effective action. Second, the contribution will have to be multiplied by \mathcal{N}^2 , where \mathcal{N} is the same constant that multiplies the single instanton effective action. The net contribution to the effective action up to two instanton order is then given by:

$$S = S_0 + \mathcal{N} (e^{S_1} - 1) + \frac{1}{2}\mathcal{N}^2(e^{S_2} - 1) e^{2S_1} + \mathcal{O}(\mathcal{N}^3), \quad (9.79)$$

The factor of 1/2 is a reflection of the fact that the exchange of two identical instantons do not generate a new contribution. This symmetry is not captured in S_2 itself which treats the two instantons as distinct. The subtraction of 1 reflects that we need at least one world-sheet component with one boundary on the first instanton and one boundary on the second instanton. The factor of e^{2S_1} reflects that once we have one world-sheet with one boundary on the first instanton and one boundary on the second instanton, we can include any number of other world-sheet components whose boundaries lie wholly on the first instanton or wholly on the second instanton.

It is now easy to verify using (9.71), (9.73) and (9.78) that S defined in (9.79) satisfies the BV master equation [227]:

$$\frac{1}{2}\{S, S\} + \Delta S = \mathcal{O}(\mathcal{N}^3). \quad (9.80)$$

We expect that the order \mathcal{N}^3 terms are cancelled when including the effect of three instanton contribution.

9.6 Unitarity and crossing symmetry

In this subsection we shall briefly describe how string field theory can be used to prove the unitarity and crossing symmetry of string amplitudes.

9.6.1 Unitarity

We can use string field theory to prove the unitarity of perturbative string amplitudes. The analysis can be divided into three parts:

1. First we need to show that it is possible to impose appropriate reality condition on the string fields such that the string field theory action is real. A reality condition essentially relates the complex conjugate of the string fields to the original string field, It can take different form for different components of the string field, e.g. $\psi_r^* = \psi_r$ or $\psi_r^* = -\psi_r$.
2. We can then use the reality of the action to prove the Cutkosky rule that relates the anti-hermitian part of an amplitude to the sum over all its cut diagrams. For $S = 1 + iT$, the cutting rule is the statement

$$T - T^\dagger = i \sum_n T^\dagger |n\rangle \langle n| T \quad \Leftrightarrow \quad \sum_n S^\dagger |n\rangle \langle n| S = 1, \quad (9.81)$$

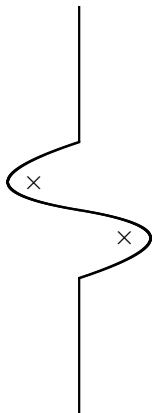

Figure 22: This figure shows a typical integration contour over the energy flowing along an internal loop of the string field theory Feynman diagram. When the external momenta are purely imaginary then we can take the internal energies also to be purely imaginary and the propagators have no poles. However when the external momenta are deformed into the complex plane, the poles of the internal propagators could approach the imaginary axis of the internal energy. In that case we deform the integration contour away from the poles, shown by \times , keeping its ends fixed at $\pm i\infty$ so that the integrand falls off at infinity.

where the sum over n runs over an orthonormal basis of states in the theory. This would be the statement of unitarity if the sum over n runs over only the physical states. The Cutkosky rules, however, are derived in the gauge fixed theory, where the sum also includes unphysical and pure gauge states. Therefore (9.81) does not quite prove unitarity.

3. In order to address the issue mentioned above, we need to show that in (9.81) the contribution due to unphysical and pure gauge states in the sum over n cancels, and hence the sum over n can be restricted to physical states only.

Each of these steps can be carried out in string field theory, *e.g.* the proof of reality of the action may be found in [20] and the proof of decoupling of the unphysical and pure gauge states can be found in [228]. The main subtlety arises in the second step [229]. The usual proof of Cutkosky rules in perturbative quantum field theory uses the largest time equation [230] that uses some specific property of the position space Green's functions. The position space Green's functions, however, are not well defined in string theory because the off-shell string amplitudes depend on external momenta by the exponential of a quadratic function of momenta – this can be seen, *e.g.* by noting that if the local coordinate w at a puncture at $w = 0$ is related to the coordinate z of the Riemann surface as $z = f(w)$, then the interaction vertex/off-shell amplitude contains a factor of $|f'(0)|^{k^2/2}$ since the conformal weight of the external off-shell vertex operator of momentum k has a contribution of the form $(\bar{h} + k^2/4, h + k^2/4)$ where \bar{h}, h are k independent constants. Due to this exponential factor the Fourier transform of the off-shell Green's function produces a highly non-local function in the position space and is hard to analyze. For this reason we have to try to prove Cutkosky rules directly in momentum space.

Another difference with the usual quantum field theory lies in the choice of contour for integration over the internal loop energies. Due to the $|f'(0)|^{k^2/2}$ factors accompanying the vertices, we can ensure that the integrand of a Feynman diagram falls off rapidly for large positive k^2 by choosing $f'(0)$'s to be small. This ensures ultraviolet finiteness of the loop momentum integrals provided we choose the contour of integration over each loop momentum k so that k^2 approaches ∞ as the contour approaches

infinity. This in particular requires that the energy integrals run along the imaginary axis, at least for large energies. However, as explained below, for Lorentzian external momenta it may not be possible to keep the energy integration contours fully along the imaginary axis. The strategy that one follows is the following [229]. We begin by taking the external momenta such that the spatial momenta are real and energies are purely imaginary. In this case one can take the integration contours for loop energies fully along the imaginary axes without encountering any pole of the propagator, since all the internal energies are purely imaginary and hence the denominator factors in the propagators remain positive. We then rotate the phases of all the external energies simultaneously towards real values, so that the positive (negative) imaginary energies approach the positive (negative) real energies along the first (third) quadrant of the complex energy plane. Now even if we take the internal loop energies (in some fixed labelling) to be all imaginary, due to energy conservation at the interaction vertices some of the internal propagators will carry complex energy. Therefore it is no longer guaranteed that the propagators will remain finite along the integration contour over loop energies running along the imaginary axes. Viewed in the complex loop energy plane, one can say that some of the poles of the integrand can approach the integration contour as we deform the external momenta. We deal with this situation by deforming the energy integration contours keeping their ends fixed at $\pm i\infty$ so as to avoid having the poles cross the integration contour. This has been shown in Fig. 22 with the crosses labeling the pole positions. It was shown in [229] that as long as the phases of all the external energies are kept the same, this can be done all the way to (almost) real values of the energies and the resulting integrals can be taken to be the definition of the string amplitudes. This is the analog of the $i\epsilon$ prescription for the propagators in usual quantum field theories. Furthermore the amplitudes defined this way satisfy Cutkosky rules, establishing unitarity of string amplitudes to all orders in perturbation theory.³²

Unitarity of the D-instanton contribution to string amplitudes can be proven in a similar way. Here an additional subtlety arises in proving the reality of the action. Often in D-instanton systems we encounter tachyonic open string modes, and as a result the steepest descent contour along which we need to carry out the integration over the open string modes may lie along the imaginary axis, producing extra factors of i that can violate the reality of the D-instanton induced effective action. In such cases one either has to find a physical explanation for the lack of unitarity or find an appropriate prescription that restores reality of the effective action. An example of the first kind is provided by two dimensional non-critical bosonic string theory where the D-instanton induced effective action has an imaginary part. Comparison of the results with that of a dual matrix model shows that the breakdown of unitarity can be attributed to the transition from the closed string states to a state of the system that does not have a closed string description [232]. This leads to an apparent lack of unitarity of the closed string amplitudes. An example of the second kind is provided by D-instanton anti-D-instanton contribution to the amplitudes in critical string theory. In this case the exponential of the annulus partition function develops a pole when the separation between the instanton and the anti-instanton reaches a critical distance 2π , and in order to get a real contribution to the effective action, one needs to integrate over the relative separation using principle value prescription.

³²The choice of integration contour described here can be shown to be equivalent to Witten's $i\epsilon$ prescription [39] for string amplitudes [231]. The latter prescription can be implemented directly at the level of the world-sheet expression for string amplitudes but it is not clear how to prove Cutkosky rules directly in this formalism.

9.6.2 Crossing symmetry

Another desirable property of quantum field theory is crossing symmetry: the property that the S-matrix for the process $A + B \rightarrow C + D$ is related to that of the process $A + \bar{C} \rightarrow \bar{B} + D$ via suitable analytic continuation where bar denotes anti-particles. Note that both these S-matrices are given by the same Green's function with different choice of external momenta. Thus the key question is whether in the space of complex but on-shell external momenta one can find a path that connects the two momentum configurations, with the Green's function remaining analytic all along this path.

In local quantum field theory, crossing symmetry was proved in [233,234] using an indirect method involving several steps.

1. One first proves that the off-shell Green's functions are analytic in a certain domain in the space of complex external momenta. This domain is known as the primitive domain of analyticity. The proof uses vanishing of commutators of local operators for space-like separated points.
2. The primitive domain of analyticity can be shown to have no overlap with the domain in which the external momenta are on-shell. Therefore it would seem that the analyticity of the off-shell Green's functions in the primitive domain of analyticity is of no use in the analysis of crossing symmetry which is a property of the S-matrix. Nevertheless, using certain properties of functions of many complex variables, one can show that any function that is analytic in the primitive domain of analyticity is actually analytic in a bigger domain known as the envelope of holomorphy. The envelope of holomorphy does have overlap with domains in which the external momenta are on-shell.
3. One then shows that in the intersection of the envelope of holomorphy and the subspace of complex external momenta where all external momenta are on-shell, one can find a suitable path that connects the process $A + B \rightarrow C + D$ to the process $A + \bar{C} \rightarrow \bar{B} + D$.

This QFT proof, however, required that the theory does not contain any massless states propagating in loops.

As already discussed, the off-shell Green's functions in string field theory carry multiplicative factors of $\exp[-C_{ij}k_ik_j]$ for external momenta k_i and constants C_{ij} , and therefore do not have good locality property in the position space. As a result the first step breaks down. Nevertheless, a perturbative proof of the holomorphy of the off-shell Green's function in the primitive domain of analyticity was given in [235] by explicit analysis of the string field theory Feynman diagrams and the prescription given in [229] for choosing the contours along which the internal energies are integrated. Once the first step of the proof is carried out, the second step goes through automatically since it relies only on general properties of functions of many complex variables, irrespective of how they arise. The third step can also be carried out following [234], since the only additional property of quantum field theory that the analysis of [234] uses is invariance of the off-shell Green's functions under Lorentz transformation with complex parameters. This is also valid for string theory amplitudes.

Note, however that the proof assumes absence of massless states, which is not true in string theory. For this reason the proof of crossing symmetry holds not for the full S-matrix elements, but for a related quantity where we remove the contribution due to massless states from the internal propagators of the Feynman diagram. What this analysis establishes, however, is that the lack of crossing symmetry of string amplitudes has the same origin as the lack of crossing symmetry for quantum field theory amplitudes, namely, the presence of massless states. The fact that string (field)

theory is apparently non-local does not pose any difficulty in the analysis of crossing symmetry, even though in the original QFT proof of crossing symmetry, locality played a crucial role in establishing the analyticity of the off-shell Green's function in the primitive domain of analyticity. Therefore as far as crossing symmetry is concerned, string (field) theory behaves as a local quantum field theory.

9.7 UV finiteness

String theory has been known to be UV finite since the early days of the theory, but string field theory offers a better perspective on the subject. For this let us review the usual heuristic argument for UV finiteness. By taking the limit where strings are point-like objects, we can collapse the world-sheet into world lines, and the integration over the moduli spaces of Riemann surfaces becomes integration over the lengths of the world-lines. This can be mapped to the conventional Feynman diagrams in quantum field theory by identifying the lengths of the world-lines as Schwinger parameters that are often used to rewrite the quantum field theory amplitudes. In this language the UV divergences appear from regions where a loop in the world-line diagram collapses to a point, i.e. all the length parameters along different propagators in the loop vanishes.

Given this, one can ask what this region would correspond to if we had fattened the world-lines into world-sheets. The answer is that such regions correspond to degenerate Riemann surfaces. On the other hand the IR divergences that come from the region where some of the world-line length parameters become large also correspond to degenerate Riemann surfaces. Since in string theory we are instructed to integrate over inequivalent Riemann surfaces, we should include the contribution from each degenerate Riemann surface only once. Using this one can interpret all the UV divergent regions in the moduli spaces of Riemann surfaces as IR divergent regions. This shows that all divergences in string theory can be interpreted as IR divergences. Hence string theory has no UV divergence. Such an interpretation is made manifest, for example, in the minimal area string diagrams discussed in section 7.8. In this construction all Riemann surfaces are built with propagators or cylinders of fixed finite circumference and string vertices that are nonsingular, as they contain no homotopically nontrivial closed curves of small length. All degenerations appear from infinitely long cylinders and thus correspond to the infrared configurations. In the representation where we express the string amplitudes as integrals over loop momenta, with infinite tower of states propagating along each propagator, the ultra-violet finiteness can be seen by noting that each interaction vertex carries an exponential suppression factor when $(k^2 + m^2)$ of any external states becomes large. Therefore neither the loop momentum integrals, nor the sum over the infinite tower of propagating states, encounter an ultra-violet divergence.

Now one could argue that this is a matter of interpretation; what if we had reinterpreted all the divergences as UV divergences instead of IR divergences? The answer to this is that in quantum field theory IR singularities of certain kind are necessary. For example loop amplitudes are required to have certain poles and branch cuts associated with particle production in intermediate channels, and these arise precisely from the IR regions in a quantum field theory. Therefore in order that string theory describes a good quantum theory, it must share the IR divergences that are present in quantum field theory. What we need to check is whether we have any additional divergences left after reproducing all the IR divergences that are present in quantum field theory. This is where string field theory proves useful by providing a fully consistent framework for analysis. The arguments presented in sections 9.3, 9.6 show that the divergences present in the theory are precisely those needed for a proper interpretation as a quantum theory. For example, if (9.81) failed to hold, we could assign

the failure to a UV divergence by making a modular transformation that converts the IR region to the UV region in the world-sheet interpretation. However, (9.81) holds and there is no left-over divergence that needs to be attributed to UV divergence in the theory.

To summarize, the fact that string field theory allows us to express the amplitudes as a sum over Feynman diagrams whose infrared properties are the same as those of a quantum field theory, and that the momentum integrals (and sum over infinite number of internal states) are finite due to the exponential suppression of the interaction vertices discussed in section 9.6, shows the absence of UV divergences in the theory.

10 Some future directions

At the time of this writing (2024) covariant string field theory has been developed and studied for about forty years. As we have seen, there are formulations of all the string field theories, but the search continues for more efficient formulations. There are also some obvious outstanding questions that could perhaps be tackled in the context of the present formulations of string field theory. Finally, there are a number of physical questions whose answers would be of current interest and dealing with them would surely better our understanding of string field theory. We briefly consider some of these directions.

1. It can be argued that just as bosonic string field theories are nicely formulated in terms of moduli spaces of Riemann surfaces, superstring field theories would have a more foundational definition if built using moduli spaces of super-Riemann surfaces. In such formulation, perhaps the present constructions using PCO's would be seen to arise naturally by making choices in the description of such supermoduli spaces. Early relevant work on supermoduli spaces was done by Belopolsky [236, 237]. More recently, this subject has been discussed at length by Witten [201], and the equivalence between the supermoduli and the PCO formalisms at the level of the world-sheet theory was established by Wang and Yin [238, 239]. For some steps in the construction of the NS sector of the open superstring field theory using supermoduli space see [149], with the extension to the R sector considered in [240].
2. A possibility is that a supermoduli space formulation would yield canonical insertions of PCO's. This would be highly desirable, as it could help the construction of string field theory solutions, which nowadays only exist for the canonically associative open bosonic string field theory and open superstring field theory in the large Hilbert space. One option was discussed in section 7.10, where the insertions occur on the boundary of the coordinate disks associated with the punctures. A canonical distribution of PCO's on the bulk of Riemann surfaces is not yet available for the version of heterotic and type II string theories of [19, 20].
3. The string field theories reviewed in this article are all formulated given a string background; essentially a CFT (or BCFT) that is coupled to ghost sectors. The CFT defines the consistent background, that happens to be a solution represented by the zero string field. Ideally, one would like to formulate the theory around arbitrary backgrounds, not just consistent backgrounds, just like Einstein's equation are written for arbitrary metrics on a manifold. Background independent formulations were considered in [165, 166] using the BV approach. An approach based on L_∞ algebras with a product without input (often called a 'curved' algebra) was explored in [100, 241]. For open strings, the possibility of using a special background to

formulate the theory seemed promising and gave rise to ‘vacuum string field theory,’ in which the tachyon vacuum, a background with no open string degrees of freedom, was used as a starting point [242–245].

4. The simple structure of the cubic bosonic open string field theory has allowed the construction of a good number of classical solutions, including time dependent ones. The relative simplicity of the associative star product allowed for this development. To date there is no known exact classical solution of bosonic closed string field theory. Nor has the tachyon vacuum for this theory been convincingly identified [63, 126]. It seems quite plausible that the simplest vertices as far as finding solutions are the ‘polyhedral’ vertices arising from Strebel quadratic differentials (or minimal area metrics). After all, these vertices are the natural generalization of the open string associative vertex to closed strings. Finding exact solutions of classical closed string field theory would be a welcome breakthrough.

Some recent work pointing in this direction include trying to make open string field theory analogous to closed string field theory by adding stubs to the open string vertices [246, 247], and formulating the non-polynomial stubbed open string field theory as a cubic theory with the use of auxiliary fields [248, 249]. There is also insight to be gained by studying QFT with stubs [250], and for the problem of closed string tachyon condensation, by investigating how stubs affect effective potentials in field theory [251]. On a different vein, there are investigations of closed string field theory aiming to relax the level matching constraint $L_0^- = 0$ [252, 253].

5. Among the classical solutions of closed bosonic string field theory, or heterotic or closed superstring field theory, black hole solutions would be among the most interesting ones. One of the outstanding issues involving black hole solutions in string theory is: given a black hole solution, described by a two dimensional world-sheet conformal field theory, how can we calculate its entropy? In other words, what is the analog of Wald’s formula [254], describing the entropy of a black hole in any higher derivative theory of gravity, in string theory? Classical string field theory may be able to answer this question, particularly since in the Gibbons-Hawking formalism [255] the computation of the entropy can be reformulated as the computation of the on-shell action as a function of the period of the Euclidean time circle. In this context the recent result by Erler [256] showing that the vanishing of the bulk terms in the on-shell action is a consequence of the dilaton theorem could provide a clue. A somewhat different approach to this problem has been suggested in [257, 258].
6. The dilaton theorem, reviewed in section 5.7 for the case of closed bosonic string field theory, has not yet been extended to open-closed theories, and heterotic and type II closed strings. There is also the issue of constant, or Gibbons-Hawking-York type terms that could be present in the closed string field theory action when dealing with noncompact spaces or on spaces with boundaries [259, 260]. The constant terms in the action (cosmological terms) in open-closed string field theory have been discussed in [106], relating them to world-sheet partition functions on the disk.
7. It remains to be seen if string field theory can provide insights into holography, perhaps a ‘proof’ of the AdS/CFT correspondence, the central example of an open-closed duality, a duality between large N gauge theories and closed strings. Some directions based on open string field theory, A_∞ and L_∞ algebras, are explored in [72, 261, 262]. There is also work using open-closed

string field theory in the background of N extended D-branes, with N large [105, 112]. The hyperbolic open-closed vertices [135] are relevant here. Some earlier research considered simpler versions of the open-closed duality, such as the duality between Chern-Simons and the closed topological A-model [263]. In the framework of string field theory, [264] studied the duality between topological matrix models and open string field theory on N extended Liouville branes. In the special cases where the background contains pure NSNS flux [265–270], we have an exact CFT description of the world-sheet theory, and it is possible to formulate string field theory in this background following the procedure described in this article. We can then try to identify what computations in this string field theory will give the boundary S-matrix in AdS and try to relate it to the correlations functions of local operators in the boundary theory.

8. It may be possible to use string field theory to address some of the perturbative results relevant for string phenomenology, *e.g.* computation of the Kahler potential in $\mathcal{N} = 1$ supersymmetric string compactification. We have already mentioned the use of string field theory for the computation of D-instanton correction to the superpotential. Another potential application of string field theory will be in developing a systematic procedure for computing amplitudes in the presence of RR flux. See [209] for some recent progress in this direction.

Acknowledgement: We would like to thank Nathan Berkovits, Minjae Cho, Harold Erbin, Ted Erler, Atakan Hilmi Firat, Olaf Hohm, Carlo Maccaferri, Raji Mamade, Nicolas Moeller, Farough Moosavian, Yuji Okawa, Roji Pius, Leonardo Rastelli, Ivo Sachs, Ranveer Singh, Jakub Vosmera, Edward Witten, and Xi Yin for useful discussions during the preparation of the manuscript.

The work of A.S. was supported by ICTS-Infosys Madhava Chair Professorship, the J. C. Bose fellowship of the Department of Science and Technology, India and the Department of Atomic Energy, Government of India, under project no. RTI4001. This research was also supported in part by grant NSF PHY-2309135 to the Kavli Institute for Theoretical Physics (KITP).

The work of B.Z was supported by the U.S. Department of Energy, Office of Science, Office of High Energy Physics of U.S. Department of Energy under grant Contract Number DE-SC0012567.(High Energy Theory research).

References

- [1] W. Siegel, “Covariantly Second Quantized String. 2.,” *Phys. Lett. B* **149**, 157 (1984) doi:10.1016/0370-2693(85)91661-2
- [2] M. Kato and K. Ogawa “Covariant quantization of string based on BRS invariance.,” *Nucl. Phys. B* **212**, 443 (1983).
- [3] M. Kaku and K. Kikkawa, “The Field Theory of Relativistic Strings. I. Trees,” *Phys. Rev. D* **10** (1974), 1110 doi:10.1103/PhysRevD.10.1110
- [4] S. Mandelstam, “The interacting string picture and functional integration.” in *Unified String Theories* (M. Green and D. Gross, eds.), World Scientific, Singapore, 1986.
- [5] E. Witten, “Noncommutative Geometry and String Field Theory,” *Nucl. Phys. B* **268**, 253-294 (1986) doi:10.1016/0550-3213(86)90155-0
- [6] B. Zwiebach, “Closed string field theory: Quantum action and the B-V master equation,” *Nucl. Phys. B* **390**, 33-152 (1993) doi:10.1016/0550-3213(93)90388-6 [arXiv:hep-th/9206084 [hep-th]].
- [7] B. Zwiebach, “Quantum open string theory with manifest closed string factorization,” *Phys. Lett. B* **256**, 22-29 (1991) doi:10.1016/0370-2693(91)90212-9

- [8] B. Zwiebach, “Interpolating string field theories,” *Mod. Phys. Lett. A* **7**, 1079-1090 (1992) doi:10.1142/S0217732392000951 [arXiv:hep-th/9202015 [hep-th]].
- [9] B. Zwiebach, “Oriented open-closed string theory revisited,” *Annals Phys.* **267**, 193-248 (1998) doi:10.1006/aphy.1998.5803 [arXiv:hep-th/9705241 [hep-th]].
- [10] H. Erbin, “String Field Theory: A Modern Introduction,” *Lect. Notes Phys.* **980**, 1-421 (2021) 2021, ISBN 978-3-030-65320-0, 978-3-030-65321-7 doi:10.1007/978-3-030-65321-7 [arXiv:2301.01686 [hep-th]].
- [11] C. Maccaferri, “String Field Theory,” [arXiv:2308.00875 [hep-th]].
- [12] T. Erler, “Four lectures on analytic solutions in open string field theory,” *Phys. Rept.* **980**, 1-95 (2022) doi:10.1016/j.physrep.2022.06.004 [arXiv:1912.00521 [hep-th]].
- [13] T. Erler, “Four Lectures on Closed String Field Theory,” *Phys. Rept.* **851**, 1-36 (2020) doi:10.1016/j.physrep.2020.01.003 [arXiv:1905.06785 [hep-th]].
- [14] M. Kudrna, “Level Truncation Approach to Open String Field Theory,” [arXiv:2101.07678 [hep-th]].
- [15] C. de Lacroix, H. Erbin, S. P. Kashyap, A. Sen and M. Verma, “Closed Superstring Field Theory and its Applications,” *Int. J. Mod. Phys. A* **32**, no.28n29, 1730021 (2017) doi:10.1142/S0217751X17300216 [arXiv:1703.06410 [hep-th]].
- [16] Y. Okawa, “Analytic methods in open string field theory,” *Prog. Theor. Phys.* **128**, 1001-1060 (2012) doi:10.1143/PTP.128.1001
- [17] E. Fuchs and M. Kroyter, “Analytical Solutions of Open String Field Theory,” *Phys. Rept.* **502** (2011), 89-149 doi:10.1016/j.physrep.2011.01.003 [arXiv:0807.4722 [hep-th]].
- [18] W. Taylor and B. Zwiebach, “D-branes, tachyons, and string field theory,” doi:10.1142/9789812702821_0012 [arXiv:hep-th/0311017 [hep-th]].
- [19] A. Sen, “BV Master Action for Heterotic and Type II String Field Theories,” *JHEP* **02**, 087 (2016) doi:10.1007/JHEP02(2016)087 [arXiv:1508.05387 [hep-th]].
- [20] A. Sen, “Reality of Superstring Field Theory Action,” *JHEP* **11** (2016), 014 doi:10.1007/JHEP11(2016)014 [arXiv:1606.03455 [hep-th]].
- [21] S. Farough Moosavian, A. Sen and M. Verma, “Superstring Field Theory with Open and Closed Strings,” *JHEP* **01** (2020), 183 doi:10.1007/JHEP01(2020)183 [arXiv:1907.10632 [hep-th]].
- [22] A. Sen and B. Zwiebach, “On the normalization of open-closed string amplitudes,” [arXiv:2405.03784 [hep-th]].
- [23] N. Berkovits, “SuperPoincare invariant superstring field theory,” *Nucl. Phys. B* **450**, 90-102 (1995) [erratum: *Nucl. Phys. B* **459**, 439-451 (1996)] doi:10.1016/0550-3213(95)00259-U [arXiv:hep-th/9503099 [hep-th]].
- [24] N. Berkovits, “A New approach to superstring field theory,” *Fortsch. Phys.* **48**, 31-36 (2000) [arXiv:hep-th/9912121 [hep-th]].
- [25] Y. Okawa and B. Zwiebach, “Heterotic string field theory,” *JHEP* **07**, 042 (2004) doi:10.1088/1126-6708/2004/07/042 [arXiv:hep-th/0406212 [hep-th]].
- [26] N. Berkovits, Y. Okawa and B. Zwiebach, “WZW-like action for heterotic string field theory,” *JHEP* **11**, 038 (2004) doi:10.1088/1126-6708/2004/11/038 [arXiv:hep-th/0409018 [hep-th]].
- [27] H. Matsunaga, “Nonlinear gauge invariance and WZW-like action for NS-NS superstring field theory,” *JHEP* **09**, 011 (2015) doi:10.1007/JHEP09(2015)011 [arXiv:1407.8485 [hep-th]].
- [28] T. Erler, S. Konopka and I. Sachs, “NS-NS Sector of Closed Superstring Field Theory,” *JHEP* **08**, 158 (2014) doi:10.1007/JHEP08(2014)158 [arXiv:1403.0940 [hep-th]].
- [29] H. Kunitomo and Y. Okawa, “Complete action for open superstring field theory,” *PTEP* **2016** (2016) no.2, 023B01 doi:10.1093/ptep/ptv189 [arXiv:1508.00366 [hep-th]].
- [30] H. Kunitomo, Y. Okawa, H. Sukeno and T. Takezaki, “Fermion scattering amplitudes from gauge-invariant actions for open superstring field theory,” [arXiv:1612.00777 [hep-th]].

- [31] D. Friedan, S. H. Shenker and E. J. Martinec, “Covariant Quantization of Superstrings,” *Phys. Lett. B* **160** (1985), 55-61 doi:10.1016/0370-2693(85)91466-2
- [32] G. Segal, “The definition of conformal field theory.” *Topology, Geometry and Quantum Field Theory: Proceedings of the 2002 Oxford Symposium in Honour of the 60th Birthday of Graeme Segal*. London Mathematical Society Lecture Note Series. Cambridge University Press; 2004:421-422.
- [33] L. Alvarez-Gaume, C. Gomez, G. W. Moore and C. Vafa, “Strings in the Operator Formalism,” *Nucl. Phys. B* **303**, 455-521 (1988) doi:10.1016/0550-3213(88)90391-4
- [34] K. Costello and B. Zwiebach, “Hyperbolic string vertices,” *JHEP* **02**, 002 (2022) doi:10.1007/JHEP02(2022)002 [arXiv:1909.00033 [hep-th]].
- [35] A. LeClair, M. E. Peskin and C. R. Preitschopf, “String Field Theory on the Conformal Plane. 1. Kinematical Principles,” *Nucl. Phys. B* **317**, 411-463 (1989) doi:10.1016/0550-3213(89)90075-8
- [36] A. LeClair, M. E. Peskin and C. R. Preitschopf, *Nucl. Phys. B* **317**, 464-508 (1989) doi:10.1016/0550-3213(89)90076-X
- [37] A. Belopolsky and B. Zwiebach, “Off-shell closed string amplitudes: Towards a computation of the tachyon potential,” *Nucl. Phys. B* **442**, 494-532 (1995) doi:10.1016/0550-3213(95)00094-9 [arXiv:hep-th/9409015 [hep-th]].
- [38] M. Schiffer and D. C. Spencer, *Functionals on finite Riemann surfaces* (Princeton University Press, Princeton, 1954); F. P. Gardiner, *Duke. Math. J.* **42** (1975) 371; S. Nag, *Proc. Indian Acad. Sci. (Math. Sci.)* **94** (1985) 111.
- [39] E. Witten, “The Feynman $i\epsilon$ in String Theory,” *JHEP* **04** (2015), 055 doi:10.1007/JHEP04(2015)055 [arXiv:1307.5124 [hep-th]].
- [40] L. Eberhardt and S. Mizera, “Evaluating one-loop string amplitudes,” *SciPost Phys.* **15** (2023) no.3, 119 doi:10.21468/SciPostPhys.15.3.119 [arXiv:2302.12733 [hep-th]].
- [41] E. P. Verlinde and H. L. Verlinde, “Multiloop Calculations in Covariant Superstring Theory,” *Phys. Lett. B* **192** (1987), 95-102 doi:10.1016/0370-2693(87)91148-8
- [42] A. Sen, “Off-shell Amplitudes in Superstring Theory,” *Fortsch. Phys.* **63** (2015), 149-188 doi:10.1002/prop.201500002 [arXiv:1408.0571 [hep-th]].
- [43] A. Sen and E. Witten, “Filling the gaps with PCO’s,” *JHEP* **09** (2015), 004 doi:10.1007/JHEP09(2015)004 [arXiv:1504.00609 [hep-th]].
- [44] I. A. Batalin and G. A. Vilkovisky, “Gauge Algebra and Quantization,” *Phys. Lett.* **102B**, 27 (1981). doi:10.1016/0370-2693(81)90205-7
- [45] I. A. Batalin and G. A. Vilkovisky, “Quantization of Gauge Theories with Linearly Dependent Generators,” *Phys. Rev. D* **28**, 2567 (1983) Erratum: [*Phys. Rev. D* **30**, 508 (1984)]. doi:10.1103/PhysRevD.28.2567, 10.1103/PhysRevD.30.508
- [46] M. Henneaux and C. Teitelboim, “Quantization of Gauge Systems”, Princeton University Press, Princeton, New Jersey, 1992.
- [47] A. S. Schwarz, “Geometry of Batalin-Vilkovisky quantization,” *Commun. Math. Phys.* **155** (1993), 249-260 doi:10.1007/BF02097392 [arXiv:hep-th/9205088 [hep-th]].
- [48] W. Siegel and B. Zwiebach, “Gauge String Fields,” *Nucl. Phys. B* **263**, 105-128 (1986) doi:10.1016/0550-3213(86)90030-1
- [49] T. Banks and M. E. Peskin, “Gauge Invariance of String Fields,” *Nucl. Phys. B* **264**, 513-547 (1986) doi:10.1016/0550-3213(86)90496-7
- [50] A. Neveu, H. Nicolai and P. C. West, “New Symmetries and Ghost Structure of Covariant String Theories,” *Phys. Lett. B* **167**, 307-314 (1986) doi:10.1016/0370-2693(86)90351-5
- [51] A. Neveu and P. C. West, “The Interacting Gauge Covariant Bosonic String,” *Phys. Lett. B* **168**, 192-200 (1986) doi:10.1016/0370-2693(86)90962-7

- [52] H. Hata, K. Itoh, T. Kugo, H. Kunitomo and K. Ogawa, “Manifestly Covariant Field Theory of Interacting String,” *Phys. Lett. B* **172**, 186-194 (1986) doi:10.1016/0370-2693(86)90834-8
- [53] H. Hata, K. Itoh, T. Kugo, H. Kunitomo and K. Ogawa, “Manifestly Covariant Field Theory of Interacting String. 2.,” *Phys. Lett. B* **172**, 195-203 (1986) doi:10.1016/0370-2693(86)90835-X
- [54] H. Hata, K. Itoh, T. Kugo, H. Kunitomo and K. Ogawa, “Pregeometrical String Field Theory: Creation of Space-time and Motion,” *Phys. Lett. B* **175**, 138-144 (1986) doi:10.1016/0370-2693(86)90703-3
- [55] T. Kugo and B. Zwiebach, “Target space duality as a symmetry of string field theory,” *Prog. Theor. Phys.* **87**, 801-860 (1992) doi:10.1143/ptp/87.4.801 [arXiv:hep-th/9201040 [hep-th]].
- [56] M. R. Gaberdiel and B. Zwiebach, “Tensor constructions of open string theories. 1: Foundations,” *Nucl. Phys. B* **505**, 569-624 (1997) doi:10.1016/S0550-3213(97)00580-4 [arXiv:hep-th/9705038 [hep-th]].
- [57] A. Sen, “Universality of the tachyon potential,” *JHEP* **12**, 027 (1999) doi:10.1088/1126-6708/1999/12/027 [arXiv:hep-th/9911116 [hep-th]].
- [58] M. Cho, B. Mazel and X. Yin, “Rolling tachyon and the Phase Space of Open String Field Theory,” [arXiv:2310.17895 [hep-th]].
- [59] T. Erler, S. Konopka and I. Sachs, “Resolving Witten’s superstring field theory,” *JHEP* **04** (2014), 150 doi:10.1007/JHEP04(2014)150 [arXiv:1312.2948 [hep-th]].
- [60] T. Erler, S. Konopka and I. Sachs, “Ramond Equations of Motion in Superstring Field Theory,” *JHEP* **11** (2015), 199 doi:10.1007/JHEP11(2015)199 [arXiv:1506.05774 [hep-th]].
- [61] C. B. Thorn, “STRING FIELD THEORY,” *Phys. Rept.* **175** (1989), 1-101 doi:10.1016/0370-1573(89)90015-X
- [62] I. Ellwood, J. Shelton and W. Taylor, “Tadpoles and closed string backgrounds in open string field theory,” *JHEP* **07**, 059 (2003) doi:10.1088/1126-6708/2003/07/059 [arXiv:hep-th/0304259 [hep-th]].
- [63] H. Yang and B. Zwiebach, “A Closed string tachyon vacuum?,” *JHEP* **09**, 054 (2005) doi:10.1088/1126-6708/2005/09/054 [arXiv:hep-th/0506077 [hep-th]].
- [64] C. Hull and B. Zwiebach, “Double Field Theory,” *JHEP* **09**, 099 (2009) doi:10.1088/1126-6708/2009/09/099 [arXiv:0904.4664 [hep-th]].
- [65] H. Sonoda, “Sewing conformal field theories,” *Nucl. Phys. B* **311** (1988), 401-416 doi:10.1016/0550-3213(88)90066-
- [66] H. Sonoda, “Sewing conformal field theories. 2.,” *Nucl. Phys. B* **311** (1988), 417-432 doi:10.1016/0550-3213(88)90067-3
- [67] S. B. Giddings, E. J. Martinec and E. Witten, “Modular Invariance in String Field Theory,” *Phys. Lett. B* **176**, 362-368 (1986) doi:10.1016/0370-2693(86)90179-6
- [68] B. Zwiebach, “A Proof that Witten’s open string theory gives a single cover of moduli space,” *Commun. Math. Phys.* **142**, 193-216 (1991) doi:10.1007/BF02099176
- [69] A. Sen, “Wilsonian Effective Action of Superstring Theory,” *JHEP* **01**, 108 (2017) doi:10.1007/JHEP01(2017)108 [arXiv:1609.00459 [hep-th]].
- [70] H. Kajiura, “Noncommutative homotopy algebras associated with open strings,” *Rev. Math. Phys.* **19**, 1-99 (2007) doi:10.1142/S0129055X07002912 [arXiv:math/0306332 [math.QA]].
- [71] H. Erbin, C. Maccaferri, M. Schnabl and J. Vošmera, “Classical algebraic structures in string theory effective actions,” *JHEP* **11**, 123 (2020) doi:10.1007/JHEP11(2020)123 [arXiv:2006.16270 [hep-th]].
- [72] D. Koyama, Y. Okawa and N. Suzuki, “Gauge-invariant operators of open bosonic string field theory in the low-energy limit,” [arXiv:2006.16710 [hep-th]].
- [73] A. S. Arvanitakis, O. Hohm, C. Hull and V. Lekeu, “Homotopy Transfer and Effective Field Theory I: Tree-level,” [arXiv:2007.07942 [hep-th]].
- [74] R. K. Singh, “Algebraic Structures In Closed Superstring Field Theory, Homotopy Transfer And Effective Actions,” [arXiv:2405.08063 [hep-th]].

- [75] C. Maccaferri and J. Vošmera, “Closed string deformations in open string field theory. Part I. Bosonic string,” *JHEP* **09**, 047 (2021) doi:10.1007/JHEP09(2021)047
- [76] T. Erler and H. Matsunaga, “Mapping between Witten and lightcone string field theories,” *JHEP* **11**, 208 (2021) doi:10.1007/JHEP11(2021)208 [arXiv:2012.09521 [hep-th]]
- [77] A. Sen, “Gauge Invariant 1PI Effective Action for Superstring Field Theory,” *JHEP* **06** (2015), 022 doi:10.1007/JHEP06(2015)022 [arXiv:1411.7478 [hep-th]].
- [78] H. Hata and B. Zwiebach, “Developing the covariant Batalin-Vilkovisky approach to string theory,” *Annals Phys.* **229** (1994), 177-216 doi:10.1006/aphy.1994.1006 [arXiv:hep-th/9301097 [hep-th]].
- [79] K. J. Costello, “The Gromov-Witten potential associated to a TCFT,” [arXiv:math/0509264 [math.QA]].
- [80] A. Sen and B. Zwiebach, “A Proof of local background independence of classical closed string field theory,” *Nucl. Phys. B* **414**, 649-714 (1994) doi:10.1016/0550-3213(94)90258-5 [arXiv:hep-th/9307088 [hep-th]].
- [81] A. Sen, “On the Background Independence of String Field Theory,” *Nucl. Phys. B* **345** (1990), 551-583 doi:10.1016/0550-3213(90)90400-8
- [82] K. Ranganathan, “Nearby CFTs in the operator formalism: The Role of a connection,” *Nucl. Phys. B* **408** (1993), 180-206 doi:10.1016/0550-3213(93)90136-D [arXiv:hep-th/9210090 [hep-th]].
- [83] K. Ranganathan, H. Sonoda and B. Zwiebach, “Connections on the state space over conformal field theories,” *Nucl. Phys. B* **414** (1994), 405-460 doi:10.1016/0550-3213(94)90436-7 [arXiv:hep-th/9304053 [hep-th]].
- [84] A. Sen and B. Zwiebach, “Quantum background independence of closed string field theory,” *Nucl. Phys. B* **423**, 580-630 (1994) doi:10.1016/0550-3213(94)90145-7 [arXiv:hep-th/9311009 [hep-th]].
- [85] A. Sen, “Background Independence of Closed Superstring Field Theory,” *JHEP* **02** (2018), 155 doi:10.1007/JHEP02(2018)155 [arXiv:1711.08468 [hep-th]].
- [86] S. Mukherji and A. Sen, “Some all order classical solutions in nonpolynomial closed string field theory,” *Nucl. Phys. B* **363** (1991), 639-664 doi:10.1016/0550-3213(91)80037-M
- [87] B. Mazel, J. Sandor, C. Wang and X. Yin, “Conformal Perturbation Theory and Tachyon-Dilaton Eschatology via String Fields,” [arXiv:2403.14544 [hep-th]].
- [88] O. Bergman and B. Zwiebach, “The Dilaton theorem and closed string backgrounds,” *Nucl. Phys. B* **441**, 76-118 (1995) doi:10.1016/0550-3213(95)00022-K [arXiv:hep-th/9411047 [hep-th]].
- [89] S. Rahman and B. Zwiebach, “Vacuum vertices and the ghost dilaton,” *Nucl. Phys. B* **471**, 233-245 (1996) doi:10.1016/0550-3213(96)00179-4 [arXiv:hep-th/9507038 [hep-th]].
- [90] J. Distler and P. C. Nelson, “Topological couplings and contact terms in 2-d field theory,” *Commun. Math. Phys.* **138**, 273-290 (1991) doi:10.1007/BF02099493
- [91] J. Polchinski, “Factorization of Bosonic String Amplitudes,” *Nucl. Phys. B* **307**, 61-92 (1988) doi:10.1016/0550-3213(88)90522-6
- [92] O. Hohm and B. Zwiebach, “ L_∞ Algebras and Field Theory,” *Fortsch. Phys.* **65**, no.3-4, 1700014 (2017) doi:10.1002/prop.201700014 [arXiv:1701.08824 [hep-th]].
- [93] R. Blumenhagen, M. Fuchs and M. Traube, “ \mathcal{W} algebras are L_∞ algebras,” *JHEP* **07**, 060 (2017) doi:10.1007/JHEP07(2017)060 [arXiv:1705.00736 [hep-th]].
- [94] L. Borsten, H. Kim, B. Jurčo, T. Macrelli, C. Saemann and M. Wolf, “Double Copy from Homotopy Algebras,” *Fortsch. Phys.* **69**, no.8-9, 2100075 (2021) doi:10.1002/prop.202100075 [arXiv:2102.11390 [hep-th]].
- [95] R. Bonezzi, C. Chiaffrino, F. Diaz-Jaramillo and O. Hohm, “Gauge invariant double copy of Yang-Mills theory: The quartic theory,” *Phys. Rev. D* **107**, no.12, 126015 (2023) doi:10.1103/PhysRevD.107.126015 [arXiv:2212.04513 [hep-th]].

- [96] R. Bonezzi, C. Chiafrino, F. Diaz-Jaramillo and O. Hohm, “Weakly Constrained Double Field Theory as the Double Copy of Yang-Mills Theory,” [arXiv:2309.03289 [hep-th]].
- [97] K. Konosu and Y. Okawa, “Nonperturbative correlation functions from homotopy algebras,” [arXiv:2405.10935 [hep-th]].
- [98] A. H. Firat, “ A_∞ perspective to Sen’s formalism,” [arXiv:2405.05310 [hep-th]].
- [99] E. Getzler, J.D.S. Jones, “ A_∞ -algebras and the cyclic bar complex,” *Ill. Journ. Math.* **34**, 256 (1990).
- [100] B. Zwiebach, “Building string field theory around nonconformal backgrounds,” *Nucl. Phys. B* **480**, 541-572 (1996) doi:10.1016/S0550-3213(96)00502-0 [arXiv:hep-th/9606153 [hep-th]].
- [101] M. Markl, “Loop homotopy algebras in closed string field theory,” *Commun. Math. Phys.* **221**, 367-384 (2001) doi:10.1007/PL00005575 [arXiv:hep-th/9711045 [hep-th]].
- [102] H. Kajiura and J. Stasheff, “Homotopy algebras inspired by classical open-closed string field theory,” *Commun. Math. Phys.* **263**, 553-581 (2006) doi:10.1007/s00220-006-1539-2 [arXiv:math/0410291 [math.QA]].
- [103] H. Kajiura and J. Stasheff, “Homotopy algebra of open-closed strings,” *Geom. Topol. Monographs* **13**, 229-259 (2008) doi:10.2140/gtm.2008.13.229 [arXiv:hep-th/0606283 [hep-th]].
- [104] C. Maccaferri, A. Ruffino and J. Vošmera, “The nilpotent structure of open-closed string field theory,” *JHEP* **08**, 145 (2023) doi:10.1007/JHEP08(2023)145 [arXiv:2305.02843 [hep-th]].
- [105] C. Maccaferri, A. Ruffino and J. Vošmera, “Open-closed string field theory in the large N limit,” *JHEP* **09**, 119 (2023) doi:10.1007/JHEP09(2023)119 [arXiv:2305.02844 [hep-th]].
- [106] C. Maccaferri and J. Vošmera, “The classical cosmological constant of open-closed string field theory,” *JHEP* **10**, 173 (2022) doi:10.1007/JHEP10(2022)173 [arXiv:2208.00410 [hep-th]].
- [107] H. Kajiura, “Homotopy algebra morphism and geometry of classical string field theory,” *Nucl. Phys. B* **630** (2002), 361-432 doi:10.1016/S0550-3213(02)00174-8 [arXiv:hep-th/0112228 [hep-th]].
- [108] A. Sen and B. Zwiebach, “Background independent algebraic structures in closed string field theory,” *Commun. Math. Phys.* **177**, 305-326 (1996) doi:10.1007/BF02101895 [arXiv:hep-th/9408053 [hep-th]].
- [109] E. Harrelson, A. A. Voronov and J. J. Zuniga, “Open-closed moduli spaces and related algebraic structures,” *Lett. Math. Phys.* **94** (2010), 1-26 doi:10.1007/s11005-010-0418-0
- [110] S. F. Moosavian and Y. Zhou, “On the Existence of Heterotic-String and Type-II-Superstring Field Theory Vertices,” [arXiv:1911.04343 [hep-th]].
- [111] H. Hata and M. M. Nojiri, “A New Symmetry in Covariant Open String Field Theory,” *Phys. Rev. D* **36**, 1193 (1987) doi:10.1103/PhysRevD.36.1193
- [112] A. H. Firat, “String vertices for the large N limit,” [arXiv:2311.00747 [hep-th]].
- [113] T. Erler, S. Konopka and I. Sachs, “One Loop Tadpole in Heterotic String Field Theory,” *JHEP* **11** (2017), 056 doi:10.1007/JHEP11(2017)056 [arXiv:1704.01210 [hep-th]].
- [114] A. Sen, “D-instantons, string field theory and two dimensional string theory,” *JHEP* **11** (2021), 061 doi:10.1007/JHEP11(2021)061 [arXiv:2012.11624 [hep-th]].
- [115] H. Erbin and S. Majumder, “ $SL(2, \mathbb{C})$ quartic vertex for closed string field theory,” [arXiv:2311.07367 [hep-th]].
- [116] N. Moeller, “Closed bosonic string field theory at quartic order,” *JHEP* **11**, 018 (2004) doi:10.1088/1126-6708/2004/11/018 [arXiv:hep-th/0408067 [hep-th]].
- [117] K. Strebel, “Quadratic differentials,” Springer, Berlin (1984).
- [118] M. Saadi and B. Zwiebach, “Closed String Field Theory from Polyhedra,” *Annals Phys.* **192** (1989), 213 doi:10.1016/0003-4916(89)90126-7
- [119] T. Kugo, H. Kunitomo and K. Suehiro, “Nonpolynomial Closed String Field Theory,” *Phys. Lett. B* **226** (1989), 48-54 doi:10.1016/0370-2693(89)90287-6

- [120] T. Kugo and K. Suehiro, “Nonpolynomial Closed String Field Theory: Action and Its Gauge Invariance,” Nucl. Phys. B **337** (1990), 434-466 doi:10.1016/0550-3213(90)90277-K
- [121] N. Moeller, “Closed Bosonic String Field Theory at Quintic Order: Five-Tachyon Contact Term and Dilaton Theorem,” JHEP **03**, 043 (2007) doi:10.1088/1126-6708/2007/03/043 [arXiv:hep-th/0609209 [hep-th]].
- [122] H. Erbin and A. H. Firat, “Characterizing 4-string contact interaction using machine learning,” [arXiv:2211.09129 [hep-th]].
- [123] A. H. Firat, “Bootstrapping closed string field theory,” JHEP **05**, 186 (2023) doi:10.1007/JHEP05(2023)186 [arXiv:2302.12843 [hep-th]].
- [124] B. Zwiebach, “How covariant closed string theory solves a minimal area problem,” Commun. Math. Phys. **136**, 83-118 (1991) doi:10.1007/BF02096792
- [125] R. Brustein and S. P. De Alwis, “Renormalization group equation and nonperturbative effects in string field theory,” Nucl. Phys. B **352**, 451-468 (1991) doi:10.1016/0550-3213(91)90451-3
- [126] N. Moeller and H. Yang, “The Nonperturbative closed string tachyon vacuum to high level,” JHEP **04**, 009 (2007) doi:10.1088/1126-6708/2007/04/009 [arXiv:hep-th/0609208 [hep-th]].
- [127] G. Zemba and B. Zwiebach, “Tadpole Graph in Covariant Closed String Field Theory,” J. Math. Phys. **30**, 2388 (1989) doi:10.1063/1.528569
- [128] M. Headrick and B. Zwiebach, “Convex programs for minimal-area problems,” Commun. Math. Phys. **377**, no.3, 2217-2285 (2020) doi:10.1007/s00220-020-03732-1 [arXiv:1806.00449 [hep-th]].
- [129] M. Headrick and B. Zwiebach, “Minimal-area metrics on the Swiss cross and punctured torus,” Commun. Math. Phys. **377**, no.3, 2287-2343 (2020) doi:10.1007/s00220-020-03734-z [arXiv:1806.00450 [hep-th]].
- [130] U. Naseer and B. Zwiebach, “Extremal isosystolic metrics with multiple bands of crossing geodesics,” Adv. Theor. Math. Phys. **26**, no.5, 1273-1346 (2022) doi:10.4310/ATMP.2022.v26.n5.a7 [arXiv:1903.11755 [math.DG]].
- [131] M. Gromov, “Filling Riemannian manifolds”. *J. Diff. Geom* **18**: 1-147 (1983).
- [132] P. Buser, “Geometry and spectra of compact Riemann surfaces,” Birkhäuser Boston 1992.
- [133] S. F. Moosavian and R. Pius, “Hyperbolic geometry and closed bosonic string field theory. Part I. The string vertices via hyperbolic Riemann surfaces,” JHEP **08**, 157 (2019) doi:10.1007/JHEP08(2019)157 [arXiv:1706.07366 [hep-th]].
- [134] S. F. Moosavian and R. Pius, “Hyperbolic geometry and closed bosonic string field theory. Part II. The rules for evaluating the quantum BV master action,” JHEP **08**, 177 (2019) doi:10.1007/JHEP08(2019)177 [arXiv:1708.04977 [hep-th]].
- [135] M. Cho, “Open-closed Hyperbolic String Vertices,” JHEP **05**, 046 (2020) doi:10.1007/JHEP05(2020)046 [arXiv:1912.00030 [hep-th]].
- [136] A. H. Firat, “Hyperbolic three-string vertex,” JHEP **08**, 035 (2021) doi:10.1007/JHEP08(2021)035 [arXiv:2102.03936 [hep-th]].
- [137] E. Witten, “Interacting Field Theory of Open Superstrings,” Nucl. Phys. B **276**, 291-324 (1986) doi:10.1016/0550-3213(86)90298-1
- [138] T. Erler and S. Konopka, “Vertical Integration from the Large Hilbert Space,” JHEP **12** (2017), 112 doi:10.1007/JHEP12(2017)112 [arXiv:1710.07232 [hep-th]].
- [139] T. Erler, Y. Okawa and T. Takezaki, “Complete Action for Open Superstring Field Theory with Cyclic A_∞ Structure,” JHEP **08**, 012 (2016) doi:10.1007/JHEP08(2016)012 [arXiv:1602.02582 [hep-th]].
- [140] S. Konopka and I. Sachs, “Open Superstring Field Theory on the Restricted Hilbert Space,” JHEP **04** (2016), 164 doi:10.1007/JHEP04(2016)164 [arXiv:1602.02583 [hep-th]].
- [141] H. Kunitomo and T. Sugimoto, “Heterotic string field theory with cyclic L_∞ structure,” PTEP **2019** (2019) no.6, 063B02 [erratum: PTEP **2020** (2020) no.1, 019201] doi:10.1093/ptep/ptz051 [arXiv:1902.02991 [hep-th]].

- [142] H. Kunitomo and T. Sugimoto, “Type II superstring field theory with cyclic L_∞ structure,” PTEP **2020** (2020) no.3, 033B06 doi:10.1093/ptep/ptaa013 [arXiv:1911.04103 [hep-th]].
- [143] H. Kunitomo, “Type II superstring field theory revisited,” PTEP **2021** (2021) no.9, 093B03 doi:10.1093/ptep/ptab103 [arXiv:2106.07917 [hep-th]].
- [144] Y. Iimori, T. Noumi, Y. Okawa and S. Torii, “From the Berkovits formulation to the Witten formulation in open superstring field theory,” JHEP **03** (2014), 044 doi:10.1007/JHEP03(2014)044 [arXiv:1312.1677 [hep-th]].
- [145] T. Erler, Y. Okawa and T. Takezaki, “ A_∞ structure from the Berkovits formulation of open superstring field theory,” [arXiv:1505.01659 [hep-th]].
- [146] T. Erler, “Relating Berkovits and A_∞ superstring field theories; small Hilbert space perspective,” JHEP **10**, 157 (2015) doi:10.1007/JHEP10(2015)157 [arXiv:1505.02069 [hep-th]].
- [147] T. Erler, “Relating Berkovits and A_∞ superstring field theories; large Hilbert space perspective,” JHEP **02**, 121 (2016) doi:10.1007/JHEP02(2016)121 [arXiv:1510.00364 [hep-th]].
- [148] M. Kroyter, Y. Okawa, M. Schnabl, S. Torii and B. Zwiebach, “Open superstring field theory I: gauge fixing, ghost structure, and propagator,” JHEP **03**, 030 (2012) doi:10.1007/JHEP03(2012)030 [arXiv:1201.1761 [hep-th]].
- [149] K. Ohmori and Y. Okawa, “Open superstring field theory based on the supermoduli space,” JHEP **04**, 035 (2018) doi:10.1007/JHEP04(2018)035 [arXiv:1703.08214 [hep-th]].
- [150] M. Kiermaier and Y. Okawa, “Exact marginality in open string field theory: A General framework,” JHEP **11** (2009), 041 doi:10.1088/1126-6708/2009/11/041 [arXiv:0707.4472 [hep-th]].
- [151] M. Kiermaier, Y. Okawa and P. Soler, “Solutions from boundary condition changing operators in open string field theory,” JHEP **03**, 122 (2011) doi:10.1007/JHEP03(2011)122 [arXiv:1009.6185 [hep-th]].
- [152] L. Bonora, C. Maccaferri and D. D. Tolla, “Relevant Deformations in Open String Field Theory: a Simple Solution for Lumps,” JHEP **11** (2011), 107 doi:10.1007/JHEP11(2011)107 [arXiv:1009.4158 [hep-th]].
- [153] T. Erler and C. Maccaferri, “String Field Theory Solution for Any Open String Background,” JHEP **10** (2014), 029 doi:10.1007/JHEP10(2014)029 [arXiv:1406.3021 [hep-th]].
- [154] M. Schnabl, Phys. Lett. B **654**, 194-199 (2007) doi:10.1016/j.physletb.2007.08.023 [arXiv:hep-th/0701248 [hep-th]].
- [155] M. Kiermaier, Y. Okawa, L. Rastelli and B. Zwiebach, “Analytic solutions for marginal deformations in open string field theory,” JHEP **01**, 028 (2008) doi:10.1088/1126-6708/2008/01/028 [arXiv:hep-th/0701249 [hep-th]].
- [156] M. Murata and M. Schnabl, “Multibrane Solutions in Open String Field Theory,” JHEP **07**, 063 (2012) doi:10.1007/JHEP07(2012)063 [arXiv:1112.0591 [hep-th]].
- [157] A. Sen, “String Field Theory as World-sheet UV Regulator,” JHEP **10** (2019), 119 doi:10.1007/JHEP10(2019)119 [arXiv:1902.00263 [hep-th]].
- [158] J. Scheinpflug and M. Schnabl, “Conformal perturbation theory from open string field theory,” [arXiv:2301.05216 [hep-th]].
- [159] J. Scheinpflug and M. Schnabl, “Closed string tachyon condensation revisited,” [arXiv:2308.16142 [hep-th]].
- [160] A. Sen, “NonBPS states and Branes in string theory,” [arXiv:hep-th/9904207 [hep-th]].
- [161] A. Sen, “Descent relations among bosonic D-branes,” Int. J. Mod. Phys. A **14**, 4061-4078 (1999) doi:10.1142/S0217751X99001901 [arXiv:hep-th/9902105 [hep-th]].
- [162] A. A. Gerasimov and S. L. Shatashvili, “On exact tachyon potential in open string field theory,” JHEP **10** (2000), 034 doi:10.1088/1126-6708/2000/10/034 [arXiv:hep-th/0009103 [hep-th]].
- [163] D. Kutasov, M. Marino and G. W. Moore, “Some exact results on tachyon condensation in string field theory,” JHEP **10** (2000), 045 doi:10.1088/1126-6708/2000/10/045 [arXiv:hep-th/0009148 [hep-th]].

- [164] D. Ghoshal and A. Sen, “Normalization of the background independent open string field theory action,” *JHEP* **11** (2000), 021 doi:10.1088/1126-6708/2000/11/021 [arXiv:hep-th/0009191 [hep-th]].
- [165] E. Witten, “Some computations in background independent off-shell string theory,” *Phys. Rev. D* **47** (1993), 3405-3410 doi:10.1103/PhysRevD.47.3405 [arXiv:hep-th/9210065 [hep-th]].
- [166] E. Witten, “On background independent open string field theory,” *Phys. Rev. D* **46** (1992), 5467-5473 doi:10.1103/PhysRevD.46.5467 [arXiv:hep-th/9208027 [hep-th]].
- [167] A. Sen and B. Zwiebach, “Tachyon condensation in string field theory,” *JHEP* **03**, 002 (2000) doi:10.1088/1126-6708/2000/03/002 [arXiv:hep-th/9912249 [hep-th]].
- [168] V. A. Kostelecky and S. Samuel, “The Static Tachyon Potential in the Open Bosonic String Theory,” *Phys. Lett. B* **207**, 169-173 (1988) doi:10.1016/0370-2693(88)91410-4
- [169] V. A. Kostelecky and S. Samuel, “On a Nonperturbative Vacuum for the Open Bosonic String,” *Nucl. Phys. B* **336**, 263-296 (1990) doi:10.1016/0550-3213(90)90111-P
- [170] N. Moeller and W. Taylor, “Level truncation and the tachyon in open bosonic string field theory,” *Nucl. Phys. B* **583** (2000), 105-144 doi:10.1016/S0550-3213(00)00293-5 [arXiv:hep-th/0002237 [hep-th]].
- [171] D. Gaiotto and L. Rastelli, “Experimental string field theory,” *JHEP* **08** (2003), 048 doi:10.1088/1126-6708/2003/08/048 [arXiv:hep-th/0211012 [hep-th]].
- [172] N. Berkovits, A. Sen and B. Zwiebach, “Tachyon condensation in superstring field theory,” *Nucl. Phys. B* **587** (2000), 147-178 doi:10.1016/S0550-3213(00)00501-0 [arXiv:hep-th/0002211 [hep-th]].
- [173] P. J. De Smet and J. Raeymaekers, “Level four approximation to the tachyon potential in superstring field theory,” *JHEP* **05** (2000), 051 doi:10.1088/1126-6708/2000/05/051 [arXiv:hep-th/0003220 [hep-th]].
- [174] N. Moeller, A. Sen and B. Zwiebach, “D-branes as tachyon lumps in string field theory,” *JHEP* **08** (2000), 039 doi:10.1088/1126-6708/2000/08/039 [arXiv:hep-th/0005036 [hep-th]].
- [175] M. Schnabl, “Analytic solution for tachyon condensation in open string field theory,” *Adv. Theor. Math. Phys.* **10**, no.4, 433-501 (2006) doi:10.4310/ATMP.2006.v10.n4.a1 [arXiv:hep-th/0511286 [hep-th]].
- [176] Y. Okawa, “Comments on Schnabl’s analytic solution for tachyon condensation in Witten’s open string field theory,” *JHEP* **04**, 055 (2006) doi:10.1088/1126-6708/2006/04/055 [arXiv:hep-th/0603159 [hep-th]].
- [177] T. Erler and M. Schnabl, “A Simple Analytic Solution for Tachyon Condensation,” *JHEP* **10**, 066 (2009) doi:10.1088/1126-6708/2009/10/066 [arXiv:0906.0979 [hep-th]].
- [178] T. Erler and C. Maccaferri, “String field theory solution for any open string background. Part II,” *JHEP* **01** (2020), 021 doi:10.1007/JHEP01(2020)021 [arXiv:1909.11675 [hep-th]].
- [179] L. Rastelli and B. Zwiebach, “Tachyon potentials, star products and universality,” *JHEP* **09** (2001), 038 doi:10.1088/1126-6708/2001/09/038 [arXiv:hep-th/0006240 [hep-th]].
- [180] L. Rastelli, A. Sen and B. Zwiebach, “Half strings, projectors, and multiple D-branes in vacuum string field theory,” *JHEP* **11** (2001), 035 doi:10.1088/1126-6708/2001/11/035 [arXiv:hep-th/0105058 [hep-th]].
- [181] D. J. Gross and W. Taylor, “Split string field theory. 1.,” *JHEP* **08** (2001), 009 doi:10.1088/1126-6708/2001/08/009 [arXiv:hep-th/0105059 [hep-th]].
- [182] L. Rastelli, A. Sen and B. Zwiebach, “Boundary CFT construction of D-branes in vacuum string field theory,” *JHEP* **11** (2001), 045 doi:10.1088/1126-6708/2001/11/045 [arXiv:hep-th/0105168 [hep-th]].
- [183] L. Rastelli, A. Sen and B. Zwiebach, “Vacuum string field theory,” [arXiv:hep-th/0106010 [hep-th]].
- [184] D. Gaiotto, L. Rastelli, A. Sen and B. Zwiebach, “Star algebra projectors,” *JHEP* **04** (2002), 060 doi:10.1088/1126-6708/2002/04/060 [arXiv:hep-th/0202151 [hep-th]].
- [185] S. Zeze, “Regularization of identity based solution in string field theory,” *JHEP* **10**, 070 (2010) doi:10.1007/JHEP10(2010)070 [arXiv:1008.1104 [hep-th]].
- [186] E. A. Arroyo, “Comments on regularization of identity based solutions in string field theory,” *JHEP* **11**, 135 (2010) doi:10.1007/JHEP11(2010)135 [arXiv:1009.0198 [hep-th]].

- [187] M. Schnabl, “Algebraic Solutions in Open String Field Theory – a Lightning Review,” *Acta Polytech.* **50**, no.3, 102-108 (2010) doi:10.14311/1213 [arXiv:1004.4858 [hep-th]].
- [188] T. Erler, “Analytic solution for tachyon condensation in Berkovits’ open superstring field theory,” *JHEP* **11** (2013), 007 doi:10.1007/JHEP11(2013)007 [arXiv:1308.4400 [hep-th]].
- [189] T. Erler, “Marginal Solutions for the Superstring,” *JHEP* **07** (2007), 050 doi:10.1088/1126-6708/2007/07/050 [arXiv:0704.0930 [hep-th]].
- [190] Y. Okawa, “Analytic solutions for marginal deformations in open superstring field theory,” *JHEP* **09** (2007), 084 doi:10.1088/1126-6708/2007/09/084 [arXiv:0704.0936 [hep-th]].
- [191] Y. Okawa, “Real analytic solutions for marginal deformations in open superstring field theory,” *JHEP* **09** (2007), 082 doi:10.1088/1126-6708/2007/09/082 [arXiv:0704.3612 [hep-th]].
- [192] N. Moeller and B. Zwiebach, “Dynamics with infinitely many time derivatives and rolling tachyons,” *JHEP* **10** (2002), 034 doi:10.1088/1126-6708/2002/10/034 [arXiv:hep-th/0207107 [hep-th]].
- [193] S. Hellerman and M. Schnabl, “Light-like tachyon condensation in Open String Field Theory,” *JHEP* **04**, 005 (2013) doi:10.1007/JHEP04(2013)005 [arXiv:0803.1184 [hep-th]].
- [194] J. A. Shapiro and C. B. Thorn, “Closed String - Open String Transitions and Witten’s String Field Theory,” *Phys. Lett. B* **194**, 43-48 (1987) doi:10.1016/0370-2693(87)90766-0
- [195] D. Z. Freedman, S. B. Giddings, J. A. Shapiro and C. B. Thorn, “The Nonplanar One Loop Amplitude in Witten’s String Field Theory,” *Nucl. Phys. B* **298**, 253 (1988) doi:10.1016/0550-3213(88)90268-4
- [196] A. Hashimoto and N. Itzhaki, “Observables of string field theory,” *JHEP* **01** (2002), 028 doi:10.1088/1126-6708/2002/01/028 [arXiv:hep-th/0111092 [hep-th]].
- [197] D. Gaiotto, L. Rastelli, A. Sen and B. Zwiebach, “Ghost structure and closed strings in vacuum string field theory,” *Adv. Theor. Math. Phys.* **6** (2003), 403-456 doi:10.4310/ATMP.2002.v6.n3.a1 [arXiv:hep-th/0111129 [hep-th]].
- [198] I. Ellwood, “The Closed string tadpole in open string field theory,” *JHEP* **08** (2008), 063 doi:10.1088/1126-6708/2008/08/063 [arXiv:0804.1131 [hep-th]].
- [199] M. Kudrna, C. Maccaferri and M. Schnabl, “Boundary State from Ellwood Invariants,” *JHEP* **07**, 033 (2013) doi:10.1007/JHEP07(2013)033 [arXiv:1207.4785 [hep-th]].
- [200] M. Kiermaier, Y. Okawa and B. Zwiebach, “The boundary state from open string fields,” [arXiv:0810.1737 [hep-th]].
- [201] E. Witten, “Superstring Perturbation Theory Revisited,” [arXiv:1209.5461 [hep-th]].
- [202] R. Pius, A. Rudra and A. Sen, “Mass Renormalization in String Theory: Special States,” *JHEP* **07** (2014), 058 doi:10.1007/JHEP07(2014)058 [arXiv:1311.1257 [hep-th]].
- [203] R. Pius, A. Rudra and A. Sen, “Mass Renormalization in String Theory: General States,” *JHEP* **07** (2014), 062 doi:10.1007/JHEP07(2014)062 [arXiv:1401.7014 [hep-th]].
- [204] A. Sen, “Gauge Invariant 1PI Effective Superstring Field Theory: Inclusion of the Ramond Sector,” *JHEP* **08** (2015), 025 doi:10.1007/JHEP08(2015)025 [arXiv:1501.00988 [hep-th]].
- [205] W. Fischler and L. Susskind, “Dilaton Tadpoles, String Condensates and Scale Invariance,” *Phys. Lett. B* **171** (1986), 383-389 doi:10.1016/0370-2693(86)91425-5
- [206] R. Pius, A. Rudra and A. Sen, “String Perturbation Theory Around Dynamically Shifted Vacuum,” *JHEP* **10** (2014), 070 doi:10.1007/JHEP10(2014)070 [arXiv:1404.6254 [hep-th]].
- [207] A. Sen, “Supersymmetry Restoration in Superstring Perturbation Theory,” *JHEP* **12** (2015), 075 doi:10.1007/JHEP12(2015)075 [arXiv:1508.02481 [hep-th]].
- [208] M. Cho, S. Collier and X. Yin, “Strings in Ramond-Ramond Backgrounds from the Neveu-Schwarz-Ramond Formalism,” *JHEP* **12** (2020), 123 doi:10.1007/JHEP12(2020)123 [arXiv:1811.00032 [hep-th]].
- [209] M. Cho and M. Kim, “A Worldsheet Description of Flux Compactifications,” [arXiv:2311.04959 [hep-th]].

- [210] J. Polchinski, “String theory. Vol. 1: An introduction to the bosonic string,” Cambridge University Press, 2007, ISBN 978-0-511-25227-3, 978-0-521-67227-6, 978-0-521-63303-1 doi:10.1017/CBO9780511816079
- [211] J. Polchinski, “String theory. Vol. 2: Superstring theory and beyond,” Cambridge University Press, 2007, ISBN 978-0-511-25228-0, 978-0-521-63304-8, 978-0-521-67228-3 doi:10.1017/CBO9780511618123
- [212] A. Sen, “Normalization of type IIB D-instanton amplitudes,” JHEP **12** (2021), 146 doi:10.1007/JHEP12(2021)146 [arXiv:2104.11109 [hep-th]].
- [213] A. Sen, “Muti-instanton amplitudes in type IIB string theory,” JHEP **12** (2021), 065 doi:10.1007/JHEP12(2021)065 [arXiv:2104.15110 [hep-th]].
- [214] S. Alexandrov, A. Sen and B. Stefański, “D-instantons in Type IIA string theory on Calabi-Yau threefolds,” JHEP **11** (2021), 018 doi:10.1007/JHEP11(2021)018 [arXiv:2108.04265 [hep-th]].
- [215] S. Alexandrov, A. Sen and B. Stefański, “Euclidean D-branes in type IIB string theory on Calabi-Yau threefolds,” JHEP **12** (2021), 044 doi:10.1007/JHEP12(2021)044 [arXiv:2110.06949 [hep-th]].
- [216] S. Alexandrov, A. H. Firat, M. Kim, A. Sen and B. Stefański, “D-instanton induced superpotential,” JHEP **07** (2022), 090 doi:10.1007/JHEP07(2022)090 [arXiv:2204.02981 [hep-th]].
- [217] A. Sen, “Normalization of D-instanton amplitudes,” JHEP **11** (2021), 077 doi:10.1007/JHEP11(2021)077 [arXiv:2101.08566 [hep-th]].
- [218] M. B. Green and M. Gutperle, “Effects of D instantons,” Nucl. Phys. B **498** (1997), 195-227 doi:10.1016/S0550-3213(97)00269-1 [arXiv:hep-th/9701093 [hep-th]].
- [219] N. B. Agmon, B. Balthazar, M. Cho, V. A. Rodriguez and X. Yin, “D-instanton Effects in Type IIB String Theory,” [arXiv:2205.00609 [hep-th]].
- [220] D. S. Eniceicu, R. Mahajan, C. Murdia and A. Sen, “Normalization of ZZ instanton amplitudes in minimal string theory,” JHEP **07** (2022), 139 doi:10.1007/JHEP07(2022)139 [arXiv:2202.03448 [hep-th]].
- [221] D. S. Eniceicu, R. Mahajan, C. Murdia and A. Sen, “Multi-instantons in minimal string theory and in matrix integrals,” JHEP **10** (2022), 065 doi:10.1007/JHEP10(2022)065 [arXiv:2206.13531 [hep-th]].
- [222] J. Chakravarty and A. Sen, “Normalization of D instanton amplitudes in two dimensional type 0B string theory,” JHEP **02** (2023), 170 doi:10.1007/JHEP02(2023)170 [arXiv:2207.07138 [hep-th]].
- [223] S. Alexandrov, R. Mahajan and A. Sen, “Instantons in sine-Liouville theory,” [arXiv:2311.04969 [hep-th]].
- [224] A. Sen, “Fixing an Ambiguity in Two Dimensional String Theory Using String Field Theory,” JHEP **03** (2020), 005 doi:10.1007/JHEP03(2020)005 [arXiv:1908.02782 [hep-th]].
- [225] A. Sen, “D-instanton Perturbation Theory,” JHEP **08** (2020), 075 doi:10.1007/JHEP08(2020)075 [arXiv:2002.04043 [hep-th]].
- [226] D. S. Eniceicu, R. Mahajan, P. Maity, C. Murdia and A. Sen, “The ZZ annulus one-point function in non-critical string theory: A string field theory analysis,” JHEP **12** (2022), 151 doi:10.1007/JHEP12(2022)151 [arXiv:2210.11473 [hep-th]].
- [227] A. Sen, “Cutkosky rules and unitarity (violation) in D-instanton amplitudes,” JHEP **07** (2021), 205 doi:10.1007/JHEP07(2021)205 [arXiv:2012.00041 [hep-th]].
- [228] A. Sen, “Unitarity of Superstring Field Theory,” JHEP **12** (2016), 115 doi:10.1007/JHEP12(2016)115 [arXiv:1607.08244 [hep-th]].
- [229] R. Pius and A. Sen, “Cutkosky rules for superstring field theory,” JHEP **10** (2016), 024 [erratum: JHEP **09** (2018), 122] doi:10.1007/JHEP10(2016)024 [arXiv:1604.01783 [hep-th]].
- [230] M. J. G. Veltman, “Unitarity and causality in a renormalizable field theory with unstable particles,” Physica **29** (1963), 186-207 doi:10.1016/S0031-8914(63)80277-3
- [231] A. Sen, “Equivalence of Two Contour Prescriptions in Superstring Perturbation Theory,” JHEP **04** (2017), 025 doi:10.1007/JHEP04(2017)025 [arXiv:1610.00443 [hep-th]].

- [232] B. Balthazar, V. A. Rodriguez and X. Yin, “ZZ instantons and the non-perturbative dual of $c = 1$ string theory,” *JHEP* **05** (2023), 048 doi:10.1007/JHEP05(2023)048 [arXiv:1907.07688 [hep-th]].
- [233] J. Bros, H. Epstein and V. J. Glaser, “Some rigorous analyticity properties of the four-point function in momentum space,” *Nuovo Cim.* **31** (1964), 1265-1302 doi:10.1007/BF02733596
- [234] J. Bros, H. Epstein and V. Glaser, “A proof of the crossing property for two-particle amplitudes in general quantum field theory,” *Commun. Math. Phys.* **1** (1965) no.3, 240-264 doi:10.1007/BF01646307
- [235] C. De Lacroix, H. Erbin and A. Sen, “Analyticity and Crossing Symmetry of Superstring Loop Amplitudes,” *JHEP* **05** (2019), 139 doi:10.1007/JHEP05(2019)139 [arXiv:1810.07197 [hep-th]].
- [236] A. Belopolsky, “New geometrical approach to superstrings,” [arXiv:hep-th/9703183 [hep-th]].
- [237] A. Belopolsky, “Picture changing operators in supergeometry and superstring theory,” [arXiv:hep-th/9706033 [hep-th]].
- [238] C. Wang and X. Yin, “On the equivalence between SRS and PCO formulations of superstring perturbation theory,” *JHEP* **03** (2023), 139 doi:10.1007/JHEP03(2023)139 [arXiv:2205.01106 [hep-th]].
- [239] C. Wang and X. Yin, “Supermoduli and PCOs at Genus Two,” doi:10.1007/JHEP01(2023)144 [arXiv:2205.10377 [hep-th]].
- [240] T. Takezaki, “Open superstring field theory including the Ramond sector based on the supermoduli space,” [arXiv:1901.02176 [hep-th]].
- [241] B. Zwiebach, “New moduli spaces from string background independence consistency conditions,” *Nucl. Phys. B* **480**, 507-540 (1996) doi:10.1016/S0550-3213(96)00501-9 [arXiv:hep-th/9605075 [hep-th]].
- [242] L. Rastelli, A. Sen and B. Zwiebach, “String field theory around the tachyon vacuum,” *Adv. Theor. Math. Phys.* **5**, 353-392 (2002) doi:10.4310/ATMP.2001.v5.n2.a5 [arXiv:hep-th/0012251 [hep-th]].
- [243] L. Rastelli, A. Sen and B. Zwiebach, “Classical solutions in string field theory around the tachyon vacuum,” *Adv. Theor. Math. Phys.* **5**, 393-428 (2002) doi:10.4310/ATMP.2001.v5.n2.a6 [arXiv:hep-th/0102112 [hep-th]].
- [244] Y. Okawa, “Open string states and D-brane tension from vacuum string field theory,” *JHEP* **07**, 003 (2002) doi:10.1088/1126-6708/2002/07/003 [arXiv:hep-th/0204012 [hep-th]].
- [245] N. Drukker and Y. Okawa, “Vacuum string field theory without matter-ghost factorization,” *JHEP* **06**, 032 (2005) doi:10.1088/1126-6708/2005/06/032 [arXiv:hep-th/0503068 [hep-th]].
- [246] M. Schnabl and G. Stetinger, “Open string field theory with stubs,” *JHEP* **07**, 032 (2023) doi:10.1007/JHEP07(2023)032 [arXiv:2301.13182 [hep-th]].
- [247] M. Schnabl and G. Stetinger, “More on stubs in open string field theory,” [arXiv:2402.00308 [hep-th]].
- [248] H. Erbin and A. H. Firat, “Open string stub as an auxiliary string field,” [arXiv:2308.08587 [hep-th]].
- [249] C. Maccaferri, R. Poletti, A. Ruffino and B. Valsesia, “Adding stubs to quantum string field theories,” [arXiv:2403.10471 [hep-th]].
- [250] C. Chiafrino and I. Sachs, “QFT with stubs,” *JHEP* **06**, 120 (2022) doi:10.1007/JHEP06(2022)120 [arXiv:2108.04312 [hep-th]].
- [251] T. Erler and A. H. Firat, “Wilsonian effective potentials and closed string field theory,” *JHEP* **02**, 018 (2024) doi:10.1007/JHEP02(2024)018 [arXiv:2311.17322 [hep-th]].
- [252] H. Erbin and M. Médevielle, “Closed string theory without level-matching at the free level,” *JHEP* **03**, 091 (2023) doi:10.1007/JHEP03(2023)091 [arXiv:2209.05585 [hep-th]].
- [253] Y. Okawa and R. Sakaguchi, “Closed string field theory without the level-matching condition,” [arXiv:2209.06173 [hep-th]].
- [254] R. M. Wald, “Black hole entropy is the Noether charge,” *Phys. Rev. D* **48** (1993) no.8, R3427-R3431 doi:10.1103/PhysRevD.48.R3427 [arXiv:gr-qc/9307038 [gr-qc]].

- [255] G. W. Gibbons and S. W. Hawking, “Action Integrals and Partition Functions in Quantum Gravity,” *Phys. Rev. D* **15** (1977), 2752-2756 doi:10.1103/PhysRevD.15.2752
- [256] T. Erler, “The closed string field theory action vanishes,” *JHEP* **10** (2022), 055 doi:10.1007/JHEP10(2022)055 [arXiv:2204.12863 [hep-th]].
- [257] A. Ahmadain and A. C. Wall, “Off-Shell Strings I: S-matrix and Action,” [arXiv:2211.08607 [hep-th]].
- [258] A. Ahmadain and A. C. Wall, “Off-Shell Strings II: Black Hole Entropy,” [arXiv:2211.16448 [hep-th]].
- [259] P. Kraus, A. Ryzhov and M. Shigemori, “Strings in noncompact space-times: Boundary terms and conserved charges,” *Phys. Rev. D* **66**, 106001 (2002) doi:10.1103/PhysRevD.66.106001 [arXiv:hep-th/0206080 [hep-th]].
- [260] S. Kim, P. Kraus and R. M. Myers, “Systematics of boundary actions in gauge theory and gravity,” *JHEP* **04**, 121 (2023) doi:10.1007/JHEP04(2023)121 [arXiv:2301.02964 [hep-th]].
- [261] Y. Okawa, “Nonperturbative definition of closed string theory via open string field theory,” [arXiv:2006.16449 [hep-th]].
- [262] C. Chiafrino, T. Ersoy and O. Hohm, “Holography as Homotopy,” [arXiv:2307.08094 [hep-th]].
- [263] R. Gopakumar and C. Vafa, “On the gauge theory / geometry correspondence,” *Adv. Theor. Math. Phys.* **3**, 1415-1443 (1999) doi:10.4310/ATMP.1999.v3.n5.a5 [arXiv:hep-th/9811131 [hep-th]].
- [264] D. Gaiotto and L. Rastelli, “A Paradigm of open / closed duality: Liouville D-branes and the Kontsevich model,” *JHEP* **07**, 053 (2005) doi:10.1088/1126-6708/2005/07/053 [arXiv:hep-th/0312196 [hep-th]].
- [265] J. M. Maldacena and H. Ooguri, “Strings in AdS(3) and SL(2,R) WZW model 1.: The Spectrum,” *J. Math. Phys.* **42** (2001), 2929-2960 doi:10.1063/1.1377273 [arXiv:hep-th/0001053 [hep-th]].
- [266] J. M. Maldacena, H. Ooguri and J. Son, “Strings in AdS(3) and the SL(2,R) WZW model. Part 2. Euclidean black hole,” *J. Math. Phys.* **42** (2001), 2961-2977 doi:10.1063/1.1377039 [arXiv:hep-th/0005183 [hep-th]].
- [267] J. M. Maldacena and H. Ooguri, “Strings in AdS(3) and the SL(2,R) WZW model. Part 3. Correlation functions,” *Phys. Rev. D* **65** (2002), 106006 doi:10.1103/PhysRevD.65.106006 [arXiv:hep-th/0111180 [hep-th]].
- [268] M. R. Gaberdiel and R. Gopakumar, “Tensionless string spectra on AdS₃,” *JHEP* **05** (2018), 085 doi:10.1007/JHEP05(2018)085 [arXiv:1803.04423 [hep-th]].
- [269] L. Eberhardt, M. R. Gaberdiel and R. Gopakumar, “The Worldsheet Dual of the Symmetric Product CFT,” *JHEP* **04** (2019), 103 doi:10.1007/JHEP04(2019)103 [arXiv:1812.01007 [hep-th]].
- [270] L. Eberhardt, M. R. Gaberdiel and R. Gopakumar, “Deriving the AdS₃/CFT₂ correspondence,” *JHEP* **02** (2020), 136 doi:10.1007/JHEP02(2020)136 [arXiv:1911.00378 [hep-th]].