

AbstractBeam: Enhancing Bottom-Up Program Synthesis Using Library Learning

Janis Zenkner^{*1}, Lukas Dierkes^{*1}, Tobias Sesterhenn¹, Christian Bartelt¹

¹ Institute for Enterprise Systems
University of Mannheim
Mannheim, 68161
janis.zenkner@uni-mannheim.de

Abstract

LambdaBeam is a state-of-the-art, execution-guided algorithm for program synthesis that utilizes higher-order functions, lambda functions, and iterative loops within a Domain-Specific Language (DSL). LambdaBeam generates each program from scratch but does not take advantage of the frequent recurrence of program blocks or subprograms commonly found in specific domains, such as loops for list traversal. To address this limitation, we introduce AbstractBeam: a novel program synthesis framework designed to enhance LambdaBeam by leveraging Library Learning. AbstractBeam identifies and integrates recurring program structures into the DSL, optimizing the synthesis process. Our experimental evaluations demonstrate that AbstractBeam statistically significantly ($p < 0.05$) outperforms LambdaBeam in the integer list manipulation domain. Beyond solving more tasks, AbstractBeam’s program synthesis is also more efficient, requiring less time and fewer candidate programs to generate a solution. Furthermore, our findings indicate that Library Learning effectively enhances program synthesis in domains that are not explicitly designed to showcase its advantages, thereby highlighting the broader applicability of Library Learning.

Introduction

The field of program synthesis aims to enable machines to automatically generate programs from a set of user-provided specifications, presenting a challenge in artificial intelligence and computer science (Gulwani et al. 2017). Various techniques have been developed to tackle this challenge, including Graph Neural Networks (Allamanis, Brockschmidt, and Khademi 2017), Sequence-to-Sequence models (Alon et al. 2020), and Large Language Models (Chen et al. 2021). In addition to these foundational end-to-end approaches, the use of Domain-Specific Languages (DSLs) and Programming-By-Example (PBE) can refine and target the automated generation of programs.

PBE uniquely allows program specifications through Input-Output (I/O) examples, from which a synthesis tool generates the corresponding code (Polozov and Gulwani 2015). Meanwhile, DSLs are specialized languages designed to address specific problems within particular domains, offering concise syntax and operations optimized for targeted tasks (Van Deursen, Klint, and Visser 2000).

^{*}These authors contributed equally.

A straightforward approach to solve a PBE task is to generate and execute all possible combinations of operations within a DSL. However, the number of combinations grows exponentially with program length, leading to an infeasible combinatorial explosion as the depth and breadth of the search space expand. This search space can be visualized as a decision tree, where longer programs increase depth and more complex DSLs increase breadth. Consequently, the trial-and-error approach becomes impractical for complex tasks.

To address this, many DSL-based program synthesis approaches apply combinatorial searches guided by Artificial Neural Networks (ANNs) or Large Language Models (LLMs) to navigate the search space more efficiently (Balog et al. 2016; Shi, Steinhardt, and Liang 2019; Barke, Peleg, and Polikarpova 2020; Shi, Bieber, and Singh 2022; Grand et al. 2023). However, the exponential growth in search space remains a critical challenge, often limiting the effectiveness of DSL-based program synthesis.

Additionally, programming is an inherently complex cognitive task, combining logic, creativity, and systematic problem-solving (Pea and Kurland 1984). Human programmers often employ a *bottom-up approach*, crafting small, self-contained functions to address specific aspects of a larger problem and then combining these functions to construct a complete software solution (Cormen et al. 2001). Another strategy to reduce complexity and development time is the use of pre-built software libraries. For example, in the domain of Machine Learning, practitioners use model architectures from PyTorch to streamline their development process (Stevens, Antiga, and Viehmann 2020).

Inspired by human software development, approaches like DreamCoder (Ellis et al. 2021) incorporate Library Learning into a top-down synthesis framework. Library Learning identifies and extracts frequently occurring program patterns or subprograms, creating reusable components for more efficient code generation which are added to the initial DSL. DreamCoder integrates this procedure into a wake-sleep cycle: during the wake phase, a simple Bayesian top-down algorithm generates programs; during the sleep phase, repeating subprograms are identified and added to the DSL. By abstracting subprograms containing multiple operations and constants, the length of synthesized programs is reduced, decreasing the search depth and improving efficiency.

LambdaBeam (Shi et al. 2024) focuses on narrowing the search breadth using an execution-guided bottom-up search. During bottom-up synthesis, subprograms are executed, and subsequent searches are informed by these intermediate program states, providing more fine-grained guidance. Additionally, LambdaBeam incorporates higher-order functions, enhancing its capability to handle complex synthesis tasks.

While LambdaBeam is efficient in terms of the number of programs evaluated, it does not utilize Library Learning, leading to a time-consuming generation of these programs. Conversely, DreamCoder excels with Library Learning and abstractions but lacks the fine-grained contextual information available during execution-guided synthesis. Furthermore, the domains DreamCoder was evaluated on contain multiple task clusters that differ only by a single parameter (e.g., *add-k with k=1*, *add-k with k=2*, etc.). This makes it easy to find and apply abstractions, creating an environment that favors Library Learning approaches but overlooks scalability and generalization challenges.

This situation presents an opportunity for a unified approach that combines the strengths of execution-guided bottom-up synthesis and Library Learning. We hypothesize that enhancing LambdaBeam with Library Learning will improve performance by reducing program length and search depth. Additionally, we believe that abstractions can be found in domains not specifically designed to contain program repetitions and that these abstractions do not generalize beyond the domain unless they accurately reflect it.

Driven by these hypotheses, we propose a new framework, AbstractBeam, which leverages LambdaBeam’s search policy and a Library Learning framework inspired by DreamCoder. AbstractBeam can define, use, and reason about operations and abstractions that may include lambda functions, iterative loops, and higher-order functions. We demonstrate the effectiveness of AbstractBeam in the LambdaBeam list manipulation domain exploring its applicability in a domain not specifically designed to showcase program repetitions, providing insights into the scalability and generalization capabilities of AbstractBeam. Our AbstractBeam code is available in the supplementary materials¹.

Background

Programming By Example

PBE is a technique that allows users to describe programs through I/O examples rather than natural language specifications. The objective in PBE tasks is to find a program $\mathcal{P} \in \mathcal{L}$ that correctly maps all inputs $\mathcal{I} = \{I_1, \dots, I_N\}$ to their respective outputs $\mathcal{O} = \{O_1, \dots, O_N\}$. Here, \mathcal{L} represents the space of all possible programs, defined by a DSL that includes constants, input variables, and operations. Operations can be arbitrarily nested and be applied to constants and input variables. Exemplary tasks can be found in the supplementary materials.

¹The code will be made publicly available after publication.

λ -Calculus

The lambda calculus (Church 1985) is a formal system in mathematical logic that can simulate any Turing Machine. In lambda calculus, terms are defined as variables, function applications, and lambda abstractions. Lambda abstractions create new functions with a specific set of variables that define their scope and the function’s body. Unlike traditional lambda functions, which introduce variables one at a time through a process known as “currying,” we allow lambda abstractions to introduce multiple variables simultaneously. Moreover, we incorporate manually designed, domain-specific primitives, such as *Add*, *Sort*, or *Map*, to extend the lambda calculus. Additionally, we employ simply-typed lambda calculus (Pierce 2002) aiding in data type management and function validation.

LambdaBeam

LambdaBeam is a program synthesis framework that utilizes a bottom-up approach, efficiently generating programs by recombining previously explored programs termed “values”. These values are stored in a set that initially only contains input variables and constants. For each step, AbstractBeam iterates over the available operations in the DSL and selects the arguments for the next operation from this set, based on the operation’s arity, i.e., the number of arguments it requires. A neural module assesses the search context, which includes the I/O examples, the current operation f , and the previously explored values. This module outputs a probability distribution over the set of explored values, guiding a beam search algorithm in selecting the most appropriate arguments a_i for the operation f . Once all necessary arguments are selected, the function $f(a_0, \dots, a_{arity})$ is executed, and its output is added to the set of explored values. This process continues until the algorithm successfully synthesizes a program that meets the specified requirements or until the search times out.

The bottom-up generation allows LambdaBeam to construct programs incrementally, refining its search based on intermediate execution results. Deterministic beam search can stall if newly generated values duplicate previously encountered ones, leaving the set of explored values unchanged. To avoid this, the UniqueRandomizer (Shi, Bieber, and Sutton 2020) methodically selects unique samples and records them in a specialized data structure, preventing the reselection of previously chosen values. Moreover, the search process includes periodic restarts to counteract difficulties in recovering from ineffective search paths. These restarts help refresh the search space, though at the cost of discarding previously explored values. Further details on LambdaBeam’s learning algorithm are available in the supplementary materials.

Stitch

Stitch (Bowers et al. 2023) implements an automated synthesis method that extracts abstractions from a corpus of programs. It begins with an initial DSL and employs a top-down search method to identify abstractions that compress the program corpus.

One challenge in this approach is that programs in the corpus may not be in normal form, meaning semantically equivalent subprograms may appear in different syntactical forms, e.g., $t_1(x) = x + 1$ and $t_2(x) = 1 + x$, complicating their identification. Transforming programs into normal form using defined rules can be impractical due to the increasing complexity and frequency of rule applications, akin to the search space blow-up in program generation.

To address this, Stitch forgoes predefined rewrite rules and instead employs a synthesis algorithm that generates programs not to solve tasks but to compress the program corpus by identifying common patterns. This approach sacrifices some completeness in compression for a more efficient identification process.

Stitch begins with an empty abstraction and sequentially adds operations from the DSL. Initially, arguments in abstractions are placeholders, allowing them to be filled with new operations, variables, or constants in subsequent iterations. To enhance generality, Stitch supports partial abstractions, which introduce new variables called "holes" (??) to fill placeholders.

$$\begin{aligned} f_1(x) &= \text{Add}(3, \text{Subtract}(\text{Multiply}(2, 3), 1)) \\ f_2(x) &= \text{Add}(3, \text{Subtract}(\text{Add}(1, 2), \text{Square}(4))) \\ a_{\text{par}}(x) &= \text{Add}(3, ??) \end{aligned}$$

For example, given a program corpus with $f_1(x)$ and $f_2(x)$ and a partial abstraction $a_{\text{par}}(x)$, Stitch iterates over DSL operations to compare and extend this abstraction (e.g., $a_{\text{par}}(x) = \text{Add}(3, \text{Subtract}(\cdot, \cdot))$). An exhaustive top-down search over all operations is infeasible due to the breadth and depth of the search tree. Instead, Stitch selects actions that optimize the compression of the program corpus. It prioritizes operations that maximize the product of an abstraction's length and frequency within the corpus: If a newly added operation's contribution is lower than the current abstraction's, the entire branch can be pruned, leading to significant gains in processing speed and memory efficiency.

AbstractBeam

To demonstrate the potential that Library Learning brings to program synthesis approaches, consider a DSL and a target program $p(l)$ that doubles all even elements in a list l and drops all odd ones.²

$$\begin{aligned} \text{DSL} &= [\text{IsEven}(x), \text{Double}(x), \text{If}(x, \text{then}, \text{else}), \\ &\quad \text{Loop}(l, \text{start}, \text{stop}), \text{Len}(l)] \\ \text{constans} &= [0, 1, 2, 3] \\ p(l) &= \text{Loop}(l, 0, \text{Len}(l)) \\ &\quad (\text{If}(\text{IsEven}(x), \text{Double}(x), \text{Drop}(x))) \end{aligned}$$

Using an exhaustive search up to a maximum length of 8, more than $|\text{DSL}|^{\text{program length}} = 9^8 > 43$ million candidate programs have to be tested to find the solution. However, if LambdaBeam consistently suggests the correct operation, only a single candidate program of weight 8 would

²This illustrative syntax differs from the programs generated by LambdaBeam and AbstractBeam.

be generated. Realistically, LambdaBeam may struggle to determine the start and end parameters of the loop operation. Assuming five options are available for both parameters (the constants and $\text{Len}(l)$), there are $5^2 = 25$ candidate programs to execute to find the solution, which is over six orders of magnitude fewer than with the exhaustive approach. Library Learning further optimizes this process by identifying and reusing common abstractions. Suppose that AbstractBeam has already found an abstraction $a(l)$ that performs a loop over the entire list. With the same assumption as for LambdaBeam, AbstractBeam suggests a single candidate program $p_{\text{AB}}(l)$ of length 5 that solves the task.

$$\begin{aligned} a(l) &= \text{Loop}(l, 0, \text{Len}(l)) \\ p_{\text{AB}}(l) &= a(l)(\text{If}(\text{IsEven}(x), \text{Double}(x), \text{Drop}(x))) \end{aligned}$$

This example illustrates the efficiency of LambdaBeam in finding a solution with minimal candidate programs. AbstractBeam enhances this capability and accelerates solution discovery by shortening program length through the use of abstractions. Consequently, AbstractBeam improves the runtime efficiency of LambdaBeam, offering a more streamlined approach to program synthesis.

AbstractBeam Framework

AbstractBeam enhances program synthesis by incorporating a learning cycle, similar to DreamCoder (Ellis et al. 2021). As illustrated in Figure 1, this cycle consists of two main phases. During the wake phase, the search policy attempts to solve as many tasks as possible using the current DSL. In the sleep phase, the compression algorithm leverages the task solutions from the wake phase to add abstractions to the DSL, which aids in solving more tasks in the next iteration and consequently in discovering more abstractions.

Wake Phase In the wake phase, a bottom-up search policy inspired by LambdaBeam is employed to generate programs that solve the training tasks based on given I/O pairs. The architecture of the neural model comprises four key components: the I/O Module, the Value Model, the Search-Context Summary Module, and the Argument Selector Module. The I/O Module, based on a MLP, processes task examples into a vector. The Value Model embeds explored values and their weights with another MLP. These embeddings are combined into a vector representation by the Search-Context Summary Module. Finally, the Argument Selector Module, based on an LSTM architecture, predicts a probability distribution over the set of possible next steps, i.e., which arguments to use for the current operation. This probability distribution is used as a scoring function for a beam search algorithm to select the most promising arguments. Details on the model architecture can be found in the supplementary materials.

Unlike LambdaBeam, where techniques such as Unique Randomizer and random restarts are typically used only during testing, AbstractBeam applies these methods during the wake phase as well. This ensures a sufficient diversity of programs for the Library Learning algorithm to work with, increasing the likelihood of discovering useful abstractions.

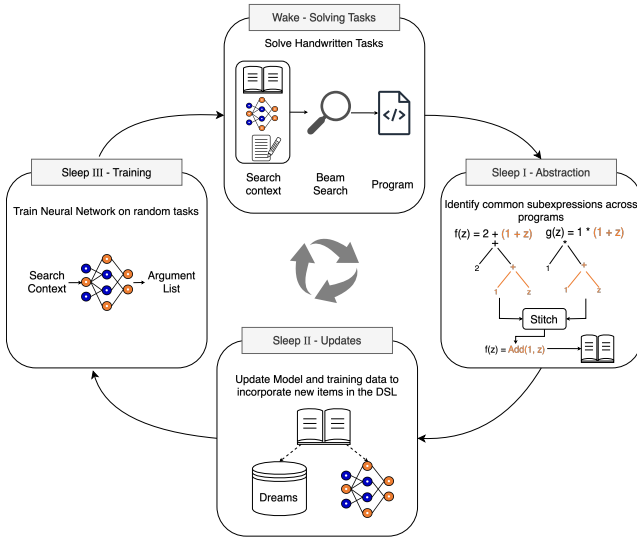

Figure 1: Systematic overview of wake-sleep cycle of the AbstractBeam framework. During the wake phase, programs are generated to solve tasks. Solutions are then used in the sleep phase to find abstractions. Finally, the model architecture and the training data are adapted to newfound abstractions.

Sleep Phase In contrast to LambdaBeam, where the focus is purely on program synthesis, AbstractBeam leverages Stitch (Bowers et al. 2023) to compress and optimize the DSL. This compression is done during the sleep phase which is divided into two parts: abstraction identification and model adaption and training.

The first part involves using Stitch to identify potential abstractions from the solutions generated in the wake phase. For Stitch to identify and utilize abstractions effectively, programs generated by the bottom-up synthesis need to be parsed into a Lisp-like lambda calculus syntax using the de Bruijn notation (De Bruijn 1994). This notation enables the nesting and composition of multiple functions with integer indices representing the binding depth of lambda expressions. For instance, $\lambda x.(\lambda y.(x + y))$ is rewritten as $(\text{lam } (\text{lam } (+ \$1 \$0)))$. Once an abstraction is identified by Stitch, it is converted back into the original format used by AbstractBeam. Since AbstractBeam uses a bottom-up approach, it requires that abstractions are directly executable. However, Stitch sometimes creates partial abstractions that are not immediately executable. To resolve this, holes in partial abstractions are replaced with variables, allowing these abstractions to be executed when given the appropriate input. These variables are treated as additional arguments for the operation turning partial abstractions into "higher-order abstractions". Ultimately, abstractions devoid of variables are stored as constants and are ready for execution. To avoid unnecessary complexity, trivial abstractions, such as $\text{Add}(x2, x1)$, are not added to the DSL but must include at least two DSL expressions that are not variables, i.e., operations, abstractions, and/or constants. Furthermore, abstractions must occur in two or more tasks, ensuring that

abstractions are generalizable and not overly specific to individual tasks.

In the second part, the synthesis model is adapted and trained to learn to use these newly discovered abstractions. The Argument Selector Module is a collection of operation-specific LSTM networks trained to propose the most suitable arguments for each operation based on the search context. In fact, only this module needs to be updated, while all other modules are independent of the DSL and thus continue the training in the next iteration. When new abstractions are added to the DSL, the Argument Selector Module must be updated to incorporate new LSTMs tailored to these operations. These new networks are initialized with the weights of the outermost operation used in the abstraction, providing a solid foundation for the subsequent training process.

In contrast to DreamCoder, which trains on replayed experiences from the wake phase and randomly generated tasks, AbstractBeam solely trains on *task traces* constructed from the current DSL. To generate the task traces, an exhaustive bottom-up search using the current DSL is performed on random tasks. Unlike LambdaBeam, where traces can be pre-generated through exhaustive bottom-up searches without neural guidance, AbstractBeam requires generating new training data at the beginning of each iteration to incorporate new abstractions into the training data. By training on randomly generated traces, AbstractBeam dynamically adapts to the evolving DSL, enabling it to solve progressively more sophisticated problems as the language evolves. Despite the computational overhead associated with repeated training data generation, these updates enable AbstractBeam to effectively manage the combinatorial explosion inherent in the search space.

Evaluation

Experimental setup

Dataset & DSL The same datasets and DSL as in LambdaBeam (Shi et al. 2024) were used for evaluation. The dataset consists of 200 tasks, split evenly between 100 handwritten and 100 synthetic tasks. The handwritten tasks were manually crafted to cover a range of scenarios, while the synthetic tasks were generated through exhaustive bottom-up searches. This synthetic dataset allows us to test our hypothesis that abstractions are beneficial only if they accurately reflect the domain. In both datasets, each task involves between one and three input variables and includes three to five I/O examples to guide the synthesis process. Using the same dataset and DSL as in (Shi et al. 2024) ensures that comparisons between the two are consistent and meaningful. Furthermore, it allows us to directly measure the improvements brought by AbstractBeam without introducing additional variance like different domains that LambdaBeam was not yet evaluated on. Additionally, we can evaluate the potential of Library Learning in domains not specifically designed for abstraction discovery. Exemplary tasks and further details about the DSL are provided in the supplementary materials.

Configurations To manage the volume and complexity of training data, we set a 1000-second time limit on each gener-

ation episode. Within this period, programs with a maximum length of 15 were created. To expedite the process, up to 300 searches were conducted in parallel to generate training data. The data generation timeout was increased by 100 seconds for each added abstraction. This incremental approach was necessary because generating training data involves a complete bottom-up search, and larger DSLs lead to an exponential increase in search duration. During the wake phase, a time limit of 100 seconds per task was imposed, with random restarts occurring every 10 seconds to explore diverse solutions. Both algorithms were trained for a maximum of 10,000 steps per iteration. These parameters were chosen to be lower than those used in LambdaBeam (Shi et al. 2024) to account for our limited computational resources. Other than that, the same hyperparameters were used. Both approaches, AbstractBeam and LambdaBeam, were trained for 10 iterations using four RTX 2080 Ti GPUs. The models that performed best on the handwritten training tasks were selected for evaluation. LambdaBeam was also trained for 10 iterations. Yet, as the DSL does not change in LambdaBeam, all neural modules in LambdaBeam remain unchanged and the training continues after generating more data. This training setup was used to ensure a fair comparison and to prevent any adverse effects that might disadvantage LambdaBeam. We used 50% of the handwritten tasks to define abstractions. It is important to note that these tasks were provided to the model only during the wake phase to potentially find solutions and define abstractions; they were not used to train the model itself. The remaining 50% were used to evaluate the performance. To mitigate any distribution effects, a two-fold cross-validation was performed. Each test set was evaluated five times, and Student’s t-tests with a significance level of 5% were conducted to identify significant differences between the two approaches, following checks for equal variances and normal distributions. The 95% confidence intervals were calculated across trials and are displayed as error bars to convey the precision of the estimates.

Results

Success rate LambdaBeam solved $50.2\% \pm 2.0\%$ of all handwritten test tasks when trained on the first fold and $36.0\% \pm 2.5\%$ on the second fold. AbstractBeam statistically significantly outperformed LambdaBeam achieving $53.6\% \pm 2.3\%$ ($p < 0.05$) on the first and $39.6\% \pm 1.5\%$ ($p < 0.05$) on the second fold. This confirms our first hypothesis that Library Learning leads to an improved performance of LambdaBeam’s synthesis. Exemplary task solutions and a list of all found abstractions can be found in the supplementary materials. As depicted in Figure 2, significant performance differences can only be found for program lengths that use abstractions. For program lengths where no or only a few program solutions contain abstractions, the performance does not differ statistically significantly between both approaches. This also holds true for the second fold (figures can be found in the supplementary materials). This further confirms that the overall performance boost is caused by the use of abstractions.

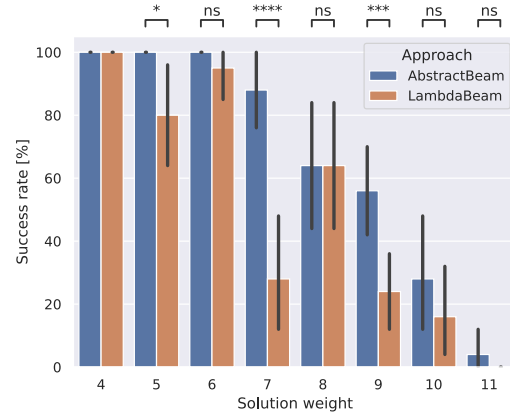

(a) Success rate per program length

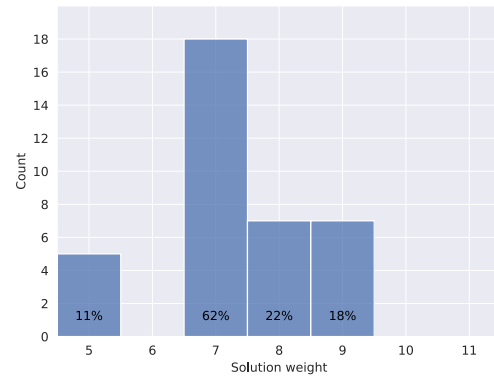

(b) Abstraction usage per program length

Figure 2: AbstractBeam outperforms LambdaBeam. The difference is especially dominant for program length 7. Here, 62% and of programs contain abstractions. The differences are all significant for program lengths that use abstractions except length 8. $ns : p \geq 0.05$, $* : p < 0.05$, $*** : p < 0.001$, $**** : p < 0.0001$

Efficiency We hypothesized that the abstraction-induced search depth reduction causes the performance boost and addresses LambdaBeam’s inefficiency in terms of time. To further analyze this, Figure 3a shows the performance of both approaches over the enumeration time, i.e., the elapsed time until a solution was found. Clearly, AbstractBeam shows an increased performance with less enumeration time. This proves the reduced search space in AbstractBeam. Furthermore, we compared the elapsed time on handwritten tasks that were successfully solved by both AbstractBeam ($2.57s \pm 5.58s$) and LambdaBeam ($4.57s \pm 7.07s$) across all five trials. As depicted in Figure 3c, AbstractBeam consistently solved these tasks in less time than LambdaBeam. This decrease in search time demonstrates that the search space reduction facilitated by the abstractions in AbstractBeam not only increases the overall performance by solving more tasks but also en-

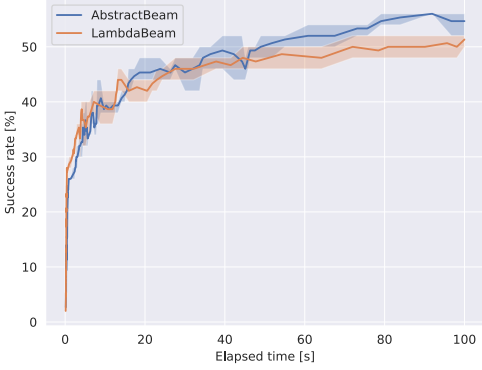

(a) Enumeration time

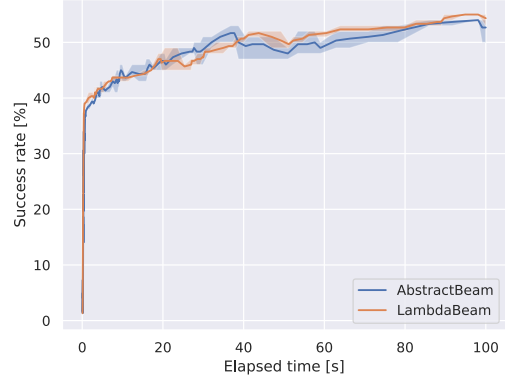

(a) Enumeration time

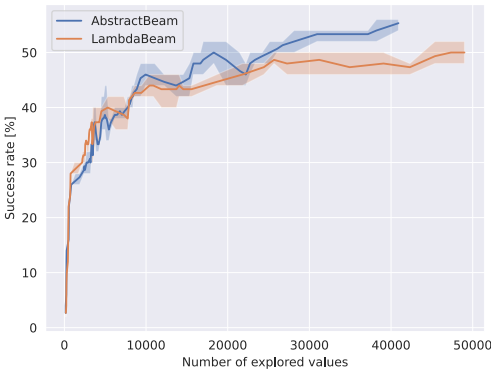

(b) Candidate programs

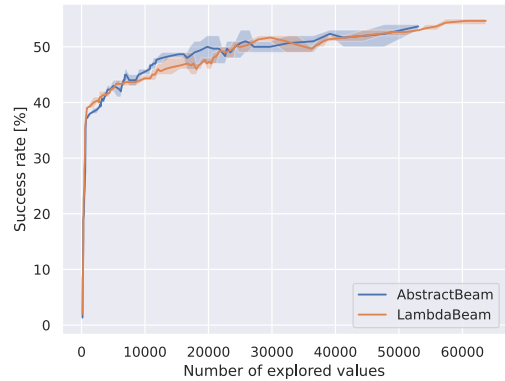

(b) Candidate programs

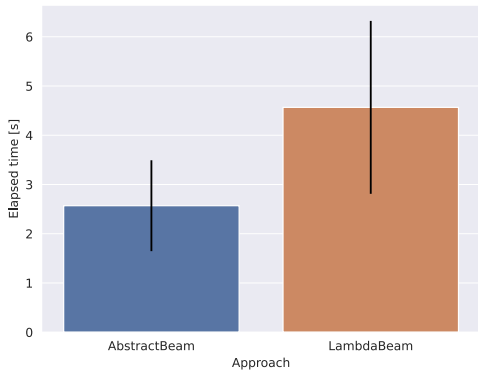

(c) Enumeration times for tasks solved by both approaches

Figure 3: With less enumeration time and fewer candidate programs AbstractBeam achieves better performance than LambdaBeam.

hances efficiency by clearly reducing the enumeration time required to find solutions. This improvement underscores the effectiveness of incorporating Library Learning and abstraction mechanisms in optimizing the search process. Moreover, AbstractBeam also shows an improved perfor-

Figure 4: Due to the distribution shift, no performance differences between LambdaBeam and AbstractBeam exist on the synthetic dataset.

mance with fewer candidate programs (Figure 3b). This also relates to the reduction of the search space depth and boosts AbstractBeam’s proficiency even further. Interestingly, AbstractBeam enumerates fewer programs than LambdaBeam even though both algorithms used the same timeout to generate programs. This relates to the fact that adding abstractions to the DSL increases the search width but lowers the search depth. With a reduced search depth, fewer candidate programs are suggested. As AbstractBeam still outperforms LambdaBeam, the balance between a larger DSL and a reduced search depth is advantageous. However, adding abstractions that are not used and bloat the DSL will shift this balance and neglect all benefits of Library Learning. This highlights the care that must be taken when designing the initial and altering the current DSL.

Synthetic dataset To assess the degree to which abstractions scale beyond the domain they were found in, we evaluated both approaches on the synthetic dataset. No significant performance differences were found between AbstractBeam (fold 1: 52.6% ± 1.4%, fold 2: 52.4% ± 1.9%)

and LambdaBeam (fold 1: $53.8\% \pm 1.2\%$, fold 2: $51.2\% \pm 1.7\%$). As shown in Figure 4, there are also no differences in the enumeration time and the number of evaluated candidate programs. Consequently, even though abstractions are used in the solution of synthetic tasks, they do not reduce the search depth. This is further supported by the enumeration times for the synthetic tasks solved by both approaches. AbstractBeam took clearly longer to find a solution, with an average time of $3.62s \pm 12.14s$, compared to LambdaBeam, which averaged $1.37s \pm 5.34s$. The reason for this is that abstractions are derived from the handwritten dataset. The handwritten dataset however does not reflect the distribution of the synthetic dataset (see the figures in the supplemental materials). Therefore, this aligns with our hypothesis that abstractions do not generalize to out-of-distribution domains.

Limitations The key limitation of AbstractBeam is the structure of the domain which imposes two constraints: First, Library Learning only works if abstractions are possible. This requires that sufficient program repetitions must exist in the solution space and sufficient tasks (or data samples) must contain these program repetitions. Second, on a more practical note, the model must be able to solve sufficient tasks, especially in the first iteration. Otherwise, the Library Learning algorithm cannot identify program repetitions even though sufficient tasks exist that contain a potential abstraction. While both points are restrictions of the task domain, the latter also relates to the design of the initial DSL that must be specific enough to solve tasks but general enough to allow repetitions. Besides limitations imposed by Library Learning, one has to consider the overhead of re-generating training data. Moreover, there are only slight absolute performance differences between LambdaBeam and AbstractBeam that are likely caused by the structure of the LambdaBeam domain. Yet, our experiments prove that the statistically significant increase in solved tasks and the more efficient solution generation are attributed to the automatic introduction of domain-specific abstractions. In addition, our results underline the general applicability of Library Learning outside of DSLs and domains designed to show the effect of Library Learning.

Related work

Human behavior has been a fundamental source of inspiration for developing new approaches in machine learning, ranging from the creation of the first ANNs (Krogh 2008) to the development of generative agents that imitate human beings in social interactions (Pearce et al. 2023). In the field of program synthesis, this idea is also prevalent. Some approaches train ANNs on solution traces gathered from human problem solvers (Park et al. 2023), while others mimic human strategies by employing hierarchical approaches that break down complex problems into smaller, more manageable tasks (Murali et al. 2017; Nye et al. 2019; Hong et al. 2021; Shrivastava, Larochelle, and Tarlow 2021; Zhong et al. 2023; Tan and Motani 2023; Zelikman et al. 2023).

These techniques aim to develop new solution strategies

but often do not directly address the primary bottleneck of program synthesis, which is the exploding search space. A common approach to mitigating this issue is guiding a search algorithm toward more promising regions. Methods for guidance vary, from leveraging prior knowledge (Yin and Neubig 2017) to executing intermediate programs that condition subsequent searches (Chen, Liu, and Song 2018; Zohar and Wolf 2018; Ellis et al. 2019; Chen, Song, and Tian 2021; Odena et al. 2020). Generally, ANNs are employed to identify auspicious areas for exploration (Yin and Neubig 2017; Ellis et al. 2019; Lee et al. 2018).

Our approach uses a framework inspired by DreamCoder (Ellis et al. 2021) yet builds upon LambdaBeam’s (Shi et al. 2024) search strategy. LambdaBeam itself adapts CrossBeam (Shi et al. 2022) to allow the use of higher-order functions. Both, employ multi-level, neural, and execution-guided synthesis. By integrating LambdaBeam into an architecture inspired by DreamCoder we add Library Learning as a fourth strategy to reduce the search space. Opposed to LambdaBeam, DreamCoder employs a top-down search strategy and does not condition its program generation on intermediate execution information. Moreover, the DreamCoder DSL consists of primitive operations yielding many commonly used subprograms. Furthermore, DreamCoder’s list domain is manually designed to show the effect of DSL enhancement by consisting of task clusters differing in one parameter only, e.g., *add-k* with *k* ranging from zero to five. Similar to AbstractBeam, LILO (Grand et al. 2023) builds upon the DreamCoder wake-sleep cycle and also uses Stitch. This approach demonstrates that leveraging human-readable language instructions for added abstractions can improve LLM-based program synthesis and alignment with human reasoning. This diverges from the goals of our work that focuses on creating a more resource-efficient program synthesis approach.

Conclusion

We introduce AbstractBeam, an execution-guided program synthesis framework that employs Library Learning to enhance its DSL in a data-driven manner. By tailoring the DSL to the specific domain it is applied to, AbstractBeam achieves improved performance and more efficient program generation. Our results demonstrate that the use of Library Learning enables AbstractBeam to automatically identify and incorporate useful abstractions, leading to significant gains in efficiency.

However, as Library Learning is inherently data-driven, the abstractions it discovers do not generalize beyond the domain they are derived from. This limitation is evident in our experimental results and highlights the ongoing challenge of designing an effective DSL that can accommodate a wide range of tasks. Incorporating domain-specific abstractions into the DSL likely embeds valuable domain knowledge, potentially aiding the model in better understanding the domain. Nonetheless, the extent to which this supports program synthesis remains an open question and warrants further investigation.

References

- Allamanis, M.; Brockschmidt, M.; and Khademi, M. 2017. Learning to represent programs with graphs. *arXiv preprint arXiv:1711.00740*.
- Alon, U.; Sadaka, R.; Levy, O.; and Yahav, E. 2020. Structural language models of code. In *International conference on machine learning*, 245–256. PMLR.
- Balog, M.; Gaunt, A. L.; Brockschmidt, M.; Nowozin, S.; and Tarlow, D. 2016. Deepcoder: Learning to write programs. *arXiv preprint arXiv:1611.01989*.
- Barke, S.; Peleg, H.; and Polikarpova, N. 2020. Just-in-time learning for bottom-up enumerative synthesis. *Proceedings of the ACM on Programming Languages*, 4(OOPSLA): 1–29.
- Bowers, M.; Olausson, T. X.; Wong, L.; Grand, G.; Tenenbaum, J. B.; Ellis, K.; and Solar-Lezama, A. 2023. Top-down synthesis for library learning. *Proceedings of the ACM on Programming Languages*, 7(POPL): 1182–1213.
- Chen, M.; Tworek, J.; Jun, H.; Yuan, Q.; Pinto, H. P. d. O.; Kaplan, J.; Edwards, H.; Burda, Y.; Joseph, N.; Brockman, G.; et al. 2021. Evaluating large language models trained on code. *arXiv preprint arXiv:2107.03374*.
- Chen, X.; Liu, C.; and Song, D. 2018. Execution-guided neural program synthesis. In *International Conference on Learning Representations*.
- Chen, X.; Song, D.; and Tian, Y. 2021. Latent execution for neural program synthesis. *arXiv preprint arXiv:2107.00101*.
- Church, A. 1985. *The calculi of lambda-conversion*. 6. Princeton University Press.
- Cormen, T.; Leiserson, C.; Rivest, R.; and Stein, C. 2001. *Advanced Algorithms*. Citeseer.
- De Bruijn, N. G. 1994. A survey of the project AUTOMATH. In *Studies in Logic and the Foundations of Mathematics*, volume 133, 141–161. Elsevier.
- Ellis, K.; Nye, M.; Pu, Y.; Sosa, F.; Tenenbaum, J.; and Solar-Lezama, A. 2019. Write, execute, assess: Program synthesis with a repl. *Advances in Neural Information Processing Systems*, 32.
- Ellis, K.; Wong, C.; Nye, M.; Sablé-Meyer, M.; Morales, L.; Hewitt, L.; Cary, L.; Solar-Lezama, A.; and Tenenbaum, J. B. 2021. Dreamcoder: Bootstrapping inductive program synthesis with wake-sleep library learning. In *Proceedings of the 42nd acm sigplan international conference on programming language design and implementation*, 835–850.
- Grand, G.; Wong, L.; Bowers, M.; Olausson, T. X.; Liu, M.; Tenenbaum, J. B.; and Andreas, J. 2023. Lilo: Learning interpretable libraries by compressing and documenting code. *arXiv preprint arXiv:2310.19791*.
- Gulwani, S.; Polozov, O.; Singh, R.; et al. 2017. Program synthesis. *Foundations and Trends® in Programming Languages*, 4(1-2): 1–119.
- Hong, J.; Dohan, D.; Singh, R.; Sutton, C.; and Zaheer, M. 2021. Latent programmer: Discrete latent codes for program synthesis. In *International Conference on Machine Learning*, 4308–4318. PMLR.
- Krogh, A. 2008. What are artificial neural networks? *Nature biotechnology*, 26(2): 195–197.
- Lee, W.; Heo, K.; Alur, R.; and Naik, M. 2018. Accelerating search-based program synthesis using learned probabilistic models. *ACM SIGPLAN Notices*, 53(4): 436–449.
- Murali, V.; Qi, L.; Chaudhuri, S.; and Jermaine, C. 2017. Neural sketch learning for conditional program generation. *arXiv preprint arXiv:1703.05698*.
- Nye, M.; Hewitt, L.; Tenenbaum, J.; and Solar-Lezama, A. 2019. Learning to infer program sketches. In *International Conference on Machine Learning*, 4861–4870. PMLR.
- Odena, A.; Shi, K.; Bieber, D.; Singh, R.; Sutton, C.; and Dai, H. 2020. BUSTLE: bottom-up program synthesis through learning-guided exploration. *arXiv preprint arXiv:2007.14381*.
- Park, J.; Im, J.; Hwang, S.; Lim, M.; Ualibekova, S.; Kim, S.; and Kim, S. 2023. Unraveling the arc puzzle: Mimicking human solutions with object-centric decision transformer. *arXiv preprint arXiv:2306.08204*.
- Pea, R. D.; and Kurland, D. M. 1984. On the cognitive effects of learning computer programming. *New ideas in psychology*, 2(2): 137–168.
- Pearce, T.; Rashid, T.; Kanervisto, A.; Bignell, D.; Sun, M.; Georgescu, R.; Macua, S. V.; Tan, S. Z.; Momennejad, I.; Hofmann, K.; et al. 2023. Imitating human behaviour with diffusion models. *arXiv preprint arXiv:2301.10677*.
- Pierce, B. C. 2002. *Types and programming languages*. MIT press.
- Polozov, O.; and Gulwani, S. 2015. Flashmeta: A framework for inductive program synthesis. In *Proceedings of the 2015 ACM SIGPLAN International Conference on Object-Oriented Programming, Systems, Languages, and Applications*, 107–126.
- Shi, K.; Bieber, D.; and Singh, R. 2022. Tf-coder: Program synthesis for tensor manipulations. *ACM Transactions on Programming Languages and Systems (TOPLAS)*, 44(2): 1–36.
- Shi, K.; Bieber, D.; and Sutton, C. 2020. Incremental sampling without replacement for sequence models. In *International Conference on Machine Learning*, 8785–8795. PMLR.
- Shi, K.; Dai, H.; Ellis, K.; and Sutton, C. 2022. CrossBeam: Learning to search in bottom-up program synthesis. *arXiv preprint arXiv:2203.10452*.
- Shi, K.; Dai, H.; Li, W.-D.; Ellis, K.; and Sutton, C. 2024. LambdaBeam: Neural Program Search with Higher-Order Functions and Lambdas. *Advances in Neural Information Processing Systems*, 36.
- Shi, K.; Steinhardt, J.; and Liang, P. 2019. Frangel: component-based synthesis with control structures. *Proceedings of the ACM on Programming Languages*, 3(POPL): 1–29.
- Shrivastava, D.; Larochelle, H.; and Tarlow, D. 2021. Learning to combine per-example solutions for neural program synthesis. *Advances in Neural Information Processing Systems*, 34: 6102–6114.

A LambdaBeam

LambdaBeam (Shi et al. 2024) is a neural synthesis search method designed to handle iterative loops, higher-order functions, and lambda functions within a program synthesis framework. It builds on the search framework of CrossBeam (Shi et al. 2022), a method that performs a bottom-up search applying DSL operations to previously-explored values. LambdaBeam introduces a neural policy capable of reasoning about lambda functions, allowing for the construction and use of these functions in a manner tailored to specific synthesis tasks.

A.1 LambdaBeam Search

LambdaBeam employs a bottom-up search strategy, similar to that of CrossBeam, where it begins with a set of basic elements (inputs and constants) and incrementally constructs more complex expressions by applying operations from a DSL. The core idea is to explore the search space by considering all possible combinations of previously generated values (or expressions) with available operations, thereby producing new values that can potentially solve the given task. The overall synthesis workflow is depicted in Figure 1. During this search process, LambdaBeam maintains a set of explored values, which includes constants, input variables, and the outputs of previously synthesized programs. The neural model (Figure 2) embedded within LambdaBeam plays a crucial role in guiding the search by assessing the context of the task—specifically, the I/O examples, the current operation, and the current set of explored values. The model consists of several key components:

- **Value Module:** This module encodes each explored value into a vector representation. For lambda expressions, it creates semantic vector representations based on their execution behavior, using a technique called property signatures. These signatures capture the functional properties of the expressions, allowing the model to reason about their potential usefulness in solving the task.
- **Argument Selector Module:** For each operation, an operator-specific LSTM network predicts the arguments by pointing to previously explored values.
- **Search Context Summary Module:** This module aggregates information from the I/O examples and the set of explored values, providing a summary vector that informs the decision-making process of the Argument Selector Module.

This context-aware guidance helps LambdaBeam prioritize the most promising paths in the search space. The search policy in LambdaBeam is further refined with two key strategies: random restarts and the UniqueRandomizer technique. Random restarts help the model avoid getting stuck in unproductive regions of the search space by periodically resetting the search. The UniqueRandomizer ensures that the model does not repeatedly explore the same values, thereby increasing the diversity of the search.

A.2 Building λ functions

One of the main challenges in handling lambdas in neural search algorithms is their algebraic representation and manipulation. Practically equivalent lambdas like $\lambda x.x + 1$, $\lambda y.y + 1$, and $\lambda x, y.x + 1$ need to be represented canonically to prune the search space effectively. LambdaBeam addresses this with a new MERGE operation: The MERGE operation is specifically designed to construct more complex lambda expressions by systematically combining simpler terms while ensuring that all intermediate terms are free of unbound variables. This is achieved by introducing additional lambda abstractions where necessary, thus binding any free variables and aligning the expressions with a canonical form known as η -long normal form in typed lambda

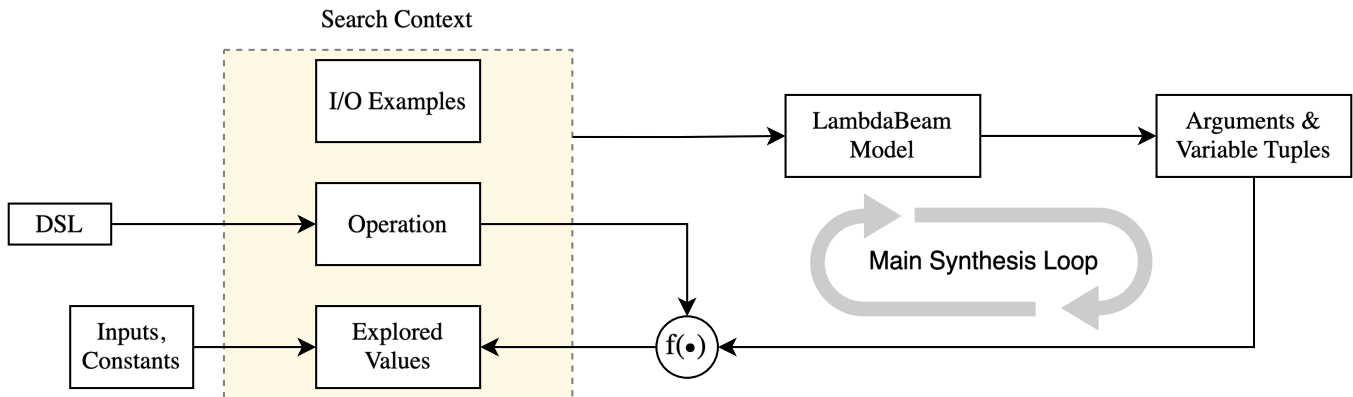

Figure 1: LambdaBeam synthesis overview (Shi et al. 2024). The synthesis model utilizes contextual information from the task specifications to condition the selection of arguments.

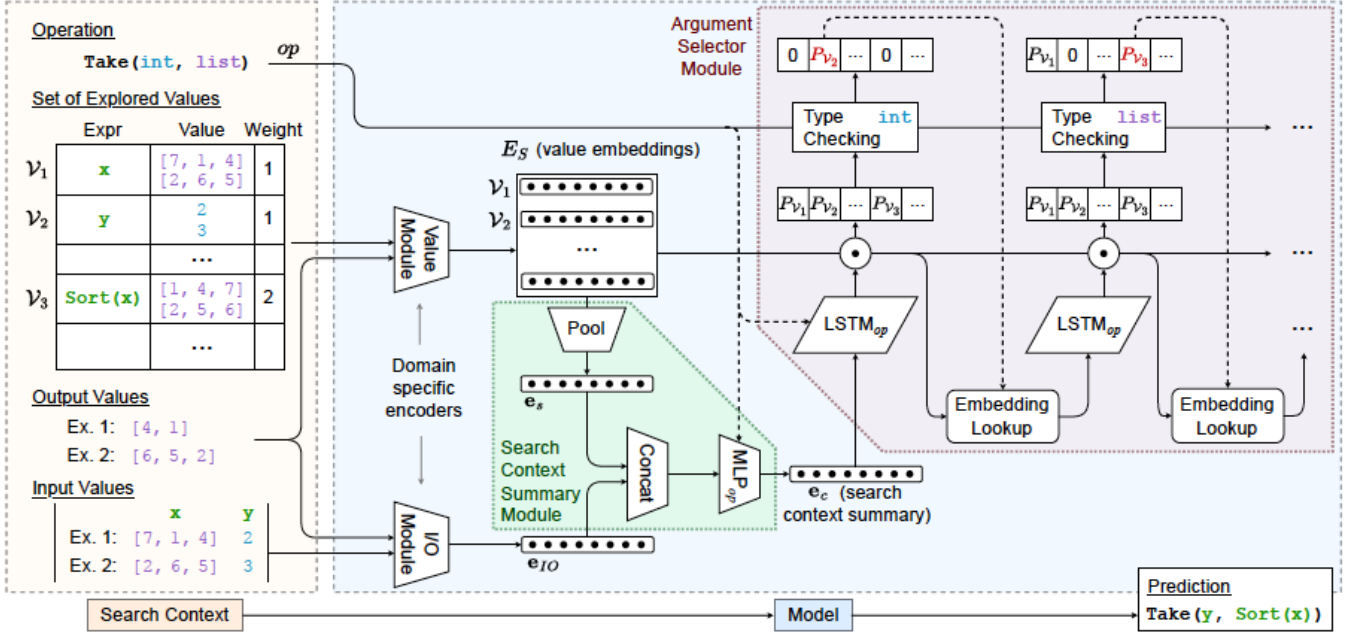

Figure 2: LambdaBeam model architecture (Shi et al. 2024). The I/O Module processes I/O examples of tasks into a vector e_{IO} using an MLP. The Value Model embeds the set of explored values and their weights employing an MLP. The Search-Context Summary Module combines the value embeddings and I/O vector into a vector representation e_c . Finally, based on an $LSTM_{op}$ architecture, the Argument Selector Module predicts the distribution used to determine the argument list for a given operation.

calculus. The MERGE operation ensures that all terms created during the synthesis process are fully bound, meaning they do not contain any free variables that would cause ambiguity.

$$t_{\text{before}} = \text{Map}(\lambda u_1 : \text{If}(\text{Equal}(f, u_1), r, u_1), x)$$

$$t_{\text{after}} = \text{Map}(\lambda u_1 : (\lambda v_1 : \text{If}((\lambda v_1 : \text{Equal}(f, v_1))(v_1), r, v_1))(u_1), x))$$

For example, when combining terms resulting in t_{before} the MERGE operation systematically transforms this into a form where any free variables are explicitly bound within the expression, yielding t_{after} . Another critical function of the MERGE operation is to standardize the naming and ordering of variables within the combined expression. By doing so, LambdaBeam reduces the likelihood of generating structurally different yet functionally identical terms. This canonicalization process helps to minimize the search space by ensuring that equivalent terms are recognized as such, thus avoiding unnecessary duplication. This ensures that the term is not only syntactically correct but also semantically clear, with all variables being properly defined within the expression. In summary, the MERGE operation plays a vital role in allowing the model to build complex lambda functions from simpler components. By addressing program aliasing and ambiguity early in the synthesis process, MERGE enables the assembly of lambda expressions, making the overall search process more efficient.

B DSL

We used the same DSL as in LambdaBeam (Shi et al. 2024). This consists of 23 first-order, five higher-order functions, and the constants $-1, 0, 1, 2, 3, 4$.

```
# 23 first-order operations
def Add(x: int, y: int) -> int:
    return x + y

def Subtract(x: int, y: int) -> int:
    return x - y

def Multiply(x: int, y: int) -> int:
    return x * y
```

```
def IntDivide(x: int, y: int)-> int:
    return x // y

def Square(x: int)-> int:
    return x ** 2

def Min(x: int, y: int)-> int:
    return min(x, y)

def Max(x: int, y: int)-> int:
    return max(x, y)

def Greater(x: int, y: int)-> bool:
    return x > y

def Less(x: int, y: int)-> bool:
    return x < y

def Equal(x: int, y: int)-> bool:
    return x == y

def IsEven(x: int)-> bool:
    return x % 2 == 0

def IsOdd(x: int)-> bool:
    return x % 2 != 0

def If(c: bool, x: int, y: int)-> int:
    return x if c else y

def Head(xs: list)-> int:
    return xs[0]

def Last(xs: list)-> int:
    return xs[-1]

def Take(n: int, xs: list)-> list:
    return xs[:n]

def Drop(n: int, xs: list)-> list:
    return xs[n:]

def Access(n: int, xs: list)-> int:
    return xs[n]

def Minimum(xs: list)-> int:
    return min(xs)

def Maximum(xs: list)-> int:
    return max(xs)

def Reverse(xs: list)-> list:
    return list(reversed(xs))

def Sort(xs: list)-> list:
    return sorted(xs)

def Sum(xs: list)-> int:
    return sum(xs)
```

```

# 5 higher-order operations
def Map(f: Callable[[int], int], xs: list)-> list:
    return [f(x) for x in xs]

def Filter(f: Callable[[int], bool], xs: list)-> list:
    return [x for x in xs if f(x)]

def Count(f: Callable[[int], bool], xs: list)-> int:
    return len([x for x in xs if f(x)])

def ZipWith(f: Callable[[int, int], int], xs: list, ys: list)-> list:
    return [f(x, y) for x, y in zip(xs, ys)]

def Scanl1(f: Callable[[int, int], int], xs: list)-> list:
    ys = [xs[0]]
    for n in range(1, len(xs)):
        ys.append(f(ys[n-1], xs[n]))
    return ys

```

C Dataset

The tasks used in our evaluation are consistent with those employed in LambdaBeam (Shi et al. 2024). They are carefully constructed to represent a range of complexity levels. The task solutions are measured by their "weight", i.e., the program length. This simple metric reflects the complexity of the generated program, with lower weights indicating straightforward, more efficient solutions. Each task typically includes one to three input variables and is accompanied by three to five I/O examples. These examples are crucial as they guide the synthesis model in generating a program that correctly maps the given inputs to the expected outputs. The tasks are designed to cover various operations, such as filtering lists, counting elements, and performing arithmetic operations, which test the model's ability to discern patterns and relationships within the data. In general, each task is structured as follows:

- **Input variables:** Tasks typically involve one to three input variables, which are lists of integers. These variables represent the data that the model must process.
- **I/O examples:** Each task includes three to five I/O examples that specify the desired output for a given set of inputs. These examples help the model learn the correct transformation or operation that needs to be applied to the inputs.
- **Expected solution:** The expected solution is a program that takes the input variables and produces the correct outputs as specified by the I/O examples.

This consistent task structure allows for a comprehensive evaluation of the model's capabilities, ensuring that it can handle a wide range of scenarios. For additional details on the task construction, please refer to LambdaBeam (Shi et al. 2024). Below, we present specific examples from the handwritten dataset used in LambdaBeam, showcasing how AbstractBeam performs in comparison.

Task "count:num-under-first" In this task, the goal is to count the number of elements in each input list that are smaller than the first element of the list.

```

1 inputs_dict = {
2   'x': [[5, 2, 6, 7, 1, 3, 8],
3         [26, 0, 19, 22, 39, 47, 1, 26],
4         [65, 33, 16, 53, 34, 95, 86, 4, 12],
5         [-11, 23, -48, -24, -11, -4, 44, 7, -26, -12],
6         [-11, 23, -48, -24, -11, -14, 44, 7, -26, -12]]
7 }
8 outputs = [3, 4, 6, 4, 5]
9 solution='Count((lambda u1: Less(u1, Head(x))), x)'

```

AbstractBeam used the following program including an abstraction to solve the task:

```

1 fn_0(Head(x), x)
2 fn_0 = Count(Less(v1, x1) x2)

```

This solution has a weight of four and was generated in 0.35 ± 0.14 seconds. In contrast, LambdaBeam’s solution had a weight of seven and was only found in two of five runs, taking 9.86 and 22.01 seconds, respectively:

```
Count((lambda u1: ((lambda v1: Greater(Head(x), v1)) (u1)), x)
```

Task “filter:negative-descending” This task requires filtering all negative numbers in the input list x and sorting them in descending order.

```
1 inputs_dict = {
2   'x': [[-4, 8, 1, -2, -9, -5],
3         [-11, 10, -13, -19, 0, -12, -10],
4         [3, -38, -48, 32, -43, -19, 23, -36, -44, 48]]
5 }
6 outputs = [[-2, -4, -5, -9],
7            [-10, -11, -12, -13, -19],
8            [-19, -36, -38, -43, -44, -48]]
9 solution = 'Filter((lambda u1: Less(u1, 0)), Reverse(Sort(x)))'
```

Interestingly, AbstractBeam found an alternative solution in 0.69 ± 0.27 seconds, which also had a weight of seven, by utilizing an abstraction:

```
1 Reverse(Take(fn_0(-1, x), Sort(x)))
2 fn_0 = Count(Less(v1, x1) x2)
```

In this solution, the input list is first sorted in ascending order. The program then determines the number of elements smaller than -1 and takes the first n elements from the sorted list before reversing them.

LambdaBeam also identified an alternative solution yet with a weight of eight, taking 1.58 ± 0.34 seconds:

```
1 Reverse(Sort(Filter((lambda u1: ((lambda v1: Greater(-1, v1)) (u1)), x)))
```

These examples illustrate how AbstractBeam can efficiently generate solutions that are often simpler and faster to find than those generated by LambdaBeam, particularly by leveraging abstractions identified during the learning process.

D Supplemental Results

D.1 Abstractions

All found abstractions are displayed in Table 1. Interestingly, besides simple abstractions, “higher-order” abstractions are found as shown by $x1(\text{Min}(0, x2))$.

Table 1: Abstractions found on by AbstractBeam.

Fold	Abstractions
1	$fn_0 = \text{Count}((\lambda v1 : \text{Less}(v1, x1)), x2)$ $fn_1 = x1(\text{Min}(2, x2))$ $fn_3 = \text{Add}(-1, x1)$ $fn_5 = \text{Count}((\lambda v1 : \text{Equal}(v1, x1)), x2)$ $fn_6 = x1(\text{Min}(fn_3(1), x2))$ $fn_8 = x1(\text{Min}(0, x2))$ $fn_{14} = x1(0, x2)$
2	$fn_0 = \text{Reverse}(\text{Sort}(x1))$ $fn_1 = \text{Take}(-1, x1)$ $fn_3 = \text{Sum}(\text{Take}(x2, x1))$ $fn_9 = \text{ZipWith}((\lambda u1, v1 : (\text{Subtract}(v1, x1))), x3, x2)$ $fn_{10} = fn_9(\text{Minimum}(x1), x1, x1)$ $fn_{11} = \text{Sum}(\text{ZipWith}((\lambda u1, v1 : (\text{Multiply}(v1, u1))), x2, x1))$ $fn_{14} = \text{Scanl1}((\lambda u1, v1 : (\text{Add}(v1, u1))), x1)$ $fn_{18} = \text{ZipWith}((\lambda u1, v1 : (\text{Multiply}(v1, u1))), x2, x1)$ $fn_{21} = \text{Filter}((\lambda v1 : \text{IsOdd}(v1)), x1)$ $fn_{22} = \text{Scanl1}((\lambda u1, v1 : (\text{Multiply}(v1, u1))), x1)$ $fn_{24} = \text{Head}(x1(fn_0(x2)))$

D.2 Further Analysis

Handwritten dataset second fold The findings of the first fold also hold true for the second fold: AbstractBeam statistically significantly ($p < 0.05$) outperforms LambdaBeam on the handwritten dataset. LambdaBeam achieved a success rate of $36.0\% \pm 2.5\%$ on handwritten test tasks when trained on the while AbstractBeam achieved $39.6\% \pm 1.5\%$ solved test tasks. This supports our initial hypothesis that Library Learning enhances the synthesis performance of LambdaBeam.

Moreover, we hypothesized that the performance gain is due to abstraction-induced reduction in search depth, addressing LambdaBeam’s limitation of low time efficiency. Figure 3a illustrates the performance of both approaches relative to enumeration time, i.e., the time taken to find a solution. It is evident that AbstractBeam demonstrates enhanced performance with the same or even less enumeration time, confirming the reduced search space depth in AbstractBeam. Interestingly, the enumeration times for tasks that were successfully solved by LambdaBeam and AbstractBeam do not differ as clearly (Figure 3c). In fact, AbstractBeam takes on average $5.85s \pm 12.39s$ while LambdaBeam takes $5.57s \pm 15.04s$. In consistency with the better performance given the same enumeration time, AbstractBeam also solves more tasks with the same number of explored values (Figure 3b). Again, LambdaBeam enumerated more candidate programs. This again relates to the abstraction-induced larger DSL and further highlights the care that must be taken when adding abstractions. This reduction in search time and candidate programs indicates that the abstraction-driven search space reduction in AbstractBeam not only improves overall task-solving performance but also significantly enhances efficiency by reducing the time needed to find solutions. This improvement highlights the effectiveness of integrating Library Learning and abstraction mechanisms in optimizing the search process.

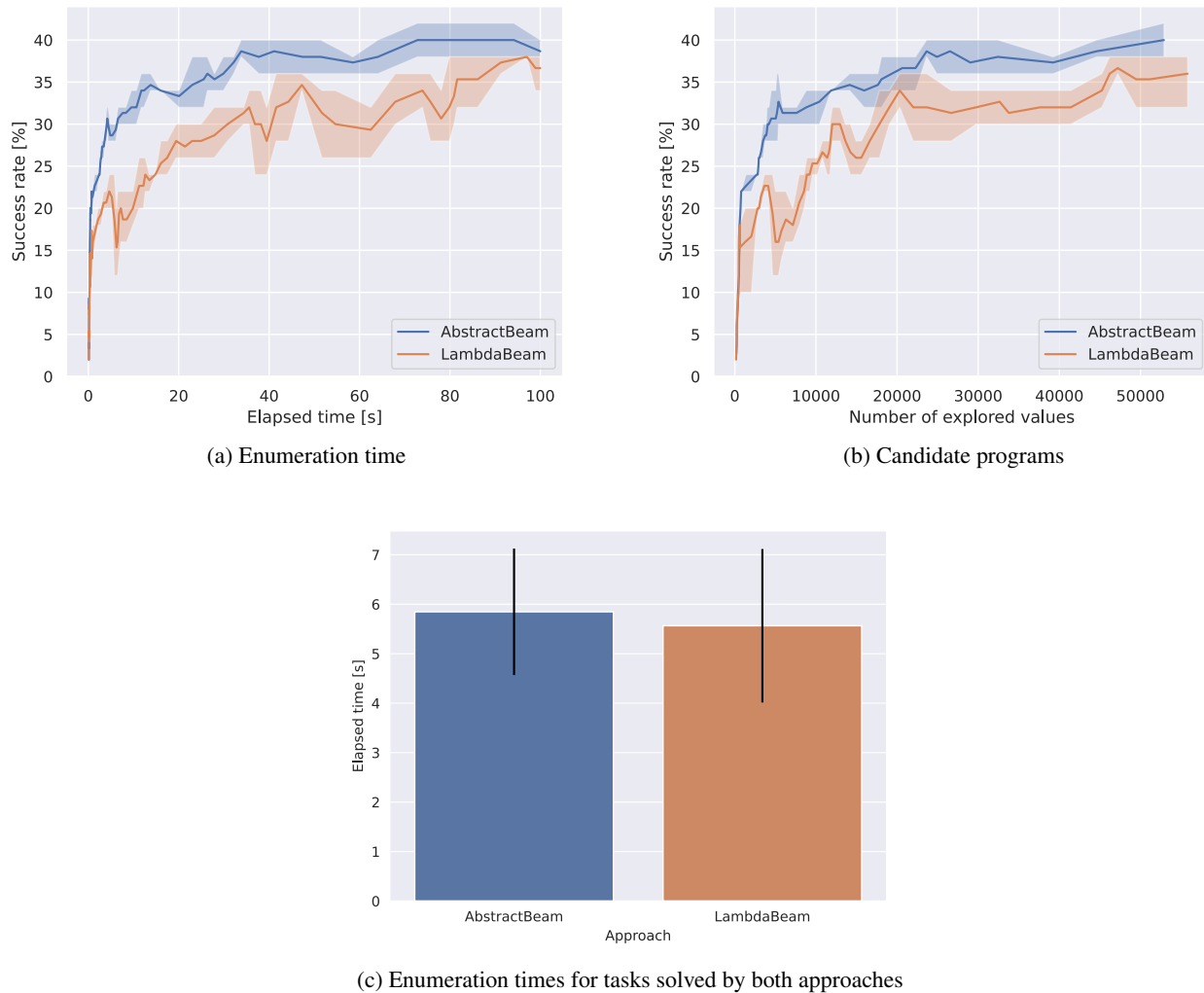

Figure 3: AbstractBeam solves more programs compared to LambdaBeam given the same enumeration time and number of candidate programs.

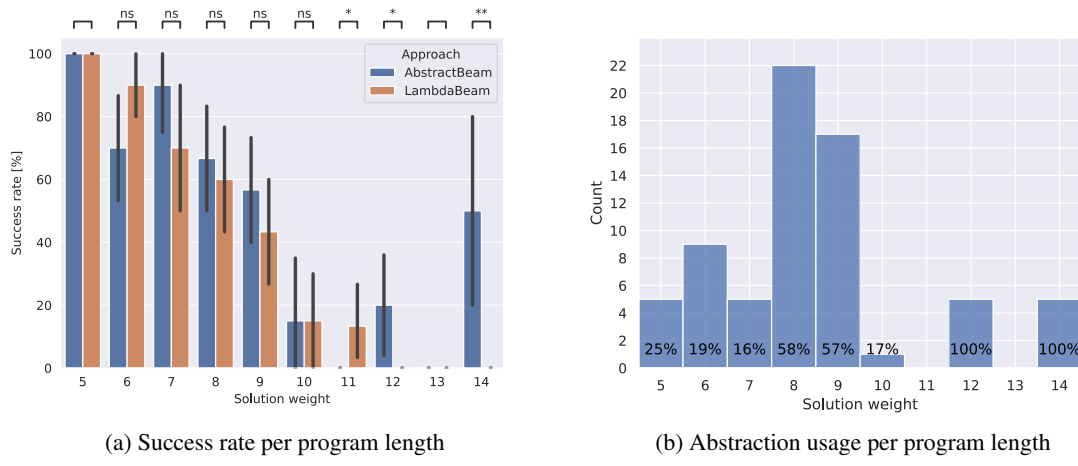

Figure 4: Clearly, AbstractBeam solves more programs. This trend gets more dominant the longer the programs get. *ns* : $p \geq 0.05$, * : $p < 0.05$

As shown in Figure 4, significant performance differences only emerge in program lengths that utilize abstractions. For shorter program lengths with minimal or no use of abstractions, no statistically significant differences were observed between the two approaches. This further confirms that the use of abstractions drives the overall performance improvement. Moreover, AbstractBeam also demonstrated better performance with fewer candidate programs (Figure 3c), further emphasizing the reduction in search space depth and enhancing LambdaBeam’s effectiveness. Interestingly, AbstractBeam generated fewer programs than LambdaBeam despite both algorithms having the same timeout for program generation. This is because adding abstractions to the DSL reduces search depth while increasing search width, resulting in more candidate programs. Yet, despite the increased search width, AbstractBeam still outperforms LambdaBeam, suggesting that the balance between a larger DSL and reduced search depth is beneficial. However, introducing abstractions that are not utilized and only inflate the DSL can offset these benefits, underscoring the importance of carefully designing and modifying the DSL.

Synthetic dataset No significant performance differences were found when evaluating both approaches on the synthetic dataset. The distributions of the synthetic and the handwritten dataset differ clearly as shown in Figure 5. This explains the performance of AbstractBeam on the synthetic dataset. Here, the abstractions found on the handwritten training set do not

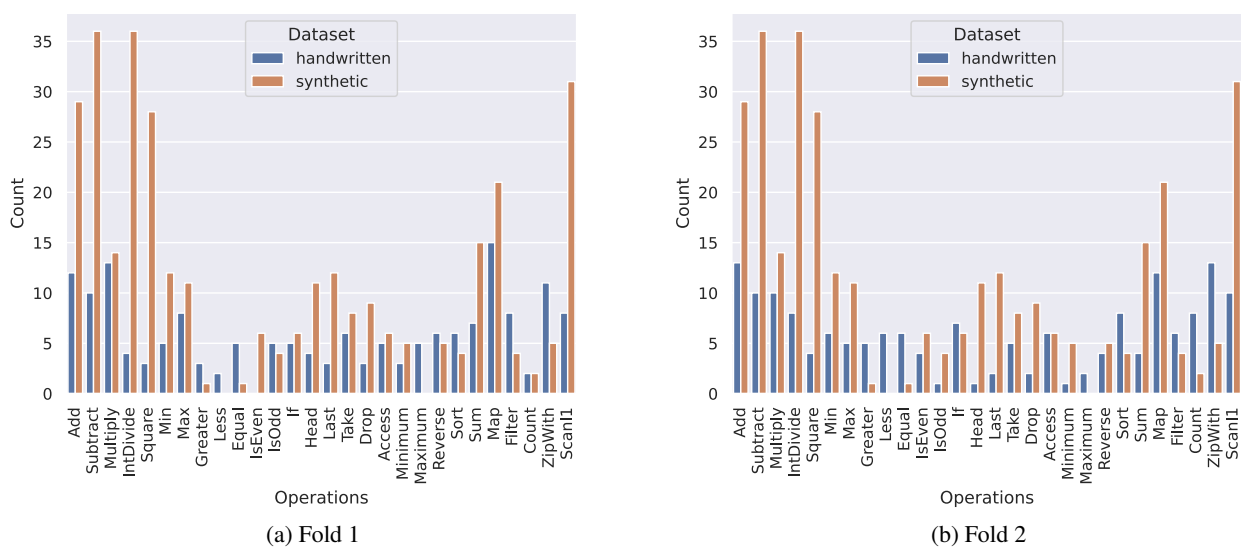

Figure 5: Histogram of operations in the handwritten and synthetic dataset.

Stevens, E.; Antiga, L.; and Viehmann, T. 2020. *Deep learning with PyTorch*. Manning Publications.

Tan, J. C. M.; and Motani, M. 2023. Large Language Model (LLM) as a System of Multiple Expert Agents: An Approach to solve the Abstraction and Reasoning Corpus (ARC) Challenge. *arXiv preprint arXiv:2310.05146*.

Van Deursen, A.; Klint, P.; and Visser, J. 2000. Domain-specific languages: An annotated bibliography. *ACM SIGPLAN Notices*, 35(6): 26–36.

Yin, P.; and Neubig, G. 2017. A syntactic neural model for general-purpose code generation. *arXiv preprint arXiv:1704.01696*.

Zelikman, E.; Huang, Q.; Poesia, G.; Goodman, N.; and Haber, N. 2023. Parsel: Algorithmic Reasoning with Language Models by Composing Decompositions. *Advances in Neural Information Processing Systems*, 36: 31466–31523.

Zhong, L.; Lindorfer, R.; Zhang, J.; Lin, L.; and Sun, S.-H. 2023. Hierarchical neural program synthesis. *arXiv preprint arXiv:2306.01818*.

Zohar, A., and Wolf, L. 2018. Automatic program synthesis of long programs with a learned garbage collector. *Advances in neural information processing systems*, 31.

occur in the solution space. Thus, they cannot be usefully applied. As abstractions do not fit the distribution of the synthetic dataset, the performance and efficiency boost that Library Learning gives in AbstractBeam is eliminated. As shown in Figure 6, this does not mean that abstractions are not applied in the solution of synthetic tasks but rather that abstractions do not reduce the program length.

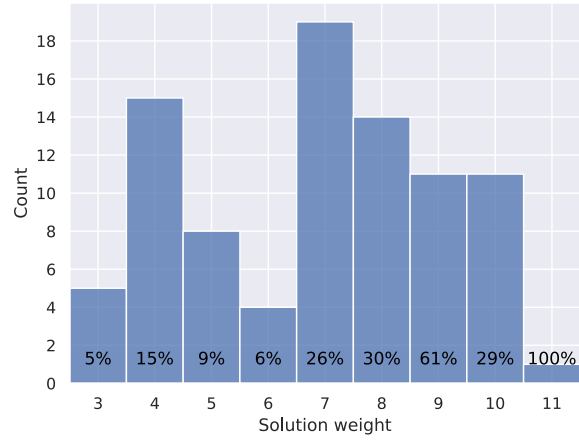

(b) Abstraction usage per program length

Figure 6: On the synthetic dataset, no significant performance differences between LambdaBeam and AbstractBeam exist. This is because abstractions found on the handwritten dataset do not reduce the search depth in the synthetic domain. *ns* : $p \geq 0.05$