

A Systematic Review on Sleep Stage Classification and Sleep Disorder Detection Using Artificial Intelligence

Tayab Uddin Wara[†], Ababil Hossain Fahad[†], Adri Shankar Das[†], Md. Mehedi Hasan Shawon^{†*}

tayabuddinwara@gmail.com, ababilhossainfahad@gmail.com, adrishankar@gmail.com,
shawon.cse.bracu@gmail.com

BSRM School of Engineering, BRAC University, Dhaka, Bangladesh.

Abstract

Sleep is vital for people's physical and mental health, and sound sleep can help them focus on daily activities. Therefore, a sleep study that includes sleep patterns and sleep disorders is crucial to enhancing our knowledge about individuals' health status. The findings on sleep stages and sleep disorders relied on polysomnography (PSG) and self-report measures, and then the study went through clinical assessments by expert physicians. However, the evaluation process of sleep stage classification and sleep disorder has become more convenient with artificial intelligence (AI) applications and numerous investigations focusing on various datasets with advanced algorithms and techniques that offer improved computational ease and accuracy. This study aims to provide a comprehensive, systematic review of the recent literature to analyze the different approaches and their outcomes in sleep studies, which includes works on "sleep stages classification" and "sleep disorder detection" using AI. In this review, 183 articles were initially selected from different journals, among which 80 records were enlisted for explicit review, ranging from 2016 to 2023. Brain waves were the most commonly employed body parameters for sleep staging and disorder studies (almost 29% of the research used brain activity signals exclusively, and 77% combined with the other signals). The convolutional neural network (CNN), the most widely used of the 34 distinct artificial intelligence models, comprised 27%. The other models included the long short-term memory (LSTM), support vector machine (SVM), random forest (RF), and recurrent neural network (RNN), which consisted of 11%, 6%, 6%, and 5% sequentially. For performance metrics, accuracy was widely used for a maximum of 83.75% of the cases, the F1 score of 45%, Kappa of 36.25%, Sensitivity of 31.25%, and Specificity of 30% of cases, along with the other metrics. This article would help physicians and researchers get the gist of AI's contribution to sleep studies and the feasibility of their intended work.

Keywords: Sleep Stage Classification, Sleep Disorder Detection, Artificial Intelligence, Systematic Review.

1. Introduction

Sleep is considered one of the most important aspects of a healthy physical and mental state. If any hindrance occurs in regular sleep, body functioning and metabolism tend to be disoriented; for example, a recent study also showed that sleep quality affects academic performance [1]. Furthermore, according to the National Sleep Foundation survey, disturbed sleep patterns have been found among 40% of patients with different diseases and disorders [2]. As a result, sleep study analysis and monitoring are essential for overall quality and a healthy life. A sleep study is a process where patients are observed the whole night, the patient's polysomnography (PSG) data is taken, and at the same time, an expert technician classifies the sleep stages. PSG includes multivariate biological signals such as electrocardiograms (ECG) for heart activity,

*Corresponding author.

[†] Equal Contribution in Manuscript Preparation.

electroencephalograms (EEG) for brain waves, electrooculograms (EOG) for eye movement records, respiratory flow, and blood oxygen saturation level, and electromyograms (EMG) for muscle movement. EEG is the most frequently used by sleep specialists among the mentioned biosignals. After the overnight sleep data is collected, these signals and the sleep stages classification are sent for interpretation by doctors specializing in sleep to check for sleep disorders. Sleep is categorized into different stages, such as wake (W), rapid eye movement (REM), and non-rapid eye movement (NREM). NREM is further classified into four stages, Stage 1 to Stage 4. The stage at which our brain tries to ease and muscle gets relaxed is defined as Stage 1. Stage 2 denotes the actual sleep stage, and our eye movements become no longer visible. At stage 3, our brain sleep, which becomes deeper at stage 4 of NREM. The stage when a person is deeply asleep, but their eyes are continuously moving, is called the REM sleep stage. Although Sleep is a natural process of calmness of voluntary and sensory muscles, our brain continuously works during Sleep [3]. The EEG signals show variable patterns not only in different sleep stages but also in different sleep disorders. A physician can identify sleep stages and sleep-related issues by adequately identifying the variation in EEG signals. EEG signals are frequently used biosignals to represent the brain's activity during different stages of sleep and find different sleep disorders. There are five types of EEG signals: alpha, beta, delta, gamma, and theta. Alpha consists of a frequency ranging from 8Hz to 13Hz (relaxation), beta consists of a frequency ranging from 13Hz to 30Hz (consciousness), delta denotes the frequency ranging from 0.5Hz to 4Hz (deep sleep), gamma denotes the frequencies that are more than 30Hz (Conscious and Focused), and theta denotes the frequency ranging from 4Hz to 8Hz (first stages of sleep) [4]. These waves come with different characteristics and are connected to specific stages of sleep. A mixture of frequency, sawtooth pattern, and low amplitude is visible in the REM stage. Alpha waves are visible with a 2-7 Hz frequency and the highest amplitude in NREM stage 1. Spindles of frequency ranging from 12 Hz to 14 Hz are visible in NREM stage 2. In stages 3 and 4 of NREM, there are low-frequency waves of 2 Hz, which denote the deep sleep stage. These wave patterns are also aperiodic and can rapidly change over several hours during sleep. All these waves of PSG are interpreted in frames of 5-10 seconds for categorization and identification of the sleep stages [3].

Sleep studies involve detecting sleep stages and then finding any possible sleep disorders. There are several types of sleep disorders, such as rapid eye movement behavior disorder (RBD), periodic limb movement disorder (PLMD), bruxism, and obstructive sleep apnea [5, 6], which affect a wide range of people daily due to their detrimental physiological effects and high prevalence [7, 8]. Delving into disorders like insomnia occurs when a person cannot sleep or finds it difficult. Fatigue, cognitive impairment, daytime sleepiness, and irritability are some symptoms of insomnia. Additionally, bruxism is an involuntary movement disorder. The symptoms of bruxism include automatically chewing the teeth without intention while sleeping. Another type of disorder, narcolepsy, is a rapid eye movement disorder, which is a long-term disorder. Each of the patients with different sleep disorders tends to have abnormalities in their

sleep signal patterns and trends compared with the stored patterns of healthy individuals. Discrepancies have been observed by manually comparing the signals (typically compressed into a few to high-frequency continuous) with the manuals provided to expert sleep physicians. Different disorders are to be found depending on the degree of abnormalities obtained. Analyzing one single whole-night sleep pattern takes numerous hours to extract meaningful interpretations from an expert sleep technician.

With all the discussion, we observed the complexity of the traditional method of sleep study, which is completed manually by a physician. Hours are taken to generate a report from these signals. Thus, researchers noticed the need for a new, consistent method to help the physician deal with the complexity and create a precise report. Artificial intelligence, including machine learning algorithms, has shown promising results in different fields of study, including bioinformatics. Hence, sleep study analysis has also experienced a significant transformation with the widespread application of AI in predicting sleep stages and disorders. This transformation is evident in the increasing number of studies utilizing AI models for sleep stage classification and disorder detection. For instance, the authors [9] introduced SleepEEGNet, a deep learning approach that achieved an overall accuracy of 84.26% in sleep stage scoring. Similarly, another work [10] demonstrated the effectiveness of transfer learning in wearable sleep stage classification using photoplethysmography, and the authors [11] used a wrist-worn device to collect the relevant accelerometer and applied a Random Forest algorithm to predict sleep classification. Several ML algorithms are also applied by the authors, such as Random Forest (RF), K-Nearest Neighbours (KNN), Support Vector Machines (SVM), and a hybrid neural network model that gained 87.4% accuracy in the sleep stage classification [12]. Unsupervised machine learning algorithms and Actigraphy are also utilized to classify sleep or wake [13]. Furthermore, the authors [14] proposed a model called U-Sleep, which is publicly available for automated sleep staging and based on deep learning architecture. Besides, another work [15] used 'Oura Ring' to collect multiple sensor data like accelerometer, autonomic nervous system (ANS)-mediated peripheral signals, and circadian, then applied a machine learning model to sleep stage detection with a maximum accuracy of 94%.

Moreover, numerous examples of sleep disorder detection using AI models are also observed, for example, a study by [16], which presents an explainable Convolutional Neural Network (CNN) for detecting Sleep Apnea from single-channel EEG recordings. The authors explained the mechanism analysis using critical-band masking and lesioning, which indicated the network learned frequency-band information associated with known sleep apnea biomarkers, emphasizing the potential clinical use of single-channel EEG for diagnosis. The CNN demonstrated good generalization across subjects with an accuracy of 69.9% and a Matthews correlation coefficient (MCC) of 0.38. The study of Rechichi et al. [17] shows the automation of detecting Rapid Eye Movement Sleep Behaviour Disorder (RBD) by identifying REM Sleep Without Atonia (RSWA) in polysomnographic traces. The Dissociation Index, utilizing Euclidean distance, assesses the

level of dissociation between the REM sleep stage and atonia, serving as a continuous measure. Their machine learning models achieved an 87% accuracy and 93% sensitivity in classifying RSWA subjects, and the Dissociation Index showed promise in evaluating the impairment level of patients. The method is a potential step toward automating the identification of REM sleep disorders and assessing the associated impairment. Here, the authors [18] utilized the Stanford STAGES dataset and proposed an interpretable machine learning solution for screening major depressive disorder (MDD) using 5-minute nighttime electrocardiogram (ECG) signals. The Bayesian-optimized extremely randomized trees classifier demonstrated the best performance (accuracy 86.32%), emphasizing the significance of gender in the model's prediction and suggesting potential integration into portable ECG monitoring systems.

This work was further inspired by the absence of a comprehensive review of the latest advancements in sleep stage classification and sleep disorder detection utilizing artificial intelligence. The SLR on sleep apnea detection using deep learning was published in early 2023 [19]. However, it doesn't represent the prediction of other sleep disorders using artificial intelligence. On the other hand, there is a review article on automatic sleep stage classification [20], where many vital factors still need to be included. Therefore, a complete review is necessary to understand the overall contribution of artificial intelligence applications in sleep study analysis, including sleep stage and disorder classification, and to investigate the recent findings. This review paper includes recent articles on sleep stage and sleep disorder studies using artificial intelligence, where numerous methodologies and techniques have been applied in different applications. Our key contributions to this article are:

- We analyzed the recent findings of 80 articles on sleep stage classification and sleep disorder detection from 2016 to 2023 using artificial intelligence. The number of articles from each year is shown in Figure 1.
- We found the most popular AI model for sleep stage classification and sleep disorder detection, along with the most widely used body parameters and evaluation metrics.

We present the current progress in automation in sleep stage classification and sleep disorders recognition research in terms of AI-based algorithms. This aims to give clear insights into current artificial intelligence techniques and machine learning algorithms applied in sleep study analysis and help researchers with future work.

In this paper, we have organized our investigation into several sections to provide a comprehensive outline of the use of artificial intelligence in sleep study analysis. Section 2 discussed the methodology and detailed our research steps and strategies, including formulating research questions and abstracting our search strategy to identify relevant literature. In section 3, we talked about the necessity of artificial intelligence. We highlighted the potential benefits of AI in enhancing the overall efficiency of sleep studies while reducing manual labor and operational

costs. Then, in section 4, we discussed some machine learning models and their working principles, illustrating their mechanisms through block diagrams. We also examined the advantages and disadvantages of these models to guide researchers in selecting the most suitable model for specific objectives. Subsequently, in section 5, we explained the results in detail, where we analyzed the 80 selected articles to identify commonly used body parameters, sample data size, machine learning models, and evaluation metrics in the context of sleep study analysis. Looking ahead to section 6, where we discussed the future research directions, we pinpointed study gaps and outlined the potential future scope of research in this field. This section not only drew insights from the reviewed publications but also provided a roadmap for future studies, including direct contributions from our work and an analytical report based on the collective findings of the reviewed literature. Finally, in section 7, we summarized the current advancements in sleep study analysis, acknowledging the limitations of our study while reflecting on the broader landscape of research in this domain.

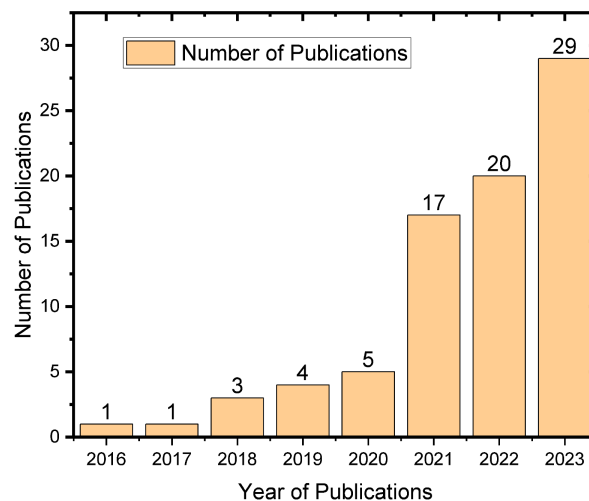

Figure 1. The number of publications considered over the years for this SLR.

2. Methodology

A review paper provides an overview of progress in a particular field or topic depending on the currently available literature so that a reader gets a brief idea of that specific field by reading only one paper. There are different types of review papers, such as narrative and systematic. We have accomplished this paper as a systematic literature review (SLR) since we gathered information by empirical research to answer some specific research questions to analyze and present the findings from the selected articles. In this paper, we have reviewed the sleep study, which includes sleep stage classification and sleep disorder detection analysis that is being accomplished using artificial intelligence. The work method can be divided into three phases. In phase 1, different online journals were utilized to search for relevant works using specific keywords described in section 2.2.1. The papers beyond the scope of this research were removed.

We fixed some criteria to exclude some papers, and as a result, we finally got eighty papers for analysis Figure 2. After gathering relevant literature, some research questions were set to analyze the literature, described in section 2.2.1. Different parameters were investigated, such as the best-fitted model, performance, data source, sample size of the data sets, the signal utilized for the study, and type of study (sleep stage classification or sleep disorder detection). In phase 2, all 80 papers were thoroughly reviewed, and all the mentioned data was extracted. This phase reflects the collaborative work as 80 papers were distributed among the authors to read and collect the data. This parallel working technique significantly reduces time and effort, making the data collection smooth and accurate. In phase 3, collected parameters were analyzed, and recent trends, frequency distributions, and work variation were observed using visual illustration in section 5. By analyzing the trends and graphs, the research questions were addressed. Finally, future scopes were determined by profoundly analyzing all the papers and this study.

2.1 Research Questions

Research Question 1. What different body parameters were used in sleep studies for Artificial Intelligence applications?

During the overnight monitoring, physiological signals, such as EEG, EOG, EMG, and ECG, are collected, along with breathing functions, respiratory airflow, peripheral pulse oximetry, etc. However, we need to determine the most widely used body parameters for sleep studies to apply the AI models and get the best possible output. We would like to investigate the different body-generated signals and dependencies for which performance fluctuates.

Research Question 2. What sample dataset size was considered in the experiments?

Types and numbers of datasets are crucial factors in training AI models, which impact their performance, efficiency, and accuracy. This question investigates the significance of the diverse and different samples included in different researchers' work with frequency usage, which will be answered via the findings.

Research Question 3. Which ML models were best fitted in the experiment?

For the intended different sleep stage classifications or disorder detection, the widely used, sophisticated AI algorithms are the key findings that must be addressed. The exploration time and efforts spent executing different models for the best outcome will be significantly reduced by answering this.

Research Question 4. What were the evaluation methods and performance metrics of the experiment?

Different evaluation methods (validation) and performance metrics are indicators of the robustness of the executed AI models. Different cross-validations are intended to exhibit various metrics, like accuracy, F1, kappa, sensitivity, specificity, and so on. Quantitative analysis of the model's performance and evaluation are crucial for determining the anticipated outputs traced by answering.

2.2 Search Strategy

Table 1 shows our paper selection strategy from different journal databases. Figure 2 shows the number of papers initially found, the criteria for which papers were discarded automatically and manually, and the number of papers left for the final review.

2.2.1 Keyword Selection

We set four specific keywords to search our relevant papers. These are sleep studies with artificial intelligence, sleep studies with machine learning, sleep stage classification, sleep disorder, and/or detection. Different authors may have used different synonyms for these keywords, but they worked within the scope of our study. Therefore, we have chosen keywords to represent all the works in this review article.

Table 1: Keyword Search

Database	Search query used
Springer, Nature, PLOS One, PubMed, Science Direct, MDPI, Hindawi, Peerj	(“sleep study with artificial intelligence” OR “sleep study with AI”) AND (“sleep study with machine learning” OR “sleep study with ML”) AND (“sleep stage” OR “sleep stage classification” OR “sleep classification”) AND (“sleep disorder and detection” OR “sleep disorder” OR “sleep detection”)

2.2.2 Screening

From the different sources mentioned in the PRISMA diagram, we initially got 183 publications. After that, we removed 60 papers because they were duplicates or inaccessible. Therefore, we can say that this is our limitation that we cannot access every journal paper, although they are available online, but paid for. Moreover, we removed 16 other publications because the papers did not use machine learning and were outside the range from 2016 to 2023. Furthermore, 27 articles were removed because they did not match the subject of this study. All the processes were done manually. After all the steps, we finally left with 80 articles to study in this paper. These papers include 32 sleep disorder papers and 48 sleep stage papers.

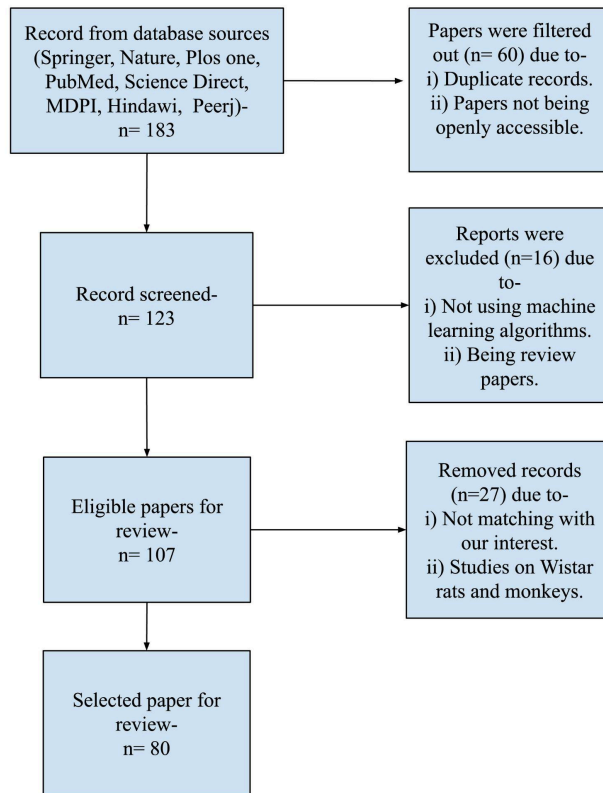

Figure 2. PRISMA diagram shows how the papers are selected for review.

3. Necessity of Artificial Intelligence in Sleep Studies

Since many people are facing sleep-related disorders, it has become evident that a robust system for diagnosing and treating such disorders is needed. The first step is to identify the sleep patterns of individuals, and then further investigation is done to diagnose any sleep disorders. Therefore, polysomnography (PSG) data is collected over the night, and the sleep stages are classified manually by a physician to determine the sleep patterns. However, this process is labor-intensive, requires tremendous time to prepare the report, and has a high operational cost. Moreover, this process is also prone to human-made errors in correctly classifying sleep stages. The introduction of artificial intelligence in sleep studies brings positive changes in the speed of data analysis, enabling researchers and healthcare professionals to gain deeper insights into sleep patterns and disorders. AI has facilitated and automated this sorting by feeding the signals or after pre-processing signals into the artificial intelligence models, which replace the laborious manual comparison process to identify the sleep stages accurately. Thus, valuable time and resources are saved, and healthcare facilities can operate and allocate resources more efficiently. More outstanding computational advances with sophisticated algorithms make diagnosing and screening disorders more efficient. For instance, analyzing the sleep stages, narcolepsy [21], and prediction or estimation of obstructive sleep apnea (OSA) [22] have been seeing promising results. Moreover, timely assessments of sleep-related issues can be done by replacing intensive

manual labor and repetitive tasks. This benefits healthcare providers by streamlining their workflow, saving patients money, and ensuring quality treatment on time.

4. Artificial Intelligence Models

While reviewing the papers, we found 34 distinct artificial intelligence models. Among them, we have described the structure and features of five frequently used models, as well as the advantages and disadvantages of these models.

4.1. CNN

CNN is an artificial neural network commonly used worldwide for pattern or image recognition. It consists of two main sections: feature extraction and classification. In the feature extraction section, input, convolution, and pooling occur. In the classification section, there is the fully connected layer and also the output layer. In the input layer, all the raw data is fed. The convolutional layer uses convolutional operations to detect edges and textures. The pooling layer down samples the feature maps to reduce spatial dimensions. In the fully connected layer, all the neurons from the layers (previous and subsequent layers) are connected to each other. Then, the output layer produces the final output, as shown in Figure 3 [23].

4.1.1. Advantages of CNN

CNN is widely known for its efficient recognition algorithm. The CNN architecture is straightforward and needs fewer training parameters. This model's noise sensitivity is reduced because of its pooling layers and feature learning. This feature of learning helps it learn simple patterns to complex structures automatically. It uses a parameter-sharing feature to reduce the number of parameters for efficiency. CNN can parallelize its operations to take advantage of modern GPU architectures and speed up the process.

4.1.2. Disadvantages of CNN

The CNN model needs significant labeled data points for efficient training. With sufficient data, it may recognize new or unseen examples. It needs very high computational power as it uses several layers and parameters. Another drawback of the model is that it needs a fixed-size input, making it less flexible. Another issue could be if the training data becomes biased for any reason, CNN will start learning that biased information, and the model will provide biased output while applied in modern world applications.

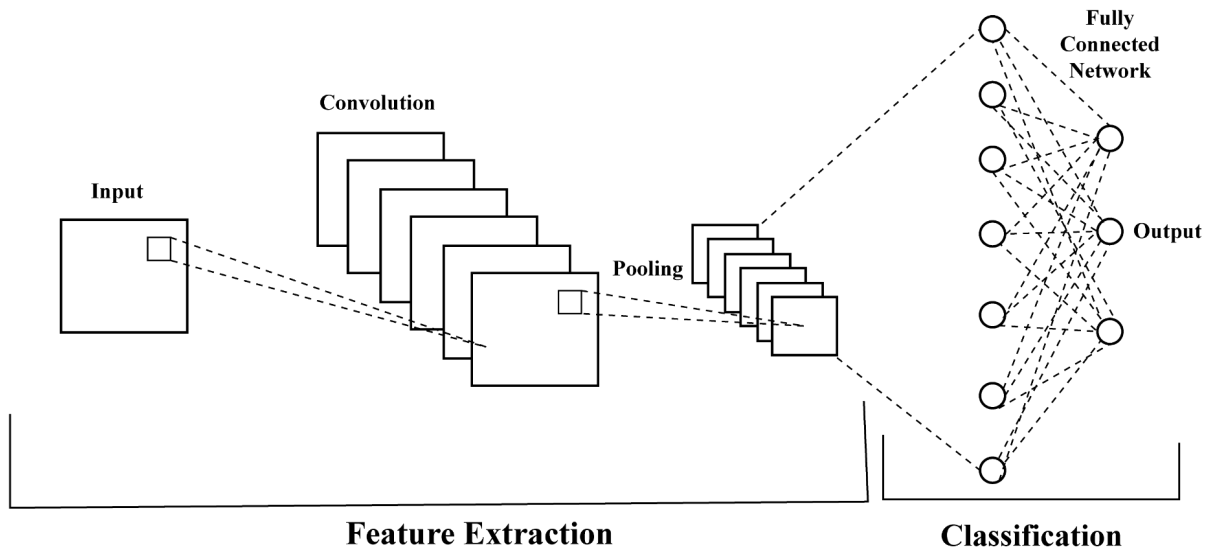

Figure 3. Convolutional Neural Network block diagram.

4.2 RNN

RNN is a neural network used for processing sequential data. The RNN models use the supervised learning concept. They contain feedback connections used to store information from the earlier stages [24]. This feature makes them more convenient for tasks requiring temporal dependencies or context, such as time series analysis, speech recognition, and natural language processing. The RNN unfolding architecture is presented in Figure 4.

4.2.1 Advantages of RNN

The main advantage of the model is that it can take and process inputs of any size. Moreover, the information-retaining feature of this model is very convenient when used for any time series prediction. Another advantage is that the input size does not increase the model size. RNN also has a parameter-sharing feature. It can share the weights across the time steps.

4.2.2. Disadvantages of RNN

RNNs sometimes can suffer from gradient vanishing or exploding problems during training while processing long sequences. This drawback can hamper long-term dependency learning. Training RNNs is also challenging, and RNN is computationally costly. The sequential nature of the model slows down the training process. As the model retains past information, it needs much storage. Moreover, RNNs are more sensitive than other neural networks in the case of hyperparameter choices. These models are also less suitable for irregular time intervals.

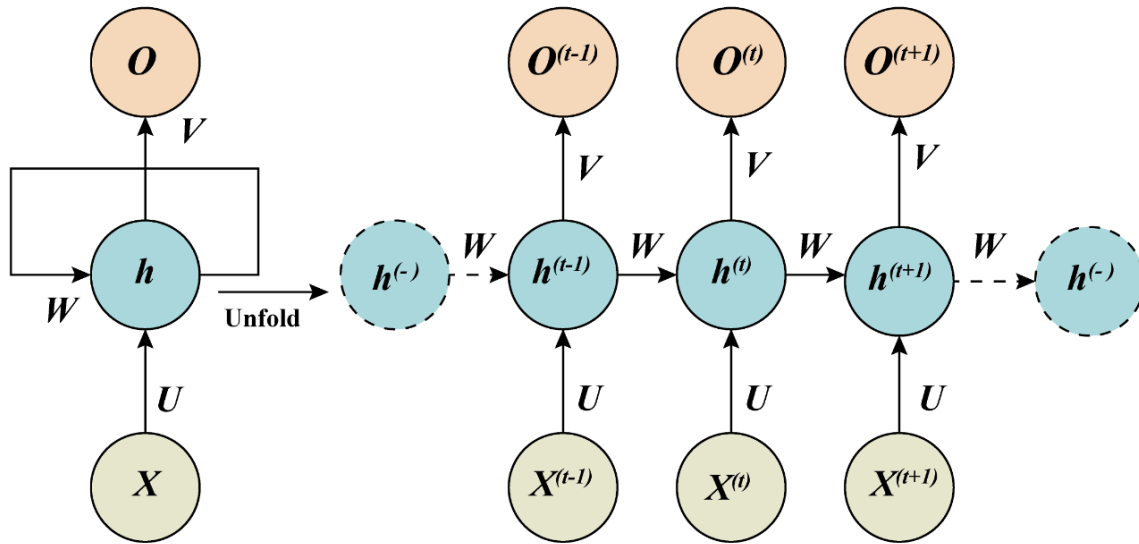

Fig. 4. Recurrent Neural Network block diagram.

4.3 Support Vector Machine (SVM)

Support Vector Machine (SVM) algorithms are used to perform classification and regression tasks. These algorithms are used when clear margins among different classes are crucial. As shown in Figure 5, the SVM determines a hyperplane that determines the best fit between the classes. The vectors of particular classes generate hyperplanes. This is the reason the model is called support vectors. The goal of this model is to maximize the optimal hyperplane and ensures a reliable prediction [25].

4.3.1 Advantages of SVM

The SVM can perform both classification and regression. It uses kernel functions to manage both linear and nonlinear decision boundaries. This feature makes the model versatile. The model can also perform efficiently with numerous features, making it practical for high-dimensional datasets. Moreover, it is durable enough to overfit when the feature number exceeds the sample. This feature makes it suitable for small datasets. Besides, SVM provides high-quality results.

4.3.2 Disadvantages of SVM

SVM also has some disadvantages. SVM is very sensitive to noise. Moreover, SVM is computationally intensive while training, making it less efficient for large datasets. Besides, the model is comparatively slower for nonlinear data than other models. SVMs can also be memory intensive while dealing with large datasets, which limits their scalability and increases runtime.

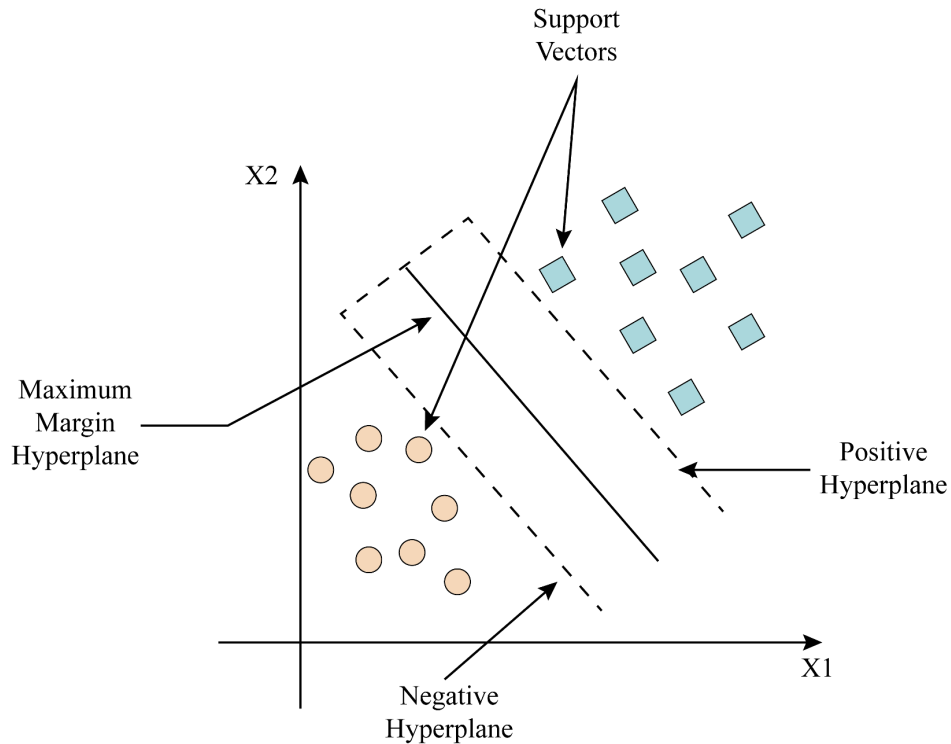

Figure 5. Support Vector Machine block diagram.

4.4 LSTM

Long Short-Term Memory (LSTM) is a form of recurrent neural network (RNN) architecture mainly designed to beat the issues of learning long-term dependencies in sequential data. The LSTM can retain information longer than the RNN using its memory cell. The memory block of this model is small but can retain memory for a longer time. The model uses three gates for controlling the memory block: the forget gate, input gate, and output gate as shown in Figure 6. The forget gate decides which information will be stored and processed further. If any information is not required, then it is not sent to the input gate. Only the needed information is sent to the input gate. The information is introduced and combined with the cell state in the input gate. Besides, in the output gate, the data from the input gate is multiplied by the cell's \tanh generated vector to get the output [26].

4.4.1 Advantages of LSTM

LSTM can retain the information for a longer time. The forget gate of the model can filter out unnecessary data. The model can be parallelized more efficiently than the regular RNNs. Moreover, LSTM can predict considerably faster and with higher accuracy because of the long-time information retention feature.

4.4.2 Disadvantages of LSTM

LSTM can be computationally intensive compared to simple feedforward neural networks. Gradually, the model turns to get overfitted for a more notable amount of data. It also has weight initialization problems. Moreover, it involves several hyperparameters; therefore, proper tuning is necessary, and finding the perfect configuration may be difficult.

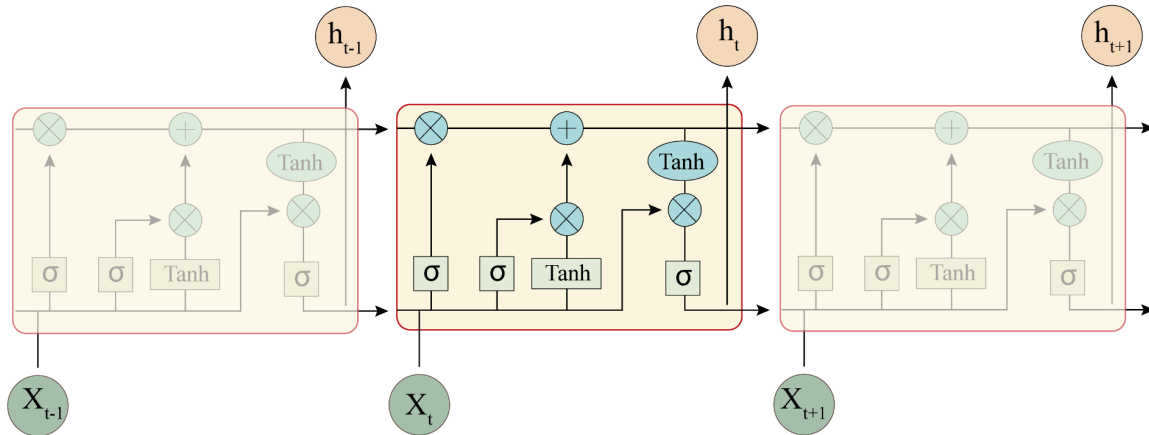

Figure 6. Long-Short Term Memory block diagram.

4.5 Random Forest

Random forest is a widely used machine learning algorithm for classification, regression, and other tasks. The model provides a single result by combining the output from multiple decision trees, as illustrated in Figure 7. The model is like a tree, where multiple trees spread from a single node. The trees also have multiple child nodes. More nodes spread from the previous child nodes, and the cycle continues several times. Therefore, it generates multiple results and combines them to get a single result [27].

4.5.1 Advantages of RF

Random Forest is known for its accuracy, robustness, and ability to handle diverse tasks. The model provides high accuracy using the ensemble of its diverse decision trees. Moreover, the ensemble model helps to create strong models that are less likely to be overfitting. The model is created in such a way that it can handle missing data from the dataset without any imputation.

4.5.2 Disadvantages of RF

The main disadvantage of this model is that it can be very complex and difficult to interpret compared to the individual decision trees. Computational intensity is also a disadvantage of the model. Moreover, more extrapolation is needed with this model. It may only extrapolate within the limited range of training data, limiting the performance on unseen data.

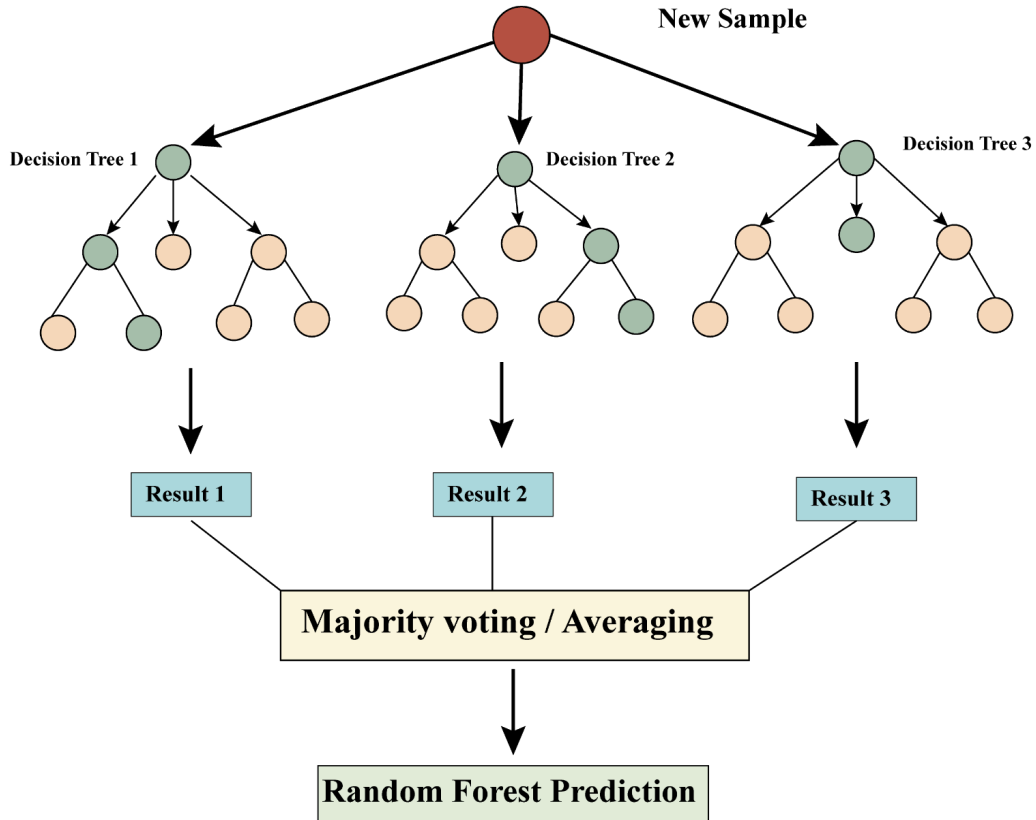

Figure 7. Random Forest block diagram.

5. Results and Discussions

In this section, our extracted findings have been organized into 5 subsections, representing the sample data size, measured body parameters, performance metrics, and AI models for sleep staging and sleep disorder detection. In summary, we answer the research questions to find out the reliable data sources and the size of datasets for sleep studies, the most utilized body parameters for sleep studies, the most widely used AI models, and the popular types of metrics to evaluate the AI models.

5.1 Sample Data Size

The performance of the executed model is explicitly dependent on the datasets and number of samples used to train the AI models. Based on most of the training data and its extracted features, the classification of sleep stages and estimation of disorders can be made with a higher degree of accuracy.

Table 2: Sample size and different datasets used in sleep stage classification.

Reference	Dataset used	Sample size
[28]	Sleep-EDFX	77 subjects
[29]	Sleep-EDF	42, 308 epochs
[30]	Sleep-EDFX, Sleep Heart Health Study (SHHS), and Haaglanden Medisch Centrum Sleep-Staging Database	6, 441 subjects (SHHS), 348 whole night recordings (Sleep-EDFX, HMCS)
[31]	Sleep-EDF and MIT-BIH polysomnographic databases	98 subjects
[32]	SleepEDF and MASS-SS3	82 subjects
[33]	The Nationwide Children's Hospital (NCH)	3984 subjects
[34]	Sleep-EDF	20 subjects
[3]	Physionet repository	153 EEG recordings
[35]	Soonchunhyang University Bucheon Hospital	602 subjects
[36]	Sleep-EDFX-8, Sleep-EDFX-20, Sleep-EDFX-78, and SHHS	435 subjects
[37]	Primary data	112 subjects
[38]	SHHS	2274 subjects
[39]	Sleep-EDFX, and University College Dublin Sleep Apnea Database (UCDDB)	45 subjects
[40]	University of British Columbia Hospital	12 subjects
[41]	DREAMS database from the University of MONS-TCTS Laboratory and Université Libre de Bruxelles - CHU de Charleroi Sleep Laboratory	20 subjects
[42]	Sleep-EDF, and Sleep-EDFX	14, 2700 samples
[43]	SHHS	1000 registers
[44]	Primary data	184 subjects
[45]	Sleep-EDFX	20 subjects
[46]	SHHS, clinical sleep laboratories at the Charité Hospital Berlin (CHB)	N/A
[12]	Sleep-EDF (2013)	30 subjects
[47]	Sleep-EDF (2013 & 2018)	98 subjects
[48]	Sleep-EDF, CinC2018 datasets	697 subjects
[15]	Primary data	106 subjects
[49]	Physionet CAP Sleep Database. 2012	108 subjects
[13]	MESA sleep study	43 subjects
[9]	Sleep-EDF (2013 & 2018)	258 PSG recordings
[50]	HMC, SHHS,UCD Apnea Database, Telemetry, DREAMS, ISRUC	443 PSG recordings
[51]	MESA, MrOS, and Apple watch datasets	1456 subjects
[36]	Sleep-EDF, UCD, and SHHS	45 (Sleep- EDF & UCD), 5445 records (SHHS)

[52]	Sleep-EDFX, St. Vincent University Hospital, and UCD	125 subjects
[53]	Primary data	28 subjects
[54]	NSRR by WSC, CAP, sleep EDF, ISRUC, MIT-BIH, and St. Vincent University Hospital sleep database	2, 431 subjects
[55]	A laboratory hospital	2, 889 subjects
[56]	Nocturnal sleep sound dataset	700 audio signals and 140 recordings
[57]	Primary data	111 subjects
[58]	SHHS, WSC, MESA, MNC, NCHSDB, SNUH and CCC databases	11,555 recordings for training and validation
[59]	SIESTA, Somnolyzer, SOMNIA, and HealthBed databases	1,171 subjects
[60]	Cleveland Clinic Sleep Registry	72 subjects
[61]	Sleep-EDFX	153 subjects
[62]	Sleep-EDF, Sleep-EDFX, and DREAMS databases	24 subjects (Sleep EDF), 20 nights of PSG recordings (DREAMS Subject databases)
[10]	SIESTA, and Eindhoven datasets	352 subjects
[63]	SHHS, MESA, and CinC database	993 subjects
[64]	SIESTA database	292 subjects
[11]	One night sleep recordings from 3 studies	158 participants (training and testing)
[14]	21 survey datasets	15,660 subjects
[65]	Sleep-EDF dataset	N/A
[66]	Sleep-EDFx, ISRUC-Sleep	178 subjects

The databases that were enlisted in Table 2 for classifying the sleep staging problem were mostly taken from the Physionet Sleep-EDF repositories, and a few were from primary collected datasets. In some studies, researchers have fused up to 7 [58] different datasets for diversity. The enrolled human subjects were considered for the sample size, but if no subjects were mentioned, then the PSG or other recorded signals or sample numbers were mentioned as the sample size. The range of subjects even spans from a few to several thousand. For instance, Casciola et al [40]. analyzed data from only 12 hospital-enrolled subjects, and Perslev et al [14]. included 15,660 subjects in their study from 21 datasets. For inclusion, in most of the papers with different datasets and different samples, the summation of the subjects or any other tracks (e.g., audio signals, epochs, and samples) was considered. The number of datasets collected from hospitals or universities, including University College Dublin and St. Vincent University Hospitals, is notable.

Table 3: Sample size and different datasets used in sleep disorder detection.

Reference	Dataset used	Sample size
[67]	Sleep-EDF	197 PSG recordings
[17]	CAP sleep and TURIN database	56 subjects
[68]	CAP sleep database	77 subjects

[69]	Lab-PSG dataset	1, 579 subjects
[18]	Stanford Technical Analysis and Sleep Genome Study (STAGES)	80 subjects
[70]	PhysioNet Apnea-ECG dataset	70 PSG recordings
[71]	Enrolled HSAT patients	14 subjects
[72]	Enrolled hospital patients	3, 972 data samples
[73]	Primary data	40 subjects
[74]	Taiwan National Health Insurance Research Database (NHIRD)	14,788 subjects
[75]	Primary data	32 subjects
[17]	CAP and TURIN databases	52 subjects
[76]	Primary data	83 subjects
[77]	CAP sleep database	30, 720 samples
[78]	National Health and Nutrition Examination Survey (NHANES 2017–2020)	4, 055 subjects
[79]	NHANES 2011–2020 survey	8, 628 subjects
[80]	Primary data	88 subjects
[16]	SHHS, UCD Sleep Apnea, and MIT-BIH Polysomnographic Database	2, 691 subjects
[81]	PhysioNet Apnea-ECG database	70 subjects
[82]	Primary data	78 subjects
[83]	UCD sleep apnea dataset	15 subjects
[84]	Primary data	653 subjects
[85]	Primary data	124 subjects
[86]	SHHS 1, WSC database	5, 243 subjects
[87]	Enrolled patients at the Northwell Health Sleep Disorders Center	50 subjects
[88]	Enrolled patients at the clinic of Samsung Medical Center	4, 014 subjects
[89]	Examined patients at the Samsung Medical Center	1, 241 subjects
[90]	Visited patients at the Seoul National University Hospital	98 subjects
[91]	Recruited patients at Seoul National University Hospital	40 subjects
[92]	Patients enrolled in Tianjin Chest Hospital	30 subjects
[93]	TMUH, SHH datasets	6, 399 subjects
[94]	Primary	50 subjects

Table 4: Different body parameter signals used in sleep stage classification.

Reference	Measurement of the body parameters	Percentage of use
[28, 29, 32, 33, 3, 36, 41, 45, 47, 48, 9, 95, 52, 54, 60, 61]	Brain waves	34.04%
[31, 38, 40, 43, 50, 10]	Eye movement, brain activity, heart rate, and muscle movement	12.77%
[34, 35, 39, 53, 62, 65]	Eye movement, brain activity, and muscle movement	12.77%

[38, 49, 55]	Eye movement, brain activity, heart rate, muscle activity, and respiratory flow	6.38%
[37, 63, 64]	Heart rate	6.38%
[42, 12]	Brain waves and eye movement	4.26%
[58, 59]	Heart rate and body movement	4.26%
[66]	Brain waves, eye movement, muscle activity, and respiration	2.13%
[44]	Brain wave, eye movement, heart rate, and breathing (flow)	2.13%
[40]	Eye movement, brain activity, heart rate, muscle movement, respiratory flow, pulse oximetry, audio-equipped video	2.13%
[46]	Eye movement, brain activity, heart rate, muscle movement, respiratory flow, oxygen saturation, and blood circulation volumetric change	2.13%
[15]	Temperature, heart rate, acceleration, and circadian rhythm	2.13%
[51]	Wrist accelerometry and heart rate	2.13%
[56]	Coughing, laughing, screaming, sneezing, snoring, sniffing, and farting	2.13%
[57]	Body movements, sleep bruxism, and snoring	2.13%
[13]	Body movement	2.13%

For sleep disorder detection-related research in Table 3, the included databases were many primary datasets collected along with datasets from different institutes, whereas in Table 2, there were a handful. The included subjects were expanded from a few to several thousand in number. Enrolled hospital patients in the Samsung Medical Center, Seoul National University Hospitals, and the National Health Survey are some of the institutions that collect the databases used for research. In works done by [75, 76, 80, 82, 84, 85] are based on their datasets.

5.2 Body Parameters

Each generated body part's signals are significant in analyzing the nature of any usual distinctive work control pattern. Different characteristics can be obtained based on the measured body parameters, which are further used to classify different sleep stages and predict sleep-related disorders. According to our findings, different measurement types have been enlisted in Tables 4 and 5. Brain waves/activities are the most common sources of signals, followed by the other PSG sources, along with respiratory flow. These frequently used body-generated signals exhibit meaningful potential features to be extracted. The percentage evaluation was done within each table count, and in both cases, solely brain waves held the weights of 34.04% and 21.43%, respectively. Then come the combined PSG signals for Table 4 (12.77%) and Table 5 (for sleep disorders), along with the respiratory, heart, and anthropometric biomarkers with a percentage of 10.71%.

Table 5: Different body parameter signals used in sleep disorder detection.

Reference	Measurement of the body parameters	Percentage of Use
[67, 68, 77, 80, 16, 92]	Brain waves	21.43%
[18, 70, 81]	Heart rate	10.71%
[71, 84, 87]	Respiratory flow/level	10.71%
[75, 17, 88]	Brain wave, heart rate, muscle movement, and eye movement	10.71%
[78, 79, 93]	Anthropometric biomarkers	10.71%
[69, 85]	Nasal flow, oxygen saturation, and brain wave	7.14%
[17]	Muscle activity, eye movement, and heart rate	3.57%
[72]	Nasal pressure, oxygen desaturation level, brain wave, and heart rate	3.57%
[73]	Diffusion tensor imaging	3.57%
[76]	Heart rate and blood flow volumetric change	3.57%
[82]	SpO2 and Changing heart rate	3.57%
[83]	Airflow, SpO2, and Rib movements	3.57%
[90]	Cortical activities	3.57%
[94]	Snore, oxygen saturation, arousal level, and other body signals	3.57%

5.3 Type of Metrics

Whether the built ML model is suitable to solve the particular problem is a concern, and performance metrics are initiated to visualize it. Performance metrics are generally used for cases associated with classification problems in ML algorithms, and for prediction or regression, error metrics are widely used. Even for different classification types, the metrics differ. Accuracy was used most frequently among the different metrics, as shown in Figure 8. In 83.75% of papers, accuracy was included with multiple overlapping evaluation metrics. It signifies the result when the targeted objects are well-defined and balanced, but accuracy isn't optimal if the distribution purporting is unevenly balanced. For the most straightforward working principle for sleep studies, it's been implemented the most. The accuracy can be denoted as

$$Accuracy = \frac{T_p + T_N}{T_p + T_N + F_p + F_N}$$

Here, T_p , T_N , F_p , and F_N denote the true positive, true negative, false positive, and false negative, respectively. For accuracy, the true negative values are also incorporated. For example, if there are any missing sleep stage categorization values, they are also included. This is being updated in calculating precision.

$$Precision = \frac{T_p}{T_p + F_p}$$

But, for the sake of simplicity, most of the metrics with accuracy were extracted, and a few with precision performance were included. Cohen's Kappa is another index that considers the random probable chances, leading to less inaccuracy. Its structural equation is-

$$Kappa = \frac{real\ accuracy - expected\ accuracy}{1 - expected\ accuracy}$$

Kappa, which is used in 36.25% of papers, along with the other metrics. It's the third most widely used metric in this review. The recall or sensitivity is similar to the precision, but the actual positive values are tried to be measured by mistakenly identified negative wrong values, which can be expressed as

$$Sensitivity = \frac{T_P}{T_P + F_N}$$

Specificity is also a commonly used metric like sensitivity, which is evaluated based on a true negative.

$$Specificity = \frac{T_N}{T_N + F_N}$$

Based on the recall and precision values, the evaluation metrics F1 are being obtained (when both of these parameters are important to evaluate, it adds more significance). Our findings show that the F1 score is the second most frequently used performance metric, at 19.6%. The formula which calculates-

$$F1\ Score = 2 * \frac{Precision * Recall}{Precision + Recall}$$

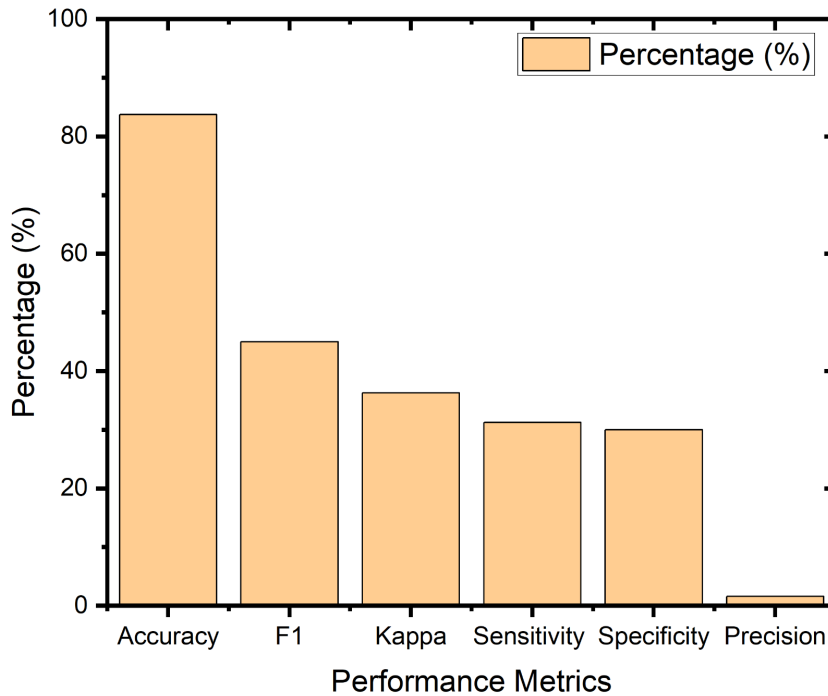

Figure 8. Different types of performance metrics.

5.4 AI Models for Sleep Stage Classification and Sleep Disorder Detection

Table 6 and Table 7 exhibit the individual paper's proposed AI models and the degree of the best-performing model with performance metrics and its evaluation methods. Among the 80 papers, 48 have been enlisted as sleep-scoring related, and the remaining 32 articles have been segmented into sleep disorder-oriented works. In our study, 15 different AI parent algorithms were found. Within the parent AI methods, we had 34 unique subcategories of AI models. These different approaches reflect the diversified interest in this field of research. Figure 9 shows a clear idea about the parents and their corresponding children or the hybrid models used in different studies. Neural networks have maximum modified child models. This study also found that CNN, RNN, AE, ResNet, TCN, DNN, MRCNN, PPG-NN, BNN, Sle-CNN, and Fuzy-NN are used as the children of neural networks. Ensemble Learning (EL) includes BO-ERTC, EBT, EBoot, LightGBM, XGBoost, CATBoost, Bagging. Support Vector Machine (SVM) includes CSVM, SVM-RBF, and SVM, which are used independently. GRU includes BiGRU and GRU independently. LSTM includes LSTM's main architecture and the hybrid of it named BiLSTM. DT, Fuzy Network, HAC HHM, K-means, KNN, LASSO, NB, and RF architectures are the main ones, as well as child architectures.

Table 6: Sleep stage classification-related articles along with AI models.

Reference	Proposed AI models	Best fitted model	Evaluation methods	Performance metrics
[28]	ANN+CNN	ANN+CNN	Skilled medical technicians	Accuracy 96%, F1 96.49% (wake)
[29]	NAMRTNet with TCN	ResNet +TCN	20-fold CV	Accuracy 86.2%, F1 score 79.8%, Kappa 0.808
[30]	BiRNN + GRU	BiRNN + GRU	30-fold CV	Accuracy 87.3%, F1 82.50%,
[31]	Bi-LSTM + CNN	BiLSTM + CNN	10-fold CV	Accuracy 90.83% (Avg), F1 87.05% (Avg), Kappa 0.85
[32]	Siamese CNN, Siamese AE	Siamese CNN, Siamese AE	10-fold CV	Accuracy 86.2%, F1 80.2%, Kappa 0.8
[33]	CNN+BiLSTM	CNN + BiLSTM	77% training and 33% testing	F1 90%
[34]	T-MCCFNN	T-MCCFNN	70% training and 30% testing	Accuracy 85.3%, Precision 87.3%, F1 85.3%
[3]	ADNN	ADNN	10-fold CV	Accuracy 98.75
[35]	CNN+RNN	CNN + RNN	482 datasets for training, 48 for validation, and 72 for testing	Kappa 0.84
[36]	CNN+Bi-LSTM	CNN + BiLSTM	20-fold, and LOSO CV	Accuracy 87.28%, F1 54.97%, Kappa 0.82 (Avg)
[37]	CNN+GRU	CNN + GRU	89 subjects for training and 23 subjects for testing	Accuracy 86.4%
[38]	CNN	CNN	70% training, and 30% for test and validation	Accuracy 91.45%, F1 89%, Kappa 0.84
[39]	CNN	CNN	1 subject for testing and 1 subject for validating	Accuracy 82.6%, F1 80%, Kappa 0.77 (Avg)
[40]	CNN + LSTM	CNN + LSTM	Leave-one-out CV	Accuracy 75.5% (Avg)
[41]	ResNet	ResNet	4-fold CV	Accuracy 87.8%
[42]	CNN	CNN	70% for training and 30% for test and validation	Accuracy 98.06%, F1 97%, Sensitivity 98% (Highest)
[43]	CNN	CNN	3 different datasets for training, testing, and validation	Precision 78%, F1 76%, Sensitivity 75%, Kappa 0.83
[44]	BNN, K-NN, DT	BNN	Leave-one-out and 10-fold CV	Accuracy 89.15% (Avg)
[45]	SVM, DT, NN, KNN, NB, LDA	DT	N/A	Accuracy 93.13%, Sensitivity 89.06%, Specificity 98.61%
[46]	TCN	TCN	N/A	Accuracy 73.8%, Kappa 0.59
[12]	RF, KNN, SVM, CNN+LSTM	CNN + LSTM	80% for training and 20% for validation	Accuracy 87.4%, F1 44/6%, Specificity 87% (Avg)

[47]	MLTCN_TCN, MLTCN_LSTM	MLTCN_TCN	Leave-One-Subject- Out and 20-fold CV	Accuracy 82.6%, Kappa 0.76 (Avg)
[48]	MRCNN	MRCNN	5-fold CV, Independent subject CV	Accuracy 92.6%, Kappa 0.736 (5-fold CV)
[15]	Light GBM	LightGBM	5-fold CV.	Accuracy 96%, F1 78%, Sensitivity 80.74%, Specificity 98.15% (full model- wake)
[49]	CSVM with L-tetrolet-based pattern	CSVM with L-tetrolet-based pattern	10-fold CV	Accuracy 92.93%, F1 92.57%, Sensitivity 87.84%, Specitivity 98.02% (Avg)
[13]	HMM	HMM	N/A	Accuracy 85.7%, Sensitivity 99.30%, Specificity 36.4%, Kappa 0.446
[9]	RNN+CNN	RNN + CNN	K-fold CV (20 & 10)	Accuracy 84.26%, F1 79.66%, Kappa 0.79
[50]	CNN+LSTM	CNN + LSTM	80% for training, 20% for validation	Kappa 0.675 (Avg)
[51]	CNN+LSTM	CNN + LSTM	75% for training, 12.5% for validation, and 12.5% for independent subset and 5-fold CV	Accuracy 79%, F1 80%, Sensitivity 77%, Specificity 89%.
[95]	MAResnet-BiGRU, Resnet-BiGRU, CNN-BiGRU, MAResnet, CNN-GRU, and ResNet	MAResnet-BiGRU	10-fold CV	Accuracy 81.73% (Avg), Kappa 0.789.
[52]	GRU (RNN)	GRU (RNN)	10-fold CV (Sleep-EDFx) 5-fold CV (UCD)	AUROC 93.95% Kappa 0.7095 (Avg- Sleep-EDFx, UCD)
[53]	RF	RF	70% for training, 20% for validation, and 10% for test	Accuracy 93.9%, F1 82.8%, Kappa 0.745.
[54]	SVM, EBT, DT, KNN, and NB	EBT	10-fold CV	Accuracy 81.5%, Sensitivity 81.3%, Specificity 95.3%, Kappa 0.702 (CT-12).
[55]	Sle-CNN	Sle-CNN	83% for training and 17% validation	Accuracy 89.6%
[56]	ANN, Support Vector Classifier, KNN, NB, and CNN	ANN	5-fold CV	Accuracy 97.4%, F1 97%
[57]	VDANN +LSTM	VDANN+LSTM	5-fold CV	Precision 84.8%, F1 83%.
[58]	DNN+LSTM	DNN+BiLSTM	80% for training and 20% for validation	Accuracy 78.8%, Kappa 0.64 (Avg- CCC, SNUH).
[59]	PPG-NN	PPG-NN	1113 recordings for training and 394 recordings for validation	Accuracy 77.8%, Kappa 0.638

[60]	K-NN	K-NN	5-fold CV	Accuracy 80.2%, Specificity 85.3%
[61]	CNN, Bi LSTM, and EDA with a multi-head attention mechanism	CNN+multi-head attention+ BiLSTM	10-fold CV	Accuracy 90.79%, F1 86.73%, Kappa 0.87
[62]	RF, K-NN, Bagging, and AdaBoost	Bootstrap aggregating (bagging)	70% for the training and 30% for test	Sensitivity 99.29% (AWA) 45.85% (S1) 85.8% (REM)
[10]	LSTM	LSTM	4-fold CV	Accuracy 76.36%, F1 81 (REM), Sensitivity 83.69% (REM), Kappa 0.65.
[63]	CNN	CNN	N/A	Accuracy 76.33%, Kappa 0.63 (Avg)
[64]	LSTM	LSTM	4-fold CV	Accuracy 77%, Kappa 0.61
[11]	RF	RF	5-fold CV	Accuracy 93.31%, Kappa 0.85 (Nonwear, test)
[14]	CNN+RF	CNN+RF	Leave-one-out CV	F1 79% (Overall)
[65]	NCA, SVM, ANN	ANN	70% for training, 30% for test and validation	Accuracy 90.33% Sensitivity 90.57% Specificity 97.58%
[66]	ResNet+LSTM	ResNet+LSTM	N/A	Accuracy 84.18% F1 80.95% (Avg)

Table 7: Sleep disorder detection-related articles along with AI models.

Reference	Proposed AI models	Best fitted model	Evaluation methods	Performance metrics
[67]	BiRNN	BiRNN	15-fold CV	Accuracy 70-85%, F1 80%, Specificity 95%
[17]	K-NN, SVM	K-NN	5-fold CV	Accuracy 86.96%, Sensitivity 93%, Specificity 75%.
[68]	EBT, EBooT, SVM, KNN	EBT, EBoot	10-fold CV	Accuracy 98.25% (Avg)
[69]	LR, K-NN, NB, RF, and SVM	RF	10-fold CV	Accuracy 80.06%, F1 80.41%, AUC 93.61%
[18]	BO-ERTC and SVM	BO-ERTC	10-fold CV	Accuracy 86.32%, F1 86%, AUC 94.8%, Sensitivity 85.85%, Specificity 86.49%
[70]	CNN+LSTM	CNN+LSTM	35 PSG recordings for training and 35 recordings for test	Accuracy 96.1%, Sensitivity 96.1%, Specificity 96.2%, Kappa 0.92
[71]	LSTM	LSTM	Leave-One-Subject-Out (LOSO) cross-validation	Kappa 0.81 (Perfect agreement)
[72]	CNN, LDA, SVM, BRT, and ANN	CNN	Training data 20% and test data 80%	Accuracy 90.43%, F1 90.98%, Sensitivity 93.21%, Specificity 90.37% (Avg)
[73]	SVM	SVM	Training on 32	Accuracy 87.5%, AUC

			subjects and testing on 8 subjects	90%, Sensitivity 80%, Specificity 100%
[74]	KNN, SVM, RF, RNN, LSTM, GRU, and CNN	CNN	Two image datasets validation	Accuracy 92.3%, F1 91.3%, AUC 93.4%, Sensitivity 89.3%, Specificity 96.6%
[75]	LR, RF, and XGBoost	RF	Leave-One-Out Cross-Validation (LOO-CV)	Accuracy 94%, AUC 95%, Sensitivity 95%, Specificity 92%
[17]	K-NN, SVM	K-NN	5-fold CV	Accuracy 87%, Sensitivity 93.33%, Specificity 75%
[76]	Ensemble learner, Kernel classifier, KNN, SVM, NB, NN, and DT	Ensemble learner, kernel classifier, and KNN	N/A	Accuracy 84%, AUC 84% (Avg)
[77]	Adaboost, RF, KNN, and SVM-RBF	SVM-RBF	70% of features for training 30% for testing	Accuracy 93.5%, F 66.9%
[78]	XGBoost, RF, ADABOOST, and ANN	XGBoost	10-fold CV	AUROC 87%, Sensitivity 77%, Specificity 77%
[79]	ANN, RF, AdaBoost, SGB, XGBoost, and SVM	SVM	10-fold CV	Accuracy 77.1%, F1 86%, Sensitivity 77.4%
[80]	Genetic algorithm and SVM	SVM	77% for training and 33% for test	AUC 90%
[16]	CNN	CNN	10-fold CV	Accuracy 69.9%, Kappa 0.7 (SHHS)
[81]	CNN	CNN	10-fold CV	Accuracy 92.4%, F1 90.6%, Specificity 92.6%
[82]	NN	NN	Internally validated by 1000 bootstrapping samples	Accuracy 91%, AUROC 96.1%, Sensitivity 71.4%, Specificity 95.3%, Kapap 0.687.
[83]	Fuzzy network	Fuzzy network	N/A	Accuracy 97.5% (detecting apnea) 95.2% (detecting hypopnea)
[84]	CATBOOST, LIGHTGBM, RBF SVM, ET, LR	CATBOOST	10-fold CV	Accuracy 71%, F1 73%, AUC 76%, Sensitivity 75%, Specificity 66%
[85]	SVM, RF, and LR	SVM, RF, LR	Leave one subject out (LOSO) CV	Accuracy 80% AUROC 94%
[86]	LR, SVC, K-NN, DT, ET, Adaboost, GNB, and RF	LR	10-fold CV	AUROC 77%, Sensitivity 73%, Specificity 70% (Avg)
[87]	CNN	CNN	Leave one subject out (LOSO) CV	Accuracy 84%
[88]	RF, XGBoost, LightGBM, CatBoost, K-means, Bisecting K-means algorithm, and GMM	HAC, CATBOOST, GMM, LightGBM, and K-means	5-fold CV	Accuracy 87.52% (CatBoost, low OSAS) Accuracy 86.01% (LightGBM, moderate OSAS) Accuracy 91.11% (LightGBM, severe OSAS)
[89]	DT, SVM, ET, Gradient Boost, K-NN, RF, and	CNN + Attention model	80% for training and 20% for test	Accuracy 93%, F1 93%

	CNN+			
[90]	CNN	CNN	80% for training and 20% for evaluation	Accuracy 99.81%, AUROC 99.41% (3D-CNN)
[91]	LASSO, PCA, and SVM	SVM	Leave-one-out CV	Accuracy 80%, F1 79%, Specificity 81%
[92]	RF, K-NN, SVM	RF	10-fold CV	Accuracy 86%, F1 87%, Kappa 85%
[93]	SVM	SVM	Validated on the SHH dataset	Accuracy 81%, AUC 83.08%, Sensitivity 76.08%, Specificity 76.55% (Avg)
[94]	DNN+RNN+GRU+LSTM	DNN+RNN+GRU+LSTM	N/A	Accuracy 95.76% F1 95.68%

Figure 10 shows that the NN has the largest contribution, which is 46% of the total papers. The second largest contribution is from LSTM, which is 15% of the collected data. There are two third most popular algorithms, SVM and EL (Ensemble Learning), and they both consist of 9% of the parent algorithm of our collected data. RF, GRU, KNN, DT, HMM, and the rest of them have sequentially 6%, 5%, 2%, 2%, and 1% share. The neural network has a variety of modified versions for different purposes. It is more popular and has a rich community as it can learn more complex patterns from data. Among these, SVM classifies finding the hyperplanes in the n-dimensional space based on the number of features. The incorporated kernel classifier can boost the required task performance of the SVM. SVM is used to extract non-linear information from the buffered EEG signals with higher accuracy [96]. On the other hand, ensemble learning is a multiclassifier, combining many learners. A modified rotational SVM can extract even more complex features, which are rooted in the principle of ensemble learning [97]. For different applications, convolutional layers and kernels like RBF can be fused into SVM, building CSVM and SVM-RBF, depicted in Figure 10. Different Parent and child architecture have their unique features. The features of the studied AI models are further explained in Table 8.

Table 8: Different child parameter's features and acronyms.

AI models	Full form	Main features
CNN	Convolutional Neural Network	Uses convolution as a form of shift-invariant feature extraction and learns through training to extract important features from time series data that are useful for classification [16].
RNN	Recurrent Neural Network	Can use previous input data in the network layer [9].
AE	Autoencoder	The autoencoder uses convolutional layers in the encoder and transposed convolutional layers in the decoder, where the encoder generates a latent representation (EN_L) of the input EEG. The decoder reconstructs the input EEG with DE_L as the output [32].
ResNet	Residual Network	Each layer is fed to the next layer. Also, it feeds to some layers that are a few hops away, helping the propagation of larger gradients to the initial layer through backpropagation and training deeper networks [41].
TCN	Temporal Convolutional Network	Can learn the dependencies between features of long-time series data [29].
DNN	Deep Neural Network	Has a deep architecture that allows deep features to be learned by having more hidden layers [94].
MRCNN	Multiscale Residual Convolutional Neural Network	Multiple residual blocks are incorporated with the CNN to extract features from various domains [48].
PPG-NN	Photoplethysmographic Neural Network	A developed classifier that uses the IHR and activity counts for input and CNN for feature extraction [59].
BNN	Bayesian Neural Network	A neural network with an output layer made of Bayes theorems for prediction [44].
Sle-CNN	Sle-CNN	It is a CNN-based architecture fused with Kernel filters in each step [55].
Fuzzy-NN	Fuzzy Neural Network	A fuzzy network with a convolutional kernel with an increased convergence training speed [34].
LSTM	Long Short-Term Memory	LSTM is a form of recurrent neural network (RNN) architecture mainly designed to beat the issues of learning long-term dependencies in sequential data [98].
BiLSTM	Bidirectional Long Short-Term Memory	Two layers of LSTM, onesies for the feedback from the output to again merge with the previous data.
SVM	Support Vector Machine	Separates classes by finding an optimal hyperplane [76].
CSVM	Cubic Support Vector Machine	Cubic polynomial order with third-degree Kernel as a classifier algorithm [49].
SVM-RBF	Support Vector Machine-Radial Basis Function	SVM classifier with the radial bias function [77].
BO-ERTC	Bayesian optimised extremely randomized trees classifier	Decision tree-based classifier from the Gini split random datasets [18].
EBT	Ensemble Bagged Trees	Average of the randomized different decision trees with relatively low variance and improving performance [68].
EBoot	Ensemble Boosted Trees	A decision tree-based ensemble learning classifier combines weak and strong learners with higher accuracy [68].
LightGBM	Light Gradient Boosting Machine	A gradient-boosting model using fewer memory deals with missing data and efficiently extracts features [15].

XGBoost	eXtreme Gradient Boosting	Gradient boosting model with ranked covariates and features [78].
CATBoost	Categorical Boosting	Average of important and high prioritized weights for the best stratification [84].
Bagging 1	Bootstrap Aggregating	Independent learners lead to the highest performance on the mixed signals data [62].
RF	Random Forest	RF, as ensemble learning, outperforms single tree-based models [60].
GRU	Gated Recurrent Unit	GRU, a much simpler version of the LSTM, combines past and current data [94].
BiGRU	Bidirectional Gated Recurrent Unit	BiGRU consists of two GRUs for forward and backward sequence processing.
KNN	K-Nearest Neighbors	classifies each element by taking the majority vote on the class of its K closest items [17].
DT	Decision Tree	Creates hierarchy structures called nodes (leaf nodes and internal nodes) and constructs a model that can predict the label [76].
HHM	Hidden Markov Model	An unsupervised model that classifies based on the activity counts from the Markov chain [13].
NB	Naive Bayes	A probabilistic ML algorithm assumes the features are conditionally independent given the class label. Utilizes the probabilities to calculate the posterior probability of each class label given the features [76].
LASSO	Least Absolute Shrinkage and Selection Operator	Reduce the risk of overfitting. It enables the proper number of features by limiting the number of effective features via regularization [91].
K-means	K-means	Updating the model parameters around the centroid until it remains unchanged [88].
HAC	Hierarchical Agglomerative Clustering	A clustering algorithm that nested and merged the individual and similar clusters [88].
Fuzzy Network	Fuzzy Network	is a system based on the fuzzy logic theorem that deals with uncertain data [83].

5.5 Summary

The key findings of those found as per the research questions are extensively depicted in this results and discussion section. First, the number of datasets with samples from the extracted papers generalized the notion of getting the most information that impacts the AI model's performance. Most datasets are taken from the Physionet repository for the sleep stage classification and primary data, along with some institutional datasets for sleep disorder detection.

In addition, the features based on the measured body parameters are likely to have a high objective-oriented relation and justify the performance of the distinctive AI model. The frequently found cases are the brain waves/activities, with a maximum of 77% cases, along with other body parameters. Among the sleep stage and sleep disorder-related papers, it was 34.04% and 21.43%, respectively. The PSG and heart rate variability also play a crucial role in total usage frequency. Then, the rest of the body-generated signals are moderately used. The

evaluation metrics for sleep studies are enlisted in Table 6 and Table 7, where we found that accuracy was the widely used metric with the highest 83.75% along with other metrics. The F1 and Kappa are also extensively used metrics, with a share of 45% and 36.25%, respectively.

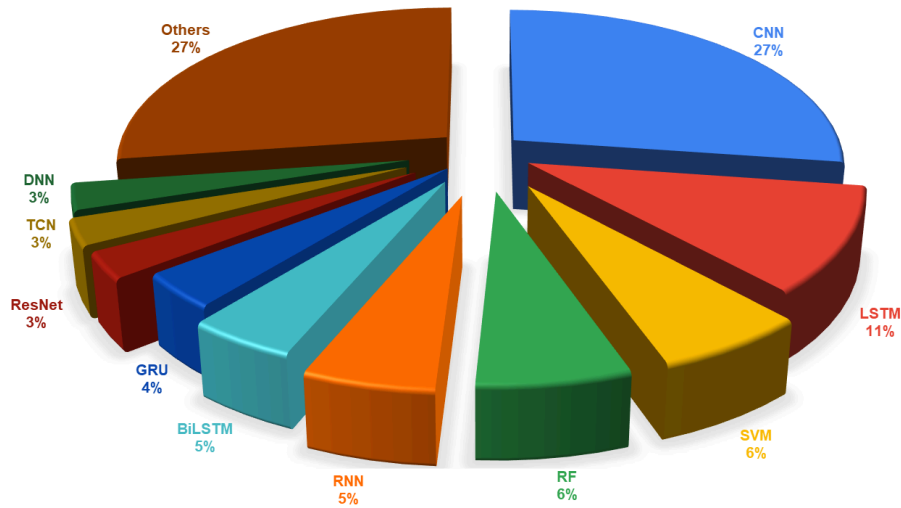

Figure 11. Top ten models.

Breaking parent nodal ML models, the top ten distinct single models are exhibited in Figure. 11. It includes only the child models used in the different research works; that's why those models have common parent and child names and a smaller portion in distinct singular representations. The top five frequently executed models are CNN, LSTM, SVM, RF, and RNN, with a share of 27%, 11%, 8%, 6%, and 5%, respectively. Since the brain's visual cortex influences CNN's working principle, it can learn from its raw, complex features. Adding multiple convolutional layers enables effective learning and categorizing features from the different signals. That's why CNN processes numerous body signals collected to determine sleep patterns with higher accuracy. There are many combinations or hybridizations with CNN, such as CNN+Bi-LSTM, CNN+GRU, CNN+LSTM, etc. As a result, it reflects that working with CNN to detect sleep stages and sleep disorders can be a good choice.

6. Future Research Directions

After analyzing an ample amount of work, it's been clear that most of the paper tends to classify the sleep stages in an automated manner. However, the focus on sleep disorder predictions from the sleep patterns was insignificant, and most of the models were trained on some common datasets. The issue of interoperability accounts for the sensitivity of the specific algorithms to specific datasets. If the datasets vary, then the models' performance also differs, and that's why the universalization of the algorithms has not yet been done, which needs to be addressed. Thus, the practicality of the proposed novel approaches is still to be investigated. Apart from these

research gaps, a more generic approach needs to be modeled in future works, leading to a complete sleep stage classification and sleep disorder detection.

7. Conclusion

This explicit review paper enlisted and investigated the AI applications in the domain of sleep adhering works. The recent trends and patterns that are replacing the traditional sleep scoring methods with continuous progress in achieving higher accuracy are tried to be incorporated by analyzing the quality research journals. Based on the four key research questions, the intended findings were approached. Among the best-fitted algorithms, the parent NN was found to be the most frequently used, with the highest share of CNN in the child model. The LSTM, SVM, RF, and RNN turned out to be sequentially significant in classifying the sleep stages and predicting sleep disorders. The brain is at the center of all control, that's why most of the features have been sorted based on the brain activity in the datasets accordingly. Amidst the model's performance metrics, accuracy was often executed, followed by F1, Kappa, sensitivity, specificity, and others. Due to the minimalist function, and generalization accuracy has been used in most cases. Despite having some constraints, like many potentially aligned papers not being openly accessible, this work aimed to foster sleep-related research by consolidating a good number of works.

Author contribution statement:

All authors listed have significantly contributed to the development and the writing of this article.

Declaration of conflict of interest:

The authors declare no conflict of interest.

Funding information:

This research received no specific grant from any funding agency.

Data availability:

Data will be made available on request.

Reference:

- [1] Okano, K., Kaczmarzyk, J. R., Dave, N., Gabrieli, J. D. E., & Grossman, J. C. (2019). Sleep quality, duration, and consistency are associated with better academic performance in college students. *Npj Science of Learning* 2019 4:1, 4(1), 1–5. <https://doi.org/10.1038/s41539-019-0055-z>
- [2] Mindell, J. A., Meltzer, L. J., Carskadon, M. A., & Chervin, R. D. (2009). Developmental aspects of sleep hygiene: findings from the 2004 National Sleep Foundation Sleep in America Poll. *Sleep Medicine*, 10(7), 771–779. <https://doi.org/10.1016/J.SLEEP.2008.07.016>
- [3] Sohaib, M., Ghaffar, A., Shin, J., Hasan, M. J., & Suleman, M. T. (2022). Automated Analysis of Sleep Study Parameters Using Signal Processing and Artificial Intelligence. *International Journal of Environmental Research and Public Health* 2022, Vol. 19, Page 13256, 19(20), 13256. <https://doi.org/10.3390/IJERPH192013256>
- [4] Shih, J. J., Krusienski, D. J., & Wolpaw, J. R. (2012). Brain-Computer Interfaces in Medicine. *Mayo Clinic Proceedings*, 87(3), 268–279. <https://doi.org/10.1016/J.MAYOCP.2011.12.008>
- [5] Pinho, A., Pombo, N., Silva, B. M. C., Bousson, K., & Garcia, N. (2019). Towards an accurate sleep apnea detection based on ECG signal: The quintessential of a wise feature selection. *Applied Soft Computing*, 83, 105568. <https://doi.org/10.1016/J.ASOC.2019.105568>
- [6] Pant, H., Dhanda, H. K., & Taran, S. (2022). Sleep apnea detection using electrocardiogram signal input to FAWT and optimize ensemble classifier. *Measurement*, 189, 110485. <https://doi.org/10.1016/J.MEASUREMENT.2021.110485>
- [7] Buongiorno, D., Cascarano, G. D., De Feudis, I., Brunetti, A., Carnimeo, L., Dimauro, G., & Bevilacqua, V. (2021). Deep learning for processing electromyographic signals: A taxonomy-based survey. *Neurocomputing*, 452, 549–565. <https://doi.org/10.1016/J.NEUCOM.2020.06.139>
- [8] Campabadal, A., Segura, B., Junque, C., & Iranzo, A. (2021). Structural and functional magnetic resonance imaging in isolated REM sleep behavior disorder: A systematic review of studies using neuroimaging software. *Sleep Medicine Reviews*, 59, 101495. <https://doi.org/10.1016/J.SMRV.2021.101495>
- [9] Mousavi, S., Afghah, F., & Rajendra Acharya, U. (2019). SleepEEGNet: Automated sleep stage scoring with sequence to sequence deep learning approach. *PLOS ONE*, 14(5), e0216456. <https://doi.org/10.1371/JOURNAL.PONE.0216456>
- [10] Radha, M., Fonseca, P., Moreau, A., Ross, M., Cerny, A., Anderer, P., Long, X., & Aarts, R. M. (2021). A deep transfer learning approach for wearable sleep stage classification with photoplethysmography. *Npj Digital Medicine* 2021 4:1, 4(1), 1–11. <https://doi.org/10.1038/s41746-021-00510-8>
- [11] Sundararajan, K., Georgievska, S., te Lindert, B. H. W., Gehrman, P. R., Ramautar, J., Mazzotti, D. R., Sabia, S., Weedon, M. N., van Someren, E. J. W., Ridder, L., Wang, J., & van Hees, V. T. (2021). Sleep classification from wrist-worn accelerometer data using random forests. *Scientific Reports* 2021 11:1, 11(1), 1–10. <https://doi.org/10.1038/s41598-020-79217-x>
- [12] Satapathy, S. K., Kondaveeti, H. K., Sreeja, S. R., Madhani, H., Rajput, N., & Swain, D. (2023). A Deep Learning Approach to Automated Sleep Stages Classification Using Multi-Modal Signals. *Procedia Computer Science*, 218, 867–876. <https://doi.org/10.1016/J.PROCS.2023.01.067>
- [13] Li, X., Zhang, Y., Jiang, F., & Zhao, H. (2020). A novel machine learning unsupervised algorithm for sleep/wake identification using actigraphy. *Chronobiology International*, 37(7), 1002–1015. <https://doi.org/10.1080/07420528.2020.1754848>

- [14] Perslev, M., Darkner, S., Kempfner, L., Nikolic, M., Jennum, P. J., & Igel, C. (2021). U-Sleep: resilient high-frequency sleep staging. *Npj Digital Medicine* 2021 4:1, 4(1), 1–12. <https://doi.org/10.1038/s41746-021-00440-5>
- [15] Altini, M., & Kinnunen, H. (2021). The Promise of Sleep: A Multi-Sensor Approach for Accurate Sleep Stage Detection Using the Oura Ring. *Sensors* 2021, Vol. 21, Page 4302, 21(13), 4302. <https://doi.org/10.3390/S21134302>
- [16] Barnes, L. D., Lee, K., Kempa-Liehr, A. W., & Hallum, L. E. (2022). Detection of sleep apnea from single-channel electroencephalogram (EEG) using an explainable convolutional neural network (CNN). *PLOS ONE*, 17(9), e0272167. <https://doi.org/10.1371/JOURNAL.PONE.0272167>
- [17] Rechichi, I., Iadarola, A., Zibetti, M., Cicolin, A., & Olmo, G. (2022). Assessing REM Sleep Behaviour Disorder: From Machine Learning Classification to the Definition of a Continuous Dissociation Index. *International Journal of Environmental Research and Public Health*, 19(1). <https://doi.org/10.3390/IJERPH19010248>
- [18] Geng, D., An, Q., Fu, Z., Wang, C., & An, H. (2023). Identification of major depression patients using machine learning models based on heart rate variability during sleep stages for pre-hospital screening. *Computers in Biology and Medicine*, 162, 107060. <https://doi.org/10.1016/J.COMPBIOMED.2023.107060>
- [19] Tyagi, P. K., & Agarwal, D. (2023). Systematic review of automated sleep apnea detection based on physiological signal data using deep learning algorithm: a meta-analysis approach. *Biomedical Engineering Letters*, 13(3), 293–312. <https://doi.org/10.1007/S13534-023-00297-5/TABLES/2>
- [20] Gaiduk, M., Serrano Alarcón, Á., Seepold, R., & Martínez Madrid, N. (2023). Current status and prospects of automatic sleep stages scoring: Review. *Biomedical Engineering Letters* 2023 13:3, 13(3), 247–272. <https://doi.org/10.1007/S13534-023-00299-3>
- [21] Stephansen, J. B., Olesen, A. N., Olsen, M., Ambati, A., Leary, E. B., Moore, H. E., Carrillo, O., Lin, L., Han, F., Yan, H., Sun, Y. L., Dauvilliers, Y., Scholz, S., Barateau, L., Hogl, B., Stefani, A., Hong, S. C., Kim, T. W., Pizza, F., ... Mignot, E. (2018). Neural network analysis of sleep stages enables efficient diagnosis of narcolepsy. *Nature Communications* 2018 9:1, 9(1), 1–15. <https://doi.org/10.1038/s41467-018-07229-3>
- [22] Papini, G. B., Fonseca, P., van Gilst, M. M., van Dijk, J. P., Pevernagie, D. A. A., Bergmans, J. W. M., Vullings, R., & Overeem, S. (2019). Estimation of the apnea-hypopnea index in a heterogeneous sleep-disordered population using optimised cardiovascular features. *Scientific Reports* 2019 9:1, 9(1), 1–16. <https://doi.org/10.1038/s41598-019-53403-y>
- [23] O’Shea, K., & Nash, R. (2015). An Introduction to Convolutional Neural Networks. *International Journal for Research in Applied Science and Engineering Technology*, 10(12), 943–947. <https://doi.org/10.22214/ijraset.2022.47789>
- [24] Sherstinsky, A. (2018). Fundamentals of Recurrent Neural Network (RNN) and Long Short-Term Memory (LSTM) Network. *Physica D: Nonlinear Phenomena*, 404. <https://doi.org/10.1016/j.physd.2019.132306>
- [25] Zhang, Y. (2012). Support vector machine classification algorithm and its application. *Communications in Computer and Information Science*, 308 CCIS(PART 2), 179–186. https://doi.org/10.1007/978-3-642-34041-3_27/COVER
- [26] Staudemeyer, R. C., & Morris, E. R. (2019). *Understanding LSTM -- a tutorial into Long Short-Term Memory Recurrent Neural Networks*. <https://arxiv.org/abs/1909.09586v1>

- [27] Breiman, L. (2001). Random forests. *Machine Learning*, 45(1), 5–32. <https://doi.org/10.1023/A:1010933404324/METRICS>
- [28] Hasan, M. N., & Koo, I. (2023). Mixed-Input Deep Learning Approach to Sleep/Wake State Classification by Using EEG Signals. *Diagnostics 2023*, Vol. 13, Page 2358, 13(14), 2358. <https://doi.org/10.3390/DIAGNOSTICS13142358>
- [29] Xu, X., Chen, C., Meng, K., Lu, L., Cheng, X., & Fan, H. (2023). NAMRTNet: Automatic Classification of Sleep Stages Based on Improved ResNet-TCN Network and Attention Mechanism. *Applied Sciences 2023*, Vol. 13, Page 6788, 13(11), 6788. <https://doi.org/10.3390/APP13116788>
- [30] Gong, Y., Wang, F., Lv, Y., Liu, C., & Li, T. (2023). Automatic Sleep Staging Using BiRNN with Data Augmentation and Label Redirection. *Electronics 2023*, Vol. 12, Page 2394, 12(11), 2394. <https://doi.org/10.3390/ELECTRONICS12112394>
- [31] Toma, T. I., & Choi, S. (2023). An End-to-End Multi-Channel Convolutional Bi-LSTM Network for Automatic Sleep Stage Detection. *Sensors 2023*, Vol. 23, Page 4950, 23(10), 4950. <https://doi.org/10.3390/S23104950>
- [32] You, Y., Guo, X., Yang, Z., & Shan, W. (2023). A Siamese Network-Based Method for Improving the Performance of Sleep Staging with Single-Channel EEG. *Biomedicines 2023*, Vol. 11, Page 327, 11(2), 327. <https://doi.org/10.3390/BIOMEDICINES11020327>
- [33] Nazih, W., Shahin, M., Eldesouki, M. I., & Ahmed, B. (2023). Influence of Channel Selection and Subject's Age on the Performance of the Single Channel EEG-Based Automatic Sleep Staging Algorithms. *Sensors 2023*, Vol. 23, Page 899, 23(2), 899. <https://doi.org/10.3390/S23020899>
- [34] Lin, C. J., Lin, C. J., & Lin, X. Q. (2023). Automatic Sleep Stage Classification Using a Taguchi-Based Multiscale Convolutional Compensatory Fuzzy Neural Network. *Applied Sciences 2023*, Vol. 13, Page 10442, 13(18), 10442. <https://doi.org/10.3390/APP131810442>
- [35] Cho, J. H., Choi, J. H., Moon, J. E., Lee, Y. J., Lee, H. D., & Ha, T. K. (2022). Validation Study on Automated Sleep Stage Scoring Using a Deep Learning Algorithm. *Medicina 2022*, Vol. 58, Page 779, 58(6), 779. <https://doi.org/10.3390/MEDICINA58060779>
- [36] Li, C., Qi, Y., Ding, X., Zhao, J., Sang, T., & Lee, M. (2022). A Deep Learning Method Approach for Sleep Stage Classification with EEG Spectrogram. *International Journal of Environmental Research and Public Health 2022*, Vol. 19, Page 6322, 19(10), 6322. <https://doi.org/10.3390/IJERPH19106322>
- [37] Urtnasan, E., Park, J. U., Joo, E. Y., & Lee, K. J. (2022). Deep Convolutional Recurrent Model for Automatic Scoring Sleep Stages Based on Single-Lead ECG Signal. *Diagnostics 2022*, Vol. 12, Page 1235, 12(5), 1235. <https://doi.org/10.3390/DIAGNOSTICS12051235>
- [38] Kim, D., Lee, J., Woo, Y., Jeong, J., Kim, C., & Kim, D. K. (2022). Deep Learning Application to Clinical Decision Support System in Sleep Stage Classification. *Journal of Personalized Medicine 2022*, Vol. 12, Page 136, 12(2), 136. <https://doi.org/10.3390/JPM12020136>
- [39] Zhu, T., Luo, W., & Yu, F. (2020). Multi-Branch Convolutional Neural Network for Automatic Sleep Stage Classification with Embedded Stage Refinement and Residual Attention Channel Fusion. *Sensors 2020*, Vol. 20, Page 6592, 20(22), 6592. <https://doi.org/10.3390/S20226592>
- [40] Casciola, A. A., Carlucci, S. K., Kent, B. A., Punch, A. M., Muszynski, M. A., Zhou, D., Kazemi, A., Mirian, M. S., Valerio, J., McKeown, M. J., & Nygaard, H. B. (2021). A Deep Learning Strategy for Automatic Sleep Staging Based on Two-Channel EEG Headband Data. *Sensors 2021*, Vol. 21, Page 3316, 21(10), 3316. <https://doi.org/10.3390/S21103316>

- [41] Hasan, M. J., Shon, D., Im, K., Choi, H. K., Yoo, D. S., & Kim, J. M. (2020). Sleep State Classification Using Power Spectral Density and Residual Neural Network with Multichannel EEG Signals. *Applied Sciences* 2020, Vol. 10, Page 7639, 10(21), 7639. <https://doi.org/10.3390/APP10217639>
- [42] Yildirim, O., Baloglu, U. B., & Acharya, U. R. (2019). A Deep Learning Model for Automated Sleep Stages Classification Using PSG Signals. *International Journal of Environmental Research and Public Health* 2019, Vol. 16, Page 599, 16(4), 599. <https://doi.org/10.3390/IJERPH16040599>
- [43] Fernández-Varela, I., Hernández-Pereira, E., & Moret-Bonillo, V. (2018). A Convolutional Network for the Classification of Sleep Stages. *Proceedings* 2018, Vol. 2, Page 1174, 2(18), 1174. <https://doi.org/10.3390/PROCEEDINGS2181174>
- [44] Procházka, A., Kuchyňka, J., Vyšata, O., Cejnar, P., Vališ, M., & Mařík, V. (2018). Multi-Class Sleep Stage Analysis and Adaptive Pattern Recognition. *Applied Sciences* 2018, Vol. 8, Page 697, 8(5), 697. <https://doi.org/10.3390/APP8050697>
- [45] Aboalayon, K. A. I., Faezipour, M., Almuhammadi, W. S., & Moslehpour, S. (2016). Sleep Stage Classification Using EEG Signal Analysis: A Comprehensive Survey and New Investigation. *Entropy* 2016, Vol. 18, Page 272, 18(9), 272. <https://doi.org/10.3390/E18090272>
- [46] Ma, Y. J. X., Zschocke, J., Glos, M., Kluge, M., Penzel, T., Kantelhardt, J. W., & Bartsch, R. P. (2023). Automatic sleep-stage classification of heart rate and actigraphy data using deep and transfer learning approaches. *Computers in Biology and Medicine*, 163, 107193. <https://doi.org/10.1016/J.COMPBIOMED.2023.107193>
- [47] Lv, X., Li, J., & Xu, Q. (2022). A Multilevel Temporal Context Network for Sleep Stage Classification. *Computational Intelligence and Neuroscience*, 2022. <https://doi.org/10.1155/2022/6104736>
- [48] Zhong, Q., Lei, H., Chen, Q., & Zhou, G. (2021). A Sleep Stage Classification Algorithm of Wearable System Based on Multiscale Residual Convolutional Neural Network. *Journal of Sensors*, 2021. <https://doi.org/10.1155/2021/8222721>
- [49] Barua, P. D., Tuncer, I., Aydemir, E., Faust, O., Chakraborty, S., Subbhuraam, V., Tuncer, T., Dogan, S., & Acharya, U. R. (2022). L-Tetrolet Pattern-Based Sleep Stage Classification Model Using Balanced EEG Datasets. *Diagnostics*, 12(10). <https://doi.org/10.3390/DIAGNOSTICS12102510>
- [50] Alvarez-Estevéz, D., & Rijsman, R. M. (2021). Inter-database validation of a deep learning approach for automatic sleep scoring. *PLOS ONE*, 16(8), e0256111. <https://doi.org/10.1371/JOURNAL.PONE.0256111>
- [51] Song, T. A., Chowdhury, S. R., Malekzadeh, M., Harrison, S., Hoge, T. B., Redline, S., Stone, K. L., Saxena, R., Purcell, S. M., & Dutta, J. (2023). AI-Driven sleep staging from actigraphy and heart rate. *PLOS ONE*, 18(5), e0285703. <https://doi.org/10.1371/JOURNAL.PONE.0285703>
- [52] Jin, Z., & Jia, K. (2023). A temporal multi-scale hybrid attention network for sleep stage classification. *Medical and Biological Engineering and Computing*, 61(9), 2291–2303. <https://doi.org/10.1007/S11517-023-02808-Z/TABLES/5>
- [53] Cao, T., Lian, Z., Du, H., Shen, J., Fan, Y., & Lyu, J. (2023). A sleep staging model for the sleep environment control based on machine learning. *Building Simulation*, 16(8), 1409–1423. <https://doi.org/10.1007/S12273-023-1049-6/METRICS>
- [54] Sharma, M., Makwana, P., Chad, R. S., & Acharya, U. R. (2023). A novel automated robust dual-channel EEG-based sleep scoring system using optimal half-band pair linear-phase biorthogonal wavelet filter bank. *Applied Intelligence*, 53(15), 18681–18699. <https://doi.org/10.1007/S10489-022-04432-0/FIGURES/5>

- [55] Zhang, Z., Xue, Y., Slowik, A., & Yuan, Z. (2023). Sle-CNN: a novel convolutional neural network for sleep stage classification. *Neural Computing and Applications*, 35(23), 17201–17216. <https://doi.org/10.1007/S00521-023-08598-7/TABLES/3>
- [56] Pandey, C., Baghel, N., Gupta, R., & Dutta, M. K. (2024). Nocturnal sleep sounds classification with artificial neural network for sleep monitoring. *Multimedia Tools and Applications*, 83(6), 15693–15709. <https://doi.org/10.1007/S11042-023-16190-3/TABLES/6>
- [57] Fukui, K. ichi, Ishimaru, S., Kato, T., & Numao, M. (2023). Sound-based sleep assessment with controllable subject-dependent embedding using Variational Domain Adversarial Neural Network. *International Journal of Data Science and Analytics*, 1–11. <https://doi.org/10.1007/S41060-023-00407-7/FIGURES/8>
- [58] Lee, J., Kim, H. C., Lee, Y. J., & Lee, S. (2023). Development of generalizable automatic sleep staging using heart rate and movement based on large databases. *Biomedical Engineering Letters*, 13(4), 649–658. <https://doi.org/10.1007/S13534-023-00288-6/TABLES/2>
- [59] Fonseca, P., Ross, M., Cerny, A., Anderer, P., van Meulen, F., Janssen, H., Pijpers, A., Dujardin, S., van Hirtum, P., van Gilst, M., & Overeem, S. (2023). A computationally efficient algorithm for wearable sleep staging in clinical populations. *Scientific Reports*, 13(1), 1–14. <https://doi.org/10.1038/S41598-023-36444-2/FIGURES/5>
- [60] Matheus, A., Samer, G., Lu, W., Nengah, H., Samantha, W., Carl, S. Y., & Reena, M. (2023). Machine learning polysomnographically-derived electroencephalography biomarkers predictive of epworth sleepiness scale. *Scientific Reports 2023 13:1*, 13(1), 1–9. <https://doi.org/10.1038/s41598-023-34716-5>
- [61] Lee, C. H., Kim, H. J., Kim, Y. T., Kim, H., Kim, J. Bin, & Kim, D. J. (2023). SleepExpertNet: high-performance and class-balanced deep learning approach inspired from the expert neurologists for sleep stage classification. *Journal of Ambient Intelligence and Humanized Computing*, 14(6), 8067–8083. <https://doi.org/10.1007/S12652-022-04443-2/FIGURES/7>
- [62] Che, J. H., Ling, B. W. K., Liu, Q., & Miao, Q. (2023). Variational mode decomposition-based sleep stage classification using multi-channel polysomnograms. *Signal, Image and Video Processing*, 17(4), 1355–1363. <https://doi.org/10.1007/S11760-022-02343-8/METRICS>
- [63] Sridhar, N., Shoeb, A., Stephens, P., Kharbouch, A., Shimol, D. Ben, Burkart, J., Ghoreyshi, A., & Myers, L. (2020). Deep learning for automated sleep staging using instantaneous heart rate. *Npj Digital Medicine 2020 3:1*, 3(1), 1–10. <https://doi.org/10.1038/s41746-020-0291-x>
- [64] Radha, M., Fonseca, P., Moreau, A., Ross, M., Cerny, A., Anderer, P., Long, X., & Aarts, R. M. (2019). Sleep stage classification from heart-rate variability using long short-term memory neural networks. *Scientific Reports 2019 9:1*, 9(1), 1–11. <https://doi.org/10.1038/s41598-019-49703-y>
- [65] Savareh, B. A., Bashiri, A., Behmanesh, A., Meftahi, G. H., & Hatef, B. (2018). Performance comparison of machine learning techniques in sleep scoring based on wavelet features and neighboring component analysis. *PeerJ*, 2018(7), e5247. <https://doi.org/10.7717/PEERJ.5247/SUPP-7>
- [66] Li, W., & Gao, J. (2023). Automatic sleep staging by a hybrid model based on deep 1D-ResNet-SE and LSTM with single-channel raw EEG signals. *PeerJ Computer Science*, 9, e1561. <https://doi.org/10.7717/PEERJ-CS.1561>
- [67] Fu, Z., Huang, C., Zhang, L., Wang, S., & Zhang, Y. (2022). Deep Learning Model of Sleep EEG Signal by Using Bidirectional Recurrent Neural Network Encoding and Decoding. *Electronics 2022, Vol. 11, Page 2644*, 11(17), 2644. <https://doi.org/10.3390/ELECTRONICS11172644>
- [68] Sharma, M., Tiwari, J., Patel, V., & Rajendra Acharya, U. (2021). Automated Identification of Sleep Disorder Types Using Triplet Half-Band Filter and Ensemble Machine Learning Techniques with EEG

- [69] Tsai, C. Y., Kuan, Y. C., Hsu, W. H., Lin, Y. T., Hsu, C. R., Lo, K., Hsu, W. H., Majumdar, A., Liu, Y. S., Hsu, S. M., Ho, S. C., Cheng, W. H., Lin, S. Y., Lee, K. Y., Wu, D., Lee, H. C., Wu, C. J., & Liu, W. Te. (2021). Differentiation Model for Insomnia Disorder and the Respiratory Arousal Threshold Phenotype in Obstructive Sleep Apnea in the Taiwanese Population Based on Oximetry and Anthropometric Features. *Diagnostics* 2022, Vol. 12, Page 50, 12(1), 50. <https://doi.org/10.3390/DIAGNOSTICS12010050>
- [70] Zhang, J., Tang, Z., Gao, J., Lin, L., Liu, Z., Wu, H., Liu, F., & Yao, R. (2021). Automatic detection of obstructive sleep apnea events using a deep CNN-LSTM model. *Computational Intelligence and Neuroscience*, 2021. <https://doi.org/10.1155/2021/5594733>
- [71] Toften, S., Kjellstadli, J. T., Tyvold, S. S., & Moxness, M. H. S. (2021). A Pilot Study of Detecting Individual Sleep Apnea Events Using Noncontact Radar Technology, Pulse Oximetry, and Machine Learning. *Journal of Sensors*, 2021. <https://doi.org/10.1155/2021/2998202>
- [72] Chaw, H. T., Kamolphiwong, T., Kamolphiwong, S., Tawaranurak, K., & Wongtanawijit, R. (2023). ZleepNet: A Deep Convolutional Neural Network Model for Predicting Sleep Apnea Using SpO2 Signal. *Applied Computational Intelligence and Soft Computing*, 2023. <https://doi.org/10.1155/2023/8888004>
- [73] Lee, D. A., Lee, H. J., Kim, H. C., & Park, K. M. (2022). Application of machine learning analysis based on diffusion tensor imaging to identify REM sleep behavior disorder. *Sleep & Breathing = Schlaf & Atmung*, 26(2), 633–640. <https://doi.org/10.1007/S11325-021-02434-9>
- [74] Phan, D. Van, Yang, N. P., Kuo, C. Y., & Chan, C. L. (2021). Deep learning approaches for sleep disorder prediction in an asthma cohort. *The Journal of Asthma : Official Journal of the Association for the Care of Asthma*, 58(7), 903–911. <https://doi.org/10.1080/02770903.2020.1742352>
- [75] Salsone, M., Quattrone, A., Vescio, B., Ferini-Strambi, L., & Quattrone, A. (2022). A Machine Learning Approach for Detecting Idiopathic REM Sleep Behavior Disorder. *Diagnostics*, 12(11). <https://doi.org/10.3390/DIAGNOSTICS12112689/S1>
- [76] Lin, C. L., Tseng, C. kun, Wang, C. J., Chao, S. H., Hwang, Y. S., & Kau, L. J. (2023). Development of smart cardiovascular measurement system using feature selection and machine learning models for prediction of sleep deprivation, cold hands and feet, and Shanghuo syndrome. *Measurement*, 221, 113441. <https://doi.org/10.1016/J.MEASUREMENT.2023.113441>
- [77] Tiwari, S., Arora, D., & Nagar, V. (2022). Supervised approach based sleep disorder detection using non - Linear dynamic features (NLDF) of EEG. *Measurement: Sensors*, 24, 100469. <https://doi.org/10.1016/J.MEASEN.2022.100469>
- [78] Huang, A. A., & Huang, S. Y. (2023). Use of machine learning to identify risk factors for insomnia. *PLOS ONE*, 18(4), e0282622. <https://doi.org/10.1371/JOURNAL.PONE.0282622>
- [79] Lee, C., & Kim, H. (2022). Machine learning-based predictive modeling of depression in hypertensive populations. *PLOS ONE*, 17(7), e0272330. <https://doi.org/10.1371/JOURNAL.PONE.0272330>
- [80] Wutzl, B., Leibnitz, K., Rattay, F., Kronbichler, M., Murata, M., & Golaszewski, S. M. (2019). Genetic algorithms for feature selection when classifying severe chronic disorders of consciousness. *PLOS ONE*, 14(7), e0219683. <https://doi.org/10.1371/JOURNAL.PONE.0219683>
- [81] Niroshana, S. M. I., Zhu, X., Nakamura, K., & Chen, W. (2021). A fused-image-based approach to detect obstructive sleep apnea using a single-lead ECG and a 2D convolutional neural network. *PLOS ONE*, 16(4), e0250618. <https://doi.org/10.1371/JOURNAL.PONE.0250618>
- [82] Yeh, E., Wong, E., Tsai, C. W., Gu, W., Chen, P. L., Leung, L., Wu, I. C., Strohl, K. P., Folz, R. J., Yar, W., & Chiang, A. A. (2021). Detection of obstructive sleep apnea using Belun Sleep Platform wearable with

- neural network-based algorithm and its combined use with STOP-Bang questionnaire. *PLOS ONE*, *16*(10), e0258040. <https://doi.org/10.1371/JOURNAL.PONE.0258040>
- [83] Sümbül, H., & Yüzer, A. H. (2024). Design of a fuzzy input expert system visual information interface for classification of apnea and hypopnea. *Multimedia Tools and Applications*, *83*(7), 21133–21152. <https://doi.org/10.1007/S11042-023-16152-9/FIGURES/12>
- [84] Chen, Q., Liang, Z., Wang, Q., Ma, C., Lei, Y., Sanderson, J. E., Hu, X., Lin, W., Liu, H., Xie, F., Jiang, H., & Fang, F. (2023). Self-helped detection of obstructive sleep apnea based on automated facial recognition and machine learning. *Sleep and Breathing*, *27*(6), 2379–2388. <https://doi.org/10.1007/S11325-023-02846-9/FIGURES/5>
- [85] Bucklin, A. A., Ganglberger, W., Quadri, S. A., Tesh, R. A., Adra, N., Da Silva Cardoso, M., Leone, M. J., Krishnamurthy, P. V., Hemmige, A., Rajan, S., Panneerselvam, E., Paixao, L., Higgins, J., Ayub, M. A., Shao, Y. P., Ye, E. M., Coughlin, B., Sun, H., Cash, S. S., ... Westover, M. B. (2023). High prevalence of sleep-disordered breathing in the intensive care unit — a cross-sectional study. *Sleep and Breathing*, *27*(3), 1013–1026. <https://doi.org/10.1007/S11325-022-02698-9/FIGURES/4>
- [86] Huo, J., Quan, S. F., Roveda, J., & Li, A. (2023). BASH-GN: a new machine learning–derived questionnaire for screening obstructive sleep apnea. *Sleep and Breathing*, *27*(2), 449–457. <https://doi.org/10.1007/S11325-022-02629-8/TABLES/4>
- [87] Lou, B., Rusk, S., Nygate, Y. N., Quintero, L., Ishikawa, O., Shikowitz, M., & Greenberg, H. (2023). Association of hypoglossal nerve stimulator response with machine learning identified negative effort dependence patterns. *Sleep and Breathing*, *27*(2), 519–525. <https://doi.org/10.1007/S11325-022-02641-Y/TABLES/2>
- [88] Han, H., & Oh, J. (2023). Application of various machine learning techniques to predict obstructive sleep apnea syndrome severity. *Scientific Reports*, *13*(1), 1–9. <https://doi.org/10.1038/S41598-023-33170-7/FIGURES/6>
- [89] Lee, W., Kim, H., Shim, J., Kim, D., Hyeon, J., Joo, E., Joo, B. E., & Oh, J. (2023). The simplification of the insomnia severity index and epworth sleepiness scale using machine learning models. *Scientific Reports*, *13*(1), 1–11. <https://doi.org/10.1038/S41598-023-33474-8/TABLES/11>
- [90] Kim, H., Seo, P., Byun, J. I., Jung, K. Y., & Kim, K. H. (2023). Spatiotemporal characteristics of cortical activities of REM sleep behavior disorder revealed by explainable machine learning using 3D convolutional neural network. *Scientific Reports* *2023* *13*:1, *13*(1), 1–13. <https://doi.org/10.1038/s41598-023-35209-1>
- [91] Lee, M. H., Kim, N., Yoo, J., Kim, H. K., Son, Y. D., Kim, Y. B., Oh, S. M., Kim, S., Lee, H., Jeon, J. E., & Lee, Y. J. (2021). Multitask fMRI and machine learning approach improve prediction of differential brain activity pattern in patients with insomnia disorder. *Scientific Reports* *2021* *11*:1, *11*(1), 1–13. <https://doi.org/10.1038/s41598-021-88845-w>
- [92] Zhao, X., Wang, X., Yang, T., Ji, S., Wang, H., Wang, J., Wang, Y., & Wu, Q. (2021). Classification of sleep apnea based on EEG sub-band signal characteristics. *Scientific Reports* *2021* *11*:1, *11*(1), 1–11. <https://doi.org/10.1038/s41598-021-85138-0>
- [93] Liu, W. Te, Wu, H. T., Juang, J. N., Wisniewski, A., Lee, H. C., Wu, D., & Lo, Y. L. (2017). Prediction of the severity of obstructive sleep apnea by anthropometric features via support vector machine. *PLOS ONE*, *12*(5), e0176991. <https://doi.org/10.1371/JOURNAL.PONE.0176991>
- [94] Arslan, R. S. (2023). Sleep disorder and apnea events detection framework with high performance using two-tier learning model design. *PeerJ Computer Science*, *9*, 1–30. <https://doi.org/10.7717/PEERJ-CS.1554/SUPP-5>

- [95] Liu, C., Yin, Y., Sun, Y., & Ersoy, O. K. (2022). Multi-scale ResNet and BiGRU automatic sleep staging based on attention mechanism. *PLOS ONE*, 17(6), e0269500. <https://doi.org/10.1371/JOURNAL.PONE.0269500>
- [96] Koley, B., & Dey, D. (2012). An ensemble system for automatic sleep stage classification using single channel EEG signal. *Computers in Biology and Medicine*, 42(12), 1186–1195. <https://doi.org/10.1016/J.COMPBIOMED.2012.09.012>
- [97] Alickovic, E., & Subasi, A. (2018). Ensemble SVM method for automatic sleep stage classification. *IEEE Transactions on Instrumentation and Measurement*, 67(6), 1258–1265. <https://doi.org/10.1109/TIM.2018.2799059>
- [98] Buddana, H. V. K. S., Kaushik, S. S., Manogna, P. V. S., & Shijin, S. K. (2021). Word Level LSTM and Recurrent Neural Network for Automatic Text Generation. *2021 International Conference on Computer Communication and Informatics, ICCCI 2021*. <https://doi.org/10.1109/ICCCI50826.2021.9402488>