

---

# Erasing Concepts from Text-to-Image Diffusion Models with Few-shot Unlearning

---

Masane Fuchi<sup>1</sup> Tomohiro Takagi<sup>1</sup>

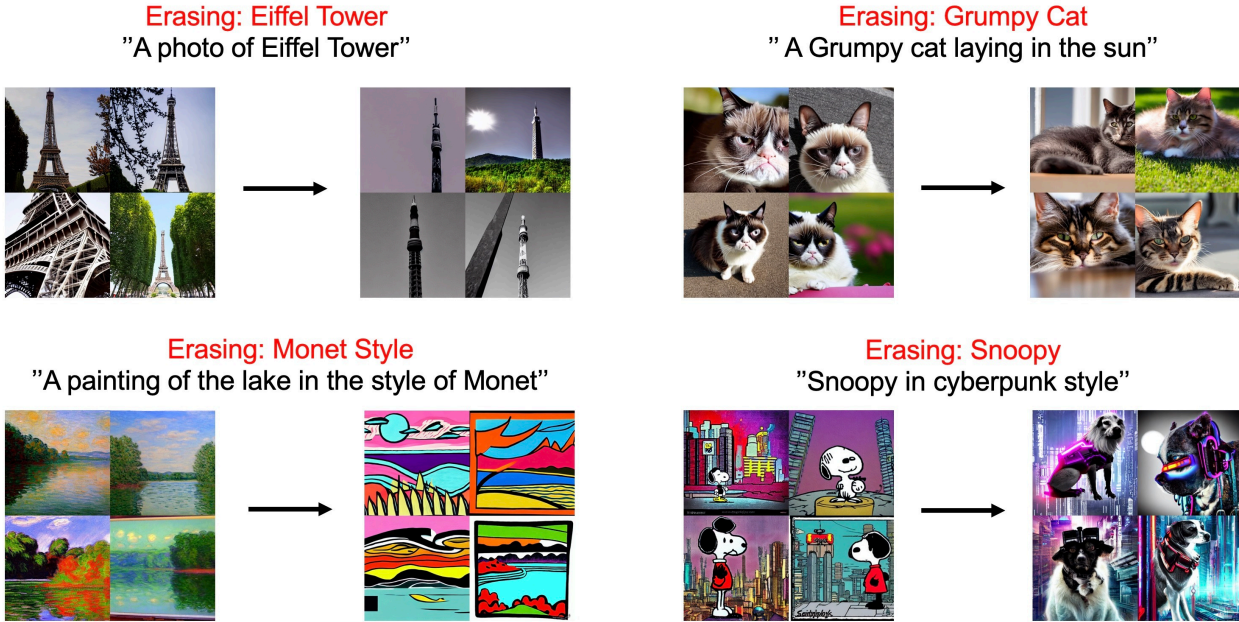

Figure 1: Overview of our results. Given simple text, our method is able to erase concept within 10 s per concept with few images. Unlike current methods, our method involves updating the text encoder. Generated images after erasing with our method are mapped to similar concept without providing anchor concepts. For example, “Snoopy” is mapped to dog which is its motif and “Grumpy Cat” is mapped to cat which is the super-category.

## Abstract

Generating images from text has become easier because of the scaling of diffusion models and advancements in the field of vision and language. These models are trained using vast amounts of data from the Internet. Hence, they often contain undesirable content such as copyrighted material. As it is challenging to remove such data and retrain the models, methods for erasing specific concepts from pre-trained models have been investigated. We propose a novel concept-erasure method that updates the text encoder using few-shot unlearning in which a few real images are used. The discussion regarding the generated images after erasing a concept has been lacking.

While there are methods for specifying the transition destination for concepts, the validity of the specified concepts is unclear. Our method implicitly achieves this by transitioning to the latent concepts inherent in the model or the images. Our method can erase a concept within 10 s, making concept erasure more accessible than ever before. Implicitly transitioning to related concepts leads to more natural concept erasure. We applied the proposed method to various concepts and confirmed that concept erasure can be achieved tens to hundreds of times faster than with current methods. By varying the parameters to be updated, we obtained results suggesting that, like previous research, knowledge is primarily accumulated in the feed-forward networks of the text encoder. Our code is available at <https://github.com/fmp453/few-shot-erasing>

<sup>1</sup>Department of Computer Science, Meiji University, Japan. Correspondence to: Masane Fuchi <ce235031@meiji.ac.jp>.

## 1. Introduction

Diffusion models (Sohl-Dickstein et al., 2015; Ho et al., 2020) have surpassed the previous state-of-the-art generative adversarial networks (GANs) (Goodfellow et al., 2014; Brock et al., 2019; Karras et al., 2020) in performance, because of their stable learning and broad representation capabilities (Dhariwal & Nichol, 2021). With classifier-free guidance (Ho & Salimans, 2021), it has also become possible to generate high-quality images on the basis of natural language instructions (Saharia et al., 2022; Ramesh et al., 2022; Balaji et al., 2023; Xue et al., 2023; Podell et al., 2024; Dai et al., 2023).

In large-scale image-generative models, since various data are collected to improve generation quality, it is possible to generate undesirable images such as copyright contents. While filtering training data can help mitigate the generation of such undesirable images (OpenAI, 2023a), it is generally costly and challenging. This approach is also ineffective against pre-trained models. Previous studies have successfully removed specific concepts from text-to-image generative models by updating the weights of U-Net (Ronneberger et al., 2015), an image generative module, or its conditioned cross attention (Gandikota et al., 2023; Kumari et al., 2023; Gandikota et al., 2024; Zhang et al., 2023; Zhao et al., 2024). However, updating parameters of U-Net can lead to a decrease in generation quality in unconditional cases.

We propose a method for erasing specific concepts from the text-to-image diffusion models without altering the parameters of the U-Net. Specifically, we focus on the text encoder and aim to achieve this by altering the quality of text conditioning. We use several images of the target concept to make slight changes to the parameters of the text encoder to remove the concept. Our method is inspired by textual inversion (Gal et al., 2023), but since we only make minor parameter adjustments, it operates very quickly. Table 1 compares our proposed method with current methods. It is evident that our proposed method can erase concepts more quickly compared to existing methods. Additionally, our proposed method naturally maps to surrounding concepts, erasing the need for concept induction by an anchor concept<sup>1</sup>.

Our contributions are as follows:

- We achieve a speedup of 60~900 times compared with current methods of updating the traditional U-Net, enabling concept erasure within 10 s.
- Concept erasure is achieved by providing several images related to the concept to be erased.

<sup>1</sup>We describe anchor concepts in detail in Appendix A.2.

- While current methods often lack discussion on the generated examples after concept erasure, our proposed method ensures semantic similarity in the resulting concepts. We highlighted this issue in the quantitative evaluation of previous research.

### 1.1. Intuitive Motivation

We provide an explanation of the intuitive motivation behind our study. On the basis of this motivation, we introduce our proposed method supported by various justifications.

Text-to-image diffusion models are implemented using models trained on a large amount of data from the web. They are highly versatile foundation models capable of executing various downstream tasks (Bommasani et al., 2022). Therefore, adapting them to individual domains requires additional fine-tuning. The smallest unit of the domain adaptation is personalization, and numerous methods have been proposed to achieve this (Gal et al., 2023; Ruiz et al., 2023; Wei et al., 2023; Chen et al., 2023; Pang et al., 2023; Fei et al., 2023; Zhang et al., 2024). Inspired by these studies, we have one fundamental question.

*If it is possible for these methods to give specific knowledge, could a similar technique be used to make them forget?*

We address this question by taking textual inversion (Gal et al., 2023) as a reference and partially changing the method. In the subsequent sections, we explore our proposed method and the answer to this question focusing on the modifications made.

## 2. Our Method

Our goal is to prevent the generation of specific concepts by updating the text encoder. The parameters of the U-Net responsible for image generation remain unchanged, ensuring that the model’s generation capability (image fidelity) is preserved. We first discuss why we believe the text encoder should be updated (Section 2.1). We then outline our proposed method (Section 2.2).

### 2.1. Why Text Encoder?

In this subsection, we explain why our method targets the updating of the text encoder.

In the field of text-to-image, it has been demonstrated that the quality of the text encoder, represented by its size, correlates with the quality of text-image alignment (Saharia et al., 2022). When comparing the use of CLIP (Radford et al., 2021) and T5 (Raffel et al., 2020) as the text encoder,

Table 1: Comparison of proposed method with current methods when erasing ‘‘Van Gogh style’’.  $\times$  means that anchor concept is necessary.

Method	Target parameters	Runtime	Anchor Concepts	#U-Net
ESD-x (Gandikota et al., 2023)	Cross-Attention	1 hour	$\checkmark$	2
UCE (Gandikota et al., 2024)	Attention Weight	10 min	$\times$	1
SPM (Lyu et al., 2023)	Adapters in U-Net	2.5 hours	$\checkmark$	1
Ours	Text Encoder	<b>7~8 sec</b>	$\checkmark$	1

it has been indicated that the T5, which is trained solely on text data outperforms human evaluation compared with using CLIP. While quantitative evaluations show similar results between CLIP and T5, it is known that quantitative metrics (such as Fréchet inception distance (FID) (Heusel et al., 2017) and CLIP Score (Hessel et al., 2021)) do not always align with human evaluations in assessing the quality of generated images (Otani et al., 2023). Therefore, achieving superior results in human evaluations support the hypothesis that the performance to some extent depends on the quality of the text encoder. DALLE-3 (OpenAI, 2023a), which is trained by using high-quality and detailed image captions generated by GPT-4 (OpenAI, 2023b), achieves extremely high-quality image generation. From these findings, for models possessing sufficient image-generation capabilities (image fidelity, that is, lower FID), we believe that given information by the text affects the text-image alignment. This is also demonstrated in TextCrafter (Li et al., 2024). CLIP’s final output is a multi-dimensional vector. Although somewhat apparent from the concept of latent variables, visualizing this vector using techniques such as t-SNE (van der Maaten & Hinton, 2008) allows for meaningful clustering (Weiss et al., 2022). Therefore, we believe that slight variations in the output of CLIP can be used to move towards similar concepts, and achieving this could be possible by slightly adjusting the parameters.

In many cases, including community models, the text encoder is often fixed during training. Considering the limited variety of text encoders, erasing specific concepts from one text encoder might be more beneficial than the strategy used with U-Net (Lyu et al., 2023) when transferring it for use in other models.

On the basis of the above, we conclude that updating the text encoder is more appropriate than updating the U-Net. Reframing concept erasure as ‘‘significantly decreasing text-image alignment for specific concepts’’ further highlights the natural focus on the text encoder.

## 2.2. Erasing Method

In this subsection, we consider preventing the generation of specific concepts by updating the text encoder. It is crucial to preserve as many concepts as possible other than the

target concept. Therefore, as mentioned in Section 2.1, we consider making slight variations to the parameters of the text encoder.

$$c_\theta \leftarrow c_\theta + \Delta c, \quad (1)$$

where  $c_\theta$  denotes the text encoder. The issue lies in how to compute  $\Delta c$ . Our method is very simple, merely setting the loss in the reverse direction according to Jang et al. (2023). Figure 2 illustrates an overview of our proposed method. While experiments in a similar setup have been conducted by Kumari et al. (2023), they updated the parameters of the U-Net, which differs from our approach. This loss setting is very similar to textual inversion (Gal et al., 2023). We use stable diffusion (Rombach et al., 2022) due to the restriction of our computational resources. The stable diffusion loss is given by

$$L_{SD} = \mathbb{E}_{x, \epsilon \in \mathcal{N}(0,1), t, y} [\|\epsilon - \epsilon_\theta(x, t, c_\theta(y))\|_2^2] \quad (2)$$

where  $t$  is the timestep,  $x$  is the denoised image to time  $t$ ,  $\epsilon$  is the unscaled noise sample, and  $\epsilon_\theta$  is the denoising network. Our method involves training to maximize this loss. However, to prevent drastic changes to the text encoder, we terminate training within an appropriate range (managed with the number of epochs) rather than maximizing it completely.

$$-\mathbb{E}_{x, \epsilon \in \mathcal{N}(0,1), t, y} [\|\epsilon - \epsilon_\theta(x, t, c_\theta(y^*))\|_2^2] \quad (3)$$

We update only the text encoder, so the parameters of  $\epsilon_\theta$  are fixed. The notation  $y^*$  denotes the caption that includes the concept to erase. We use CLIP ImageNet Template (Radford et al., 2021) for this caption as well as textual inversion. By making slight variations to the text encoder, we assume that the impact on other concepts is minimal and is further mapped to approximate concepts. Since only minor changes are made, training is completed in a short period.

In this formulation, we investigated two approaches: one using a few-shot method (Wang et al., 2020) with four pre-prepared images for  $x$  and the other using completely random noise (zero-shot).

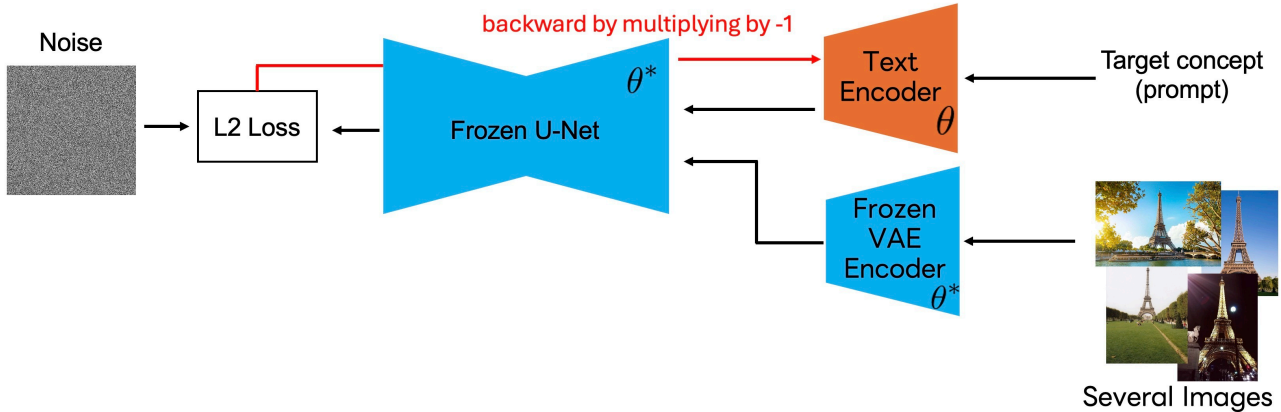

Figure 2: Overview of our proposed method.  $\theta^*$  denotes that parameters are fixed.

Intuitively, considering text-image alignment, the few-shot approach is expected to perform better. We aimed to confirm this through experiment. Considering practical aspects, it is straightforward to prepare actual images of the concepts to be erased, making it possible to confirm the effectiveness of the method even with the few-shot approach.

### 2.3. Update Parameters

There are studies suggesting that the knowledge gained during learning is stored in feed-forward networks (i.e. MLPs) (Meng et al., 2022; Dai et al., 2022; Geva et al., 2021). There is also a study that shows that the final self-attention layer is also effective in knowledge editing (Meng et al., 2022). Following these studies, we update all MLPs and the final self-attention layer. The list of updated parameters is shown in Table 4 of Appendix B.

## 3. Experiments

We confirm the effectiveness of our proposed method throughout the experiments. Before presenting the results, we discuss the baselines (Section 3.1) and experimental settings (Section 3.2).

### 3.1. Baselines

We used ESD (Gandikota et al., 2023) (we specifically used ESD-x-1, which updates the parameters related to cross-attention), Unified Concept Editing (UCE) (Gandikota et al., 2024), and Semi-Permeable Membrane (SPM) (Lyu et al., 2023) which are open sourced and high effectiveness as the baselines. Due to the privacy issue with of LAION-5B (Schuhmann et al., 2022)<sup>2</sup>, we cannot conduct with Ab-

<sup>2</sup><https://laion.ai/notes/laion-maintenance/>

lating Concept (Kumari et al., 2023). When elements other than the pre-trained model depend on external materials, such as in this case, we may not be able to reproduce the results completely. The above baselines exclusively use the text-to-image diffusion models, including VAE, U-Net, text encoder, and tokenizer. For further details, please refer to Appendix C.2.

### 3.2. Experimental Setup

**Training.** We apply our proposed method to Stable Diffusion 1.5<sup>3</sup>, the text encoder of which is OpenAI CLIP vit-large-patch14<sup>4</sup>. We use four images in the few-shot setting. The text encoder is optimized using Adam (Kingma & Ba, 2017). The hyperparameters we used in our experiments are listed in Table 2.

Table 2: Hyperparameters of our method

Hyperparameter	Value
Batch Size	2
Training Epochs	4 (proper noun) 5 (common noun)
Learning rate	$1 \times 10^{-5}$
Adam ( $\beta_1, \beta_2$ )	(0.9, 0.98)
Weight decay	$1 \times 10^{-8}$

**Generating.** We used PNDM Scheduler (Liu et al., 2022) with 7.5 guidance scale and 100 inference steps.



Figure 3: Comparison of images generated with each method

### 3.3. Qualitative Results

**Erasing Single Object** We conducted experiments focusing on proper nouns. We also conducted experiments with common nouns to ensure general performance. We focus on the results using “Eiffel Tower” as the proper noun and “banana” as the common noun. More results are presented in Appendix D.

In the first row of Figure 3, the results of erasing “Eiffel Tower” are shown. With ESD and SPM, while the concept of the Eiffel Tower disappears, the generated images are completely unrelated. This phenomenon was also observed by Lu et al. (2024), and it is necessary to consider whether the generated images of the erased concepts are appropriate. With UCE, as the anchor concept was “Paris”, the results depict the cityscape of Paris. In contrast, our proposed method not only prevented the generation of the Eiffel Tower but also retained only the elements of the tower, indicating that the embedding is mapped to a similar concept.

In the second row of Figure 3, the results of erasing “banana” are shown. Overall, similar results when erasing “Eiffel Tower” can be observed. SPM produced results that are difficult to interpret as successfully erasing the banana. As common nouns are ubiquitous words, they are likely heavily represented in the training data of original stable

diffusion, making it challenging to erase such concepts. With UCE, as the anchor concept is “Fruit”, various types of fruits were generated. Despite not explicitly specifying such categories, our proposed method generated something resembling a category of fruits to which bananas belong.

**Effect on Other Concepts** We investigated the impact of removing one concept on the generation of other concepts. We used a text encoder with “Eiffel Tower” erased to generate other concepts. The generated concepts were “cat”, which is an unrelated concept, another landmark in Paris “Arc de Triomphe” (the caption we used “Triumphal arch”), and a similar-shaped landmark “Tokyo Tower”. The results are shown in Figure 4. It can be seen that other concepts could also be generated. The generated images of the Tokyo Tower differ in actual shape<sup>5</sup>. However, because this is already observed in the images from the Original SD, we did not consider it is a significant drawback in the qualitative evaluations.

In previous studies (Gandikota et al., 2023; Kumari et al., 2023; Gandikota et al., 2024; Zhang et al., 2023; Zhao et al., 2024), the generated images from Original SD were treated as ground truth. However, we consider this approach lacks justification. As observed in the example of “Tokyo Tower” in Figure 4, the generated images from the Original SD are not perfect. Like Fan et al. (2024), we believe that the generated images using a retrain model<sup>6</sup>

<sup>3</sup><https://huggingface.co/runwayml/stable-diffusion-v1-5>

<sup>4</sup><https://huggingface.co/openai/clip-vit-large-patch14>

<sup>5</sup>The actual shape of Tokyo Tower can be checked at <https://www.japan.travel/en/spot/1709/>

<sup>6</sup>Details of a retrain model are described in Appendix A.3.

should be the ground truth. However, a retrain model involves significant computational costs, surpassing the scope of the type of experimentation we can conduct. As the training data of CLIP are not publicly available, reproducing experiments is also impossible. Therefore, we primarily conducted a qualitative evaluation.

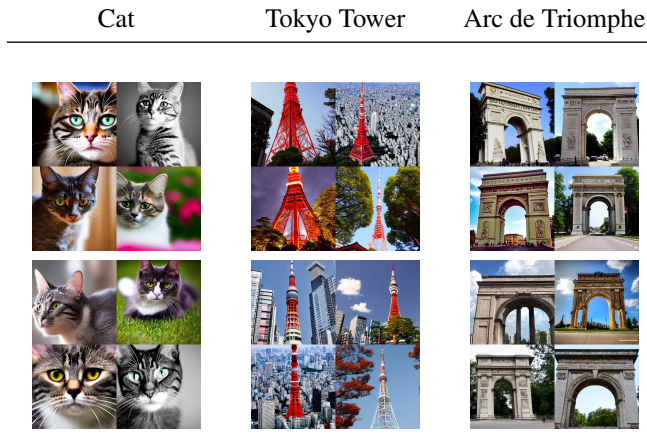

Figure 4: Comparison of the generated images between before (upper) and after (bottom) erasing “Eiffel Tower”. Caption we used when generating was “a photo of (a) {concept}”.

### 3.4. Erasing Multiple Concepts

We considered the erasure of multiple concepts. We erase “Snoopy”, “R2D2”, and “Mickey Mouse” in that order. The results are shown in Figure 5. Even after removing multiple concepts, the erased concepts did not reappear. While the change in generated images could be considered a future challenge, as previously mentioned, a retrain model served as the ground truth in our research, mitigating this issue. It can be observed that for the concepts that were not erased, the contents of the prompts were reflected in the generated images. The generated images of R2D2 from Original SD also did not match the prompt, which serves as another example of why Original SD is not considered the ground truth.

### 3.5. Quantitative Results

We used CLIP Score (Hessel et al., 2021) as the evaluation metric. While FID is suitable for evaluation on limited datasets, there are concerns about its inability to reflect diversity in other cases (Jayasumana et al., 2023), so we choose not to use this standard metric. CLIP Score faces similar challenges in evaluating concepts not learned by CLIP (Otani et al., 2023). We address this issue by not using such captions during evaluation. Since our method does not update any parameters of the U-Net, image fidelity should not degrade. However, as the parameters of the text

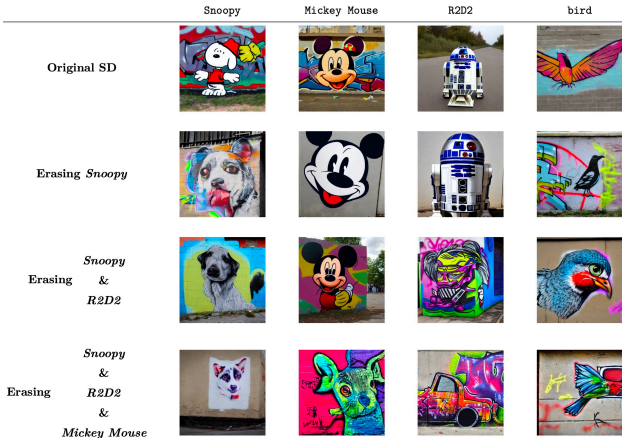

Figure 5: Samples of “graffiti of the {Concept}” when erasing multiple concepts

encoder are updated, text-image alignment may decrease.

It should be noted that while a higher CLIP Score is desirable for concepts that have not been erased, the same may not hold true for erased concepts. Considering the example of the “Eiffel Tower” in Figure 3, for instance, it is anticipated that ESD-x-1 would have a lower CLIP Score compared with our proposed method. This is because when there is no relevance between the text and generated image, the CLIP Score is naturally lower. We conducted a quantitative comparison following prior studies (Gandikota et al., 2023; Kumari et al., 2023; Gandikota et al., 2024; Zhang et al., 2023; Basu et al., 2023; Lyu et al., 2023). However, the metrics used in those studies do not evaluate “how well concepts have been erased?”. To the best of our knowledge, such evaluation metrics do not currently exist.

We created the prompts using CLIP ImageNet Template small and calculated the CLIP Score. Ten images were generated for each prompt. Due to resource constraints, generating ten images simultaneously is not feasible, so five images were generated at a time with seed values of 0 and 2024. Generation was executed using DDIM (Song et al., 2021) Scheduler with 7.5 guidance scale and 50 inference steps.

Table 3 lists the results. Following previous studies, it can be observed that our proposed method is capable of erasing styles more effectively. Regarding objects, while successfully removing the target concept, our method maintained CLIP Scores for other concepts as much as possible. However, the results of the quantitative evaluation in Table 3 do not align with the results presented in Figure 3. Similar to the earlier discussion, upon examining the generated Eiffel Tower images in Figure 3, it is evident that the Eiffel Tower was erased with all methods. According to previous studies, ESD-x-1, which had the lowest CLIP Score, would be

Table 3: Comparison of the CLIP Scores

Erasing <i>Eiffel Tower</i>			
	Eiffel Tower	Tokyo Tower	Triumphal arch
Original SD	0.256	0.283	0.286
ESD-x-1	0.111	0.177	0.274
UCE	0.213	0.241	0.284
SPM	0.190	0.277	0.283
Ours	0.212	0.262	0.281
Erasing <i>Monet Style</i>			
	Monet Style	Gogh Style	Picasso Style
Original SD	0.276	0.264	0.267
ESD-x-1	0.276	0.264	0.267
UCE	0.273	0.264	0.267
SPM	0.235	0.263	0.267
Ours	0.179	0.207	0.241

considered the best-performing method. However, it is difficult to claim that ESD-x-1 exhibits the best performance through qualitative comparison. Therefore, we believe that using CLIP Score for evaluating concept erasure is not be appropriate. The same argument applies when using evaluation metrics such as FID or Learned perceptual Image Patch Similarity (LPIPS) (Zhang et al., 2018). LPIPS is a metric that represents the distance from the Original SD. However, in the context of machine unlearning, a retrain model is the gold standard as the ground truth (Thudi et al., 2022; Jia et al., 2023; Fan et al., 2024). If FID or LPIPS were to be used, a retrain model would need to be prepared, which is impractical as an evaluation metric.

## 4. Ablation Studies

We decomposed our proposed method into several elements and conducted additional experiments to confirm the effectiveness of the elements.

### 4.1. $k$ -shot Erasing

We consider reducing the number of images provided during training. We conducted these experiments with zero-shot and two-shot. Figure 6 shows the results with zero-shot, and Figure 7 shows the results with two-shot. In both cases, the “Eiffel Tower” is still present. However, with zero-shot, it is clearly recognizable, while with two-shot, some images make it difficult to distinguish the Eiffel Tower. This indicates the need for diverse images.

As evident from Figure 8, with four-shot, the concept is mostly disappeared after the second epoch (four iterations). From this observation, we consider that the number of iterations is also sufficient for zero and two-shot setting.

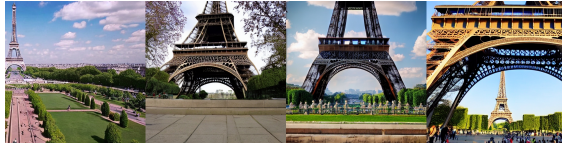

Figure 6: Generated images in case with zero-shot erasing



Figure 7: Generated images in case with two-shot erasing

### 4.2. Number of Epochs

We confirm the transition over epochs using “Snoopy”, “Eiffel Tower”, and “banana”. Five epochs were trained for all concepts in relation to Section 4.4. Figure 8 shows the results. The concepts “Snoopy” and “Eiffel Tower”, which are proper nouns, disappeared early on. Therefore, there is no possibility of concept erasure failure due to the low number of iterations in the two-shot setting mentioned in the previous subsection. For “banana”, however, the concept disappeared at the end of the fifth epoch. This indicates that the difficulty of the task differs between common and proper nouns. It can be inferred that more common nouns than proper nouns are included in the training data when training with CLIP and stable diffusion. This suggests that it is more difficult to erase knowledge that is more deeply rooted in the model.

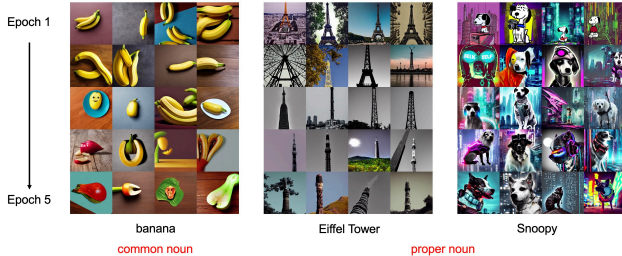

Figure 8: Transition due to change in number of epochs. Top row is the result at end of first epoch and bottom row is result at end of fifth epoch. Captions we used in generating are “a banana on the table”, “a photo of Eiffel Tower” and “Snoopy in cyberpunk style” respectively.

### 4.3. Real or Synthesized Images

All experiments were conducted using real images. This experimental setting is based on our belief that a retrain model serves as the ground truth. In this case, it is most appropriate to use a subset of the dataset  $\mathcal{D}_f$  containing the

concepts to erase. However, experiments can be conducted using synthesized images. Therefore, we conducted experiments using four synthesized images (referred as Figure 3). The results are shown in Figure 9. Eiffel Tower was completely absent in some images, while in others, it is unclear what is being generated. Additionally, while in real images, the concept of “Eiffel Tower” was mapped to “Tower”, in the case of generated images, “Eiffel Tower” was mapped to “Building”. Since the appropriateness of each approach depends largely on subjective interpretation, we cannot make a definitive assertion. However, on the basis of the idea of slight change in text encoders, we believe that “Eiffel Tower” should be mapped to the “Tower”.



Figure 9: Results when using synthesized images

#### 4.4. Update Parameters

There are studies suggesting that knowledge acquired during training is stored in MLPs (Meng et al., 2022; Dai et al., 2022; Geva et al., 2021) and in the first self-attention modules (Basu et al., 2023) of transformer-based models, but it is unclear which is more effective in text-to-image tasks. We conducted experiments by limiting the parameters updated to either MLPs or self-attention modules to determine which part of CLIP contributes to knowledge updating. We presented the results from full parameter tuning. In the first self-attention layer, there are four trainable weight matrices:  $W_q$ ,  $W_k$ ,  $W_v$ , and  $W_{out}$ . We conducted the experiments under two settings: (i) updating only  $W_{out}$  following the approach of DiffQuickFix (Basu et al., 2023) and (ii) updating all four matrices.

The results are presented in Figure 10. In the updates of the first self-attention layer, the concept of “Snoopy” was not erased in either setting, and almost identical results were obtained. It can be inferred that slightly updating only the weights of the first self-attention layer contributes minimally to concept erasure. When only updating MLPs, it can be observed that the concept disappeared by the end of the fifth epoch. This suggests that knowledge is accumulated in MLPs. It is evident that the concept disappeared at earlier stages with both our method and the full-parameter-tuning method. Therefore, it can be inferred that there are parameters related to knowledge other than MLPs. In comparison with full parameter tuning, the transition of generated images is generally the same. Up to the second epoch, the results were mostly identical when viewed as a whole despite some differences in detail. From this observation,

the key other than MLPs is the final self-attention layer.

This comparison suggests that even with a transformer-based architecture such as CLIP trained on image-text pairs, the primary knowledge may be accumulated in MLPs. This indicates that in text-to-image diffusion models, using a transformer-based text encoder, regardless of the specific model (such as T5, BERT (Devlin et al., 2019)), updating the parameters of MLPs may enable concept erasure. However, since we do not have access to the weights of models trained using text encoders trained only with text, we cannot verify this.

## 5. Limitations

The experiments presented in Section 3 demonstrated the effectiveness of our proposed method. However, challenges remain for more general concept erasure. In Figure 11, we show the cases of failed erasing. We consider “church” as an example, this failure. It may stem from the large domain represented by “church” in the text encoder’s latent space. Since our method aims to map to similar semantic spaces by fine-tuning the text encoder, it becomes challenging to remove concepts associated with large semantic spaces. In such cases, combining our method with other concept erasure methods is feasible. DiffQuickFix (Basu et al., 2023) updates one of the weight matrices in the first self-attention layer, which is not updated with our proposed method. Hence, it can be effectively combined with our method to improve concept erasure in challenging cases.

## 6. Related Works

### 6.1. Text-to-Image Diffusion Models and Text Encoder

Denosing diffusion models (Sohl-Dickstein et al., 2015; Ho et al., 2020) have achieved success even on large-scale datasets with high variance, such as ImageNet (Deng et al., 2009), by using a simple objective function. They have also demonstrated the ability to handle various resolutions (Ho et al., 2022). While it had been necessary to prepare a separate classifier for conditional generation tasks (Dhariwal & Nichol, 2021), recent advancements have enabled image generation without the need for a classifier (Ho & Salimans, 2021).

CLIP (Radford et al., 2021), trained on a large corpus of image-text pairs from the Internet, has established a robust connection between images and natural language. The evolution of image generation with natural language has been accelerated by the fusion of CLIP and diffusion models (Saharia et al., 2022; Ramesh et al., 2022; OpenAI, 2023a; Rombach et al., 2022). Research has also been conducted on how to transfer natural-language information to





Figure 10: Change in concept erasure depending on parameters to be updated

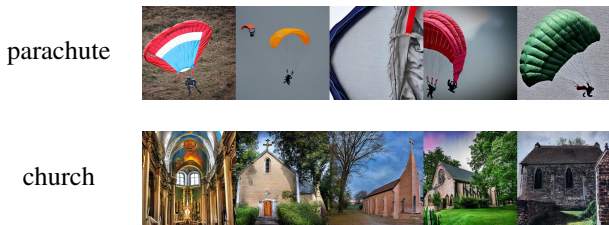

Figure 11: Cases of failed erasing of parachute and church

generation models. Qualitatively, models trained with more natural-language data outperformed CLIP, even if there was no quantitative difference. The scaling effect of U-Net in generating images was also found to be marginal (Saharia et al., 2022). Combining CLIP with other models allows for handling both visual and linguistic information more effectively (Balaji et al., 2023). In Stable Diffusion 3 (Esser et al., 2024), the adoption of three text encoders significantly contributes to faithful generation aligned with prompts, owing to high-quality text embeddings.

We focused on the quality of text conditions in the text-to-image diffusion models. This idea is inspired by the notion that improving the quality of image captions enhances the overall quality of text-to-image generation. Specifically, we intentionally degrade the quality of text embeddings used for conditioning U-Net to attempt concept erasure.

## 6.2. Erasing Concepts from Text-to-Image Diffusion Models

Many image-generation models are trained on a vast amount of data collected from the Internet. Consequently, such datasets often contain undesired images, such as those containing NSFW content or copyrighted material, necessitating measures to address these issues when deploying the models to the market. Several studies have been conducted on methods to remove specific concepts or objects from generated images, many of which involve modify-

ing the weights associated with U-Net, an image generative module (Gandikota et al., 2023; Kumari et al., 2023; Gandikota et al., 2024; Zhang et al., 2023). Some of these methods update the parameters of U-Net itself (Gandikota et al., 2023; Kumari et al., 2023; Zhao et al., 2024), while others update the weights of cross-attention modules conditioning the U-Net (Zhang et al., 2023; Gandikota et al., 2024). There are also methods for investigating the flow of knowledge between U-Net and the text encoder, updating only parts of the text encoder (Basu et al., 2023). Particularly when updating parameters associated with U-Net, there is a possibility of decreasing the image fidelity of the generated models, as well as potential reductions in the transmission capability of conditions. The computational complexity of U-Net can lead to time-consuming concept erasure. Most methods require the anchor concepts like the target concept. These often necessitate human or large language models intervention for their generation, without clear guidelines on their quality.

Since our method automatically sets the anchor concept in accordance with the latent space of the text encoder, the quality of the anchor concept does not affect the ablation result.

## 6.3. Knowledge in Transformer-based Models

Research have progressed in understanding where the knowledge of transformer-based large language models is accumulated. Large language models trained only on natural language are believed to accumulate knowledge in the MLP blocks in the transformer (Meng et al., 2022; Dai et al., 2022; Geva et al., 2021), and updating the parameters of MLP enables knowledge editing (Yao et al., 2022; Dong et al., 2022). However, regarding the text encoder of CLIP trained using both natural language and images, findings also suggesting that knowledge is primarily accumulated in the first self-attention layer (Basu et al., 2023).

We have also obtained results suggesting similar knowl-

edge accumulation in encoder-only models by treating the CLIP text encoder as a transformer-based language model and limiting the parameters to update. Our research suggests that, similar to prior studies, knowledge editing is achievable by updating MLP blocks. We also confirm that more effective concept erasure is possible by updating not only MLP blocks but also the final self-attention layer.

## 7. Conclusion

We interpreted concept erasure from text-to-image diffusion models as the disruption of text-image alignment and introduced a method for achieving this by making minor changes to the text encoder. Our method, which involves making slight modifications to the CLIP text encoder, requires fewer updates compared with current methods. Therefore, concept erasure can be executed very rapidly. When the text encoder undergoes minor changes, it is mapped to concepts that are closer in the latent space of the text encoder, leading to more natural changes than those generated by human-selected anchor concepts. In our experiments, we confirmed that several target concepts disappeared while suppressing the effect on other concepts. By varying the parameters to update, we confirmed that knowledge is primarily accumulated in the MLP blocks of the transformer, consistent with previous research. Like GPT and BERT, it has been suggested that knowledge accumulates in the MLP blocks of the transformer regardless of the training method. We also highlighted the inadequacy of the evaluation metrics used in previous research in the context of machine unlearning, emphasizing the need for proper evaluation.

In terms of future directions, there is potential for developing evaluation metrics for cases in which creating a re-train model is not feasible. While we used a very simple method of gradient ascent, there is scope for applying various other methods. Using saliency maps-based methods, such as SalUn (Fan et al., 2024), could be beneficial, as they adaptively control the updated parameters, potentially leading to more effective editing when combined with our proposed method. By updating the text encoder by using adapter tuning, similar to SPM, it is likely to achieve similar functionality to facilitated transport.

## References

- Balaji, Y., Nah, S., Huang, X., Vahdat, A., Song, J., Zhang, Q., Kreis, K., Aittala, M., Aila, T., Laine, S., Catanzaro, B., Karras, T., and Liu, M.-Y. ediff-i: Text-to-image diffusion models with an ensemble of expert denoisers, 2023.
- Basu, S., Zhao, N., Morariu, V., Feizi, S., and Manjunatha, V. Localizing and editing knowledge in text-to-image generative models, 2023.
- Bommasani, R., Hudson, D. A., Adeli, E., Altman, R., Arora, S., von Arx, S., Bernstein, M. S., Bohg, J., Bosselut, A., Brunskill, E., Brynjolfsson, E., Buch, S., Card, D., Castellon, R., Chatterji, N., Chen, A., Creel, K., Davis, J. Q., Demszky, D., Donahue, C., Doumbouya, M., Durmus, E., Ermon, S., Etchemendy, J., Ethayarajh, K., Fei-Fei, L., Finn, C., Gale, T., Gillespie, L., Goel, K., Goodman, N., Grossman, S., Guha, N., Hashimoto, T., Henderson, P., Hewitt, J., Ho, D. E., Hong, J., Hsu, K., Huang, J., Icard, T., Jain, S., Jurafsky, D., Kalluri, P., Karamcheti, S., Keeling, G., Khani, F., Khattab, O., Koh, P. W., Krass, M., Krishna, R., Kudithipudi, R., Kumar, A., Ladhak, F., Lee, M., Lee, T., Leskovec, J., Levent, I., Li, X. L., Li, X., Ma, T., Malik, A., Manning, C. D., Mirchandani, S., Mitchell, E., Munyikwa, Z., Nair, S., Narayan, A., Narayanan, D., Newman, B., Nie, A., Niebles, J. C., Nilforoshan, H., Nyarko, J., Ogut, G., Orr, L., Papadimitriou, I., Park, J. S., Piech, C., Portelance, E., Potts, C., Raghunathan, A., Reich, R., Ren, H., Rong, F., Roohani, Y., Ruiz, C., Ryan, J., Ré, C., Sadigh, D., Sagawa, S., Santhanam, K., Shih, A., Srinivasan, K., Tamkin, A., Taori, R., Thomas, A. W., Tramèr, F., Wang, R. E., Wang, W., Wu, B., Wu, J., Wu, Y., Xie, S. M., Yasunaga, M., You, J., Zaharia, M., Zhang, M., Zhang, T., Zhang, X., Zhang, Y., Zheng, L., Zhou, K., and Liang, P. On the opportunities and risks of foundation models, 2022.
- Brock, A., Donahue, J., and Simonyan, K. Large scale GAN training for high fidelity natural image synthesis. In *International Conference on Learning Representations*, 2019. URL <https://openreview.net/forum?id=B1xsqj09Fm>.
- Chen, W., Hu, H., LI, Y., Ruiz, N., Jia, X., Chang, M.-W., and Cohen, W. W. Subject-driven text-to-image generation via apprenticeship learning. In *Thirty-seventh Conference on Neural Information Processing Systems*, 2023. URL <https://openreview.net/forum?id=vw3bHyQbX7>.
- Dai, D., Dong, L., Hao, Y., Sui, Z., Chang, B., and Wei, F. Knowledge neurons in pretrained transformers. In Muresan, S., Nakov, P., and Villavicencio, A. (eds.), *Proceedings of the 60th Annual Meeting of the Association for Computational Linguistics (Volume 1: Long Papers)*, pp. 8493–8502, Dublin, Ireland, May 2022. Association for Computational Linguistics. doi: 10.18653/v1/2022.acl-long.581. URL <https://aclanthology.org/2022.acl-long.581>.
- Dai, X., Hou, J., Ma, C.-Y., Tsai, S., Wang, J., Wang, R., Zhang, P., Vandenhende, S., Wang, X., Dubey, A., Yu, M., Kadian, A., Radenovic, F., Mahajan, D., Li, K.,

- Zhao, Y., Petrovic, V., Singh, M. K., Motwani, S., Wen, Y., Song, Y., Sumbaly, R., Ramanathan, V., He, Z., Vajda, P., and Parikh, D. Emu: Enhancing image generation models using photogenic needles in a haystack, 2023.
- Deng, J., Dong, W., Socher, R., Li, L.-J., Li, K., and Fei-Fei, L. Imagenet: A large-scale hierarchical image database. In *2009 IEEE Conference on Computer Vision and Pattern Recognition*, pp. 248–255, 2009. doi: 10.1109/CVPR.2009.5206848.
- Devlin, J., Chang, M.-W., Lee, K., and Toutanova, K. BERT: Pre-training of deep bidirectional transformers for language understanding. In Burstein, J., Doran, C., and Solorio, T. (eds.), *Proceedings of the 2019 Conference of the North American Chapter of the Association for Computational Linguistics: Human Language Technologies, Volume 1 (Long and Short Papers)*, pp. 4171–4186, Minneapolis, Minnesota, June 2019. Association for Computational Linguistics. doi: 10.18653/v1/N19-1423. URL <https://aclanthology.org/N19-1423>.
- Dhariwal, P. and Nichol, A. Q. Diffusion models beat GANs on image synthesis. In Beygelzimer, A., Dauphin, Y., Liang, P., and Vaughan, J. W. (eds.), *Advances in Neural Information Processing Systems*, 2021. URL <https://openreview.net/forum?id=AAWuCVzaVt>.
- Dong, Q., Dai, D., Song, Y., Xu, J., Sui, Z., and Li, L. Calibrating factual knowledge in pretrained language models. In Goldberg, Y., Kozareva, Z., and Zhang, Y. (eds.), *Findings of the Association for Computational Linguistics: EMNLP 2022*, pp. 5937–5947, Abu Dhabi, United Arab Emirates, December 2022. Association for Computational Linguistics. doi: 10.18653/v1/2022.findings-emnlp.438. URL <https://aclanthology.org/2022.findings-emnlp.438>.
- Esser, P., Kulal, S., Blattmann, A., Entezari, R., Müller, J., Saini, H., Levi, Y., Lorenz, D., Sauer, A., Boesel, F., Podell, D., Dockhorn, T., English, Z., Lacey, K., Goodwin, A., Marek, Y., and Rombach, R. Scaling rectified flow transformers for high-resolution image synthesis, 2024.
- Fan, C., Liu, J., Zhang, Y., Wong, E., Wei, D., and Liu, S. Salun: Empowering machine unlearning via gradient-based weight saliency in both image classification and generation. In *The Twelfth International Conference on Learning Representations*, 2024. URL <https://openreview.net/forum?id=gn0mIhQGm>.
- Fei, Z., Fan, M., and Huang, J. Gradient-free textual inversion. In *Proceedings of the 31st ACM International Conference on Multimedia*, MM '23, pp. 1364–1373, New York, NY, USA, 2023. Association for Computing Machinery. ISBN 9798400701085. doi: 10.1145/3581783.3612599. URL <https://doi.org/10.1145/3581783.3612599>.
- Gal, R., Alaluf, Y., Atzmon, Y., Patashnik, O., Bermano, A. H., Chechik, G., and Cohen-or, D. An image is worth one word: Personalizing text-to-image generation using textual inversion. In *The Eleventh International Conference on Learning Representations*, 2023. URL <https://openreview.net/forum?id=NAQvF08TcyG>.
- Gandikota, R., Materzynska, J., Fiotto-Kaufman, J., and Bau, D. Erasing concepts from diffusion models. In *Proceedings of the IEEE/CVF International Conference on Computer Vision (ICCV)*, pp. 2426–2436, October 2023.
- Gandikota, R., Orgad, H., Belinkov, Y., Materzyńska, J., and Bau, D. Unified concept editing in diffusion models. In *Proceedings of the IEEE/CVF Winter Conference on Applications of Computer Vision (WACV)*, pp. 5111–5120, January 2024.
- Geva, M., Schuster, R., Berant, J., and Levy, O. Transformer feed-forward layers are key-value memories. In Moens, M.-F., Huang, X., Specia, L., and Yih, S. W.-t. (eds.), *Proceedings of the 2021 Conference on Empirical Methods in Natural Language Processing*, pp. 5484–5495, Online and Punta Cana, Dominican Republic, November 2021. Association for Computational Linguistics. doi: 10.18653/v1/2021.emnlp-main.446. URL <https://aclanthology.org/2021.emnlp-main.446>.
- Goodfellow, I., Pouget-Abadie, J., Mirza, M., Xu, B., Warde-Farley, D., Ozair, S., Courville, A., and Bengio, Y. Generative adversarial nets. In Ghahramani, Z., Welling, M., Cortes, C., Lawrence, N., and Weinberger, K. (eds.), *Advances in Neural Information Processing Systems*, volume 27. Curran Associates, Inc., 2014. URL [https://proceedings.neurips.cc/paper\\_files/paper/2014/file/5ca3e9b122f61f8f06494c97b1afccf3-Paper.pdf](https://proceedings.neurips.cc/paper_files/paper/2014/file/5ca3e9b122f61f8f06494c97b1afccf3-Paper.pdf).
- Hessel, J., Holtzman, A., Forbes, M., Le Bras, R., and Choi, Y. CLIPScore: A reference-free evaluation metric for image captioning. In Moens, M.-F., Huang, X., Specia, L., and Yih, S. W.-t. (eds.), *Proceedings of the 2021 Conference on Empirical Methods in Natural Language Processing*, pp. 7514–7528, Online and Punta Cana, Dominican Republic, November 2021. Association for Computational Linguistics. doi: 10.18653/v1/2021.emnlp-main.595. URL <https://aclanthology.org/2021.emnlp-main.595>.

- Heusel, M., Ramsauer, H., Unterthiner, T., Nessler, B., and Hochreiter, S. Gans trained by a two time-scale update rule converge to a local nash equilibrium. In Guyon, I., Luxburg, U. V., Bengio, S., Wallach, H., Fergus, R., Vishwanathan, S., and Garnett, R. (eds.), *Advances in Neural Information Processing Systems*, volume 30. Curran Associates, Inc., 2017. URL [https://proceedings.neurips.cc/paper\\_files/paper/2017/file/8a1d694707eb0fefe65871369074926d-Paper.pdf](https://proceedings.neurips.cc/paper_files/paper/2017/file/8a1d694707eb0fefe65871369074926d-Paper.pdf).
- Ho, J. and Salimans, T. Classifier-free diffusion guidance. In *NeurIPS 2021 Workshop on Deep Generative Models and Downstream Applications*, 2021. URL <https://openreview.net/forum?id=qw8AKxfYbI>.
- Ho, J., Jain, A., and Abbeel, P. Denoising diffusion probabilistic models. In Larochelle, H., Ranzato, M., Hadsell, R., Balcan, M., and Lin, H. (eds.), *Advances in Neural Information Processing Systems*, volume 33, pp. 6840–6851. Curran Associates, Inc., 2020. URL [https://proceedings.neurips.cc/paper\\_files/paper/2020/file/4c5bcfec8584af0d967f1ab10179ca4b-Paper.pdf](https://proceedings.neurips.cc/paper_files/paper/2020/file/4c5bcfec8584af0d967f1ab10179ca4b-Paper.pdf).
- Ho, J., Saharia, C., Chan, W., Fleet, D. J., Norouzi, M., and Salimans, T. Cascaded diffusion models for high fidelity image generation. *Journal of Machine Learning Research*, 23(47):1–33, 2022. URL <http://jmlr.org/papers/v23/21-0635.html>.
- Howard, J. and Gugger, S. Fastai: A layered api for deep learning. *Information*, 11(2), 2020. ISSN 2078-2489. doi: 10.3390/info11020108. URL <https://www.mdpi.com/2078-2489/11/2/108>.
- Hu, E. J., yelong shen, Wallis, P., Allen-Zhu, Z., Li, Y., Wang, S., Wang, L., and Chen, W. LoRA: Low-rank adaptation of large language models. In *International Conference on Learning Representations*, 2022. URL <https://openreview.net/forum?id=nZeVKeeFYf9>.
- Jang, J., Yoon, D., Yang, S., Cha, S., Lee, M., Logeswaran, L., and Seo, M. Knowledge unlearning for mitigating privacy risks in language models. In Rogers, A., Boyd-Graber, J., and Okazaki, N. (eds.), *Proceedings of the 61st Annual Meeting of the Association for Computational Linguistics (Volume 1: Long Papers)*, pp. 14389–14408, Toronto, Canada, July 2023. Association for Computational Linguistics. doi: 10.18653/v1/2023.acl-long.805. URL <https://aclanthology.org/2023.acl-long.805>.
- Jayasumana, S., Ramalingam, S., Veit, A., Glasner, D., Chakrabarti, A., and Kumar, S. Rethinking fid: Towards a better evaluation metric for image generation, 2023.
- Jia, J., Liu, J., Ram, P., Yao, Y., Liu, G., Liu, Y., Sharma, P., and Liu, S. Model sparsity can simplify machine unlearning. In *Thirty-seventh Conference on Neural Information Processing Systems*, 2023. URL <https://openreview.net/forum?id=0jzH883i34>.
- Karras, T., Laine, S., Aittala, M., Hellsten, J., Lehtinen, J., and Aila, T. Analyzing and improving the image quality of stylegan. In *Proceedings of the IEEE/CVF Conference on Computer Vision and Pattern Recognition (CVPR)*, June 2020.
- Kingma, D. P. and Ba, J. Adam: A method for stochastic optimization, 2017.
- Kumari, N., Zhang, B., Wang, S.-Y., Shechtman, E., Zhang, R., and Zhu, J.-Y. Ablating concepts in text-to-image diffusion models. In *Proceedings of the IEEE/CVF International Conference on Computer Vision (ICCV)*, pp. 22691–22702, October 2023.
- Li, Y., Liu, X., Kag, A., Hu, J., Idelbayev, Y., Sagar, D., Wang, Y., Tulyakov, S., and Ren, J. Textcrafter: Your text encoder can be image quality controller, 2024.
- Liu, L., Ren, Y., Lin, Z., and Zhao, Z. Pseudo numerical methods for diffusion models on manifolds. In *International Conference on Learning Representations*, 2022. URL <https://openreview.net/forum?id=PlKWvd2yBkY>.
- Lu, S., Wang, Z., Li, L., Liu, Y., and Kong, A. W.-K. Mace: Mass concept erasure in diffusion models, 2024.
- Lyu, M., Yang, Y., Hong, H., Chen, H., Jin, X., He, Y., Xue, H., Han, J., and Ding, G. One-dimensional adapter to rule them all: Concepts, diffusion models and erasing applications, 2023.
- Meng, K., Bau, D., Andonian, A., and Belinkov, Y. Locating and editing factual associations in gpt. In Koyejo, S., Mohamed, S., Agarwal, A., Belgrave, D., Cho, K., and Oh, A. (eds.), *Advances in Neural Information Processing Systems*, volume 35, pp. 17359–17372. Curran Associates, Inc., 2022.
- OpenAI. Improving image generation with better captions, 2023a.
- OpenAI. Gpt-4 technical report, 2023b.
- Otani, M., Togashi, R., Sawai, Y., Ishigami, R., Nakashima, Y., Rahtu, E., Heikkilä, J., and Satoh, S. Toward verifiable and reproducible human evaluation for text-to-image generation. In *Proceedings of the IEEE/CVF*

- Conference on Computer Vision and Pattern Recognition (CVPR)*, pp. 14277–14286, June 2023.
- Pang, L., Yin, J., Xie, H., Wang, Q., Li, Q., and Mao, X. Cross initialization for personalized text-to-image generation, 2023.
- Podell, D., English, Z., Lacey, K., Blattmann, A., Dockhorn, T., Müller, J., Penna, J., and Rombach, R. SDXL: Improving latent diffusion models for high-resolution image synthesis. In *The Twelfth International Conference on Learning Representations*, 2024. URL <https://openreview.net/forum?id=di52zR8xgf>.
- Radford, A., Kim, J. W., Hallacy, C., Ramesh, A., Goh, G., Agarwal, S., Sastry, G., Askell, A., Mishkin, P., Clark, J., Krueger, G., and Sutskever, I. Learning transferable visual models from natural language supervision. In Meila, M. and Zhang, T. (eds.), *Proceedings of the 38th International Conference on Machine Learning*, volume 139 of *Proceedings of Machine Learning Research*, pp. 8748–8763. PMLR, 18–24 Jul 2021. URL <https://proceedings.mlr.press/v139/radford21a.html>.
- Raffel, C., Shazeer, N., Roberts, A., Lee, K., Narang, S., Matena, M., Zhou, Y., Li, W., and Liu, P. J. Exploring the limits of transfer learning with a unified text-to-text transformer. *J. Mach. Learn. Res.*, 21(1), jan 2020. ISSN 1532-4435.
- Ramesh, A., Dhariwal, P., Nichol, A., Chu, C., and Chen, M. Hierarchical text-conditional image generation with clip latents, 2022.
- Rombach, R., Blattmann, A., Lorenz, D., Esser, P., and Ommer, B. High-resolution image synthesis with latent diffusion models. In *Proceedings of the IEEE/CVF Conference on Computer Vision and Pattern Recognition (CVPR)*, pp. 10684–10695, June 2022.
- Ronneberger, O., Fischer, P., and Brox, T. U-net: Convolutional networks for biomedical image segmentation. In Navab, N., Hornegger, J., Wells, W. M., and Frangi, A. F. (eds.), *Medical Image Computing and Computer-Assisted Intervention – MICCAI 2015*, pp. 234–241, Cham, 2015. Springer International Publishing. ISBN 978-3-319-24574-4.
- Ruiz, N., Li, Y., Jampani, V., Pritch, Y., Rubinstein, M., and Aberman, K. Dreambooth: Fine tuning text-to-image diffusion models for subject-driven generation. In *Proceedings of the IEEE/CVF Conference on Computer Vision and Pattern Recognition (CVPR)*, pp. 22500–22510, June 2023.
- Saharia, C., Chan, W., Saxena, S., Li, L., Whang, J., Denton, E., Ghasemipour, S. K. S., Gontijo-Lopes, R., Ayan, B. K., Salimans, T., Ho, J., Fleet, D. J., and Norouzi, M. Photorealistic text-to-image diffusion models with deep language understanding. In Oh, A. H., Agarwal, A., Belgrave, D., and Cho, K. (eds.), *Advances in Neural Information Processing Systems*, 2022. URL <https://openreview.net/forum?id=08Yk-n5l2Al>.
- Schuhmann, C., Beaumont, R., Vencu, R., Gordon, C. W., Wightman, R., Cherti, M., Coombes, T., Katta, A., Mullis, C., Wortsman, M., Schramowski, P., Kundurthy, S. R., Crowson, K., Schmidt, L., Kaczmarczyk, R., and Jitsev, J. LAION-5b: An open large-scale dataset for training next generation image-text models. In *Thirty-sixth Conference on Neural Information Processing Systems Datasets and Benchmarks Track*, 2022. URL <https://openreview.net/forum?id=M3Y74vmsMcY>.
- Sohl-Dickstein, J., Weiss, E., Maheswaranathan, N., and Ganguli, S. Deep unsupervised learning using nonequilibrium thermodynamics. In Bach, F. and Blei, D. (eds.), *Proceedings of the 32nd International Conference on Machine Learning*, volume 37 of *Proceedings of Machine Learning Research*, pp. 2256–2265, Lille, France, 07–09 Jul 2015. PMLR. URL <https://proceedings.mlr.press/v37/sohl-dickstein15.html>.
- Song, J., Meng, C., and Ermon, S. Denoising diffusion implicit models. In *International Conference on Learning Representations*, 2021. URL <https://openreview.net/forum?id=St1giarCHLP>.
- Thudi, A., Deza, G., Chandrasekaran, V., and Papernot, N. Unrolling sgd: Understanding factors influencing machine unlearning. In *2022 IEEE 7th European Symposium on Security and Privacy (EuroS&P)*, pp. 303–319. IEEE, 2022.
- van der Maaten, L. and Hinton, G. Visualizing data using t-sne. *Journal of Machine Learning Research*, 9 (86):2579–2605, 2008. URL <http://jmlr.org/papers/v9/vandermaaten08a.html>.
- Wang, Y., Yao, Q., Kwok, J. T., and Ni, L. M. Generalizing from a few examples: A survey on few-shot learning. *ACM Comput. Surv.*, 53(3), jun 2020. ISSN 0360-0300. doi: 10.1145/3386252. URL <https://doi.org/10.1145/3386252>.
- Wei, Y., Zhang, Y., Ji, Z., Bai, J., Zhang, L., and Zuo, W. Elite: Encoding visual concepts into textual embeddings for customized text-to-image generation. In *Proceedings of the IEEE/CVF International Conference on Computer Vision (ICCV)*, pp. 15943–15953, October 2023.

- Weiss, M., Rahaman, N., Locatello, F., Pal, C., Bengio, Y., Schölkopf, B., Li, L. E., and Ballas, N. Neural attentive circuits. In Oh, A. H., Agarwal, A., Belgrave, D., and Cho, K. (eds.), *Advances in Neural Information Processing Systems*, 2022. URL <https://openreview.net/forum?id=q41xK9Bunq1>.
- Xue, Z., Song, G., Guo, Q., Liu, B., Zong, Z., Liu, Y., and Luo, P. RAPHAEL: Text-to-image generation via large mixture of diffusion paths. In *Thirty-seventh Conference on Neural Information Processing Systems*, 2023. URL <https://openreview.net/forum?id=jUdZCcoOu3>.
- Yao, Y., Huang, S., Dong, L., Wei, F., Chen, H., and Zhang, N. Kformer: Knowledge injection in transformer feed-forward layers. In *CCF International Conference on Natural Language Processing and Chinese Computing*, pp. 131–143. Springer, 2022.
- Zhang, E., Wang, K., Xu, X., Wang, Z., and Shi, H. Forget-me-not: Learning to forget in text-to-image diffusion models, 2023.
- Zhang, Q. and Chen, Y. Fast sampling of diffusion models with exponential integrator. In *The Eleventh International Conference on Learning Representations*, 2023. URL <https://openreview.net/forum?id=Loek7hfb46P>.
- Zhang, R., Isola, P., Efros, A. A., Shechtman, E., and Wang, O. The unreasonable effectiveness of deep features as a perceptual metric. In *Proceedings of the IEEE Conference on Computer Vision and Pattern Recognition (CVPR)*, June 2018.
- Zhang, X., Wei, X.-Y., Zhang, W., Wu, J., Zhang, Z., Lei, Z., and Li, Q. A survey on personalized content synthesis with diffusion models, 2024.
- Zhao, M., Zhang, L., Zheng, T., Kong, Y., and Yin, B. Separable multi-concept erasure from diffusion models, 2024.

## A. Preliminaries

### A.1. Diffusion Models

Denosing diffusion models consist of two processes: forward and reverse process. In the forward process, the noise is gradually added to the input data  $x_0$ , eventually resulting in pure Gaussian noise. In the reverse process, starting from Gaussian noise, the model predicts the noise added at each time step  $t \in [0, T]$ .

### A.2. Anchor Concepts

We refer to concept  $B$  as the anchor concept when transitioning from concept  $A$  to concept  $B$ . For example, with UCE (Gandikota et al., 2024), the following optimization problem is formulated.

$$\min_W \sum_{i=0}^m \|Wc_i - \underbrace{v_i^*}_{W^{\text{old}}c_i^*}\|_2^2 + \lambda \|W - W^{\text{old}}\|_F^2$$

Here,  $W$  is the projection matrix,  $c_i$  is the text embedding of the prompt containing the concepts to be erased (e.g. “Van Gogh style”), and  $c_i^*$  is also text embeddings taken from the destination prompt (e.g. “art”). In this case, we consider  $c_i^*$  to be the anchor concept.

As another example, we consider Ablating Concepts (Kumari et al., 2023). The method is formulated as a model-based approach as follows.

$$\arg \min_{\varepsilon_\theta} \mathbb{E}_{\mathbf{x}_t, \mathbf{c}, \mathbf{c}^*, t} [w_t \|\varepsilon_{\theta_{\text{fixed}}}(\mathbf{x}_t, \mathbf{c}, t) - \varepsilon_\theta(\mathbf{x}_t, \mathbf{c}^*, t)\|_2^2]$$

where  $c$  is a random prompt for the anchor concept (e.g. “cat”) and  $c^*$  is modified from  $c$  to include the target concept (e.g. “Grumpy Cat”). In this case,  $c^*$  is the anchor concept.

### A.3. Retrain Model

We refer to a “retrain model” as one that is trained on a training dataset from which the forgetting dataset has been removed. Specifically, let  $\mathcal{D}$  denote the training datasets and  $\mathcal{D}_f \subseteq \mathcal{D}$  is the forgetting datasets. As an example, we assume a text-to-image model has been trained on LAION-5B and want to erase the concept of “Grumpy Cat”. In this case, LAION-5B is  $\mathcal{D}$  and the subset of LAION-5B, the elements of which contain “Grumpy Cat”, is  $\mathcal{D}_f$ . The  $\mathcal{D}_r = \mathcal{D} \setminus \mathcal{D}_f$ , which is  $\mathcal{D}_f$  removed from  $\mathcal{D}$ , denote the remaining datasets, and the model trained using  $\mathcal{D}_r$  is called a retrain model.

## B. Updated Layers

Table 4 shows the names of the updated layers.

## C. Experimental Details

### C.1. Environments

We conducted all experiments on a single NVIDIA RTX A5000. Our software environments were PyTorch 1.13.1, diffusers 0.21.4, and transformers 4.34.0.

### C.2. Baselines

We describe the baselines used in our experiments.

- ESD (Gandikota et al., 2023): This method updates the parameters related to U-Net. It prepares two outputs: one from Original SD and the other from the fine-tuned model. The fine-tuned model is updated using the L2 Loss of each output. We use ESD-x-1, which updates the parameters related to cross-attention.

Table 4: List of the updated layer name with our method.

Layer Name
text_model.encoder.layers.0.mlp.fc1
text_model.encoder.layers.0.mlp.fc2
text_model.encoder.layers.1.mlp.fc1
text_model.encoder.layers.1.mlp.fc2
text_model.encoder.layers.2.mlp.fc1
text_model.encoder.layers.2.mlp.fc2
text_model.encoder.layers.3.mlp.fc1
text_model.encoder.layers.3.mlp.fc2
text_model.encoder.layers.4.mlp.fc1
text_model.encoder.layers.4.mlp.fc2
text_model.encoder.layers.5.mlp.fc1
text_model.encoder.layers.5.mlp.fc2
text_model.encoder.layers.6.mlp.fc1
text_model.encoder.layers.6.mlp.fc2
text_model.encoder.layers.7.mlp.fc1
text_model.encoder.layers.7.mlp.fc2
text_model.encoder.layers.8.mlp.fc1
text_model.encoder.layers.8.mlp.fc2
text_model.encoder.layers.9.mlp.fc1
text_model.encoder.layers.9.mlp.fc2
text_model.encoder.layers.10.mlp.fc1
text_model.encoder.layers.10.mlp.fc2
text_model.encoder.layers.11.mlp.fc1
text_model.encoder.layers.11.mlp.fc2
text_model.encoder.layers.11.self_attn.k_proj
text_model.encoder.layers.11.self_attn.v_proj
text_model.encoder.layers.11.self_attn.k_proj
text_model.encoder.layers.11.self_attn.out_proj



- UCE (Gandikota et al., 2024): This method updates the weights of the cross-attention in U-Net by closed-form. Unlike ESD, it does not require the output of the Original SD. In the experiments, we used anchor concepts generated by ChatGPT.
- SPM (Lyu et al., 2023): This method uses adapter tuning using LoRA (Hu et al., 2022) for the U-Net attention module. Therefore, transferring erased model to another model is easy.

### C.3. Implementation Details of Baselines

We describe the details of the baseline implementations.

- **ESD-x**: We used the original implementation using diffusers<sup>7</sup>. Following the original paper, the learning rate was set to  $10^{-5}$ , number of iterations was 1,000, and  $\eta = 1$ .
- **UCE**: We used the original implementation<sup>8</sup>. The hyperparameters, except anchor concept, were those provided in the official implementation. The anchor concept was generated by ChatGPT<sup>9</sup> for each concept. The prompt given to ChatGPT was when the erased concepts is "{TARGET CONCEPT}", what concepts to guide the erased concepts towards? Answer the one concept name.
- **SPM**: We used the original implementation<sup>10</sup>. For configuration of training, we used the provided configuration<sup>11</sup>. When generating the images, we did not use the negative prompt for fair comparison with other methods. The setting of the generation phase is described in Section 3.2.

### C.4. Implementation Details of Our Proposed Method

We used CLIP ImageNet Template to erase the concepts. This template is separated into object and style. We list the details of the templates in Tables 5 and 6. These prompts are also used in textual inversion for diffusers<sup>12</sup>. When updating the text encoder, prompts are randomly chosen for each iteration.

## D. Additional Results

In this section, we present the results of further qualitative evaluation. Comparisons with current methods and further results of the proposed method only are presented.

### D.1. Additional Comparison

Table 7 shows the target concepts, the anchor concepts used with UCE, and the prompts used during generation.

Figure 12 shows the results of erasing ‘‘Snoopy’’. Since the motif of Snoopy is a dog, it can be considered that the proposed method has transitioned to a concept close to it. Additionally, ESD-x-1 resulted in the absence of Snoopy, which is speculated to differ from the retrain results we consider as ground truth. Although the results of UCE were mapped by the concept ‘‘Peanuts’’, it is difficult to argue that the ‘‘cyberpunk style’’ was adequately reflected.

Figure 13 shows the results of erasing ‘‘Grumpy Cat’’. ESD-x-1 generated an image of an unrelated building. Both SPM and UCE showed a significant decrease in generation quality. As shown in Figure 3, UCE maintained the quality of concept erasure and target concept generation when given an appropriate anchor concept. However, in this case, since ‘‘Internet Meme’’ is the anchor concept, it resulted in such a generation. ‘‘Internet Meme’’ was an anchor concept generated by ChatGPT, but whether such anchor concepts are appropriate depends on the knowledge of the human or model used to generate them.

<sup>7</sup><https://huggingface.co/spaces/baulab/Erasing-Concepts-In-Diffusion/tree/main>

<sup>8</sup><https://github.com/rohitgandikota/unified-concept-editing/tree/main>

<sup>9</sup><https://chat.openai.com/>

<sup>10</sup><https://github.com/Con6924/SPM/tree/main>

<sup>11</sup><https://github.com/Con6924/SPM/blob/main/configs/snoopy/config.yaml>

<sup>12</sup>[https://github.com/huggingface/diffusers/blob/main/examples/textual\\_inversion/textual\\_inversion.py](https://github.com/huggingface/diffusers/blob/main/examples/textual_inversion/textual_inversion.py)

Table 5: List of prompts used when erasing object

Object Prompt
a photo of a {Object Name}
a rendering of a {Object Name}
a cropped photo of the {Object Name}
the photo of a {Object Name}
a photo of a clean {Object Name}
a photo of a dirty {Object Name}
a dark photo of the {Object Name}
a photo of my {Object Name}
a photo of the cool {Object Name}
a close-up photo of a {Object Name}
a bright photo of the {Object Name}
a cropped photo of a {Object Name}
a photo of the {Object Name}
a good photo of the {Object Name}
a photo of one {Object Name}
a close-up photo of the {Object Name}
a rendition of the {Object Name}
a photo of the clean {Object Name}
a rendition of a {Object Name}
a photo of a nice {Object Name}
a good photo of a {Object Name}
a photo of the nice {Object Name}
a photo of the small {Object Name}
a photo of the weird {Object Name}
a photo of the large {Object Name}
a photo of a cool {Object Name}
a photo of a small {Object Name}

Table 6: List of prompts used when erasing style

Style Prompt
a painting in the style of {Style Name}
a rendering in the style of {Style Name}
a cropped painting in the style of {Style Name}
the painting in the style of {Style Name}
a clean painting in the style of {Style Name}
a dirty painting in the style of {Style Name}
a dark painting in the style of {Style Name}
a picture in the style of {Style Name}
a cool painting in the style of {Style Name}
a close-up painting in the style of {Style Name}
a bright painting in the style of {Style Name}
a cropped painting in the style of {Style Name}
a good painting in the style of {Style Name}
a close-up painting in the style of {Style Name}
a rendition in the style of {Style Name}
a nice painting in the style of {Style Name}
a small painting in the style of {Style Name}
a weird painting in the style of {Style Name}
a large painting in the style of {Style Name}

Table 7: List of target concepts, anchor concepts, and prompts in generating

Target Concept	Anchor Concept (UCE)	Prompt in Generating
Snoopy	Peanuts	Snoopy in cyberpunk style
Grumpy Cat	Internet Meme	A Grumpy cat laying in the sun.
Mickey Mouse	Disney	drawing of Mickey Mouse walking along the river.
R2D2	Star Wars	portrait of R2D2
Gogh Style	Post-Impressionism	Painting of trees in bloom in the style of Van Gogh.

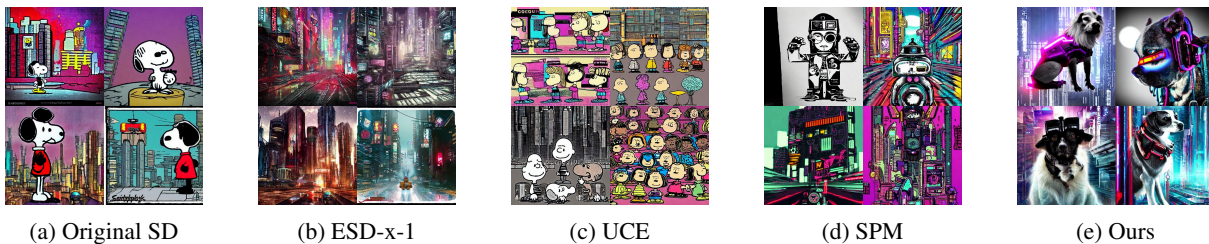

Figure 12: Comparison of generated images when erasing ‘‘Snoopy’’

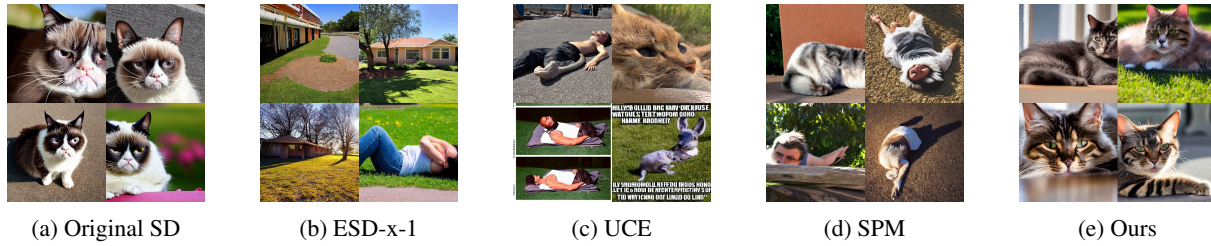

Figure 13: Comparison of generated images when erasing “Grumpy Cat”

Figure 14 presents the results of erasing “Mickey Mouse”. ESD-x-1 seemed to disregard the target concept, resulting in images more aligned with “drawing” and “river” present in the prompt. Intuitively, something other than Mickey Mouse should be “walking along the river”. Additionally, both SPM and UCE occasionally produced images reminiscent of “Mickey Mouse”.

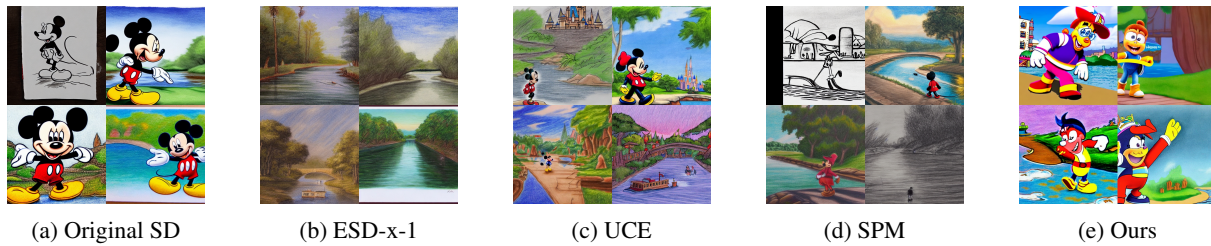

Figure 14: Comparison of generated images when erasing “Mickey Mouse”

Figure 15 illustrates the results of erasing “R2D2”. While UCE produced images related to “Star Wars”, it is worth noting that specifying proper nouns as anchor concepts becomes inappropriate when attempting to erase multiple concepts. As the number of concepts to erase increases, it becomes challenging for humans to designate anchor concepts while considering their relationships. This difficulty also applies when using large language models.

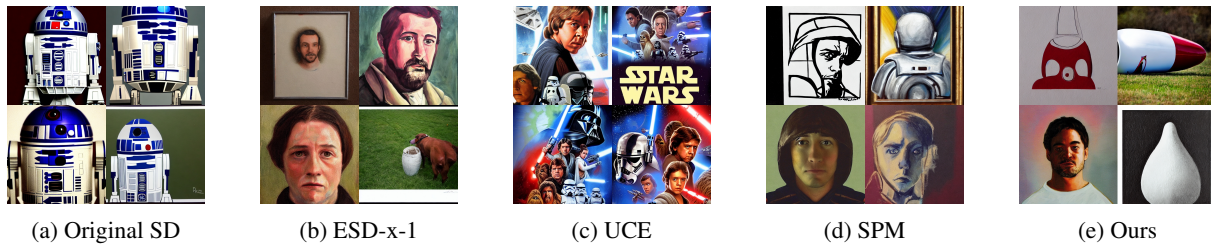

Figure 15: Comparison of generated images when erasing “R2D2”

Figure 16 shows the result of erasing the “Gogh style”. It is difficult to say that the Gogh style was completely erased because UCE output starry night, which is strongly associated with Gogh.

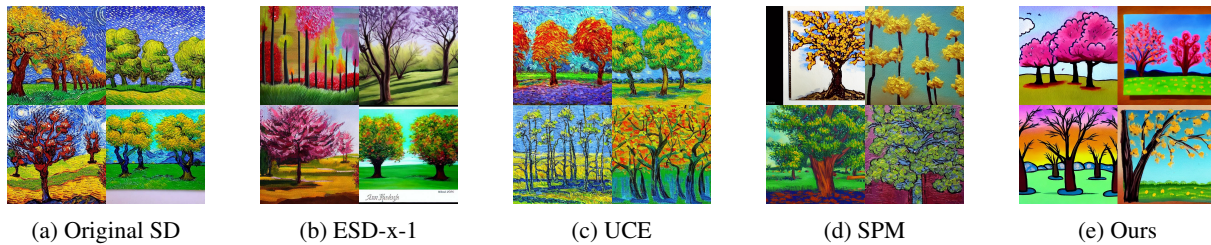

Figure 16: Comparison of generated images when erasing “Van Gogh style”

## D.2. Additional Results of Our Method

We present the results without comparing them with other methods. The purpose is solely to demonstrate the performance of our proposed method. We used all classes of Imagenette (Howard & Gugger, 2020), which is a subset of ImageNet. We generated ten images for each class. The caption we used was “a photo of a {class name}”. In Figures 17-26 show the comparisons between before and after erasing.

Our proposed method demonstrates highly effective erasure performance even for objects containing common nouns such as those in Imagenette.

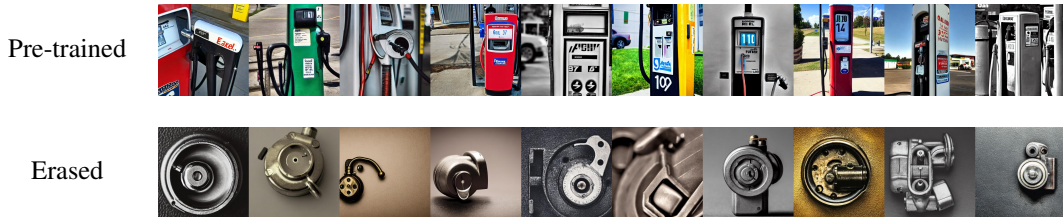

Figure 17: Generated images of gas pump



Figure 18: Generated images of cassette player

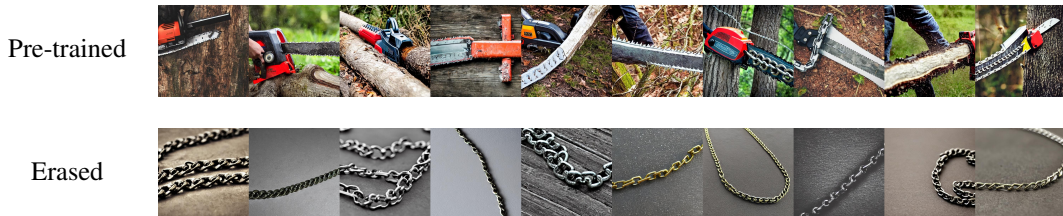

Figure 19: Generated images of chainsaw



Figure 20: Generated images of church

## D.3. Transferability

Our proposed method updates the text encoder. Therefore, it can transfer the erased model to other text-to-image diffusion models that use the same text encoder. We confirm the transferability to other text-to-image diffusion models. We used Stable Diffusion 1.4<sup>13</sup> with VAE and U-Net. The text encoder is the model from which “Snoopy” was erased. Figure 27

<sup>13</sup><https://huggingface.co/CompVis/stable-diffusion-v1-4>



Figure 21: Generated images of tench (a type of fish)

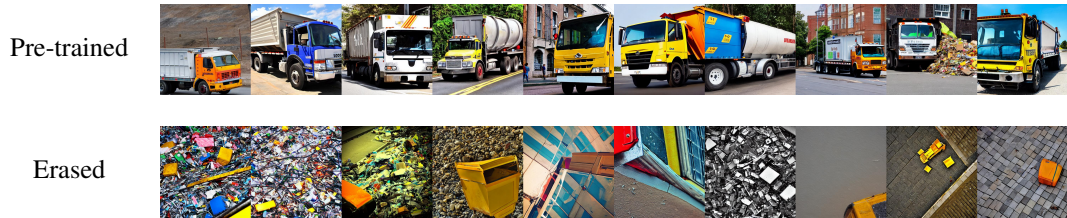

Figure 22: Generated images of garbage truck

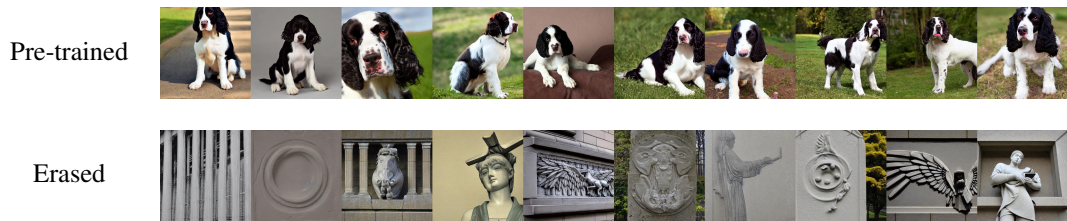

Figure 23: Generated images of English springer

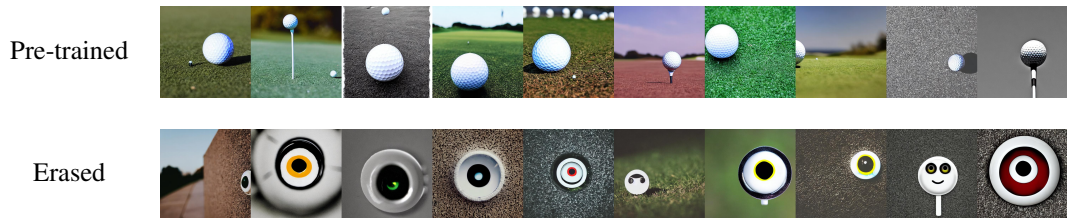

Figure 24: Generated images of golf ball

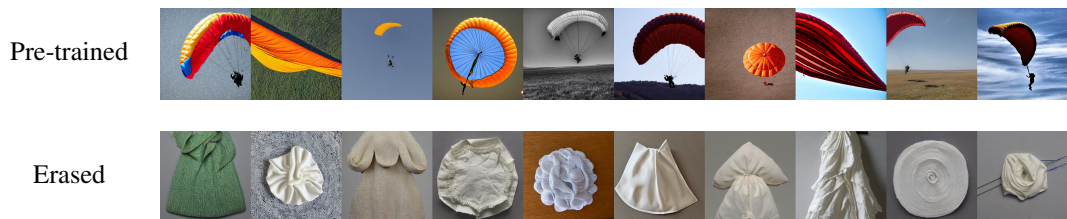

Figure 25: Generated images of parachute

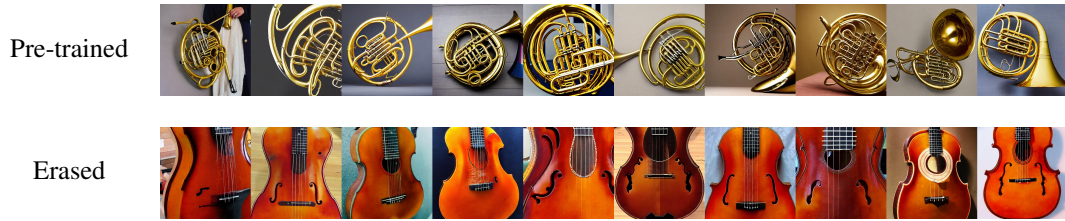

Figure 26: Generated images of French horn

shows the results. Once a concept is erased from the text encoder, we can be sure that the concept is also erased from the model using the same text encoder.



(a) Snoopy in cyberpunk style.



(b) a photo of Eiffel Tower.

Figure 27: Generated images using the text encoder from which “Snoopy” was erased with Stable Diffusion 1.4.

We used DreamShaper<sup>14</sup> for community models. We used DEIS Scheduler (Zhang & Chen, 2023) with 25 inference steps. Figure 28 shows the results before and after erasing “Eiffel Tower”. Because of the erasure of the Eiffel Tower from the text encoder, it was erased from the generated image.

<sup>14</sup><https://huggingface.co/Lykon/DreamShaper>



(a) Using text encoder from which “Eiffel Tower” was not erased



(b) Using text encoder from which “Eiffel Tower” was erased

Figure 28: Generated images before and after erasing “Eiffel Tower” with DreamShaper