







Certified MaxSAT Preprocessing

Extended version including appendix

Hannes Ihalainen¹✉, Andy Oertel^{2,3}, Yong Kiam Tan⁴, Jeremias Berg¹, Matti Järvisalo¹, Magnus O. Myreen⁵, and Jakob Nordström^{3,2}

¹ Department of Computer Science, University of Helsinki, Helsinki, Finland

{hannes.ihalainen, jeremias.berg, matti.jarvisalo}@helsinki.fi

² Lund University, Lund, Sweden

andy.oertel@cs.lth.se

³ University of Copenhagen, Copenhagen, Denmark

jn@di.ku.dk

⁴ Institute for Infocomm Research (I²R), A*STAR, Singapore

tanyk1@i2r.a-star.edu.sg

⁵ Chalmers University of Technology, Gothenburg, Sweden

myreen@chalmers.se

Abstract. Building on the progress in Boolean satisfiability (SAT) solving over the last decades, maximum satisfiability (MaxSAT) has become a viable approach for solving NP-hard optimization problems, but ensuring correctness of MaxSAT solvers has remained an important concern. For SAT, this is largely a solved problem thanks to the use of proof logging, meaning that solvers emit machine-verifiable proofs of (un)satisfiability to certify correctness. However, for MaxSAT, proof logging solvers have started being developed only very recently. Moreover, these nascent efforts have only targeted the core solving process, ignoring the preprocessing phase where input problem instances can be substantially reformulated before being passed on to the solver proper.

In this work, we demonstrate how pseudo-Boolean proof logging can be used to certify the correctness of a wide range of modern MaxSAT preprocessing techniques. By combining and extending the VERIPB and CAKEPB tools, we provide formally verified, end-to-end proof checking that the input and preprocessed output MaxSAT problem instances have the same optimal value. An extensive evaluation on applied MaxSAT benchmarks shows that our approach is feasible in practice.

Keywords: maximum satisfiability · preprocessing · proof logging · formally verified proof checking

1 Introduction

The development of Boolean satisfiability (SAT) solvers is arguably one of the true success stories of modern computer science—today, SAT solvers are routinely used as core engines in many types of complex automated reasoning systems. One example of this is SAT-based optimization, usually referred to as

maximum satisfiability (MaxSAT) solving. The improved performance of SAT solvers, coupled with increasingly sophisticated techniques for using SAT solver calls to reason about optimization problems, have made MaxSAT solvers a powerful tool for tackling real-world NP-hard optimization problems [8].

Modern MaxSAT solvers are quite intricate pieces of software, however, and it has been shown repeatedly in the MaxSAT evaluations [51] that even the best solvers sometimes report incorrect results. This was previously a serious issue also for SAT solvers (see, e.g., [13]), but the SAT community has essentially eliminated this problem by requiring that solvers should be *certifying* [1,53], i.e., not only report whether a given formula is satisfiable or unsatisfiable but also produce a machine-verifiable proof that this conclusion is correct. Many different SAT proof formats such as RUP [33], TRACECHECK [7], GRIT [17], and LRAT [16] have been proposed, with DRAT [35,36,74] established as the de facto standard; for the last ten years, proof logging has been compulsory in the (main track of the) SAT competitions [66]. It is all the more striking, then, that until recently no similar developments have been observed in MaxSAT solving.

1.1 Previous Work

A first natural question to ask—since MaxSAT solvers are based on repeated calls to SAT solvers—is whether SAT proof logging techniques could be used for MaxSAT. Although clausal proof systems such as DRAT could in principle certify MaxSAT reasoning, the overhead of translating claims about the cost of solutions into disjunctive clauses that DRAT reasons with seems too large to be feasible in practice.

While there have been several attempts to design proof logging methods specifically for MaxSAT solving [11,24,39,44,57,58,63,64,65], none of these has come close to providing a general proof logging solution, because they apply only for very specific algorithm implementations and/or fail to capture the full range of techniques used. Recent papers have instead proposed using pseudo-Boolean proof logging with VERIPB [9,32] to certify correctness of so-called solution-improving solvers [72] and core-guided solvers [4]. Although these works demonstrate, for the first time, practical proof logging for modern MaxSAT solving, the methods developed thus far only apply to the core solving process. This ignores the MaxSAT preprocessing phase, where the input formula can undergo major reformulation. State-of-the-art solvers sometimes use stand-alone preprocessor tools, or sometimes integrate preprocessing-style reasoning more tightly within the MaxSAT solver engine, to speed up the search for optimal solutions. Some of these preprocessing techniques are lifted from SAT to MaxSAT, but there are also native MaxSAT preprocessing methods that reason about the objective function being optimized and therefore lack analogies in SAT solving.

1.2 Our Contribution

In this paper, we show, for the first time, how to use pseudo-Boolean proof logging with VERIPB to produce proofs of correctness for a wide range of prepro-

cessing techniques used in modern MaxSAT solvers. VERIPB proof logging has previously been successfully used not only for core MaxSAT search as discussed above, but also for advanced SAT solving techniques (including symmetry breaking) [9,27,32], subgraph solving [28,29,30], constraint programming [23,31,54,55], and 0–1 ILP presolving [37], and we add MaxSAT preprocessing to this list.

In order to do so, we extend the VERIPB proof format to include an output section where a reformulated output can be presented, and where the pseudo-Boolean proof establishes that this output formula and the input formula are *equioptimal*, i.e., have optimal solutions of the same value. We also enhance CAKEPB [10,29]—a verified proof checker for pseudo-Boolean proofs—to handle proofs of reformulation. In this way, we obtain a formally verified toolchain for certified preprocessing of MaxSAT instances.

It is worth noting that, although preprocessing is also a critical component in SAT solving, we are not aware of any proof logging tool that supports proofs of correctness even for reformulated decision problems, meaning that formulas are *equisatisfiable*—the DRAT format and tools support proofs that satisfiability of an input CNF formula F implies satisfiability of an output CNF formula G but not the converse direction (except in the special case where F is a subset of G). To the best of our knowledge, our work presents the first practical tool for proving (two-way) equisatisfiability or equioptimality of reformulated problems.

We have performed computational experiments running a MaxSAT preprocessor with proof logging and proof checking on benchmarks from the MaxSAT evaluations. Although there is certainly room for improvements in performance, these experiments provide empirical evidence for the feasibility of certified preprocessing for real-world MaxSAT benchmarks.

1.3 Organization of This Paper

After reviewing preliminaries in Section 2, we explain our pseudo-Boolean proof logging for MaxSAT preprocessing in Section 3, and Section 4 discusses verified proof checking. We present results from a computational evaluation in Section 5, after which we conclude with a summary and outlook for future work in Section 6.

2 Preliminaries

We write x to denote a Boolean variable, which we think of as $\{0, 1\}$ -valued, and write \bar{x} as a shorthand for $1 - x$. We use ℓ to denote such *positive* and *negative literals*, respectively. A *clause* $C = \ell_1 \vee \ell_2 \vee \dots \vee \ell_k$ is a disjunction of literals and a formula in *conjunctive normal form (CNF)* $F = C_1 \wedge \dots \wedge C_m$ is a conjunction of clauses, where we think of clauses and formulas as sets when convenient, so that there are no repetitions and order is irrelevant.

A *pseudo-Boolean (PB) constraint* is a 0–1 linear inequality $\sum_j a_j \ell_j \geq b$, where, when convenient, we can assume all literals ℓ_j to refer to distinct variables and all integers a_j and b to be non-negative (so-called *normalized form*), and a *pseudo-Boolean formula* is a conjunction of such constraints. We can identify

the clause $C \equiv \ell_1 \vee \ell_2 \vee \dots \vee \ell_k$ with the pseudo-Boolean constraint $\text{PB}(C) = \ell_1 + \ell_2 + \dots + \ell_k \geq 1$, so a CNF formula F is just a special type of PB formula $\text{PB}(F) = \{\text{PB}(C) \mid C \in F\}$.

A (*partial*) *assignment* ρ mapping variables to $\{0, 1\}$, and extending to literals by $\rho(\bar{x}) = 1 - \rho(x)$ for x in the domain of ρ , satisfies a PB constraint $\sum_j a_j \ell_j \geq b$ if $\sum_{\ell_j: \rho(\ell_j)=1} a_j \geq b$ (assuming normalized form), and a PB formula is satisfied by ρ if all constraints in it are. We also refer to total satisfying assignments ρ as *solutions*. In a *pseudo-Boolean optimization (PBO)* problem we ask for the solution minimizing an *objective function* $O = \sum_j c_j \ell_j + W$, where c_j and W are integers and W represents a trivial lower bound on the minimum cost.

2.1 Pseudo-Boolean Proof Logging Using Cutting Planes

Pseudo-Boolean proof logging—as supported in VERIPB—is based on the *cutting planes* proof system [15] with extensions as discussed briefly below. We refer the reader to [14] for more information about cutting planes and to [9,32,37] for detailed information about the VERIPB proof system and format.

A pseudo-Boolean proof maintains two sets of *core constraints* \mathcal{C} and *derived constraints* \mathcal{D} under which the objective O should be minimized. At the start of the proof, \mathcal{C} is initialized to the constraints in the input formula. Any constraints derived by the rules described below are placed in \mathcal{D} , from where they can later be moved to \mathcal{C} (but not vice versa). Proofs maintain the invariant that the optimal value of any solution to \mathcal{C} and to the original input problem is the same. Hence, deletions from \mathcal{C} cannot be done arbitrarily but require the so called checked deletion rule discussed later. New constraints can be derived from $\mathcal{C} \cup \mathcal{D}$ by performing *addition* of two constraints or *multiplication* of a constraint by a positive integer, and *literal axioms* $\ell \geq 0$ can be used at any time. Additionally, we can apply *division* to $\sum_j a_j \ell_j \geq b$ by a positive integer d followed by rounding up to obtain $\sum_j \lceil a_j/d \rceil \ell_j \geq \lceil b/d \rceil$, and *saturation* to yield $\sum_j \min\{a_j, b\} \cdot \ell_j \geq b$ (where we again assume normalized form).

The negation of a constraint $C = \sum_j a_j \ell_j \geq b$ is $\neg C = \sum_j a_j \ell_j \leq b - 1$. For a (partial) assignment ρ we write $C|_\rho$ for the *restricted constraint* obtained by replacing variables assigned by ρ with their values and simplifying. We say that C *unit propagates* ℓ *under* ρ if $C|_\rho$ cannot be satisfied unless ℓ is assigned to 1. If repeated unit propagation on all constraints in $\mathcal{C} \cup \mathcal{D} \cup \{\neg C\}$, starting with the empty assignment $\rho = \emptyset$, leads to contradiction in the form of an unsatisfiable constraint, we say that C follows by *reverse unit propagation (RUP)* from $\mathcal{C} \cup \mathcal{D}$. Such (efficiently verifiable) RUP steps are allowed in proofs as a convenient way to avoid writing out an explicit cutting planes derivation. We use the same notation $C|_\omega$ to denote the result of applying to C a (*partial*) *substitution* ω , which can also map variables to other literals in addition to 0 and 1, and extend this notation to sets in the obvious way by the set image of $(\cdot)|_\omega$.

In addition to the above rules, which derive semantically implied constraints, there is a *redundance-based strengthening rule*, or just *redundance rule* for short, that can derive a non-implied constraint C as long as this does not change the

feasibility or optimal value. This can be guaranteed by considering a *witness substitution* ω such that for any total assignment α satisfying $\mathcal{C} \cup \mathcal{D}$ but violating C , the composition $\alpha \circ \omega$ is another total assignment that satisfies $\mathcal{C} \cup \mathcal{D} \cup \{C\}$ and yields an objective value that is at least as good for the objective O . Formally, C can be derived from $\mathcal{C} \cup \mathcal{D}$ by exhibiting ω and subproofs for

$$\mathcal{C} \cup \mathcal{D} \cup \{\neg C\} \vdash (\mathcal{C} \cup \mathcal{D} \cup \{C\})|_{\omega} \cup \{O \geq O|_{\omega}\}, \quad (1)$$

using the previously discussed rules (where the notation $\mathcal{C}_1 \vdash \mathcal{C}_2$ means that the constraints \mathcal{C}_2 can be derived from the constraints \mathcal{C}_1).

During preprocessing, constraints in the input formula are often deleted or replaced by other constraints, in which case the proof should establish that these deletions maintain equioptimality. Removing constraints from the derived set \mathcal{D} is unproblematic, but arbitrary deletions from the core set \mathcal{C} could potentially introduce spurious better solutions. Therefore, removing C from \mathcal{C} can only be done by the *checked deletion rule*, which requires a proof that the redundancy rule can be used to rederive C from $\mathcal{C} \setminus \{C\}$ (see [9] for a more detailed explanation).

Finally, it turns out to be useful to allow replacing O by a new objective O' using an *objective function update rule*, as long as this does not change the optimal value of the problem. Formally, updating the objective from O to O' requires derivations of the two constraints $O \geq O'$ and $O' \geq O$ from the core set \mathcal{C} , which shows that any satisfying solution to \mathcal{C} has the same value for both objectives. More details on this rule can be found in [37].

2.2 Maximum Satisfiability

A WCNF instance of (weighted partial) maximum satisfiability $\mathcal{F}^W = (F_H, F_S)$ is a conjunction of two CNF formulas F_H and F_S with hard and soft clauses, respectively, where soft clauses $C \in F_S$ have positive weights w^C . A solution ρ to \mathcal{F}^W satisfies F_H and has cost $\text{COST}(F_S, \rho)$ equal to the sum of weights of all soft clauses *not satisfied* by ρ . The optimum $\text{OPT}(\mathcal{F}^W)$ of \mathcal{F}^W is $\text{COST}(F_S, \rho)$ of an optimal solution ρ minimizing the cost, or ∞ if no solution exists.

State-of-the-art MaxSAT preprocessors such as MAXPRE [39,43] take a slightly different *objective-centric* view [5] of MaxSAT instances $\mathcal{F} \equiv (F, O)$ as consisting of a CNF formula F and an objective function $O = \sum_j c_j \ell_j + W$ to be minimized under assignments ρ satisfying F . A WCNF MaxSAT instance $\mathcal{F}^W = (F_H, F_S)$ is converted into objective-centric form $\text{OBJMAXSAT}(\mathcal{F}^W) = (F, O)$ by letting the clauses $F = F_H \cup \{C \vee b_C \mid C \in F_S, |C| > 1\}$ of $\text{OBJMAXSAT}(\mathcal{F}^W)$ consist of the hard clauses of \mathcal{F}^W and the non-unit soft clauses in F_S , each extended with a fresh variable b_C that does not appear in any other clause. The objective $O = \sum_{(\bar{\ell}) \in F_S} w^{(\bar{\ell})} \ell + \sum w^C b_C$ contains literals ℓ for all unit soft clauses $\bar{\ell}$ in F_S as literals for all new variables b_C , with coefficients equal to the weights of the corresponding soft clauses. In other words, each unit soft clause $(\bar{\ell}) \in F_S$ of weight w is transformed into the term $w \cdot \ell$ in the objective function O , and each non-unit soft clause C is transformed into the hard clause $C \vee b_C$ paired with the unit soft clause (\bar{b}_C) with same weight as C . The following observation summarizes the properties of $\text{OBJMAXSAT}(\mathcal{F}^W)$ that are central to our work.

Observation 1 *Assume ρ is a solution to a WCNF MaxSAT instance \mathcal{F}^W . There exists a solution ρ' to $(F, O) = \text{OBJMAXSAT}(\mathcal{F}^W)$ with $\text{COST}(\mathcal{F}^W, \rho) = O(\rho')$. Conversely, if ρ'_2 is a solution to $\text{OBJMAXSAT}(\mathcal{F}^W)$, then there exists a solution ρ_2 of \mathcal{F}^W for which $\text{COST}(\mathcal{F}^W, \rho_2) \leq O(\rho'_2)$.*

Since objective-centric MaxSAT can be seen to be a pseudo-Boolean optimization problem, Observation 1 implies that the optimal value of the objective O subject to constraints $\text{PB}(F)$, where $(F, O) = \text{OBJMAXSAT}(\mathcal{F}^W)$, is equal to the optimal cost of \mathcal{F}^W (cf. Figure 4 for the formalized theorems).

3 Proof Logging for MaxSAT Preprocessing

We now discuss how pseudo-Boolean proof logging can be used to reason about correctness of MaxSAT preprocessing steps. Our approach maintains a correspondence between the working-instance of the preprocessor and the core constraints of the proof. Specifically, after each preprocessing step (i.e. application of a preprocessing technique) the set of derived constraints will be empty. Thus we focus here on the core set of the proof; adding a constraint to the proof should be understood as adding it to the derived set and moving it to the core set, deleting a constraint as using checked deletion to remove it from the core set. Full technical details are in Appendix A.

3.1 Overview

We consider preprocessing of WCNF MaxSAT instances under *equioptimality*—this refers to the application of steps of inference (preprocessing) rules to \mathcal{F}^W , resulting in an *equioptimal* instance \mathcal{F}_P^W , i.e., an instance \mathcal{F}_P^W such that $\text{OPT}(\mathcal{F}^W) = \text{OPT}(\mathcal{F}_P^W)$. In *certified* MaxSAT preprocessing, we also provide a proof justifying the claim $\text{OPT}(\mathcal{F}^W) = \text{OPT}(\mathcal{F}_P^W)$. We discuss inputs that have solutions. Our approach also covers the—arguably less interesting—case of \mathcal{F}^W not having solutions; details are in Appendix A.5.

An overview of the workflow of our certifying MaxSAT preprocessor is shown in Figure 1. Given a WCNF instance \mathcal{F}^W as input, the preprocessor proceeds in 5 stages (illustrated on the left in Figure 1), and then outputs a preprocessed MaxSAT instance \mathcal{F}_P^W and a pseudo-Boolean proof which shows that $\text{OPT}(\text{OBJMAXSAT}(\mathcal{F}^W)) = \text{OPT}(\text{OBJMAXSAT}(\mathcal{F}_P^W))$. For certified MaxSAT preprocessing, a formally verified checker (Section 4) can be used on the proof log to verify that: (a) the initial core constraints in the proof correspond exactly to the clauses in $\text{OBJMAXSAT}(\mathcal{F}^W)$, (b) the final core constraints in the proof correspond exactly to the clauses in $\text{OBJMAXSAT}(\mathcal{F}_P^W)$, and (c) that each step in the proof is valid. Below, we provide more details on the 5 sequential stages of the preprocessing flow.

Stage 1: Initialization. An input WCNF instance \mathcal{F}^W is converted to pseudo-Boolean format by converting it to an objective-centric representation $(F^0, O^0) =$

	<i>preprocessing</i> (MaxSAT)	<i>proof</i> (pseudo-Boolean)
1. Initialization	$(\mathcal{F}^W, 0)$	$(\text{PB}(F^0), O^0)$ where $(F^0, O^0) = \text{OBJMAXSAT}(\mathcal{F}^W)$
2. Preprocessing on WCNF	$(\mathcal{F}_1^W, \text{LB}^1)$	(\mathcal{C}^1, O^1)
3. Conversion to objective-centric	$(F^2, O^2 + \text{LB}^1)$ where $(F^2, O^2) = \text{OBJMAXSAT}(\mathcal{F}_1^W)$	$(\text{PB}(F^2), O^2 + \text{LB}^1)$
4. Preprocessing on objective-centric	(F^3, O^3)	$(\text{PB}(F^3), O^3)$
5. Constant removal	(F^4, O^4) where $F^4 = F^3 \wedge (b^{W^3})$ $O^4 = O^3 - W^3 + W^3 b^{W^3}$	$(\text{PB}(F^4), O^4)$
Output	Preprocessed WCNF $\mathcal{F}_P^W = (F^4, F_S^P)$	Proof of equioptimality of $\text{PB}(F^0)$ under O^0 and $\text{PB}(F^4)$ under O^4

Fig. 1. Overview of the five stages of certified MaxSAT preprocessing of a WCNF instance \mathcal{F}^W . The middle column contains the state of the working MaxSAT instance as a WCNF instance and a lower bound on its optimum cost (Stages 1–2), or as an objective-centric instance (Stages 3–5). The right column contains a tuple (\mathcal{C}, O) with the set \mathcal{C} of core constraints, and objective O , respectively, of the proof after each stage.

$\text{OBJMAXSAT}(\mathcal{F}^W)$ and then representing all clauses in F^0 as pseudo-Boolean constraints. The initial proof maintained by the preprocessor will have the constraints $\text{PB}(F^0)$ as core constraints and O^0 as the objective. The initial working MaxSAT instance will be \mathcal{F}^W . Additionally, the preprocessor maintains a lower bound (initialized to 0) on the optimal cost of \mathcal{F}^W .

Stage 2: Preprocessing on the Initial WCNF Representation. During preprocessing on the WCNF representation, a (very limited) set of simplification techniques are applied on the working formula. At this stage the preprocessor removes duplicate, tautological, and blocked clauses [42]. Additionally, hard unit clauses are unit propagated and clauses subsumed by hard clauses are removed. Importantly, the preprocessor is performing these simplifications on a WCNF MaxSAT instance where it deals with hard and soft clauses. As the pseudo-Boolean proof has no concept of hard or soft clauses, the reformulation steps must be logged in terms of the constraints in the proof. The next example illustrates how reasoning with different types of clauses is logged in the proof.

Example 1. Assume that the working instance of the preprocessor has two duplicate hard clauses C and D . Then the proof has two identical linear inequalities

$\text{PB}(C)$ and $\text{PB}(D)$ in the core set. Since $\text{PB}(D)$ is RUP, it can be deleted directly. If D is a non-unit soft clause instead, the proof has the linear constraint $\text{PB}(D \vee b_D)$ and its objective the term $w^D b_D$ where b_D does not appear in any other constraint. Then we log four steps: (1) remove the (RUP) constraint $\text{PB}(D \vee b_D)$, (2) introduce $\bar{b}_D \geq 1$ to the proof by redundancy-based strengthening using the witness $\{b_D \rightarrow 0\}$, (3) remove the term $w^D b_D$ from the objective, and (4) remove the constraint $\bar{b}_D \geq 1$ with the witness $\{b_D \rightarrow 0\}$.

Stage 3: Conversion to Objective-Centric Representation. In order to apply more simplification rules in a cost-preserving way, the working instance $\mathcal{F}_1^W = (F_H^1, F_S^1)$ at the end of Stage 2 is converted into the corresponding objective-centric representation that takes the lower-bound LB incurred during Stage 1 into account. More specifically, the preprocessor next converts its working MaxSAT instance into the objective-centric instance $\mathcal{F}_2 = (F^2, O^2 + \text{LB})$ where $(F^2, O^2) = \text{OBJMAXSAT}(\mathcal{F}_1^W)$.

Here, it is important to note that at the end of Stage 2, the core constraints \mathcal{C}^1 and objective O^1 of the proof are not necessarily $\text{PB}(F^2)$ and $O^2 + \text{LB}$, respectively. Specifically, consider a unit soft clause $(\bar{\ell})$ of \mathcal{F}_1^W obtained by shrinking a non-unit soft clause $C \supseteq (\bar{\ell})$ of the input instance, with weight w^C . Then the objective function O^2 in the preprocessor will include the term $w^C \ell$ that does not appear in the objective function O^1 in the proof. Instead, O^1 contains the term $w^C b_C$ and \mathcal{C}^1 the constraint $\bar{\ell} + b_C \geq 1$ where b_C is the fresh variable added to C in Stage 1. In order to “sync up” the working instance and the proof we log the following four steps: (1) introduce $\ell + \bar{b}_C \geq 1$ to the proof with the witness $\{b_C \rightarrow 0\}$, (2) update O^1 by adding $w^C \ell - w^C b_C$, (3) remove the constraint $\ell + \bar{b}_C \geq 1$ with the witness $\{b_C \rightarrow 0\}$, (4) remove the constraint $\bar{\ell} + b_C \geq 1$ with witness $\{b_C \rightarrow 1\}$. The same steps are logged for all soft unit clauses of \mathcal{F}_1^W obtained during Stage 2. In the last stages, the preprocessor will operate on an objective-centric MaxSAT instance whose clauses correspond exactly to the core constraints of the proof.

Stage 4: Preprocessing on the Objective-Centric Representation. During preprocessing on the objective-centric representation, more simplification techniques are applied to the working objective-centric instance and logged to the proof. We implemented proof logging for a wide range of preprocessing techniques. These include MaxSAT versions of rules commonly used in SAT solving like: bounded variable elimination (BVE) [20,68], bounded variable addition [48], blocked clause elimination [42], subsumption elimination, self-subsuming resolution [20,60], failed literal elimination [25,45,75], and equivalent literal substitution [12,47,71]. We also cover MaxSAT-specific preprocessing rules like Trim-MaxSAT [61], (group)-subsumed literal (or label) elimination (SLE) [6,43], intrinsic at-most-ones [38,39], binary core removal (BCR) [26,43], label matching [43], and hardening [2,39,56]. Here we give examples for BVE, SLE, label matching, and BCR, the rest are detailed in Appendix A. In the following descriptions, let (F, O) be the current objective-centric working instance.

Bounded Variable Elimination (BVE) [20,68]. BVE eliminates a variable x that does not appear in the objective from F by replacing all clauses in which either x or \bar{x} appears with the non-tautological clauses in $\{C \vee D \mid C \vee x \in F, D \vee \bar{x} \in F\}$.

An application of BVE is logged as follows: (1) each non-tautological constraint $\text{PB}(C \vee D)$ is added by summing the existing constraints $\text{PB}(C \vee x)$ and $\text{PB}(D \vee \bar{x})$ and (2) each constraint of form $\text{PB}(C \vee x)$ and $\text{PB}(D \vee \bar{x})$ is deleted with the witnesses $x \rightarrow 1$ and $x \rightarrow 0$, respectively.

Label Matching [43]. Label matching allows merging pairs of objective variables that can be deduced to not both be set to 1 by optimal solutions. Assume that (i) F contains the clauses $C \vee b_C$ and $D \vee b_D$, (ii) b_C and b_D are objective variables with the same coefficient w in O , and (iii) $C \vee D$ is a tautology. Then label matching replaces b_C and b_D with a fresh variable b_{CD} , i.e., replaces $C \vee b_C$ and $D \vee b_D$ with $C \vee b_{CD}$ and $D \vee b_{CD}$ and adds $-wb_C - wb_D + wb_{CD}$ to O .

As $C \vee D$ is a tautology we assume w.l.o.g. that $\bar{x} \in C$ and $x \in D$ for a variable x . Label matching is logged via the following steps: (1) introduce the constraint $\bar{b}_C + \bar{b}_D \geq 1$ with the witness $\{b_C \rightarrow x, b_D \rightarrow \bar{x}\}$, (2) introduce the constraints $b_{CD} + \bar{b}_C + \bar{b}_D \geq 2$ and $\bar{b}_{CD} + b_C + b_D \geq 1$ by reification; these correspond to $b_{CD} = b_C + b_D$ which holds even though the variables are binary due to the constraint added in the first step, (3) update the objective by adding $-wb_C - wb_D + wb_{CD}$ to it, (4) introduce the constraints $\text{PB}(C \vee b_{CD})$ and $\text{PB}(D \vee b_{CD})$ which are RUP, (5) delete $\text{PB}(C \vee b_C)$ and $\text{PB}(D \vee b_D)$ with the witness $\{b_C \rightarrow \bar{x}, b_D \rightarrow x\}$, (6) delete the constraint $b_{CD} + \bar{b}_C + \bar{b}_D \geq 2$ with the witness $\{b_C \rightarrow 0, b_D \rightarrow 0\}$ and $\bar{b}_{CD} + b_C + b_D \geq 1$ with the witness $\{b_C \rightarrow 1, b_D \rightarrow 0\}$, (7) delete $\bar{b}_C + \bar{b}_D \geq 1$ with the witness $\{b_C \rightarrow 0\}$.

Subsumed Literal Elimination (SLE) [6,39]. Given two non-objective variables x and y s.t. (i) $\{C \mid C \in F, y \in C\} \subseteq \{C \mid C \in F, x \in C\}$ and (ii) $\{C \mid C \in F, \bar{x} \in C\} \subseteq \{C \mid C \in F, \bar{y} \in C\}$, subsumed literal elimination (SLE) allows fixing $x = 1$ and $y = 0$. SLE is logged with the following steps: (1) introduce $x \geq 1$ and $\bar{y} \geq 1$, both with witness $\{x \rightarrow 1, y \rightarrow 0\}$, (2) simplify the constraint database via propagation, (3) delete the constraints introduced in the first step as neither x nor y appears in any other constraints after the simplification.

If x and y are objective variables, the application of SLE additionally requires that: (iii) the coefficient in the objective of x is at most as high as the coefficient of y . Then the value of x is not fixed as it would incur cost. Instead, only $y = 0$ is fixed and y removed from the objective. Intuitively, conditions (i) and (ii) establish that the values of x and y can always be flipped to 0 and 1, respectively, without falsifying any clauses. If neither of the variables is in the objective, this flip does not increase the cost of any solutions. Otherwise, condition (iii) ensures that the flip does not make the solution worse, i.e., increase its cost.

Binary Core Removal (BCR) [26,43]. Assume that the following four prerequisites hold: (i) F contains a clause $b_C \vee b_D$ for two objective variables b_C and b_D , (ii) b_C and b_D have the same coefficient w in O , (iii) the negations \bar{b}_C and \bar{b}_D do not appear in any clause of F , and (iv) both b_C and b_D appear in at

least one other clause of F but not together in any other clause of F . Binary core removal replaces all clauses containing b_C or b_D with the non-tautological clauses in $\{C \vee D \vee b_{CD} \mid C \vee b_C \in F, D \vee b_D \in F\}$, where b_{CD} is a fresh variable, and modifies the objective function by adding $-wb_C - wb_D + wb_{CD} + w$ to it.

BCR is logged as a combination of the so-called *intrinsic at-most-ones* technique [38,39] and BVE. Applying intrinsic at most ones on the variables b_C and b_D introduces a new clause ($\bar{b}_C \vee \bar{b}_D \vee b_{CD}$) and adds $-wb_C - wb_D + wb_{CD} + w$ to the objective. Our proof for intrinsic at most ones is the same as the one presented in [4]. As this step removes b_C and b_D from the objective, both can now be eliminated via BVE.

Stage 5: Constant Removal and Output. After objective-centric preprocessing, the final objective-centric instance (F^3, O^3) is converted back to a WCNF instance. Before doing so, the constant term W_3 of O^3 is removed by introducing a fresh variable b^{W_3} , and setting $F^4 = F^3 \wedge (b^{W_3})$ and $O^4 = O^3 - W_3 + W_3 b^{W_3}$. This step is straightforward to prove.

Finally, the preprocessor outputs the WCNF instance $\mathcal{F}_P^W = (F^4, F_S^P)$ that has F^4 as hard clauses. the set F_S^P of soft clauses consists of a unit soft clause ($\bar{\ell}$) of weight c for each term $c \cdot \ell$ in O^4 . The preprocessor also outputs the final proof of the fact that the minimum-cost of solutions to the pseudo-Boolean formula $\text{PB}(F^0)$ under O^0 is the same as that of $\text{PB}(F^4)$ under O^4 , i.e. that $\text{OPT}(\text{OBJMAXSAT}(\mathcal{F}^W)) = \text{OPT}(\text{OBJMAXSAT}(\mathcal{F}_P^W))$.

3.2 Worked Example of Certified Preprocessing

We give a worked-out example of certified preprocessing of the instance $\mathcal{F}^W = (F_H, F_S)$ where $F_H = \{(x_1 \vee x_2), (\bar{x}_2)\}$ and three soft clauses: (\bar{x}_1) with weight 1, $(x_3 \vee \bar{x}_4)$ with weight 2, and $(x_4 \vee \bar{x}_5)$ with weight 3. The proof for one possible execution of the preprocessor on this input instance is detailed in Table 1.

During Stage 1 (Steps 1–4 in Table 1), the core constraints of the proof are initialized to contain the four constraints corresponding to the hard and non-unit soft clauses of \mathcal{F}^W (IDs (1)–(4) in Table 1), and the objective to $x_1 + 2b_1 + 3b_2$, where b_1 and b_2 are fresh variables added to the non-unit soft clauses of \mathcal{F}^W .

During Stage 2 (Steps 5–9), the preprocessor fixes $x_2 = 0$ via unit propagation by removing x_2 from the clause $(x_1 \vee x_2)$, and then removing the unit clause (\bar{x}_2) . The justification for fixing $x_2 = 0$ are Steps 5–7. Next the preprocessor fixes $x_1 = 1$ which (i) removes the hard clause (x_1) , and (ii) increases the lower bound on the optimal cost by 1. The justification for fixing $x_1 = 1$ are Steps 8 and 9 of Table 1. At this point—at the end of Stage 2—the working instance $\mathcal{F}_1^W = (F_H^1, F_S^1)$ has $F_H^1 = \{\}$ and $F_S^1 = \{(x_3 \vee \bar{x}_4), (x_4 \vee \bar{x}_5)\}$.

In Stage 3, the preprocessor converts its working instance into the objective-centric representation (F, O) where $F = \{(x_3 \vee \bar{x}_4 \vee b_1), (x_4 \vee \bar{x}_5 \vee b_2)\}$ and $O = 2b_1 + 3b_2 + 1$, which exactly matches the core constraints and objective of the proof after Step 9. Thus, in this instance, the conversion does not result in any proof logging steps. Afterwards, during Stage 4 (Steps 10–17), the preprocessor

Table 1. Example proof produced by a certifying preprocessor. The column (ID) refers to constraint IDs in the pseudo-Boolean proof. The column (Step) indexes all proof logging steps and is used when referring to the steps in the discussion. The letter ω is used for the witness substitution in redundance-based strengthening steps.

Step	ID	Type	Justification	Objective
1	(1)	add $x_1 + x_2 \geq 1$	input	$x_1 + 2b_1 + 3b_2$
2	(2)	add $\bar{x}_2 \geq 1$	input	$x_1 + 2b_1 + 3b_2$
3	(3)	add $x_3 + \bar{x}_4 + b_1 \geq 1$	input	$x_1 + 2b_1 + 3b_2$
4	(4)	add $x_4 + \bar{x}_5 + b_2 \geq 1$	input	$x_1 + 2b_1 + 3b_2$
<i>Unit propagation: fix $x_2 = 0$, constraint (2)</i>				
5	(5)	add $x_1 \geq 1$	(1) + (2)	$x_1 + 2b_1 + 3b_2$
6		delete (1)	RUP	$x_1 + 2b_1 + 3b_2$
7		delete (2)	$\omega: \{x_2 \rightarrow 0\}$	$x_1 + 2b_1 + 3b_2$
<i>Unit propagation; fix $x_1 = 1$, constraint (5)</i>				
8		add $-x_1 + 1$ to obj.	(5)	$2b_1 + 3b_2 + 1$
9		delete (5)	$\omega: \{x_1 \rightarrow 1\}$	$2b_1 + 3b_2 + 1$
<i>BVE: eliminate x_4</i>				
10	(6)	add $x_3 + b_1 + \bar{x}_5 + b_2 \geq 1$	(3) + (4)	$2b_1 + 3b_2 + 1$
11		delete (3)	$\omega: \{x_4 \rightarrow 0\}$	$2b_1 + 3b_2 + 1$
12		delete (4)	$\omega: \{x_4 \rightarrow 1\}$	$2b_1 + 3b_2 + 1$
<i>Subsumed literal elimination: \bar{b}_2</i>				
13	(7)	add $\bar{b}_2 \geq 1$	$\omega: \{b_2 \rightarrow 0, b_1 \rightarrow 1\}$	$2b_1 + 3b_2 + 1$
14		add $-3b_2$ to obj.	(7)	$2b_1 + 1$
15	(8)	add $x_3 + b_1 + \bar{x}_5 \geq 1$	(6) + (7)	$2b_1 + 1$
16		delete (6)	RUP	$2b_1 + 1$
17		delete (7)	$\omega: \{b_2 \rightarrow 0\}$	$2b_1 + 1$
<i>Remove objective constant</i>				
18	(9)	add $b_3 \geq 1$	$\omega: \{b_3 \rightarrow 1\}$	$2b_1 + 1$
19		add $b_3 - 1$ to obj.	(9)	$2b_1 + b_3$

applies BVE in order to eliminate x_4 (Steps 10–12) and SLE to fix b_2 to 0 (Steps 13–17). Finally, Steps 18 and 19 represent Stage 5, i.e., the removal of the constant 1 from the objective. After these steps, the preprocessor outputs the preprocessed instance $\mathcal{F}_P^W = (F_H^P, F_S^P)$, where $F_H^P = \{(x_3 \vee \bar{x}_5 \vee b_1), (b_3)\}$ and F_S^P contains two clauses: (\bar{b}_1) with weight 2, and (\bar{b}_3) with weight 1.

4 Verified Proof Checking for Preprocessing Proofs

This section presents our new workflow for formally verified, end-to-end proof checking of MaxSAT preprocessing proofs based on pseudo-Boolean reasoning; an overview of this workflow is shown in Figure 2. To realize this workflow, we extended the VERIPB tool and its proof format to support a new *output section* for declaring (and checking) reformulation guarantees between input and output PBO instances (Section 4.1); we similarly modified CAKEPB [29] a verified proof checker to support the updated proof format (Section 4.2);

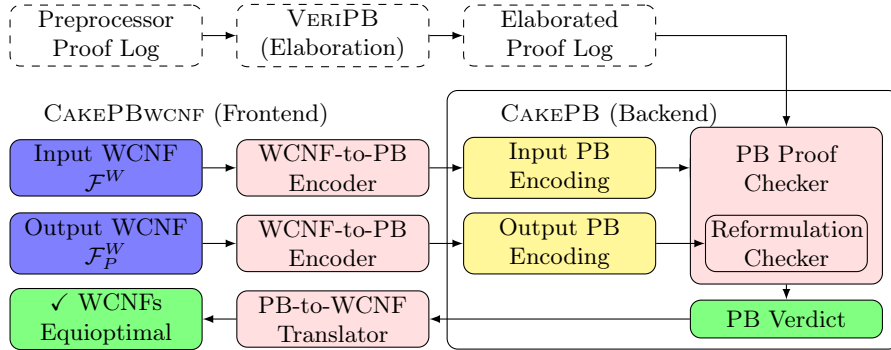

Fig. 2. Workflow for end-to-end verified MaxSAT preprocessing proof checking.

finally, we built a verified frontend, CAKEPBWCNF, which mediates between MaxSAT WCNF instances and PBO instances (Section 4.3). Our formalization is carried out in the HOL4 proof assistant [67] using CAKEML tools [34,59,70] to obtain a verified executable implementation of CAKEPBWCNF. A snapshot of the CAKEPB development is at https://github.com/CakeML/cakeml/tree/9c063a7d92cadb36c49a6e45856ae0db734dc9e5/examples/pseudo_bool.

In the workflow (Figure 2), a MaxSAT preprocessor produces a reformulated output WCNF along with a proof log claiming that it is equioptimal to the input WCNF. The proof log is elaborated by VERIPB then checked by CAKEPBWCNF, resulting in a verified *verdict*—if the proof checking succeeds, then the input and output WCNFs are equioptimal. This workflow also supports verified checking of WCNF MaxSAT solving proofs (where the output parts of the flow are omitted).

4.1 Output Section for Pseudo-Boolean Proofs

Given an input PBO instance (F, O) , the VERIPB proof system as described in Section 2.1 maintains the invariant that the core constraints \mathcal{C} (and current objective) are equioptimal to the input instance. Utilizing this invariant, the new *output section* for VERIPB proofs allows users to optionally specify an output PBO instance (F', O') at the end of a proof. This output instance is claimed to be a reformulation of the input which is either: (i) *derivable*, i.e., satisfiability of F implies satisfiability of F' , (ii) *equisatisfiable* to F , or (iii) *equioptimal* to (F, O) . These are increasingly stronger claims about the relationship between the input and output instances. After checking a pseudo-Boolean derivation, VERIPB runs reformulation checking which, e.g., for equioptimality, checks that $\mathcal{C} \subseteq F'$, $F' \subseteq \mathcal{C}$, and that the respective objective functions are syntactically equal after normalization; other reformulation guarantees are checked analogously.

The VERIPB tool supports an *elaboration* mode [29], where it converts a proof in *augmented* proof format to a *kernel* proof format. The augmented format contains syntactic sugar rules to facilitate proof logging for solvers and preprocessors like MAXPRE, while the kernel format is supported by the formally

verified proof checker CAKEPB. The new output section is passed unchanged from augmented to kernel format during elaboration.

4.2 Verified Proof Checking for Reformulations

There are two main verification tasks involved in extending CAKEPB with support for the output section. The first task is to verify soundness of all cases of reformulation checking. Formally, the equioptimality of an input PBO instance fml , obj and its output counterpart fml' , obj' is specified as follows:

$$\begin{aligned} \text{sem_output } fml \text{ } obj \text{ None } fml' \text{ } obj' \text{ Equioptimal} &\stackrel{\text{def}}{=} \\ \forall v. (\exists w. \text{satisfies } w \text{ } fml \wedge \text{eval_obj } obj \text{ } w \leq v) &\iff \\ (\exists w'. \text{satisfies } w' \text{ } fml' \wedge \text{eval_obj } obj' \text{ } w' \leq v) & \end{aligned}$$

This definition says that, for all values v , the input instance has a satisfying assignment with objective value less than or equal to v iff the output instance also has such an assignment; note that this implies (as a special case) that fml is satisfiable iff fml' is satisfiable. The verified correctness theorem for CAKEPB says that *if* CAKEPB successfully checks a pseudo-Boolean proof in kernel format and prints a verdict declaring equioptimality, then the input and output instances are indeed equioptimal as defined in `sem_output`.

The second task is to develop verified optimizations to speedup proof steps which occur frequently in preprocessing proofs; some code hotspots were also identified by profiling the proof checker against proofs generated by MAXPRE. Similar (unverified) versions of these optimizations are also used in VERIPB. These optimizations turned out to be necessary in practice—they mostly target steps which, when naïvely implemented, have quadratic (or worse) time complexity in the size of the constraint database.

Optimizing Reformulation Checking. The most expensive step in reformulation checking for the output section is to ensure that the core constraints \mathcal{C} are included in the output formula and vice versa (possibly with permutations and duplicity). Here, CAKEPB normalizes all pseudo-Boolean constraints involved to a canonical form and then copies both \mathcal{C} and the output formula into respective array-backed hash tables for fast membership tests.

Optimizing Redundance and Checked Deletion Rules. A naïve implementation of these two redundance-based rules would require walking over the entire database of active constraints, e.g., checking all the subproofs in eq. (1) by looping over all constraints in the RHS $(\mathcal{C} \cup \mathcal{D} \cup \{C\})|_{\omega} \cup \{O \geq O|_{\omega}\}$. An important observation here is that preprocessing proofs frequently use substitutions ω that only involve a small number of variables (usually one and the variable is fresh for reifications). Consequently, most of the constraints $(\mathcal{C} \cup \mathcal{D} \cup \{C\})|_{\omega}$ can be skipped when checking redundancy because they are unchanged by the substitution. Similarly, the constraint $\{O \geq O|_{\omega}\}$ is expensive to construct when O contains many terms, but this construction can be skipped if it is *a priori* known that no variables

$$\begin{aligned}
\text{sat_hard } w \text{ wfml} &\stackrel{\text{def}}{=} \forall C. \text{mem } (0, C) \text{ wfml} \Rightarrow \text{sat_clause } w \ C \\
\text{weight_clause } w \ (n, C) &\stackrel{\text{def}}{=} \text{if } \text{sat_clause } w \ C \text{ then } 0 \text{ else } n \\
\text{cost } w \ \text{wfml} &\stackrel{\text{def}}{=} \text{sum } (\text{map } (\text{weight_clause } w) \ \text{wfml}) \\
\text{opt_cost } \text{wfml} &\stackrel{\text{def}}{=} \text{if } \neg \exists w. \text{sat_hard } w \ \text{wfml} \text{ then } \text{None} \\
&\quad \text{else } \text{Some } (\text{min}_{\text{set}} \{ \text{cost } w \ \text{wfml} \mid \text{sat_hard } w \ \text{wfml} \})
\end{aligned}$$

Fig. 3. Formalized semantics for MaxSAT WCNF problems.

being substituted occur in O . To handle these cases, CAKEPB stores a lazily-updated mapping of variables to their occurrences in the constraint database and the objective, which it uses to detect and skip the aforementioned cases.

The aforementioned occurrence mapping is necessary for performance due to the frequency of steps involving witnesses for preprocessing proofs. However, storing this mapping does lead to a memory overhead in our checker. More precisely, every variable *occurrence* in any constraint in the database corresponds to exactly one ID in the mapping. Thus, the overhead of storing the mapping is worst-case quadratic in the number of clauses, but it is still linear in the total space usage for the constraints database.

4.3 Verified WCNF Frontend

The CAKEPBWCNF frontend mediates between MaxSAT WCNF problems and pseudo-Boolean optimization problems native to CAKEPB. Accordingly, the correctness of CAKEPBWCNF is stated in terms of MaxSAT semantics, i.e., the encoding, underlying pseudo-Boolean semantics, and proof system are all formally verified. In order to trust CAKEPBWCNF, one *only* has to carefully inspect the formal definition of MaxSAT semantics shown in Figure 3 to make sure that it matches the informal definition in Section 2.2. Here, each clause C is paired with a natural number n , where $n = 0$ indicates a hard clause and when $n > 0$ it is the weight of C . The optimal cost of a weighted CNF formula wfml is None (representing ∞) if no satisfying assignment to the hard clauses exist; otherwise, it is the minimum cost among all satisfying assignments to the hard clauses.

There and Back Again. CAKEPBWCNF contains a verified WCNF-to-PB encoder implementing the encoding described in Section 2.2. Its correctness theorems are shown in Figure 4, where the two lemmas in the top row relate the satisfiability and cost of the WCNF to its PB optimization counterpart after running `wcnf_to_pbf` (and vice versa), see Observation 1. Using these lemmas, the final theorem (bottom row) shows that equioptimality for two (encoded) PB optimization problems can be *translated* back to equioptimality for the input and preprocessed WCNFs.

Putting Everything Together. The final verification step is to specialize the end-to-end machine code correctness theorem for CAKEPB to the new frontend. The resulting theorem for CAKEPBWCNF is shown abridged in Figure 5; a detailed

$$\begin{array}{l}
 \vdash \text{wfml_to_pbf } wfml = (obj, pbf) \wedge \\
 \text{satisfies } w \text{ (set pbf)} \Rightarrow \\
 \exists w'. \text{sat_hard } w' wfml \wedge \\
 \text{cost } w' wfml \leq \text{eval_obj } obj w \\
 \\
 \vdash \text{wfml_to_pbf } wfml = (obj, pbf) \wedge \\
 \text{sat_hard } w wfml \Rightarrow \\
 \exists w'. \text{satisfies } w' \text{ (set pbf)} \wedge \\
 \text{eval_obj } obj w' = \text{cost } w wfml \\
 \\
 \vdash \text{full_encode } wfml = (obj, pbf) \wedge \text{full_encode } wfml' = (obj', pbf') \wedge \\
 \text{sem_output (set pbf) } obj \text{ None (set pbf')} obj' \text{ Equioptimal} \Rightarrow \\
 \text{opt_cost } wfml = \text{opt_cost } wfml'
 \end{array}$$

Fig. 4. Correctness theorems for the WCNF-to-PB encoding.

$$\begin{array}{l}
 \vdash \text{cake_pb_wcnf_run } cl fs mc ms \Rightarrow \\
 \exists out err. \\
 \text{extract_fs } fs \text{ (cake_pb_wcnf_io_events } cl fs) = \\
 \text{Some (add_stdout (add_stderr } fs err) out) \wedge \\
 (\text{length } cl = 4 \wedge \text{isSuffix "s VERIFIED OUTPUT EQUIOPTIMAL\n"} out) \Rightarrow \\
 \exists wfml wfml'. \\
 \text{get_fml } fs \text{ (el 1 } cl) = \text{Some } wfml \wedge \text{get_fml } fs \text{ (el 3 } cl) = \text{Some } wfml' \wedge \\
 \text{opt_cost } wfml = \text{opt_cost } wfml'
 \end{array}$$

Fig. 5. Abridged final correctness theorem for CAKEPBWCNF.

explanation of similar CAKEML-based theorems is available elsewhere [29,69] so we do not go into details here. Briefly, the theorem says that whenever the verdict string “s VERIFIED OUTPUT EQUIOPTIMAL” is printed (as a suffix) to the standard output by an execution of CAKEPBWCNF, then the two input files given on the command line parsed to equioptimal MaxSAT WCNF instances.

5 Experiments

We upgraded the MaxSAT preprocessor MAXPRE 2.1 [39,41,43] to MAXPRE 2.2, which produces proof logs in the VERIPB format [10]. MAXPRE 2.2 is available at the MAXPRE 2 repository [50]. The generated proofs were checked and elaborated using VERIPB [73] and the verified proof checker CAKEPBWCNF. As benchmarks we used the 558 weighted and 572 unweighted MaxSAT instances from the MaxSAT Evaluation 2023 [52].

The experiments were conducted on 11th Gen Intel(R) Core(TM) i5-1145G7 @ 2.60GHz CPUs with 16 GB of memory, a solid state drive as storage, and running Rocky Linux 8.5. Each benchmark ran exclusively on a node and the memory was limited to 14 GB. The time for MAXPRE was limited to 300 seconds; there is also an option to let MAXPRE know about this time limit, which we did not use since MAXPRE decides which techniques to try based on the remaining time, which makes it difficult to compare results with and without proof logging. The time limits for both VERIPB and for CAKEPBWCNF were set to 6000 seconds to get as many instances checked as possible.

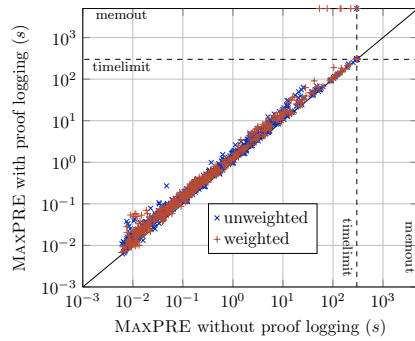

Fig. 6. Proof logging overhead for MAXPRE.

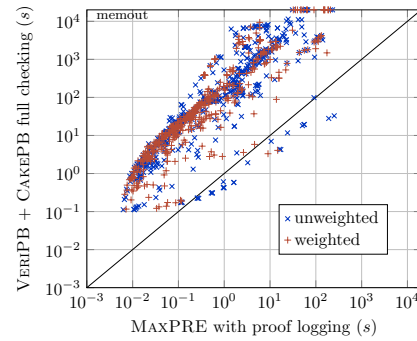

Fig. 7. MAXPRE vs. combined proof checking running time.

This evaluation focuses on the default setting of MAXPRE, which does not use some of the techniques mentioned in Section 3 (or Appendix A). We have also conducted experiments with all techniques enabled to check the correctness of the proof logging implementation for all preprocessing techniques. The data and source code from our experiments is available at [40].

The goal of the experimental evaluation is to answer the following questions:

- RQ1.** How much extra time is required to write the proof for the preprocessor?
- RQ2.** How long does proof checking take compared to proof generation?

To answer the first question, we compare MAXPRE with and without proof logging in Figure 6. In total, MAXPRE without proof logging successfully preprocesses 1081 instances; with proof logging enabled, 8 fewer instances were preprocessed within the resource limits, i.e., due to either time- or memory-out. For the successfully preprocessed instances, the geometric mean of the proof logging overhead is 46% of the running time and 95% of the instances were preprocessed with proof logging in at most twice the time as without proof logging.

For our comparison between proof generation and proof checking, we only consider the 1073 instances successfully preprocessed by MAXPRE within the resource limits. Of these, 1021 instances were successfully checked and elaborated by VERIPB, and 991 instances were subsequently successfully checked by the formally verified checker CAKEPBWCNF, with the remaining instances being time- or memory-outs. This shows the practical viability of our approach, as the vast majority of preprocessing proofs were checked within the resource limits.

A scatter plot comparing the running time of MAXPRE with proof logging enabled against the combined checking process is shown in Figure 7. For the combined checking time, we only consider the instances that have been successfully checked by CAKEPBWCNF. In the geometric mean, the time for the combined verified checking pipeline of VERIPB elaboration followed by CAKEPBWCNF is $113\times$ the preprocessing time of MAXPRE. A general reason for this overhead is that the preprocessor has more MaxSAT application-specific context than the

pseudo-Boolean checker, so the preprocessor can log proof steps without performing the actual reasoning while the checker must ensure that those steps are sound in an application-agnostic way. An example for this is reification: as the preprocessor knows its reification variables are fresh, it can easily emit redundancy steps that witness on those variables; but the checker has to verify freshness against its own database. Similar behaviour has been observed in other applications of pseudo-Boolean proof logging [27,37].

To analyse further the causes of proof checking overhead, we also compared VERIPB to CAKEPBWCNF. The checking of the elaborated kernel proof with CAKEPBWCNF is $6.7\times$ faster than checking and elaborating the augmented proof with VERIPB. This suggests that the bottleneck for proof checking is VERIPB; VERIPB *without* elaboration is about $5.3\times$ slower than CAKEPBWCNF. As elaboration is a necessary step before running CAKEPBWCNF, improving the performance of VERIPB would benefit the performance of the pipeline as a whole. One specific improvement would be to augment RUP rules with LRAT-style hints [16], so that VERIPB does not need to elaborate RUP to cutting planes. This kind of engineering challenges are beyond the scope of this paper.

6 Conclusion

In this work, we show how to use pseudo-Boolean proof logging to certify correctness of the MaxSAT preprocessing phase, extending previous work for the main solving phase in unweighted model-improving solvers [72] and general core-guided solvers [4]. As a further strengthening of previous work, we present a fully formally verified toolchain which provides end-to-end verification of correctness.

In contrast to SAT solving, there is a rich variety of MaxSAT solving techniques, and it still remains to design pseudo-Boolean proof logging methods for general, weighted, model-improving MaxSAT solving [22,46,62] and *implicit hitting set (IHS)* solvers [18,19] with *abstract cores* [3]. Nevertheless, our work demonstrates again that pseudo-Boolean reasoning seems like a very promising foundation for MaxSAT proof logging, and we are optimistic that this work is another step on the path towards general adoption of proof logging techniques for MaxSAT solving.

Acknowledgments. This work has been financially supported by the University of Helsinki Doctoral Programme in Computer Science DoCS, the Research Council of Finland under grants 342145 and 346056, the Swedish Research Council grants 2016-00782 and 2021-05165, the Independent Research Fund Denmark grant 9040-00389B, the Wallenberg AI, Autonomous Systems and Software Program (WASP) funded by the Knut and Alice Wallenberg Foundation, and by A*STAR, Singapore. Part of this work was carried out while some of the authors participated in the extended reunion of the semester program *Satisfiability: Theory, Practice, and Beyond* in the spring of 2023 at the Simons Institute for the Theory of Computing at UC Berkeley. We also acknowledge useful discussions at the Dagstuhl workshops 22411 *Theory and Practice of SAT and Combinatorial Solving* and 23261 *SAT Encodings and Beyond*. The computational experiments were enabled by resources provided by LUNARC at Lund University.

A Complete Overview of Proof Logging for MaxSAT Preprocessing

In this appendix, we provide a complete overview of proof logging for the preprocessing techniques implemented by MAXPRE. As we already presented proof logging for bounded variable elimination, subsumed literal elimination, label matching and binary core removal in Section 3 of the paper, we do not present those techniques here. In addition, we do not include intrinsic at-most-ones (even though implemented in MAXPRE), as it is already discussed in [4].

A.1 Fixing Variables

Many of the preprocessing techniques can fix variables (or literals) to either 0 or 1. We describe here the generic procedure that is invoked when a variable is fixed. Assume that a preprocessing technique decides to fix $\ell = 1$ for a literal ℓ . Then, in the preprocessor, each clause $C \vee \bar{\ell}$ is replaced by clause C , i.e., falsified literal $\bar{\ell}$ is removed. Additionally, each clause $C \vee \ell$ is removed (as they are satisfied when $\ell = 1$).

In the proof, we do the following. First, the technique that fixes $\ell = 1$, ensures that constraint $\ell \geq 1$ is in the core constraints of the proof. It may be that $\ell \geq 1$ is already in the core constraints of the proof (i.e. instance has a unit clause (ℓ)), or it may be that $\ell \geq 1$ needs to be introduced as a new constraint. The details on how $\ell \geq 1$ is introduced depends on the specific technique that is fixing $\ell = 1$. Now, assuming $\ell \geq 1$ is in the core constraints, the following procedure is invoked.

- (1) If ℓ or $\bar{\ell}$ appears in the objective function, the objective function is updated.
- (2) For each clause $C \vee \bar{\ell}$, the constraint $\text{PB}(C)$ is introduced as a sum of $\text{PB}(C \vee \bar{\ell})$ and $\ell \geq 1$.
- (3) Each constraint $\text{PB}(C \vee \ell)$ is deleted (as a RUP constraint).
- (4) Finally, the core constraint $\ell \geq 1$ is deleted last with witness $\{\ell \rightarrow 1\}$.

A.2 Preprocessing on the Initial WCNF Representation

We explain the preprocessing techniques that can be applied during preprocessing on the WCNF representation, detailing especially how the different types of clauses are handled. The preprocessing techniques applied on the WCNF representation only modify a clause C by either removing a literal ℓ from C or removing C entirely. With this intuition, given an input WCNF instance $\mathcal{F}^W = (F_H, F_S)$ and a working instance $\mathcal{F}_1^W = (F_H^1, F_S^1)$ each clause in \mathcal{F}_1^W is one of the following three types:

- (1) A hard clause $C \in F_H^1$ that is a subset or equal to a hard clause $C \subseteq C^{\text{orig}} \in F_H$ of \mathcal{F}^W .
- (2) An *originally unit soft clause*, i.e., a soft clause $C \in F_S^1$ that is equal to a unit soft clause in F_S .

- (3) An *originally non-unit soft clause*, i.e., $C \in F_S^1$ that is a subset or equal to a non-unit soft clause $C \subseteq C^{\text{orig}} \in F_S$ of \mathcal{F}^W .

With this we next detail how the preprocessing rules permitted on the WCNF representation are logged. In the following, we assume a fixed working WCNF instance.

Duplicate Clause Removal. In the paper we discussed how to log the removal of two duplicate clauses C and D when: (i) both are hard, or (ii) C is hard and D is an originally non-unit soft clause. Here we detail the remaining cases.

Assume first that both C and D are originally non-unit duplicate soft clauses with weights w^C and w^D , respectively. Then the proof has the core constraints $\text{PB}(C \vee b_C)$ and $\text{PB}(D \vee b_D)$ and its objective the terms $w^C b_C$ and $w^D b_D$. The removal of D is logged as follows.

- (1) Introduce the constraints: $\bar{b}_C + b_D \geq 1$ with the witness $\{b_C \rightarrow 0\}$ and $b_C + \bar{b}_D \geq 1$, with the witness $\{b_D \rightarrow 0\}$ to the core set. These encode $b_C = b_D$.
- (2) Update the objective by adding $-w^C b_C + w^C b_D$ to it, conceptually increasing the coefficient of b_D by w^C .
- (3) Remove the constraints introduced in step (1) using the same witnesses.
- (4) Remove the (RUP) constraint $\text{PB}(D \vee b_C)$.

If $C = (\bar{\ell})$ is originally a unit soft clause but $D = (\bar{\ell})$ is originally a non-unit soft clause, then the core constraints of the proof include constraint $\text{PB}(\ell \vee b_D)$ and the objective of the proof the terms $w^C \ell$ and $w^D b_D$. The removal of D is logged similarly to the previous case with the literal b_C replaced with ℓ .

The case of two duplicate originally unit soft clauses does not require proof logging since the corresponding terms in the objective are automatically summed.

Tautology Removal. If a clause is a tautology, it is also a RUP clause. Thus, a tautological hard clause is simply deleted. The removal of a tautological soft clause additionally requires updating the objective.

More specifically, assume C is a tautological soft clause of weight w^C . Then C is originally non-unit, so the proof has a constraint $\text{PB}(C \vee b_C)$ and its objective the term $w^C b_C$. The removal of C is logged with the following steps:

- (1) Delete the (RUP) constraint $\text{PB}(C \vee b_C)$.
- (2) Introduce the constraint $\bar{b}_C \geq 1$ with witness $\{b_C \rightarrow 0\}$ and move the new constraint to the core set.
- (3) Update the objective by adding $-w^C b_C$ to it.
- (4) Remove the constraint introduced in step (2) with the same witness.

Unit Propagation of Hard Clauses. If the instance contains a (hard) unit clause (l) , the literal l is fixed to 1 with the method of fixing variables described in Section A.1.

Removal of Empty Soft Clauses. If the instance contains an empty soft clause C —either as input or as a consequence of e.g., unit propagation—it is removed and the lower bound increased by its weight w^C . If C was originally non-unit, the core constraints of the proof contain the constraint $b_C \geq 1$ and the objective the term $w^C b_C$. The removal of C is logged by the following steps:

- (1) Update the objective by adding $-w^C b_C + w^C$.
- (2) Delete the constraint $b_C \geq 1$ with the witness $\{b_C \rightarrow 1\}$.

If $C = (\ell)$ is an originally unit soft clause the objective is updated in conjunction with the literal ℓ getting fixed to 0, as described in Section A.1. Thus, no further steps are required.

Blocked Clause Elimination (BCE) [42]. Our implementation of BCE considers a clause $C \vee \ell$ blocked (on the literal ℓ) if for each clause $D \vee \bar{\ell}$ there is a literal $\ell' \in D$ for which $\bar{\ell}' \in C$.

When preprocessing on the objective-centric representation, BCE considers only literals ℓ for which neither ℓ nor $\bar{\ell}$ appears in the objective function. During initial WCNF preprocessing stage, there are no requirements for literal ℓ . (Notice that whenever there is a unit clause (ℓ) , $C \vee \ell$ is not blocked on the literal ℓ .)

The removal of a blocked clause is logged as the deletion of the corresponding constraint $\text{PB}(C \vee \ell)$ with the witness $\{\ell \rightarrow 1\}$. If $C \vee \ell$ is an (originally non-unit) soft clause, the objective function is also updated exactly as with tautology removal.

Subsumption Elimination. A clause D is subsumed by the clause C if $C \subseteq D$. Whenever the subsuming clause C is hard, D is removed as a RUP clause. If D is soft, the objective function is updated exactly as with tautology removal.

A.3 Preprocessing on Objective-Centric Representation

We detail how the preprocessing techniques that are applied on the objective-centric representation (F, O) of the working instance are logged. In addition to these, the preprocessor can also apply the techniques detailed in Section A.2.

TrimMaxSAT [61]. The TrimMaxSAT technique heuristically looks for a set of literals N s.t. every solution ρ to F assigns each $\ell \in N$ to 0, or more formally, F entails the unit clause $(\bar{\ell})$. All such literals are fixed by the generic procedure (recall Section A.1). The literals to be fixed are identified by iterative calls to an (incremental) SAT solver [21,49] under different assumptions.

In order to log the TrimMaxSAT technique we log the proof produced by each SAT solver call into the derived set of constraints in our PB proof. After the set N is identified, we make $|N|$ extra SAT calls, one for each $\ell \in N$. Each call is made assuming the value of ℓ to 1. Due to the properties of TrimMaxSAT and SAT-solvers, the result will be UNSAT, after which $\bar{\ell} \geq 1$ will be RUP w.r.t

to the current set of core and derived constraints. As such it is added and moved to core in order to invoke the generic variable fixing procedure. Finally, when TrimMaxSAT will not be used any more, all constraints added to the derived set by the SAT solver are removed.

Self-Subsuming Resolution (SSR) [20,60]. Given clauses $C \vee l$ and $D \vee \bar{\ell}$ such that C subsumes D and ℓ is not in the objective, SSR substitutes D for $D \vee \bar{\ell}$. The proof has two steps: (1) Introduce $\text{PB}(D)$ as a new RUP constraint. (2) Remove $\text{PB}(D \vee \bar{\ell})$ as it is RUP.

Group-Subsumed Label Elimination (GSLE) [43]. Let b be an objective variable that has the coefficient c^b in O , and L a set of objective variables such that each $b_i \in L$ has coefficient c^i in O . Assume then that (i) $c^b \geq \sum_{b_i \in L} c^i$, (ii) the negation of b or any variables in L do not appear in any clauses, and (iii) $\{C \mid b \in C\} \subseteq \{D \mid \exists b \in L : b \in D\}$. Then, an application of GSLE fixes $b = 0$. To prove an application of GSLE, we introduce the constraint $\bar{b} \geq 1$ with the witness $\{b \rightarrow 0, b_i \rightarrow 1 \mid b_i \in L\}$, and invoke the generic variable fixing procedure detailed in Section A.1 to fix $b = 0$.

Bounded Variable Addition (BVA) [48]. Consider a set of literals M_{lit} and a set of clauses $M_{cls} \subseteq F$, such that for all $\ell \in M_{lit}$ and $C \in M_{cls}$, each clause $(C \setminus M_{lit} \cup \{\ell\})$ is either in F or a tautology. Then an application of BVA adds the clauses $S_x = \{(\ell \vee x) \mid \ell \in M_{lit}\}$ and $S_{\bar{x}} = \{(C \setminus M_{lit}) \cup \{\bar{x}\} \mid C \in M_{cls}\}$, and removes the clauses $C \setminus M_{lit}$.

An application of BVA is logged as follows: (1) Add the constraint $\text{PB}(C)$ for each $C \in S_{\bar{x}}$ with the witness $\{x \rightarrow 0\}$. (2) Add the constraint $\text{PB}(C)$ for each $C \in S_x$ with the witness $\{x \rightarrow 1\}$. (3) Delete each constraint $\text{PB}(C)$ for $C \in M_{cls}$ as a RUP constraint.

Structure-based Labelling [43]. Given an objective variable b and a clause C that is blocked on the literal ℓ , when $b = 1$, an application of structure-based labelling replaces C with $C \vee b$. The proof is logged as follows: (1) Introduce the constraint $\text{PB}(C \vee b)$ that is RUP. (2) Delete the constraint $\text{PB}(C)$ with the witness $\{\ell \rightarrow 1\}$.

Failed Literal Elimination (FLE) [25,45,75]. A literal ℓ is failed (denoted $\ell \vdash_{\text{up}} \perp$) if setting $\ell = 1$ allows unit propagation to derive a conflict (i.e., an empty clause). An application of FLE fixes $\ell = 0$ when ℓ is a failed literal for which $\bar{\ell}$ is not in the objective.

In addition to standard FLE, MAXPRE implements an extension that also fixes a literal $\ell = 0$ if: (i) $\bar{\ell}$ is not in the objective function (ii) each clause in F that contains ℓ also contains some other literal ℓ' that is implied by ℓ by unit propagation (denoted $\ell \vdash_{\text{up}} \ell'$), i.e., setting $\ell = 1$ also fixes $\ell' = 1$ after a sequence of unit propagation steps is applied.

Logging FLE. For a failed literal ℓ the constraint $\bar{\ell} \geq 1$ is RUP. For the extended technique the constraint $\bar{\ell} \geq 1$ is introduced with the witness $\{\ell \rightarrow 0\}$. Afterwards the generic procedure for fixing literals described in Section A.1 is invoked.

Implied Literal Detection. If both a literal ℓ_1 and its negation $\bar{\ell}_1$ imply another literal ℓ_2 by unit propagation (i.e., propagating either $\ell = 1$ or $\ell = 0$ also propagates $\ell_2 = 1$), the preprocessor fixes $\ell_2 = 1$.

As an extension to this technique, the preprocessor also fixes $\ell_2 = 1$ if (i) ℓ_1 implies ℓ_2 by unit propagation, (ii) neither ℓ_1 nor ℓ_2 appear in the objective function in either polarity, and (iii) each clause containing $\bar{\ell}_2$ also contains some other literal ℓ' that is implied by $\bar{\ell}_1$ by unit propagation.

Logging Implied Literals. For some intuition, note that $\ell_1 \vdash_{\text{up}} \ell_2$ does not in general imply $\bar{\ell}_2 \vdash_{\text{up}} \bar{\ell}_1$. Thus, there is no guarantee that $\ell_2 \geq 1$ would be RUP. Given that $\ell_1 \vdash_{\text{up}} \ell_2$ and $\bar{\ell}_1 \vdash_{\text{up}} \ell_2$, the proof is instead logged as follows:

- (1) Add $\bar{\ell}_1 + \ell_2 \geq 1$ and $\ell_1 + \ell_2 \geq 1$ that are both RUP.
- (2) Introduce the constraint $\ell_2 \geq 1$ by divide the sum of constraints introduced in step (1) by 2. Move the new constraint to the core constraints.
- (3) Delete the constraints introduced in step (1).
- (4) Invoke the generic procedure detailed in Section A.1 to fix $\ell_2 = 1$.

The extended technique is logged by first adding the constraint $\ell_1 + \ell_2 \geq 1$ with the witness $\{\ell_2 \rightarrow 1\}$. For some intuition, if the constraint is falsified, the assumptions guarantee that $\ell' = 1$ so the value of ℓ_2 can be flipped without falsifying other constraints.

Equivalent Literal Substitution [12,47,71]. If $\ell_1 \vdash_{\text{up}} \ell_2$ and $\bar{\ell}_1 \vdash_{\text{up}} \bar{\ell}_2$, the equivalent literal technique substitutes ℓ_1 with ℓ_2 . As an extension to this technique, the same substitution is applied also in cases where the following three conditions hold: (i) $\ell_1 \vdash_{\text{up}} \ell_2$, (ii) neither ℓ_1 nor ℓ_2 appear in the objective function in either polarity, and (iii) $\bar{\ell}_1$ implies some other literal in each clause containing $\bar{\ell}_2$ by unit propagation.

Logging Equivalent Literals. An application of equivalent literal substitution is logged as follows.

- (1) Introduce the clauses $\bar{\ell}_1 + \ell_2 \geq 1$ and $\ell_1 + \bar{\ell}_2 \geq 1$ as RUP. In the case of the extended technique, $\ell_1 + \bar{\ell}_2 \geq 1$ is added with the witness $\{\ell_2 \rightarrow 0\}$.
- (2) For each clause $C \vee \ell_1$, replace $\text{PB}(C \vee \ell_1)$ with $\text{PB}(C \vee \ell_2)$ with the RUP rule.
- (3) For each clause $C \vee \bar{\ell}_1$, replace $\text{PB}(C \vee \bar{\ell}_1)$ with $\text{PB}(C \vee \bar{\ell}_2)$ with the RUP rule.
- (4) If ℓ_1 or $\bar{\ell}_1$ appear in the objective function, replace them with ℓ_2 and $\bar{\ell}_2$, respectively.
- (5) Remove the constraints introduced in step (1).

Hardening [2,39,56]. Given an upper bound UB for the optimal cost of (F, O) and an objective variable b that has a coefficient $w^b > UB$ in O , hardening fixes $b = 0$. Proof logging for hardening has been previously studied in [4]. In [4], however, the hardening is done with the presence of so-called objective-improving constraints, i.e., constraints of form $O \leq UB - 1$, where UB is the cost of the best currently known solution. In the context of preprocessing where the preprocessor should provide an equioptimal instance as an output, introducing objective-improving constraints to the instance is not possible. Instead, given a solution ρ to F with cost $O(\rho) = UB$ and an objective variable b with $w^b > UB$, we introduce the constraint $\bar{b} \geq 1$ with ρ as the witness and then invoke the generic procedure for fixing variables, as detailed in Section A.1.

A.4 Conversion to WCNF — Renaming Variables

In the final stage of preprocessing, MAXPRE converts the instance to WCNF. The conversion removes the objective constant as described in Section 3.1 of the main paper. Additionally, the conversion ‘renames’ (some of) the variables.

There are two reasons for renaming variables. The first is to remove any gaps in the indexing of variables. In WCNF, variables are named with integers. During preprocessing, some variables in the instance might have been eliminated from the instance. At the end MAXPRE compacts the range of variables to be continuous and start from 1. The second reason for renaming variables is to sync names between WCNF and the pseudo-Boolean proof. In the pseudo-Boolean proofs, the naming scheme of variables is different, valid variable names include, for instance, x_1 , x_2 , y_{15} , $_b4$. When a WCNF instance is converted to a pseudo-Boolean instance, the variable i of the WCNF instance is mapped to the variable x_i of the pseudo-Boolean instance. For j th non-unit soft clause of a WCNF instance, the conversion introduces a variable $_bj$. During preprocessing, the ‘proof logger’ of MAXPRE takes care of mapping MAXPRE variables to correct variable names in proof. In the end, however, MAXPRE produces an output WCNF file, and at this point, each variable i of WCNF instance should again correspond to variable x_i of proof. Thus, for example, all $_b$ -variables are replaced with x -variables.

Logging variable naming. Assume that the instance has a set of variables V and for each $x \in V$, we wish to use name $f(x)$ instead of x in the end. We do proof logging for variable renaming in two phases. (1) For each $x \in V$, introduce temporary variable t_x , set $x = t_x$ and then ‘move’ all the constraints and the objective function to the temporary namespace. The original constraints and encodings for $x = t_x$ are then removed. (2) For each $x \in V$, introduce $f(x) = t_x$, and ‘move’ the constraints and the objective to the final namespace. The temporary constraints and encodings are then removed.

A.5 On Solution Reconstruction and Instances Solved During Preprocessing

Finally, we note that while the focus of this work has been on certifying the preservation of the costs of solutions, in practice our certified preprocessor also allows reconstructing a minimum-cost solution to the input. More precisely, consider an input WCNF instance \mathcal{F}^W , a preprocessed instance \mathcal{F}_P^W , and an optimal solution ρ_p to \mathcal{F}_P^W . Then MAXPRE can compute an optimal solution ρ to \mathcal{F}^W in linear time with respect to the number of preprocessing steps performed. More details can be found in [43].

Importantly, the optimality of a reconstructed solution can be easily verified without considering how the reconstruction is implemented in practice; given that we have verified the equioptimality of \mathcal{F}^W and \mathcal{F}_P^W , and that ρ_p is an optimal solution to \mathcal{F}_P^W , the optimality of reconstructed ρ to \mathcal{F}^W can be verified by checking that (i) ρ indeed is a solution to \mathcal{F}^W (ii) The cost of ρ w.r.t. \mathcal{F}^W is equivalent to the cost of ρ_p w.r.t. \mathcal{F}_P^W .

On a related note, MAXPRE can actually solve some instances during preprocessing, either by: (i) determining that the hard clauses do not have solutions, or (ii) computing an optimal solution to some working instance. In practice (i) happens by the derivation of the unsatisfiable empty (hard) clause and (ii) by the removal of every single clause from the working instance. We have designed the preprocessor to always terminate with an output WCNF and a proof of equioptimality rather than producing different kinds of proofs.

If an empty hard clause is derived, the preprocessing is immediately terminated and an output WCNF instance containing a single hard empty clause produced. Additionally, an empty constraint $0 \geq 1$ is added to the proof and all other core constraints deleted by the RUP rule. Notice how the proof of equioptimality between the input and output can in this case be seen as a proof of infeasibility of the input hard clauses.

If all clauses are removed from the working instance, MaxPRE terminates and outputs the instance obtained after constant removal (recall Stage 5 in Section 3) on an instance without other clauses.

References

1. Alkassar, E., Böhme, S., Mehlhorn, K., Rizkallah, C., Schweitzer, P.: An introduction to certifying algorithms. *it - Information Technology Methoden und innovative Anwendungen der Informatik und Informationstechnik* **53**(6), 287–293 (Dec 2011)
2. Ansótegui, C., Bonet, M.L., Gabàs, J., Levy, J.: Improving SAT-based weighted MaxSAT solvers. In: Proceedings of the 18th International Conference on Principles and Practice of Constraint Programming, (CP '12). Lecture Notes in Computer Science, vol. 7514, pp. 86–101. Springer (2012)
3. Berg, J., Bacchus, F., Poole, A.: Abstract cores in implicit hitting set MaxSat solving. In: Proceedings of the 23rd International Conference on Theory and Applications of Satisfiability Testing (SAT '20). Lecture Notes in Computer Science, vol. 12178, pp. 277–294. Springer (Jul 2020)

4. Berg, J., Bogaerts, B., Nordström, J., Oertel, A., Vandesande, D.: Certified core-guided MaxSAT solving. In: Proceedings of the 29th International Conference on Automated Deduction (CADE-29). Lecture Notes in Computer Science, vol. 14132, pp. 1–22. Springer (Jul 2023)
5. Berg, J., Järvisalo, M.: Unifying reasoning and core-guided search for maximum satisfiability. In: Proceedings of the 16th European Conference on Logics in Artificial Intelligence, (JELIA '19). Lecture Notes in Computer Science, vol. 11468, pp. 287–303. Springer (2019)
6. Berg, J., Saikko, P., Järvisalo, M.: Subsumed label elimination for maximum satisfiability. In: Kaminka, G.A., Fox, M., Bouquet, P., Hüllermeier, E., Dignum, V., Dignum, F., van Harmelen, F. (eds.) Proceedings of the 22nd European Conference on Artificial Intelligence, (ECAI '16). FAIA, vol. 285, pp. 630–638. IOS Press (2016)
7. Biere, A.: Tracecheck. <http://fmv.jku.at/tracecheck/> (2006)
8. Biere, A., Heule, M.J.H., van Maaren, H., Walsh, T. (eds.): Handbook of Satisfiability, Frontiers in Artificial Intelligence and Applications, vol. 336. IOS Press, 2nd edn. (Feb 2021)
9. Bogaerts, B., Gocht, S., McCreesh, C., Nordström, J.: Certified dominance and symmetry breaking for combinatorial optimisation. *Journal of Artificial Intelligence Research* **77**, 1539–1589 (Aug 2023), preliminary version in *AAAI '22*
10. Bogaerts, B., McCreesh, C., Myreen, M.O., Nordström, J., Oertel, A., Tan, Y.K.: Documentation of VeriPB and CakePB for the SAT competition 2023 (Mar 2023), available at <https://satcompetition.github.io/2023/checkers.html>
11. Bonet, M.L., Levy, J., Manyà, F.: Resolution for Max-SAT. *Artificial Intelligence* **171**(8-9), 606–618 (2007)
12. Brafman, R.I.: A simplifier for propositional formulas with many binary clauses. *IEEE Transactions on Systems, Man, and Cybernetics, Part B (Cybernetics)* **34**(1), 52–59 (2004)
13. Brummayer, R., Lonsing, F., Biere, A.: Automated testing and debugging of SAT and QBF solvers. In: Proceedings of the 13th International Conference on Theory and Applications of Satisfiability Testing (SAT '10). Lecture Notes in Computer Science, vol. 6175, pp. 44–57. Springer (Jul 2010)
14. Buss, S.R., Nordström, J.: Proof complexity and SAT solving. In: Biere et al. [8], chap. 7, pp. 233–350
15. Cook, W., Coullard, C.R., Turán, G.: On the complexity of cutting-plane proofs. *Discrete Applied Mathematics* **18**(1), 25–38 (Nov 1987)
16. Cruz-Filipe, L., Heule, M.J.H., Hunt Jr., W.A., Kaufmann, M., Schneider-Kamp, P.: Efficient certified RAT verification. In: Proceedings of the 26th International Conference on Automated Deduction (CADE-26). Lecture Notes in Computer Science, vol. 10395, pp. 220–236. Springer (Aug 2017)
17. Cruz-Filipe, L., Marques-Silva, J.P., Schneider-Kamp, P.: Efficient certified resolution proof checking. In: Proceedings of the 23rd International Conference on Tools and Algorithms for the Construction and Analysis of Systems (TACAS '17). Lecture Notes in Computer Science, vol. 10205, pp. 118–135. Springer (Apr 2017)
18. Davies, J., Bacchus, F.: Solving MAXSAT by solving a sequence of simpler SAT instances. In: Proceedings of the 17th International Conference on Principles and Practice of Constraint Programming (CP '11). Lecture Notes in Computer Science, vol. 6876, pp. 225–239. Springer (Sep 2011)
19. Davies, J., Bacchus, F.: Exploiting the power of MIP solvers in MAXSAT. In: Proceedings of the 16th International Conference on Theory and Applications of

- Satisfiability Testing (SAT '13). Lecture Notes in Computer Science, vol. 7962, pp. 166–181. Springer (Jul 2013)
20. Eén, N., Biere, A.: Effective preprocessing in SAT through variable and clause elimination. In: Proceedings of the 8th International Conference on Theory and Applications of Satisfiability Testing (SAT '05). Lecture Notes in Computer Science, vol. 3569, pp. 61–75. Springer (Jun 2005)
 21. Eén, N., Sörensson, N.: Temporal induction by incremental SAT solving. In: Strichman, O., Biere, A. (eds.) First International Workshop on Bounded Model Checking, (BMC '03). Electronic Notes in Theoretical Computer Science, vol. 89, pp. 543–560. Elsevier (2003)
 22. Eén, N., Sörensson, N.: Translating pseudo-Boolean constraints into SAT. Journal on Satisfiability, Boolean Modeling and Computation **2**(1-4), 1–26 (Mar 2006)
 23. Elffers, J., Gocht, S., McCreesh, C., Nordström, J.: Justifying all differences using pseudo-Boolean reasoning. In: Proceedings of the 34th AAAI Conference on Artificial Intelligence (AAAI '20). pp. 1486–1494 (Feb 2020)
 24. Filmus, Y., Mahajan, M., Sood, G., Vinyals, M.: MaxSAT resolution and subcube sums. In: Proceedings of the 23rd International Conference on Theory and Applications of Satisfiability Testing (SAT '20). Lecture Notes in Computer Science, vol. 12178, pp. 295–311. Springer (Jul 2020)
 25. Freeman, J.W.: Improvements to Propositional Satisfiability Search Algorithms. Ph.D. thesis, University of Pennsylvania, USA (1995), uMI Order No. GAX95-32175
 26. Gimpel, J.F.: A reduction technique for prime implicant tables. In: Proceedings of the 5th Annual Symposium on Switching Circuit Theory and Logical Design, (SWCT '64). pp. 183–191. IEEE Computer Society (1964)
 27. Gocht, S., Martins, R., Nordström, J., Oertel, A.: Certified CNF translations for pseudo-Boolean solving. In: Proceedings of the 25th International Conference on Theory and Applications of Satisfiability Testing (SAT '22). Leibniz International Proceedings in Informatics (LIPIcs), vol. 236, pp. 16:1–16:25 (Aug 2022)
 28. Gocht, S., McBride, R., McCreesh, C., Nordström, J., Prosser, P., Trimble, J.: Certifying solvers for clique and maximum common (connected) subgraph problems. In: Proceedings of the 26th International Conference on Principles and Practice of Constraint Programming (CP '20). Lecture Notes in Computer Science, vol. 12333, pp. 338–357. Springer (Sep 2020)
 29. Gocht, S., McCreesh, C., Myreen, M.O., Nordström, J., Oertel, A., Tan, Y.K.: End-to-end verification for subgraph solving. In: Proceedings of the 36th AAAI Conference on Artificial Intelligence (AAAI '24) (Feb 2024), to appear
 30. Gocht, S., McCreesh, C., Nordström, J.: Subgraph isomorphism meets cutting planes: Solving with certified solutions. In: Proceedings of the 29th International Joint Conference on Artificial Intelligence (IJCAI '20). pp. 1134–1140 (Jul 2020)
 31. Gocht, S., McCreesh, C., Nordström, J.: An auditable constraint programming solver. In: Proceedings of the 28th International Conference on Principles and Practice of Constraint Programming (CP '22). Leibniz International Proceedings in Informatics (LIPIcs), vol. 235, pp. 25:1–25:18 (Aug 2022)
 32. Gocht, S., Nordström, J.: Certifying parity reasoning efficiently using pseudo-Boolean proofs. In: Proceedings of the 35th AAAI Conference on Artificial Intelligence (AAAI '21). pp. 3768–3777 (Feb 2021)
 33. Goldberg, E., Novikov, Y.: Verification of proofs of unsatisfiability for CNF formulas. In: Proceedings of the Conference on Design, Automation and Test in Europe (DATE '03). pp. 886–891 (Mar 2003)

34. Guéneau, A., Myreen, M.O., Kumar, R., Norrish, M.: Verified characteristic formulae for CakeML. In: Proceedings of the 26th European Symposium on Programming (ESOP '17). Lecture Notes in Computer Science, vol. 10201, pp. 584–610. Springer (Apr 2017)
35. Heule, M.J.H., Hunt Jr., W.A., Wetzler, N.: Trimming while checking clausal proofs. In: Proceedings of the 13th International Conference on Formal Methods in Computer-Aided Design (FMCAD '13). pp. 181–188 (Oct 2013)
36. Heule, M.J.H., Hunt Jr., W.A., Wetzler, N.: Verifying refutations with extended resolution. In: Proceedings of the 24th International Conference on Automated Deduction (CADE-24). Lecture Notes in Computer Science, vol. 7898, pp. 345–359. Springer (Jun 2013)
37. Hoen, A., Oertel, A., Gleixner, A., Nordström, J.: Certifying MIP-based presolve reductions for 0–1 integer linear programs. In: Proceedings of the 21st International Conference on the Integration of Constraint Programming, Artificial Intelligence, and Operations Research (CPAIOR '24) (May 2024), to appear
38. Ignatiev, A., Morgado, A., Marques-Silva, J.: RC2: an efficient maxsat solver. *Journal on Satisfiability, Boolean Modeling and Computation* **11**(1), 53–64 (2019)
39. Ihalainen, H., Berg, J., Järvisalo, M.: Clause redundancy and preprocessing in maximum satisfiability. In: Proceedings of the 11th International Joint Conference on Automated Reasoning (IJCAR '22). Lecture Notes in Computer Science, vol. 13385, pp. 75–94. Springer (Aug 2022)
40. Ihalainen, H., Oertel, A., Tan, Y.K., Berg, J., Järvisalo, M., Myreen, M.O., Nordström, J.: Experimental Repository for “Certified MaxSAT Preprocessing” (Feb 2024). <https://doi.org/10.5281/zenodo.10630852>
41. Jabs, C., Berg, J., Ihalainen, H., Järvisalo, M.: Preprocessing in sat-based multi-objective combinatorial optimization. In: Yap, R.H.C. (ed.) Proceedings of the 29th International Conference on Principles and Practice of Constraint Programming, (CP '23). *LIPICs*, vol. 280, pp. 18:1–18:20. Schloss Dagstuhl - Leibniz-Zentrum für Informatik (2023)
42. Järvisalo, M., Biere, A., Heule, M.: Blocked clause elimination. In: Esparza, J., Majumdar, R. (eds.) Proceedings of the 16th International Conference on Tools and Algorithms for the Construction and Analysis of Systems, (TACAS '10). Lecture Notes in Computer Science, vol. 6015, pp. 129–144. Springer (2010)
43. Korhonen, T., Berg, J., Saikko, P., Järvisalo, M.: MaxPre: An extended MaxSAT preprocessor. In: Gaspers, S., Walsh, T. (eds.) Proceedings of the 20th International Conference on Theory and Applications of Satisfiability Testing, (SAT '17). Lecture Notes in Computer Science, vol. 10491, pp. 449–456. Springer (2017)
44. Larrosa, J., Nieuwenhuis, R., Oliveras, A., Rodríguez-Carbonell, E.: A framework for certified Boolean branch-and-bound optimization. *Journal of Automated Reasoning* **46**(1), 81–102 (2011)
45. Le Berre, D.: Exploiting the real power of unit propagation lookahead. *Electronic Notes in Discrete Mathematics* **9**, 59–80 (2001)
46. Le Berre, D., Parrain, A.: The Sat4j library, release 2.2. *Journal on Satisfiability, Boolean Modeling and Computation* **7**, 59–64 (Jul 2010)
47. Li, C.M.: Integrating equivalency reasoning into davis-putnam procedure. In: Kautz, H.A., Porter, B.W. (eds.) Proceedings of the Seventeenth National Conference on Artificial Intelligence and Twelfth Conference on Innovative Applications of Artificial Intelligence. pp. 291–296. AAAI Press / The MIT Press (2000)
48. Manthey, N., Heule, M.J.H., Biere, A.: Automated reencoding of Boolean formulas. In: 8th International Haifa Verification Conference (HVC '12), Revised Selected Papers. Lecture Notes in Computer Science, vol. 7857, pp. 102–117. Springer (2013)

49. Marques-Silva, J., Lynce, I., Malik, S.: Conflict-driven clause learning SAT solvers. In: Biere, A., Heule, M., van Maaren, H., Walsh, T. (eds.) *Handbook of Satisfiability - Second Edition, Frontiers in Artificial Intelligence and Applications*, vol. 336, pp. 133–182. IOS Press (2021)
50. MaxPre 2 : MaxSAT preprocessor. <https://bitbucket.org/coreo-group/maxpre2>
51. MaxSAT evaluations: Evaluating the state of the art in maximum satisfiability solver technology. <https://maxsat-evaluations.github.io/>
52. MaxSAT evaluation 2023. <https://maxsat-evaluations.github.io/2023> (Jul 2023)
53. McConnell, R.M., Mehlhorn, K., Näher, S., Schweitzer, P.: Certifying algorithms. *Computer Science Review* **5**(2), 119–161 (May 2011)
54. McIlree, M., McCreesh, C.: Proof logging for smart extensional constraints. In: *Proceedings of the 29th International Conference on Principles and Practice of Constraint Programming (CP '23)*. *Leibniz International Proceedings in Informatics (LIPIcs)*, vol. 280, pp. 26:1–26:17 (Aug 2023)
55. McIlree, M., McCreesh, C., Nordström, J.: Proof logging for the circuit constraint. In: *Proceedings of the 21st International Conference on the Integration of Constraint Programming, Artificial Intelligence, and Operations Research (CPAIOR '24)* (May 2024), to appear
56. Morgado, A., Heras, F., Marques-Silva, J.: Improvements to core-guided binary search for maxsat. In: Cimatti, A., Sebastiani, R. (eds.) *Proceedings of the 15th International Conference on Theory and Applications of Satisfiability Testing, (SAT '12)*. *Lecture Notes in Computer Science*, vol. 7317, pp. 284–297. Springer (2012)
57. Morgado, A., Ignatiev, A., Bonet, M.L., Marques-Silva, J.P., Buss, S.R.: DR-MaxSAT with MaxHS: First contact. In: *Proceedings of the 22nd International Conference on Theory and Applications of Satisfiability Testing (SAT '19)*. *Lecture Notes in Computer Science*, vol. 11628, pp. 239–249. Springer (Jul 2019)
58. Morgado, A., Marques-Silva, J.: On validating Boolean optimizers. In: *Proceedings of the 23rd IEEE International Conference on Tools with Artificial Intelligence, (ICTAI '11)*. pp. 924–926 (2011)
59. Myreen, M.O., Owens, S.: Proof-producing translation of higher-order logic into pure and stateful ML. *Journal of Functional Programming* **24**(2–3), 284–315 (Jan 2014)
60. Ostrowski, R., Grégoire, É., Mazure, B., Sais, L.: Recovering and exploiting structural knowledge from CNF formulas. In: Hentenryck, P.V. (ed.) *Proceedings of the 8th International Conference on Principles and Practice of Constraint Programming, (CP '02)*. *Lecture Notes in Computer Science*, vol. 2470, pp. 185–199. Springer (2002)
61. Paxian, T., Raiola, P., Becker, B.: On preprocessing for weighted MaxSAT. In: *Proceedings of the 22nd International Conference on Verification, Model Checking, and Abstract Interpretation, (VMCAI '21)*. *Lecture Notes in Computer Science*, vol. 12597, pp. 556–577. Springer (2021)
62. Paxian, T., Reimer, S., Becker, B.: Dynamic polynomial watchdog encoding for solving weighted MaxSAT. In: *Proceedings of the 21st International Conference on Theory and Applications of Satisfiability Testing (SAT '18)*. *Lecture Notes in Computer Science*, vol. 10929, pp. 37–53. Springer (Jul 2018)
63. Py, M., Cherif, M.S., Habet, D.: Towards bridging the gap between SAT and MaxSAT refutations. In: *Proceedings of the 32nd IEEE International Conference on Tools with Artificial Intelligence (ICTAI '20)*. pp. 137–144 (Nov 2020)

64. Py, M., Cherif, M.S., Habet, D.: A proof builder for Max-SAT. In: Proceedings of the 24th International Conference on Theory and Applications of Satisfiability Testing (SAT '21). Lecture Notes in Computer Science, vol. 12831, pp. 488–498. Springer (Jul 2021)
65. Py, M., Cherif, M.S., Habet, D.: Proofs and certificates for Max-SAT. *Journal of Artificial Intelligence Research* **75**, 1373–1400 (Dec 2022)
66. The international SAT Competitions web page. <http://www.satcompetition.org>
67. Slind, K., Norrish, M.: A brief overview of HOL4. In: Proceedings of the 21st International Conference on Theorem Proving in Higher Order Logics (TPHOLs '08). Lecture Notes in Computer Science, vol. 5170, pp. 28–32. Springer (Aug 2008)
68. Subbarayan, S., Pradhan, D.K.: NiVER: Non-increasing variable elimination resolution for preprocessing SAT instances. In: Hoos, H.H., Mitchell, D.G. (eds.) Proceedings of the 7th International Conference on Theory and Applications of Satisfiability Testing, (SAT '04). Lecture Notes in Computer Science, vol. 3542, pp. 276–291. Springer (2004)
69. Tan, Y.K., Heule, M.J.H., Myreen, M.O.: Verified propagation redundancy and compositional UNSAT checking in CakeML. *International Journal on Software Tools for Technology Transfer* **25**, 167–184 (Feb 2023), preliminary version in *TACAS '21*
70. Tan, Y.K., Myreen, M.O., Kumar, R., Fox, A.C.J., Owens, S., Norrish, M.: The verified CakeML compiler backend. *Journal of Functional Programming* **29**, e2:1–e2:57 (Feb 2019)
71. Van Gelder, A.: Toward leaner binary-clause reasoning in a satisfiability solver. *Annals of Mathematics and Artificial Intelligence* **43**(1), 239–253 (2005)
72. Vandesande, D., De Wulf, W., Bogaerts, B.: QMaxSATpb: A certified MaxSAT solver. In: Proceedings of the 16th International Conference on Logic Programming and Non-monotonic Reasoning (LPNMR '22). Lecture Notes in Computer Science, vol. 13416, pp. 429–442. Springer (Sep 2022)
73. VeriPB: Verifier for pseudo-Boolean proofs. <https://gitlab.com/MIAOresearch/software/VeriPB>
74. Wetzler, N., Heule, M.J.H., Hunt Jr., W.A.: DRAT-trim: Efficient checking and trimming using expressive clausal proofs. In: Proceedings of the 17th International Conference on Theory and Applications of Satisfiability Testing (SAT '14). Lecture Notes in Computer Science, vol. 8561, pp. 422–429. Springer (Jul 2014)
75. Zabih, R., McAllester, D.A.: A rearrangement search strategy for determining propositional satisfiability. In: Shrobe, H.E., Mitchell, T.M., Smith, R.G. (eds.) Proceedings of the 7th National Conference on Artificial Intelligence, (AAAI '88). pp. 155–160. AAAI Press / The MIT Press (1988)