

arXiv:2404.15896v2 [math.CT] 21 Jun 2024

A Homological View of Categorical Algebra

George Peschke and Tim Van der Linden

June 24, 2024

Abstract We provide a foundation for working with homological and homotopical methods in categorical algebra. This involves two mutually complementary components, namely (a) the strategic selection of suitable axiomatic frameworks, some well known and some new, and (b) the development of categorical tools for effective reasoning and computing within those frameworks.

The selection of axiomatic frameworks begins ‘from the ground up’ with z -exact categories. These are pointed categories in which every morphism has a kernel and cokernel. Then we progress all the way to abelian categories, en route meeting contexts such as Borceux–Bourn homological categories and Janelidze–Márki–Tholen semiabelian categories. We clarify the relationship between these axiomatic frameworks by direct comparison, but also by explaining how concrete examples fit into the selection. The outcome is a fine-grained set of criteria by which one can map varieties of algebras (in the sense of Universal Algebra) and topological models of algebraic theories into the various frameworks.

The categorical tools for effective computation deal mostly with situations involving universal factorizations of morphisms, with exact sequences, and with the homology of chain complexes.

Further, the categorical tools for computation include the ‘basic diagram lemmas’ of homological algebra, that is the (Short) 5-Lemma, the (3×3) -Lemma, the Snake Lemma, and applications thereof. We find that these tools are even available in some surprisingly weak categorical environments, such as the category of pointed sets. In discovering such features, we make systematic use of what we call the self-dual axis of a category.

Preface

From the ground up, we develop those aspects of Categorical Algebra which allow a categorical approach to homological methods in potentially non-abelian categories. In doing so, we build on several earlier developments, and we add a number of new insights.

To recap, by the 1950's Universal Algebra had evolved into a well established subject. Then arrived the highly influential notion of *abelian category* [22, 43]. It quickly motivated efforts to create a non-commutative analogue relevant to corresponding types of universal algebras and beyond. The conflicting demands for broadest possible applicability vs. strong categorical tools for computation resulted a number of approaches such as the works of Gerstenhaber, Huq, and Orzech amongst others [49, 37, 70].

It took till the turn of the millennium until these efforts came to a kind of confluence when Janelidze, Márki, and Tholen introduced *semiabelian* categories [51]. Their work took into account then recent novelties in Category Theory such as the concepts of Barr exactness [4] and Bourn protomodularity [14]. Soon thereafter, Borceux and Bourn [10] proposed the broader and, as a consequence, computationally weaker environment of *homological* categories. Its scope reaches beyond semiabelian categories and includes categories of topological-algebraic objects such as topological groups.

Initially, our goal was to create a systematic foundation for the fruitful use of these new categorical methods within the framework of Quillen's homotopical algebra; relying specifically on his remarkable Theorem 4 in Section [75, II.4]. Then we realized that a systematic homological view of categorical algebra opens up new opportunities to the effect that key tools for computations with homological invariants are actually available in settings where, historically, they were not expected to be valid. For example 'diagram lemmas' such as the (Short) 5-Lemma, the (3×3) -Lemma, the Snake Lemma hold true in the category Set_* of pointed sets.

Accordingly, we shifted our approach, and developed the from-the-ground-up view of homological methods presented here. As a 'side effect' the reader will also find an ample display of categorical methods for investigation and computation; methods which unify

processes which had previously been based on element manipulation. - For further details about these developments, we refer the reader to the introductions to parts, chapters, and sections.

An environmental scan reveals a rich web of axiom systems which are related to our objectives in one way or another. We dedicate an entire chapter to the purpose of making this web more transparent to the non-specialist.

The Role of Exercises

Most sections end with a set of exercises of varying purpose and varying level of difficulty. The reader will find ample opportunity to practice the use of the categorical methods presented here, often in contrast with arguments based on the manipulation of elements in underlying sets. Then there is the development of explicit examples in familiar categories, such as monoids, groups, etc. We also turned certain questions which we currently are unable to answer into exercises; these are labelled 'ANK' for 'answer not known'.

Acknowledgements

We are grateful to the *Pacific Institute for the Mathematical Sciences* for inviting us to visit their beautiful environment to work on this manuscript, and to the *Institut de Recherche en Mathématique et Physique* of the Université catholique de Louvain for inviting George Peschke to Louvain-la-Neuve on several occasions. Many thanks to those who have read a very preliminary version of this text: Florent Afsa, Maxime Culot and Bo Shan Deval. Many thanks also to Marino Gran and Joost Vercruyse for fruitful discussions.

Tim Van der Linden is a Senior Research Associate of the Fonds de la Recherche Scientifique-FNRS.

Notes

On the arXiv editions For the time being, this is a living document. More topics will be added¹, and the current document will evolve accordingly to form a coherent exposition. We welcome any comments and suggestions you may have.

George Peschke
Department of Math. and Stat. Sciences
University of Alberta
Edmonton
Canada T6G 2G1
e-mail: george.peschke@ualberta.ca

Tim Van der Linden
Institut de Recherche en Mathématique et Physique
Université catholique de Louvain
chemin du cyclotron 2 bte L7.01.02
B-1348 Louvain-la-Neuve
Belgium
e-mail: tim.vanderlinden@uclouvain.be

¹Chapters on varieties of algebras and internal actions are in preparation, as is a more extensive bibliography.

Contents

Preface	iii
I Homology in Pointed Categories	1
1 z-Exact Categories	15
1.1 Subobjects and Quotient Objects	17
1.2 Initial, Terminal, Zero Objects	21
1.3 Sets and Pointed Sets	23
1.4 Kernels and Cokernels	29
1.5 z-Exact Categories	34
1.6 Pullback and Pushout Recognition	39
1.7 Normal Subobjects	42
1.8 Normal Decompositions and Factorizations	44
1.9 Exact Sequences	54
1.10 The Category of Short Exact Sequences - I	58
1.11 The Normal Short 5-Lemma	63
2 Homology in Di-Exact Categories	67
2.1 Di-Extensions	71
2.2 Snake Sequences	83
2.3 Homology	92
2.4 The Long Exact Homology Sequence	100
2.5 Homological Self Duality	108
2.6 Preservation of Normal Maps by Diverion	121
2.7 Sub-Di-Exact Categories	124
2.8 Di-Exact Categories	127
2.9 Normal Pushouts and Normal Pullbacks	131
2.10 Higher Extensions	135

3	Normal Categories	139
3.1	Normal Categories	140
3.2	Image Factorization	143
3.3	The Snake Lemma	149
3.4	Alternate Characterizations of Normal Categories	151
4	Homological Categories	159
4.1	Homological Categories	161
4.2	Split Short Exact Sequences	164
4.3	Exact Sequences and Base Change	170
4.4	Normal Pushouts	178
4.5	The (Short) 5-Lemma	185
4.6	The (3×3) -Lemma	191
4.7	Commuting Morphisms	196
4.8	Commutative Objects in Homological Categories	204
4.9	Alternate Characterizations of Homological Categories	209
4.10	Protomodularity	212
4.11	The Mal'tsev Property	217
5	Semiabelian Categories	221
5.1	Axiomatic Foundations	223
5.2	Normal Pushouts	225
5.3	Normal Morphisms	227
5.4	The Category of Short Exact Sequences - II	230
5.5	The Lattice of Subobjects	231
5.6	Alternate Characterizations: Barr-exact Mal'tsev Categories	237
5.7	Alternate Characterizations: On the Existence of Colimits	240
6	Internal Structures	243
6.1	Internal Magmas, Monoids, Groups	244
6.2	Biproducts and Linear Categories	249
6.3	Internal Graphs and Internal Relations	258
7	Abelian Categories	267
7.1	Preadditive Categories	271
7.2	Additive Categories	273
7.3	Preabelian Categories	277
7.4	Abelian Categories	279
7.5	Related categorical structures	280
7.6	Categories of abelian objects	285

II Appendix	291
A Background from Category Theory	293
A.1 Limits and Colimits	293
A.2 Absolute Diagrams	300
A.3 Around Surjectivity	304
A.4 Factorization Systems	312
A.5 Reflective Subcategories	317
Index	331
Notation Index	340
Acronyms	343

Part I

Homology in Pointed Categories

Introduction to Part I

A peek at the history of homology

To provide context for what the reader will find here, let us review some highlights in the history of homology and homological methods².

The origins of homology are purely geometric. In *Analysis Situs* [74, §5], Poincaré used embedded cobordisms in a given manifold to define when a formal linear combination of compact boundaryless k -dimensional submanifolds was homologous to another such linear combination. The evolution of combinatorial analogues followed via the study of polyhedra: Around the 1920's a chain complex of finitely generated free abelian groups was associated to a polyhedron to extract Betti numbers and torsion coefficients of its underlying topological space. Combined, these numerical invariants characterize the homology groups of the chain complex up to isomorphism by providing the rank of its free summand plus the torsion summand.

Emmy Noether realized [47],[29, p. 174] that these groups themselves should be the objects of primary attention. In fact, according to P. Alexandrov, E. Noether responded with these ideas to lectures given by H. Hopf in 1926 and 1927; see [29, p. 174]. An element of such a homology group in dimension k could then be viewed as a combinatorial analogue of Poincaré's homology class of formal linear combinations of compact boundaryless k -dimensional submanifolds of a given manifold; see [74].

Increasingly, the use of homology of chain complexes broadened beyond its topological-geometric origins. Eilenberg and Mac Lane introduced the theory of categories to provide a formal foundation for 'natural transformations'. As part of the confluence of these developments, in 1956 H. Cartan and S. Eilenberg presented the first text on homological algebra ever [26].

Derived functors on categories of modules, algebras, groups, etc. were its dominant theme. Commonalities of homological constructions in those environments were soon abstracted

²For more information on the history of homology, see for instance [30] and [82].

into ‘abelian categories’ by A. Grothendieck [43]; see [61] and [22] for earlier steps in that direction.

Via (simplicial) model categories [75], Quillen created a foundational framework for *Homotopical Algebra*. Its vast scope encompasses the essentials of homological algebra, as well as homotopical invariants from algebraic topology and the homotopy theory of simplicial sets. Further examples include varieties of algebras/categories of models of Lawvere theories, next to what are today called *Mal’tsev categories* (with enough projectives and coequalizers of kernel pairs), as all of these are simplicial Quillen model categories [75, II.4].

Our objectives

While wanting to develop a direct and effective interface between modern categorical algebra and Quillen’s simplicial model category structure on Mal’tsev categories/varieties of algebras, we observed more and more advantages in building homology of chain complexes up systematically from categories which need only meet minimal structural prerequisites, namely the presence of a zero object along with the existence of kernels and cokernels. We call such a category *z-exact*. The environment of a *z-exact* category is sufficient for a discussion of universal factorizations of a given morphism and, consequently, of (short) exact sequences, of chain complexes, and homology as a measure for their failure to be exact. Remarkably, a version of the (Short) 5-Lemma for normal maps holds in this context.—The basic properties of *z-exact* categories are developed in Chapter 1.

To be able to compute effectively with homological invariants, one frequently relies on tools such as the Snake Lemma and the border cases of the (3×3) -Lemma. Perhaps surprisingly, only one additional structural hypothesis³ suffices to ensure that these tools are available: We assume that every composite

$$f = \square \xrightarrow{\mu} \square \xrightarrow{\varepsilon} \square$$

in which μ is a kernel and ε a cokernel admits a factorization as $f = \square \xrightarrow{e} \square \xrightarrow{m} \square$, where e is a cokernel and m is a kernel. Calling a composite of a normal epimorphism with a normal monomorphism such as $m \circ e$ a *normal map*, and a composite of a normal monomorphism with a normal epimorphism such as $\varepsilon \circ \mu$ an *antinormal map*, this amounts to asking that *every antinormal composite is a normal map*⁴. We refer to this as the (ANN)-property. A *z-exact* category which also satisfies the (ANN)-property is called *di-exact*.

³A form of this condition occurs in the definition of a *w-exact category* due to Burgin [23] and reappears as one of the ‘old axioms’ in [51].

⁴In comparison: an abelian category is a *z-exact* category with binary product and coproducts, in which *every map is normal*.

—The basic properties of di-exact categories are developed in Chapter 2. Moreover, we identify several structural axioms which are weaker than the (ANN)-condition, and which still support homologically meaningful results. We also explain connections with concepts such as p-exact categories.

Homological and semiabelian categories

To explain the relationship with existing literature, the authors of [10] presented *homological categories* as an environment in which the classical diagram lemmas of homological algebra hold: (Short) 5-Lemma, (3×3) -Lemma, Noether isomorphism theorems, Snake Lemma, which is the key to establishing the long exact homology sequence from a short exact sequence of normal chain complexes. We view a homological category as a category with zero object which is finitely bicomplete⁵ and satisfies two more structural axioms:

- ▶ pullbacks preserve normal epimorphisms, and
- ▶ for every morphism $f: X \rightarrow Y$ with section $s: Y \rightarrow X$, the maps s and $\ker(f)$ generate X ; see Definition 4.1.1.

Homological categories enjoy some features which are beyond the scope of di-exact categories. These are developed in Chapter 4.

On the other hand, di-exact categories have qualities, such as Theorem 2.4.4, which are beyond the scope homological categories. This is thanks to the surprising strength of the (ANN)-property. The synthesis of di-exact categories and homological categories is given by *semiabelian categories*^{6,7}: A category \mathcal{X} is semiabelian exactly when it is homological and satisfies the (ANN)-property.

With a view toward varieties of algebras, the semiabelian framework is particularly attractive for the following reason. In every homological category regular epimorphisms and normal epimorphisms coincide. In a variety of algebras an epimorphism is regular if and

⁵This means that our definition of ‘homological category’ differs slightly from earlier definitions such as the one in [10], where the only colimits required to exist are coequalizers of kernel pairs.

⁶The inventors of semiabelian categories chose this terminology because of the non-self-dual nature of this axiom system: It is half of abelian, in the sense that a category \mathcal{X} is abelian if and only if both \mathcal{X} and its opposite \mathcal{X}^{op} are semiabelian.

⁷The term ‘semiabelian category’ is also in use with two separate different meanings: (1) Palamodov calls a preabelian category *semiabelian* if for every morphism $f: X \rightarrow Y$, the natural comparison map $Q(K(f)) \rightarrow K(Q(f))$ is simultaneously a monomorphism and an epimorphism [71, 72, 44, 78]. These are closely related to, but different from [79], (2) *Raikov semiabelian* categories [76], which coincide with the *almost abelian* categories of Rump [78] and the *quasi-abelian categories* of [84, 78, 80]. As explained by G. Janelidze [77], the latter may be characterized as those categories which are at the same time homological and co-homological.

only if its underlying set theoretic function is surjective, which makes it ‘easy’ to recognize. —Remarkably, every homological variety of algebras is automatically semiabelian. —Foundational material of semiabelian categories is presented in Chapter 5.

Still, z -exact categories which are lower structured than ‘semiabelian’ have their place: Thanks to Lawvere’s semantic view of universal algebra, a Lawvere theory has models in many categories. For example, the category $\text{Grp}(\text{Top})$ of topological groups is homological but fails to be semiabelian.

In Part I of this monograph we work towards these convenient settings from the bottom up, starting with the context of pointed categories, in a way which is meant to keep the focus on the most basic homological-algebraic concepts—such as kernels and cokernels, (short) exact sequences, chain complexes and their homology, diagram lemmas—while assuming as little as possible in terms of conditions on the surrounding category. At the same time, this minimizes the amount of background knowledge we ask from the reader. The purpose of this methodology is to arrive at minimal requirements for our results to hold, requirements which moreover arise out of a clear homological-algebraic need. As a side-effect, the scope of the results in the first chapters encompasses part of the environment (which is not directly comparable to the semiabelian setting) considered by Grandis in [42] for slightly different purposes.

Self-duality

Along the way, we learned to pay attention to what we call the self-dual axis of a category. Let us sketch the underlying idea⁸: In the language of category theory, consider the collection of all self-dual statements about a category. Then the self-dual axis of a category \mathcal{X} is the collection of all those self-dual statements about \mathcal{X} which are true. Thus, we arrive at the tautological . . .

Metatheorem A category and its opposite always have the same self-dual axis.

This is so because a self-dual statement about \mathcal{X} is true if and only if it is true about \mathcal{X}^{op} .

For example, from the classical diagram lemmas we obtain self-dual statements about a z -exact category. So, a z -exact category \mathcal{X} contains those classical diagram statements in its self-dual axis if and only if they hold in \mathcal{X} .

Immediately, this leads us to an application of the Metatheorem: It is known that Set_*^{op} , the opposite of the category Set_* of pointed sets is a semiabelian category. So, the classical diagram lemmas belong to the self-dual axis of Set_*^{op} and, hence, to the self-dual axis of the category Set_* itself . . . even though Set_* is far from being semiabelian.

⁸This material is of independent interest. A more detailed treatment is in preparation.

We organized the material in this part of the work so that we can relate ongoing developments more explicitly to the self-dual axis of a z-exact category. This point of view naturally makes us arrive at the axioms of semiabelian categories from an unexpected new angle. Since the basic constructions of homological algebra are self-dual, we emphasize working with self-dual structural axioms—just as in the abelian framework.

Preliminaries

We assume that the reader is familiar with basic category theoretical notions. In order to fix terminology and notation, we collect selected materials in an [Appendix A](#). For further background on category theory, we recommend [\[63, 6, 1\]](#).

An overview of exactness conditions and categorical structures

We will be working with various sets of structural axioms, each with certain underlying exactness conditions; see Figure 1 for a diagrammatical presentation of the relationships between those structures. Then we show how certain well-studied categories of algebraic structures fit into this diagram; see Tables 1 and 2 below.

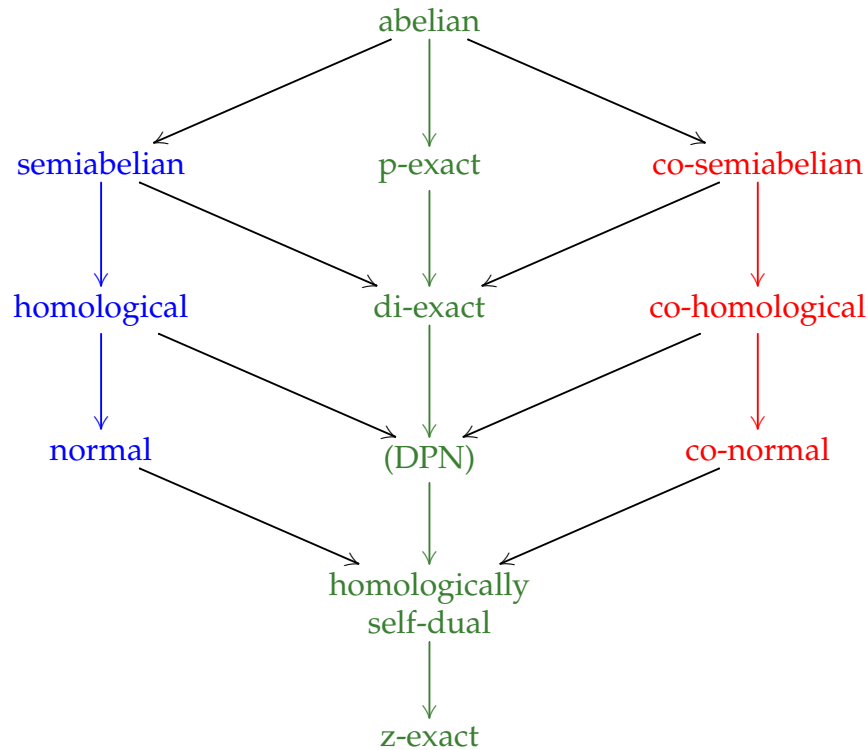

Figure 1: Relations between categorical structures and exactness conditions. Categories on the right satisfy the dual set of structural axioms of those on the left and vice versa. Self dual structures appear in the center.

The categorical structures in the left hand column are familiar from the literature, as are their duals on the right. Homologically relevant properties of so structured categories are systematically developed in Chapters 3, 4 and 5.

We use Table 1 to show how categories of familiar algebraic objects fit into the left hand column of Figure 1.

semiabelian	varieties of Ω -groups Orzech categories of interest	$\text{Alg}_{\mathbb{T}}(\text{Set}), \text{Alg}_{\mathbb{T}}(\text{HComp})$ $\text{Grp}, \text{Lie}_R, \text{CCHopf}_{\mathbb{K}}$	Loop $\text{Set}_*^{op}, \text{Cat}^n(\text{Grp})$
homological	$\text{Grp}(\text{Top})$ almost abelian categories	$\text{Alg}_{\mathbb{T}}(\text{Top})$	Ab_{ff}
normal			OrdGrp

Table 1: Rows separate algebraic structures: Referring to the left hand column of Figure 1, entries in higher rows are also entries in lower rows, while entries of lower rows are in general *not* entries of higher rows.

The middle column in Figure 1 is reserved for self dual categorical structures. Amongst them abelian categories and p-exact categories are classically known; we elaborate on those in Chapter 7. We systematically introduce the remaining structures in Chapter 2, and we explain their significance. Strongest among these conditions is di-exactness. It plays a special role for two reasons: (a) when satisfied, homology behaves really well; see e.g. Theorems 2.4.2 and 2.4.4; and (b) it separates homological categories from semiabelian ones. A category \mathcal{X} is di-exact if and only if the following axioms hold.

- ▶ \mathcal{X} has a zero object; see (1.2.1).
- ▶ Any morphism in \mathcal{X} has a (functorially chosen) kernel and a cokernel; see (1.4).
- ▶ (ANN) *antinormal composites are normal*: whenever a morphism f can be written as a composite $f = \epsilon\mu$, with a normal monomorphism μ followed by a normal epimorphism ϵ , then f may be factored as $f = me$, where m is a normal monomorphism and e is a normal epimorphism.

$$\begin{array}{ccc}
 \square & \xrightarrow{\mu} & \square \\
 \downarrow e & & \downarrow \epsilon \\
 \square & \xrightarrow{m} & \square
 \end{array}$$

The lowest structured categories we will be working with are the z-exact ones. We only assume the existence of a zero object and that every map has a kernel and a cokernel. Thus z-exact categories are self dual.

A *Puppe-exact* or *p-exact* category is a pointed category in which every morphism f is normal. Thus f admits an essentially unique decomposition $f = me$ with e a normal

epimorphism and m a normal monomorphism. This implies the existence of kernels and cokernels, so that a p-exact category is always z-exact. For information on p-exact categories see [41, 42, 12, 34], in particular the citations there to the foundational work of Puppe, Mitchell and others. A p-exact category which admits binary products or binary coproducts is abelian; see (7.5.8).

A di-exact additive category is abelian (7.5.9) because in an a pointed additive category, a morphism $f: X \rightarrow Y$ may be factored as the normal monomorphism $(1_X, 0): X \rightarrow X \oplus Y$ followed by the normal epimorphism $\langle f, 1_Y \rangle: X \oplus Y \rightarrow Y$. By the (ANN)-condition, every morphism is normal. Hence the given category is both p-exact and additive, which makes it abelian.

We use Table 2 to show how categories of familiar algebraic objects fit into the middle column of Figure 1.

abelian	$R\text{-Mod}, \text{Mod-}R$	sheaves in $R\text{-Mod}, \text{Mod-}R$	Ab_{fg}
p-exact		$\mathbb{K}\text{-Proj}, \text{Mlc}$	SetPBij
di-exact	semiabelian categories w-exact categories		$\text{Set}_*, \text{Set}_*^{op}$
homologically self-dual	normal categories	$\text{SES}(\mathcal{X})$ for \mathcal{X} di-exact, $\text{CHopf}_{\mathbb{K}}$	$\text{CMon}, \text{Top}_*$
z-exact	varieties of algebras whose theory admits a single constant		$\text{SES}(\text{CMon})$

Table 2: Referring to the middle column of Figure 1, entries in higher rows are also entries in lower rows, while entries of lower rows are in general *not* entries of higher rows.

Here is how some well known and some less familiar categories of algebraic structures relate to the tables:

1. Group objects $\text{Grp}(\text{Top})$ in the category Top of topological spaces form a homological category which is *not* semiabelian, as do models of a Lawvere theory \mathbb{T} in Top , provided its models in Set form a semiabelian category.
2. Group objects $\text{Grp}(\text{Set})$ in the category Set of sets and functions form a semiabelian category, as do varieties whose objects have an underlying group structure and a unique constant: so-called *varieties of Ω -groups*. Among the varieties of Ω -groups we find:
 - The category XMod of crossed modules.
 - The category Rng of (non-unital) rings and, more generally, associative and non-associative algebras over any given ring, such as the category Lie_R of Lie algebras over any ring R .

- Algebras (in $\text{Vect}_{\mathbb{K}}$) over any algebraic operad.
3. All Orzech categories of interest [70] are semiabelian.
 4. Cocommutative Hopf algebras over a field form a semiabelian category [40, 38], while commutative Hopf algebras are at least homologically self-dual (see Example 2.5.16; they are co-protomodular by [36], but regularity is currently not clear).
 5. Torsion-free groups and torsion-free abelian groups form homological categories, denoted Grp_{tf} and Ab_{tf} respectively. Neither category is semiabelian. The variety Loop of loops is semiabelian but not a variety of Ω -groups.
 6. A category is *almost abelian*, [78], exactly when it is at the same time homological and co-homological [77]. Among the almost abelian categories we find the categories of real or complex Banach spaces, and the category of locally compact abelian groups.
 7. The category Set_* of pointed sets is not homological because it fails to satisfy the (KSG)-condition. However, it is co-semiabelian, see Exercise 5.1.3. Consequently, Set_*^{op} is semiabelian, and both categories are di-exact. Neither category is p-exact because not every epimorphism is normal.
 8. For any $n \geq 1$, the category $\text{Cat}^n(\text{Grp})$ of n -fold iterated internal categories in the category of groups (equivalent to Loday's cat^n -groups [60]) is also semiabelian.
 9. The category Ab_{fg} of finitely generated *abelian* groups is abelian.
 10. The category OrdGrp of preordered groups is known to be normal but not homological [28]: a preordered group being a group equipped with a preorder (a reflexive and transitive relation) for which the group operation is monotone; arrows are monotone group homomorphisms.
 11. The category SetPBij of sets and partial bijections (bijections from a subset of the domain to a subset of the codomain) is known to be p-exact but not abelian [42].
 12. The category Mlc of modular lattices and modular connections is p-exact; see [12] and the references there.
 13. The category $\mathbb{K}\text{-Proj}$ of projective objects over a field \mathbb{K} , useful in K -theory, is one of the classical examples of a non-abelian p-exact category.
 14. *Weakly p-exact* or *w-exact* categories were introduced by Burgin in [23]. They form a context encompassing both p-exact and semiabelian categories. For a definition and quick introduction in English, see [12]; note that (ANN) is amongst the axioms defining w-exact categories.

15. The category \mathbf{CMon} of commutative monoids is homologically self-dual as shown in (2.5.14). In (2.6.4) it is shown that this category is not (DPN), so that it cannot be di-exact.
16. (2.5.22) explains that the category \mathbf{Top}_* of pointed topological spaces is (HSD). Of course, the same holds for the dual of these last two categories.
17. The category $\mathbf{SES}(\mathcal{X})$ of short exact sequences in any di-exact category \mathcal{X} is homologically self-dual (2.5.11). On the other hand 2.5.15, if we take short exact sequences in the category \mathbf{CMon} of commutative monoids, then we find a category which is z-exact but not (HSD).

Leitfaden for Part I

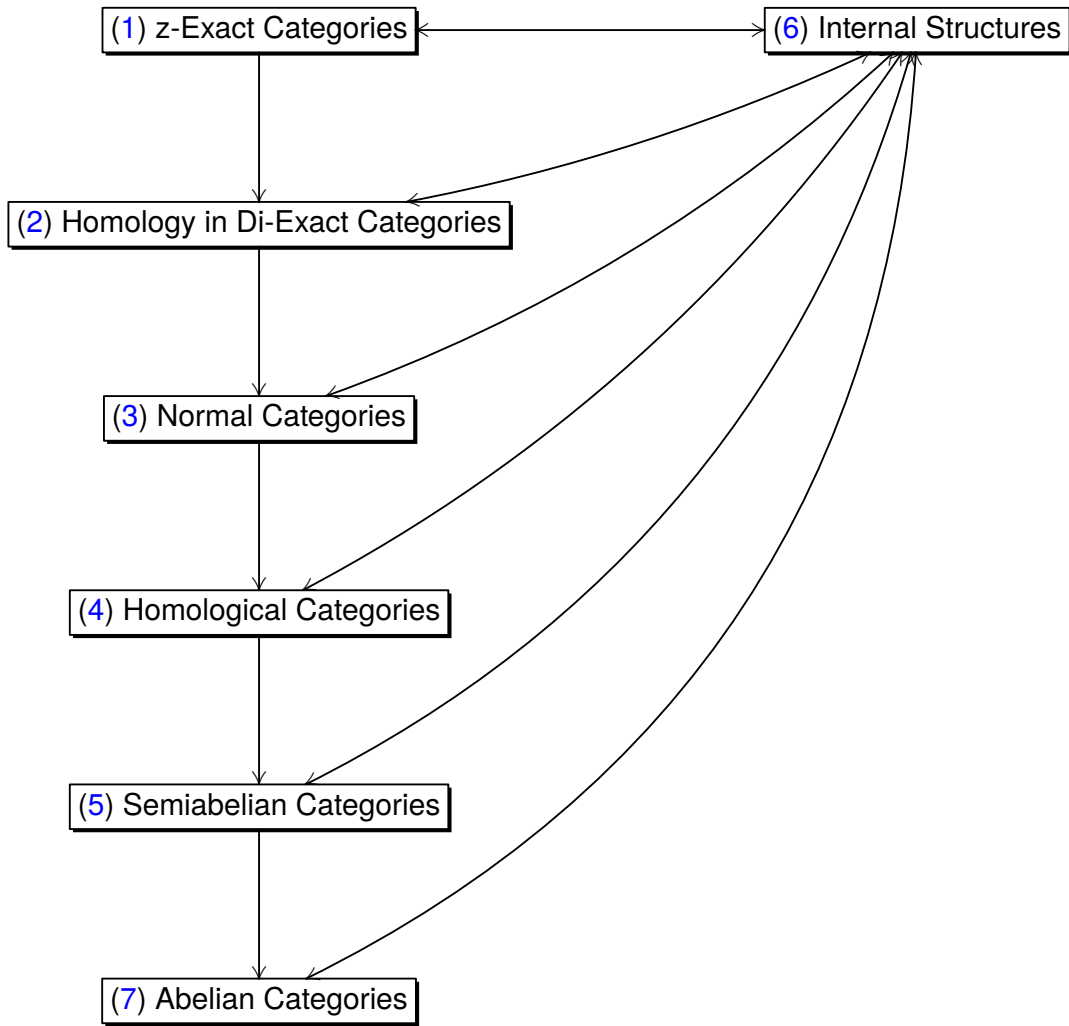

Chapter 1

z-Exact Categories

A category is z-exact¹ if it has a zero object, and if every morphism f has a kernel and a cokernel which depends functorially on f . If a morphism m represents the kernel of some map, then we call it a *normal monomorphism*. Dually, if a morphism e represents the cokernel of some map, then we call it a *normal epimorphism*.

In a z-exact category every morphism f has two universal factorizations:

- ▶ The class of all compositions $f = mu$, with m a normal monomorphism, is not empty and contains an initial element. We call it the *normal mono factorization* of f .
- ▶ The class of all compositions $f = ve$, with e a normal epimorphism, is not empty and contains a terminal element. We call the *normal epi factorization* of f .

The factorizations come from the following categories associated to a z-exact category \mathcal{X} :

1. The category $\text{Arr}(\mathcal{X})$ of morphisms (arrows) in \mathcal{X} .
2. The category $\text{NM}(\mathcal{X})$ of normal monomorphisms in \mathcal{X} , which is contained in $\text{Arr}(\mathcal{X})$ as a full reflective subcategory.
3. The category $\text{NE}(\mathcal{X})$ of normal epimorphisms in \mathcal{X} , which is contained in $\text{Arr}(\mathcal{X})$ as a full coreflective subcategory.

On this foundation, we introduce the concept of exact sequence, as well as its dual: a coexact sequence.

¹This terminology is specialized from Grandis in [42]. He works with maps which assume the role of kernels and cokernels in a relativized setting: A class \mathcal{Z} of objects which may contain non-zero objects is designated to act as zero-objects. Then ‘zero maps’ are defined relative to \mathcal{Z} .

We end this chapter by discussing internal magmas, monoids, and groups in a z-exact category; see Sections 1.10 and 6.2. We also explain how z-exact categories are related to normal categories; see Section 3.1.

Leitfaden for Chapter 1

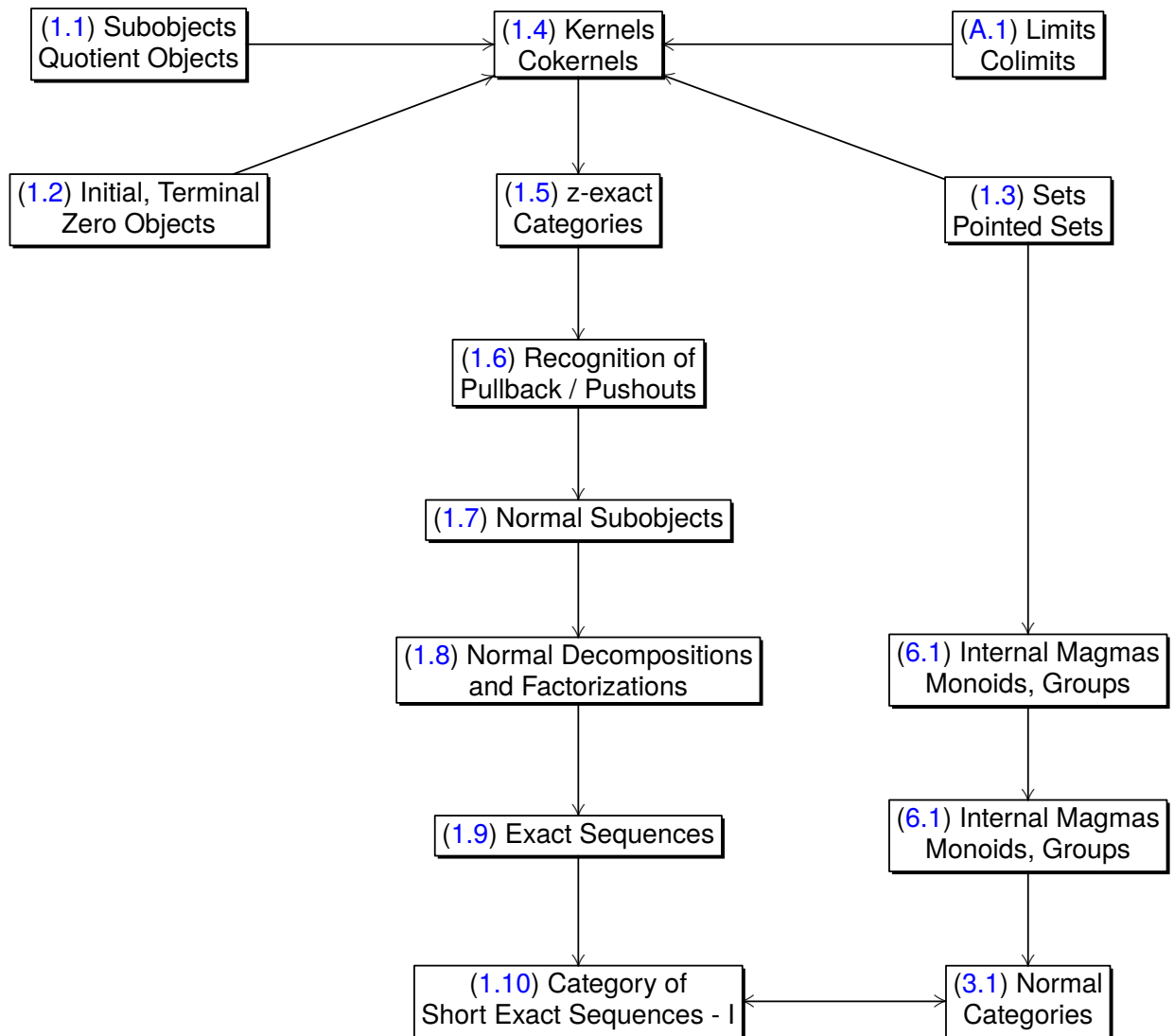

1.1 Subobjects and Quotient Objects

We introduce the concepts of monomorphism, epimorphism, as well as the associated concepts of subobject and quotient object. These notions are valid in any category.

Monomorphisms

1.1.1 Definition

Monomorphism

In any category \mathcal{X} , a morphism $m: M \rightarrow X$ is a *monomorphism*, a *mono* or *is monic* if, whenever $u, v: U \rightarrow M$ satisfy $mu = mv$, then $u = v$; notation: a tailed arrow $M \twoheadrightarrow X$.

1.1.2 Definition

Jointly monomorphic family

A family of morphisms $(f_i: M \rightarrow X_i)_{i \in I}$ in \mathcal{X} is *jointly monomorphic* if, whenever $u, v: U \rightarrow M$ satisfy $f_i u = f_i v$ for all $i \in I$, then $u = v$.

For example, if $\lambda: \lim(F) \Rightarrow F$ is a limit cone of a functor F from a small category into \mathcal{X} , then the family of morphisms λ_j of the cone λ is jointly monomorphic.

Subobjects

In a category \mathcal{X} the class of monomorphism with fixed codomain X carries a canonical partial ordering: We say that $m: M \twoheadrightarrow X$ is *less than or equal to* $n: N \twoheadrightarrow X$, in symbols $m \leq n$, if m factors through n ; i.e. there exists $p: M \rightarrow N$, with $m = n \circ p$. In this situation p is unique, and it is monic by (1.1.11.ii). We say that m is *equivalent to* n if $m \leq n$ and $n \leq m$. It follows that p with $m = n \circ p$ is an isomorphism. So, the class of monomorphisms with codomain X carries a canonical equivalence relation.

1.1.3 Definition

Subobject

A *subobject* of an object X in a category \mathcal{X} is an equivalence class of monomorphisms with codomain X .

It is common practice to refer to a morphism $m: M \rightarrow X$ as the subobject it represents. If m is determined by context, we may even refer to M itself as a subobject of X , and write $M \leq X$. We write $Sub(X)$ for the (possibly large) set of all subobjects of X . It is equipped with the partial ordering induced by the \leq -relation on monomorphisms with codomain X .

1.1.4 Example

Monomorphisms and subobjects of sets

A morphism in the category Set of sets is monic if and only if it is an injective function. Using the image of a function $f: A \rightarrow X$, we see that every subobject of X is uniquely

represented by a subset of X . Consequently, $Sub(X)$ is naturally equivalent to the power set $\mathcal{P}(X)$, equipped with the partial ordering by inclusion.

1.1.5 Example Monomorphisms and subobjects of topological spaces

In the category Top of topological spaces, a monomorphism $m: M \rightarrow X$ is given by a continuous function which is injective on underlying sets. Consequently, a subobject of X may be constructed in two steps. In step 1, select a subset S of the set underlying X , and equip S with the subspace topology. In step 2 choose any refinement of the topology of S . For example, refining the topology of X itself yields a space X' for which the identity function $X' \rightarrow X$ of underlying sets is a continuous bijection, not necessarily a homeomorphism. Thus, in Top , not all monomorphisms are subspace inclusions. For instance, the inclusion of the set of positive reals, equipped with the discrete topology, into \mathbb{R} is such a monomorphism.

1.1.6 Example Monomorphisms and subobjects of compact Hausdorff spaces

In the category $CHTop$ of compact Hausdorff spaces, a monomorphism $m: M \rightarrow X$ is given by an embedding of a compact Hausdorff space M as a closed subspace of X . Consequently, a subobject of X may be uniquely represented by the inclusion mapping of a closed subspace of X .

Indeed, any proper refinement of the topology of a compact Hausdorff space yields a Hausdorff space which is no longer compact. This is so because in a compact Hausdorff space, a subset is closed if and only if it is compact.

1.1.7 Example Monomorphisms and subobjects in a variety of algebras

In a variety of algebras, a monomorphism $m: M \rightarrow X$ is given by a morphism of algebras which is injective on underlying sets. Thus the subobjects of an algebra correspond to its subalgebras.

Intersection and union of subobjects

In a category \mathcal{X} , we introduce the notions of ‘meet’ and ‘join’ of subobjects. These are categorical versions of ‘intersection’ and ‘union’ of subsets.

1.1.8 Definition Meet and join of subobjects

Given an object X in a category \mathcal{X} , consider two subobjects, respectively represented by monomorphisms $m: M \rightarrow X$ and $n: N \rightarrow X$.

- (i) The *meet* or *intersection* of m and n is their greatest lower bound in the partial ordering of $Sub(X)$, provided it exists; notation: $M \wedge N$ or, more precisely, $m \wedge n$.

- (ii) The *join* or *union* of m and n of X is their least upper bound in $Sub(X)$, provided it exists; notation $M \vee N$.

The intersection of M and N always exists whenever \mathcal{X} admits pullbacks; see (A.1.17). The join $M \vee N$ does exist whenever \mathcal{X} admits binary coproducts and image factorizations; see (5.5.1). If \mathcal{X} admits arbitrary limits, we have:

1.1.9 Proposition

Arbitrary meets and joins in a complete category

For a family $\mathcal{S} = (S_\lambda | \lambda \in \Lambda)$ of subobjects of X in a complete category \mathcal{X} the following hold:

- (i) The meet of the objects in \mathcal{S} exists and may be constructed as

$$\bigwedge_{\lambda \in \Lambda} S_\lambda = \lim_{\Lambda} (S_\lambda \twoheadrightarrow X)$$

- (ii) If \mathcal{X} is well powered, then the join of \mathcal{S} exists and may be constructed as

$$\bigvee_{\lambda \in \Lambda} S_\lambda = \bigwedge_{i \in I} T_i$$

with $(T_i | i \in I)$ the family of all those subobjects of X which contain every S_λ . \diamond

Epimorphisms

Dual to the concepts of monomorphism and subobject are the concepts of epimorphism and quotient object:

1.1.10 Definition

Epimorphism

In any category, a morphism $e: Y \rightarrow Z$ is an *epimorphism*, an *epi* or *is epic* if, whenever $u, v: Z \rightarrow W$ satisfy $ue = ve$, then $u = v$; notation: a double-headed arrow $Y \twoheadrightarrow Z$.

We call a family $(g_i: A_i \rightarrow Y)_{i \in I}$ *jointly epimorphic* if, whenever $u, v: Y \rightarrow Z$ satisfy $ug_i = vg_i$ for all $i \in I$, then $u = v$. For example, if $\gamma: F \Rightarrow \text{colim}(F)$ is a colimit cocone of a functor F from a small category into \mathcal{X} , then the family of morphisms γ_j of the cocone γ is jointly epimorphic.

Quotient objects

In a category \mathcal{X} , an epimorphism $e: X \rightarrow Q$ is said to be *greater than or equal to* an epimorphism $\varepsilon: X \rightarrow R$ if there exists $q: Q \rightarrow R$ with $qe = \varepsilon$. Whenever such q exists, it

is unique and, by (1.1.13.ii) epic. If e is greater than or equal to ε and ε is greater than or equal to e , we say that e and ε are *equivalent*.

A quotient object of X is an equivalence class of epimorphisms with domain X . It is common practice to refer to the epimorphism $e: X \rightarrow Q$ or the object Q as the quotient object it represents.

Unexpected quotient objects can occur. For example, in the category of unital rings the field of rational numbers \mathbb{Q} appears as a quotient object of $\mathbb{Z} \rightarrow \mathbb{Q}$; see (A.3.10). We conclude that the concept of epimorphism does not characterize surjective algebra morphisms. For this reason, quotients determined by mere epimorphisms may exhibit pathological properties. Such pathologies do not occur in quotients determined by stronger types of epimorphisms, such as regular epimorphisms in the context of a variety of algebras, or normal epimorphisms as in Section 3.2.

Exercises

1.1.11 Exercise

Composite of monomorphisms

In an arbitrary category \mathcal{X} , consider composable morphisms $X \xrightarrow{f} Y \xrightarrow{g} Z$, and show the following:

- (i) If both f and g are monomorphisms, then gf is a monomorphism.
- (ii) If gf is a monomorphism, then f is a monomorphism.
- (iii) If gf is a monomorphism, then g need not be a monomorphism.

1.1.12 Exercise

Monomorphisms in CHTop

Show that in the category CHTop of compact Hausdorff spaces every monomorphism $m: M \rightarrow X$ is uniquely represented by the inclusion of a closed subspace S of X into X .

1.1.13 Exercise

Composite of epimorphisms

In a category \mathcal{X} , consider composable morphisms $X \xrightarrow{f} Y \xrightarrow{g} Z$, and show the following:

- (i) If both f and g are epimorphisms, then gf is an epimorphism.
- (ii) If gf is an epimorphism, then g is an epimorphism.
- (iii) If gf is an epimorphism, then f need not be an epimorphism.

1.1.14 Exercise

Epimorphisms in Grp

[63, p. 21] Show that in the category Grp of groups every epimorphism is surjective.

1.1.15 Exercise

Limit construction of join

Let \mathcal{C} be a complete category in which for each object X the collection of subobjects is a set; i.e. \mathcal{C} is *well*

powered. If M and N are subobjects of X , show that

$$M \vee N = \lim_J (\Phi)$$

where J is the category spanned by all those representatives of subobjects of X which contain both M and N . This makes J a subcategory of \mathcal{C} , and $\Phi: J \rightarrow \mathcal{C}$ is the inclusion functor.

1.2 Initial, Terminal, Zero Objects

We introduce the concepts of initial, terminal, and zero objects, and identify such objects in a sampling of categories.

1.2.1 Definition

Initial, terminal, zero object

An object i in a category \mathcal{X} is called *initial* if $\text{Hom}_{\mathcal{X}}(i, X)$ is a singleton set for all objects X in \mathcal{X} . Dually, an object t in \mathcal{X} is *terminal* if $\text{Hom}_{\mathcal{X}}(X, t)$ is a singleton set for all X . A *zero object* in \mathcal{X} is an object 0 which is both initial and terminal.

1.2.2 Definition

Pointed category

We say that a category \mathcal{X} is *pointed* if it has a zero object.

1.2.3 Example

Terminal / initial object in Set

The category Set of sets has a unique initial object, namely the empty set \emptyset . It also has terminal objects, namely any 1-element set. As 1-element sets are non-empty, Set does not have a zero object.

In a category \mathcal{X} with zero object every hom-set $\text{Hom}_{\mathcal{X}}(X, 0)$ contains a unique element, denoted 0_{0X} , and $\text{Hom}_{\mathcal{X}}(0, Y)$ contains a unique element, denoted 0_{Y0} . Consequently, $\text{Hom}_{\mathcal{X}}(X, Y)$ contains the composite $0_{YX} := 0_{Y0} \circ 0_{0X}$, called the *zero map* from X to Y . It is the unique map from X to Y which factors through 0 . We write 0 in place of 0_{YX} if there is no risk of confusion. An object in \mathcal{X} is a zero object if and only if $1_X = 0_{XX}$; see (1.2.11).

Composition of morphisms preserves the zero map in the following sense:

1.2.4 Proposition

Zero maps are absorbant under composition

In category with zero object the following hold for any morphisms $u: A \rightarrow X$ and $v: Y \rightarrow Z$:

$$0_{0X} \circ u = 0_{0A} \quad \text{and} \quad v \circ 0_{Y0} = 0_{Z0} \quad \diamond$$

Here are examples of categories with a zero object.

1.2.5 Example

The category of sets with base point is pointed

Associated to Set is the category Set_* of sets with a chosen base point, called ‘pointed sets’ for short: An object in Set_* is a pair (X, x) consisting of a set X and an element $x \in X$, called the base point of (X, x) . A morphism $f: (X, x) \rightarrow (Y, y)$ is a function $f: X \rightarrow Y$ such that $f(x) = y$. It follows that any pair $(\{x\}, x)$ is a zero object in Set_* . \diamond

1.2.6 Example

Grp has is pointed

The category Grp of groups has a zero object: any one-element group is one. The zero maps are those which send every element of the domain to the neutral element of the codomain. \diamond

1.2.7 Example

Rng is pointed

In the category Rng of rings with or without a unit we allow that the multiplicative unit 1 equals the additive 0. A morphism in Rng preserves the sum and the multiplication, but need not preserve the unit (if a unit exists). The zero ring is a zero object. \diamond

1.2.8 Example

URng has distinct initial and terminal objects

In contrast, let URng be the category whose objects are rings with a multiplicative 1, called the unit; again, we do *not exclude* the possibility that 1 equals the additive 0. Morphisms are set theoretic functions which preserve the unit and commute with addition and multiplication. Then URng has the integers \mathbb{Z} as an initial object, and it has the zero ring, consisting of a single element ‘0’, as a terminal object. As $\mathbb{Z} \neq 0$, URng does not have a zero object.

Notes Special role of the category Set_*

Whenever we work with pointed categories, the category Set_* of pointed sets is implicitly involved. This is so because every hom-set is canonically pointed by the zero map, and zero maps are absorbant under composition (1.2.4). So, pointed categories are enriched in Set_* .

We note that the concept of a pointed category is self-dual.

Exercises

1.2.9 Exercise

Initial object as a colimit

In any category \mathcal{X} , show that an object A is an initial object in \mathcal{X} if and only if it is a colimit of the empty functor from the empty category into \mathcal{X} .

1.2.10 Exercise

Terminal object as a limit

In any category \mathcal{X} , show that an object Z is a terminal object in \mathcal{X} if and only if it is a limit of the empty functor from the empty category into \mathcal{X} .

1.2.11 Exercise

Recognizing a zero object - z-Ex

In a category with a zero object 0 , show that the following conditions are equivalent:

- (I) X is a zero object;
- (II) there exists a monomorphism $X \rightarrow 0$;
- (III) there exists an epimorphism $0 \rightarrow X$;
- (IV) $1_X = 0_{XX}$.

1.2.12 Exercise

Sum projections yield pushout

In a pointed category with sums use arbitrary objects X and Y to form this commutative square.

$$\begin{array}{ccc}
 X + Y & \xrightarrow{\langle 0, 1_Y \rangle} & Y \\
 \langle 1_X, 0 \rangle \downarrow & & \downarrow \\
 X & \longrightarrow & 0
 \end{array}$$

Show that this square is a pushout.

1.2.13 Exercise

Product via pullback

In a pointed category with pullbacks show that the universal object in the pullback diagram below is a product of X and Y .

$$\begin{array}{ccc}
 P & \xrightarrow{x} & X \\
 y \downarrow & \circlearrowleft & \downarrow 0 \\
 Y & \xrightarrow{0} & 0
 \end{array}$$

1.2.14 Exercise

Alternative construction of the category of pointed sets

The category of pointed sets Set_* may be constructed as follows. If $*$ in Set is any terminal object, i.e. any 1-element set, then the category $*/\text{Set}$ of *object under $*$* —also called *slice category* or *comma category*, an object of $*/\text{Set}$ is a morphism $x: * \rightarrow X$, and a morphism from $x: * \rightarrow X$ to $y: * \rightarrow Y$ is a function $f: X \rightarrow Y$ such that $f \circ x = y$ —is isomorphic to Set_* .

1.3 Sets and Pointed Sets

Here we present some basic properties of the categories Set of sets and Set_* of pointed sets. We explain in detail how functorial limits and colimits can be constructed in Set . Then we use the forgetful functor $U: \text{Set}_* \rightarrow \text{Set}$ and its left adjoint, given by adding a disjoint point ‘+’ to a given set X , to obtain functorial limits and colimits in Set_* ; see (1.3.2), (1.3.3), and (1.3.5).

Any product over the empty category is the set $\{\emptyset\}$. If J is a discrete 1-element category,

then the limit of $F: J \rightarrow \text{Set}$ is $F(j)$. The product of two sets X and Y is the set of all ordered pairs $(x, y) := \{x, \{x, y\}\}$. With binary products, the concept of function $f: X \rightarrow Y$ is defined as a subset of $X \times Y$. If $F: J \rightarrow \text{Set}$ is a functor, where J is a discrete category with 3 or more objects, then

$$\lim(F) = \prod_{j \in J} F(j) := \{f: X \rightarrow Y \mid f \text{ is function}\}$$

For $n \geq 0$, we construct the n -th power $P_n: \text{Set} \rightarrow \text{Set}$ by letting $P_n(X)$ be the product determined by the constant functor $p: \{1, \dots, n\} \rightarrow \text{Set}$ with value X .

If J is an arbitrary small category, then the limit $F: J \rightarrow \text{Set}$ is obtained as

$$\lim(F) := \left\{ x \in \prod_{j \in J} F(j) \mid \forall u: i \rightarrow j \text{ in } J, F_u(x_i) = x_j \right\}$$

Given a pointed category \mathcal{X} , we observe that the Hom-functor on \mathcal{X} factors through the category Set_* :

$$\begin{array}{ccc} \mathcal{X}^{op} \times \mathcal{X} & \xrightarrow{\text{Hom}_{\mathcal{X}}(-,-)} & \text{Set} \\ & \searrow \text{Hom}_*(-,-) & \nearrow U \\ & \text{Set}_* & \end{array}$$

We take the existence of such a factorization as a light way of saying that \mathcal{X} is enriched in the category of pointed sets.

Turning to colimits, any coproduct over the empty category is the empty set. If J is a discrete 1-element category, then the colimit of $F: J \rightarrow \text{Set}$ is $F(j)$. If J is a discrete category with 2 or more elements, then

$$\coprod_{j \in J} F(j) := \left\{ (j, x) \in \text{Ob}(J) \times \left(\bigcup_{j \in J} F(j) \right) \mid x \in F(j) \right\}$$

If J is an arbitrary small category, then the colimit $F: J \rightarrow \text{Set}$ is defined as the quotient set

$$\text{colim}(F) := \coprod_{j \in J} F(j) \Big/ \sim$$

where ' \sim ' is the equivalence relation generated by $(i, x) \sim (j, F_u x)$, for all morphisms $u: i \rightarrow j$ in J .

1.3.1 Theorem

Set is closed symmetric monoidal

The category Set is symmetric monoidal via 'product'. The commutative diagram shows that $\prod_{a \in -} B \cong - \times B$ is left adjoint to $\text{Hom}(B, -)$.

$$\begin{array}{ccc} \text{Hom}(A \times B, C) & \longleftarrow \longrightarrow & \text{Hom}(A, \text{Hom}(B, C)) \\ \updownarrow & & \updownarrow \\ \text{Hom}(\prod_{a \in A} B, C) & \longleftarrow \longrightarrow & \prod_{a \in A} \text{Hom}(B, C) \end{array}$$

Let us now turn to the relationship between the categories of sets and pointed sets.

1.3.2 Proposition

Set_{*} \Leftarrow Set adjunction

The base point forget functor $U: \text{Set}_* \rightarrow \text{Set}$ has a left adjoint $X \mapsto X_+$ which sends a set X to the pointed set $X_+ := (X + \{X\}, X)$, which is the set X with the base-point X adjoined via coproduct (= disjoint union) in Set. \diamond

1.3.3 Theorem

Set_{*} is complete

The forgetful functor $U: \text{Set}_* \rightarrow \text{Set}$ preserves and reflects limits. — If $(X_i, x_i)_{i \in I}$ is a family of pointed sets, then

$$\prod_{i \in I} (X_i, x_i) = \left(\prod_{i \in I} X_i, (x_i)_{i \in I} \right)$$

Subsequently, the limit of a diagram of pointed sets is canonically a pointed subset of the product of pointed sets at the nodes of the diagram. In particular, Set_{*} is functorially complete. \diamond

1.3.4 Definition

Wedge operation in Set_{*}

In Set_{*} the *wedge* or *1-point union* of a family $(X_k, x_k)_{k \in K}$ of pointed sets is

$$\bigvee_{k \in K} (X_k, x_k) := \left(\prod_{k \in K} X_k \Big/ (x_{k_1} \sim x_{k_2}), * \right)$$

with $*$ the equivalence class of any x_k .

Let $q: \prod_{k \in K} X_k \rightarrow \bigvee_{k \in K} (X_k, x_k)$ be the quotient map. If $i_k: X_k \rightarrow \prod_{k \in K} X_k$ are the structure maps for the coproduct in Set, then $q i_k$ are structure maps for the coproduct in Set_{*}. As the coproduct in Set is associative and commutative, so is the wedge operation in Set_{*}.

1.3.5 Theorem

Set_{*} is cocomplete

The category Set_* is functorially cocomplete. The colimit of a diagram in Set_* is given by the appropriate quotient of the wedge formed from the pointed sets at the nodes of the diagram. \diamond

1.3.6 Definition

Smash product in Set_{*}

In Set_* , the *smash (product)* of (X, x_0) by (Y, y_0) is

$$(X, x_0) \wedge (Y, y_0) := ((X \times Y) / ((X \times \{y_0\}) \cup (\{x_0\} \times Y)), \{(X \times \{y_0\}) \cup (\{x_0\} \times Y)\})$$

We write $x \wedge y$ for the image of $(x, y) \in X \times Y$ in $(X, x_0) \wedge (Y, y_0)$.

Thus the smash of (X, x) by (Y, y) is constructed by collapsing the subset $(X \times \{y\}) \cup (\{x\} \times Y)$ of $X \times Y$ to a point, which becomes the base point of $(X, x) \wedge (Y, y)$.

1.3.7 Theorem

Set_{*} with $-\wedge-$ is closed symmetric monoidal

The category Set_* is closed symmetric monoidal via ‘smash product’. A natural bijection of based sets

$$\text{Hom}_*((X, x_0) \wedge (Y, y_0), (Z, z_0)) \longleftrightarrow \text{Hom}_*((X, x_0), \text{Hom}_*((Y, y_0), (Z, z_0)))$$

is given by

(i) $f: (X, x_0) \wedge (Y, y_0) \rightarrow (Z, z_0)$ gets sent to

$$\bar{f}: (X, x_0) \rightarrow \text{Hom}_*((Y, y_0), (Z, z_0)), \quad [\bar{f}(x)](y) := f(x \wedge y)$$

(ii) $g: (X, x_0) \rightarrow \text{Hom}_*((Y, y_0), (Z, z_0))$ gets sent to

$$\underline{g}: (X, x_0) \wedge (Y, y_0) \rightarrow (Z, z_0), \quad \underline{g}(x \wedge y) := [g(x)](y)$$

Now consider a pointed category \mathcal{X} . Every Hom-set $\text{Hom}_{\mathcal{X}}(X, Y)$ in \mathcal{X} is canonically equipped with a base point, namely the zero-map 0_{YX} . Let us write $\text{Hom}_*(X, Y)$ for this pointed Hom-set.

1.3.8 Theorem

Pointed Hom-sets of a pointed category

In a pointed category \mathcal{C} the following hold.

(i) $\text{Hom}_{\mathcal{X}}(X, Y) = U \circ \text{Hom}_*(X, Y)$, where $U: \text{Set}_* \rightarrow \text{Set}$ is the forgetful functor.

(ii) For $u: X \rightarrow Y$ and $v: Y \rightarrow Z$, $0_{ZY}u = 0_{ZX} = v0_{YX}$.

Thus, in particular Set_* is enriched in itself. In the following lemma we confirm that a pointed category can only be enriched in Set_* by taking the zero map $0_{XY}: X \rightarrow Y$ as the base point of $\text{Hom}(X, Y)$.

1.3.9 Lemma **In pointed category: base point in $\text{Hom}(X, Y)$ unique**
 If a category enriched over pointed sets has a zero-object, then in any hom-set $\text{Hom}(X, Y)$ the base point is the zero map.

Proof Let $*_{YX}: X \rightarrow Y$ denotes the base point of $\text{Hom}(X, Y)$. Then, for arbitrary $g: Y \rightarrow Z$ and $f: U \rightarrow X$, we must have $g \circ *_{YX} = *_{ZX}$ and $*_{YX} \circ f = *_{YU}$. Therefore,

$$*_{YX} = *_{Y0} \circ *_{0X} = 0_{Y0} \circ 0_{0X} = 0_{YX}$$

This is what we wanted to show. □

In a category with zero object, by (1.3.9), we use the notation 0_{XY} for both the map which factors through a zero object and the base-point in a pointed hom-set $\text{Hom}_*(X, Y)$.

Exercises

1.3.10 Exercise **Split monomorphisms in Set_***
 Show that in the category Set_* of pointed sets and base-point preserving functions, a morphism is a split monomorphism if and only if it is an injective base-point preserving function.

1.3.11 Exercise **One-point union versus cartesian product in Set_***
 In Set_* , the coproduct is called the *one-point union*: given two pointed sets (X, x) and (Y, y) , it is obtained as the disjoint union of X and Y , modulo identification of x and y . Check this. Then use (1.3.10) to prove that the canonical comparison map $(X, x) + (Y, y) \rightarrow (X, x) \times (Y, y)$ is a split monomorphism.

The following two exercises provide examples of non-pointed categories which are canonically enriched in Set_* .

1.3.12 Exercise **Non-zero rings are enriched in Set_***
 Show that the category of non-zero rings (Rng from which the zero object is removed) is non-pointed category which is enriched over pointed sets.

Formulate a generalization of the above which starts with an arbitrary pointed category.

1.3.13 Exercise **Epi / monomorphism in Set and in Set_***
 About a function $f: X \rightarrow Y$ in Set or in Set_* , show that the following hold:

- (i) f is a monomorphism if and only if it is injective.
- (ii) f is an epimorphism if and only if it is surjective.

1.3.14 Exercise**Surjective functions are pullback stable**

Show that the pullback of a surjective function $g: Z \rightarrow Y$ along any function $f: X \rightarrow Y$ is again surjective.

1.3.15 Exercise**Image factorization in Set and in Set_{*}**

About a function $f: X \rightarrow Y$ in Set or in Set_{*}, show that the following hold:

- (i) $E := KP(f)$ is an equivalence relation on X .
- (ii) $q: X \rightarrow X/E$ is a coequalizer for the projections $pr_1, pr_2: KP(f) \rightarrow X$.
- (iii) f factors through q as $f = i \circ q$, where i is injective.

Below, we collect a guided suite of properties of the category Top of topological spaces and the category Top_{*} of based topological spaces which are relevant to our purposes, in particular to working in topological varieties.

1.3.16 Exercise**Forget Top_{*} → Set_{*} preserves limits and colimits**

Show that the following:

- (i) The forget functors Top → Set and Top_{*} → Set_{*} preserve and reflect limits.
- (ii) The forget functors Top → Set and Top_{*} → Set_{*} preserve colimits.

Hint: Each of these forget functors has a left and a right adjoint.

1.3.17 Exercise**Subobjects in Top and Top_{*}**

Show that a subobject of a (based) topological space X is given by the inclusion of a subset of X equipped with the subspace topology or a refinement of the subspace topology.

1.3.18 Exercise**Compact Hausdorff spaces can not be refined**

In the category Top, if X is a compact Hausdorff space, and $f: A \rightarrow X$ is a continuous bijection, then exactly one of the following two applies:

- (i) f is a homeomorphism.
- (ii) A is not compact.

1.3.19 Exercise**Compact Hausdorff spaces**

In the category CHTop of compact Hausdorff spaces show the following:

- (i) A subobject of X is given by a closed subspace of X with the subspace topology.
- (ii) A proper refinement of the topology of X yields a space which is no longer compact.

1.4 Kernels and Cokernels

In this section we introduce the categorical concepts of kernel and cokernel, and we develop their basic properties from the ground up. For example, we show that every kernel has an equivalent characterization as a certain kind of pullback. Dually, every cokernel may equivalently be expressed as a certain kind of pushout; see (1.4.5). Further, by (1.5.6) the kernel of a monomorphism is 0, as is the cokernel of an epimorphism (1.5.5). Additional properties can be found in (1.5.8) and in (1.5.9). - Let us now turn to details.

1.4.1 Definition

Kernel

In category with a zero object a *kernel* of a morphism $f: X \rightarrow Y$ is given by a map $\kappa: K \rightarrow X$ such that these two conditions hold:

- (i) $f\kappa = 0$, and
- (ii) any map $\kappa': K' \rightarrow X$ with $f\kappa' = 0$ factors uniquely through κ .

In this situation we write $\ker(f)$ for κ and $K(f)$ for K .

Dualizing, we obtain:

1.4.2 Definition

Cokernel

A *cokernel* of a morphism $f: X \rightarrow Y$ is given by a map $\pi: Y \rightarrow Q$ such that:

- (i) $\pi f = 0$, and
- (ii) any map $\pi': Y \rightarrow Q'$ with $\pi' f = 0$ factors uniquely through π .

In this situation we write $\operatorname{coker}(f)$ for π and $Q(f)$ for Q .

In diagram language, a map $\kappa: K \rightarrow X$ represents the kernel of $f: X \rightarrow Y$ if and only if, on the left below, every diagram of solid arrows admits a unique filler λ as shown.

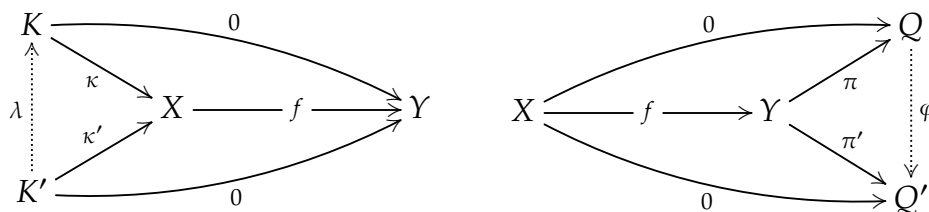

Dually, a map $\pi: Y \rightarrow Q$ represents the cokernel of $f: X \rightarrow Y$ if and only if, on the right above, every diagram of solid arrows admits a unique filler φ as shown. Consequently (1.4.11), if $\kappa: K \rightarrow X$ is a kernel of f , then κ is a monomorphism. Moreover, any two kernels of f are related by a unique isomorphism.

This means that, whenever a kernel of f exists, it represents a special and unique kind of subobject of X , which is what we call *the* kernel of f . It is common practice to accept the inaccuracy of writing $\kappa = \ker(f)$ or, even shorter, $K = K(f)$. We call a morphism k a *kernel* when it represents the kernel of some map.

1.4.3 Definition

Normal monomorphism

A morphism κ in a category with a zero object is called a *normal monomorphism* if it is the kernel of some arrow. We write $\kappa: K \rightarrow X$ to indicate that κ is a normal monomorphism, and say that K is a normal subobject of X , denoted $K \triangleleft X$.

Dually, in (1.4.2) it follows that the map π is an epimorphism and, further, that any two cokernel maps are related by a unique isomorphism. This means that, whenever a cokernel of f exists, it represents a special and unique kind of quotient object of Y , called *the* cokernel of f . We write $\pi = \operatorname{coker}(f)$ or $Q = Q(f)$ to say that π , respectively Q , is a cokernel of f . If $K \triangleleft X$ represented by a normal monomorphism $k: K \rightarrow X$, then we write X/K for the quotient of X by K , the cokernel Q of k .

1.4.4 Definition

Normal epimorphism

In a category with a zero object, a morphism $\pi: Y \rightarrow Q$ is called a *normal epimorphism* if it is the cokernel of some arrow. We write $\pi: Y \rightarrow Q$ to indicate that π is a normal epimorphism.

Let us now turn to the question of whether kernels, respectively cokernels, exist:

1.4.5 Proposition

(Co)Kernels and pushout/pullback diagrams

For a morphism $f: X \rightarrow Y$ in a category with a zero object the following hold.

- (i) f has a kernel if and only if the diagram $X \xrightarrow{f} Y \leftarrow 0$ admits a pullback.
- (ii) f has a cokernel if and only if the diagram $0 \leftarrow X \xrightarrow{f} Y$ admits a pushout.

Proof The commutative square on the left below has the pullback property exactly when κ has the universal property of the kernel of f .

$$\begin{array}{ccc}
 K & \longrightarrow & 0 \\
 \kappa \downarrow & \lrcorner & \downarrow \\
 X & \xrightarrow{f} & Y
 \end{array}
 \qquad
 \begin{array}{ccc}
 X & \xrightarrow{f} & Y \\
 \downarrow & \lrcorner & \downarrow \pi \\
 0 & \longrightarrow & C
 \end{array}$$

Similarly, the commutative square on the right above has the pushout property exactly when π has the universal property of the cokernel of f . □

1.4.6 Example

Various kernels and cokernels

Familiar kernels and cokernels include:

- (i) In Grp , kernels correspond to inclusions of normal subgroups; in Rng , as in Lie_R , a kernel is the inclusion of an ideal.
- (ii) In Set_* the kernel of $f: (X, x) \rightarrow (Y, y)$ is the pointed set $(\{z \in X \mid f(z) = y\}, x)$. The cokernel of f is the pointed set $(Y/f(X), \{f(X)\})$ where $Y/f(X)$ is the set Y modulo the equivalence relation R defined by aRb iff $a = b$ or $a, b \in f(X)$.
- (iii) In Mnd , the addition morphism $+: \mathbb{N} \times \mathbb{N} \rightarrow \mathbb{N}$ has kernel $\{(0, 0)\}$.
- (iv) Any pointed category admits a kernel and a cokernel for any isomorphism, namely 0 . Conversely, 1_A is a kernel of $A \rightarrow 0$ and a cokernel of $0 \rightarrow A$.

Kernels and cokernels determine each other in the following sense.

1.4.7 Proposition

Kernel of cokernel of kernel

In a category with a zero object, the following hold:

- (i) if k is a normal monomorphism which admits a cokernel, then $k = \ker(\text{coker}(k))$;
- (ii) if f is a normal epimorphism which admits a kernel, then $f = \text{coker}(\ker(f))$.

Hence, in a pointed category, any normal monomorphism is a kernel of its cokernel, while any normal epimorphism is a cokernel of its kernel.

Proof We prove (i), as (ii) is its dual. Suppose $k: K \rightarrow X$ is a kernel of $f: X \rightarrow Y$ and consider a cokernel $\varepsilon: X \rightarrow Q$ of k . Then there is a unique $g: Q \rightarrow Y$ such that $g \circ \varepsilon = f$. We prove that k is a kernel of ε by verifying the universal property. We let $h: Z \rightarrow X$ satisfy $\varepsilon \circ h = 0$. Then also $f \circ h = g \circ \varepsilon \circ h$ is trivial, so that a unique $l: Z \rightarrow K$ exists for which $k \circ l = h$. This proves the claim. \square

It can be helpful to interpret (1.4.7) via commutative diagrams:



If the square (L) is a pushout with u a normal monomorphism, then $v = Q(u)$ and (L) is also a pullback. If the square (R) is a pullback with b a normal epimorphism, then $a = K(b)$ and (R) is also a pushout.

Notes

On the concept of normal monomorphism Some authors define the term normal monomorphism differently; see e.g. [16], [20, Lemma 5.9], [10]. These works conceptualize a different aspect of ‘being normal’—namely, *being a class of an internal equivalence relation*. In a category which is not Barr exact, this latter notion does not agree with the concept of a kernel.

One example where this happens is the category of finitely generated free abelian groups. This category is additive and admits kernels. However, there are monomorphisms which are not kernels. Yet all monomorphisms are normal in the sense of Bourn, see [20, Lemma 5.9]. One can show that in a semiabelian category a monomorphism is a kernel, if and only if it normal in the sense of [16], [20, Lemma 5.9], [10]. Also, a morphism is monic if and only if its kernel vanishes; see (3.1.6).

Exercises

1.4.8 Exercise

Isomorphism and normal epi / mono

In any pointed category, show that an isomorphism is both, a normal epimorphism and a normal monomorphism.

1.4.9 Exercise

Equivalent condition for kernel - z-Ex

Given a map $f: X \rightarrow Y$, show that the following are equivalent for a map $m: M \rightarrow X$:

- (I) m represents $K(f)$.
- (II) m represents the greatest subobject of X for which $f \circ m = 0$.

1.4.10 Exercise

Equivalent condition for cokernel - z-Ex

Given a map $f: X \rightarrow Y$, show that the following are equivalent for a map $q: Y \rightarrow Q$:

- (I) q represents $Q(f)$.
- (II) q represents the greatest subobject of y for which $q \circ f = 0$.

1.4.11 Exercise

Normal monomorphism is monic - z-Ex

Show that a kernel of $f: X \rightarrow Y$ is a monomorphism.

1.4.12 Exercise

$$K(K(f)) = 0$$

Given $f: X \rightarrow Y$ with its kernel $\mu: K(f) \rightarrow X$. Show that $K(\mu) = 0$.

1.4.13 Exercise

Composition of normal monomorphisms - z-Ex

About composable maps $K \xrightarrow{\mu} L \xrightarrow{\nu} M$ prove the following:

- (i) If μ and ν are normal monomorphisms, show that $\nu\mu$ need not be a normal monomorphism.
- (ii) If $\nu\mu$ is a normal monomorphism and ν is monic, show that μ is a normal monomorphism.
- (iii) Show that (ii) is false when ν is not monic.

1.4.14 Exercise**Some special cokernels**

In a category with a zero object \mathcal{X} prove the following:

- (i) For X in \mathcal{X} arbitrary, $1_X: X \rightarrow X$ is a cokernel of $z: 0 \rightarrow X$.
- (ii) If $f: X \rightarrow Y$ is an isomorphism in \mathcal{X} , then f is a cokernel of $z: 0 \rightarrow X$.
- (iii) If $f: X \rightarrow Y$ is an epimorphism, then $\zeta: Y \rightarrow 0$ is a cokernel of f .

1.4.15 Exercise

In a category with a zero object show that, for arbitrary X , the identity $1_X: X \rightarrow X$ is a kernel of $q: X \rightarrow 0$ and the cokernel of $m: 0 \rightarrow X$.

1.4.16 Exercise

$$Q(Q(f)) = 0$$

Given $f: X \rightarrow Y$, let $\varepsilon: Y \rightarrow Q(f)$ be its cokernel. Show that $Q(\varepsilon) = 0$.

1.4.17 Exercise**Subobject / quotient object of 0 - z-Ex**

About the zero object in a category which has a zero object, show the following:

- (i) 0 is the one and only subobject of 0 , and it is normal.
- (ii) 0 is the one and only quotient object of 0 , and it is normal.

1.4.18 Exercise **$K(f) = 0$ does not imply f is monomorphism**

Give an example of a pointed category containing a morphism f such that $K(f) = 0$, yet f is not a monomorphism.

1.4.19 Exercise**Cokernel vanishes yet not epimorphic**

In the category Grp find a non-epimorphic morphism whose cokernel vanishes.

1.4.20 Exercise**Normal epimorphism is epic**

In any pointed category, a normal epimorphism $f: Y \rightarrow Q$ is epic.

1.4.21 Exercise**Normal epi cancellation**

In any pointed category, if gf is a normal epimorphism and f is epic, then g is a normal epimorphism.

1.4.22 Exercise**Composition of normal epimorphisms**

Find an example of a pointed category with normal epimorphisms f and g such that the composite gf is *not* normal epic.

1.4.23 Exercise**Non-cancellation for normal monomorphisms**

Find a pointed category and a normal monomorphism composite of $X \xrightarrow{f} Y \xrightarrow{g} Z$ in which f is not normal; compare (iv) in Proposition 1.5.8.

1.4.24 Exercise

Normal epimorphisms / monomorphisms in Set_*

In the category Set_* of pointed sets, show a function $f: (X, x) \rightarrow (Y, y)$ has the following properties:

- (i) f is a normal epimorphism if and only if, for every $y \neq t \in Y$, its fiber $f^{-1}(t)$ under f is a singleton.
- (ii) f is a normal monomorphism if and only if it is an injective function.

1.5 z-Exact Categories

To unburden the subsequent exposition from existence considerations, we then specialize to categories with a zero object in which every map has a kernel and a cokernel. We say that such a category is z-exact. Perhaps surprising is that, in z-exact categories a primordial version of, what is commonly known as, the Third Isomorphism Theorem holds; see (1.5.11).

1.5.1 Definition

z-exact category

A category with a zero object in which every morphism has a (functorially chosen) kernel and cokernel is called an z-exact category.

The label **z-Ex** in the caption of a definition or of a result indicates that, what is captioned, applies to z-exact categories. For example:

1.5.2 Corollary

Normal subobject / quotient object inversion - z-Ex

For every object X in a z-exact category, the class $NSub(X)$ of normal subobjects of X is in bijective correspondence with the class $NQuo(X)$ via the operations

$$NSub(X) \begin{array}{c} \xrightarrow{\text{coker}} \\ \xleftarrow{\text{ker}} \end{array} NQuo(X)$$

Motivated by the effect of the correspondence in (1.5.2) on the orders of normal subgroups / quotient groups of a finite group, we introduce the following terminology.

1.5.3 Terminology

Normal subobject / quotient object inversion

We refer to the bijection in (1.5.2) as the *normal subobject / quotient object inversion over X* .

Existence of kernels and cokernels suffices for the availability of certain pullbacks and pushouts.

1.5.4 Proposition

Existence of special pullbacks / pushouts - z-Ex

Let \mathcal{X} be a category with zero object in which every map has a kernel and a cokernel. Then the following hold:

- (i) The pullback of a normal monomorphism along an arbitrary morphism exists; such pullbacks preserve normal monomorphisms.
- (ii) The pushout of a normal epimorphism along an arbitrary morphism exists; such pushouts preserve normal epimorphisms.

Proof In the diagram below, we start from a normal monomorphism μ and an arbitrary morphism f .

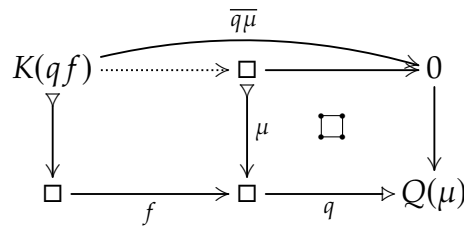

Then μ , together with its cokernel yields the bicartesian square on the right. The left hand square is constructed by first taking the kernel of the composite qf , then adding the uniquely induced dotted arrow. Then, pullback cancellation (A.1.6) shows that the square on the left is a pullback. Thus the pullback of the normal monomorphism μ along the arbitrary map f exists and is again a normal monomorphism.

The proof of (ii) is dual. □

In (1.5.5) and its dual (1.5.6), we present necessary conditions for being a (normal) epimorphism, respectively a (normal) monomorphism.

1.5.5 Proposition

$Q(epi) = 0$

In a pointed category, an epimorphism $q: X \rightarrow Y$ has $coker(q) = (Y \rightarrow 0)$.

◇

1.5.6 Proposition

$K(mono) = 0$

In a pointed category, a monomorphism $f: X \rightarrow Y$ has $ker(f) = (0 \rightarrow X)$.

◇

The converse of (1.5.6) or (1.5.5) does not always hold, unless the category satisfies additional conditions; see (3.1.6). For example, in the category Set_* of pointed sets a function whose kernel is 0 need not be a monomorphism; see exercise (1.4.18). Similarly, in Grp there are non-epimorphic maps whose cokernel vanishes; see Exercise 1.4.19.

Very useful is the following recognition criterion for isomorphisms.

1.5.7 Proposition

Isomorphism recognition

In a category with a zero object, the following are equivalent for a morphism $f: X \rightarrow Y$:

- (I) f is an isomorphism;
- (II) f is a normal epimorphism and a monomorphism;
- (III) f is an epimorphism and a normal monomorphism.

Proof The implication (i) implies (ii) is clear. To see that (ii) implies (i) suppose f is a normal epimorphism and a monomorphism. Then the kernel of f is 0 by (1.5.6). By (1.4.7), the normal epimorphism f is the cokernel of $0 \rightarrow X$, so that it is an isomorphism by item (iv) in Example 1.4.6.

Now (iii) implies (i) by duality. To see that (ii) implies (iii) we see with (1.5.5) that $\text{coker}(f) = Y \rightarrow 0$. With (1.4.7) we have that $f = \text{ker}(Y \rightarrow 0)$, and so f is an isomorphism. \square

Computations Involving (Co-)Kernels

1.5.8 Proposition

Properties of normal monomorphisms - z-Ex

The following hold:

- (i) Given two composable maps $X \xrightarrow{f} Y \xrightarrow{g} Z$ in \mathcal{X} , the kernel of gf is the pullback along f of the kernel of g .
- (ii) If g is a monomorphism, then $\text{ker}(gf) = \text{ker}(f)$.
- (iii) In a composite $K \xrightarrow{\varphi} U \xrightarrow{m} X \xrightarrow{f} Y$, if $\text{ker}(f: X \rightarrow Y) = m\varphi$ and m is monic, then $\varphi = \text{ker}(fm)$.
- (iv) If a composite vu is a normal monomorphism and v is a monomorphism, then u is a normal monomorphism.

Proof (i) See the proof of (1.5.4).

(ii) We know from (1.5.6) that $\text{ker}(g) = 0$. By (1.5.8), $\text{ker}(gf)$ is the pullback of $\text{ker}(g) = 0$ along f . But that is exactly $\text{ker}(f)$.

(iii) We verify the kernel property of φ directly. Consider the situation depicted in the diagram below.

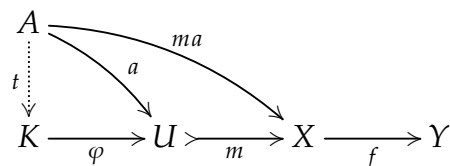

If $(fm)a = 0$, then $f(ma) = 0$, and so there exists $t: A \rightarrow K$, unique with the property $m\varphi t = ma$. As m is monic, $\varphi t = a$. If $t': A \rightarrow K$ is another map with $\varphi t' = a$, then

$m\varphi t' = ma$, and the universal property of the kernel $m\varphi$ yields $t = t'$. This proves the claim.

(iv) This follows from (iii) by setting f the cokernel of vu . □

In (1.5.8.iv) the assumption that m is monic is essential; see exercise (1.4.23). Dualizing Proposition 1.5.8.iii results in a valid statement about cokernels.

1.5.9 Proposition Properties of normal epimorphisms - z-Ex

The following hold:

- (i) Given two composable maps $X \xrightarrow{f} Y \xrightarrow{g} Z$, the cokernel of gf is the pushout along g of the cokernel of f .
- (ii) If f is an epimorphism, then $\text{coker}(gf) = \text{coker}(g)$.
- (iii) If a composite vu is a normal epimorphism, and u is epic then v is a normal epimorphism. ◇

1.5.10 Corollary Factoring the cokernel of a map - z-Ex

Given composable maps $X \xrightarrow{f} Y \xrightarrow{g} Z$, let $\gamma: \text{coker}(f) \rightarrow \text{coker}(gf)$ be the induced map. Then

$$\text{coker}(g) = \text{coker}(\gamma) \circ \text{coker}(g \circ f)$$

Proof We consider the following diagram (cf. (1.5.9.i)).

$$\begin{array}{ccccc}
 X & \xrightarrow{f} & Y & \xrightarrow{g} & Z \\
 \downarrow & & \downarrow & & \downarrow \\
 0 & \longrightarrow & Q(f) & \xrightarrow{\gamma} & Q(gf) \\
 & & \downarrow & & \downarrow \\
 & & 0 & \longrightarrow & Q(\gamma)
 \end{array}$$

The concatenation of the two pushout squares on the right is again a pushout by (A.1.10). So, the composite of the vertical maps on the right represents the cokernel of g . □

If X is a subobject of Y , write Y/X for $Q(X \hookrightarrow Y)$. With this notation, a very special case of (1.5.10) is:

1.5.11 Corollary

Primordial Third Isomorphism Theorem - z-Ex

Given subobjects $X < Y < Z$, then

$$Z/Y \cong Q((Y/X) \rightarrow (Z/X))$$

We will frequently encounter situations in which we commute one limit with another, or one colimit with another. Such reasoning is supported by ‘Fubini’s Theorem’, [63, Section IX.2]. Here is a particularly useful sampling of such results. As limits commute, kernels commute with products:

1.5.12 Proposition

Kernels commute with products - z-Ex

If in a z-exact category the product of morphisms $f: A \rightarrow B$ and $g: X \rightarrow Y$ exists, then the identity $K(f \times g) = K(f) \times K(g)$ holds. \diamond

Dualizing, we obtain:

1.5.13 Proposition

Cokernels commute with sums - z-Ex

If in a z-exact category the sum of morphisms $f: A \rightarrow B$ and $g: X \rightarrow Y$ exists, then the identity $Q(f + g) = Q(f) + Q(g)$ holds. \diamond

1.5.14 Proposition

Cokernel of the inclusion into a sum - z-Ex

For any two objects X and Y which admit a coproduct, the cokernel of the structure map $i_X: X \rightarrow X + Y$ is the universal map $\langle 0, 1_Y \rangle: X + Y \rightarrow Y$.

Proof The concatenation of pushouts below is again a pushout:

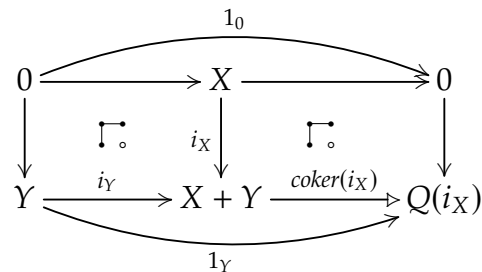

As the composite along the top is the identity, so is the composite along the bottom. The diagram then explains why $coker(i_X) = \langle 0, 1_Y \rangle$. \square

Dually:

1.5.15 Proposition

Kernel of the projection from a product - z-Ex

For any two objects X and Y which admit a product, the kernel of the projection map $pr_X: X \times Y \rightarrow X$ is the universal map $(0, 1_Y): Y \rightarrow X \times Y$. \diamond

Notes

The Primordial Third Isomorphism Theorem (1.5.11) is valid in all z -exact categories. In the literature the Third Isomorphism Theorem involves normal subobjects $X \triangleleft Y \triangleleft Z$, with $X \triangleleft Z$, and concludes with a short exact sequence

$$(Y/X) \twoheadrightarrow (Z/X) \longrightarrow (Z/Y)$$

Such a conclusion may not be available in an arbitrary z -exact category. In Section 2.5 we identify a necessary and sufficient condition under which this conclusion holds.

On the concept of z -exact categories In (1.5.1) we defined a z -exact category as a category with a zero-object, and where every morphism has a kernel and a cokernel. As such it is a special and motivating special case of the concept of Z -exact category in the sense of Grandis [42], where Z is a chosen class of objects which serve as zeroes. Ours is the special case where Z consists of the object 0 .

Exercises

1.5.16 Exercise **Cokernels commute with sums / kernels commute with products**
 Prove propositions (1.5.12) and (1.5.13).

1.5.17 Exercise **Kernel from kernel pair**
 Let $f: X \rightarrow Y$ be a morphism and $(KP(q), pr_1, pr_2)$ a kernel pair, a pullback of f along itself. Then a kernel of f is represented by the composite

$$pr_1 \circ ker(pr_2): K(pr_2) \longrightarrow X.$$

1.6 Recognizing Pullback Squares and Pushout Squares

We develop frequently used facts about pullbacks and pushouts in their relation to kernels and cokernels.

1.6.1 Proposition **Pullback yields isomorphic kernels - z -Ex**

In the commutative diagram

$$\begin{array}{ccccc} K(\bar{f}) & \twoheadrightarrow & P & \xrightarrow{\bar{f}} & U \\ \bar{g} \downarrow & & \downarrow \bar{g} & \text{(R)} & \downarrow g \\ K(f) & \twoheadrightarrow & V & \xrightarrow{f} & W, \end{array}$$

if the square (R) is a pullback, then \bar{g} is an isomorphism.

Proof Consider the commutative diagram below.

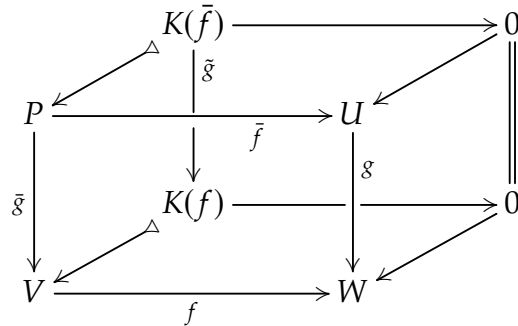

The front, top, and bottom faces of this cube are pullbacks by design. Therefore by (A.1.6.i), the rectangle from the top back edge to the front bottom edge is a pullback as well. But then pullback cancellation (A.1.6.ii) says that also the back face is a pullback. The identity map $0 \rightarrow 0$ pulls back to an isomorphism, namely \tilde{g} . — This was to be shown. \square

1.6.2 Proposition

Pullback recognition: kernel side I - z-Ex

In the commutative diagram below, let $\alpha = K(q)$, and α' a monomorphism such that $q'\alpha' = 0$.

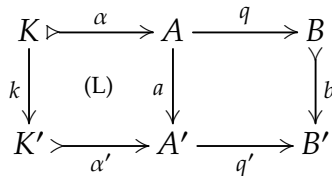

If b is a monomorphism then the square (L) is a pullback.

Proof Given arrows u and v as shown, we prove that the square on the left has the required universal property.

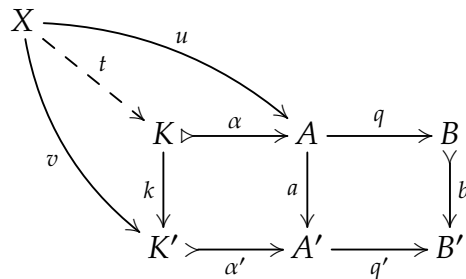

We find that $bqu = q'au = q'\alpha'v = 0$. As b is a monomorphism, $qu = 0$. Via the universal property of the kernel α , there is a map $t: X \rightarrow K$, unique with the property

$\alpha t = u$. It remains to show that $kt = v$. This follows from the defining property of the monomorphism α' , upon observing that

$$\alpha' kt = a\alpha t = au = \alpha' v.$$

So $kt = v$, as required. □

We can say more in the context of a homological category: see (4.3.6).

The following propositions on pushouts and epimorphisms are dual to their respective counterparts on pullbacks and monomorphisms.

1.6.3 Proposition

Pushout yields isomorphism of cokernels - z-Ex

In the commutative diagram below, suppose $q = \text{coker}(\alpha)$ and $q' = \text{coker}(\alpha')$.

$$\begin{array}{ccccc} R & \xrightarrow{\alpha} & X & \xrightarrow{q} & Y \\ r \downarrow & & x \downarrow & & y \downarrow \\ R' & \xrightarrow{\alpha'} & X' & \xrightarrow{q'} & Y' \end{array}$$

If the left hand square is a pushout then y is an isomorphism. ◇

1.6.4 Proposition

Pushout recognition - z-Ex

In the commutative diagram below, suppose $q' = \text{coker}(\alpha')$, and q is an epimorphism such that $q\alpha = 0$.

$$\begin{array}{ccccc} R & \xrightarrow{\alpha} & X & \xrightarrow{q} & Y \\ r \downarrow & & x \downarrow & & y \downarrow \\ R' & \xrightarrow{\alpha'} & X' & \xrightarrow{q'} & Y' \end{array}$$

If r is an epimorphism then the right hand square is a pushout. ◇

1.7 Normal Subobjects and Normal Closure

By Definition 1.4.3, a subobject of an object X is normal if it is the kernel of some map with domain X . In a z -exact category we know that the intersection of two normal subobjects always exists by (1.5.4); here we prove that it is again normal, see (1.7.1). Then we show that every every subobject of X has a unique normal closure.

1.7.1 Proposition

Intersection of normal subobjects - z -Ex

The intersection of two normal subobjects is again a normal subobject.

Proof Let $m: M \rightarrow X$ be the kernel of f , and $n: N \rightarrow X$ the kernel of g . From (1.1), we know that the pullback of m and n constructs their intersection $M \wedge N$:

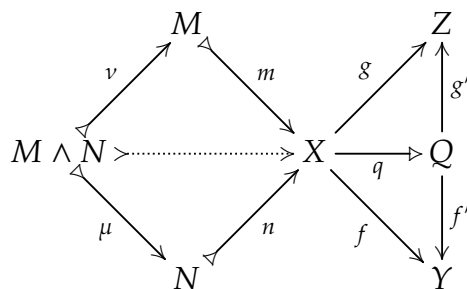

We take the cokernel q of $mv = n\mu$ and notice that g factors through q as a morphism g' , while f factors through q as a morphism f' .

Consider a morphism $u: U \rightarrow X$ such that $q \circ u = 0$. This implies that $f \circ u = 0$ and $g \circ u = 0$. So, there exist morphisms $x: U \rightarrow M$ and $y: U \rightarrow N$ for which $m \circ x = u = n \circ y$. Hence there exists a unique morphism $(x, y): U \rightarrow M \wedge N$ such that $v \circ (x, y) = x$ and $\mu \circ (x, y) = y$. We see that $(m \circ v) \circ (x, y) = m \circ x = u$, which proves that the intersection of m and n is the kernel of $q: X \rightarrow Q$. \square

Examples in the category Grp of groups show that a composite of two normal monomorphisms need not represent a normal subobject in general. On the other hand, as in Grp , every subobject has a unique normal closure.

1.7.2 Definition

Normal closure of a subobject

In a pointed category, let $m: M \rightarrow X$ represent a subobject of X . Provided it exists, the *normal closure* $\bar{m}: \bar{M} \rightarrow X$ of m is the least normal subobject of X containing m .

In a z -exact category every subobject has a unique normal closure:

1.7.3 Lemma

Existence of normal closure - z-Ex

Let $m: M \twoheadrightarrow X$ represent a subobject of X . Then $k: K(Q(u)) \twoheadrightarrow X$ is the least normal subobject of X containing m .

Proof To see this, consider this commutative diagram:

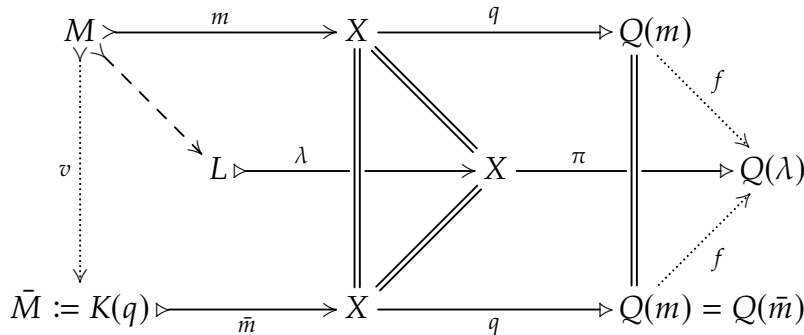

Via the front facing part, we see that $m < \bar{m}$. To see that \bar{m} represents the least normal subobject of X containing m , consider an arbitrary normal subobject $\lambda: L \twoheadrightarrow X$ containing m . It follows that π factors uniquely through q as shown. Consequently, \bar{m} factors uniquely through λ ; i.e., $\bar{m} < \lambda$. — This completes the proof. \square

Dually:

1.7.4 Proposition

Pushout of normal epimorphisms - z-Ex

In a pushout diagram of normal epimorphisms

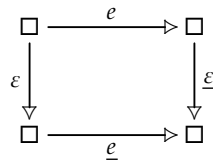

the composite $\underline{\varepsilon}e = \underline{e}\varepsilon$ is a normal epimorphism. \diamond

Exercises

1.7.5 Exercise

Intersection when binary products exist

Give an alternate proof of (1.7.1): In a pointed category with binary products, the intersection of the kernels of maps $f: X \rightarrow Y$ and $g: X \rightarrow Z$ is the kernel of the map $(f, g): X \rightarrow Y \times Z$.

1.8 Normal Decompositions and Factorizations

In a \mathcal{Z} -exact category \mathcal{X} , we present canonical ways of expressing a given morphism as a composite involving a strategically placed normal monomorphism, respectively normal epimorphism. This development forms a good foundation for a discussion of exact sequences, chain complexes, and homology. To explain the underlying idea, we use the interplay between three categories which are associated to \mathcal{X} :

- The *arrow category* $\text{Arr}(\mathcal{X})$ of \mathcal{X} . Its objects are morphisms $\square \xrightarrow{u} \square$, where u is a morphism in \mathcal{X} . A morphism $(a, b): u \rightarrow v$ is given by a commutative square in \mathcal{X} :

$$\begin{array}{ccc} \square & \xrightarrow{a} & \square \\ u \downarrow & & \downarrow v \\ \square & \xrightarrow{b} & \square \end{array}$$

- The category $\text{NM}(\mathcal{X})$ is the full subcategory of \mathcal{X} whose objects are normal monomorphisms in \mathcal{X} .
- The category $\text{NE}(\mathcal{X})$ is the full subcategory of \mathcal{X} whose objects are normal epimorphisms in \mathcal{X} .

An equivalence between the categories $\text{NM}(\mathcal{X})$ and $\text{NE}(\mathcal{X})$ is given by the functors

$$\text{coker}: \text{NM}(\mathcal{X}) \longrightarrow \text{NE}(\mathcal{X}) \quad \text{and} \quad \text{ker}: \text{NE}(\mathcal{X}) \longrightarrow \text{NM}(\mathcal{X})$$

Further, $\text{Arr}(\mathcal{X})$ contains $\text{NM}(\mathcal{X})$ as a reflective subcategory, and it contains $\text{NE}(\mathcal{X})$ as a coreflective subcategory; see Propositions 1.8.1 and 1.8.2.

1.8.1 Proposition

$\text{NM}(\mathcal{X})$ **reflective in** $\text{Arr}(\mathcal{X})$ - **\mathcal{Z} -Ex**

The category $\text{NM}(\mathcal{X})$ is reflective in \mathcal{X} , and the adjunction unit on an object f is given by the commutative square on the left.

$$\begin{array}{ccccc} \square & \xrightarrow{f} & \square & \xrightarrow{q:=\text{coker}(f)} & Q(f) \\ \eta_f^0 \downarrow \text{dotted} & & \parallel & & \parallel \\ K(q) & \xrightarrow{\text{ker}(q)} & \square & \xrightarrow{q} & Q(f) \end{array}$$

Proof This follows directly from the definitions. □

Dually:

1.8.2 Proposition

NE(\mathcal{X}) coreflective in Arr(\mathcal{X}) - z-Ex

The category NE(\mathcal{X}) is coreflective in \mathcal{X} , and the adjunction counit on an object u is given by the commutative square on the right.

$$\begin{array}{ccccc}
 K(f) & \xrightarrow{k} & \square & \xrightarrow{\text{coker}(k)} & Q(k) \\
 \parallel & & \parallel & & \downarrow \varepsilon_f^1 \\
 K(f) & \xrightarrow{k:=\ker(f)} & \square & \xrightarrow{f} & \square
 \end{array}$$

We are now ready to analyze decompositions $f = uv$ where u is a normal monomorphism or v is a normal epimorphism.

1.8.3 Definition

Normal decompositions - z-Ex

Consider a morphism $f: X \rightarrow Y$ in a z-exact category.

- (i) A composite $f = mu$ in which m is a normal monomorphism is called a *normal mono decomposition* of f .
- (ii) A composite $f = ve$ in which e is a normal epimorphism is called a *normal epi decomposition* of f .

Thus $f = 1_Y \circ f = f \circ 1_X$ is a normal mono, respectively a normal epi, decomposition of f . Whenever we have simultaneously a normal epi and a normal mono decomposition of a morphism, then the two are uniquely related as follows.

1.8.4 Proposition

Relationship between normal epi / mono decompositions - z-Ex

Given a morphism f with a given normal mono decomposition $f = mu$ and a normal epi decomposition $f = ve$, there is a unique map φ which renders the diagram below commutative.

$$\begin{array}{ccccc}
 & & f & & \\
 & \curvearrowright & & \curvearrowleft & \\
 \square & \xrightarrow{e} & \square & \xrightarrow{v} & \square \\
 & & \downarrow \varphi & & \\
 \square & \xrightarrow{u} & \square & \xrightarrow{m} & \square \\
 & \curvearrowleft & & \curvearrowright & \\
 & & f & &
 \end{array}$$

Proof Let $k := \ker(e)$. Then $e = \text{coker}(k)$. Noting that $mu k = 0$, the monic property of m yields $uk = 0$. So, there exists α , unique with $u = \alpha e$.

Let $q := \text{coker}(m)$. Then $m = \ker(q)$. Noting that $qve = 0$, the epic property of e yields $qv = 0$. So, there exists β , unique with $v = m\beta$.

We infer $\alpha = \beta$ from the computation $mae = mu = f = ve = m\beta e$. So, $\varphi := \alpha = \beta$ is the claimed map. \square

Among all normal epi decompositions of a given map f , there is one class which is distinguished by a being terminal. Dually, among all normal mono decompositions of f , there is an initial class:

1.8.5 Lemma

Initial / terminal normal decompositions - z-Ex

Every morphism $f: X \rightarrow Y$ has an initial normal mono decomposition given by the construction on the left.

$$\begin{array}{ccc}
 X & \xrightarrow{f} & Y & \xrightarrow{q} & Q(f) \\
 \parallel & & \uparrow & & \\
 X & \xrightarrow{\dots\dots\dots} & K & & \\
 & & \triangle & & \\
 & & m := \ker(q) & &
 \end{array}
 \qquad
 \begin{array}{ccc}
 K(f) & \xrightarrow{k} & X & \xrightarrow{f} & Y \\
 & & \downarrow & & \parallel \\
 & & Q & \xrightarrow{\dots\dots\dots} & Y \\
 & & \text{coker}(k) := e & & \\
 & & v := \varepsilon_f^1 & &
 \end{array}$$

Dually, f has a terminal normal epi decomposition given by the construction on the right.

Proof Apply the universal property of the unit η of the reflection $\text{Arr}(\mathcal{X}) \rightarrow \text{NM}(\mathcal{X})$, respectively the counit ε of the coreflection $\text{Arr}(\mathcal{X}) \rightarrow \text{NE}(\mathcal{X})$. \square

Via its universal property, the initial normal mono decomposition of a map f is unique up to isomorphism. We refer to it as the *normal mono factorization of f* . Similarly, we refer to the terminal normal epi decomposition of f as the *normal epi factorization of f* .

1.8.6 Notation

Normal epi / normal mono factorization comparison map

Given a map f in a z-exact category, Proposition 1.8.4 yields a unique map $EM(f)$ relating its normal epi factorization to its normal mono factorization. We call it the normal epi / normal mono factorization comparison map.

1.8.7 Lemma

Recognizing special initial/terminal decompositions - z-Ex

For a composite $f = vu$ the following hold:

- (i) If u is an epimorphism and v is a normal monomorphism, then vu is the normal mono factorization of f .
- (ii) If u is a normal epimorphism and v is a monomorphism, then vu is the normal epi factorization of f .

Proof (i) The universal property of the normal mono factorization of f yields this commutative diagram:

$$\begin{array}{ccccc}
 X & \xrightarrow{u'} & K & \xrightarrow{m} & Y \\
 \parallel & & \downarrow \alpha & & \parallel \\
 X & \xrightarrow{u} & L & \xrightarrow{v} & Y
 \end{array}$$

With (1.5.7), we see that α is an isomorphism because (a) commutativity of the square on the right shows (1.5.8) that α is a normal monomorphism, while (b) commutativity of the square on the left shows (1.1.13) that α is an epimorphism. \square

We single out three special cases involving the normal epi factorization and the normal mono factorization of a given morphism.

1.8.8 Definition

Image factorization - z-Ex

A morphism f admits an *image factorization* if it can be written as a composite $f = ve$, with e a normal epimorphism and v a monomorphism.

$$\square \xrightarrow[e]{} I(f) \xrightarrow{v} \square$$

f

In this situation, the domain of v is called the *image* of f .

In (1.8.8), the term image factorization generalizes what we know about functions of sets: Every function has an essentially unique factorization into ‘surjection’ followed by ‘injection’. The situation here is analogous: Whenever f admits an image factorization as ve , then (1.8.7) tells us that it is a special kind of normal epi factorization. It is available if and only if the comparison map $EM(f)$ is monic.

Less commonly used is the dual ‘coimage factorization’ of ‘image factorization’: An epimorphism followed by a normal monomorphism. In this case, the normal mono factorization $f = mu$ the map u happens to be an epimorphism. This occurs if and only if the comparison map $EM(f)$ is epic. Thus $coim(f) := u$ is called the *coimage* of f , and $col(f)$ is the codomain of $coim(f)$.

Given a map f , we are particularly interested in the special case where a normal mono factorization and a normal epi factorization coincide or, more precisely, where the normal epi / normal mono factorization comparison map $EM(f)$ is an isomorphism:

1.8.9 Definition

Normal morphism - z-Ex

A morphism $f: X \rightarrow Y$ is called *normal*, also *proper*, if it admits a decomposition $f = me$

in which m is a normal monomorphism and e is a normal epimorphism.

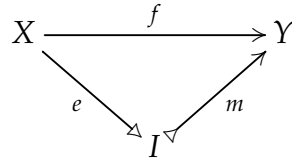

With (1.8.7) we see that, for a normal morphism, its normal mono factorization coincides with its normal epi factorization. In particular, the decomposition $f = me$, with $m = \ker(\text{coker}(f))$ and $e = \text{coker}(\ker(f))$, is unique up to unique isomorphism. Thus we may refer to the decomposition $f = me$ as the *normal factorization* of f . — We develop basic properties of normal maps.

1.8.10 Proposition

Recognizing the normal factorization - z-Ex

Suppose a normal map f admits a decomposition $f = np$ with n monic and p epic. Then n is a normal monomorphism, and p is a normal epimorphism.

Proof In the diagram below, the bottom row is the normal factorization of f .

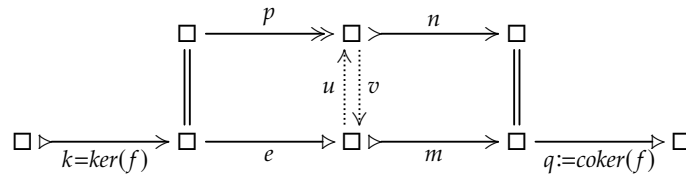

We know that $e = \text{coker}(k)$, and that $npk = fk = 0$. With the monic property of n we conclude that $pk = 0$. There exists u , unique with $p = ue$ because $e = \text{coker}(k)$. Dually, $qnp = qf = 0$. With the epic property of p we conclude that $qn = 0$. There exists v , unique with $n = mv$ because $m = \ker(q)$.

The claim will follow once we show that u and v are inverses of each other. Indeed, using the monic and epic properties of m and e ,

$$mvue = mvp = np = me \quad \text{and so} \quad e = vue \quad \text{and so} \quad vu = 1$$

Similarly,

$$nuvp = mvuvp = mvp = np$$

Using the monic and epic properties of n and p , $uv = 1$, and the proof is complete. \square

1.8.11 Proposition Factoring normal map through a subobject of its codomain - z-Ex

If a normal map $f: X \rightarrow Y$ is a composite $f = \mu f'$ with μ a monomorphism, then f' is a normal map.

Proof We reason using this diagram:

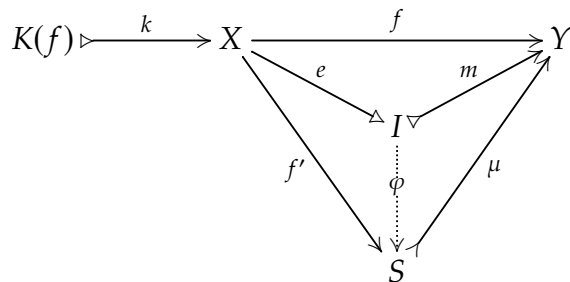

First note that $k = K(f')$ because μ is monic; see (1.5.8.ii). Then we know from (1.8.5) that $e = Q(k)$. So there is $\varphi: I \rightarrow S$, unique with $f' = \varphi e$. The identity $m = \mu\varphi$ follows from the epic property of e and the computation

$$\mu\varphi e = \mu f' = f = m e$$

With (1.5.8.iv) we infer that φ is a normal monomorphism. Thus the composite φe is a normal decomposition of f' ; i.e., f' is a normal map. \square

In other words, (1.8.11) says that, whenever in a normal composite $X \xrightarrow{f} Y \xrightarrow{g} Z$ the map g is a monomorphism, then f is a normal map. - Dually:

1.8.12 Proposition **Factoring a normal map through quotient of domain - z-Ex**
 If a normal map $f: X \rightarrow Y$ is a composite $f = \bar{f}\varepsilon$ with ε an epimorphism, then \bar{f} is a normal map. \diamond

By using the universal properties of kernels and cokernels, we see that normal factorizations are functorial:

1.8.13 Proposition **Normal factorizations are functorial - z-Ex**
 If in a commutative square of morphisms, as on the left, the horizontal arrows are normal, then there is a unique map which renders their normal factorizations commutative, as on the right below.

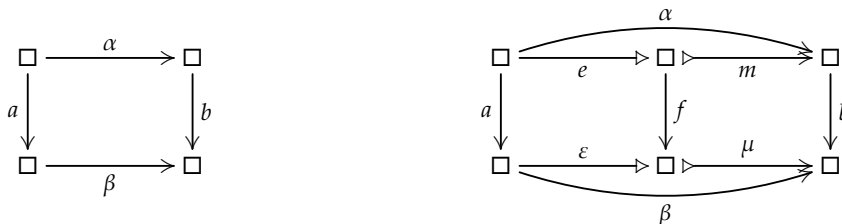

We now consider decompositions of order 2. Initially perhaps surprising, such decompositions occur ‘naturally’.

1.8.14 Definition

Subnormal decompositions - z-Ex

A *subnormal mono decomposition* of a morphism f is given by a sequence $f = m_1 m_2 u$ in which m_1 and m_2 are normal monomorphisms. Dually, a *subnormal epi decomposition* of f is given by a sequence $f = v e_2 e_1$ in which e_1 and e_2 are normal epimorphisms.

The subnormal mono decompositions of f contain an initial object which is obtained in two steps, namely

1. Into the normal mono factorization $f = m_1 u_1$ of f , insert
2. the normal mono factorization $f = m_1(m_2 u_2)$ of u_1 .

Dually, the subnormal epi decompositions of f contain a terminal object $f = (v_2 e_2) e_1$ constructed from the normal epi factorization $f = v_1 e_1$ of f .

We call f *subnormal* if it admits a subnormal mono decomposition $f = m_1 m_2 e$ in which e is a normal epimorphism. We call f *cosubnormal* if it admits a subnormal epi decomposition $f = m e_2 e_1$ in which m is a normal monomorphism.

For instance, in the category Grp of groups, any composite of two normal subgroup inclusions is a subnormal map, while any cosubnormal map is automatically normal. In general, we have:

1.8.15 Proposition

Subnormal and cosubnormal implies normal - z-Ex

A morphism which is both subnormal and cosubnormal is normal.

Proof Assume that $m e_2 e_1 = f = m_1 m_2 e$ factors as $m e_2 e_1$, where e, e_1, e_2 are normal epimorphisms and m, m_1, m_2 are normal monomorphisms. Thus we have this commutative diagram:

$$\begin{array}{ccccccc}
 \square & \xrightarrow{e_1} & \square & \xrightarrow{e_2} & \square & \xrightarrow{m} & \square \\
 \parallel & & \downarrow p & \nearrow i & \downarrow k & & \parallel \\
 \square & \xrightarrow{e} & \square & \xrightarrow{m_2} & \square & \xrightarrow{m_1} & \square
 \end{array}$$

The composite $m(e_2 e_1)$ is the normal mono factorization of f . So, there exists k unique with $m = m_2 k$ and $k e_2 e_1 = m_2 e$. Then k is a normal monomorphism because the right hand square commutes. Also, $(m_1 m_2) e$ is the normal epi factorization of f . So, there exists p unique with $e = p e_1$ and $m_1 m_2 p = m e_2$. Then p is a normal epimorphism because the left hand square commutes. Via the monic property of m_1 or the epic property of e_1 , we see that the middle square commutes as well.

Now recall that normal epimorphisms are strong. So, the center square has two unique fillers i and j which render the resulting triangles commutative. It follows that $j = i^{-1}$, implying that the composite e_2e_1 is a normal epimorphism and that m_1m_2 is a normal monomorphism. Thus f is a normal map. \square

We close this section by clarifying how to compute (co)limits in the categories $\text{NM}(\mathcal{X})$ and $\text{NE}(\mathcal{X})$. Here, we rely on the general principles governing limits and colimits in reflective, respectively coreflective, subcategories; see Section A.5,

1.8.16 Proposition

(Co)limits in $\text{NM}(\mathcal{X})$ and in $\text{NE}(\mathcal{X})$ - z-Ex

In a z-exact category \mathcal{X} the following hold:

- (i) If \mathcal{X} admits limits over a small category D , then so does $\text{NM}(\mathcal{X})$, and these are computed object-wise.
- (ii) If \mathcal{X} admits colimits over a small category D , then so does $\text{NM}(\mathcal{X})$. To compute the colimit of a diagram $\Phi: D \rightarrow \text{NM}(\mathcal{X})$ of normal monomorphisms, compute the colimit of Φ in $\text{Arr}(\mathcal{X})$, then apply the reflector $\text{Arr}(\mathcal{X}) \rightarrow \text{NM}(\mathcal{X})$.
- (iii) If \mathcal{X} admits colimits over a small category D , then so does $\text{NE}(\mathcal{X})$, and these are computed object-wise.
- (iv) If \mathcal{X} admits limits over a small category D , then so does $\text{NE}(\mathcal{X})$. To compute the limit of a diagram $\Psi: D \rightarrow \text{NE}(\mathcal{X})$ of normal monomorphisms, compute the limit of Ψ in $\text{Arr}(\mathcal{X})$, then apply the coreflector $\text{Arr}(\mathcal{X}) \rightarrow \text{NE}(\mathcal{X})$.

Proof (i) is true because kernels commute with limits. Dually, (iii) is true because cokernels commute with colimits.

(ii) is an application of (A.5.2), and (iv) is its dual. \square

1.8.17 Proposition

Normal mono in $\text{NM}(\mathcal{X})$ / normal epi in $\text{NE}(\mathcal{X})$ - z-Ex

In a z-exact category \mathcal{X} the following hold:

- (i) A morphism in $\text{NE}(\mathcal{X})$ is a normal epimorphism if and only if its underlying square in \mathcal{X} is a pushout of normal epimorphisms.
- (ii) A morphism in $\text{NM}(\mathcal{X})$ is a normal monomorphism if and only if its underlying square in \mathcal{X} is a pullback of normal monomorphisms.

Proof We prove (ii). In the commutative diagram below, assume that the left hand

square represents the kernel of the right hand square in $\text{NM}(\mathcal{X})$.

$$\begin{array}{ccccc}
 K & \xrightarrow{\alpha} & A & \xrightarrow{q} & B \\
 \downarrow k & \circlearrowleft & \downarrow a & & \downarrow b \\
 K' & \xrightarrow{\alpha'} & A' & \xrightarrow{q'} & B'
 \end{array}$$

Then $\alpha = \ker(q)$ in \mathcal{X} , and $\alpha' = \ker(q')$. By (1.6.2), the left hand square is a pullback.

Conversely, suppose the square on the left is a pullback of normal monomorphisms. Construct the right hand square as the cokernel of (α, α') in $\text{NM}(\mathcal{X})$. Then $q' = \text{coker}(\alpha')$ and, hence, $\alpha' = \ker(q')$. We show directly that $(\alpha, \alpha') = \ker(q, q')$. Indeed, if $(x, x') : m \rightarrow a$ is such that $(q, q')(x, x') = (qx, q'x') = (0, 0)$, then x' factors uniquely through α' via t' . The pullback property of the left hand square yields a unique factorization of x through α via t . It follows that (t, t') is the required unique factorization of (x, x') through (α, α') in $\text{NM}(\mathcal{X})$. \square

Notes On Puppe-exact categories

A *Puppe-exact* or *p-exact* category is a z-exact category in which all morphisms are normal; see [41, 42] and the citations there to the foundational work of Puppe, Mitchell and others. Whenever a p-exact category admits binary products or binary coproducts, then it is abelian; see [34] for an explicit proof of this fact.

Exercises

1.8.18 Definition

Subnormal decompositions of order r - z-Ex

A *subnormal mono decomposition of order r* of $f : X \rightarrow Y$ is a diagram

$$X \xrightarrow{u} K_r \xrightarrow{m_r} \cdots \xrightarrow{m_1} Y$$

in which m_r, \dots, m_1 are normal monomorphisms. Dually, a *subnormal epi decomposition of order r* of f is a diagram

$$X \xrightarrow{e_1} \cdots \xrightarrow{e_r} Q_r \xrightarrow{v} Y$$

in which e_1, \dots, e_r are normal epimorphisms.

1.8.19 Exercise

Initial / terminal subnormal decompositions - z-Ex

Given a map f in a pointed category, show that iterating the constructions in Lemma 1.8.5 yields:

- (i) A normal mono decomposition of order r of f , which is initial among all such decompositions, and
- (ii) a normal epi decomposition of order r of f , which is terminal among all such decompositions.

1.8.20 Definition

Subnormal / cosubnormal map of order r - z-Ex

We say that f is *subnormal of order r* if it admits a subnormal mono decomposition of order r in which the map u is a normal epimorphism. Dually, f is *cosubnormal of order r* if it admits a subnormal epi decomposition of order r in which the map v is a normal monomorphism.

1.8.21 Exercise

Subnormal and cosubnormal of order r implies normal

A map f which is both subnormal and cosubnormal of order r is normal.

1.8.22 Exercise

Solvable group via subnormal factorization

In the category Grp of groups, show that a group G is solvable if and only if there is $r \geq 1$ for which the zero map $0 \rightarrow G$ admits a subnormal decomposition of order r for which the quotient groups $Q_i := N_i/N_{i+1}$ in the diagram below are abelian.

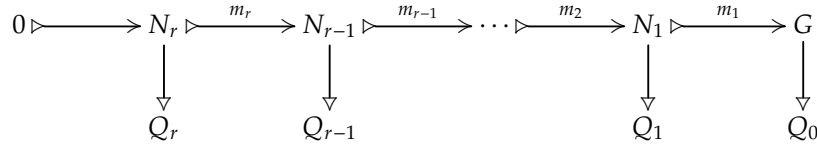

1.8.23 Exercise

Nilpotent group via cosubnormal factorization

In the category Grp of groups, show that a group G is nilpotent of order less than or equal to r if and only if the zero map $G \rightarrow 0$ admits a cosubnormal decomposition of order r for which the kernel groups $K_i := K(Q_i \rightarrow Q_{i+1})$ in the diagram below are central in Q_i :

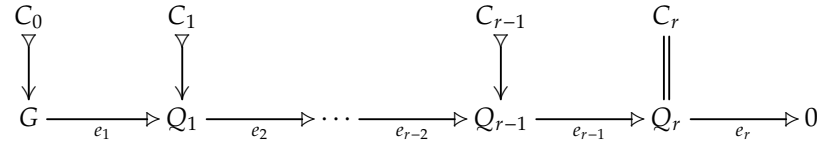

1.8.24 Exercise

Colimits in $NM(\mathcal{X})$, alternate computation - z-Ex

In a pointed category \mathcal{X} , show that the colimit of a diagram $\Phi: D \rightarrow NM(\mathcal{X})$ may be computed as:

$$\text{colim}^D(\Phi) \cong \ker \left(\text{colim}^D(\text{coker} \circ \Phi) \right)$$

In detail:

1. Let $\Psi := \text{coker} \circ \Phi: D \rightarrow NE(\mathcal{X})$ be the diagram in $NE(\mathcal{X})$ obtained by applying normal subobject / quotient inversion to the diagram Φ in $NM(\mathcal{X})$.
2. Compute $\text{colim}(\Psi)$ in $NE(\mathcal{X})$ by taking object-wise colimits.
3. Apply normal subobject / quotient inversion to the result of (ii).

Dualized the above to a computation of the limit of a diagram $\Psi: D \rightarrow NE(\mathcal{X})$.

1.9 Exact Sequences

In this section we introduce exact sequences and we develop their basic properties. So, what say here applies even in low structured settings such as the category Set_* of pointed sets or the category Mag of unital magmas.

1.9.1 Definition

Short exact sequence/extension

A *short exact sequence* in a pointed category is a diagram

$$E \quad K \triangleright \xrightarrow{k} X \xrightarrow{q} \triangleright Q$$

where k is a kernel of q , and q is a cokernel of k . We also say that E is an *extension of K over Q* , or a *cover of Q by K* .

In a short exact sequence E , as in (1.9.1), we sometimes write Q as the quotient X/K . Such a sequence provides a tool for the structural analysis of objects: In a z -exact category, where kernels and cokernels are always available, the middle object X , together with either of the end objects determines the other end object up to isomorphism. — When dealing with short exact sequences, we generally assume that kernels and cokernels exist. With (1.4.17) we see:

1.9.2 Example

Extension with middle object 0 - z-Ex

A sequence $K \rightarrow 0 \rightarrow Q$ is short exact if and only if $K = 0 = Q$. \diamond

1.9.3 Example

Extension by 0's - z-Ex

A sequence $0 \rightarrow X \rightarrow 0$ is short exact if and only if $X = 0$. \diamond

1.9.4 Example

Constructing a short exact sequence from a normal mono/epi - z-Ex

If $f: X \triangleright \rightarrow Y$ is a normal monomorphism, then the sequence on the left below is short exact. If $g: Y \rightarrow Z$ is a normal epimorphism, then the sequence on the right is short exact.

$$X \triangleright \xrightarrow{f} Y \longrightarrow \triangleright Q(f) \quad K(g) \triangleright \longrightarrow Y \xrightarrow{g} \triangleright Z$$

Proof This is so because a normal monomorphism is the kernel of its cokernel, respectively, a normal epimorphism is the cokernel of its kernel; see (1.4.7). \square

More generally:

1.9.5 Definition

Exactness of composable maps - z-Ex

A sequence of composable maps

$$A \xrightarrow{f} B \xrightarrow{g} C$$

is *exact (in position B)* if f admits a normal factorization $f = me$ such that $m = \ker(g)$. It is *coexact (in position B)* if g admits a normal factorization $g = kp$ such that $p = \operatorname{coker}(f)$.

1.9.6 Lemma

Recognizing exactness - z-Ex

For composable *normal* morphisms g following f the conditions below are equivalent.

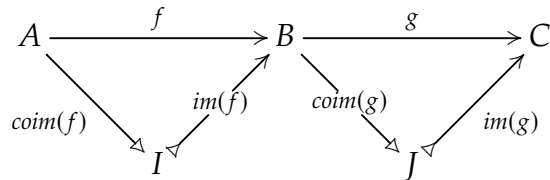

- (I) The sequence is exact in position B ; i.e., $\operatorname{im}(f) = \ker(g)$.
- (II) The sequence is coexact in position B ; i.e., $\operatorname{coker}(f) = \operatorname{coim}(g)$
- (III) The sequence $I \twoheadrightarrow B \rightarrow J$ is short exact. ◇

1.9.7 Corollary

Recognizing a short exact sequence - z-Ex

A sequence of normal morphisms of the form

$$(S) \quad 0 \longrightarrow A \xrightarrow{f} B \xrightarrow{g} C \longrightarrow 0$$

is exact if and only if the sequence $A \xrightarrow{f} B \xrightarrow{g}$ is short exact. ◇

Extending Definition 1.9.5, we say that a sequence of finite length

$$X_0 \xrightarrow{f_0} X_1 \xrightarrow{f_1} \cdots \rightarrow X_k \xrightarrow{f_k} \cdots \rightarrow X_n \xrightarrow{f_n} X_{n+1}$$

is *exact* if, for every $1 \leq k \leq n$, the sequence $X_{k-1} \rightarrow X_k \rightarrow X_{k+1}$ is exact. This implies that the maps f_0, \dots, f_{n-1} are normal maps.

Dually, the sequence is *coexact* if, for every $1 \leq k \leq n$, the sequence $X_{k-1} \rightarrow X_k \rightarrow X_{k+1}$ is coexact. This implies that the maps f_1, \dots, f_n are normal maps. Extending to infinite sequences:

1.9.8 Definition

Long exact sequence - z-Ex

A sequence of morphisms $\cdots \rightarrow X_{n+1} \rightarrow X_n \xrightarrow{f_n} X_{n-1} \rightarrow \cdots$ is called *long exact* if it can be spliced together from short exact sequences $Z_n \xrightarrow{k_n} X_n \xrightarrow{q_n} Z_{n-1}$ as in Figure 1.1.

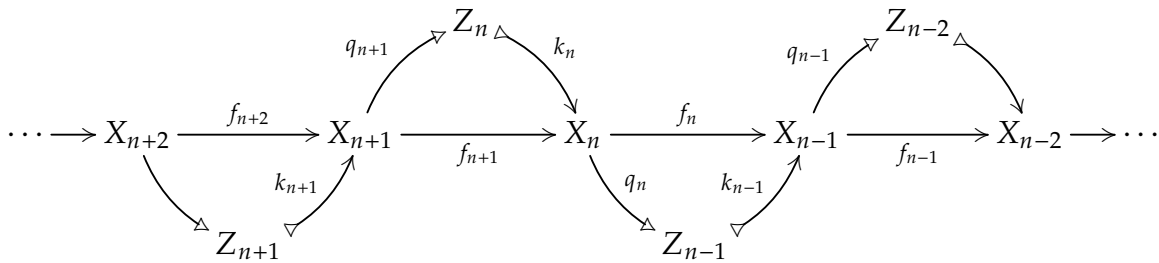

Figure 1.1: An exact sequence admits splicing by short exact sequences

This means that every morphism in a long exact sequence admits a normal factorization, and factorizations of adjacent morphisms form short exact sequences as shown. Note that the sequence of morphisms in (1.9.8) is exact if and only if it is coexact (i.e., exact in the opposite category). For historic reasons we favor using the term ‘exact’. With (1.5.8.ii) and (1.5.9.ii) we see that

$$k_n = \ker(q_n) = \ker(f_n) \quad \text{and} \quad q_n = \text{coker}(k_n) = \text{coker}(f_{n+1})$$

Whenever a sequence of morphisms admits a decomposition as in Figure 1.1, then this decomposition is unique up to isomorphism, in agreement with Section 1.8.

Notes

Use of the term ‘extension’ The use of the term ‘extension’ is conflicted in the literature. Some authors refer to a short exact sequence $K \xrightarrow{k} X \xrightarrow{q} Q$ as an extension of Q .

First use of the term ‘exact’ Curiously, it seems that exactness of a sequence of abelian groups was only used more than a decade after the introduction of homology of a chain complex; see a talk by Hurewicz [50]. This is according to the Kelley-Pitcher [56, p. 682] who appear to be the first to use the term ‘exact sequence’ [56, Def. 3.1], but see also what Hilton [46, p. 291] explains regarding J. H. C. Whitehead’s work.

Exercises

1.9.9 Exercise

Factoring a morphism of zero maps - z-Ex

[10, p. 272ff] In the diagram below, assume that the front face commutes, and that the bottom right

square is a pullback.

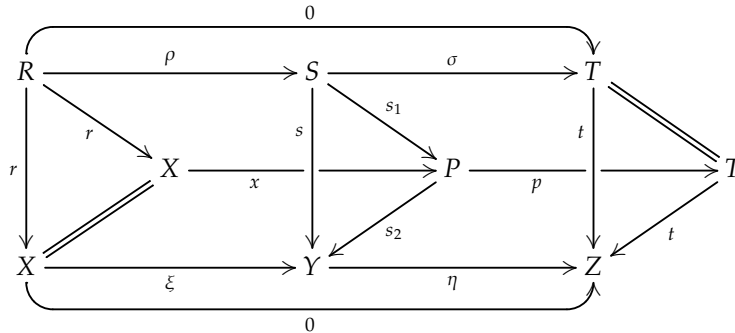

Then the following hold:

- (i) There exist unique maps s_1 and x rendering the entire diagram commutative.
- (ii) If $\xi = \ker(\eta)$, then $x = \ker(p)$.
- (iii) If $\xi = \ker(\eta)$ and $\rho = \ker(\sigma)$, then the upward facing left hand square is a pullback.
- (iv) If $\xi = \ker(\eta)$ and the upper sequence is short exact, then $X \xrightarrow{x} P \xrightarrow{p} T$ is short exact.

1.9.10 Exercise

Short exact sequence in Set_*

In the category Set_* of pointed sets show that, in a short exact sequence $N \xrightarrow{i} X \xrightarrow{q} Q$ the following hold:

- (i) q has a unique section $s: Q \rightarrow X$, and
- (ii) i and s form a cocone for X as the coproduct of N and Q .

1.9.11 Exercise

Factoring the cokernel of a map - z-Ex

Given composable maps $f: X \rightarrow Y$ and $g: Y \rightarrow Z$, show that the diagram of below has exact rows and columns and commutes.

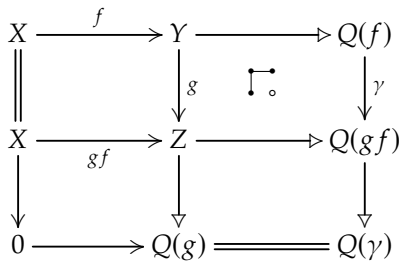

Moreover, the square on the upper right is a pushout. Hint: Corollary 1.5.10.

1.10 The Category of Short Exact Sequences - I

Associated to a \mathcal{X} -exact category \mathcal{X} is the category $\text{SES}(\mathcal{X})$ of short exact sequences in \mathcal{X} . It has:

- *objects* short exact sequences in \mathcal{X} , which we denote $(\varepsilon) \quad M \triangleright \rightarrow X \rightarrow Q$;
- *morphisms* commutative diagrams in \mathcal{X} whose rows are short exact sequences:

$$\begin{array}{ccc}
 & \varepsilon & \\
 (\kappa, \xi, \rho) \downarrow & & \\
 & \varphi & \\
 & & \\
 K \triangleright \xrightarrow{k} X \xrightarrow{q} Q & & \\
 \kappa \downarrow & \xi \downarrow & \rho \downarrow \\
 L \triangleright \xrightarrow{l} Y \xrightarrow{r} R & &
 \end{array}$$

We show (1.10.1) that $\text{SES}(\mathcal{X})$ is again a \mathcal{X} -exact category. A zero object is given by the short exact sequence $0 \rightarrow 0 \rightarrow 0$. If (co)limits over some small category D exists in \mathcal{X} , then the constructions in (1.10.2) provide (co)limits over D in $\text{SES}(\mathcal{X})$. Such computations are facilitated by using that the category $\text{SES}(\mathcal{X})$ is equivalent to the category $\text{NM}(\mathcal{X})$ of normal monomorphisms in \mathcal{X} as well as to the category $\text{NE}(\mathcal{X})$ of normal epimorphisms in \mathcal{X} ; see Section 1.8.

Indeed, forgetting the normal monomorphism of a short exact sequence yields a functor $C: \text{SES}(\mathcal{X}) \rightarrow \text{NE}(\mathcal{X})$. Similarly, forgetting the normal epimorphism of a short exact sequence yields a functor $K: \text{SES}(\mathcal{X}) \rightarrow \text{NM}(\mathcal{X})$. Using functorial kernels, respectively cokernels, yields equivalence inverses

$$\text{NE}(\mathcal{X}) \longrightarrow \text{SES}(\mathcal{X}) \quad \text{and} \quad \text{NM}(\mathcal{X}) \longrightarrow \text{SES}(\mathcal{X})$$

Here is a diagrammatic view of these equivalences.

$$\begin{array}{ccc}
 \text{NM}(\mathcal{X}) & \xrightleftharpoons[\text{ker}]{\text{coker}} & \text{NE}(\mathcal{X}) \\
 \swarrow K & & \searrow C \\
 & \text{SES}(\mathcal{X}) & \\
 \swarrow & & \searrow \\
 & &
 \end{array}
 \qquad
 \begin{array}{ccc}
 K \triangleright \xrightarrow{k} X \xrightarrow{q} Q & \xrightleftharpoons[\text{ker}(q)]{\text{coker}(k)} & X \xrightarrow{q} Q \\
 \swarrow & & \searrow \\
 & \text{SES}(\mathcal{X}) & \\
 \swarrow & & \searrow \\
 & &
 \end{array}$$

1.10.1 Theorem

If \mathcal{X} has (co)limits over a small category D , then so does $\text{SES}(\mathcal{X})$.

$\text{SES}(\mathcal{X})$ is a \mathcal{X} -exact category - \mathcal{X} -Ex

Proof If 0 is a zero object in \mathcal{X} , then the short exact sequence $0 \rightarrow 0 \rightarrow 0$ is a zero object in $\text{SES}(\mathcal{X})$. To see what (co)limits exist in $\text{SES}(\mathcal{X})$ we may use the equivalence between $\text{SES}(\mathcal{X})$ and either of the categories $\text{NM}(\mathcal{X})$ and $\text{NE}(\mathcal{X})$, combined with Proposition 1.8.16. \square

Let us explain explicitly how (co)limits in $\text{SES}(\mathcal{X})$ are computed: A diagram of short exact sequences modeled on a small category D is given by a functor $F: D \rightarrow \text{SES}(\mathcal{X})$. Then every object d in D yields a short exact sequence

$$Fd \quad K_{Fd} \triangleright \xrightarrow{\kappa_{Fd}} X_{Fd} \xrightarrow{q_{Fd}} Q_{Fd}$$

With this notational convention we have:

1.10.2 Corollary

Computation of (co)limits in $\text{SES}(\mathcal{X})$ - z-Ex

For a pointed category \mathcal{X} in which (co)limits modeled on a small category D exist:

- (i) D -colimits in $\text{SES}(\mathcal{X})$ exist. If $F: D \rightarrow \text{SES}(\mathcal{X})$ is a diagram modeled on a (finite) small category D , then

$$\text{colim}(F) \quad K(\text{colim}(q \circ F)) \triangleright \longrightarrow \text{colim}(X \circ F) \xrightarrow{\text{colim}(q \circ F)} \text{colim}(Q \circ F)$$

- (ii) C -limits in $\text{SES}(\mathcal{X})$ exist. If $F: D \rightarrow \text{SES}(\mathcal{X})$ is a diagram modeled on a (finite) small category D , then

$$\text{lim}(F) \quad \text{lim}(K \circ F) \xrightarrow{\text{lim}(\kappa \circ F)} \text{lim}(X \circ F) \longrightarrow Q(\text{lim}(\kappa \circ F))$$

Proof These claims may be verified directly. However, by (1.8.16), limits in $\text{NM}(\mathcal{X})$ are computed pointwise, and colimits in $\text{NE}(\mathcal{X})$ are computed pointwise. Via the equivalences between $\text{NM}(\mathcal{X})$, $\text{NE}(\mathcal{X})$, and $\text{SES}(\mathcal{X})$, the computation of (co)limits in $\text{SES}(\mathcal{X})$ is encapsulated in these diagrams:

$$\begin{array}{ccc} \text{SES}(\mathcal{X}) & \xrightarrow{\text{lim in SES}(\mathcal{X})} & \text{SES}(\mathcal{X}) \\ \simeq \downarrow K & & \uparrow \text{ker} \simeq \\ \text{NM}(\mathcal{X}) & \xrightarrow{\text{lim in NM}(\mathcal{X})} & \text{NM}(\mathcal{X}) \end{array} \quad \begin{array}{ccc} \text{SES}(\mathcal{X}) & \xrightarrow{\text{colim in SES}(\mathcal{X})} & \text{SES}(\mathcal{X}) \\ \simeq \downarrow C & & \uparrow \text{coker} \simeq \\ \text{NE}(\mathcal{X}) & \xrightarrow{\text{colim in NE}(\mathcal{X})} & \text{NE}(\mathcal{X}) \end{array}$$

This is what we wanted to show. \square

We conclude that, while $\text{SES}(\mathcal{X})$ is a category of diagrams, it is not equivalent to a functor category because (co-)limits in $\text{SES}(\mathcal{X})$ are *not necessarily* computed object-wise. For example:

1.10.3 Corollary

(Co)kernels in $\text{SES}(\mathcal{X})$ - z-Ex

The (co)kernel of a morphism (μ, ξ, η) in $\text{SES}(\mathcal{X})$ is computed as in this commutative diagram with horizontal short exact sequences, and where λ is the kernel, and σ the cokernel of ξ :

$$\begin{array}{ccccc}
 M & \xrightarrow{m} & N & \xrightarrow{\quad} & Q(m) \\
 \mu \downarrow & \circlearrowleft & \downarrow v & & \downarrow \zeta \\
 K & \xrightarrow{k} & X & \xrightarrow{q} & Q \\
 \kappa \downarrow & & \xi \downarrow & & \downarrow \rho \\
 L & \xrightarrow{l} & Y & \xrightarrow{r} & R \\
 \eta \downarrow & & \sigma \downarrow & \circlearrowright & \downarrow \tau \\
 K(t) & \xrightarrow{\quad} & S & \xrightarrow{t} & T
 \end{array}
 \quad (\kappa, \xi, \rho) \downarrow \varphi \quad (1.10.3)$$

In this situation, the top left square is a pullback, and the bottom right square is a pushout.

Proof The computation of $\ker(\kappa, \xi, \rho) = (\mu, v, \zeta)$ and of $\text{coker}(\kappa, \xi, \rho) = (\eta, \sigma, \tau)$ is given by (1.10.2). The pullback/pushout claims follow from (1.8.17). \square

1.10.4 Corollary

Monos/epis in $\text{NM}(\mathcal{X})$, $\text{SES}(\mathcal{X})$, $\text{NE}(\mathcal{X})$ - z-Ex

The following hold for a morphism in $\text{NM}(\mathcal{X})$, respectively $\text{SES}(\mathcal{X})$, respectively $\text{NE}(\mathcal{X})$:

$$\begin{array}{ccc}
 \begin{array}{ccc} K & \xrightarrow{k} & X \\ \kappa \downarrow & & \downarrow \xi \\ L & \xrightarrow{l} & Y \end{array} &
 \begin{array}{ccccc} K & \xrightarrow{k} & X & \xrightarrow{q} & Q \\ \kappa \downarrow & & \downarrow \xi & & \downarrow \rho \\ L & \xrightarrow{l} & Y & \xrightarrow{r} & R \end{array} &
 \begin{array}{ccc} X & \xrightarrow{q} & Q \\ \xi \downarrow & & \downarrow \rho \\ Y & \xrightarrow{r} & R \end{array}
 \end{array}$$

- (i) Any of the three morphisms above is a monomorphism in its category if and only if ξ is a monomorphism.
- (ii) Any of the three morphisms above is a epimorphism in its category if and only if ξ is a epimorphism.

Proof (i) We prove the claim in $\text{SES}(\mathcal{X})$, and infer the claim in $\text{NM}(\mathcal{X})$, respectively in $\text{NE}(\mathcal{X})$ from the equivalences between these three categories. - If (κ, ξ, ρ) is a monomor-

phism in $\text{SES}(\mathcal{X})$ we infer that ξ is monic from this situation:

$$\begin{array}{ccccc}
 0 & \longrightarrow & A & \xlongequal{\quad} & A \\
 \downarrow & & \downarrow a & \downarrow b & \downarrow qa \quad \downarrow qb \\
 K & \xrightarrow{k} & X & \xrightarrow{q} & Q \\
 \downarrow \kappa & & \downarrow \xi & & \downarrow \rho \\
 L & \xrightarrow{l} & Y & \xrightarrow{r} & R
 \end{array}$$

Suppose $\xi a = \xi b$. Then we obtain two morphisms into the middle row which, after composing with the monomorphism (κ, ξ, ρ) are equal. Thus $a = b$, implying that ξ is monic.

Conversely, suppose ξ is a monomorphism in \mathcal{X} . To show that (κ, ξ, ρ) is a monomorphism in $\text{SES}(\mathcal{X})$ consider the situation below.

$$\begin{array}{ccccc}
 M & \xrightarrow{m} & Z & \xrightarrow{s} & S \\
 \downarrow \mu & & \downarrow \zeta & \downarrow \zeta' & \downarrow \gamma \quad \downarrow \gamma' \\
 K & \xrightarrow{k} & X & \xrightarrow{q} & Q \\
 \downarrow \kappa & & \downarrow \xi & & \downarrow \rho \\
 L & \xrightarrow{l} & Y & \xrightarrow{r} & R
 \end{array}$$

If $(\kappa, \xi, \rho) \circ (\mu, \zeta, \gamma) = (\kappa, \xi, \rho) \circ (\mu', \zeta', \gamma')$, then $\xi \zeta = \xi \zeta'$, implying that $\zeta = \zeta'$ since ξ is monic. It follows that

$$\gamma s = q \zeta = q \zeta' = \gamma' s$$

So, $\gamma = \gamma'$ via the epic property of the normal epimorphism b . Similarly,

$$k \mu = \zeta m = \zeta' m = k \mu'$$

So, $\mu = \mu'$ via the monic property of the normal monomorphism k . - The proof of (ii) is similar. \square

1.10.5 Corollary

Adjunction between $\text{Arr}(\mathcal{X})$ and $\text{SES}(\mathcal{X})$ - z-Ex

Associated to a pointed category \mathcal{X} are these adjunctions

$$\text{Arr}(\mathcal{X}) \begin{array}{c} \xrightarrow{\quad} \\ \perp \\ \xleftarrow{G \circ K} \end{array} \text{SES}(\mathcal{X}) \qquad \text{Arr}(\mathcal{X}) \begin{array}{c} \xrightarrow{\quad} \\ \top \\ \xleftarrow{G' \circ C} \end{array} \text{SES}(\mathcal{X})$$

Given a morphism $f: X \rightarrow Y$ in \mathcal{X} , the following hold:

(i) The left adjoint of the adjunction on the left sends f to the short exact sequence

$$K(Q(f)) \triangleright \longrightarrow Y \longrightarrow Q(f)$$

(ii) The right adjoint of the adjunction on the right sends f to the short exact sequence

$$K(f) \triangleright \longrightarrow X \longrightarrow Q(K(f))$$

Since the category of short exact sequences in a z-exact category is again a z-exact category, we may consider short exact sequences of short exact sequences; that is we may consider the category $\text{SES}(\text{SES}(\mathcal{X}))$. Due to the particular way in which we compute (co)limits in $\text{SES}(\mathcal{X})$ unexpected phenomena may occur. For example:

1.10.6 Example Short exact sequence of short exact sequences in $\text{Grp}(\text{Top})$

Based on [27, p. 43]: Consider this commutative diagram of topological groups:

$$\begin{array}{ccccc}
 0 & \longrightarrow & R^\delta & \xlongequal{\quad} & R^\delta \\
 \downarrow & & \downarrow (0,1) & & \downarrow h \\
 R^\delta & \xrightarrow{(1,0)} & X & \xrightarrow{pr_2} & R \\
 \downarrow h & & \downarrow pr_1 & & \downarrow \\
 R & \xlongequal{\quad} & R & \longrightarrow & 0
 \end{array}$$

Here R denotes the additive group of real numbers with the Euclidean topology, and R^δ the same group with the discrete topology. Let $h: R^\delta \rightarrow R$ denote the continuous bijection given by the identity map on underlying sets. Further, let X be the topological space obtained by refining the product topology on $R \times R$ by the sets

$$U_s := \{(x, y) \in R \times R \mid x - y = s\}$$

Then addition yields the structure of a topological group on X . Moreover, the functions $pr_1, pr_2: X \rightarrow R$ which are projections on underlying sets are normal epimorphisms whose kernels are copies of R^δ .

So, the rows of the above diagram are short exact sequences in the category $\text{Grp}(\text{Top})$ of topological groups. Vertically, we have a short exact sequence of short exact sequences. Remarkable though is that the vertical sequences on the left and on the right fail to be short exact.

Exercises

1.10.7 Exercise **Non-pointwise mystery in short exact sequence of short exact sequences - ANK**
 For a short exact sequence of short exact sequences in a pointed category

$$\begin{array}{ccccc}
 M & \xrightarrow{a} & L & \xrightarrow{d} & I \\
 \downarrow u & & \downarrow v & & \downarrow w \\
 K & \xrightarrow{b} & X & \xrightarrow{e} & Q \\
 \downarrow x & & \downarrow y & & \downarrow z \\
 J & \xrightarrow{c} & R & \xrightarrow{f} & S
 \end{array}$$

decide if w is always a monomorphism, and if x is always an epimorphism.

1.11 The Normal Short 5-Lemma

Here, we collect basic properties of morphisms of short exact sequences. This development results in a version of the (Short) 5-Lemma which holds in \mathcal{Z} -exact categories.

1.11.1 Proposition **Morphism of short exact sequences: properties - \mathcal{Z} -Ex**
 In a morphism of short exact sequences assume that ξ is a normal map.

$$\begin{array}{ccccc}
 K & \xrightarrow{k} & X & \xrightarrow{q} & Q \\
 \downarrow \kappa & & \downarrow \xi & & \downarrow \rho \\
 L & \xrightarrow{l} & Y & \xrightarrow{r} & R
 \end{array}$$

Then the following hold:

- (i) If κ and ρ are epimorphisms, then ξ is a normal epimorphism.
- (ii) If κ and ρ are monomorphisms, then ξ is a normal monomorphism.

Proof (i) Augment the given morphism of short exact sequences with the cokernels

of κ , ξ , and ρ to obtain this commutative diagram:

$$\begin{array}{ccccc}
 K & \xrightarrow{k} & X & \xrightarrow{q} & Q \\
 \kappa \downarrow & & \xi \downarrow & & \rho \downarrow \\
 L & \xrightarrow{l} & Y & \xrightarrow{r} & R \\
 \downarrow & & \downarrow & & \downarrow \\
 Q(\kappa) = 0 & \xrightarrow{\quad} & Q(\xi) & \xrightarrow{s} & Q(\rho) = 0
 \end{array}$$

The bottom row happens to be short exact because (a) the map $0 \rightarrow Q(\xi)$ is a normal monomorphism, and (b) cokernels commute to the effect that

$$Q(\rho) = Q(Q(q) \rightarrow Q(r)) \cong Q(Q(\kappa) \rightarrow Q(\xi)) = Q(0)$$

Thus s is an isomorphism, implying that $Q(\xi) = 0$.

The normal map ξ is a composite $\xi = me$, where e is a normal epimorphism, and m is a normal monomorphism. With (1.5.9), we see that $Q(\xi) = Q(m) = 0$. Thus m is an isomorphism.

(ii) Coaugmenting the given morphism of short exact sequences with the kernels of κ , ξ , and ρ , we start an argument which is dual to the one given in (i), and the claim follows. \square

1.11.2 Corollary

Normal Short 5-Lemma - z-Ex

Consider a morphism of short exact sequences in which ξ is a normal map.

$$\begin{array}{ccccc}
 K & \xrightarrow{k} & X & \xrightarrow{q} & Q \\
 \kappa \downarrow & & \xi \downarrow & & \rho \downarrow \\
 L & \xrightarrow{l} & Y & \xrightarrow{r} & R
 \end{array}$$

If κ and ρ are both monic and epic, then κ , ξ , ρ are isomorphisms.

Proof With (1.11.1) we see that ξ is an isomorphism. Consequently, the epimorphism κ is also a normal monomorphism (1.5.8), and the monomorphism ρ is also a normal epimorphism (1.5.9). So, all of κ , ξ , ρ are isomorphisms. \square

1.11.3 Corollary

Normal 5-Lemma - z-Ex

Consider a morphism of exact sequences.

$$\begin{array}{ccccccccc}
 \square & \longrightarrow & \square & \longrightarrow & \square & \longrightarrow & \square & \longrightarrow & \square \\
 a \downarrow & & b \downarrow \cong & & c \downarrow & & d \downarrow \cong & & e \downarrow \\
 \square & \longrightarrow & \square & \longrightarrow & \square & \longrightarrow & \square & \longrightarrow & \square
 \end{array}$$

If c is a normal map, a is an epimorphism, e a monomorphism, and b, d isomorphisms, then c is an isomorphism.

Proof Via pushout and pullback recognition, we reduce the proof of the Normal 5-Lemma to an application of the Normal Short 5-Lemma (1.11.2). As the rows are exact we obtain normal factorizations at selected points as shown below.

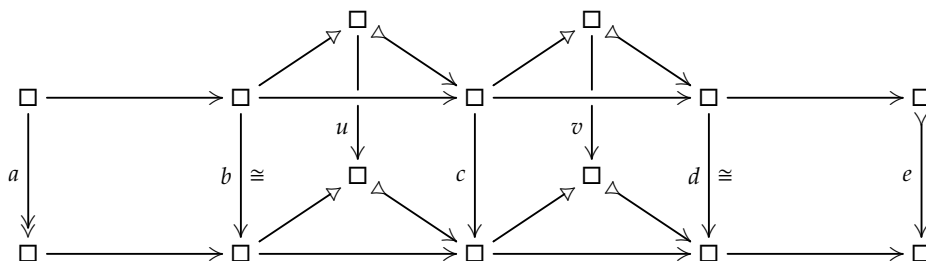

The square with vertical maps b and u is a pushout because a is an epimorphism (1.6.4), implying that u is an isomorphism. The square with vertical maps v and d is a pullback because e is a monomorphism (1.6.2), implying that v is an isomorphism. Now the Normal Short 5-Lemma (1.11.2) tells us that c is an isomorphism. \square

Comments

In the Normal Short 5-Lemma and the Normal 5-Lemma, the requirement that the vertical middle maps ξ , respectively c , be normal is very strong. We will see that both results hold in homological categories, without assuming that ξ , respectively c , are normal maps. On the other hand, the result encompasses the full Short 5-Lemma in the context of any p-exact category; in particular, we regain the result for abelian categories.

The earliest version of the Normal Short 5-Lemma we know of appears as Theorem 6.2 of [55], where it is shown to characterize subtractive categories amongst pointed regular categories. Note, however, that the structural axioms at the foundation of [55] are incompatibly different from ours. To begin, the notion of exactness is different, and as a result the nature of the Short 5-Lemma is different. In fact, the concept of short exact sequence used there is weaker than ours, and the image of the middle map ξ in the diagram is only assumed to be an ideal (i.e., a regular image of a normal monomorphism along a regular epimorphism), rather than a normal monomorphism. Hence the two versions of a Normal Short 5-Lemma are not immediately comparable.

Exercises

1.11.4 Exercise

Short 5-Lemma in Set_*

With the notation of (1.11.2), show that the primordial Short 5-Lemma holds in the category Set_* of pointed sets, without assuming that ξ be a normal map.

Chapter 2

Homology in Di-Exact Categories

We build on the preparations in the previous chapter and introduce the concept of a chain complex, along with the concept of homology as a measure of the failure of exactness of a chain complex. Actually, contrary to what happens in an abelian category, the analysis presented in Section 2.3 shows that there are two canonical measures of the failure of a chain complex to be exact in a given position. While the constructions of these two measures are dual to one another, they are *not necessarily isomorphic*.

Thus, we face two challenges: (a) determine under which conditions the two dual constructions of homology are naturally isomorphic, and (b) provide standard tools to be able to compute effectively with homological invariants; tools such as:

- ▶ The Snake Lemma;
- ▶ the (3×3) -Lemma;
- ▶ the (Short) 5-Lemma.

As explained in the introduction to this part of the work (Chapter I), whenever these tools are available in a given \mathcal{X} -exact category \mathcal{X} , they belong to the self-dual axis of \mathcal{X} . Accordingly, we look for least demanding self-dual structural axioms which ensure the validity of (a) and (b).

Perhaps surprisingly, the structural axioms we distil in Section 2.1 are all related to situations which permit the construction of a *di-extension*, that is a commutative diagram in

which every row and column is a short exact sequence:

$$\begin{array}{ccccc}
 M & \xrightarrow{a} & L & \xrightarrow{d} & \square \\
 \downarrow u & & \downarrow \kappa & & \downarrow w \\
 K & \xrightarrow{m} & X & \xrightarrow{\pi} & Q \\
 \downarrow \varepsilon & & \downarrow e & & \downarrow z \\
 \square & \xrightarrow{\mu} & R & \xrightarrow{f} & S
 \end{array}$$

For example, the two dual constructions of homology are canonically isomorphic if and only if, whenever the composite $em = 0$, then the composite $\pi\kappa$ is a normal map, which happens precisely when the diagram is a di-extension. —Indeed, in this situation the top left square is a pullback with $M = K$, and the bottom right square is a pushout with $R = S$. So, the top right corner simultaneously represents both the familiar homology of the chain complex $K \xrightarrow{m} X \xrightarrow{e} R$, as well as its dually constructed homology.

We say that a z -exact category \mathcal{X} is *homologically self-dual*, (HSD) for short, if it satisfies the condition just described. We refer to the condition itself as the (HSD)-condition¹. It turns out that the scope of the (HSD)-condition extends beyond immediate homological concerns. For example, we show in Section 2.5 that it is equivalent to the validity of the Third Isomorphism Theorem, as well as the validity of the Pure Snake Lemma.

In Sections 2.6, 2.7, and 2.8 we introduce increasingly more demanding self-dual structural axioms we ask a z -exact category to satisfy. For an outline, we refer to the diagram above.

The weakest of these axioms, discussed in Section 2.6, requires em to be a normal map if and only if $\pi\kappa$ is a normal map. This is equivalent to the validity of the border cases of the (3×3) -Lemma.

The second of these axioms, discussed in Section 2.7, is a convenient self-dual requirement which ensures that the Snake Lemma is true; see Section 2.2.

The strongest of these axioms, discussed in Section 2.8 plays a special role. It requires every antinormal map to be a normal map. This means that every composite of the kind em above admits a factorization $\mu\varepsilon$. We call this the (ANN)-condition (for ‘antinormal composites are normal’), and a z -exact category satisfying the (ANN)-condition is called *di-exact*.

¹The significance of the (HSD)-condition has already been recognized by Grandis in [42] in settings which require normal monomorphisms and normal epimorphisms to be closed under composition; there it is called the *homology axiom*.

On the one hand, the (ANN)-condition characterizes the separation between homological categories, Chapter 4, and semiabelian categories, Chapter 5. On the other, in a di-exact category, the Snake Lemma holds, the border cases of the (3×3) -Lemma hold, and a primordial version of the (Short) 5-Lemma holds. In addition, the remarkably subtle Theorem 2.4.4 holds.

We close this chapter with a discussion of normal pushouts and normal pullbacks in Section 2.9, and of higher extensions in Section 2.10. The latter results in boundary cases of higher-dimensional versions of the (3×3) -Lemma.

Leitfaden for Chapter 2

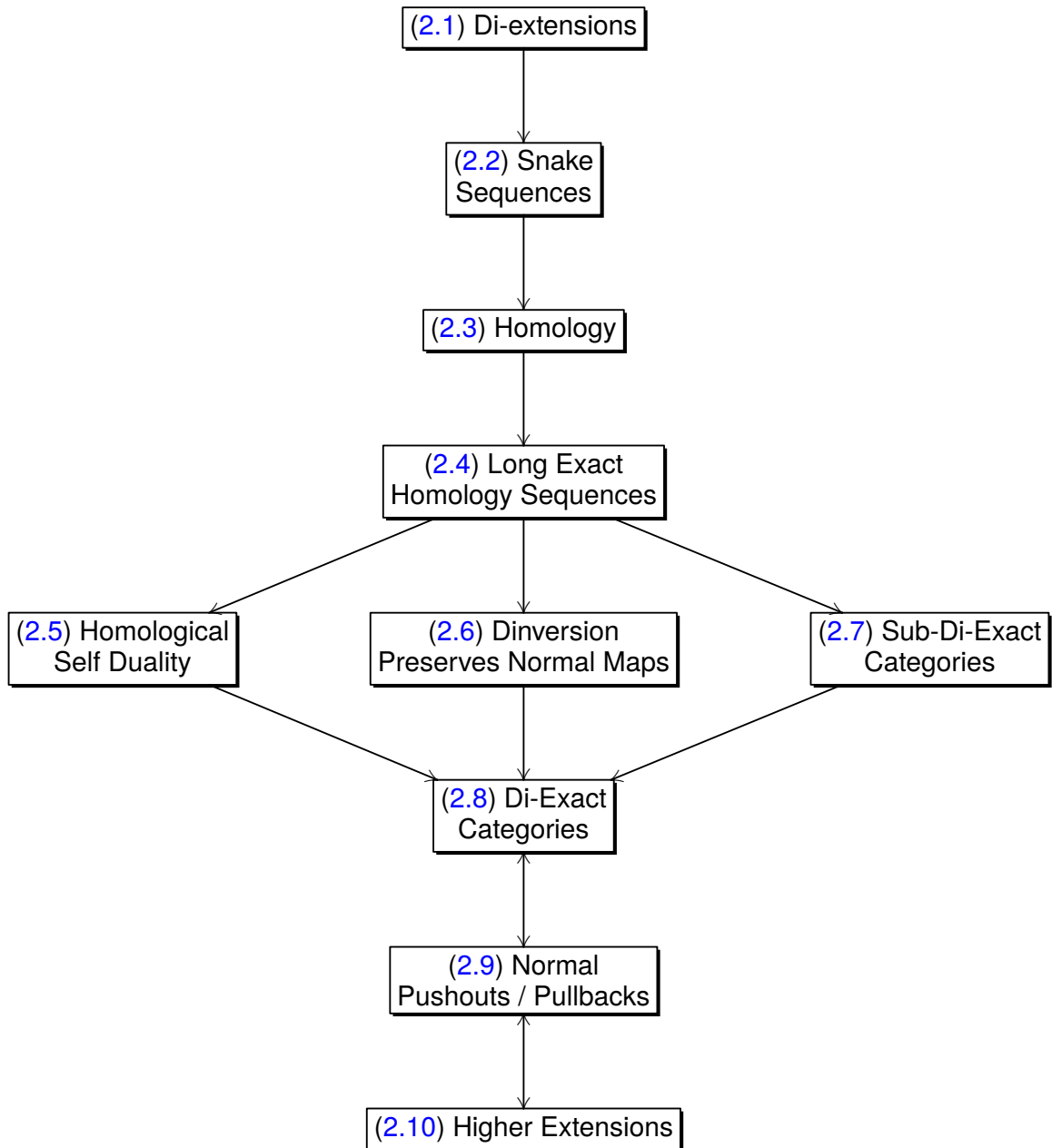

2.1 Di-Extensions

In Section 1.10, we observed in Example 1.10.6 that a short exact sequence in the category $\text{SES}(\mathcal{X})$ of short exact sequences is a (3×3) -diagram which might have a column/row which fails to be a short exact sequence in the underlying category. Here we single out a special class of short exact sequences of short exact sequences which are free of this phenomenon:

2.1.1 Definition

(3×3) -diagram / di-extension - z-Ex

In any category, a (3×3) -diagram is a commutative diagram of the form

$$\begin{array}{ccccc}
 M & \xrightarrow{a} & L & \xrightarrow{d} & I \\
 \downarrow u & & \downarrow v & & \downarrow w \\
 K & \xrightarrow{b} & X & \xrightarrow{e} & Q \\
 \downarrow x & & \downarrow y & & \downarrow z \\
 J & \xrightarrow{c} & R & \xrightarrow{f} & S
 \end{array} \tag{2.1.1}$$

In a z -exact category \mathcal{X} , such a diagram is called a *di-extension of M and over S* if each of its rows and columns is a short exact sequence in the underlying category \mathcal{X} .

We develop methods for the construction of di-extensions. Perhaps surprisingly, the conditions we encounter match exactly those conditions which a z -exact category must satisfy so that diagram lemmas, such as the Snake Lemma, familiar from homological algebra hold. Here is an outline. If (2.1.1) is a di-extension, then the square $K \rightrightarrows R$ provides the normal decomposition cx of the map $K \rightarrow R$. This map is also antinormally decomposed as yb , i.e., a normal monomorphism followed by a normal epimorphism. - The same kind of structure is associated to the square $L \rightrightarrows Q$.

We will see that every di-extension centered upon X can be constructed from a suitable antinormal pair (y, b) , or equivalently, the antinormal pair (e, v) . In fact, in a di-extension the antinormal pairs (y, b) and (e, v) determine each other, up to isomorphism, through diversion (= di-inversion), that is the normal subobject / quotient inversion (1.5.3) applied to y and b , respectively e and v .

2.1.2 Definition

Antinormal (de)composition - z-Ex

A composition of morphisms $\varepsilon\mu$ is called *antinormal* if μ is a normal monomorphism, and ε is a normal epimorphism. An *antinormal decomposition* of a given morphism f is given

by an identity $f = \varepsilon\mu$, where $\varepsilon\mu$ is an antinormal composition. A morphism is said to be *antinormal* if it admits an antinormal decomposition.

Let us clarify: A normal map f has an essentially unique factorization $f = me$, with e a normal epimorphism and m a normal monomorphism. On the other hand, antinormal decompositions, if they exist, need not be unique. For example, every object X yields an antinormal decomposition $0 \triangleright X \rightarrow 0$ of the zero map. Thus, being normal is a property which a given morphism might or might not have. However, an antinormal decomposition of $f = \varepsilon\mu$ is a choice of additional structure associated with f ; whether or not f admits such a decomposition is indeed a property of f , but many such decompositions may exist for this morphism. In response, we refer to a pair (ε, μ) consisting of a normal epimorphism ε and a normal monomorphism μ as an antinormal pair. By design, it provides an antinormal decomposition of $f := \varepsilon\mu$.

We will frequently encounter an antinormal pair whose components compose to a normal map f . So, we spell out explicitly how f may be factored as a normal map.

2.1.3 Lemma Factoring an normal map via an antinormal decomposition - z-Ex

If an antinormal decomposition of f is given by $X \xrightarrow{\mu} S \xrightarrow{\varepsilon} Y$, then the following are equivalent.

- (I) $f = me$ is a normal factorization of f .
- (II) f is a normal map, and $e = \text{coker}(\bar{k})$, where \bar{k} comes from the pullback of μ along $k := \text{ker}(\varepsilon)$ on the left below.

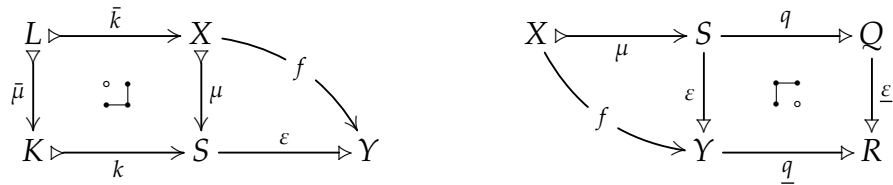

- (III) f is a normal map, and $m = \text{ker}(\underline{q})$, where \underline{q} comes from the pushout of ε along $q := \text{coker}(\mu)$ on the right above.

Proof (I) \Leftrightarrow (II) We know that f is a normal map if and only if it admits a factorization $f = me$ with m a normal monomorphism and e a normal epimorphism. In this situation m is uniquely determined by factoring f through $e := \text{coker}(\text{ker}(f))$. This latter map is the pullback of $\text{ker}(\varepsilon)$ along μ ; i.e., it is the map \bar{k} in the pullback diagram under (II), which is in fact just the kernel of f . - The equivalence of (I) and (III) follows by dual reasoning. \square

Every antinormal pair (ε, μ) provides initial data for a double extension via the following construction:

1. Construct the inverse antinormal pair (π, κ) of (ε, μ) by taking $\pi := \text{coker}(\mu)$ and $\kappa := \text{ker}(\varepsilon)$
2. Construct M as the pullback as indicated (1.5.4). Then the maps a and u are normal monomorphisms and, with $\omega := \pi\kappa$, $a = \text{ker}(\omega)$, and $u = \text{ker}(\alpha)$.
3. Construct S as the pushout as indicated (1.5.4). Then the maps f and z are normal epimorphisms and, with $\alpha := \varepsilon\mu$, $f = \text{coker}(\alpha)$, and $z = \text{coker}(\omega)$.

$$\begin{array}{ccccc}
 M & \xrightarrow{a} & L & \xrightarrow{\quad d \quad} & \square \\
 \downarrow u & & \downarrow \kappa & \searrow \omega & \downarrow w \\
 K & \xrightarrow{\mu} & X & \xrightarrow{\pi} & Q \\
 \downarrow x & & \downarrow \varepsilon & \searrow \alpha & \downarrow z \\
 \square & \xrightarrow{\quad c \quad} & R & \xrightarrow{f} & S
 \end{array}
 \tag{2.1.4}$$

By design, the maps α and ω come with antinormal decompositions $\alpha := \varepsilon\mu$ and $\omega := \pi\kappa$. We are left with the question if $d := \text{coker}(a)$ and $w := \text{ker}(z)$ form the normal factorization of ω , and if $x := \text{coker}(u)$ and $c := \text{ker}(f)$ form the normal factorization of α . - The following lemma confirms that Diagram 2.1.4 admits an expansion to a di-extension if and only if both, α and β are normal maps.

2.1.5 Lemma

Di-extension from antinormal pair - z-Ex

Diagram 2.1.4 admits an expansion to a di-extension if and only if α and ω are normal maps.

Proof If the maps α and ω are normal, then (2.1.3) tells us that their normal factorizations are constructed as

$$d := \text{coker}(a), \quad w := \text{ker}(z), \quad x := \text{coker}(u), \quad c := \text{ker}(f)$$

Thus all rows and columns of the resulting (3×3) -diagram are short exact sequences; i.e., we obtain a di-extension.

Conversely, if (ε, μ) together with its antinormal inversion (π, κ) expand to a di-extension, then this di-extension provides normal factorizations of α and ω . \square

In general, if a map f admits an antinormal decomposition $f = \varepsilon\mu$, then f need not be a normal map. So, in general, it makes no sense to ask for a functorial construction from antinormal pairs to di-extensions. However:

2.1.6 Lemma

Map of di-extensions from map of antinormal pairs - z-Ex

Using the notation (2.1.4), suppose the di-extensions (E1) and (E2) contain the antinormal pairs (ε, μ) and (ε', μ') in their bottom left corners. Then every morphism $(\alpha, \beta, \gamma): (\varepsilon, \mu) \rightarrow (\varepsilon', \mu')$ of antinormal pairs is the unique restriction of a morphism $(E1) \rightarrow (E2)$ of di-extensions.

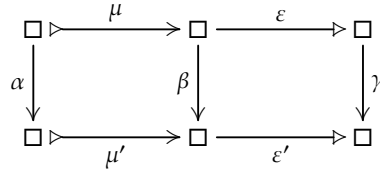

Based on (2.1.5), we single out several settings in which an antinormal pair (ε, μ) yields a double extension.

2.1.7 Corollary

Di-extension from antinormal pair - z-Ex

Let \mathcal{X} be a z-exact category in which every antinormal map is a normal map. Then every antinormal pair yields a di-extension. \diamond

2.1.8 Definition

Di-exact category - z-Ex

Of a z-exact category \mathcal{X} , we say that it satisfies the (ANN)-condition if every antinormal map is normal. If so, we call \mathcal{X} *di-exact*.

In other words, a category \mathcal{X} is di-exact if and only if the following axioms hold.

1. \mathcal{X} has a zero object; see (1.2.1).
2. Any morphism in \mathcal{X} has a (functorially chosen) kernel and a cokernel; see (1.4).
3. (ANN): Every antinormal map is normal; whenever a morphism factors as a normal monomorphism μ followed by a normal epimorphism e

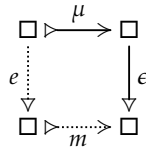

it may be written as a composite of a normal epimorphism e followed by a monomorphism m .

We use the label 'DEx' to identify a di-exact category.

Less demanding is the condition that dinversion preserves normal maps. This means that, dinversion applied to antinormal pair which happens to compose to a normal map yields

an antinormal pair which composes to a normal map. With the notation of Diagram (2.1.4), this means that α is a normal map if and only if ω is a normal map. We use the acronym (DPN) for this condition, and we use the label 'DPN' to identify z-exact categories which satisfy the (DPN)-condition.

2.1.9 Corollary

Di-extension from normal antinormal pair - DPN

Let \mathcal{X} be a z-exact category in which dinversion preserves normal maps. Then every antinormal pair (ε, μ) with normal composite $\alpha := \varepsilon\mu$ provides initial data for a di-extension. \diamond

Of particular interest will be antinormal pairs (ε, μ) for which $\varepsilon\mu = 0$. We say that a z-exact category is *homologically self-dual* if dinversion turns every antinormal decomposition of 0 into an antinormal pair with a normal composite. With the notation of Diagram (2.1.4), this means that whenever $\alpha = 0$ then ω is a normal map. We use the label 'HSD' to identify homologically self-dual categories.

2.1.10 Corollary

Di-extension from antinormal decomposition of 0 - HSD

In a homologically self-dual category every antinormal pair (ε, μ) with $\mu\varepsilon = 0$ provides initial data for a di-extension. \diamond

Here is a summary of the structural axioms introduced above:

2.1.11 Terminology

Di-extensive conditions

Given a z-exact category \mathcal{X} , we introduce the following conditions:

- (i) *Homological self-duality (HSD)* holds in \mathcal{X} if dinversion turns every antinormal decomposition of the zero map into an antinormal pair with normal composite. - A z-exact category in which the (HSD)-condition is satisfied is called *homologically self-dual*.
- (ii) *Dinversion preserves normal maps (DPN)* if dinversion turns every antinormal composite which is normal into an antinormal map which is normal.
- (iii) *Sub-di-exactness* \mathcal{X} is *sub-di-exact* if every (co)subnormal map in \mathcal{X} which admits an antinormal decomposition is normal, and dinversion preserves normal antinormal maps.
- (iv) *Every antinormal composite is a normal map (ANN)* - A z-exact category in which the (ANN)-condition is satisfied is called *di-exact*. - DEx
- (v) *All maps are normal*.

Evidently, we have (v) \Rightarrow (iv) \Rightarrow (iii) \Rightarrow (ii) \Rightarrow (i). - In Table 2.1 we graphically summarize the kinds of di-extensions which are associated to the types of antinormal pairs we

discussed.

	$\square \xrightarrow{\mu} \square \xrightarrow{\varepsilon} \square$ is short exact - z-Ex		$\varepsilon\mu = 1$ - DPN
	$\varepsilon\mu = 0$ - HSD, variant 1		$\varepsilon\mu = 0$ - HSD, variant 2
	$\varepsilon\mu \neq 0, 1$ and $\varepsilon\mu$ normal - DPN		$\varepsilon\mu \neq 0, 1$ - DEx

Table 2.1: Di-extension types

Next, we clarify the relationship between the category $\text{ANP}(\mathcal{X})$ of antinormal pairs in a z-exact category \mathcal{X} and the category $\text{DEx}(\mathcal{X})$ of di-extensions in \mathcal{X} . To this end, let $\varphi: [2] \rightarrow [2]^2$ be the functor with the following description:

$$\begin{array}{ccc}
 [0 \xrightarrow{a_0} 1 \xrightarrow{a_1} 2] & \xrightarrow{\varphi} & \begin{array}{ccccc}
 (0, 0) & \longrightarrow & (1, 0) & \longrightarrow & (2, 0) \\
 \downarrow & & \downarrow & & \downarrow \\
 (0, 1) & \xrightarrow{\varphi(a_0):=a_0 \times 1_1} & (1, 1) & \longrightarrow & (2, 1) \\
 \downarrow & & \downarrow \varphi(a_1):=1_1 \times a_1 & & \downarrow \\
 (0, 2) & \longrightarrow & (1, 2) & \longrightarrow & (2, 2)
 \end{array}
 \end{array}$$

Thus, if $X: [2]^2 \rightarrow \mathcal{X}$ is a di-extension then, using the notation from (2.1.4), $X\varphi$ is the antinormal diagram $\alpha = K \xrightarrow{\mu} X \xrightarrow{\varepsilon} R$.

2.1.13 Proposition

φ^* is equivalence of categories - **DEx**

The functor $\varphi^*: \text{DEx}(\mathcal{X}) \rightarrow \text{ANP}(\mathcal{X})$ is an equivalence of categories. Using the notation

from (2.1.4), a pseudo-inverse $\psi: \text{ANP}(\mathcal{X}) \rightarrow \text{DEx}(\mathcal{X})$ comes from applying this sequence of functorial constructions to a given antinormal pair (ε, μ) :

1. Form the antinormal inverse ($\pi := \text{coker}(\mu), \kappa := K(\varepsilon)$).
2. Form the pullback of μ and κ to obtain the top left square of (2.1.4).
3. Form the pushout of ε and π to obtain the bottom right square of (2.1.4).
4. Form the normal factorization $\alpha = cx$ by putting $x := \text{coker}(u)$. Then α factors uniquely and functorially through x via the normal monomorphism c .
5. Form the normal factorization $\omega = wd$ by putting $w := K(z)$. Then ω factors uniquely and functorially through w via the normal epimorphism d .

Proof The proposed construction yields a di-extension by (2.1.5). The construction is functorial by (2.1.6). \square

To compute (co)limits in $\text{DEx}(\mathcal{X})$, we first clarify how to compute (co)limits in $\text{ANP}(\mathcal{X})$.

2.1.14 Proposition

(Co)limits in $\text{ANP}(\mathcal{X})$ - z-Ex

The colimit of J -diagram $F: J \rightarrow \text{ANP}(\mathcal{X})$ may be computed as

$$\text{colim}(F) = \left(\square \xrightarrow{\ker\left(\text{colim}\left(\text{coker} \circ F|_{[0 \xrightarrow{a_1} 1]}\right)\right)} \text{colim}(F|1) \xrightarrow{\text{colim}(F|a_1)} \text{colim}(F|2) \right)$$

The limit of F may be computed as

$$\text{lim}(F) = \left(\text{lim}(F|0) \xrightarrow{\text{lim}(F|a_0)} \text{lim}(F|1) \xrightarrow{\text{coker}\left(\text{lim}\left(\ker \circ F|_{[1 \xrightarrow{a_1} 2]}\right)\right)} \square \right)$$

Hence $\text{ANP}(\mathcal{X})$ has all (co)limits \mathcal{X} has. In particular, if \mathcal{X} is z-exact, then so is $\text{ANP}(\mathcal{X})$.

Proof Let us consider the proposed computation of colimits in $\text{ANP}(\mathcal{X})$. It is the computation of the colimit in $\text{NM}(\mathcal{X})$ of the underlying J -diagram of normal monomorphisms, composed with the computation of the colimit in $\text{NE}(\mathcal{X})$ of the underlying diagram of normal epimorphisms. We only need to observe that these two colimits yield composable morphisms in \mathcal{X} . Indeed, the codomain of the colimit in $\text{NM}(\mathcal{X})$ is $\text{colim}(F|1)$, which is exactly the same as the domain of the colimit in $\text{NE}(\mathcal{X})$.

Dual reasoning yields the limit computation of F . \square

2.1.15 Corollary

$\text{DEx}(\mathcal{X})$ is a z-exact category - DEx

The category $\text{DEx}(\mathcal{X})$ associated to a di-exact category \mathcal{X} is a z-exact category.

Proof We only need to show that the category $\text{DEx}(\mathcal{X})$ has kernels and cokernels. From (2.1.13) we know that $\text{DEx}(\mathcal{X})$ is equivalent to $\text{ANP}(\mathcal{X})$. In (2.1.14), we reduce the computation of (co)kernels in $\text{ANP}(\mathcal{X})$ to the computation of (co)kernels in $\text{NM}(\mathcal{X})$ and in $\text{NE}(\mathcal{X})$, and these are computed in (1.8.16). So, the claim follows. \square

We observe that the requirement that antinormal maps be normal is equivalent to the following condition.

2.1.16 Definition **Normal image preservation of normal maps - z-Ex**

In a z -exact category *normal images preserve normal maps* if, for every morphism of normal factorizations in which f and g are normal maps, the map g is normal as well.

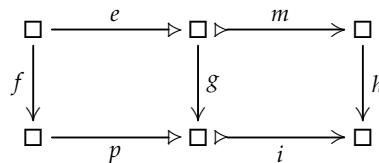

Keeping in mind that the map g in (2.1.16) is uniquely determined by the remaining maps, we conclude that, in a category where normal images preserve normal maps, every commutative square of normal maps, as on the left below, has normal factorizations which form the commutative diagram on the right below.

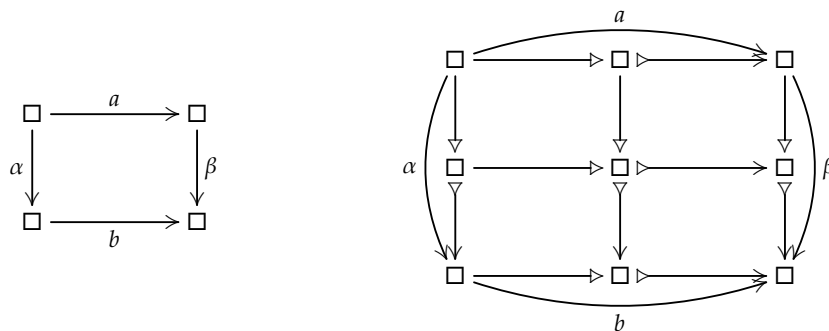

2.1.17 Proposition **Antinormal composites and normal images - z-Ex**

In a z -exact category, the following conditions are equivalent:

- (I) Antinormal composites are normal maps.
- (II) Normal images preserve normal maps.

Proof (II) \Rightarrow (I) Suppose g admits a factorization $g = \mu\varepsilon$, where ε is a normal epimorphism, and μ is a normal monomorphism. Then take $f := m := \mu$, $p := h := \varepsilon$, and e and i identities. Now (II) implies that g is normal.

(I) \Rightarrow (II) For the converse, in the diagram on the left, we use the normal factorizations $f = f_2f_1$ and $h = h_2h_1$, along with the decomposition $g = g_2\dot{g}g_1$ from (1.8.4).

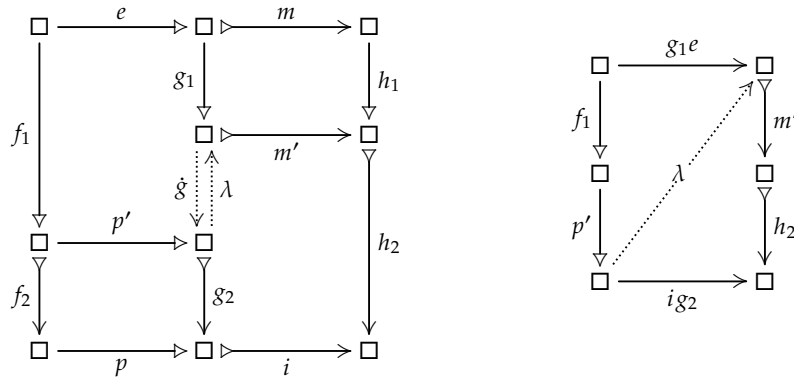

We claim that \dot{g} has an inverse given by the map λ which comes from the orthogonality between the strong epimorphism $p'f$ and the monomorphism h_2m' . This follows from the computations

$$\begin{aligned} h_2m'\lambda\dot{g}g_1e &= ig_2\dot{g}g_1e = h_2m'g_1e && \Rightarrow \lambda\dot{g} = 1 \\ ig_2\dot{g}\lambda p'f_1 &= ig_2\dot{g}g_1e = ig_2p'f_1 && \Rightarrow \dot{g}\lambda = 1 \end{aligned}$$

This implies that g is a normal map, and the proof that (I) \Leftrightarrow (II) is complete. \square

Notes

On di-exact categories Of a di-exact category, (2.1.11.iv), we ask that every map which admits an antinormal decomposition be normal. It plays a special role in what follows for the following reasons. We will introduce homological categories and semiabelian categories. To, the set of structural axioms characterizing homological categories, we only need to add one more axiom to characterize semiabelian categories, namely (2.1.11.iv). Condition (v) is stronger and holds, for instance, for abelian categories.

It is, therefore quite surprising that in di-exact categories most of the basic tool set is available so that effective computations with homology can be carried out. Some of these tools are even available under significantly weaker conditions. So, while we uniformly adopt di-exact categories as a working environment, we will point out where results hold under any of the weaker assumptions listed in (2.1.11). This broadens the scope of those results, in particular toward the inclusion of certain topological varieties. We will discuss this in detail.

On homological self-duality At first, this condition may look quite specialized. However, we see in Section 2.5 that its scope is surprisingly diverse. The terminology is motivated by the fact that, in a homologically self-dual category two dual, but a priori different constructions of ‘homology’ are naturally equivalent; see the Notes in Section 2.3.

On the dinversion of antinormal pairs Associated to a \mathcal{Z} -exact category \mathcal{X} is the category $\text{ANP}(\mathcal{X})$ of antinormal pairs (ε, μ) . With functorial kernels and cokernels, ‘dinversion’ is a functor

$$B: \text{ANP}(\mathcal{X}) \longrightarrow \text{ANP}(\mathcal{X})$$

which is its own inverse up to unique equivalence. The up-to-equivalence fixed points of B are antinormal pairs which concatenate to short exact sequences.

Exercises

2.1.18 Exercise

Constructing di-extensions - $\mathcal{Z}\text{-Ex}$

Show that each of the following yields a double extension.

- (i) Extending the kernel pair of a normal monomorphism or the cokernel pair of a normal epimorphism yields a di-extension with 0’s in the antidiagonal corners.
- (ii) Extending a bicartesian square of normal monomorphisms yields a di-extension with a 0 in the bottom right corner.
- (iii) Extending a bicartesian square of normal epimorphisms yields a di-extension with a 0 in the top left corner.
- (iv) Extending a bicartesian square in the top right whose edges are normal monomorphisms, respectively normal epimorphisms, as shown on the left below, yields a di-extension with a 0 in the bottom left corner.



- (v) Extending a bicartesian square in the bottom left whose edges are normal monomorphisms, respectively normal epimorphisms, as shown on the right above yields a di-extension with a 0 in the top right corner.

2.1.19 Exercise

Dinversion in Set_*

Show that, in the category Set_* of pointed sets, dinversion preserves normal maps.

2.1.20 Exercise

Antinormal pairs with prescribed properties for $\varepsilon\mu$ - $\mathcal{Z}\text{-Ex}$

In a \mathcal{Z} -exact category \mathcal{X} , let (ε, μ) be an antinormal pair. Using the notation of (2.1.4) prove the following:

- (i) If $\varepsilon\mu$ is a normal monomorphism which turns into a normal map under antinormal inversion, then the map $K(\varepsilon) \rightarrow Q(\mu)$ is a normal monomorphism as well, and the resulting di-extension has a 0 in the top left corner.

- (ii) If $\varepsilon\mu$ is a normal epimorphism which turns into a normal map under antinormal inversion, then the map $K(\varepsilon) \rightarrow Q(\mu)$ is a normal epimorphism as well, and the resulting di-extension has a 0 in the bottom right corner.
- (iii) If $\varepsilon\mu$ is an isomorphism which turns into a normal map under antinormal inversion, then the map $K(\varepsilon) \rightarrow Q(\mu)$ is an isomorphism as well, and the resulting di-extension has a 0 in the top left and the bottom right corners.
- (iv) Decide whether there are pointed categories in which an antinormal pair (ε, μ) , with $\varepsilon\mu = 1$, need not yield a double extension. - ANK

2.1.21 Exercise

Diversion of isomorphisms - ANK

For a z -exact category, determine the significance of the condition that diversion turns every isomorphism into an isomorphism. (Compare with (4.2.9) and the condition that diversion preserves all normal maps).

2.1.22 Exercise

Di-extensions in Mnd and Mag - ANK

In each of the categories Mag of unital magmas or Mnd of monoids decide if every short exact sequence of short exact sequences is a di-extension.

2.1.23 Exercise

Pushout of normal epimorphisms - ANK

In a z -exact category, consider the morphism of short exact sequences below.

$$\begin{array}{ccccc}
 M & \twoheadrightarrow & X & \twoheadrightarrow & Q \\
 m \downarrow & & \downarrow & (R) & \downarrow \\
 N & \twoheadrightarrow & Y & \twoheadrightarrow & R
 \end{array}$$

Assume that all maps in square (R) are normal epimorphisms, and that (R) is a pushout. Is the map m on the left always an epimorphism? - Also formulate the dual of this question, and try to answer it.

2.1.24 Exercise

Antinormal inversion in (topological) varieties - ANK

For a variety of algebras \mathcal{V} and the associated topological variety $\bar{\mathcal{V}}$ do the following:

- (i) If $\bar{\mathcal{V}}$ satisfies any of the conditions in (2.1.11) show that so does \mathcal{V} .
- (ii) Determine those varieties of algebras in which diversion preserves normal maps for which diversion in $\bar{\mathcal{V}}$ also preserves normal maps.
- (iii) Determine those di-exact varieties for which $\bar{\mathcal{V}}$ is di-exact as well.

2.1.25 Exercise

Antinormal inversion in varieties - ANK

Determine in which z -exact varieties diversion preserves normal maps.

2.1.26 Exercise

Special cases of (3×3) normal factorizations of normal maps - DEx

Given the commutative square below, show the following:

$$\begin{array}{ccc}
 \square & \xrightarrow{a} & \square \\
 \alpha \downarrow & & \downarrow \beta \\
 \square & \xrightarrow{\quad} & \square
 \end{array}$$

81

- (i) Suppose a and b are normal epimorphisms. If α is a normal map, then β is a normal map.
- (ii) Suppose a and b are normal monomorphisms. If β is a normal map, then α is a normal map.

Given a map f in a pointed category, it is not at all clear whether it admits an antinormal decomposition or not. The next exercises provide constructions of an antinormal decomposition in special cases.

2.1.27 Exercise

Maps in Ab are antinormal

Show that every morphism in the category Ab of abelian groups (more generally: in an abelian category) admits antinormal decompositions.

2.1.28 Exercise

Precrossed module admits antinormal decomposition - Grp

A *precrossed module (of groups)* is a group homomorphism $\partial: T \rightarrow G$, called the *boundary map*, together with a left group action $\alpha: G \times T \rightarrow T$ of G on T ; $g.t := \alpha(g, t)$ such that

$$\partial(g.t) = g\partial(t)g^{-1}$$

This condition says that ∂ is equivariant with respect to α and the conjugation action γ of G on itself.

- (i) The map ∂ of a precrossed module condition is a normal map.
- (ii) The map $\mu: G \rtimes_{\gamma} G \rightarrow G$, $\mu(x, g) := xg$ is a group homomorphism.
- (iii) An antinormal decomposition of ∂ is given by the commutative diagram

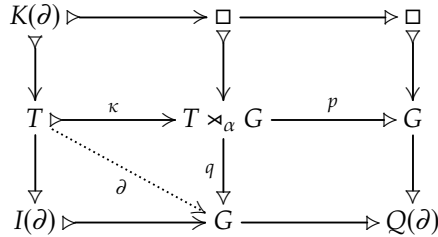

in which $\kappa(t) := (t, 1)$, $q := \mu \circ (\partial \rtimes 1_G)$, and $p(t, g) := g$.

- (iv) Show that a section of q is given by $s: G \rightarrow T \rtimes_{\alpha} G$.
- (v) Show that, as a sectioned decomposition, $q\kappa$ is initial among all antinormal decompositions $\partial = rk$ for which r admits a section, say σ .

2.1.29 Exercise

Are normal maps antinormal? - ANK

Determine if there is a pointed category in which there exists a normal map which does not admit an antinormal decomposition. If such a category exists, develop sufficient conditions to identify pointed categories in which every normal map admits an antinormal decomposition.

2.2 Snake Sequences

We show that various versions of the Snake Lemma hold in di-exact categories; see (2.1.11). We begin with the Pure Snake Lemma and use it as a stepping stone to prove the Classical Snake Lemma and variations thereof.

2.2.1 Lemma

Pure Snake Lemma - DEx

Consider this morphism of short exact sequences:

$$\begin{array}{ccccc}
 K & \xrightarrow{\kappa} & X & \xrightarrow{\xi} & Q \\
 a \downarrow & & \parallel & & \downarrow \rho \\
 L & \xrightarrow{\xi} & X & \xrightarrow{\eta} & R
 \end{array} \tag{2.2.1}$$

Then κ is a normal monomorphism, and ρ is a normal epimorphism. Moreover, the normal factorization of the antinormal composite $t := ql$ yields the exact sequence below.

$$\begin{array}{ccccccc}
 0 & \longrightarrow & A & \xrightarrow{k} & X & \xrightarrow{\beta\xi} & Q & \xrightarrow{\rho} & R & \longrightarrow & 0 \\
 & & & & \downarrow & & \uparrow & & & & \\
 & & & & Q(\kappa) & \xrightarrow[\cong]{\partial^{-1}} & K(\rho) & & & &
 \end{array}$$

This sequence is functorial with respect to morphisms of diagrams of the form (2.2.1).

Proof That κ and ρ are normal monomorphism and normal epimorphism, respectively, follows via commutativity and (1.5.8), (1.5.9). Next, consider the following rearrangement of the information from the given morphism of short exact sequences:

$$\begin{array}{ccccc}
 A & \xrightarrow{\kappa} & X & \xrightarrow{\tilde{q}} & K(\rho) \\
 \parallel & & \downarrow l & \searrow t & \downarrow \mu \\
 A & \xrightarrow{k} & B & \xrightarrow{q} & C \\
 \downarrow & & \downarrow r & & \downarrow \rho \\
 0 & \longrightarrow & R & \xlongequal{\quad} & R
 \end{array}$$

In a homologically self-dual category, the antinormally decomposed map $t = ql$ has the normal factorization presented on the top right; see (2.1). This proves the claim. Functoriality follows from the uniqueness property of the normal factorization of t . \square

Repeated use of the Pure Snake Lemma yields the Classical Snake Lemma. It plays a pivotal role in homological algebra.

2.2.2 Theorem

Classical Snake Lemma - DEx

Suppose the maps κ, ξ, ρ in the following morphism of short exact sequences are normal.

$$\begin{array}{ccccc} K & \xrightarrow{k} & X & \xrightarrow{q} & Q \\ \kappa \downarrow & & \xi \downarrow & & \downarrow \rho \\ L & \xrightarrow{l} & Y & \xrightarrow{r} & R \end{array}$$

Then the kernels and cokernels of κ, ξ, ρ form a six-term exact sequence

$$0 \longrightarrow K(\kappa) \xrightarrow{k^*} K(\xi) \xrightarrow{q^*} K(\rho) \xrightarrow{\partial} Q(\kappa) \xrightarrow{l_*} Q(\xi) \xrightarrow{r_*} Q(\rho) \longrightarrow 0$$

The six-term exact sequence depends functorially on morphisms of the underlying diagrams of short exact sequences.

Proof Compare [9, p. 47f][10, p. 297f]. We reduce the proof of the classical Snake Lemma to three applications of the Pure Snake Lemma.

Step 1: Comparison with the extension of kernels In the commutative diagram below, via (2.1.3), the composite $K \rightarrow I(\kappa) \rightarrow I(\xi)$ is the normal factorization of the antinormal composite $K \rightarrow X \rightarrow I(\xi)$. By (2.1.7), we obtain a di-extension of $K(\kappa)$ over S .

$$\begin{array}{ccccccc} & & & & q^* & & \\ & & & & \curvearrowright & & \\ K(\kappa) & \xrightarrow{k^*} & K(\xi) & \xrightarrow{\quad} & J & \xrightarrow{\quad} & K(\rho) \longrightarrow Q(q^*) \\ \downarrow & \circlearrowleft & \downarrow & & \downarrow & & \downarrow \\ K & \xrightarrow{\alpha} & X & \xrightarrow{q} & Q & \xrightarrow{\quad} & Q \\ \downarrow \kappa & \searrow & \downarrow \xi & \searrow & \downarrow \rho & \searrow & \downarrow \rho \\ & I(\kappa) & \xrightarrow{\quad} & I(\xi) & \xrightarrow{\quad} & S & \xrightarrow{\tau} & I(\rho) \\ & \swarrow & \downarrow & \swarrow & \downarrow & \swarrow \mu & \downarrow & \swarrow \\ L & \xrightarrow{\quad} & Y & \xrightarrow{\quad} & R & \xrightarrow{\quad} & R \\ \downarrow & & \downarrow & & \downarrow & & \downarrow \\ Q(\kappa) & \xrightarrow{l_*} & Q(\xi) & \xrightarrow{r_*} & Q(\rho) & \xrightarrow{\quad} & Q(\rho) \end{array}$$

Working with the universal properties of the kernels and cokernels, combined with their monomorphic and epimorphic properties, shows that the supplemented maps exist and

are unique rendering the entire diagram commutative. So, q^* is a normal map, and the Pure Snake Lemma yields a functorial isomorphism $Q(q^*) \rightarrow K(\tau)$.

Step 2: Comparison with the extension of cokernels The dual construction yields a di-extension of T over $Q(\rho)$.

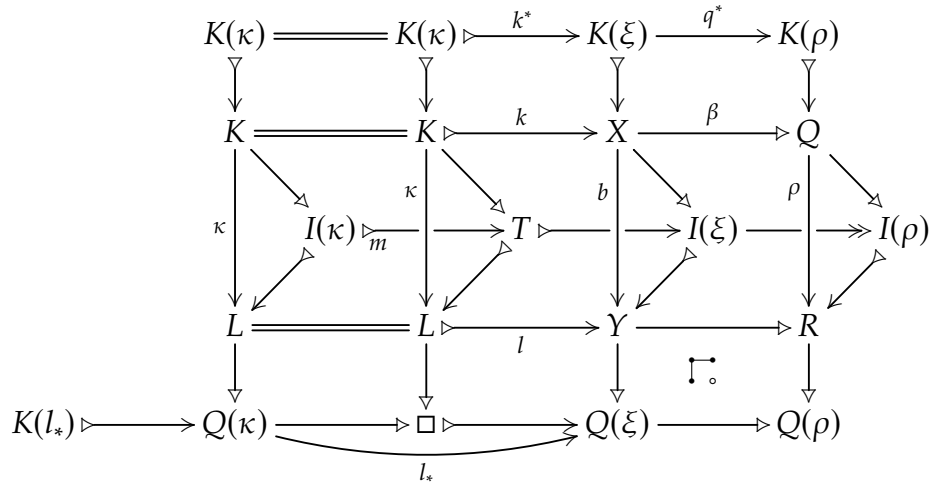

Working with the universal properties of the kernels and cokernels shows that the supplemented maps exist and are unique rendering the entire diagram commutative (the pullback property of the square with corners T and Y is essential here). The Pure Snake Lemma yields a functorial isomorphism $K(l_*) \rightarrow Q(m)$.

Step 3: Connecting steps 1 and 2 From steps 1 and 2, we obtain the diagram of short exact sequences below.

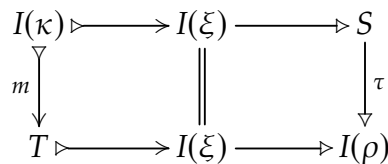

Combining the epimorphic property of the cokernel $K \rightarrow I(\kappa)$ with the monomorphic property of the kernel $I(\xi) \rightarrow Y$, we see that the left hand square commutes. Dually, combining the epimorphic property of the cokernel $B \rightarrow I(b)$ with the monomorphic property of the kernel $I(\rho) \rightarrow R$, we see that the right hand square commutes. The Pure Snake Lemma yields a functorial isomorphism $K(\tau) \rightarrow Q(m)$.

Step 4: Assembly The functorial isomorphisms we found in steps 1, 2, 3, may be composed

as in the diagram below to yield the desired isomorphism ∂ :

$$\begin{array}{ccc}
 Q(q^*) & \xrightarrow[\cong]{\partial} & K(\xi_*) \\
 \text{Step 1 } \cong \downarrow & & \cong \uparrow \text{Step 2} \\
 K(\tau) & \xrightarrow[\text{Step 3 } \cong]{} & Q(m)
 \end{array}$$

The arguments given are functorial with respect to morphisms of diagrams, as in the statement of the Classical Snake Lemma. So, its proof is complete.

To extend the scope of the Snake Lemma, we explain how the argument given above can be refined so that the hypotheses can be weakened to: “(co)subnormal maps in \mathcal{X} which admit an antinormal decomposition are normal”, combined with the assumption that diversion preserves normal maps in \mathcal{X} ; see (2.1.11). This refinement affects step 1 and, by duality, step 2. Here is an excerpt of the relevant part of the diagram used in step 1.

$$\begin{array}{ccc}
 K(\kappa) \triangleright \xrightarrow{k^*} K(\xi) & & \\
 \downarrow \triangleright & \circlearrowleft \downarrow & \downarrow \triangleright \\
 K \triangleright \xrightarrow{k} X & & \\
 \downarrow \triangleright & \circlearrowleft \downarrow & \downarrow \triangleright \\
 I(\kappa) \triangleright \xrightarrow{\quad} I(\xi) & & \\
 \downarrow \triangleright \gamma & & \downarrow \triangleright \\
 P \triangleright \xrightarrow{\quad} I(\xi) & & \\
 \downarrow \triangleright & \circlearrowleft \downarrow & \downarrow \triangleright \\
 L \triangleright \xrightarrow{\quad} Y & & \\
 \downarrow \triangleright & & \downarrow \triangleright
 \end{array}$$

In the above diagram we used (1.5.4) to insert the pullback of $L \triangleright Y$ along $I(\xi) \triangleright Y$ into the square $I(\kappa) \rightrightarrows Y$. The comparison map γ is a normal monomorphism by (1.5.8). Thus we have a factorization of the antinormal composite $K \triangleright X \rightarrow I(\xi)$ as a subnormal map. In a sub-di-exact category, such a map is normal, and diversion turns it into a normal map. Thus, we obtain the di-extension we were working with in step 1.

Dually, in step 2, we find that the antinormal composite $I(\xi) \triangleright Y \rightarrow R$ is cosubnormal, hence normal. \square

2.2.3 Terminology

The morphism ∂ in the statement of the Classical Snake Lemma (2.2.2) is also called the *snake map/morphism* or the *connecting map/morphism*.

2.2.4 Corollary

Relaxed Snake Lemma - DEx

[9, p. 47f][10, p. 297f] Consider the commutative diagram below.

$$\begin{array}{ccccccc}
 & & K & \xrightarrow{k} & X & \xrightarrow{q} & Q & \longrightarrow & 0 \\
 & & \downarrow \kappa & & \downarrow \xi & & \downarrow \rho & & \\
 0 & \longrightarrow & L & \xrightarrow{l} & Y & \xrightarrow{r} & R & &
 \end{array}$$

Assume that the maps k, κ, ξ, ρ, r are normal, the top sequence is exact, and the bottom sequence is coexact. Then there is this functorial six-term exact sequence:

$$K(\kappa) \xrightarrow{k^*} K(\xi) \xrightarrow{q^*} K(\rho) \xrightarrow{\partial} Q(\kappa) \xrightarrow{l_*} Q(\xi) \xrightarrow{r_*} Q(\rho)$$

Proof We reduce the given situation to the Classical Snake Lemma 2.2.2:

$$\begin{array}{ccccccc}
 & & & \xrightarrow{k^*} & & \xrightarrow{q^*} & & \\
 K(\kappa) & \xrightarrow{\quad} & K(\kappa') & \xrightarrow{\quad} & K(\xi) & \xrightarrow{\quad} & K(\rho') & \xrightarrow{\cong} & K(\rho) \\
 \downarrow & \circlearrowleft & \downarrow & & \downarrow & & \downarrow & & \downarrow \\
 K & \xrightarrow{u} & K' & \xrightarrow{k'} & X & \xrightarrow{q} & Q & \xrightarrow{=} & Q \\
 \downarrow \kappa & & \downarrow \kappa' & & \downarrow b & & \downarrow \rho' & & \downarrow \rho \\
 L & \xrightarrow{=} & L & \xrightarrow{l} & Y & \xrightarrow{r'} & R' & \xrightarrow{v} & R \\
 \downarrow & & \downarrow & & \downarrow & & \downarrow & & \downarrow \\
 Q(\kappa) & \xrightarrow{\cong} & Q(\kappa') & \xrightarrow{\quad} & Q(\xi) & \xrightarrow{\quad} & Q(\rho') & \xrightarrow{x} & Q(\rho) \\
 & \xrightarrow{l_*} & & & & & & \xrightarrow{r_*} &
 \end{array}$$

The composite $k'u$ is the normal factorization of the normal map k . So, $k' = K(q)$. The universal property of the kernel l yields k' unique with $lk'u = l\kappa$. We conclude $\kappa'u = \kappa$ via the monomorphic property of l . With (1.8.12), we see that κ' is a normal map.

The composite vr' is the normal factorization of r , coming from the coexactness in position Y . Via the cokernel q we obtain ρ' , unique with $\rho'q = r'\xi$. We conclude $v\rho' = \rho$ from the epimorphic property of β . With (1.8.11), we see that ρ' is a normal map.

Thus we may apply the classical Snake Lemma to the morphism (κ', ξ, ρ') of short exact sequences, to obtain the following exact sequence:

$$0 \rightarrow K(\kappa') \rightarrow K(\xi) \rightarrow K(\rho') \xrightarrow{\partial} Q(\kappa') \xrightarrow{x} Q(\xi) \rightarrow Q(\rho') \rightarrow 0$$

Using the normal factorizations of κ and κ' we arrive at the following commutative diagram:

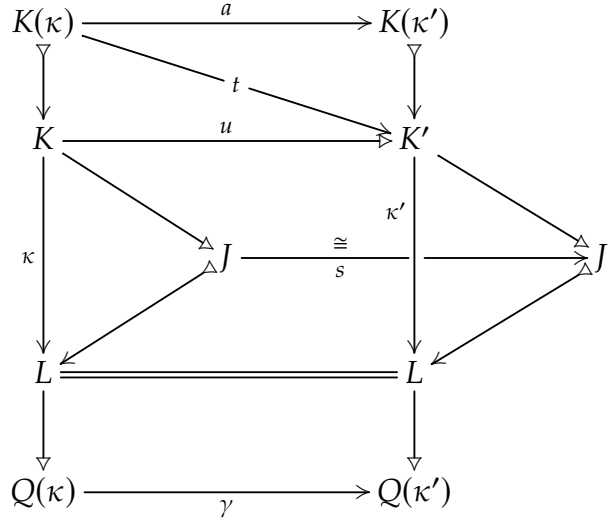

The map s is an isomorphism because it is a normal monomorphism by commutativity of the square $J \rightrightarrows L$, and it is an epimorphism by commutativity of the square $K \rightrightarrows J'$. So, the map γ is an isomorphism as well. Via the recognition criterion for homologically self-dual categories (2.5.9), a is a normal epimorphism. Thus $K(\kappa) \rightarrow K(\xi) \rightarrow K(\rho)$ is exact at $K(\xi)$, and $Q(\kappa')$ may be replaced by $Q(\kappa)$ via the isomorphism we found.

Dual argumentation completes the validation of the relaxed snake sequence. Checking that all constructions involved are functorial completes the proof. \square

For later use, we develop a number generalizations of the Pure Snake Lemma 2.2.1. We start from a commutative diagram in which the composites $\beta\alpha$ and $\eta\xi$ are 0.

$$\begin{array}{ccccc}
 A & \xrightarrow{\alpha} & B & \xrightarrow{\beta} & C \\
 \downarrow a & & \parallel & & \downarrow c \\
 X & \xrightarrow{\xi} & B & \xrightarrow{\eta} & Z
 \end{array} \tag{2.2.4}$$

We further assume that β is a normal epimorphism and ξ is a normal monomorphism.

The above diagram has the following expansion which we will refer to.

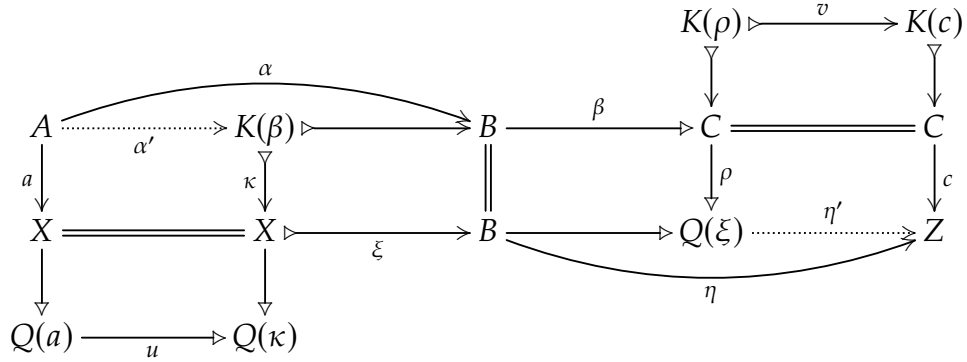

2.2.5 Corollary

Generalized pure snake I - DEx

In the setup of diagram (2.2.4), the following hold and are functorial with respect to morphisms of diagrams of type (2.2.4):

- (i) The top row in the diagram below is exact, and the map d is normal.

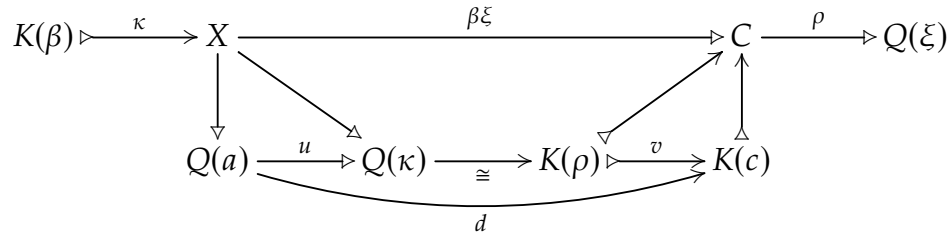

- (ii) If the top row in (2.2.4) is exact, then a is a normal map, u is an isomorphism, and d is a normal monomorphism. Moreover, the sequence below is exact.

$$K(\beta) \xrightarrow{\kappa} X \longrightarrow K(c) \longrightarrow Q(\xi) \xrightarrow{\eta'} Z$$

- (iii) If the bottom row in (2.2.4) is coexact, then c is a normal map, v is an isomorphism, and d is a normal epimorphism. Moreover, the sequence below is coexact.

$$A \xrightarrow{\alpha'} K(\beta) \longrightarrow Q(a) \longrightarrow C \xrightarrow{\rho} Q(\xi)$$

Proof Upon confirming the normal monomorphism and epimorphism properties of the maps κ and ρ , we see that the Pure Snake Lemma (2.2.1) is applicable to the morphism

$(\kappa, 1_B, \rho)$, and claim (i) follows since $Q(\kappa) \cong K(\rho)$ while u is a normal epimorphism and v a normal monomorphism.

(ii) If the top row in (2.2.4) is exact then a' is a normal epimorphism. So $a = \kappa a'$ is a normal map, and (1.6.4) the bottom left square is a pushout. It follows that u is an isomorphism and, hence, d is a normal monomorphism.

Now, we observe that we can apply (i) to the morphism $(v, 1_C, \eta')$ and splice the result into the exact sequence from (i). The result is:

$$\begin{array}{ccccccc}
 K(\beta) & \xrightarrow{\kappa} & X & \xrightarrow{\quad} & K(c) & \xrightarrow{\quad} & Q(\xi) \xrightarrow{\eta'} \rightarrow Z \\
 & & \searrow & & \swarrow & & \swarrow \\
 & & & & Q(\kappa) \cong K(\rho) & & Q(v) \cong K(\eta')
 \end{array}$$

So, the top row is exact as claimed.

(iii) The argument is dual to that of (ii). □

2.2.6 Corollary

Relaxed Pure Snake Lemma - DEx

In the setup of diagram (2.2.4), assume that the top row is exact and that the bottom row is coexact. Then a and c are normal maps, and the normal factorization of the antinormal composite $t := \beta\xi$ yields

$$\begin{array}{ccccccc}
 A & \xrightarrow{a} & X & \xrightarrow{\beta\xi} & C & \xrightarrow{c} & Z \\
 & & \downarrow & & \uparrow & & \\
 & & Q(a) & \xrightarrow[\cong]{d} & K(c) & &
 \end{array}$$

as a functorial exact and coexact sequence. ◇

2.2.7 Corollary

- DEx

In the setup of diagram (2.2.4), suppose at the following two conditions hold.

- (i) $\beta = \text{coker}(a)$ and $\xi = \text{ker}(\eta)$.
- (ii) The maps a and c are normal.

Then the sequence below is exact and coexact, and is functorial with respect to morphisms of diagrams of type (2.2.4).

$$A \xrightarrow{a'} K(\beta) \longrightarrow Q(a) \longrightarrow K(c) \longrightarrow Q(\xi) \xrightarrow{\eta'} Z$$

Proof We refine the expansion of (2.2.4) as follows.

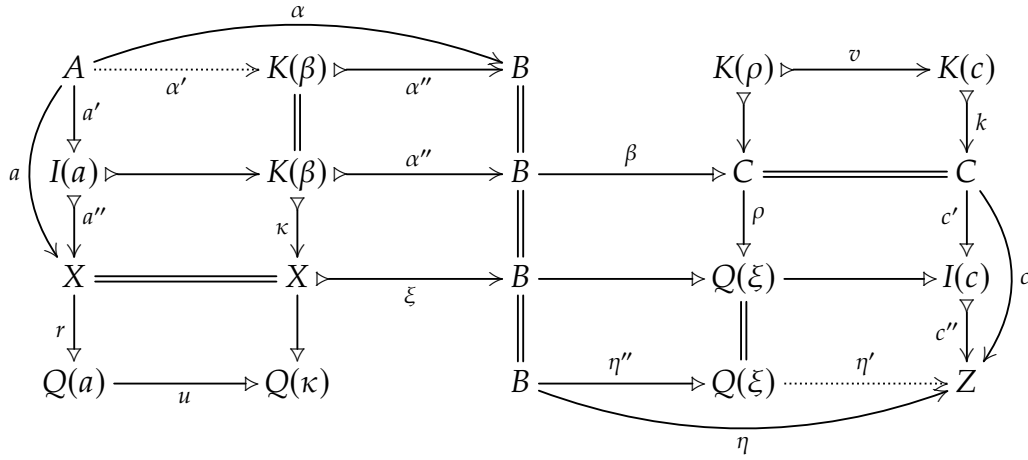

Upon confirming that the diagram commutes and that the maps have the indicated properties, a 3-fold application of the Pure Snake Lemma yields the following exact and coexact sequence which is spliced from short exact sequences.

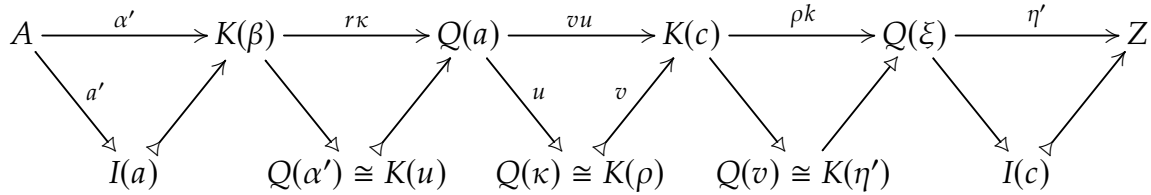

This proves the claim. □

Comments On minimal conditions

In the proof of (2.2.1), we actually only assume that we are working in a homologically self-dual category (2.1.11). Its generalizations (2.2.5), (2.2.6), and (2.2.7) rely only on properties of z-exact categories and the validity of the Pure Snake Lemma. So, they also hold under this weakened assumption.

The proof of the Classical Snake Lemma (2.2.2) involves four steps. As presented, Steps 1 and 2 are valid with a straightforward argument in di-exact categories. However, more subtly, we also presented an argument which is valid z-exact categories in which antinormal composites which are (co)subnormal are actually normal and that normal maps are preserved by dinversion; that is in sub-di-exact categories (2.1.11). Step 3 only relies on homological self-duality. So, the Classical Snake Lemma and its corollary (2.2.4) hold in sub-di-exact categories as well. We present a further analysis of sub-di-exact categories in Section 2.7.

Exercises

2.2.8 Exercise

Generalized pure snake III - DEx

In the setup of diagram (2.2.4), suppose at least one of the following two conditions hold.

- (i) The map a is normal, and the bottom row is coexact.
- (ii) The map c is normal, and the top row is exact.

Then the sequence below is exact and coexact, and is functorial with respect to morphisms of diagrams of type (2.2.4).

$$A \xrightarrow{a} X \xrightarrow{\beta\xi} C \xrightarrow{c} Z$$

2.3 Homology

We consider chain complexes in \mathbb{Z} -exact categories, and we introduce two types of homology as a measure of failure of exactness. Technically, these two definitions of homology are dual to one another. In a di-exact category, and under mild conditions required of the chain complex, these two constructions of homology are related as is explained in Lemma 2.3.9. For normal chain complexes, this relationship turns into an isomorphism.

Subsequently, we confirm that either type of homology serves its purpose as expected. Under the conditions formulated in (2.3.13) and (2.3.14), homology vanishes if and only if the chain complex is exact.

2.3.1 Definition

Chain complex - \mathbb{Z} -Ex

A *chain complex* is a \mathbb{Z} -indexed sequence of maps

$$\cdots \longrightarrow C_{n+1} \xrightarrow{d_{n+1}} C_n \xrightarrow{d_n} C_{n-1} \longrightarrow \cdots$$

such that $d_n \circ d_{n+1} = 0$ for each $n \in \mathbb{Z}$.

2.3.2 Notation

Chain complex

We write (C, d^C) for a chain complex, and shorten the notation to (C, d) or even C , if there is no risk of confusion. The family of maps d^C is called the *differential* or the *boundary operator* of the chain complex.

Thus every long exact sequence is a chain complex. The converse is far from true. To see how special exact chain complexes are, let us analyze consequences of the condition $d_n \circ d_{n+1} = 0$. For every $n \in \mathbb{Z}$, we find this decomposition diagram:

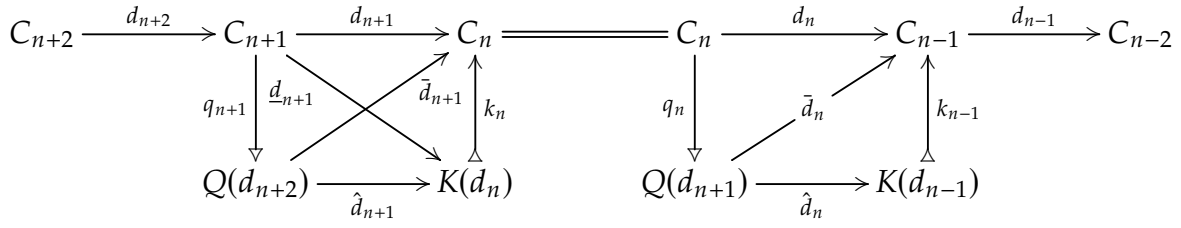

Figure 2.1: Decomposition diagram of d

Using that k_n is a kernel, we find a unique map \underline{d}_{n+1} with $d_{n+1} = k_n \circ \underline{d}_{n+1}$. Using that q_{n+1} is a cokernel, we find a unique \bar{d}_{n+1} with $d_{n+1} = \bar{d}_{n+1} \circ q_{n+1}$. Then:

- (a) $d_n \circ \bar{d}_{n+1} = 0$; so there is $r_{n+1}: Q(d_{n+2}) \rightarrow K(d_n)$, unique with $\bar{d}_{n+1} = k_n r_{n+1}$.
- (b) $\underline{d}_{n+1} \circ d_{n+2} = 0$; so there is $s_{n+1}: Q(d_{n+2}) \rightarrow K(d_n)$, unique with $\underline{d}_{n+1} = s_{n+1} q_{n+1}$.

We have $r_{n+1} = s_{n+1}$ because

$$k_n s_{n+1} q_{n+1} = k_n \underline{d}_{n+1} = d_{n+1} = \bar{d}_{n+1} q_{n+1} = k_n r_{n+1} q_{n+1}$$

Thus $\hat{d}_{n+1} := r_{n+1} = s_{n+1}$ is the unique map rendering the entire diagram commutative.

In general, there is no reason why \underline{d}_{n+1} should be a normal epimorphism and, hence, there is no reason why C should be exact in position n . Similarly, there is no reason why \bar{d}_n should be a normal monomorphism and, hence, there is no reason why C should be coexact in position n . Each of these observations leads to a measure of failure of exactness for chain complexes. The resulting discussion involves the following settings:

2.3.4 Definition

Types of chain complexes - z-Ex

Of a chain complex (C, d) , we distinguish the following properties:

- (i) (C, d) is a *normal chain complex* if d_n is a normal map for each $n \in \mathbb{Z}$.
- (ii) (C, d) is a *subnormal chain complex* if \underline{d}_n is a normal map for each $n \in \mathbb{Z}$.
- (iii) (C, d) is a *cosubnormal chain complex* if \bar{d}_n is a normal map for each $n \in \mathbb{Z}$.
- (iv) (C, d) is a *weakly normal chain complex* if \hat{d}_n is a normal map for each $n \in \mathbb{Z}$.

We clarify the relationship between these types of chain complexes via the following three lemmas.

2.3.5 Lemma

Recognizing normality of d_{n+1} - z-Ex

Using the notation of the decomposition diagram (2.3), the following are equivalent.

- (I) d_{n+1} is normal.
- (II) $\underline{d}_{n+1} = me$ is normal, and the composite $k_n m$ is a normal monomorphism.
- (III) $\bar{d}_{n+1} = v\varepsilon$ is normal, and the composite εq_{n+1} is a normal epimorphism. ◇

2.3.6 Lemma

Recognizing normality of \hat{d}_{n+1} - z-Ex

Using the notation of the decomposition diagram (2.3), the following are equivalent.

- (I) \hat{d}_{n+1} is normal.
- (II) The initial normal mono factorization $\underline{d}_{n+1} = \mu u$ of \underline{d}_{n+1} admits a cosubnormal refinement $\underline{d}_{n+1} = \mu \varepsilon q_{n+1}$.
- (III) The terminal normal epi factorization $\bar{d}_{n+1} = v\varepsilon$ of \bar{d}_{n+1} admits a subnormal refinement $\bar{d}_{n+1} = k_n m e$. ◇

2.3.7 Lemma

Cosubnormal and subnormal \Rightarrow Normal - z-Ex

A chain complex which is subnormal and cosubnormal is a normal chain complex.

Proof This follows from Proposition 1.8.15. □

The following diagram summarizes the relationships between the types of chain complexes in (2.3.4).

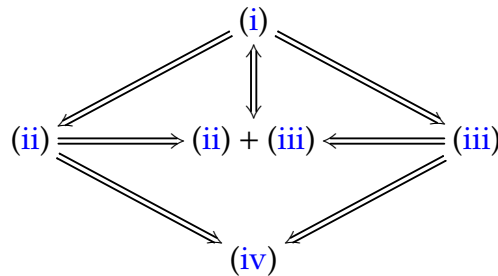

For weakly normal chain complexes we introduce the following measures of ‘failure of exactness’:

2.3.8 Definition

Homology of a chain complex - z-Ex

Let (C, d) denote a weakly normal chain complex. Using the notation of the decomposition diagram (2.3), the *cokernel homology* of (C, d) in position $n \in \mathbb{Z}$ is

$$H_n^c C := Q(\hat{d}_{n+1}) \cong Q(\underline{d}_{n+1}: C_{n+1} \rightarrow K(d_n))$$

The *kernel homology* of (C, d) in position n is

$$H_n^k C := K(\hat{d}_n) \cong \ker(\bar{d}_n)$$

The two constructions of homology are related as follows.

2.3.9 Lemma

Relationship: $H_n^c C$ and $H_n^k C$ - DEx

For a weakly normal chain complex (C, d) , the objects $H_n^c C$ and $H_n^k C$ are related via this functorial exact and coexact sequence:

$$Q(d_{n+2}) \xrightarrow{\bar{d}'_{n+1}} K(q_n) \longrightarrow H_n^c C \xrightarrow{\lambda_n(C)} H_n^k C \longrightarrow Q(k_n) \xrightarrow{\underline{d}'_n} K(d_{n-1})$$

where $\bar{d}'_{n+1} = \ker(q_n) \circ \bar{d}'_{n+1}$ and $\underline{d}'_n = \underline{d}'_n \circ \text{coker}(k_n)$. The comparison map $\lambda_n(C)$ has the following properties:

- (i) $\lambda_n(C)$ is a normal monomorphism if and only if d_{n+1} is cosubnormal.
- (ii) $\lambda_n(C)$ is a normal epimorphism if and only if d_n is subnormal.

Proof We relate the kernel and cokernel variants of homology via this diagram:

$$\begin{array}{ccccccc}
 C_{n+2} & \xrightarrow{d_{n+2}} & C_{n+1} & \xrightarrow{d_{n+1}} & C_n & & H_n^k C \\
 & & \downarrow q_{n+1} & & \parallel & & \downarrow \\
 & & Q(d_{n+2}) & \xrightarrow{\bar{d}'_{n+1}} & C_n & \xrightarrow{q_n} & Q(d_{n+1}) \\
 & & \downarrow \hat{d}'_{n+1} & & \parallel & & \downarrow \hat{d}'_n \\
 & & K(d_n) & \xrightarrow{k_n} & C_n & \xrightarrow{\underline{d}'_n} & K(d_{n-1}) \\
 & & \downarrow & & \parallel & & \downarrow k_{n-1} \\
 & & H_n^c C & & C_n & \xrightarrow{d_n} & C_{n-1} \xrightarrow{d_{n-1}} C_{n-2}
 \end{array}$$

By assumption, the maps \hat{d}_k are normal. Thus the Generalized Pure Snake Lemma 2.2.7 yields the claimed exact sequence and its functoriality.

- (i) By exactness, the map $\lambda_n(C)$ is a normal monomorphism if and only if \bar{d}'_{n+1} is a normal epimorphism. This happens if and only if \bar{d}'_{n+1} is a normal map which, in turn, is equivalent to d_{n+1} being cosubnormal.
- (ii) Similarly, $\lambda_n(C)$ is a normal epimorphism if and only if \underline{d}'_n is a normal monomorphism. This happens if and only if \underline{d}'_n is a normal map which, in turn, is equivalent to d_n being subnormal. □

2.3.10 Corollary

Homology of a types of chain complexes - DEx

For a weakly normal chain complex (C, d) the following hold

- (i) If (C, d) is subnormal, then $\lambda_n(C): H_n^c C \rightarrow H_n^k C$ is a normal epimorphism for all $n \in \mathbb{Z}$.
- (ii) If (C, d) is cosubnormal, then $\lambda_n(C): H_n^c C \rightarrow H_n^k C$ is a normal monomorphism for all $n \in \mathbb{Z}$.
- (iii) If (C, d) is normal, then $\lambda_n(C): H_n^c C \rightarrow H_n^k C$ is an isomorphism for all $n \in \mathbb{Z}$.

Proof (i) and (ii) follow from (2.3.9). This implies (iii) because a map that is both subnormal and cosubnormal is normal (1.8.15). \square

2.3.11 Corollary

Homology of a normal chain complex - DEx

For a normal chain complex (C, d) in a di-exact category, $\lambda_n(C): H_n^c C \cong H_n^k C$ is an isomorphism for every $n \in \mathbb{Z}$. \diamond

In view of Corollary 2.3.11, there is no need to distinguish between the cokernel vs. the kernel based approach to homology. Instead, as in abelian categories, we use the isomorphisms $\lambda_n(C)$ to define the homology of the complex:

2.3.12 Notation

Homology of a normal chain complex - DEx

Given a normal chain complex (C, d) in a di-exact category, we define

$$H_n(C) := H_n^c C \cong H_n^k C$$

We confirm that either of the two homology variants we just introduced vanishes if and only if the chain complex in question is exact in the appropriate position.

2.3.13 Proposition

$H_n^c C$ vanishes if and only if chain complex exact - z-Ex

For a weakly normal chain complex (C, d) in a pointed category \mathcal{X} the following hold.

- (i) If (C, d) is exact in position $n \in \mathbb{Z}$, then $H_n^c C = 0$.
- (ii) If \underline{d}_n is normal, and $H_n^c C = 0$, then $H_n^k C = 0$ as well, and C is exact in position n .

Hence a subnormal chain complex (C, d) is exact in position $n \in \mathbb{Z}$ if and only if $H_n^c C = H_n^k C = 0$.

Proof We reason via the commutative diagram below.

$$\begin{array}{ccccccc}
 & & & \xrightarrow{d_{n+1}} & & & \\
 & & & \curvearrowright & & & \\
 C_{n+1} & \xrightarrow{q_{n+1}} & Q(d_{n+2}) & \xrightarrow{\bar{d}_{n+1}} & C_n & \xrightarrow{q_n} & Q(d_{n+1}) \\
 \rho_{n+1} \downarrow & \searrow \underline{d}_{n+1} & \downarrow \hat{d}_{n+1} & & \parallel & & \downarrow \bar{d}_n \\
 I & \xrightarrow{e_{n+1}} & K(d_n) & \xrightarrow{k_n} & C_n & \xrightarrow{d_n} & C_{n-1}
 \end{array}$$

- (i) If C is exact in position n , then \underline{d}_{n+1} is a normal epimorphism. So $H_n^c C = Q(\underline{d}_{n+1}) = 0$.
- (ii) If $H_n^c C = Q(\hat{d}_{n+1}) = 0$, and $\underline{d}_{n+1} = e_{n+1}\rho_{n+1}$ is normal, then $e_{n+1} = \ker(0)$ may be chosen to be $1_{K(d_n)}$. But then $\underline{d}_{n+1} = \rho_{n+1}$, implying that C is exact in position n . \square

Dually:

2.3.14 Proposition $H_n^k C$ vanishes if and only if chain complex coexact - z-Ex
 For a weakly normal chain complex (C, d) in a pointed category \mathcal{X} the following hold.

- (i) If (C, d) is coexact in position $n \in \mathbb{Z}$, then $H_n^k C = 0$.
- (ii) If \bar{d}_n is normal, and $H_n^k C = 0$, then C is coexact in position n .

A cosubnormal chain complex (C, d) is coexact in position $n \in \mathbb{Z}$ if and only if $H_n^k C = 0$. \diamond

Hence:

2.3.15 Corollary Simultaneous vanishing of $H_n^k C$ and $H_n^c C$ - z-Ex
 For a normal chain complex C and $n \in \mathbb{Z}$, we have $H_n^k C = 0 = H_n^c C$ if and only if C is exact in position n . \diamond

Lemma 2.3.9 leaves open the possibility that, in a subnormal chain complex, $H_n^k C$ can vanish while $H_n^c C \neq 0$. In this case, the property ' $H_n^k C = 0$ ' does not characterize exactness of C in position n . Examples show that this actually happens:

2.3.16 Example Non-subnormal chain complex
 In the category Grp of groups, consider the following chain complex C , in which $C_0 = \langle y \rangle$ is the free group on the single generator y :

$$\cdots \longrightarrow 0 \longrightarrow \langle x \rangle \xrightarrow{d_2} \langle x, y \rangle \xrightarrow{d_1} \langle y \rangle \longrightarrow 0 \longrightarrow \cdots$$

Further, d_2 is the inclusion which maps x to x , and d_1 is the quotient map which sends x to 1 and y to y . Then we find that $H_1^k C = 0$, while

$$H_1^c C \cong \langle y^n x y^{-n}, n \in \mathbb{Z} - \{0\} \rangle$$

The complex C is not subnormal, though.

2.3.17 Example

Subnormal, non-normal chain complex

In the category Grp of groups we now construct a subnormal chain complex C which is not exact but has $H_n^k C = 0$: Choose a group M with normal subgroup L containing a normal subgroup K whose normal closure in M is L . Then this diagram is a subnormal chain complex.

$$\cdots \longrightarrow 0 \longrightarrow K \xrightarrow{d_2} M \xrightarrow{d_1} M/L \longrightarrow 0 \longrightarrow \cdots,$$

If M sits in position 0, then $H_0^k C = 0$ while $H_n^c C \cong L/K \neq 0$. In particular, the chain complex is not exact at M .

For a concrete example, choose $M/L = C_2 = \{\pm 1\}$ a 2-element group acting on $L := \mathbb{Z} \times \mathbb{Z}$ by interchanging coordinates. Then take $K := \mathbb{Z} \times 0$.

2.3.18 Definition

Morphism of chain complexes - z-Ex

A morphism $f: C \rightarrow D$ of chain complexes is given by a commutative diagram of the form:

$$\begin{array}{ccccccc} C & & \cdots & \longrightarrow & C_{n+1} & \xrightarrow{d_{n+1}^C} & C_n & \xrightarrow{d_n^C} & C_{n-1} & \longrightarrow & \cdots \\ f \downarrow & & & & \downarrow f_{n+1} & & \downarrow f_n & & \downarrow f_{n-1} & & \\ D & & \cdots & \longrightarrow & D_{n+1} & \xrightarrow{d_{n+1}^D} & D_n & \xrightarrow{d_n^D} & D_{n-1} & \xrightarrow{d_{n-1}^D} & \cdots \end{array}$$

The chain complexes in a pointed category \mathcal{C} form a category containing as full subcategories 'subnormal chain complexes', 'cosubnormal chain complexes' and 'normal chain complexes'.

2.3.19 Proposition

H_n^c - and H_n^k - are functorial - z-Ex

A morphism $f: A \rightarrow B$ of weakly normal chain complexes induces, for each $n \in \mathbb{Z}$, a

commutative square of homology objects:

$$\begin{array}{ccc}
 H_n^c A & \xrightarrow{\lambda_n(A)} & H_n^k A \\
 H_n^c f \downarrow & & \downarrow H_n^k f \\
 H_n^c B & \xrightarrow{\lambda_n(A)} & H_n^k B
 \end{array}$$

The above diagram is functorial with respect to morphisms of weakly normal chain complexes.

Proof The diagram we used to define H_n^c and H_n^k , see (2.3.8) is functorial with respect to morphisms of chain complexes. So, the claim follows. \square

Notes

On Minimal Conditions Both, lemma (2.3.9), which explains the relationship between the kernel and the cokernel constructions of homology, and its corollary (2.3.10) rely only on the Pure Snake Lemma. So, both are valid in homologically self-dual categories.

On the Need for Both Types of Homology In view of Corollary 2.3.11, one might be tempted to conclude that considering both, the kernel definition as well as the cokernel definition of homology is redundant if we agree to work with normal chain complexes only. This, however, is not so because constructions that we might want to perform force us to consider both kinds of homology in conjunction; see in particular Theorem 2.4.4.

Exercises

2.3.20 Exercise

(Non-)cancellation in a product - z-Ex

Give an example of a pointed category with non-zero objects X and Y such $X \times Y \cong Y$. Then show the following: In every pointed category, for objects X and Y which admit a product $X \times Y$, if $pr_Y: X \times Y \rightarrow Y$ is a monomorphism, then $X \cong 0$.

2.4 The Long Exact Homology Sequence

We provide effective tools for computing with homology. Most importantly, this includes the long exact sequence of homology objects associated with a short exact sequence of normal chain complexes; see (2.4.2).

Next, we analyze the chain complexes obtained by taking pointwise kernels and cokernels of a normal morphism of long exact sequences, Theorem 2.4.4. We find that the chain complex of pointwise kernels is subnormal, while the chain complex of cokernels is cosubnormal. Then we show that the homology of the cokernel complex agrees with the homology of the kernel complex up to a dimension shift (2.4.4). In abelian categories this is well known and takes a much simpler form. Under the present minimal assumptions, it confirms that it is essential to introduce the fine grained cokernel and kernel homologies (2.3.8), as well as various types of chain complexes (2.3.1).

Theorem 2.4.4 provides homological methods for a whole range of results familiar from abelian categories. For example:

- ▶ We find conditions under which a normal morphism of exact chain complexes has an exact kernel complex, respectively an exact cokernel complex; see (2.4.5).
- ▶ For a sequence $X \xrightarrow{f} Y \xrightarrow{g} Z$ of normal maps, we find its associated 6-term exact sequence of kernels and cokernels; see (2.4.7).
- ▶ We obtain further variations of the Snake Lemma in (2.4.8) and in (2.4.9).

2.4.1 Definition Exactness of composite of morphisms of chain complexes - z-Ex

A diagram $A \rightarrow B \rightarrow C$ of chain complexes is called *short exact* if, for each $n \in \mathbb{Z}$, the sequence $A_n \rightarrow B_n \rightarrow C_n$ is short exact.

2.4.2 Theorem Long exact homology sequence - DEx

A short exact sequence $A \xrightarrow{f} B \xrightarrow{g} C$ of normal chain complexes functorially induces a long exact sequence of homology objects:

$$\cdots \rightarrow H_{n+1}(C) \xrightarrow{\partial_{n+1}} H_n(A) \xrightarrow{f_*} H_n(B) \xrightarrow{g_*} H_n(C) \xrightarrow{\partial_n} H_{n-1}(A) \rightarrow \cdots$$

Proof *Step 1* Each position k of the short exact sequence of chain complexes yields a

morphism of short exact sequences in \mathfrak{X} :

$$\begin{array}{ccccc}
 K(d_{k+1}^A) & \twoheadrightarrow & K(d_{k+1}^B) & \longrightarrow & K(d_{k+1}^C) \\
 \downarrow & & \downarrow & & \downarrow \\
 A_{k+1} & \twoheadrightarrow & B_{k+1} & \longrightarrow & C_{k+1} \\
 \downarrow d_{k+1}^A & & \downarrow d_{k+1}^B & & \downarrow d_{k+1}^C \\
 A_k & \twoheadrightarrow & B_k & \longrightarrow & C_k \\
 \downarrow & & \downarrow & & \downarrow \\
 Q(d_{k+1}^A) & \longrightarrow & Q(d_{k+1}^B) & \longrightarrow & Q(d_{k+1}^C)
 \end{array}$$

The top sequence is coexact, and the bottom sequence is exact by the Snake Lemma 2.2.2.

Step 2 Choosing $k = n + 1$ and $n - 1$, we form the following commutative diagram.

$$\begin{array}{ccccc}
 H_n^k A & \longrightarrow & H_n^k B & \longrightarrow & H_n^k C \\
 \downarrow & & \downarrow & & \downarrow \\
 Q(d_{n+1}^A) & \longrightarrow & Q(d_{n+1}^B) & \longrightarrow & Q(d_{n+1}^C) \\
 \downarrow \hat{d}_{n+1}^A & & \downarrow \hat{d}_{n+1}^B & & \downarrow \hat{d}_{n+1}^C \\
 K(d_{n-1}^A) & \twoheadrightarrow & K(d_{n-1}^B) & \longrightarrow & K(d_{n-1}^C) \\
 \downarrow & & \downarrow & & \downarrow \\
 H_{n-1}^c A & \longrightarrow & H_{n-1}^c B & \longrightarrow & H_{n-1}^c C
 \end{array}$$

The maps $\hat{d}_n^A, \hat{d}_n^B, \hat{d}_n^C$ are normal. So we apply the Relaxed Snake Lemma 2.2.4 to obtain a segment of the claimed exact sequence of homology objects. To complete the proof, all that remains is to identify kernel/cokernel based homology objects via (2.3.9). Since the Relaxed Snake Lemma as well as the isomorphism of cokernel and kernel defined homology is functorial, so is the long exact homology sequence. \square

2.4.3 Terminology

Long exact homology sequence

In the setting of (2.4.2), the sequence

$$\cdots \rightarrow H_{n+1}(C) \xrightarrow{\partial_{n+1}} H_n(A) \xrightarrow{f_*} H_n(B) \xrightarrow{g_*} H_n(C) \xrightarrow{\partial_n} H_{n-1}(A) \rightarrow \cdots$$

is called the *long exact homology sequence* of the given short exact sequence of normal chain complexes. The maps ∂_n are known as connecting homomorphisms

2.4.4 Theorem (Co-)kernels of a normal morphism of long exact sequences - DEx
Consider a morphism of long exact sequences:

$$\begin{array}{ccccccccccc}
 \cdots & \longrightarrow & A_{n+2} & \xrightarrow{d_{n+2}^A} & A_{n+1} & \xrightarrow{d_{n+1}^A} & A_n & \xrightarrow{d_n^A} & A_{n-1} & \xrightarrow{d_{n-1}^A} & A_{n-2} & \longrightarrow & \cdots \\
 & & \alpha_{n+2} \downarrow & & \alpha_{n+1} \downarrow & & \alpha_n \downarrow & & \alpha_{n-1} \downarrow & & \alpha_{n-2} \downarrow & & \\
 \cdots & \longrightarrow & B_{n+2} & \xrightarrow{d_{n+2}^B} & B_{n+1} & \xrightarrow{d_{n+1}^B} & B_n & \xrightarrow{d_n^B} & B_{n-1} & \xrightarrow{d_{n-1}^B} & B_{n-2} & \longrightarrow & \cdots
 \end{array}$$

If each α_n is a normal map, then the kernel objects $K_n := K(\alpha_n)$ form a subnormal chain complex, while the cokernel terms $C_n := Q(\alpha_n)$ form a cosubnormal chain complex. The homologies of these two chain complexes are linked via an isomorphism which is functorial with respect to morphisms of normal morphisms of long exact sequences:

$$H_{n-1}^c K \cong H_{n+1}^k C$$

Proof *Step 1: Long exact sequences are spliced short exact ones* By Definition 1.9.8, each of the long exact sequences (A, d^A) and (B, d^B) is spliced together from short exact sequences as shown. Since normal factorizations are functorial (1.8.13), we obtain this commutative diagram.

$$\begin{array}{ccccccccccc}
 A_{n+2} & \xrightarrow{d_{n+2}^A} & A_{n+1} & \xrightarrow{d_{n+1}^A} & A_n & \xrightarrow{d_n^A} & A_{n-1} & \xrightarrow{d_{n-1}^A} & A_{n-2} \\
 \alpha_{n+2} \downarrow & & \alpha_{n+1} \downarrow & \varepsilon_{n+1}^A \swarrow & \mu_{n+1}^A \searrow & & \alpha_{n-1} \downarrow & & \alpha_{n-2} \downarrow \\
 & & & I_{n+1} & & & I_n & & \\
 & & & \gamma_{n+1} \downarrow & & & \gamma_n \downarrow & & \\
 B_{n+2} & \xrightarrow{d_{n+2}^B} & B_{n+1} & \xrightarrow{d_{n+1}^B} & B_n & \xrightarrow{d_n^B} & B_{n-1} & \xrightarrow{d_{n-1}^B} & B_{n-2} \\
 & & \varepsilon_{n+1}^B \swarrow & \mu_{n+1}^B \searrow & & & \varepsilon_n^B \swarrow & \mu_n^B \searrow & \\
 & & J_{n+1} & & J_n & & & &
 \end{array}$$

Here $I_{n+1} := Q(d_{n+2}^A) \cong K(d_n^A)$ and $J_{n+1} := Q(d_{n+2}^B) \cong K(d_n^B)$. The maps γ_n are normal by (2.1.17). Since kernels and cokernels are functorial, Step 1 depends functorially on morphisms of normal morphisms of long exact sequences.

To continue the argument, we insert the (3×3) -diagram of normal factorizations from

(2.1.16) into the squares $A_n \rightrightarrows B_{n-1}$ of normal maps.

Step 2: Computation of the homology of the subnormal kernel sequence By definition, $\sigma_n := \ker(\gamma_n)$. This yields the factorization $k_n = \lambda_n \bar{k}_n$. The square $L_n \rightrightarrows A_{n-1}$ is a pullback (1.6.2). So λ_n is a normal monomorphism by (1.5.4). It is the kernel of the composite $\varepsilon_{n-1}^A \kappa_{n-1}$ by (1.5.8) and, hence, the kernel of k_{n-1} .

Further, the antinormal composite $\varepsilon_n^A \kappa_n$ also has a normal factorization $\sigma_n \bar{k}_n = m e$, with e a normal epimorphism, and m a normal monomorphism. So \bar{k}_n is a normal map by (1.8.11). Since k_n factors through $\ker(k_{n-1})$, (K, k) is a chain complex. This chain complex is subnormal by what we just showed. It depends functorially on morphisms of normal morphisms between long exact sequences. - By definition:

$$H_{n-1}^c K = Q(\bar{k}_n)$$

Step 3: Computation of the homology of the cosubnormal cokernel complex By definition, $\tau_n := \operatorname{coker}(\gamma_n)$. This yields the factorization $c_n = \bar{c}_n \rho_n$. The square $B_n \rightrightarrows T_n$ is a pushout by (1.6.4). So ρ_n is a normal epimorphism by (1.5.4). It is the cokernel of the composite $\varepsilon_n \mu_{n+1}^B$ and, hence, the cokernel of c_{n+1} .

Further, the antinormal composite $\varepsilon_n \mu_{n+1}^B$ has a normal factorization via which we see that \bar{c}_{n+1} is a normal map. This renders c_{n+1} a cosubnormal map. Since c_n factors through $\operatorname{coker}(c_{n+1})$, (C, c) is a chain complex which is cosubnormal by what we just showed. It depends functorially on morphisms of normal morphisms between long exact sequences. - By definition:

$$H_{n+1}^k C = K(\bar{c}_{n+1})$$

Step 4: $H_{n-1}^c K \cong H_{n+1}^k C$ The Snake Lemma 2.2.2 yields:

$$\begin{array}{ccccccc}
 L_{n+1} & \xrightarrow{\lambda_{n+1}} & K_n & \xrightarrow{k_n} & L_n & \longrightarrow & H_{n-1}^c K \\
 \sigma_{n+1} \downarrow & & \kappa_n \downarrow & & \sigma_n \downarrow & & \\
 I_{n+1} & \longrightarrow & A_n & \longrightarrow & I_n & & \\
 \gamma_{n+1} \downarrow & & \alpha_n \downarrow & & \gamma_n \downarrow & & \\
 J_{n+1} & \longrightarrow & B_n & \longrightarrow & J_n & & \\
 \tau_{n+1} \downarrow & & \varepsilon_n \downarrow & & \tau_n \downarrow & & \\
 H_{n+1}^k C \longrightarrow & T_{n+1} & \xrightarrow{\bar{c}_{n+1}} & C_n & \xrightarrow{\rho_n} & T_n &
 \end{array}$$

From the proof of the Snake Lemma we obtain the desired isomorphism

$$H_{n-1}^c K \cong H_{n+1}^k C$$

This completes the proof. \square

2.4.5 Corollary

Kernel sequence exact \Leftrightarrow cokernel sequence exact - DEx

A normal morphism of long exact sequences has an exact sequence of pointwise kernels if and only if it has an exact sequence of pointwise cokernels.

Proof With (2.3.13) we see that (K, k) is exact if and only if $H_n^c K = 0$, for all $n \in \mathbb{Z}$. By (2.4.4), this happens if and only if $H_n^k C = 0$, for all $n \in \mathbb{Z}$. With (2.3.14), we see that this is equivalent to the exactness of (C, c) . \square

2.4.6 Corollary

Positionwise (co-)kernel is (co-)kernel - DEx

For a normal morphism $f: A \rightarrow B$ of long exact sequences the following hold:

- (i) If each f_n is a monomorphism, then f is a normal monomorphism in the category of long exact sequences.
- (ii) If each f_n is an epimorphism, then f is a normal epimorphism in the category of long exact sequences. \diamond

2.4.7 Corollary

6-term exact sequence from composite - DEx

In the composite $X \xrightarrow{f} Y \xrightarrow{g} Z$, if f , g , and $g \circ f$ are normal maps, then the sequence below is exact. It is functorial with respect to morphisms of such composition diagrams.

$$K(f) \xrightarrow{u} K(gf) \xrightarrow{\tilde{f}} K(g) \longrightarrow Q(f) \xrightarrow{v} Q(gf) \xrightarrow{\tilde{g}} Q(g)$$

Here u is the universal map of kernels, and v is the universal map of cokernels. The maps \tilde{f} and \tilde{g} are explained in the proof.

Proof We work with the commutative diagram below.

$$\begin{array}{ccccccccc}
 0 & \longrightarrow & 0 & \longrightarrow & K(g) & \longrightarrow & K(v) & \longrightarrow & 0 \\
 \downarrow & & \downarrow & & \downarrow & & \downarrow & & \\
 K(f) & \xrightarrow{\kappa} & X & \xrightarrow{f} & Y & \longrightarrow & Q(f) & & \\
 \downarrow u & & \parallel & & \downarrow g & & \downarrow v & & \\
 K(gf) & \xrightarrow{\kappa'} & X & \xrightarrow{gf} & Z & \longrightarrow & Q(gf) & & \\
 \downarrow & & \downarrow & & \downarrow & & \downarrow & & \\
 Q(u) & \longrightarrow & 0 & \longrightarrow & Q(g) & \longrightarrow & Q(v) & &
 \end{array}$$

Note that the rows in the middle are exact because f and gf are normal. The quadruple $(u, 1_X, g, v)$ forms a normal morphism of long exact sequences because (a) u is a normal monomorphism by (iv); (b) g is normal by assumption; and (c) v is normal by (2.1.17).

Both, the row of cokernels and the row of kernels are normal chain complexes. In all positions but $K(v)$ this is obvious. In position $K(v)$ (2.4.4) tells us that the map $K(g) \rightarrow K(v)$ is subnormal. With $\ker(K(v) \rightarrow 0) = 1_{K(v)}$, it follows that it is normal. Thus (2.3.15): either chain complex is exact in a given position if and only if its homology in that position vanishes.

Step 1 $Q(g) \rightarrow Q(v)$ is an isomorphism Indeed, it is a normal epimorphism by (1.5.9). Further, its kernel K is the homology of the bottom chain complex in position $Q(g)$. By (2.4.4) this kernel vanishes. By (1.5.7), the horizontal bottom right map is an isomorphism.

Step 2 $K(g) \rightarrow K(v)$ is a normal epimorphism Again by (2.4.4) we have that 0 is the homology of the normal chain complex $0 \rightarrow K(g) \rightarrow K(v) \rightarrow 0$ in position $K(v)$. So, the normal map in question is a normal epimorphism.

Step 3 $Q(u) \cong K(K(g) \rightarrow K(v))$ First, $Q(u)$ is the homology of the bottom chain complex in the leftmost position. Second, $K(K(g) \rightarrow K(v))$ is the homology of the top chain complex in position $K(g)$. By (2.4.4), both terms are isomorphic.

Step 4 We assemble the available information to obtain the 6-term exact sequence:

$$\begin{array}{ccccccccc}
 K(f) & \xrightarrow{u} & K(gf) & \xrightarrow{\tilde{f}} & K(g) & \longrightarrow & Q(f) & \xrightarrow{v} & Q(gf) & \longrightarrow & Q(v) \\
 & & \searrow & & \swarrow & & \swarrow & & \searrow & & \downarrow \cong \\
 & & Q(u) & & K(v) & & & & Q(g) & & \\
 & & \swarrow & & \searrow & & & & & &
 \end{array}$$

This was to be shown. Since all the constructions and arguments used are functorial, so is the 6-term exact sequence. \square

Notes On Minimal Conditions

The proof of theorem (2.4.2) relies on the relaxed Snake Lemma (2.2.4), which is valid in sub-di-exact categories. Thus (2.4.2) holds in such categories as well.

Exercises

2.4.8 Exercise

Strong relaxed Snake Lemma - DEx

In the morphism of exact sequences below, assume that a, b, c are normal maps.

$$\begin{array}{ccccccccc}
 K(\alpha) & \longrightarrow & A & \xrightarrow{\alpha} & B & \xrightarrow{\beta} & C & \longrightarrow & 0 \\
 \downarrow & & \downarrow a & & \downarrow b & & \downarrow c & & \downarrow \\
 0 & \longrightarrow & X & \xrightarrow{\xi} & Y & \xrightarrow{\eta} & Z & \longrightarrow & Q(\eta)
 \end{array}$$

Then the sequence below is exact and functorial.

$$\begin{array}{ccccccc}
 0 & \longrightarrow & K(\alpha) & \longrightarrow & K(a) & \longrightarrow & K(b) & \longrightarrow & K(c) \\
 & & & & & & \downarrow & & \\
 & & & & & & Q(a) & \longrightarrow & Q(b) & \longrightarrow & Q(c) & \longrightarrow & Q(\eta) & \longrightarrow & 0.
 \end{array}$$

2.4.9 Exercise

Extended Snake Lemmas - DEx

Consider the commutative diagram with exact rows below.

$$\begin{array}{ccccccccc}
 A & \xrightarrow{a} & B & \xrightarrow{b} & C & \longrightarrow & D & \longrightarrow & 0 \\
 \alpha \downarrow & & \beta \downarrow & & \gamma \downarrow & & \delta \downarrow & & \\
 0 & \longrightarrow & W & \xrightarrow{w} & X & \xrightarrow{x} & Y & \xrightarrow{y} & Z
 \end{array}$$

If the vertical maps are normal, then the following hold:

(i) If $Q(\alpha) = 0$, then the sequence below is exact and functorial with respect to morphisms of such diagrams:

$$K(\alpha) \longrightarrow K(\beta) \longrightarrow K(\gamma) \longrightarrow K(\delta) \xrightarrow{\partial} Q(\beta) \longrightarrow Q(\gamma) \longrightarrow Q(\delta)$$

(ii) If $K(\delta) = 0$, then the sequence below is exact and functorial with respect to morphisms of such diagrams:

$$K(\alpha) \longrightarrow K(\beta) \longrightarrow K(\gamma) \xrightarrow{\partial} Q(\alpha) \longrightarrow Q(\beta) \longrightarrow Q(\gamma) \longrightarrow Q(\delta)$$

2.4.10 Exercise **Kernel/cokernel sequences from a square of proper maps - DEx**
 Consider the morphism of exact sequences constructed from the center square of normal maps.

$$\begin{array}{ccccccc}
 K(\alpha) & \triangleright & \longrightarrow & A & \xrightarrow{a} & B & \longrightarrow \triangleright Q(\alpha) \\
 K(\alpha, \beta) \downarrow & & & \alpha \downarrow & & \beta \downarrow & & \downarrow Q(\alpha, \beta) \\
 K(x) & \triangleright & \longrightarrow & X & \xrightarrow{x} & Y & \longrightarrow \triangleright Q(x)
 \end{array}$$

If $Q(K(\alpha, \beta)) = 0$, show that the sequence below is exact:

$$\begin{array}{ccccccc}
 0 & \longrightarrow & K(K(\alpha, \beta)) & \triangleright \longrightarrow & K(\alpha) & \longrightarrow & K(\beta) & \longrightarrow & K(Q(\alpha, \beta)) \\
 & & & & & & & & \downarrow \\
 & & & & & & & & Q(\alpha) & \longrightarrow & Q(\beta) & \longrightarrow & Q(Q(\alpha, \beta)) & \longrightarrow & 0
 \end{array}$$

Further, if $K(Q(\alpha, \beta)) = 0$, show that the sequence below is exact:

$$\begin{array}{ccccccc}
 0 & \longrightarrow & K(K(\alpha, \beta)) & \triangleright \longrightarrow & K(\alpha) & \longrightarrow & K(\beta) \\
 & & & & & & \downarrow \\
 & & & & & & Q(K(\alpha, \beta)) & \longrightarrow & Q(\alpha) & \longrightarrow & Q(\beta) & \longrightarrow & Q(Q(\alpha, \beta)) & \longrightarrow & 0
 \end{array}$$

Now use the symmetry in the center square of the above diagram to develop 7-term exact sequences involving the kernels and cokernels of a and x .

2.5 Homological Self Duality

In (2.1.11i), we said that a z-exact category is homologically self-dual if dinversion turns every antinormal decomposition of the zero map into a normal map and, hence, yields a di-extension. Here, we show that this condition has a much wider scope: For any normal chain complex C , it is equivalent to the condition that the cokernel construction of homology $H_n^c C$ and the kernel construction $H_n^k C$ coincide. Perhaps a bit surprisingly, it is also equivalent to the validity of the Pure Snake Lemma, as well as the validity of the Third Isomorphism Theorem.

We begin by examining properties of certain morphisms of short exact sequence which are directly related to the manner in which homological self-duality can be used to construct di-extensions as in Figure 2.1.

2.5.1 Definition **Totally normal sequence of mono/epimorphisms - z-Ex**
 A sequence of monomorphisms (resp. epimorphisms) $A \rightarrow B \rightarrow \cdots \rightarrow Z$ is *totally normal* if all composites of these morphisms are normal monomorphisms (resp. normal epimorphisms).

With (1.6.4), let us observe that every totally normal sequence of monomorphisms yields a special morphism of short exact sequences in which the right hand square is a pushout:

$$\begin{array}{ccccc}
 A & \xrightarrow{\alpha} & B & \xrightarrow{q:=\text{coker}(\alpha)} & Q \\
 \parallel & & \downarrow \beta & \lrcorner & \downarrow \gamma \\
 A & \xrightarrow{\beta\alpha} & C & \xrightarrow{r:=\text{coker}(\beta\alpha)} & R
 \end{array} \tag{2.5.2}$$

While pushouts preserve (normal) epimorphisms (1.5.4), in general, they fail to preserve (normal) monomorphisms.

2.5.3 Lemma **Properties of Diagram (2.5.2) - z-Ex**
 In diagram (2.5.2) the left hand square is a pullback, and so $\alpha = \ker(r\beta)$. If γ is a monomorphism, then the square on the right is bicartesian.

Proof To see that the left hand square is a pullback, consider maps $a: T \rightarrow A$ and $b: T \rightarrow B$ with $\beta b = \beta\alpha a$. The monic property of β implies that $b = \alpha a$. Thus a is the unique filler required for the pullback property to hold. With (1.5.8.i), we see that $\alpha = \ker(r\beta)$.

Now, suppose γ is a monomorphism. Since the right hand square is a pushout, the

cokernels of β and γ are related by an isomorphism:

$$\begin{array}{ccccc}
 A & \xrightarrow{\alpha} & B & \xrightarrow{q:=\text{coker}(\alpha)} & Q \\
 \parallel & & \downarrow \beta & \lrcorner & \downarrow \gamma \\
 A & \xrightarrow{\beta\alpha} & C & \xrightarrow{r:=\text{coker}(\beta\alpha)} & R \\
 & & \downarrow & & \downarrow \\
 & & S & \xlongequal{\quad} & S
 \end{array}$$

With (1.6.2) we see that the right hand square is a pullback. □

Dually, every totally normal sequence of epimorphisms yields a special morphism of short exact sequences in which the left hand square is a pullback:

$$\begin{array}{ccccc}
 K & \xrightarrow{k:=\text{ker}(\eta\xi)} & X & \xrightarrow{\eta\xi} & Z \\
 \downarrow \kappa & \lrcorner & \downarrow \xi & & \parallel \\
 L & \xrightarrow{l:=\text{ker}(\eta)} & Y & \xrightarrow{\eta} & Z
 \end{array} \tag{2.5.4}$$

While pullbacks preserve (normal) monomorphisms (1.5.4), in general, they fail to preserve (normal) epimorphisms.

2.5.5 Lemma

Properties of Diagram (2.5.4) - z-Ex

In diagram (2.5.4) the left hand square is a pushout, and so $\eta = \text{coker}(\xi k)$. If κ is an epimorphism, then the square on the left is bicartesian. ◇

2.5.6 Proposition

Diverions of 0 and (2.5.2) / (2.5.4) - z-Ex

In a z-exact category, the following conditions are equivalent.

- (I) For every totally normal sequence of monomorphisms and its morphism of short exact sequences as in (2.5.2), the normal monomorphism β pushes forward to a normal monomorphism γ .
- (II) Every diversion of 0 is a normal map. - HSD
- (III) For every totally normal sequence of epimorphisms and its morphism of short exact sequences, as in (2.5.4), the normal epimorphism ξ pulls back to a normal epimorphism κ .

Proof (I) \Rightarrow (II) Given an antinormal decomposition $0 = em$ of 0 , form the pullback on the top left:

$$\begin{array}{ccccc}
 \square & \xrightarrow{k} & K(e) & \xrightarrow{q} & Q(k) \\
 \parallel & & \downarrow \kappa & & \downarrow \underline{\kappa} \\
 \square & \xrightarrow{m} & \square & \xrightarrow{\varepsilon} & Q(m) \\
 \downarrow & & \downarrow e & & \\
 0 & \longrightarrow & \square & &
 \end{array}$$

Then the universal map $\underline{\kappa}: Q(k) \rightarrow Q(m)$ is a normal monomorphism by hypothesis. So the dinversion $\varepsilon\kappa$ of em is a normal map.

(II) \Rightarrow (III) Given a diagram as in (2.5.4), consider the construction below.

$$\begin{array}{ccccc}
 & & K & \xrightarrow{\quad \kappa \quad} & L \\
 & & \downarrow k & & \downarrow l \\
 K(\xi) & \longrightarrow & X & \xrightarrow{\quad \xi \quad} & Y \\
 \downarrow & & \downarrow \eta\xi & & \downarrow \eta \\
 0 & \longrightarrow & Z & \xlongequal{\quad} & Z
 \end{array}$$

Since the dinversion ξk of 0 is normal, we know that the universal map $K \rightarrow K(\text{coker}(\xi k))$ is a normal monomorphism. However, we know that $\eta = \text{coker}(\xi k)$ from (2.5.5) that. So, $K(\text{coker}(\xi k)) = L$, which implies the claim.

(III) \Rightarrow (I) Given a diagram as in (2.5.2), we obtain the square on the bottom right from the pushout property of the square $B \rightrightarrows R$:

$$\begin{array}{ccccc}
 A & \xrightarrow{\alpha} & B & \xrightarrow{q:=\text{coker}(\alpha)} & Q \\
 \parallel & & \downarrow \beta & \lrcorner & \downarrow \gamma \\
 A & \xrightarrow{\beta\alpha} & C & \xrightarrow{r:=\text{coker}(\beta\alpha)} & R \\
 & & \downarrow & & \downarrow t \\
 & & S & \xlongequal{\quad} & S
 \end{array}$$

The normal epimorphism r pulls back to a normal epimorphism $s: B \rightarrow K(t)$. If $k = \ker(t)$, then we find:

$$\ker(s) = \ker(ks) = \ker(r\beta) \stackrel{(2.5.3)}{=} \alpha$$

But then $q = s$, and $\gamma = k$ is a normal monomorphism. □

2.5.7 Proposition

Criteria for homological self-duality - z-Ex

In a z -exact category the following are equivalent.

- (I) Every dinversion of 0 is a normal map - **HSD**
- (II) *The Third Isomorphism Property holds* Every totally normal sequence of monomorphisms $X \triangleright \rightarrow Y \triangleright \rightarrow Z$ yields a short exact sequence $(Y/X) \triangleright \rightarrow (Z/X) \rightarrow (Z/Y)$.
- (III) *Pure Snake Condition* For every morphism of short exact sequences

$$\begin{array}{ccccc}
 A & \xrightarrow{\alpha} & B & \xrightarrow{\beta} & C \\
 \downarrow a & & \parallel & & \downarrow c \\
 X & \xrightarrow{\xi} & Y & \xrightarrow{\eta} & Z
 \end{array}$$

there is a functorial isomorphism $Q(a) \cong K(c)$.

- (IV) *Homology is self-dual* For every normal chain complex (C, d) , and every $n \in \mathbb{Z}$, $H_n^c C \cong H_n^k C$.

Proof (I) \Rightarrow (II) We know from Proposition (2.5.6) that a category is homologically self-dual if and only if it satisfies condition (2.5.6.I). That the latter condition implies (II) is a special case of Exercise 1.9.11.

(II) \Rightarrow (III) We observe that $A \xrightarrow{a} X \xrightarrow{\xi} Y$ is a totally normal sequence of monomorphisms. Thus we obtain the short exact sequence

$$Q(a) = (X/A) \triangleright \longrightarrow Q(\alpha) = (B/A) \longrightarrow Q(\xi) = (Y/X)$$

This means that $Q(a) \cong K(c)$, as required.

(III) \Rightarrow (IV) The construction of the (co)kernel homology of (C, d) in position n fits into

this pure snake diagram, which implies the claim.

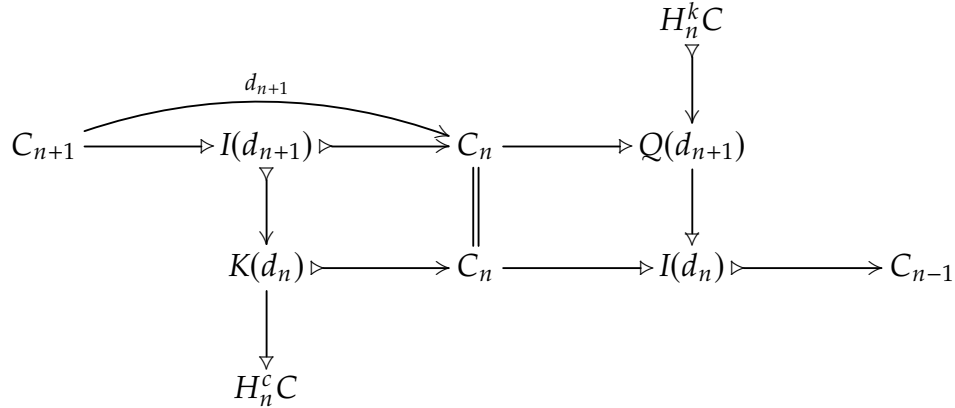

(IV) \Leftrightarrow (I) An antinormal pair (ε, μ) determines a normal chain complex C , as on the left below, if and only if $\varepsilon\mu = 0$. Construct κ and π by dinversion, then the top left square as a pullback, and the bottom right square as a pushout yields the diagram on the right.

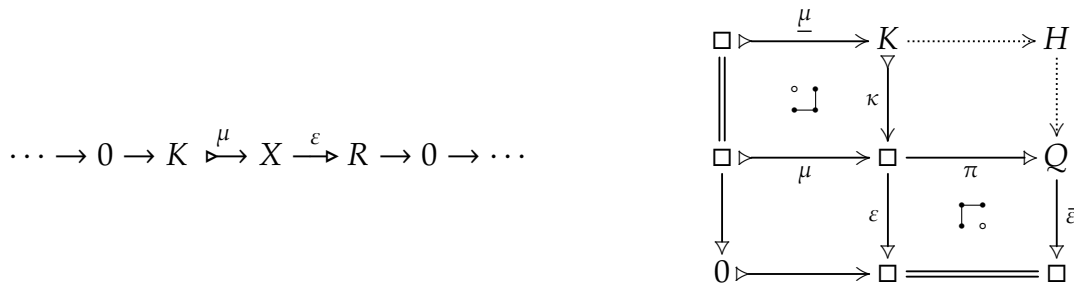

Placing X in position 0 of the chain complex C , observe the following:

1. With $\kappa = \ker(\varepsilon)$, we see that $\bar{\mu}$ is the unique factorization of μ through K . So, $Q(\bar{\mu}) = H_0^c C$ is the cokernel constructed homology of C in position X .
2. With $\pi = \text{coker}(\mu)$, we see that $\bar{\varepsilon}$ is the unique factorization of ε through Q . So, $K(\bar{\varepsilon}) = H_0^k C$ is the kernel constructed homology of C in position X .

Thus, if the antinormal pair (π, κ) composes to a normal map, then its normal factorization consists of $Q(\bar{\mu})$ and $K(\bar{\varepsilon})$. So, we obtain $H_0^c C \cong H \cong H_0^k C$.

On the other hand, if the two homology constructions are naturally isomorphic, then they provide a normal factorization of the composite $\pi\kappa$. - This completes the proof. \square

The following paraphrasing of Proposition 2.5.7 makes the relationship between homological self-duality and di-extensions explicit:

2.5.8 Proposition **Homological self-duality and the (3×3) -Lemma - z-Ex**
 For a z-exact category \mathcal{X} the following are equivalent:

- (I) \mathcal{X} is homologically self-dual.
- (II) Every dinversion of 0 is a normal map. - HSD
- (III) In every (3×3) -diagram, with a 0 in the bottom left corner, in which the rows and the left and middle column are short exact sequences

$$\begin{array}{ccccc}
 A & \xrightarrow{\alpha} & B & \xrightarrow{c} & Q \\
 \parallel & & \downarrow \beta & & \downarrow \gamma \\
 A & \xrightarrow{\beta\alpha} & C & \xrightarrow{c'} & R \\
 \downarrow & & \downarrow b & & \downarrow \\
 0 & \xrightarrow{\quad} & S & \xlongequal{\quad} & S
 \end{array}$$

it follows that the right hand column is a short exact sequence. ◇

Condition (2.5.8.III) has an equivalent sibling, obtained by mirroring the diagram over the AS-diagonal.

2.5.9 Corollary **More criteria for homological self-duality - z-Ex**
 A z-exact category is homologically self-dual if and only if any of the conditions below is satisfied.

- (VI) In a morphism of short exact sequences as in (2.5.4), the normal epimorphism ξ pulls back to a normal epimorphism κ .
- (VII) Every totally normal sequence of epimorphisms $X \twoheadrightarrow Y \twoheadrightarrow Z$ yields a short exact sequence $K(X \twoheadrightarrow Y) \twoheadrightarrow K(X \twoheadrightarrow Z) \twoheadrightarrow K(Y \twoheadrightarrow Z)$.

Proof These claims may be verified directly. Alternatively, (VI) is a paraphrasing of (2.5.6.III), and (VII) is dual to (2.5.7.II). □

2.5.10 Corollary **Cobase change of a normal epimorphism**
 In a homologically self-dual category, the pushout of a short exact sequence $K \twoheadrightarrow X \twoheadrightarrow Y$ along a normal epimorphism $h: K \twoheadrightarrow L$ whose kernel m is normal in X yields a short

exact sequence as in the diagram below.

$$\begin{array}{ccccc}
 K & \xrightarrow{k} & X & \xrightarrow{f} & Y \\
 \downarrow h & \lrcorner & \downarrow h' & & \parallel \\
 L & \xrightarrow{k'} & A & \xrightarrow{f'} & Y
 \end{array}$$

Proof The sequence $k \circ m$ is a totally normal sequence of monomorphisms. So, the claim is equivalent to (2.5.6.I). \square

2.5.11 Proposition **Homological self-duality of $\text{NM}(\mathcal{X})$, $\text{SES}(\mathcal{X})$, $\text{NE}(\mathcal{X})$ - DEx**
 For a di-exact category \mathcal{X} , the categories $\text{NM}(\mathcal{X})$, $\text{SES}(\mathcal{X})$, and $\text{NE}(\mathcal{X})$ are homologically self-dual.

Proof We know that the categories $\text{NM}(\mathcal{X})$, $\text{SES}(\mathcal{X})$, and $\text{NE}(\mathcal{X})$ are equivalent. So, it suffices to prove that $\text{NM}(\mathcal{X})$ is homologically self-dual. We verify that criterion (2.5.6.I) holds. The top four rows of the diagram below present a the situation of (2.5.2) in $\text{NM}(\mathcal{X})$. Here we used that, by Proposition 2.8.5, a short exact sequence in $\text{NM}(\mathcal{X})$ is pointwise short exact. In the di-exact category \mathcal{X} , the (3×3) -diagrams in the front and back are di-extensions, and β'' is a normal monomorphism.

$$\begin{array}{ccccccc}
 & & A & \xrightarrow{\alpha} & B & \xrightarrow{\text{coker}(\alpha)} & Q \\
 & & \parallel & \searrow \beta & \downarrow b & & \downarrow q \\
 A & \xrightarrow{\beta\alpha} & C & \xrightarrow{\text{coker}(\beta\alpha)} & R & \xrightarrow{\gamma} & Q \\
 \downarrow a & & \downarrow c & & \downarrow r & & \downarrow q' \\
 A' & \xrightarrow{\beta'\alpha'} & C' & \xrightarrow{\text{coker}(\beta'\alpha')} & R' & \xrightarrow{\gamma'} & Q' \\
 & & \parallel & \searrow \beta' & \downarrow b' & & \downarrow q'' \\
 & & A'' & \xrightarrow{\beta''} & B'' & \xrightarrow{\text{coker}(\beta'')} & Q'' \\
 & & \parallel & \searrow \beta'' & \downarrow b'' & & \downarrow q'' \\
 Q(a) & \xrightarrow{\beta''} & C'' & \xrightarrow{\text{coker}(\beta'')} & R'' & \xrightarrow{\gamma''} & Q''
 \end{array}$$

We must show that (γ, γ') is a normal monomorphism in $\text{NM}(\mathcal{X})$ or, equivalently, that the square $R \rightrightarrows Q'$ is a pullback of normal monomorphisms; see (1.8.17). To see this, note first that $\gamma, \gamma', \gamma''$ are normal monomorphisms by homological self-duality in \mathcal{X} . Then the square $R \rightrightarrows Q'$ is a pullback by Proposition 1.6.2. \square

For identifying homologically self-dual categories, the following lemma provides a useful tool. We rely on background from Section 3.1.

2.5.12 Lemma

Criterion for homological self-duality

In a z-exact regular category, if the morphism γ in diagram (2.5.2) is a monomorphism, then it is a normal monomorphism.

Proof We extend diagram (2.5.2) as follows:

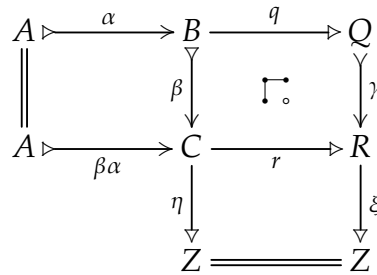

Thus $\eta: C \rightarrow Z$ and $\xi: R \rightarrow Z$ represent cokernels of β and γ , respectively. Since the top right square is a pushout, the bottom right square results via (1.6.3). We show that $\gamma = \ker(\xi)$ by checking the universal property.

Consider $x: X \rightarrow R$ such that $\xi \circ x = 0$. The normal epimorphism $\text{coker}(\beta\alpha)$ pulls back along x to a regular epimorphism \bar{c} .

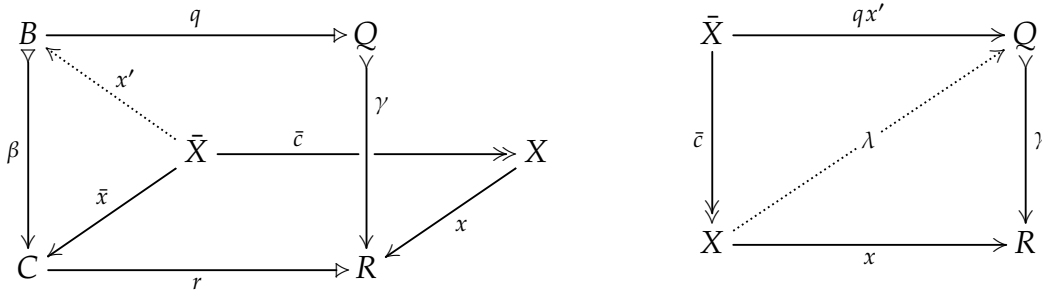

The computation $\eta\bar{x} = \xi r\bar{x} = \xi x\bar{c} = 0$ yields a map $x': \bar{X} \rightarrow B$ unique with $\bar{x} = \beta x'$. From these data, we compose the square on the right. It commutes because

$$x\bar{c} = r\bar{x} = r\beta x' = \gamma q x'.$$

The regular epimorphism \bar{c} is strong by (A.3), and so the square on the right has a unique filler λ rendering it commutative. This implies that γ is normal. \square

We close this section by showing that, in the category of commutative monoids, homology is self-dual, even though this category is not normal, as follows from (3.1.6) combined

with (1.4.6). The argument relies on an explicit computation of the kernel pair of a normal epimorphism. This computation is of independent interest; see Lemma 2.5.13.

2.5.13 Lemma Fibers of a normal epimorphism of commutative monoids

Let $f: B \rightarrow C$ be a normal epimorphism of commutative monoids, and let K be its kernel. Then the kernel pair of f consists of all pairs (b, b') for which there exist $k, k' \in K$ such that $b + k = b' + k'$.

Proof We know that the kernel pair $KP(f)$ is the least internal equivalence relation on B whose equivalence class of 0 is K .

Let $R \subseteq B \times B$ denote the set of all pairs (b, b') for which there exist $k, k' \in K$ such that $b + k = b' + k'$. For simplicity, write $b \sim b'$ whenever $(b, b') \in R$. We show first that R is an internal equivalence relation on B containing K as its zero-class. Indeed, the relation R is reflexive because, for every $b \in B$, $b + 0 = b + 0$. It is symmetric because so is $=$. To see that R is transitive, suppose $b \sim b'$ and $b' \sim b''$. Then there exist $k, k', l, l' \in K$ such that

$$b + k = b' + k' \quad \text{and} \quad b' + l' = b'' + l'' \quad \text{and so} \quad b + k + l' = b' + k' + l' = b' + l' + k' = b'' + l'' + k'$$

Finally, R is an internal relation because if $b + k = b' + k'$ and $c + l = c' + l'$, then $b + c + k + l = b' + c' + k' + l'$, which means that $(b + c) \sim (b' + c')$. By design, $(K \times \{0\}) \cup (\{0\} \times K) \subseteq R$. Furthermore, if $b \sim 0$, then $b + k = k'$ for some $k, k' \in K$, which implies that $b \in K$. Hence K is the zero-class of R . - So, $KP(f) \subseteq R$.

Next, we show that R is the *least* internal equivalence relation on B of which K is the zero-class. Let $S \subseteq B \times B$ be such an internal equivalence relation. Then, for every $k \in K$, $0Sk$ and $kS0$. So, since S is internal,

$$bS(b + k) \quad \text{and} \quad (b + k)Sb \quad \text{for every } b \in B, k \in K$$

Now, suppose $(b, b') \in R$. Then $b + k = b' + k'$ for some $k, k' \in K$. As S is reflexive: $(b + k)S(b' + k')$ and, hence,

$$bS(b + k)S(b' + k')Sb'$$

So, $(b, b') \in S$ by transitivity. Hence $R \subseteq KP(f)$. This was to be shown. □

2.5.14 Theorem CMon is homologically self-dual

The category \mathbf{CMon} of commutative monoids is homologically self-dual.

Proof We show that in diagram (2.5.2), the morphism γ is a normal monomorphism. By (2.5.12) it suffices to show that γ is monic.

Write $c := \text{coker}(\alpha)$ and $c' := \text{coker}(\beta\alpha)$. If $\gamma(q) = \gamma(q')$ for $q, q' \in Q$, choose $b, b' \in B$ with $c(b) = q$ and $c(b') = q'$. Then $c'\beta(b) = \gamma(q) = \gamma(q') = c'\beta(b')$. By (2.5.13), there are $a,$

$a' \in A$ such that

$$\beta(b + \alpha(a)) = \beta(b) + \beta\alpha(a) = \beta(b') + \beta\alpha(a') = \beta(b' + \alpha(a'))$$

Since β is monic, $b + \alpha(a) = b' + \alpha(a')$. But then

$$q = c(b) = c(b + \alpha(a)) = c(b' + \alpha(a')) = c(b') = q'$$

So, γ is monic, and the proof is complete. \square

2.5.15 Example

z-Exact but not (HSD)

The category $\text{SES}(\text{CMon})$ of short exact sequences of commutative monoids is z-exact. However, $\text{SES}(\text{CMon})$ is not homologically self dual. This follows from a counterexample constructed by F. Afsa.

2.5.16 Example

Commutative Hopf algebras are (HSD)

The category $\text{CHopf}_{\mathbb{K}}$ of commutative Hopf algebras over a field \mathbb{K} is homologically self-dual. Note that by [36] we know it is a co-protomodular category (see Section 4.10). We do, however, not know whether it is co-regular as well, so we cannot use that it is co-homological to obtain the result. We thus give a direct proof.

In (2.5.4) we write I for the cokernel of the kernel of κ ; it is the image of ξk as a morphism of vector spaces. We need to prove that the induced map $I \rightarrow L$ is an isomorphism. A direct calculation shows that the Hopf algebra I includes into Y as a normal subHopf algebra in the sense of [69, Definition 3.4.1]. In the commutative case, it thus becomes the kernel of its cokernel—see [69, Theorem 3.4.6]. This finishes the proof that (HSD) holds for commutative Hopf algebras.

For the sake of completeness, we recall that the following results which appeared in (1.11) are actually valid in any homologically self-dual category.

2.5.17 Proposition

Primordial Short 5-Lemma - HSD

Consider a morphism of short exact sequences in which b is a normal map.

$$\begin{array}{ccccc} A & \xrightarrow{k} & B & \xrightarrow{f} & C \\ \downarrow a & & \downarrow b & & \downarrow c \\ X & \xrightarrow{l} & Y & \xrightarrow{g} & Z \end{array}$$

If a and c are both monic and epic, then a, b, c are isomorphisms. \diamond

2.5.18 Proposition

Primordial 5-Lemma - HSD

Consider a morphism of exact sequences.

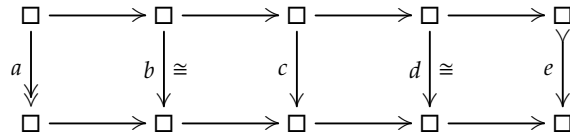

If c is a normal map, a is an epimorphism, e a monomorphism, and b, d isomorphisms, then c is an isomorphism. \diamond

Notes On Homological self-duality in a wider context

On self-duality A pointed category \mathcal{X} is homologically self-dual if and only if its opposite \mathcal{X}^{op} is homologically self-dual.

Why homologically self-dual categories only allow for a partial deployment of homological methods

From what we have seen about exactness and homology in homologically self-dual categories, we ask: To which extent can homological algebra tools and results known from abelian categories be adapted to homologically self-dual categories? - Answer: Very little beyond basic definitions and constructions. Important tools for computation, such as the full (Short) 5-Lemma, the (3×3) -Lemma, and others need not be available in every homologically self-dual category. This imposes severe limits on our capability to compute effectively. In the following sections we consider incrementally more demanding foundational axioms with the aim of being able to prove stronger results.

On examples of homologically self-dual varieties By (3.1.8), for a pointed variety of algebras to satisfy the (HSD)-condition, it suffices that each surjective algebra morphism is a cokernel. For example, in a pointed variety surjective morphisms are cokernels whenever it has a forget functor to the category Grp of groups.

Thus, in particular, normal varieties are homologically self-dual. On the other hand, there do exist varieties of algebras which satisfy the (HSD)-condition but aren't normal—the category CMon of commutative monoids is one, see (2.5.14) and (3.1.4).

Exercises

2.5.19 Exercise

Special property of (2.5.2)-diagram - z-Ex

In the morphism of short exact sequences associated to a totally normal sequence of monomorphisms (2.5.2), show that the left hand square is a pullback. Then conclude that $\alpha = \ker(\text{coker}(\beta\alpha) \circ \beta)$.

2.5.20 Exercise

Special property of (2.5.4)-diagram - z-Ex

In the morphism of short exact sequences associated to a totally normal sequence of epimorphisms (2.5.4), show that the right hand square is a pushout. Then conclude that $\eta = \text{coker}(\xi \circ \ker(\eta\xi))$.

2.5.21 Exercise

Set_{*} is homologically self-dual

Show that the category Set_{*} of pointed sets is homologically self-dual. - Hint: Recall (1.4.24).

2.5.22 Exercise

Top_{*} is homologically self-dual

Show that the category Top_{*} of based topological spaces is homologically self-dual.

With Exercise 2.5.22 we have a category which is homologically self-dual but is not regular; compare Lemma 2.5.12.

2.5.23 Exercise

Pushout property in (2.5.4)

In the situation of diagram (2.5.4) assume that κ is an epimorphism. Show that the square on the left is a pushout.

2.5.24 Exercise

Pushout recognition under homological self-duality

In a homologically self-dual category, consider a morphism of short exact sequences of the form

$$\begin{array}{ccccc} K & \longrightarrow & X & \longrightarrow & Z \\ \downarrow k & & \downarrow \xi & & \parallel \\ L & \longrightarrow & Y & \longrightarrow & Z \end{array}$$

where ξ is a normal epimorphism. Show that the map k is a normal epimorphism and that the square on the left is both a pushout and a pullback.

2.5.25 Exercise

Totally normal sequence of mono/epi morphisms - Construction - z-Ex

In a pointed category \mathcal{X} , show that an arbitrary sequence $A \xrightarrow{a} B \xrightarrow{b} C$ of morphisms yields

- (i) a totally normal sequence of monomorphisms $K(a) \hookrightarrow K(ba) \hookrightarrow A$, and
- (ii) a totally normal sequence of epimorphisms $C \twoheadrightarrow Q(ba) \twoheadrightarrow Q(b)$.

2.5.26 Exercise

Image factorization of (normal epi) \circ (normal mono) - HSD

For an antinormal pair (h, k) in a homologically self-dual category the following are equivalent:

- (I) $K(h)$ is a subobject of K .
- (II) The composite $h \circ k$ admits a normal epi / mono image factorization so that the diagram below is a pushout.

$$\begin{array}{ccc} K & \xrightarrow{h'} & L \\ \downarrow k & \lrcorner & \downarrow k' \\ X & \xrightarrow{h} & Q \end{array}$$

In this situation k' is a normal map.

2.5.27 Exercise

Normality preserved by certain pullbacks - HSD

In a homologically self-dual category, consider a morphism of short exact sequences in which c is a normal monomorphism.

$$\begin{array}{ccccc} A & \xrightarrow{\alpha} & B & \xrightarrow{\beta} & C \\ \downarrow a & \lrcorner & \downarrow b & & \downarrow c \\ X & \xrightarrow{\xi} & Y & \xrightarrow{\eta} & Z \end{array}$$

Then the square on the left is a pullback. Moreover,

- (i) if b is a normal monomorphism, then a is a normal monomorphism;
- (ii) if b is a normal epimorphism, then a is a normal epimorphism;
- (iii) if b is a normal map, then a is a normal map.

Dually:

2.5.28 Exercise

Normal maps preserved by certain pushouts - HSD

In a homologically self-dual category, consider a morphism of short exact sequences in which a is a normal epimorphism.

$$\begin{array}{ccccc}
 A & \xrightarrow{\alpha} & B & \xrightarrow{\beta} & C \\
 a \downarrow & & b \downarrow & \circlearrowleft & \downarrow c \\
 X & \xrightarrow{\xi} & Y & \xrightarrow{\eta} & Z
 \end{array}$$

Then the square on the right is a pushout. Moreover,

- (i) if b is a normal epimorphism, then c is a normal epimorphism;
- (ii) if b is a normal monomorphism, then c is a normal monomorphism;
- (iii) if b is a normal map, then c is a normal map. ◇

2.5.29 Exercise

Pullback of a short exact sequence along a normal monomorphism - HSD

Compare (2.5.10) In a homologically self-dual category, pulling back a short exact sequence $A \triangleright \rightarrow C \rightarrow R$ along a normal monomorphism $\gamma: Q \triangleright \rightarrow R$ yields a commutative diagram

$$\begin{array}{ccccc}
 A & \xrightarrow{a} & B & \xrightarrow{f} & Q \\
 \parallel & & \beta \downarrow & \circlearrowleft & \downarrow \gamma \\
 A & \xrightarrow{\alpha} & C & \xrightarrow{c} & R
 \end{array}$$

in which f is normal, and $Q(f) \cong K(Q(\beta) \rightarrow Q(\gamma))$.

2.5.30 Exercise

Pushout of a short exact sequence along a normal epimorphism - HSD

Formulate the dual of Exercise 2.5.29 and prove it.

2.5.31 Exercise

Normal map essential in Short 5-Lemma

In the category $CMon$ of commutative monoids, consider the morphism of short exact sequences.

$$\begin{array}{ccccc}
 \mathbb{N} & \xrightarrow{(1,0)} & \mathbb{N} \times \mathbb{N} & \xrightarrow{pr_2} & \mathbb{N} \\
 \parallel & & b \downarrow (+, pr_2) & \circlearrowleft & \parallel \\
 \mathbb{N} & \xrightarrow{(1,0)} & \mathbb{N} \times \mathbb{N} & \xrightarrow{pr_2} & \mathbb{N}
 \end{array}$$

The coordinate maps of b are 'addition' and 'projection onto the second coordinate'. Show that b is injective, not surjective, hence is not an isomorphism.

Then explain why this morphism of short exact sequences is not a counterexample to the primordial Short 5-Lemma (1.11.2). Conclude further that the subobject $S := \{(m, n) \mid n \geq m\} < \mathbb{N} \times \mathbb{N}$ is not a normal subobject of $\mathbb{N} \times \mathbb{N}$.

2.5.32 Exercise

Linear categories - ANK

In view of (2.5.14) and (6.2.10), determine if linear categories are homologically self-dual.

2.5.33 Exercise

Hopf algebras - ANK

Is the category of Hopf algebras over a field homologically self-dual?

2.6 Preservation of Normal Maps by Dinversion

In Section 2.1, we introduced the (DPN)-condition which requires that *dinversion preserves normal morphisms*. In (2.1.9), we explained its role in the construction of di-extensions. Here we introduce di-extensive pushouts and di-extensive pullbacks as conditions which are equivalent to the (DPN)-condition; see (2.6.1).

Then we explain how this development is related to the classical perspective of the 'border cases' of the (3×3) -Lemma. Facts surrounding the (3×3) -Lemma are well documented in existing literature. This connection enables us to identify z-exact categories which satisfy the (DPN)-condition.

Throughout, we take advantage of the fact that di-extensions exhibit notational symmetry across the axis joining the initial and the terminal corners. It cuts the number of cases that need to be considered in half.

2.6.1 Definition

Di-extensive pushout / pullback - z-Ex

A pullback of normal monomorphisms, left below, is *di-extensive* if, whenever one of γ or c is a normal monomorphism, then so is the other.

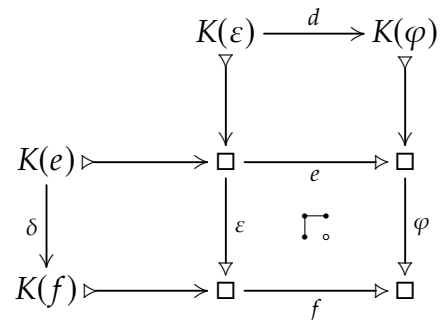
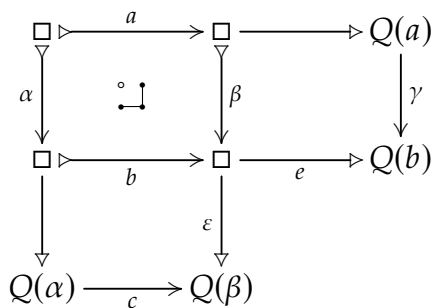

A pushout of normal epimorphisms, right above, is *di-extensive* if, whenever one of d or δ is a normal monomorphism, then so is the other.

2.6.2 Proposition **Dinversion and di-extensive pushouts / pullbacks - z-Ex**
 In a z-exact category the following are equivalent.

- (I) Pullbacks of normal monomorphisms are di-extensive.
- (II) Dinversion preserves normal maps.
- (III) Pushouts of normal epimorphisms are di-extensive.

Proof The key to observe that, whenever an antinormal composite $\varepsilon\mu$ or $\pi\kappa$ is a normal map, then (1.6.2) and (1.6.4) yield pullback and pushout squares as indicated.

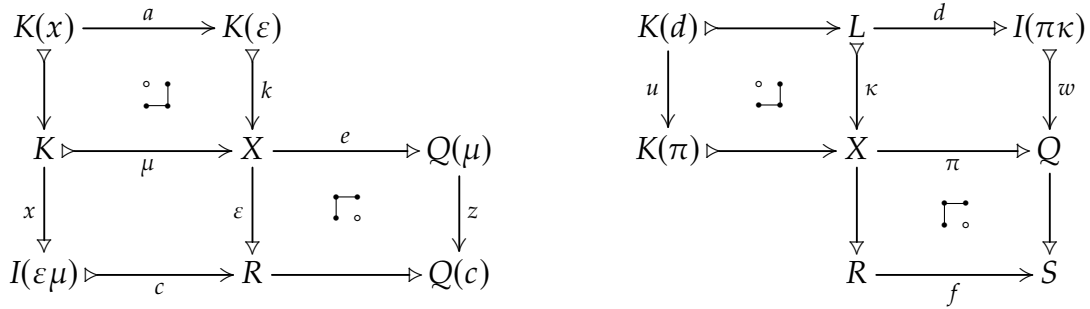

So, in the diagram on the left, a is a normal monomorphism and z is a normal epimorphism. Similarly, in the diagram on the right, u is a normal monomorphism, and f is a normal epimorphism.

(I) \Leftrightarrow (II) If $\varepsilon\mu$ is normal, we want to show that ek is normal as well. This is so because, by (I), ek factors through $\text{coker}(a)$ with a normal monomorphism.

Conversely, if in the diagram on the left in (2.6.1) the map c is a normal monomorphism, then we must show that γ is a normal monomorphism as well. By assumption $e\beta$ is a normal map. Since a is the pullback of $b = \ker(e)$ along β , we have $a = \ker(e\beta)$. So, $Q(a) = I(e\beta)$, and so γ is a normal monomorphism.

(II) \Leftrightarrow (III) The argument is dual to the one for (I) \Leftrightarrow (II). □

2.6.3 Proposition **(DPN) and border cases of the (3 × 3)-Lemma - z-Ex**
 In a z-exact category, the following are equivalent.

- (I) Dinversion preserves normal maps.
- (II) Every (3×3)-diagram in which all rows, together with the left and the middle column are short exact, is a di-extension: the right column is exact as well.

- (III) Every (3×3) -diagram in which all rows, together with the right and the middle column are short exact, is a di-extension: the left column is exact as well.
- (IV) Every (3×3) -diagram in which all columns, together with the bottom and the middle rows are short exact, is a di-extension: the top row is exact as well.
- (V) Every (3×3) -diagram in which all columns, together with the top and the middle rows are short exact, is a di-extension: the bottom row is exact as well.

Proof With Lemma 2.1.5 we see that (i) is equivalent to each of (ii), (iii), (iv), and (v). \square

We close this section by reflecting upon The Classical Snake Lemma (2.2.2). Let us say that a z -exact category \mathcal{X} satisfies the *Snake Condition* if the conclusion of the Snake Lemma holds in \mathcal{X} . Then we know already:

- ▶ The Snake Condition implies that dinversion preserves normal maps (Exercise 2.6.5).
- ▶ Di-exact categories satisfy the Snake Condition.
- ▶ Sub-di-exact categories satisfy the Snake Condition.

We observe that the Snake Condition is self-dual, as are the items listed above. In (3.3.1), we verify the validity of the Snake condition in categories in which dinversion preserves normal maps, and which also satisfy either of the non-self-dual conditions that normal monomorphisms, respectively normal epimorphisms, are closed under composition; (NE/MC).

2.6.4 Example

(HSD) but not (DPN)

The category $C\text{Mon}$ is homologically self dual. But dinversion does not preserve all of its normal maps.

Notes

Remark on the Middle Cases of the (3×3) -Lemma The nature of the ‘middle cases’ of the (3×3) -Lemma differs significantly from that of its ‘border cases’. No antinormal pair is present as initial data. Further, an additional requirement is needed: The row/column which is not known to be exact must compose to 0. As far as we know, the environment of homological categories (4.1) provides minimal practical conditions under which the middle cases of the (3×3) -Lemma hold.

Exercises

2.6.5 Exercise

Use (2.6.3) to show that in any z -exact category in which the Snake Condition holds, dinversion preserves normal maps.

Determine for which categories of topological algebras d inversion preserves normal maps.

2.7 Sub-Di-Exact Categories

In this section we discuss in more detail sub-di-exact categories (2.1.11), that is: z-exact categories satisfying the following two conditions:

- ▶ Every (co)subnormal map that admits an antinormal decomposition is normal, and
- ▶ d inversion preserves normal maps.

At first sight, this condition may look a bit esoteric. However, it is exactly the condition which is needed in the proof of the Snake Lemma we presented in Section 2.2. Further, it is also relevant in topological varieties. For example, in the category of topological groups, a map which admits an antinormal decomposition need not be a normal map. However, antinormal (co)subnormal maps are normal.

To facilitate identifying categories satisfying the two properties stated above, we reformulate them in terms of preservation of normal epi/monomorphisms under normal image factorization; see (2.7.1). For context, recall from (2.1.17) that antinormal maps are normal if and only if normal images preserve normal maps. Restricting this condition to the preservation of normal epimorphisms as well as normal monomorphisms, yields the following strictly weaker condition:

2.7.1 Definition Normal image preservation of normal epis / monos - z-Ex

In a pointed category *normal images preserve normal monomorphisms and normal epimorphisms* if every morphism of normal factorizations, as in the commutative diagram below, satisfies the following conditions:

$$\begin{array}{ccccc}
 \square & \xrightarrow{e} & \square & \xrightarrow{m} & \square \\
 f \downarrow & & \downarrow g & & \downarrow h \\
 \square & \xrightarrow{p} & \square & \xrightarrow{i} & \square
 \end{array} \tag{2.7.1}$$

If the morphisms f and h are normal monomorphisms, then g is a normal monomorphism, and if f and h are normal epimorphisms, then g is a normal epimorphism.

2.7.2 Proposition Normal images and normality of (co)subnormal maps - z-Ex

For an z-exact category \mathcal{X} the following conditions are equivalent:

(I) For each antinormal decomposition of a (co)subnormal map the construction (2.1.4) yields a di-extension.

(II) \mathcal{X} is sub-di-exact.

(III) Normal images preserve normal monomorphisms and normal epimorphisms, and dinversion preserves normal maps.

Proof (I) \Leftrightarrow (II) follows from Lemma 2.1.5, because every normal map is both subnormal and cosubnormal.

(II) \Rightarrow (III) In the diagram of Definition 2.7.1, assume that f and h are normal monomorphisms. The pullback of i and h as in the diagram below induces a factorization l of g through k .

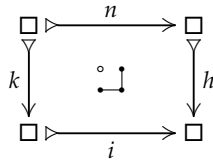

We see that l is a normal monomorphism, because so are m and n . Now $pf = kle$ is both antinormal and subnormal. So it is normal by assumption. It follows that $g = kl$ is a normal monomorphism. - The case where f and h are normal epimorphisms follows by duality.

(III) \Rightarrow (II) To see an antinormal subnormal map is normal, we relate it to diagram (2.7.1) as follows. Let pf represent the antinormal decomposition. Choose i to be the identity, and let hme represent the subnormal decomposition. Then g is a normal monomorphism because, by the assumption, normal images preserve normal monomorphisms. So, pf is a normal map. - That antinormal cosubnormal maps are normal follows by duality. \square

In light of (2.7.2), we may reformulate the di-extensive conditions formulated in (2.1.11) as follows:

2.7.3 Proposition

Paraphrasing of structural axioms

Given an z -exact category \mathcal{X} , consider the following conditions:

- (i) \mathcal{X} is *homologically self-dual*: Whenever an antinormal pair composes to the zero map, then it provides initial data for a di-extension.
- (ii) *Dinversion preserves normal maps*: whenever an antinormal pair composes to a normal map, then it provides initial data for a di-extension.
- (iii) \mathcal{X} is *sub-di-exact*: Whenever an antinormal pair in \mathcal{X} composes to a subnormal or a cosubnormal map, then it provides initial data for a di-extension.

(iv) \mathcal{X} is *di-exact*: Antinormal composites are normal maps; every antinormal pair in \mathcal{X} generates double extension.

(v) \mathcal{X} is *Puppe-exact* or *p-exact*: All maps are normal.

The implications (v) \Rightarrow (iv) \Rightarrow (iii) \Rightarrow (ii) \Rightarrow (i) hold. ◇

Notes

On the notion of p-exact categories In (2.7.3.v) we defined a category to be Puppe-exact if it is z-exact and all morphisms are normal. We should note that, equivalently, a category is Puppe-exact if it has a zero object and all morphisms are normal; see Exercise 2.7.8.

Examples of sub-di-exact categories We now explain that Axiom (2.7.3.iii) holds in the category $\text{Grp}(\text{Top})$ of topological groups. (We know that (2.7.3.iv) doesn't hold: this is related to the fact that $\text{Grp}(\text{Top})$ is not semiabelian.)

2.7.4 Proposition

Normal images of normal epis / monos in top varieties

If \mathcal{V} is a pointed variety of algebras in which normal monomorphisms (respectively, normal epimorphisms) are preserved under normal images in the sense of (2.7.1), then they are also preserved in the category $\mathcal{V}(\text{Top})$ of \mathcal{V} -algebras in Top .

Proof Suppose f and h are normal monomorphisms in $\mathcal{V}(\text{Top})$. Then we know that the unique map g is a normal monomorphism in \mathcal{V} , and we must show that it is a subspace inclusion. This is so because (a) a composite of two subspace inclusions is a subspace inclusion, and (b) the analogue of (1.5.8.iv) holds for subspace inclusions.

This argument dualizes to normal epimorphisms. Essential here is (a) a composite of two quotient maps is again a quotient map, and (b) the analogue of (1.5.9.iii) holds for quotient maps. □

Exercises

2.7.5 Exercise

Preservation of normal epis / monos in selected categories

For each of the following categories determine if normal images preserve normal epimorphisms and normal monomorphisms.

- (i) $\text{Grp}(\text{Top})$, the category of topological groups.
- (ii) Pointed topological spaces.

2.7.6 Exercise

Topological monoids and di-extension

In the category $\text{Mnd}(\text{Top})$ of topological monoids do the following:

- (i) Determine if $\text{Mnd}(\text{Top})$ is homologically self-dual.
- (ii) Determine if dinversion in $\text{Mnd}(\text{Top})$ preserves normal maps.

2.7.7 Exercise

Subtractive varieties and di-extension

For an arbitrary subtractive variety \mathcal{V} in which $x - y = 0$ implies $x = y$ do the following:

- (i) Determine if diversion in \mathcal{V} preserves normal maps.
- (ii) Determine if \mathcal{V} is sub-di-exact.

2.7.8 Exercise

Equivalent characterization of Puppe-exact categories

Show that a category is Puppe-exact in the sense of Proposition 2.7.3 if and only if it is a category with a zero object in which every morphism is a normal map.

2.8 Di-Exact Categories

In a di-exact category every antinormal map is normal; see (2.1.8). This means that, whenever a morphism f admits a decomposition $f = em$ in which m is a normal monomorphism and e a normal epimorphism, the morphism f is normal as well. In previous sections we saw that di-exact categories support setting up a foundation for the effective use of homological invariants. From (2.1.17), we already know that this condition is satisfied if and only if normal images preserve normal maps. Here, we present another recognition criterion, for this condition in terms of pullbacks or pushouts with a special property:

2.8.1 Definition

Di-extensive pullbacks / pushouts - z-Ex

A pullback of normal monomorphisms is *di-extensive* if, as on the left below, the connecting maps between their cokernels are normal monomorphisms as well.

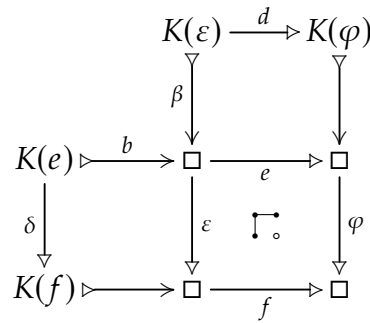
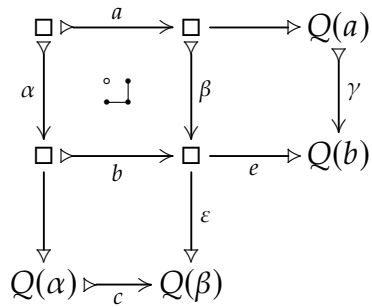

A pushout of normal epimorphisms is di-extensive if, as on the right above, the connecting maps between their kernels are normal epimorphisms as well.

Here is the motivation for introducing di-extensive pullbacks, respectively di-extensive pushouts.

2.8.2 Proposition

Di-exact categories and di-extensive pullback / pushouts - z-Ex

In a z -exact category, the following conditions are equivalent:

- (I) Pullbacks of normal monomorphisms are di-extensive.

(II) Antinormal composites are normal maps.

(III) Pushouts of normal epimorphisms are di-extensive.

Proof (I) \Leftrightarrow (III) With (2.1.5) we see that the di-extensive pullback on the left above yields a di-extension whose terminal vertex is the pushout of e and ε . Conversely, the di-extensive pushout on the right above yields a di-extension whose initial vertex is the pullback of b and β .

Further, with (2.1.7), we see that (I) \Leftrightarrow (II) \Leftrightarrow (III). □

2.8.3 Corollary

Normal mono/epi in $\text{SES}(\mathcal{X})$ - DEx

In the category $\text{SES}(\mathcal{X})$ of a di-exact category \mathcal{X} the following hold for a morphism $F = (\mu, \xi, \eta)$ of short exact sequences:

- (i) F is a normal monomorphism if and only if μ, ξ, η are normal monomorphisms in \mathcal{X} . This happens if and only if (μ, ξ) belong to a pullback square of normal monomorphisms.
- (ii) F is a normal epimorphism if and only if μ, ξ, η are normal epimorphisms in \mathcal{X} . This happens if and only if (ξ, η) belong to a pushout square of normal epimorphisms.

Proof (i) F is a normal monomorphism in $\text{SES}(\mathcal{X})$ if and only if F followed by its cokernel is a short exact sequence, hence a di-extension in $\text{SES}(\mathcal{X})$. With the analysis related to (2.1.4), we see that this happens if and only if μ, ξ, η are normal monomorphisms in \mathcal{X} . By (2.8.2), this happens if and only if (μ, ξ) belong to a pullback square of normal monomorphisms.

(ii) The proof is dual to that of (i). □

This means that in a di-exact category, the category $\text{DEx}(\mathcal{X})$ of di-extensions in \mathcal{X} is equivalent to both, the category of pushouts of normal epimorphisms in \mathcal{X} , and the category of pullbacks of normal monomorphisms in \mathcal{X} .

2.8.4 Corollary

Comparison $\text{DEx}(\mathcal{X})$ - $\text{NM}(\text{NM}(\mathcal{X}))$ - $\text{NE}(\text{NE}(\mathcal{X}))$ - DEx

Given a di-exact category \mathcal{X} , the following categories associated to \mathcal{X} are equivalent:

- (i) the category $\text{DEx}(\mathcal{X})$ of di-extensions in \mathcal{X} ;
- (ii) the category $\text{NM}(\text{NM}(\mathcal{X}))$ of normal monomorphisms in the category of normal monomorphisms in \mathcal{X} ;
- (iii) the category $\text{NE}(\text{NE}(\mathcal{X}))$ of normal epimorphisms in the category of normal epimorphisms in \mathcal{X} .

Proof The functors $m, e: [1]^2 \rightarrow [2]^2$ induce restrictions of $M: \text{DEx}(\mathcal{X}) \rightarrow \text{NM}(\text{NM}(\mathcal{X}))$ and $E: \text{DEx}(\mathcal{X}) \rightarrow \text{NE}(\text{NE}(\mathcal{X}))$. An inverse to each comes from (1.8.17), which says:

- ▶ a normal monomorphism in $\text{NM}(\mathcal{X})$ is a pullback diagram of normal monomorphisms in \mathcal{X} ; and
- ▶ a normal epimorphism in $\text{NE}(\mathcal{X})$ is a pushout diagram of normal epis in \mathcal{X} .

With (2.8.2) the claim follows. □

Since $\text{NM}(\mathcal{X}) \simeq \text{SES}(\mathcal{X}) \simeq \text{NE}(\mathcal{X})$, the category of short exact sequences in \mathcal{X} provides yet another viewpoint:

2.8.5 Proposition Antinormal composites and short exact sequences in $\text{SES}(\mathcal{X})$ - z-Ex
In a z-exact category \mathcal{X} the following conditions are equivalent:

- (I) \mathcal{X} is di-exact.
- (II) Every short exact sequence in $\text{SES}(\mathcal{X})$ is a di-extension in \mathcal{X} .
- (III) Cokernels and kernels of normal maps in any of the categories $\text{SES}(\mathcal{X})$, $\text{NE}(\mathcal{X})$, and $\text{NM}(\mathcal{X})$ are computed object-wise.

Proof (I) \Rightarrow (II) By (1.10.3), a short exact sequence in $\text{SES}(\mathcal{X})$ is given by a commutative (3×3) -diagram with the indicated features:

$$\begin{array}{ccccc}
 \square & \xrightarrow{a} & \square & \xrightarrow{d} & \square \\
 \downarrow u & \circlearrowleft & \downarrow v & & \downarrow w \\
 \square & \xrightarrow{b} & \square & \xrightarrow{e} & \square \\
 \downarrow x & & \downarrow y & \circlearrowright & \downarrow z \\
 \square & \xrightarrow{c} & \square & \xrightarrow{f} & \square
 \end{array}$$

If \mathcal{X} is di-exact, then ev is normal. Since $z = Q(ev)$, $w = \ker(z)$ is the normal mono part of the normal factorization of ev . Thus $d = Q(K(ev)) = Q(a)$ is a normal epimorphism and the top row is short exact. Similar reasoning shows that $c = \ker(f)$ renders the bottom sequence short exact. Thus the given short exact sequence in $\text{SES}(\mathcal{X})$ is a di-extension.

(I) \Rightarrow (III) A normal map $F = (\alpha, \beta, \gamma)$ in $\text{SES}(\mathcal{X})$ is a normal epimorphism $E = (\varepsilon_1, \varepsilon_2, \varepsilon_3)$, followed by a normal monomorphism $M = (\mu_1, \mu_2, \mu_3)$. If \mathcal{X} is di-exact, then we have $\ker(F) = \ker(E)$, which is computed object-wise by (2.8.3). Similarly, $\text{coker}(F) = \text{coker}(M)$ which is also computed object-wise by (2.8.3). This implies the claim for $\text{NE}(\mathcal{X})$ and for $\text{NM}(\mathcal{X})$ because the equivalences in Section 1.10 preserve and reflect limits and colimits.

(III) \Rightarrow (II) Without loss of generality, we argue based on the assumption that cokernels and kernels in $\text{SES}(\mathcal{X})$ are computed object-wise. Given a short exact sequence in $\text{SES}(\mathcal{X})$, as in the diagram above, $(d, e, f) = \text{coker}(a, b, c)$ is computed by taking object-wise cokernels. Similarly, $(a, b, c) = \text{ker}(d, e, f)$ is computed by taking object-wise kernels. Thus the short exact sequence is a di-extension.

(II) \Rightarrow (I) Given an antinormal composite yb , we show that it is a normal map using the diagram above: Let $v := \text{ker}(y)$, then construct the top left square as a pullback. Put $x := \text{coker}(u)$, and let c denote the unique factorization. Then the morphism $(a, b): u \rightarrow v$ is a normal monomorphism in $\text{NM}(\mathcal{X})$. Thus, the morphism (a, b, c) of short exact sequences is a normal monomorphism as well. Combined with its cokernel, it is a short exact sequence in $\text{SES}(\mathcal{X})$. By assumption, this is a di-extension. So, c is a normal monomorphism, and cx is the normal factorization of yb . \square

2.8.6 Corollary **Normal epis in $\text{NE}(\mathcal{X})$ and $\text{NM}(\mathcal{X})$ for di-exact \mathcal{X} - DEx**
 In a di-exact category \mathcal{X} the following hold:

- (i) In $\text{NE}(\mathcal{X})$ a map (a, b) from a normal epimorphism x to another such y is a normal epimorphism in $\text{NE}(\mathcal{X})$ if and only if (a, b) and (x, y) form a pushout square of normal epimorphisms in \mathcal{X} .
- (ii) In $\text{NM}(\mathcal{X})$ a map (r, s) from a normal monomorphism u to another such v is a normal epimorphism in $\text{NM}(\mathcal{X})$ if and only if both r and s are normal epimorphisms in \mathcal{X} . \diamond

Dually:

2.8.7 Corollary **Normal monos in $\text{NE}(\mathcal{X})$ and $\text{NM}(\mathcal{X})$ for di-exact \mathcal{X} - DEx**
 In a di-exact category \mathcal{X} the following hold:

- (i) In $\text{NM}(\mathcal{X})$ a map (a, b) from a normal monomorphism x to another such y is a normal monomorphism in $\text{NM}(\mathcal{X})$ if and only if (a, b) and (x, y) form a pullback square of normal monomorphisms in \mathcal{X} .
- (ii) In $\text{NE}(\mathcal{X})$ a map (r, s) from a normal epimorphism u to another such v is a normal monomorphism in $\text{NE}(\mathcal{X})$ if and only if both r and s are normal epimorphisms in \mathcal{X} .

Exercises

2.8.8 Exercise **Pushout of normal epimorphisms**

In a z-exact category, consider the morphism of short exact sequences below.

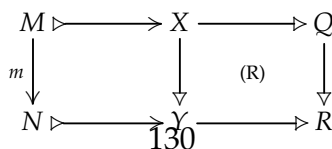

Assume that all maps in square (R) are normal epimorphisms, and that (R) is a pushout. Is the map m on the left always a normal epimorphism? - Also formulate the dual of this question, and try to answer it.

2.8.9 Exercise

Recursiveness of di-extension conditions - ANK

In \mathcal{Z} -exact category \mathcal{X} , do the following:

- (i) If \mathcal{X} is homologically self-dual, determine if $\text{SES}(\mathcal{X})$ is homologically self-dual.
- (ii) If dinverson in \mathcal{X} preserves normal maps, determine if it does so in $\text{SES}(\mathcal{X})$.
- (iii) If \mathcal{X} is di-exact, determine if $\text{SES}''(\mathcal{X})$ is di-exact.

We suspect that the answer is 'no' at least for item (iii).

2.9 Normal Pushouts and Normal Pullbacks

We introduce the concept of normal pushout and explain how it refines the notion of di-extensive pushout from Section 2.8. Dually, the notion of normal pullback refines the notion of di-extensive pullback. - Starting from a commuting square (S), we construct the pullback $P \rightrightarrows Y$ and the pushout $U \rightrightarrows Q$.

$$\begin{array}{ccc}
 \begin{array}{ccc} P & \xrightarrow{\pi_V} & V \\ \pi_X \downarrow & \circlearrowleft & \downarrow v \\ X & \xrightarrow{f} & Y \end{array} &
 \begin{array}{ccc} U & \xrightarrow{g} & V \\ u \downarrow & (S) & \downarrow v \\ X & \xrightarrow{f} & Y \end{array} &
 \begin{array}{ccc} U & \xrightarrow{g} & V \\ u \downarrow & \Gamma \circlearrowleft & \downarrow q_V \\ X & \xrightarrow{q_X} & Q \end{array}
 \end{array}$$

We then have comparison maps $(u, g): U \rightarrow P$ and $\langle f, v \rangle: Q \rightarrow Y$.

2.9.1 Definition

Seminormal/normal pushout - z-Ex

The square (S) is called

- 1. a *normal pushout*, if u, v, f, g and (u, g) are normal epimorphisms;
- 2. a *seminormal pushout*, if (u, g) and at least one of the pairs $(f$ and $g)$ or $(u$ and $v)$ are normal epimorphisms.

Dually:

2.9.2 Definition

Seminormal/normal pullback

The square (S) is called

- 1. a *normal pullback*, if u, v, f, g and $\langle f, v \rangle$ are normal monomorphisms;

2. a *seminormal pullback*, if $\langle f, v \rangle$ and at least one of the pairs $(f$ and $g)$ or $(u$ and $v)$ are normal monomorphisms.

2.9.3 Proposition Homological self-duality / seminormal pushout property - z-Ex

A z-exact category \mathcal{X} is homologically self-dual if and only if whenever in a morphism of short exact sequences

$$\begin{array}{ccccc} K & \longrightarrow & X & \longrightarrow & Q \\ \kappa \downarrow & & \xi \downarrow & & \downarrow \rho \\ L & \longrightarrow & Y & \longrightarrow & R \end{array} \quad (R)$$

the square (R) is a seminormal pushout, then κ is a normal epimorphism.

Proof Suppose \mathcal{X} is homologically self-dual. In the commutative diagram below, the bottom right square is constructed as the pullback of q along v .

$$\begin{array}{ccccccc} K & \xrightarrow{k} & X & \xrightarrow{\quad} & V & \xrightarrow{\quad} & V \\ \kappa \downarrow & \searrow \kappa & \downarrow \xi & \searrow \hat{\xi} & \downarrow \rho & \xrightarrow{\quad} & \downarrow \rho \\ L & \xrightarrow{\hat{k}} & P & \xrightarrow{\bar{r}} & V & \xrightarrow{\quad} & V \\ \parallel \swarrow & \parallel \swarrow & \parallel \swarrow & \parallel \swarrow & \parallel \swarrow & \parallel \swarrow & \parallel \swarrow \\ L & \xrightarrow{l} & X & \xrightarrow{r} & Y & \xrightarrow{\quad} & V \\ & & \downarrow \xi & & \downarrow \rho & & \downarrow \rho \end{array}$$

If the square (R) is a seminormal pushout, then the comparison map $\hat{\xi}$ is a normal epimorphism. So, \bar{r} is a normal epimorphism by (1.5.9.iii). Thus the middle row is short exact. So, κ is a normal epimorphism by the recognition criterion (2.5.9) for homologically self-dual categories.

Conversely, suppose ρ is an isomorphism and ξ a normal epimorphism. According to the recognition criterion (2.5.9) for homologically self-dual categories we need to show that κ is a normal epimorphism. To see this, construct the square $P \rightrightarrows Y$ as a pullback. So, the isomorphism ρ pulls back to the isomorphism $\bar{\rho}$. Then $\hat{\xi} = \bar{\rho}^{-1}\xi$ is a normal epimorphism. This means that the square $X \rightrightarrows R$ is a normal pushout. By hypothesis, κ is a normal epimorphism. \square

We need to confirm that a seminormal pushout actually has the universal property expected of a pushout.

2.9.4 Corollary Seminormal pushout \Rightarrow pushout - HSD

In a homologically self-dual category, every seminormal pushout is a pushout.

Proof Given a seminormal pushout square, consider the kernels of the pair of opposing normal epimorphisms, as in (2.9.3). Then k is a (normal) epimorphism. So, the square (R) is a pushout by (1.6.4). \square

2.9.5 Corollary

Normal pushout is di-extensive - HSD

In a homologically self-dual category every normal pushout square (R) is a di-extensive pushout of normal epimorphisms.

Proof The square (R) is a pushout by (2.9.4). Moreover, the induced maps between kernels of the normal epimorphisms are normal epimorphisms by (2.9.3). So, (R) is a di-extensive pushout of normal epimorphisms. \square

Dually:

2.9.6 Proposition

Homological self-duality / seminormal pullback property - z-Ex

A z -exact category \mathcal{X} is homologically self-dual if and only if, whenever in a morphism of short exact sequences the square (L) is a seminormal pullback,

$$\begin{array}{ccccc}
 K & \twoheadrightarrow & X & \longrightarrow & Q \\
 \downarrow \kappa & & \downarrow \xi & & \downarrow \rho \\
 L & \twoheadrightarrow & Y & \longrightarrow & R
 \end{array}
 \quad (L)$$

then ρ is a normal monomorphism. \diamond

2.9.7 Corollary

Seminormal pullback \Rightarrow pullback - HSD

In a homologically self-dual category, every seminormal pullback is a pullback. \diamond

2.9.8 Corollary

Normal pullback is di-extensive - HSD

In a homologically self-dual category every normal pullback square (L) is a di-extensive pullback of normal monomorphisms. \diamond

In a normal category pullbacks preserve normal epimorphisms. Because of this property, we obtain a convenient criterion for identifying seminormal pushouts. As a consequence, a pushout of normal epimorphisms is double extensive if and only if it is a normal pushout. Thus, in a normal category antinormal inversion preserves normal maps. Therefore, much of what we developed earlier in this Chapter is satisfied in normal categories.

2.9.9 Example

A non-seminormal pushout

Pick any two non-zero objects A and B in the category Grp of groups. If $i_A: A \rightarrow A + B$

is the canonical inclusion into the coproduct, then we obtain the morphism of short exact sequences whose right hand square is a pushout:

$$\begin{array}{ccccc}
 A & \xlongequal{\quad} & A & \longrightarrow & 0 \\
 \downarrow i & & \downarrow i_A & \lrcorner & \downarrow \\
 \bar{A} & \longrightarrow & A + B & \xrightarrow{\langle 0, 1_B \rangle} & B
 \end{array}$$

The comparison map of kernels is the inclusion of A into its normal closure in $A + B$, which is not a normal epimorphism. So, the pushout on the right can not be a seminormal pushout by (2.9.3).

Notes

Origin of ‘normal pushout’ Normal pushouts were preceded by regular pushouts, introduced in [19]. The more general variant of a semiregular pushout appears in [81, 3.5]. We want to work with exact sequences and with homological invariants. We introduced those concepts in z-exact categories, and we saw that normal epimorphisms and normal monomorphisms are the central concepts for our purposes. Adapting the notion of (semi)regular pushout resulted in (semi)normal pushout. - In a normal category, both concepts coincide.

Exercises

2.9.10 Exercise

Normal pullbacks in every z-exact category - z-Ex

If $\kappa: K \rightarrow X$ is a normal monomorphism, show that the pullback of κ along itself is a normal pullback.

2.9.11 Exercise

Pullback of normal monomorphisms in Set_*

Show that, in the category Set_* of pointed sets, every pullback of normal monomorphisms is a normal pullback.

2.9.12 Exercise

Pullback of normal monomorphisms of groups need not be normal

Show that, in the category Grp of groups, the pullback of two normal monomorphisms need not be a normal pullback.

2.10 Higher Extensions

To define what an n -fold extension in a \mathcal{Z} -exact category \mathcal{X} is, we adopt the following notational conventions.

For $n \geq 0$, let $[n]$ denote the category $0 \rightarrow \cdots \rightarrow n$. In particular, $[2] = 0 \rightarrow 1 \rightarrow 2$. For $k_1, \dots, k_{n-1}, t \in \{0, 1, 2\}$, define the n -tuple $d_i^n(k_1, \dots, k_{n-1}; t)$ by

$$d_i^n(k_1, \dots, k_{n-1}; t) := \begin{cases} (t, k_1, \dots, k_{n-1}) & \text{if } i = 1 \\ (k_1, \dots, k_{i-1}, t, k_i, \dots, k_{n-1}) & \text{if } 1 < i < n \\ (k_1, \dots, k_{n-1}, t) & \text{if } k = n \end{cases}$$

In a \mathcal{Z} -exact category \mathcal{X} and $n \geq 1$, an n -fold extension is a diagram E modeled on $[2]^n$ in which every sequence of the form

$$E(d_i^n(k_1, \dots, k_{n-1}; 0)) \longrightarrow E(d_i^n(k_1, \dots, k_{n-1}; 1)) \longrightarrow E(d_i^n(k_1, \dots, k_{n-1}; 2))$$

is short exact. The n -fold extensions in \mathcal{X} form the full subcategory $\text{Ex}^n(\mathcal{X})$ of the category of $[2]^n$ -diagrams in \mathcal{X} . For example, $\text{Ex}^1(\mathcal{X}) = \text{SES}(\mathcal{X})$, and $\text{Ex}^2(\mathcal{X}) = \text{DEx}(\mathcal{X})$.

Assuming that antinormal maps in \mathcal{X} are normal (2.1.11), we show how to construct n -fold extensions inductively from suitable morphisms of $(n - 1)$ -extensions. This construction may be re-interpreted as the border cases of a higher order (3×3) -Lemma.

2.10.1 Proposition

Sources of di-extensions - DEx

In a di-exact category \mathcal{X} , the following hold for a morphism $F = (\mu, \xi, \eta)$ of short exact sequences

$$\begin{array}{ccc} & & \begin{array}{ccccc} M & \xrightarrow{m} & X & \xrightarrow{q} & Q \\ \mu \downarrow & & \xi \downarrow & & \eta \downarrow \\ N & \xrightarrow{n} & Y & \xrightarrow{r} & R \end{array} \\ (\mu, \xi, \eta) \downarrow & & & & \end{array} \quad (2.10.1)$$

- (i) If each of μ, ξ, η is a normal epimorphism then the kernels of μ, ξ, η extend F to a di-extension which is functorial with respect to morphisms of such diagrams.
- (ii) If each of μ, ξ, η is a normal monomorphism then the cokernels of μ, ξ, η extend F to a di-extension which is functorial with respect to morphisms of such diagrams.

Proof Both claims follow using one of the ‘border cases’ of the (3×3) -Lemma, as in (2.6.3). We note in passing that the conclusion of this proposition holds under the weaker hypothesis of ‘dinversion preserves normal maps’, as in (2.1.5). \square

We use (2.10.1) inductively to construct n -fold extensions from $(n - 1)$ -extensions. Equivalently, we formulate versions of border cases of the (3^n) -lemma for $(n - 1)$ -fold extensions.

2.10.2 Theorem

Recursive construction of n -fold extensions - DEx

For a morphism

$$F = \{f_{\mathbf{i}} \mid \mathbf{i} = (i_1, \dots, i_n) \in \{0, 1, 2\}^n\} : X \rightarrow Y$$

of n -fold extensions the following hold:

- (i) If each $f_{\mathbf{i}}$ is a normal epimorphism, then adjoining the kernels of the $f_{\mathbf{i}}$ yields an $(n + 1)$ -fold extension.
- (ii) If each $f_{\mathbf{i}}$ is a normal monomorphism, then adjoining the cokernels of the $f_{\mathbf{i}}$ yields an $(n + 1)$ -fold extension.

Proof (i) Let K denote the $[2]^n$ -diagram constructed from the kernels of the normal epimorphisms $f_{\mathbf{i}}$. It only remains to show that each of the top sequences in the (3×3) -diagram below is short exact:

$$\begin{array}{ccccc}
 K(d_i^n(k_1, \dots, k_{n-1}; 0)) & \longrightarrow & K(d_i^n(k_1, \dots, k_{n-1}; 1)) & \longrightarrow & K(d_i^n(k_1, \dots, k_{n-1}; 2)) \\
 \Downarrow & & \Downarrow & & \Downarrow \\
 X(d_i^n(k_1, \dots, k_{n-1}; 0)) & \longrightarrow & X(d_i^n(k_1, \dots, k_{n-1}; 1)) & \longrightarrow & X(d_i^n(k_1, \dots, k_{n-1}; 2)) \\
 \Downarrow & & \Downarrow & & \Downarrow \\
 Y(d_i^n(k_1, \dots, k_{n-1}; 0)) & \longrightarrow & Y(d_i^n(k_1, \dots, k_{n-1}; 1)) & \longrightarrow & Y(d_i^n(k_1, \dots, k_{n-1}; 2))
 \end{array}$$

This, however, is the case by (2.10.1). The proof of (ii) is similar. \square

2.10.3 Corollary

3^n -lemma - DEx

Let X be a $[2]^n$ -diagram, $n \geq 2$, with sequences

$$X(d_i^n(k_1, \dots, k_{n-1}; 0)) \longrightarrow X(d_i^n(k_1, \dots, k_{n-1}; 1)) \longrightarrow X(d_i^n(k_1, \dots, k_{n-1}; 2))$$

Then the following hold:

- (i) If all of the above sequences are known to be short exact, except possibly the ones with $i = 1$, then X is an n -fold extension.
- (ii) If all of the above sequences are known to be short exact, except possibly the ones with $i = n$, then X is an n -fold extension. \diamond

2.10.4 Proposition Normality of antinormal subnormal maps is recursive w.r.t. $\text{SES}(\mathcal{X})$
 If antinormal subnormal maps \mathcal{X} are normal, then this same property holds in each of the equivalent categories $\text{NM}(\mathcal{X})$, $\text{SES}(\mathcal{X})$, and $\text{NE}(\mathcal{X})$.

Proof We prove the claim for $\text{NM}(\mathcal{X})$. A subnormal antinormal map in $\text{NM}(\mathcal{X})$ is given by this kind of commutative diagram:

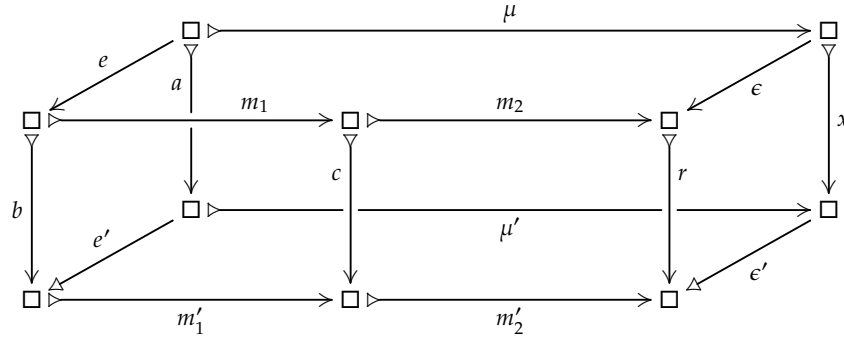

Consequently, both front squares and the back square are pullbacks of normal monomorphisms in \mathcal{X} . The left and right squares depict normal epimorphisms in $\text{NM}(\mathcal{X})$. So, e' and ϵ' are normal epic in \mathcal{X} . By the assumption on \mathcal{X} , the composite $m'_2 m'_1$ is a normal monomorphism in \mathcal{X} . Hence so is its pullback $m_2 m_1$. It follows that the front square is a pullback of normal monomorphisms in \mathcal{X} , or in other words, a normal monomorphism in $\text{NM}(\mathcal{X})$. \square

Notes On higher extensions

On weakening hypotheses to - DPN Reviewing the proof of Proposition 2.10.1, we see that normal maps in \mathcal{X} are closed under dinversion (2.1.9) if and only if all border cases of the (3×3) -Lemma hold. That is: Suppose in a (3×3) -diagram all rows and columns, except possibly for one of the four border sequences are known to be short exact, then the diagram is a di-extension.

On viewpoints of higher extensions Every n -fold extension may be viewed as a short exact sequence of $(n - 1)$ -fold extensions in n 'orthogonal' ways. Thus, we have two ways of distinguishing a higher extension in the category of short exact sequences of $(n - 1)$ -fold extensions:

- An n -fold extension is a short exact sequence in the category of $(n - 1)$ -fold extensions in all n orthogonal ways.
- An n -fold extension is a short exact sequence of $(n - 1)$ -fold extensions which forgets to a short exact sequence in the category of $(n - 1)$ -fold diagrams.

Both points of view complement each other. While the first is appealing because of its fully inductive nature, the second benefits from pointwise limits and colimits in the underlying category.

Chapter 3

Normal Categories

The term ‘normal category’ was first used by Mitchell [67, I.14] to refer to a pointed category in which every monomorphism is a normal map. In [55, Sec. 1], Z. Janelidze repurposed this term to refer to a different concept: a category which is pointed and regular, and such that regular epimorphisms and normal epimorphisms coincide. In a finitely bicomplete context, this amounts to the existence of pullback-stable normal epi/mono factorizations which, in turn, corresponds to the condition that split epimorphisms are normal, while normal epimorphisms are preserved under pullbacks. This latter characterization is what we adopt as a definition: see (3.1.1).

Leitfaden for Chapter 3

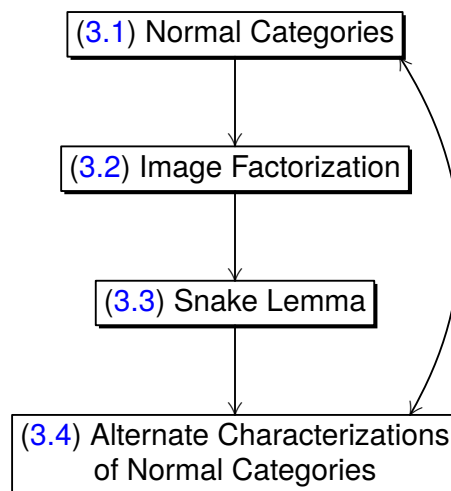

3.1 Normal Categories

In [55, Sec. 1], Z. Janelidze defined a normal category as being a pointed regular category where all regular epis are normal. Here, guided by the foundation developed earlier, we adapt his ideas as follows:

3.1.1 Definition

Normal category

A category \mathcal{X} is called *normal* if the following structural axioms are satisfied:

- ▶ *Zero object*: \mathcal{X} has a zero object; see (1.2.1).
- ▶ *Functorially finitely complete*: For every functor $F: J \rightarrow \mathcal{X}$ whose domain is a finite category J , the limit $\lim(F)$ exists; see (A.1).
- ▶ *Functorially finitely cocomplete*: For every functor $F: J \rightarrow \mathcal{X}$ whose domain is a finite category J , the colimit $\operatorname{colim}(F)$ exists; see (A.1).
- ▶ *(PNE) Pullbacks preserve normal epimorphisms*: The pullback \bar{g} of a normal epimorphism g along any morphism f in \mathcal{X} is a normal epimorphism.

$$\begin{array}{ccc}
 P & \longrightarrow & Z \\
 \bar{g} \downarrow & \circlearrowleft & \downarrow g \\
 X & \xrightarrow{f} & Y
 \end{array}$$

- ▶ *(AEN) Absolute epimorphisms are normal*: In \mathcal{X} , every absolute epimorphism is a cokernel of its kernel.

To comment on the structural axioms characterizing a normal category, we start in a finitely bicomplete pointed category. Thus every normal category is automatically *z-exact*. Via (3.2.5), the (PNE)-condition is inspired by the fact that it is satisfied in every variety of algebras in which normal and regular epimorphisms coincide.

As to the (AEN)-condition, an immediate consequence is that every sectioned epimorphism determines a special kind of short exact sequence:

3.1.2 Definition

Split short exact sequence - z-Ex

A *split short exact sequence* is given by a diagram

$$K \triangleright \xrightarrow{k} X \xleftarrow[x]{q} Q$$

where $k = \ker(q)$, $q = \operatorname{coker}(k)$ and $qx = 1_Q$.

3.1.3 Proposition **Sectioned epimorphism yields split short exact sequence - \mathbb{N}**
 An absolute epimorphism $q: X \rightarrow Q$, sectioned by $x: Q \rightarrow X$, together with any choice of a morphism $k: K \rightarrow X$ representing $\ker(q)$, yields a split short exact sequence.

Proof Via the (AEN)-condition, this is so because every absolute epimorphism is the cokernel of its kernel. \square

Further, we show in the next section that the (AEN)-condition plays a key role in establishing the existence of image factorizations. Here is an example which shows that in general, not every absolute epimorphism is a normal map.

3.1.4 Example **Addition $\mathbb{N} \times \mathbb{N} \rightarrow \mathbb{N}$**
 In the category \mathbf{Mnd} of monoids (or in the category \mathbf{CMon} of commutative monoids), consider the addition morphism together with a chosen section

$$a: \mathbb{N} \times \mathbb{N} \longrightarrow \mathbb{N}, \quad a(m, n) := m + n, \quad s(n) := (n, 0)$$

Then $k := \ker(a) = 0$. So, $a \neq \text{coker}(k)$.

We turn to developing properties of normal categories. To begin, we show that the situation of Example 3.1.4 cannot occur: a map is a monomorphism exactly when its kernel vanishes. We prove this in two steps:

3.1.5 Lemma **Monomorphism if and only if kernel is 0**
 In category with zero object assume that every map has a kernel pair, and that the (AEN)-condition holds. Then a morphism $f: X \rightarrow Y$ is a monomorphism if and only if its kernel vanishes.

Proof If f is monic, then $\ker(f) = 0$ by Proposition 1.5.6. For the converse, consider the kernel pair diagram of f :

$$\begin{array}{ccc} KP(f) & \begin{array}{c} \xrightarrow{pr_1} \\ \xleftarrow{s} \end{array} & X \\ \begin{array}{c} \uparrow s \\ \downarrow pr_2 \end{array} & \begin{array}{c} \circlearrowleft \\ \circlearrowright \end{array} & \downarrow f \\ X & \xrightarrow{f} & Y \end{array}$$

Since $K(f) = 0$, by Proposition 1.6.1 the kernels of pr_1 and pr_2 vanish as well. But these sectioned epimorphisms are normal epimorphisms by assumption. In particular (1.4.7), the morphism pr_1 is a cokernel of its kernel 0. So, it is an isomorphism. But then f is a monomorphism by (A.1.8). \square

3.1.6 Corollary

Monomorphism if and only if kernel is 0 - \mathbb{N}

In a normal category, a morphism $f: X \rightarrow Y$ is a monomorphism if and only if its kernel vanishes.

Proof One of the structural axioms of a normal category requires sectioned epimorphisms to be normal. Thus the claim follows from (3.1.5). \square

Next, we relate normal categories to the development in Chapter 2. We show that every normal category is homologically self-dual and even satisfies the (DPN)-condition; see Section 3.2. In what follows, we will refer to the notation

$$\begin{array}{ccccc}
 K & \xrightarrow{k} & X & \xrightarrow{q} & Q \\
 \kappa \downarrow & & \downarrow \xi & & \downarrow \rho \\
 (L) & & & & (R) \\
 L & \xrightarrow{l} & X & \xrightarrow{r} & R
 \end{array} \tag{3.1.7}$$

for a morphism of short exact sequences.

3.1.8 Lemma

Normal categories are homologically self-dual - \mathbb{N}

Every normal category \mathcal{X} is homologically self-dual.

Proof We use the recognition criterion (2.5.9.VI). In Diagram (3.1.7), consider the case where ρ is an isomorphism, and ξ is a normal epimorphism. We must show that κ is a normal epimorphism as well. To see this, note first that the square (L) is a pullback by (1.6.2). Via the (PNE)-condition, it pulls the normal epimorphism ξ back to the normal epimorphism κ . So, \mathcal{X} is homologically self-dual. \square

Among the normal categories, we find certain subtractive varieties:

3.1.9 Definition

Subtractive variety

A pointed variety is said to be *subtractive* if it has a binary operation ‘ $-$ ’ which satisfies $x - x = 0$ and $x - 0 = x$.

We adopted the terminology ‘subtractive variety’ from [55]. Alternatively, one may conceptualize such a variety as consisting of left unital magmas satisfying $x^2 = 1$ for all x . For example, every pointed variety whose algebras have an underlying group or loop structure is subtractive. In a group, define $x - y := xy^{-1}$. In a loop define $x - y := x/y$ where $/$ is the division on the right.

The following result presents a sufficient condition for a subtractive variety to be a normal category.

3.1.10 Proposition

Condition for subtractive variety to be normal category

Any subtractive variety in which $x - y = 0$ implies $x = y$ is a normal category.

Proof If $f: X \rightarrow Y$ is a regular epimorphism, given as the coequalizer of $r_1, r_2: R \rightarrow X$, then f is a cokernel of its kernel $\kappa: K(f) \rightarrow X$. If $g: X \rightarrow Z$ satisfies $g\kappa = 0$, we claim that $gr_1 = gr_2$. Indeed, for each $x \in R$, we have $f(r_1(x)) = f(r_2(x))$ so that $f(r_1(x) - r_2(x)) = 0$ and $(r_1(x) - r_2(x)) \in K(f)$. Then $g(r_1(x) - r_2(x)) = 0$, and so $g(r_1(x)) = g(r_2(x))$ as claimed. This implies that g factors uniquely through the coequalizer f of r_1 and r_2 . So, f is a normal epimorphism and the (PNE)-condition is satisfied.

Finally, in a finitely complete category, absolute epimorphisms are regular. So, what we just proved also implies that the (AEN)-condition is satisfied. \square

Thus all varieties of groups are subtractive and, hence, normal. More generally, a pointed variety which has a group structure amongst its operations is subtractive.

In a loop, $x/y = 1$ implies $y = 1 \cdot y = (x/y) \cdot y = x$ so the variety of loops is a normal category as well.

3.2 Image Factorization

In Section 1.8, we showed that, in a z -exact category, every morphism f may be factored in a universal way as $f = ve$, with v a normal epimorphism. We called this the normal-epi factorization of f , and know that it may be constructed thus:

$$K(f) \xrightarrow{k} X \begin{array}{c} \xrightarrow{e} \\ \xrightarrow{f} \\ \xrightarrow{v} \end{array} Q(\kappa) = I \xrightarrow{v} Y. \quad (3.2.1)$$

In this diagram $k = \ker(f)$, and $e = \text{coker}(k)$.

We will show that, in a normal category, the map v in the normal epi-factorization of f is always a monomorphism. This means that every map f has an image factorization; see (1.8.8). So, when working in a normal category, we use the terms ‘normal epi factorization’ and ‘image factorization’ interchangeably.

As an application, we show that in a normal category, normal, regular, effective, strong, and extremal epimorphisms coincide. This enables us to interpret image factorizations within the framework of orthogonal factorization systems; see (3.2.12).

We turn to developing auxiliary results which we use to show that, in a homological category, every morphism admits an image factorization.

3.2.2 Lemma **f factors through $Q(\ker(f))$ via map with trivial kernel - \mathbb{N}**
 In the factorization diagram 3.2.1, the kernel $K(v)$ of v is 0.

Proof Via the universal properties of kernels and cokernels the morphism f yields the commutative diagram below.

$$\begin{array}{ccccc}
 K(f) & \xrightarrow{k} & X & \xrightarrow{f} & Y \\
 \bar{e} \downarrow & & \downarrow e & & \parallel \\
 K(v) & \xrightarrow{k'} & I & \xrightarrow{v} & Y
 \end{array}$$

As the diagram commutes,

$$k'\bar{e} = ek = 0 = 0\bar{e}$$

With Proposition 1.6.2 we see that the left hand square is a pullback. Via the (PNE)-property, it preserves the normal epimorphism e ; i.e., \bar{e} is a normal epimorphism. Hence from the calculation above, it follows that $k' = 0$. \square

3.2.3 Corollary **Existence of image factorizations - \mathbb{N}**

In a normal category, in the normal epi-factorization $f = ev$ of a morphism f , the map v is a monomorphism.

Proof From (3.2.2), we know that $K(v) = 0$. Then (3.1.6) tells us that v is a monomorphism. \square

This means that the normal epi-factorization of f is an image factorization. - We turn to comparing various types of epimorphisms in a normal category.

3.2.4 Corollary **Extremal epimorphism is normal - \mathbb{N}**

In a normal category, every extremal epimorphism is a normal epimorphism.

Proof If $f: X \rightarrow Y$ is an extremal epimorphism, consider the image factorization (3.2.3) of f through the cokernel of $k = \ker(f)$:

$$\begin{array}{ccccc}
 & & & & Q(k) \\
 & & & \nearrow e & \downarrow m \\
 K(f) & \xrightarrow{k} & X & \xrightarrow{f} & Y
 \end{array}$$

As f is an extremal epimorphism, m is an isomorphism. So f , along with e , is a normal epimorphism. \square

We can now establish the equivalence of certain types of epimorphism in normal categories displayed in Figure A.1.

3.2.5 Corollary **Equivalence of various epimorphisms - N**
 For any morphism $f: X \rightarrow Y$, the following conditions are equivalent:

- (I) f is a normal epimorphism.
- (II) f is a regular epimorphism.
- (III) f is an effective epimorphism.
- (IV) f is a strong epimorphism.
- (V) f is an extremal epimorphism.

Proof In a category with finite limits, we have (I) \Rightarrow (II) \Leftrightarrow (III), and (II) \Rightarrow (IV) \Rightarrow (V). The implication (V) \Rightarrow (I) from (3.2.4) completes the proof. \square

3.2.6 Proposition **Pullbacks preserve image factorizations and normal maps - N**
 Pull the map u back along a map f so as to obtain the map \bar{u} :

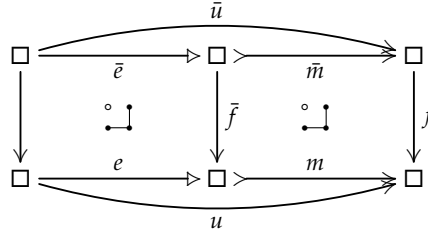

If $u = me$ is an image factorization of u , then an image factorization of \bar{u} is given by $\bar{u} = \bar{m}\bar{e}$, where \bar{m} is the pullback of m along f and \bar{e} is the pullback of e along \bar{f} . Further, if m is a normal monomorphism then \bar{m} is a normal monomorphism as well.

Proof The map f pulls the monomorphism m back to the monomorphism \bar{m} by (A.1.12). Then \bar{f} pulls the normal epimorphism e axiomatically back to the normal epimorphism \bar{e} . Finally, the concatenation of these two pullbacks is again a pullback by (A.1.6). Thus $\bar{m} \circ \bar{e}$ is the image factorization of the pullback \bar{u} of u along f . Finally, if m happens to be a normal monomorphism, then \bar{m} is a normal monomorphism as well by (1.5.8). \square

As a consequence, we see that, in a normal category, normal epimorphisms enjoy the following properties:

3.2.7 Proposition

Properties of normal epimorphisms - N

For morphisms $f: X \rightarrow Y$, $g: Y \rightarrow Z$, and $f': X' \rightarrow Y'$ in a normal category, the following hold.

- (i) If $g \circ f$ is a normal epimorphism, then so is g .
- (ii) If f and g are normal epimorphisms, then so is $g \circ f$.
- (iii) If f and f' are normal epimorphisms, then so is $f \times f'$.

Proof We use the fact (3.2.5) that, under the stated hypotheses, normal epimorphisms, strong epimorphisms and extremal epimorphisms are equivalent concepts. In situation (i) it therefore suffices to show that g is a extremal epimorphism. Consider a factorization of g through a subobject m of Z :

$$\begin{array}{ccccc}
 & & & & M \\
 & & & \nearrow \gamma & \downarrow m \\
 X & \xrightarrow{f} & Y & \xrightarrow{g} & Z
 \end{array}$$

Then $\gamma \circ f$ is a factorization of the extremal epimorphism $g \circ f$ through m . So m is an isomorphism, implying that g is an extremal epimorphism.

(ii) It suffices to show that a composite of strong epimorphisms is a strong epimorphism. This is the content of (A.3.14).

(iii) We use that normal epimorphisms are pullback-stable to see that in the two pullback squares

$$\begin{array}{ccc}
 X \times X' & \xrightarrow{1_X \times f'} & X \times Y' \\
 \pi_{X'} \downarrow & & \downarrow \pi_{Y'} \\
 X' & \xrightarrow{f'} & Y'
 \end{array}
 \qquad
 \begin{array}{ccc}
 X \times Y' & \xrightarrow{f \times 1_{Y'}} & Y \times Y' \\
 \pi_X \downarrow & & \downarrow \pi_Y \\
 X & \xrightarrow{f} & Y
 \end{array}$$

the top horizontal arrows are normal epimorphisms. The result now follows from (ii), because $f \times f' = (f \times 1_Y) \circ (1_X \times f')$. □

3.2.8 Corollary

Product of short exact sequences - N

If the sequences $K \xrightarrow{k} X \xrightarrow{q} Q$ and $L \xrightarrow{l} Y \xrightarrow{r} R$ are short exact, then so is the sequence

$$K \times L \xrightarrow{k \times l} X \times Y \xrightarrow{q \times r} Q \times R$$

Proof We know from (3.2.7) that the product $q \times r$ of the normal epimorphisms q and r is again a normal epimorphism. So $q \times r$ is the cokernel of its kernel, by (1.4.7). However, $\ker(q \times r) = \ker(q) \times \ker(r) = k \times l$ because limits commute with limits. This proves that a product of two short exact sequences is short exact. \square

3.2.9 Corollary **Cobase change preserves extremal epimorphisms - \mathbb{N}**
 Pushouts along any map preserve regular/strong/extremal epimorphisms.

Proof From (1.5.4) we know that cobase change preserves normal epimorphisms. From (3.2.5) we know that in a normal category the concepts of normal epimorphism and regular / strong / extremal epimorphism coincide. \square

3.2.10 Corollary **Recognizing normal epi via jointly extremal epis - \mathbb{N}**
 In the diagram below, if the maps λ and u are jointly extremally epimorphic, then v is a normal epimorphism.

$$\begin{array}{ccccc}
 K & \xrightarrow{\kappa} & U & \xrightarrow{\text{coker}(\kappa)} & V \\
 \downarrow k & & \downarrow u & & \downarrow v \\
 L & \xrightarrow{\lambda} & X & \xrightarrow{\text{coker}(\lambda)} & Y
 \end{array}$$

Proof It follows from the hypotheses that $\text{coker}(\lambda) \circ \lambda = 0$ and $\text{coker}(\lambda) \circ u$ are jointly extremally epimorphic. So, $\text{coker}(\lambda) \circ u = v \circ \text{coker}(\kappa)$ is an extremal epimorphism. Hence, by (3.2.5), it is a normal epimorphism. By (1.5.9.i), v is a normal epimorphism. \square

3.2.11 Proposition **Image factorization of morphism out of a binary sum - \mathbb{N}**
 For any two morphisms $f: X \rightarrow Z$ and $g: Y \rightarrow Z$:

$$I(f) \vee I(g) = I(\langle f, g \rangle: X + Y \rightarrow Z)$$

Proof Consider the commutative diagram below:

$$\begin{array}{ccccc}
 & & X + Y & & \\
 & \nearrow i_X & \downarrow & \nwarrow i_Y & \\
 & & S & & \\
 & \nearrow & \downarrow & \nwarrow & \\
 X & \xrightarrow{I(f)} & I(\langle f, g \rangle) & \xleftarrow{I(g)} & Y
 \end{array}$$

The claim follows via (A.3.16) once we have shown that the canonical inclusions of $I(f)$ and $I(g)$ in $I(\langle f, g \rangle)$ are jointly extremally epimorphic. Indeed, given a subobject S of $I(\langle f, g \rangle)$

which contains $I(f)$ and $I(g)$ as subobjects, the normal epimorphism $X + Y \rightarrow I(\langle f, g \rangle)$ factors through S . With (3.2.7) it follows that the monomorphism $S \rightarrow I(\langle f, g \rangle)$ is a normal epimorphism as well and, hence (1.5.7), an isomorphism. - This implies the claim. \square

Notes

Existence of image factorizations and orthogonal factorization systems The existence of a normal epi/mono factorization for *every* morphism has a direct tie to the theory of orthogonal prefactorization systems; see Appendix A.4. Beginning with the class \mathcal{M} of monomorphism in a category \mathcal{C} , one obtains the class \mathcal{E} of strong epimorphisms as its left orthogonal complement. In a normal category strong epimorphisms are normal. Here, then, is a reformulation of what we found earlier in this section.

3.2.12 Theorem

OFS from normal epi/mono factorizations - N

We let \mathcal{E} be the class of normal epimorphisms, and \mathcal{M} the class of monomorphisms. Then

- (i) every morphism $f: X \rightarrow Y$ in \mathcal{C} admits a factorization as $f = me$, where $m \in \mathcal{M}$ and $e \in \mathcal{E}$;
- (ii) \mathcal{E} and \mathcal{M} are each other's *orthogonal complement*: given any commutative square

$$\begin{array}{ccc} A & \xrightarrow{u} & U \\ e \downarrow & \nearrow \varphi & \downarrow m \\ B & \xrightarrow{v} & V \end{array}$$

- (a) $e \in \mathcal{E}$ if and only if for every $m \in \mathcal{M}$, a unique filler φ exists, while
- (b) $m \in \mathcal{M}$ if and only if for every $e \in \mathcal{E}$, a unique filler φ exists.

Proof In Lemma 3.2.2 we show that $K(m) = 0$ and, with (3.1.6), we infer that m is a monomorphism. Since by definition (A.3.4), strong epimorphisms satisfy (a) and one of the implications in (b), it remains to show that every strong epimorphism is a normal epimorphism, and that these satisfy the other implication in (b). The first claim holds because every strong epimorphism is extremal and in a normal category, every extremal epimorphism is a normal epimorphism; see (3.2.4). The second claim uses the factorization: suppose m is such that for every $e \in \mathcal{E}$, the diagram admits a unique filler φ . We may factor $m = ip$ where $m \in \mathcal{M}$ and $p \in \mathcal{E}$. Then a filler φ exists for the square $m1_U = ip$, which shows that p is an isomorphism, and thus m is a monomorphism, because so is i . \square

Exercises

3.2.13 Exercise

$Q(f) = 0$ does not imply f is an epimorphism

Find an example of a morphism $f: X \rightarrow Y$ in a normal category where $Q(f) = 0$, but f is not an epimorphism.

3.2.14 Exercise

$v \circ u$ normal monomorphism does not imply that u is normal

Find an example of a normal category in which there exists a composite vu which is a normal monomorphism but u is not a normal monomorphism; compare (3.2.7) and recall (1.5.8.iv).

3.3 The Snake Lemma

The following proof of the Snake Lemma is inspired by the proof of the Snake Lemma in [10]. It is valid in normal categories satisfying the condition (DPN). It is independent of the (ANN)-condition which forms the basis of the proof given in (2.2.2).

3.3.1 Theorem

Classical Snake Lemma - N + DPN

In a normal category satisfying the (DPN)-condition, suppose the maps κ , ξ and ρ in the following morphism of short exact sequences are normal.

$$\begin{array}{ccccc}
 K & \xrightarrow{k} & X & \xrightarrow{q} & Q \\
 \kappa \downarrow & & \xi \downarrow & & \rho \downarrow \\
 L & \xrightarrow{l} & Y & \xrightarrow{r} & R
 \end{array}$$

Then the kernels and cokernels of κ , ξ , ρ form a six-term exact sequence

$$0 \longrightarrow K(\kappa) \xrightarrow{k^*} K(\xi) \xrightarrow{q^*} K(\rho) \xrightarrow{\partial} Q(\kappa) \xrightarrow{l_*} Q(\xi) \xrightarrow{r_*} Q(\rho) \longrightarrow 0$$

This six-term exact sequence depends functorially on morphisms of the underlying diagrams of short exact sequences.

Proof We construct the diagram below starting from the two columns on the right.

$$\begin{array}{ccccccc}
 K(\kappa) & \xrightarrow{k^*} & K(\xi) & \xlongequal{\quad} & K(\xi) & \xrightarrow{q^*} & K(\rho) \\
 \downarrow & \circlearrowleft & \downarrow & & \downarrow & & \downarrow \\
 K & \xrightarrow{\quad} & K(e) & \xrightarrow{\quad} & X & \xrightarrow{q} & Q \\
 \downarrow & \searrow & \downarrow & \square & \downarrow & \searrow & \downarrow \\
 \kappa & \searrow & I(\kappa) & \xrightarrow{\quad} & K(\eta) & \xrightarrow{\quad} & I(\xi) & \xrightarrow{\eta} & I(\rho) \\
 \downarrow & \searrow & \downarrow & \searrow & \downarrow & \searrow & \downarrow & \searrow & \downarrow \\
 L & \xlongequal{\quad} & L & \xrightarrow{\quad} & Y & \xrightarrow{\quad} & R \\
 \downarrow & & \downarrow & & \downarrow & & \downarrow \\
 Q(\kappa) & \xrightarrow{\quad} & K(r_*) & \xrightarrow{\quad} & Q(\xi) & \xrightarrow{r_*} & Q(\rho)
 \end{array}$$

l_*

The map e is a normal epimorphism, being a composite of two such. So, η is a normal epimorphism as well. Via the (HSD)-property (3.1.8), the morphism of short exact sequences

$$(K(e) \rightarrow K(\eta), X \rightarrow I(\xi), I(\rho) = I(\rho))$$

yields the bi-cartesian square $K(e) \rightrightarrows I(\xi)$ in the middle and the identity $K(b) = K(b)$ in the upper row.

From the morphism of short exact sequences $(K(\eta) \rightarrow L, I(\xi) \rightrightarrows Y, I(\rho) \rightarrow R)$, we see that the square $K(\eta) \rightrightarrows Y$ is a pullback. With the (DPN)-condition we obtain the di-extension whose middle object is Y ; see (2.1.9).

The map $I(\kappa) \rightrightarrows L$ factors through $K(\eta)$ via a normal monomorphism. The Pure Snake Lemma (2.5.7) yields a functorial isomorphism

$$S := Q(I(\kappa) \rightarrow K(\eta)) \cong K(Q(\kappa) \rightarrow K(r_*)) = K(l_*)$$

The upper-left part of the diagram extends to the following di-extension.

$$\begin{array}{ccccc}
 K(\kappa) & \xrightarrow{k^*} & K(l) & \longrightarrow & J \\
 \downarrow & & \downarrow & \searrow q^* & \downarrow \\
 K & \longrightarrow & K(e) & \longrightarrow & K(\rho) \\
 \downarrow & & \downarrow & & \downarrow \\
 I(\kappa) & \longrightarrow & K(\eta) & \longrightarrow & S
 \end{array}$$

The bottom short exact sequence has been constructed above. The horizontal short exact sequence in the middle comes from homological self-duality:

$$\begin{array}{ccccc}
 K & \longrightarrow & K(e) & \longrightarrow & K(\rho) \\
 \parallel & & \downarrow & & \downarrow \\
 K & \longrightarrow & X & \longrightarrow & Q \\
 & & \downarrow e & & \downarrow \\
 & & I(\rho) & \xlongequal{\quad} & I(\rho)
 \end{array}$$

We have $k^* = \ker(q^*)$ because kernels commute with kernels. So, q^* admits an antinormal decomposition. Given that its di-inverse is the normal map $K \rightarrow K(\eta)$, q^* is normal as well. Assembling the available information, we compute:

$$Q(q^*) \cong Q(J \rightrightarrows K(\rho)) \cong S \cong K(l_*)$$

This yields the required 6-term exact sequence. It is functorial because we assume that kernels and cokernels are functorial. \square

3.3.2 Remark

Snake when normal monos are closed under composition

An analysis of the proof of (3.3.1) shows that it is valid in z -exact categories which enjoy the (DPN)-property, and in which *normal epimorphisms* are closed under composition. Therefore, dual reasoning shows that the Classical Snake Lemma is valid in z -exact categories which enjoy the (DPN)-property, and in which *normal monomorphisms* are closed under composition.

The Relaxed Snake Lemma (2.2.4) is also valid under the assumptions stated in (3.3.1).

Exercises

3.3.3 Exercise

Classical Snake vs. border cases of (3×3) -Lemma - z -Ex

In a z -exact category assume that normal monomorphisms are closed under composition or that normal epimorphisms are closed under composition. Show that the Classical Snake Lemma holds if and only if the border cases of the (3×3) -Lemma (2.6.3) hold.

3.4 Alternate Characterizations of Normal Categories

We compare the concept of a normal category, as defined in Section 3.1 with the concept of a normal category as defined by Z. Janelidze in [55, Sec. 1]. To express the distinction, we call a category Z . *Janelidze-normal* if it is pointed, regular, and regular epimorphisms are normal epimorphisms. In (3.4.2), we show that a finitely cocomplete Z . Janelidze-normal category is the same thing as a normal category from (3.1).

In (3.4.3) we show that the (DPN)-condition is satisfied in all normal subtractive varieties [55], i.e., in any subtractive variety where all surjective algebra maps are normal epimorphisms, see (3.1.1). By (3.1.10), every pointed variety with a binary operation $'-'$ such that $x - x = 0$ and $x - 0 = x$, and where $x - y = 0$ implies $x = y$ is normal subtractive.

As it turns out, in a normal context, the condition (DPN) is characteristic of subtractivity: we proceed by showing that a normal category satisfies (DPN) if and only if it is *subtractive* in a suitable, purely categorical sense [55]. We approach this concept by means of the *difference object* $D(X)$, which is the kernel $\delta_X: D(X) \rightarrow X + X$ of the codiagonal map $\nabla_X: X + X \rightarrow X$. The difference object enables us to define the *formal difference* of two morphisms $f, g: X \rightarrow Y$ as the composite $f - g = \langle f, g \rangle \circ \delta_X: D(X) \rightarrow Y$. In (3.4.10), we show that the formal difference behaves well with respect to composition. In (3.4.11), we characterize normal categories by means of the formal difference. In (3.4.14), we show that any normal category in which the (DPN)-property holds is subtractive. Conversely, in (3.4.15), we show that a normal subtractive category satisfies the (DPN)-property.

From the perspective of categorical algebra, Axiom (PNE) of (3.1.1) is at the core of the

concept of a *regular* category, introduced in [4]; see (A.4.11). In the presence of the other axioms characterizing a normal category, it implies that regular epimorphisms are stable under pullbacks.

3.4.1 Definition

Z. Janelidze-normal category

[54] A Z. Janelidze-normal category is a regular category with a zero object in which every regular epimorphism is a normal epimorphism.

In a Janelidze-normal category the (PNE)-condition is satisfied, because normal epimorphisms and regular epimorphisms coincide.

3.4.2 Theorem

Characterization of normal categories

For a pointed category \mathcal{X} , the following are equivalent:

- (I) \mathcal{X} is a normal category, as per Definition 3.1.1.
- (II) \mathcal{X} is finitely cocomplete and Z. Janelidze-normal.

Proof Suppose \mathcal{X} is normal. In \mathcal{X} , normal epimorphisms and regular epimorphisms coincide by Corollary 3.2.5. Then every morphism has an image factorization by Corollary 3.2.3. By (3.2.6), such an image factorization is preserved by pullbacks because of the (PNE)-condition. So, \mathcal{X} is Z. Janelidze-normal.

Conversely, it only remains to show that the (AEN)-condition is satisfied. This is so because an absolute epimorphism is always a regular epimorphism. \square

We are now ready to characterize normal categories satisfying the (DPN)-condition by means of a categorical version of the subtractivity condition. We first consider the varietal case, because as we shall see, the proof there can be mimicked in a purely categorical setting.

3.4.3 Proposition

Subtractive varieties and diversion of normal maps

In a normal subtractive variety, diversion preserves normal maps.

Proof We show that condition (II) of Proposition 2.6.3 holds. We use the notation of (2.1.1). First, we see that the bottom right square is a pushout by (1.6.4). So, z is a normal epimorphism, and it remains to show that w is the kernel of z .

To see this, note first that $zw = 0$; i.e., the set image of w is contained in $K(z)$. Now let $q \in Q$ such that $z(q) = 0$. Pick $x \in X$ with $e(x) = q$. Then $f(y(x)) = z(e(x)) = z(w) = 0$. So, there is $j \in J$ with $c(j) = y(x)$. Pick $k \in K$ such that $x(k) = j$. Then y sends $x - b(k)$ to $0 \in R$. So, there is $l \in L$ with $v(l) = x - b(k)$. Now $w(d(l)) = e(x - b(k)) = q$.

So, every element of $K(z)$ belongs to the set image of w . Thus, the argument is complete once we show that w is injective or, equivalently, $K(w) = 0$. In this last step, it is essential that a subtractive category is a normal category. So monomorphisms are exactly those maps whose kernel vanishes; see (3.1.6).

Take $i \in I$ with $w(i) = 0$. Let $l \in L$ with $d(l) = i$. Then $e(v(l)) = 0$ so that $k \in K$ exists with $b(k) = v(l)$. Now $x(k)$ is zero because c is a monomorphism and $y(b(k)) = y(v(l)) = 0$. Which gives us $m \in M$ with $u(m) = k$. Now $a(m) = l$ since v is a monomorphism and $v(a(m)) = b(u(m)) = b(k) = v(l)$. Hence $i = d(l) = d(a(m)) = 0$. \square

Given an object X in a normal category \mathcal{X} , the codiagonal map $\nabla_X := \langle 1_X, 1_X \rangle: X + X \rightarrow X$ is sectioned by the structure maps $i_1, i_2: X \rightarrow X + X$. Thus ∇_X is an absolute, hence normal, epimorphism which gives rise to the sectioned short exact sequence

$$D(X) \begin{array}{c} \longleftarrow \\ \xrightarrow{\delta_X} \end{array} X + X \begin{array}{c} \xleftarrow{\nabla_X} \\ \xrightarrow{i_1} \end{array} X$$

Using functorial (co)limits, we obtain a functor $D: \mathcal{X} \rightarrow \mathcal{X}$.

3.4.4 Definition

Difference object - \mathbb{N}

Given an object X in a normal category, the associated *difference object* is $D(X)$.

3.4.5 Example

Difference objects in Ab

In the category Ab, the coproduct $X + X$ is the biproduct $X \oplus X$, so that the kernel δ_X is represented by the map $(1_X, -1_X): X \rightarrow X \oplus X$. Hence the functor D is naturally equivalent to the identity functor on Ab.

3.4.6 Example

Difference objects in Grp

Given an element x of a group X , we write $\bar{x} := i_1(x) \in X + X$ and $\underline{x} := i_2(x) \in X + X$ for the images of x in the respective summands of $X + X$. Then the difference group $D(X)$ is the normal subgroup generated by elements of the shapes

$$\bar{x}\underline{x}^{-1} \quad \text{and} \quad \underline{x}(\bar{x})^{-1}, \quad x \in X$$

Proof An arbitrary element w of $X + X$ may be written as $w = \bar{x}_1 \underline{y}_1 \cdots \bar{x}_n \underline{y}_n$. We argue by induction. If $n = 1$, then $\nabla_X(w) = 1$ if and only if $y_1 = x_1^{-1}$. So, assume the claim is true for $1 \leq n - 1$. We notice that $\nabla_X(w) = 1$ if and only if $\nabla_X(\bar{x}_1^{-1} w \underline{x}_1) = 1$. Then, we

compute:

$$\begin{aligned}
1 &= \nabla_X \left(\underline{x_1}^{-1} \left[\overline{x_1 y_1} \cdots \overline{x_n y_n} \right] \underline{x_1} \right) \\
\Leftrightarrow 1 &= \nabla_X \left((\underline{x_1}^{-1} \overline{x_1}) \left[\underline{y_1} \overline{x_2 y_2} \cdots \overline{x_n y_n} \underline{x_1} \right] \right) \\
\Leftrightarrow 1 &= \nabla_X \left((\underline{x_1}^{-1} \overline{x_1}) \right) \nabla_X \left(\underline{y_1} \overline{x_2 y_2} \cdots \overline{x_n y_n} \underline{x_1} \right) \\
\Leftrightarrow 1 &= \nabla_X \left(\underline{y_1} \left[\overline{x_2 y_2} \cdots \overline{x_n y_n x_1 y_1} \right] \underline{y_1}^{-1} \right) \\
\Leftrightarrow 1 &= \nabla_X \left[\overline{x_2 y_2} \cdots \overline{x_n} \left(\underline{y_n x_1 y_1} \right) \right]
\end{aligned}$$

Hence the claim follows by induction. □

The difference object enables us to formally define the difference of two morphisms outside an abelian environment:

3.4.7 Definition

Formal difference of two morphisms

Given two morphisms $f, g: X \rightarrow Y$, their *formal difference* is the composite

$$f - g := (D(X) \xrightarrow{\delta_X} X + X \xrightarrow{\langle f, g \rangle} Y)$$

3.4.8 Example

The difference of two morphisms of abelian groups

In the category Ab of abelian groups, the difference object $D(A)$ of A is functorially isomorphic to A . If now $f, g: A \rightarrow B$, then this isomorphism identifies the formal difference $(f - g) = \langle f, g \rangle \circ \delta_A: D(A) \rightarrow B$ with the pointwise difference $f - g: A \rightarrow B$.

3.4.9 Example

The difference of two group homomorphisms

In the category of groups, the pointwise difference of f and g is not a morphism. The group homomorphism $f - g: D(X) \rightarrow Y$ amends this: it takes a generator \overline{xx}^{-1} and sends it to $f(x)g(x)^{-1}$.

3.4.10 Proposition

Formal difference maps and composition - H

The formal difference construction of maps $f, g: X \rightarrow Y$ has the following properties:

- (i) For $z: Y \rightarrow Z$, $z \circ (f - g) = (z \circ f) - (z \circ g)$
- (ii) For $a: A \rightarrow X$, $(f - g) \circ D(k) = (f \circ a) - (g \circ a)$

Proof We compute

$$z \circ (f - g) = z \circ \langle f, g \rangle \circ \delta_X = \langle (z \circ f), (z \circ g) \rangle \circ \delta_X = (z \circ f) - (z \circ g)$$

Similarly,

$$(f - g) \circ D(a) = \langle f, g \rangle \circ \delta_X \circ D(k) = \langle f, g \rangle \circ (a + a) \circ \delta_A = (f \circ a) - (g \circ a)$$

This was to be shown. □

For the following proposition, let us observe that the difference object is well defined under the weaker assumptions stated there. We just need to be aware that the absolute epimorphism ∇_X need not be normal.

3.4.11 Proposition

A pointed regular finitely bicomplete category is normal if and only if for any two given morphisms $f, g: X \rightarrow Y$,

$$f - g = 0 \quad \Rightarrow \quad f = g$$

Proof In a normal category, the morphism ∇_X is a normal epimorphism, so that $\langle f, g \rangle \delta_X = f - g = 0$ gives us a unique factorization $h: X \rightarrow Y$ of $\langle f, g \rangle$ over ∇_X . This means that $\langle f, g \rangle = h \nabla_X = \langle h, h \rangle$ and thus $f = h = g$.

For the converse, via (3.4.2) it suffices to prove that every regular epimorphism is normal. To see this, we show that, for a pair of parallel arrows $f, g: X \rightarrow Y$, their coequalizer is a cokernel of $f - g: D(X) \rightarrow Y$. Consider the commutative diagram below, in which e is a coequalizer of f and g .

$$\begin{array}{ccccc}
 D(X) & \xrightarrow{\delta_X} & X + X & \xrightarrow{\nabla_X} & X & \begin{array}{c} \xrightarrow{f} \\ \xrightarrow{g} \end{array} & Y \\
 & \searrow^{f-g} & \downarrow \langle f, g \rangle & & & & \downarrow e \\
 & & Y & \xrightarrow{e} & & & Q
 \end{array}$$

If $h: Y \rightarrow Z$ satisfies $h(f - g) = hf - hg = 0$, then $hf = hg$ by assumption. So, the universal property of the coequalizer implies the universal property of the cokernel. □

The difference $\rho_X := 1_X - 0: D(X) \rightarrow X$ plays a special role. It appears in the next definition:

3.4.12 Definition

Normal subtractive category

A normal category is *subtractive* if, for each object X , the canonical map

$$\rho_X := 1_X - 0: D(X) \rightarrow X$$

is a normal epimorphism.

Thus, a subtractive category comes equipped with a normal epic natural transformation $\rho: D \Rightarrow 1_X$.

3.4.13 Lemma

Condition for $f = g$ - \mathbb{N}

In a subtractive category, suppose $f, g: X \rightarrow Y$ satisfy $(f - 0) = (g - 0): D(X) \rightarrow Y$, then $f = g$.

Proof We compute:

$$f \circ \rho_X = f \circ (1_X - 0) = f - 0 = g - 0 = g \circ (1_X - 0) = g \circ \rho_X$$

so that $f = g$, because ρ_X is an epimorphism. \square

3.4.14 Proposition

(DPN) implies subtractivity - \mathbb{N}

Any normal category in which the (DPN)-property holds is subtractive.

Proof We contemplate the di-extension

$$\begin{array}{ccccc}
 \square & \xrightarrow{\quad} & X \flat X & \xrightarrow{\xi} & X \\
 \downarrow & & \downarrow \kappa_X^X & & \downarrow \\
 D(X) & \xrightarrow{\delta_X} & X + X & \xrightarrow{\nabla_X} & X \\
 \downarrow \rho_X & & \downarrow \langle 1_X, 0 \rangle & & \downarrow \\
 X & \xrightarrow{\quad} & X & \longrightarrow & 0
 \end{array}$$

which comes from the top right antinormal composite $\nabla_X \circ \kappa_X^X$: Note that ξ is an absolute, hence normal, epimorphism. For it admits a section induced by $\iota_2: X \rightarrow X + X$. This proves that ρ_X is a normal epimorphism. \square

It follows that any subtractive variety (3.1.9) is a subtractive category in the sense of (3.4.12).

For the converse of (3.4.14) we may essentially repeat proof of (3.4.3). This illustrates how in this context, certain varietal proofs involving elements admit a direct translation into a categorical proof.

3.4.15 Proposition

Subtractivity implies (DPN) - \mathbb{N}

Any normal subtractive category satisfies the (DPN)-property.

Proof We show that condition (II) of Proposition 2.6.3 holds. We use the notation of (2.1.1). First, we see that the bottom right square is a pushout by (1.6.4). So, z is a normal epimorphism, and it remains to show that w is the kernel of z . To see this, note first that $z \circ w = 0$ by commutativity.

First, we show that w is a monomorphism or, equivalently, $K(w) = 0$; see (3.1.6). Consider $i: Y_1 \rightarrow I$ such that $w \circ i = 0$. Take the pullback $l: Y_2 \rightarrow L$ of i along d , so that $d \circ l = i \circ p_1$ where the normal epimorphism $p_1: Y_2 \rightarrow Y_1$ is the pullback of d along i . Then $e \circ v \circ l = 0$ so that $k: Y_2 \rightarrow K$ exists with $b \circ k = v \circ l$. Now $c \circ k = 0$ by commutativity, and so $x \circ k = 0$ because c is a monomorphism. So, there is $m: Y_2 \rightarrow M$, unique with $u \circ m = k$. Now $a \circ m = l$ since v is a monomorphism and $v \circ a \circ m = b \circ u \circ m = b \circ k = v \circ l$. Hence $i \circ p = d \circ l = d \circ a \circ m = 0$. The epic property of p implies that $i = 0$.

Now let $q: Z_1 \rightarrow Q$ be such that $z \circ q = 0$. Take the pullback $\bar{q}: Z_2 \rightarrow X$ of q along e , so that $e \circ \bar{q} = q \circ \bar{e}$, where the normal epimorphism $\bar{e}: Z_2 \rightarrow Z_1$ is the pullback of e along q . Then $f \circ y \circ \bar{q} = z \circ e \circ \bar{q} = z \circ q \circ \bar{e} = 0$. So, there is $j: Z_2 \rightarrow J$, unique with $c \circ j = y \circ \bar{q}$. Pull back j along x to a map $\bar{j}: Z_3 \rightarrow K$ such that $x \circ \bar{j} = j \circ \bar{x}$ where $\bar{x}: Z_3 \rightarrow Z_2$ is the normal epic pullback of x along j . Then $\bar{q} \circ \bar{x} - b \circ \bar{j}: D(Z_3) \rightarrow X$ is such that $y \circ (\bar{q} \circ \bar{x} - b \circ \bar{j}) = 0: D(Z_3) \rightarrow R$. So, there is $l: D(Z_3) \rightarrow L$, unique with $v \circ l = \bar{q} \circ \bar{x} - b \circ \bar{j}$. Now,

$$w \circ d \circ l = e \circ v \circ l = e \circ (\bar{q} \circ \bar{x} - b \circ \bar{j}) = q \bar{e} - 0 = q \circ \bar{e} \circ (1_{Z_2} - 0) = q \circ \bar{e} \circ \rho_{Z_2}$$

so that—by orthogonality of the normal epimorphism $r_1 \circ \rho_{Z_2}$ and the monomorphism w , it is here that subtractivity is used—a unique morphism $\hat{q}: Z_1 \rightarrow I$ exists which satisfies $\hat{q} \circ \bar{e} \circ \rho_{Z_2} = d \circ l$ and the needed $w \circ \hat{q} = q$. - Thus $w = \ker(z)$. \square

Notes

Scope of regular categories Regular categories provide a convenient environment for developing a calculus of internal relations or for the study of internal logic. It is part of the definition of a *Barr exact* category, and as such one of the axioms defining an *elementary topos*. Furthermore, all abelian categories and all varieties in the sense of universal algebra are regular categories (since they are actually Barr exact).

Subtractive varieties Normal subtractive varieties may be characterized as varieties which are normal subtractive categories. We keep this characterization (which combines results of [55] and [54]) for a later version of the text which will include a chapter on varieties of algebras.

Internal actions Some of the exact sequences in (3.4.14) play an important role in the theory of internal actions in the context of semiabelian categories [13, 21]—more about this subject in a later version of this document.

Ideal-Determined Categories A category is *ideal determined* ([52], see also [65]) if it is normal and di-exact. In particular, such a category satisfies the (DPN)-property. So it is subtractive by (3.4.14). An explicit characterization of ideal-determined varieties appears in [52].

Formal difference of maps in an abelian category Example 3.4.8 generalizes to abelian categories; see Exercise (7.4.8).

Chapter 4

Homological Categories

In Section 4.1, we introduce the concept of *homological category* which first appeared in work of Borceux and Bourn in [10]. Homological categories and normal categories from Chapter 3 are closely related: In the collection of structural axioms characterizing a normal category, we replace the (AEN)-condition, every split epimorphism is a normal map, by the assumption that, for every split epimorphism $p: X \rightarrow Y$ with section $s: Y \rightarrow X$, the morphisms s and $\kappa = \ker(p)$ are jointly extremal-epimorphic:

$$K(p) \begin{array}{c} \xrightarrow{\kappa} \\ \xrightarrow{p} \end{array} X \begin{array}{c} \xleftarrow{s} \\ \xrightarrow{p} \end{array} Y$$

We interpret this as saying that ‘kernel and section of p generate X ’, and refer to this property as the (KSG)-condition.

The (KSG)-condition is extracted from *Bourn protomodular* categories [14]. It implies the (AEN)-condition, and it enables us to prove results which need not hold in a normal category, such as the (Short) 5-Lemma, the ‘middle case’ of the (3×3) -Lemma, and more as presented in Sections 4.1 to 4.6:

- ▶ Homological categories are normal; hence all of the epimorphism types ‘normal’, ‘effective’, ‘regular’, ‘strong’, and ‘extremal’ coincide, and the Snake Lemma holds.
- ▶ Every morphism f admits a normal epi factorization; that is $f = me$, where e is a normal epimorphism, and m is a monomorphism (not necessarily normal).
- ▶ The Short 5-Lemma and the 5-Lemma are true.
- ▶ The (3×3) -Lemma holds in its full generality, with a formulation which matches the one familiar from abelian categories.

See Section 4.10 for further insights on the original viewpoint on protomodularity in terms of the so-called *fibration of points*.

Leitfaden for Chapter 4

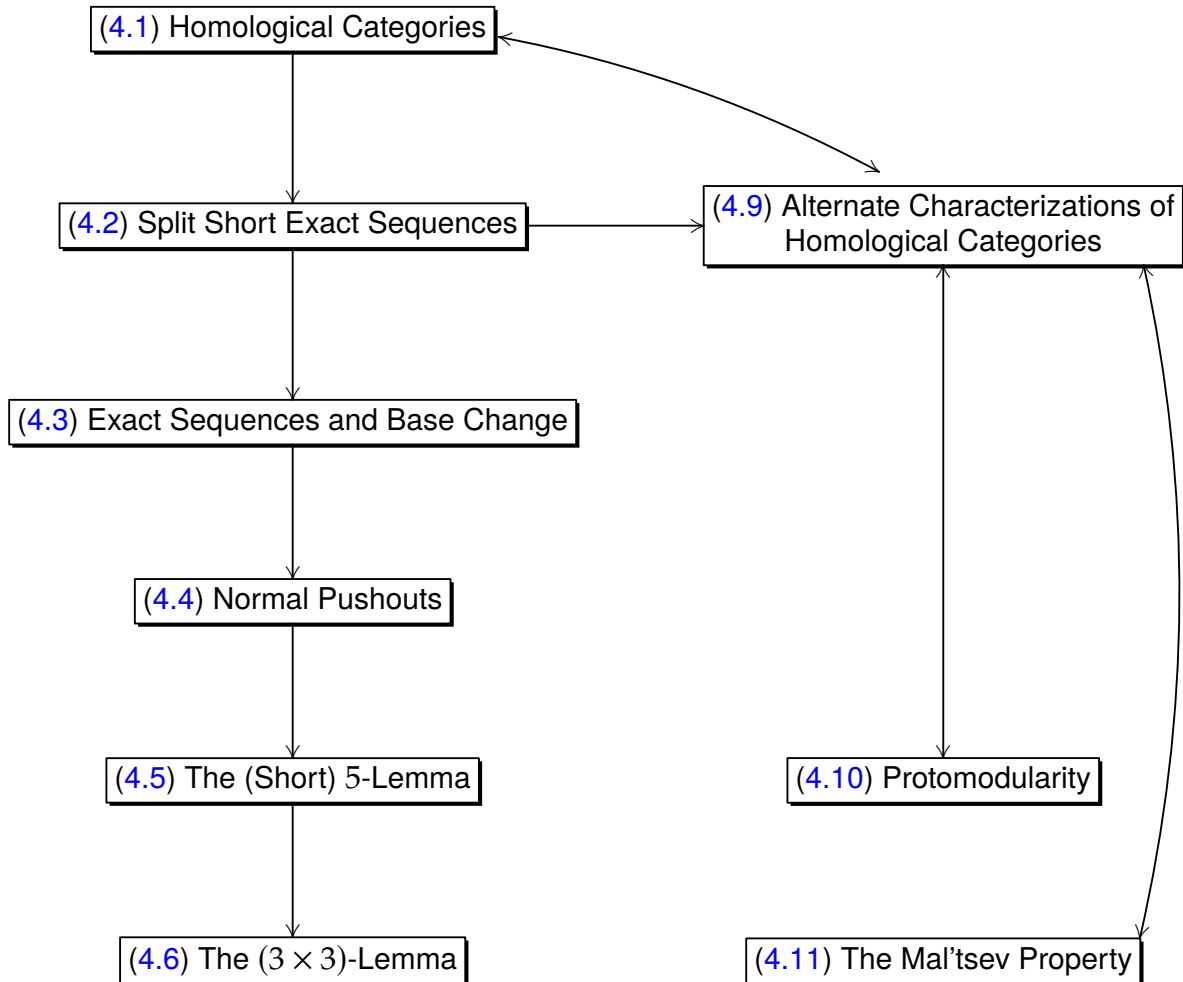

4.1 Axioms for Homological Categories

Originally, in [10], Borceux and Bourn defined a pointed category as being homological if it is regular and protomodular. Here, building on the foundation developed earlier, we arrive at the following presentation of their work:

4.1.1 Definition

Homological category

A category \mathcal{X} is *homological* if it satisfies the following structural axioms.

- ▶ *Zero object*: \mathcal{X} has a zero object; see (1.2.1).
- ▶ *Functorially finitely complete*: For every functor $F: J \rightarrow \mathcal{X}$ whose domain is a finite category J , the limit $\lim(F)$ exists; see (A.1).
- ▶ *Functorially finitely cocomplete*: For every functor $F: J \rightarrow \mathcal{X}$ whose domain is a finite category J , the colimit $\operatorname{colim}(F)$ exists; see (A.1).
- ▶ *(PNE) Pullbacks preserve normal epimorphisms*: The pullback \bar{g} of a normal epimorphism g along any morphism f in \mathcal{X} is a normal epimorphism.

$$\begin{array}{ccc}
 P & \longrightarrow & Z \\
 \bar{g} \downarrow & \circlearrowleft & \downarrow g \\
 X & \xrightarrow{f} & Y
 \end{array}$$

- ▶ *(KSG) Kernel and section generate*: For a morphism $q: X \rightarrow Q$ with any given section $x: Q \rightarrow X$ (so that $qx = 1_Q$),

$$K(q) \xrightarrow{k} X \xrightleftharpoons[x]{q} Q \tag{4.1.1}$$

the morphisms x and $k = \ker(q)$ are jointly extremal-epimorphic; see (A.3.1).

Comparison with normal categories In transitioning from normal categories to homological ones, we swap out the condition (AEN)—absolute epimorphisms are normal—for the condition (KSG). In (4.1.2), we show that every homological category is a normal category. Beyond this fact, the role of the (KSG)-condition is not immediately obvious. Yet, it is far reaching. Given a short exact sequence, it is the key toward gaining information about its middle object from its end objects. Indeed, we shall prove (4.9.2) that, in the context of a normal category, the (KSG)-condition is equivalent to the validity of the Short 5-Lemma; see Theorem 4.5.1.

To see the difficulty one encounters if the (KSG)-condition is not satisfied, consider the category Set_* of pointed sets. Here we encounter the phenomenon that a sectioned epimorphism q as in Diagram 4.1.1 need not be the cokernel of its kernel k , because K combined with any section of q fail to generate X . To see this in Set_* , take a ‘huge’ pointed set (X, t) and let $q: (X, t) \rightarrow (\{-1, 1\}, 1)$ send $a \neq t$ to -1 . Then $K := K(q) = \{t\}$, and so $\text{coker}(\ker(q)) = 1_X \neq q$.

The following proposition implies that every homological category is also a normal category.

4.1.2 Proposition

Split epimorphism is normal - H

In a z-exact category which satisfies the (KSG)-condition, every split epimorphism is a normal epimorphism.

Proof Given a split epimorphism p with its kernel k as in Diagram 4.1.1, we check that p is a cokernel of k . Let $f: X \rightarrow Z$ be such that $fk = 0$. Then $fs: Y \rightarrow Z$ is a factorization of f through p . Indeed, $fsp = f$ because k and s are jointly epimorphic and $fsp = fs$ while $fspk = 0 = fk$. Since p is an epimorphism, this factorization is unique. \square

4.1.3 Corollary

Homological \Rightarrow normal - H

Every homological category \mathcal{X} enjoys the following properties.

- (i) \mathcal{X} is a normal category; see (3.1.1).
- (ii) (HSD) \mathcal{X} is homologically self-dual.

Proof (i) With (4.1.2) we see that the structural axioms (3.1.1) characterizing a normal category are satisfied. This implies (ii) because we know already that every normal category is homologically self-dual; (3.1.8). \square

4.1.4 Example

Normal but not homological

The category OrdGrp of preordered groups is known to be normal but not homological [28]: a preordered group being a group equipped with a preorder (a reflexive and transitive relation) for which the group operation is monotone; arrows are monotone group homomorphisms.

Notes Borceux-Bourn homological vs homological

Finite (co)completeness We require a homological category to be finitely bicomplete. This means that our definition of ‘homological category’ differs slightly from earlier definitions such as the one in [10], where the only colimits required to exist are coequalizers of kernel pairs. More precisely, whenever a morphism $f: X \rightarrow Y$ admits a kernel pair, the coequalizer of the kernel pair projections must exist. While it is clear that this condition holds in a finitely cocomplete category, there are categories in which the converse does not hold. For example, these two conditions do not guarantee the existence of cokernels or coproducts.

This means that a category which merely admits this type of colimits need not even be z-exact. Requiring a homological category to be finitely cocomplete is a matter of convenience.

For clarity, we say that a category is *Borceux–Bourn homological* (or *BB-homological*) if it is pointed, finitely complete, admits coequalizers of kernel pairs, preserves normal epimorphisms under base change, and has the (KSG)-property. We explain in (4.10.10) that this agrees with the original definition of Borceux and Bourn.

As we shall see in Chapter 5, in the context of a semiabelian category, this problem no longer occurs. Indeed, if a BB-homological category satisfies (ANN), then existence of binary coproducts entails finite cocompleteness. This is a non-trivial result¹.

Exercises

4.1.5 Exercise

Torsion-free groups

Show that the category Grp_{tf} of torsion-free groups has the following properties:

- (i) Given a group G , its torsion subgroup is $T(G)$ is a normal subgroup.
- (ii) The quotient map $G \rightarrow G/T(G)$ determines a functor $\text{Grp} \rightarrow \text{Grp}_{tf}$ to the effect that Grp_{tf} is a reflective subcategory of Grp .
- (iii) The kernel of a morphism $f: G \rightarrow H$ of torsion free groups is its kernel in Grp ; i.e. the set of all those $g \in G$ with $f(g) = 0$.
- (iv) The cokernel of a morphism $f: G \rightarrow H$ of torsion-free groups is given by its cokernel in Grp modulo its torsion subgroup.
- (v) Grp_{tf} is complete and limits may be computed in Grp . - Conclude that the (PNE)-property holds in Grp_{tf} .
- (vi) The (KSG)-property holds in Grp_{tf} .

Conclude that Grp_{tf} is a homological category.

4.1.6 Exercise

Torsion-free abelian groups

Show that the category Ab_{tf} is a homological category.

¹This result is omitted in the current rendition of the text, but will be available in a later version.

4.2 Split Short Exact Sequences

We know from (4.1.2) that, in a homological category, every sectioned epimorphism is the cokernel of its kernel. Thus, as in a normal category, every sectioned epimorphism determines a split short exact sequence. Via the (KSG)-property, kernel and section of such a split short exact sequence generate the middle object. As consequence, we show in (4.2.4) that a morphism of split short exact sequences is an isomorphism if and only if it restricts to an isomorphism of the end objects. This result is called the *Split Short 5-Lemma*.

Using the Split Short 5-Lemma, we establish a converse to (1.6.1). There, we showed that, in a pullback square, the kernels of two opposing maps are canonically isomorphic. Here, we show that, if a morphism of split short exact sequence involves an isomorphism of kernel objects, then the square of cokernels is a pullback; see (4.2.8).

Next, we use this information to identify a product of two objects in a homological category. In (4.2.9) we show that an object T admits the structure of a product of A and B if and only if T fits into mutually split short exact sequences:

$$A \begin{array}{c} \xrightarrow{i} \\ \xleftarrow{q} \end{array} T \begin{array}{c} \xleftarrow{p} \\ \xrightarrow{j} \end{array} B$$

As another application we show in (4.2.10) that the canonical map $A + B \rightarrow A \times B$ is a normal epimorphism.

4.2.1 Definition

Morphism of sectioned/split short exact sequences - z-Ex

A *morphism of split short exact sequences* is given by a diagram whose rows are split short exact sequences:

$$\begin{array}{ccccc} K & \xrightarrow{k} & X & \begin{array}{c} \xrightarrow{q} \\ \xleftarrow{x} \end{array} & Q \\ \kappa \downarrow & & \xi \downarrow & & \downarrow \rho \\ L & \xrightarrow{l} & Y & \begin{array}{c} \xrightarrow{r} \\ \xleftarrow{y} \end{array} & R \end{array} \quad (4.2.1)$$

such that the left hand square commutes, $\rho q = r \xi$, and $\xi x = y \rho$.

We write $SSES(\mathcal{X})$ for the category of split short exact sequences and their morphisms.

Here is an example which demonstrates what can happen in a z-exact category which fails to satisfy the (KSG)-Axiom.

4.2.2 Example

Projection $\mathbb{N} \times \mathbb{N} \rightarrow \mathbb{N}$

In the category \mathbf{Mnd} of monoids, consider the split short exact sequence

$$\mathbb{N} \xrightarrow{k=(1,0)} \mathbb{N} \times \mathbb{N} \begin{array}{c} \xleftarrow{pr_1} \\ \xrightarrow{s=\Delta} \end{array} \mathbb{N}$$

where $pr_1(m, n) := m$, and $s(n) := (n, n)$. Still, k and s fail to generate $\mathbb{N} \times \mathbb{N}$. This corresponds to the existence of factorizations of k and s through proper subobjects of $\mathbb{N} \times \mathbb{N}$ such as, for $c \geq 2$ fixed,

$$M = \{(m, 0) + (n, n) + (0, pc) \mid m, n, p \in \mathbb{N}\}$$

4.2.3 Example

Split short exact sequence in \mathbf{Set}_* vs. (KSG)

More subtle yet is what happens in the category \mathbf{Set}_* of pointed sets. On the one hand, in every *split short exact sequence*, kernel and section generate the middle object. However, absolute epimorphisms need not be normal maps. So, the (KSG)-property is not satisfied in \mathbf{Set}_* ; see Exercise 4.2.11.

4.2.4 Proposition

Split Short 5-Lemma - H

Consider a morphism of split short exact sequences as in (4.2.1). If k and ρ are isomorphisms, then ξ is an isomorphism as well.

Proof In the given diagram, consider the diagram of kernels of κ , ξ , and ρ :

$$0 \longrightarrow K(\xi) \begin{array}{c} \xleftarrow{s} \\ \xrightarrow{\kappa} \end{array} 0$$

We find that $K(s) = K(\kappa) = 0$ because limits commute with limits. With (1.9.3), we see that $K(\xi) = 0$. So, the map ξ is a monomorphism by Proposition 3.1.6. Now l and y factor through this monomorphism ξ via $l'\kappa^{-1}$ and $x\rho^{-1}$. Since l and y are jointly extremal-epimorphic, we infer with the (KSG)-property that ξ is an isomorphism. \square

4.2.5 Proposition

Pullback of sectioned epimorphism - H

Consider the pullback of a sectioned epimorphism $p: X \rightarrow Y$, with a section $s: Y \rightarrow X$, along an arbitrary $f: A \rightarrow Y$, as in (A.2.5):

$$\begin{array}{ccc} P & \xrightarrow{\bar{f}} & X \\ \bar{p} \downarrow \uparrow \bar{s} & \circlearrowleft & p \downarrow \uparrow s \\ A & \xrightarrow{f} & Y \end{array}$$

Then the morphisms \bar{f} and s are jointly extremal-epimorphic.

Proof In the commutative diagram below, assume that $m : M \rightarrow X$ is a monomorphism.

$$\begin{array}{ccccc}
 & & M & & \\
 & r' \nearrow & \downarrow m & \nwarrow s' & \\
 P & \xrightarrow{\tilde{f}} & X & \xleftarrow{s} & Y
 \end{array}$$

We want to show that m is an isomorphism. To see this, note first that $pm : M \rightarrow Y$ satisfies $pms' = ps = 1_Y$. So pm admits a section s' , which makes it an absolute epimorphism. Now expand the original diagram by taking kernels:

$$\begin{array}{ccccc}
 & & \tilde{r}' & & \\
 & \overbrace{\hspace{10em}} & & \underbrace{\hspace{10em}} & \\
 K(\tilde{p}) & \xrightarrow[\cong]{\tilde{f}} & K(p) & \xleftarrow{\tilde{m}} & K(pm) \\
 \downarrow & & \downarrow & \circlearrowleft & \downarrow \\
 P & \xrightarrow{\tilde{f}} & X & \xleftarrow{m} & M \\
 \downarrow \tilde{p} & \circlearrowleft & \downarrow p \uparrow s & & \downarrow pm \uparrow s' \\
 A & \xrightarrow{f} & Y & \xlongequal{\hspace{2em}} & Y
 \end{array}$$

The map \tilde{f} is an isomorphism by (1.5.8). The top right square is a pullback (1.6.2), and so pullback stability of monomorphisms (A.1.12) shows that \tilde{m} is a monomorphism. The morphism \tilde{r}' induced by r' via the top right pullback, however, is such that $\tilde{m} \circ \tilde{r}' = \tilde{f}$. Hence \tilde{m} is both a monomorphism and an absolute epimorphism, which makes it an isomorphism; see (A.2.10). With the split Short 5-Lemma (4.2.4), we see that m is an isomorphism. \square

Any pullback of a sectioned epimorphism along a sectioned epimorphism yields a sectioned epimorphism in the category of sectioned epimorphisms in \mathcal{X} , as in (A.2.8):

$$\begin{array}{ccc}
 P & \xleftarrow{\tilde{t}} & X \\
 \tilde{p} \uparrow \tilde{s} & \tilde{f} & \downarrow p \uparrow s \\
 A & \xleftarrow{t} & Y \\
 & f &
 \end{array} \tag{4.2.6}$$

This means that $\tilde{f} \circ \tilde{t} = 1_X$, $p \circ s = 1_Y$, $f \circ t = 1_Y$ and $\tilde{p} \circ \tilde{s} = 1_A$, and that the two possible composites from any corner to its opposite corner are equal. We find the next result, which as explained in (4.11) is related to the concept of a Mal'tsev category.

4.2.7 Corollary

Mal'tsev property - H

In a pointed, finitely complete category satisfying the (KSG)-axiom, suppose diagram (4.2.6) is a pullback of $p: X \rightarrow Y$ along a morphism $f: A \rightarrow Y$. Then, the sections \bar{s} and \bar{t} are jointly extremal-epimorphic.

Proof Via the (KSG)-axiom, the maps \bar{s} and $K(\bar{p}) \rightarrow P$ are jointly extremally epimorphic. But the map $K(\bar{p}) \cong K(p) \rightarrow P$ factors through X via \bar{t} . So, \bar{s} and \bar{t} are jointly extremally epimorphic. \square

4.2.8 Lemma

Pullback recognition, split short exact version - H

Consider a morphism of split short exact sequences.

$$\begin{array}{ccccc}
 K' & \xrightarrow{\kappa'} & X' & \begin{array}{c} \xrightarrow{p'} \\ \xleftarrow{s'} \end{array} & Y' \\
 k \downarrow \cong & & x \downarrow & & y \downarrow \\
 K & \xrightarrow{\kappa} & X & \begin{array}{c} \xrightarrow{p} \\ \xleftarrow{s} \end{array} & Y
 \end{array}$$

Then k is an isomorphism if and only if the square $X' \rightrightarrows Y$ is a pullback.

Proof If the square on the right is a pullback, then k is an isomorphism by (1.6.1). The converse follows via the Split Short 5-Lemma (4.2.4): Pulling back p along y yields the commutative diagram below.

$$\begin{array}{ccccccc}
 K' & \xrightarrow{\kappa'} & X' & \begin{array}{c} \xrightarrow{p'} \\ \xleftarrow{s'} \end{array} & Y' & & \\
 \downarrow k \cong & \searrow k & \downarrow x & \dashrightarrow t & \downarrow y & & \\
 K & \xrightarrow{\kappa} & X & \xrightarrow{\quad} & X \times_Y Y' & \begin{array}{c} \xrightarrow{\bar{p}} \\ \xleftarrow{\bar{s}} \end{array} & Y' \\
 & & & & \downarrow & & \downarrow y \\
 K & \xrightarrow{\kappa} & X & \begin{array}{c} \xrightarrow{p} \\ \xleftarrow{s} \end{array} & Y & &
 \end{array}$$

The universal property of $X \times_Y Y'$ yields the comparison map t , and we claim that t is an isomorphism. Indeed, $K(p) = K \cong K(\bar{p})$. A section \bar{s} of \bar{p} exists via the pullback property of the bottom right square. Now the Split Short 5-Lemma tells us that t is an isomorphism. - This implies the claim. \square

4.2.9 Proposition

Product properties - H

In any homological category the following hold.

- (i) Any product projection $pr_A: A \times B \rightarrow A$ is a normal epimorphism.

(ii) The product of two objects A and B fits into two short exact sequences:

$$A \begin{array}{c} \xrightarrow{(1_A, 0)} \\ \xleftarrow{pr_A} \end{array} A \times B \begin{array}{c} \xleftarrow{pr_B} \\ \xrightarrow{(0, 1_B)} \end{array} B$$

(iii) Two maps $q: T \rightarrow A$ and $p: T \rightarrow B$ represent T as a product of A and B if and only if p and q , together with their kernels, yield mutually sectioning short exact sequences such as

$$A \begin{array}{c} \xrightarrow{i} \\ \xleftarrow{q} \end{array} T \begin{array}{c} \xleftarrow{p} \\ \xrightarrow{j} \end{array} B$$

If so, then $(q, p): T \rightarrow A \times B$ is an isomorphism.

Proof (i) pr_A has a section $(0, 1_B)$. So, the claim follows from (4.1.2).

(ii) To see this, we show that $\ker(pr_A) = (0, 1_B)$. Consider the commutative diagram below.

$$\begin{array}{ccccc} & & & & 1_B \\ & & & & \downarrow \\ B & \xrightarrow{(0, 1_B)} & A \times B & \xrightarrow{pr_B} & B \\ & & \downarrow pr_A & \circlearrowleft & \downarrow \\ & & A & & 0 \\ & & \downarrow & & \downarrow \\ 0 & \longrightarrow & A & \longrightarrow & 0 \end{array}$$

The square on the right is a pullback, as is the outer rectangle. By pullback cancellation (A.1.6), the left hand square is a pullback as well. With (1.4.5) we see that $(0, 1_B) = \ker(pr_A)$.

(iii) If p and q , together with their kernels, yield those mutually sectioning short exact sequences, then the diagram below commutes.

$$\begin{array}{ccccc} A & \begin{array}{c} \xrightarrow{i} \\ \xleftarrow{q} \end{array} & T & \begin{array}{c} \xleftarrow{p} \\ \xrightarrow{j} \end{array} & B \\ \parallel & & \downarrow (q, p) & & \parallel \\ A & \begin{array}{c} \xrightarrow{(1_A, 0)} \\ \xleftarrow{pr_A} \end{array} & A \times B & \begin{array}{c} \xleftarrow{pr_B} \\ \xrightarrow{(0, 1_B)} \end{array} & B \end{array}$$

By the Split Short 5-Lemma 4.2.4, the map (q, p) is an isomorphism. Via the commutativity of the diagram, we see that (T, q, p) is a product cone.

Conversely, if (T, q, p) is a product cone, then the map (q, p) , induced by the product

property of $A \times B$ is an isomorphism.

$$\begin{array}{ccccc}
 A & \xleftarrow{q} & T & \xrightarrow{p} & B \\
 \parallel & & \cong \downarrow (q,p) & & \parallel \\
 A & \xrightarrow{(1_A,0)} & A \times B & \xleftarrow{(0,1_B)} & B \\
 \leftarrow \text{pr}_A & & & & \text{pr}_B \rightarrow
 \end{array}$$

It follows that p and q are normal epimorphisms. Further, $i := (q, p)^{-1} \circ (1_A, 0) = K(p)$ is a section for q , and $j := (q, p)^{-1} \circ (0, 1_B) = K(q)$ is a section for p . \square

4.2.10 Proposition

$A + B \rightarrow A \times B$ is a normal epimorphism - H

For objects A and B , the *sum/product* or *coproduct/product* comparison map

$$\gamma_{A,B} := (\langle 1_A, 0 \rangle, \langle 0, 1_B \rangle) = \langle (1_A, 0), (0, 1_B) \rangle: A + B \longrightarrow A \times B$$

is a normal epimorphism.

Proof The two inclusions $(1_A, 0)$ and $(0, 1_B)$ are jointly extremal-epimorphic by Corollary 4.2.7, applied in the situation where $Y = 0$. Thus the induced arrow $A + B \rightarrow A \times B$ is an extremal epimorphism. So it is a normal epimorphism by (3.2.5). \square

Proposition 4.2.10 implies that the factor inclusions into the *product* are jointly epimorphic:

$$A \xrightarrow{(1_A,0)} A \times B \xleftarrow{(0,1_B)} B$$

Notes

On the comparison map $A + B \rightarrow A \times B$ In (4.2.10), we showed that the comparison map $A + B \rightarrow A \times B$ is a normal epimorphism. This fact plays a key role in what follows: It provides the foundation for discussing abelian objects in a semiabelian category. It supports the development of a well behaved theory of commutators. Finally, a homological category in which $\gamma_{A,A}$ is an isomorphism for every A is additive.

Split short exact sequences and semidirect products As in the category Grp of groups, we will see later that the middle object X in a split short exact sequence $K \twoheadrightarrow X \hookrightarrow Y$ may be described as a semidirect product of K and Y .

Functorial kernels in a homological category \mathcal{X} yield a canonical equivalence between the category SSES(\mathcal{X}) of split short exact sequences in \mathcal{X} , and the category SEpi(\mathcal{X}) of sectioned epimorphisms in \mathcal{X} . The latter is also known as the ‘category of points’ in \mathcal{X} ; see (A.2) and (4.10.6).

Exercises

4.2.11 Exercise

KSG in Set*

In the category Set* of pointed sets show the following:

(i) Set_* fails to satisfy the (KSG)-Axiom.

(ii) If $K \xrightarrow{k} X \xrightarrow{p} Y$ is a short exact sequence with splitting s of p , then k and s are jointly extremal-epimorphic.

4.2.12 Exercise

Weak condition for: Sectioned epimorphism is normal - z-Ex

In a z -exact category, consider a sectioned epimorphism $p: X \rightarrow Y$ with section $s: Y \rightarrow X$ and kernel $\kappa = \ker(p)$.

$$K \triangleright \xrightarrow{\kappa} X \begin{array}{c} \xleftarrow{p} \\ \xrightarrow{s} \end{array} \triangleright Y$$

If κ and s are jointly epimorphic, then p is a cokernel of κ .

4.2.13 Exercise

Biproduct in a pointed variety - ANK

Is there are non-linear variety with a non-zero object X for which $\gamma_{X,X}: X + X \rightarrow X \times X$ is an isomorphism?

4.2.14 Exercise

Double absolute epimorphisms - H

First recall (4.2.5), then revisit Exercise A.2.13 in the context of a homological category: is a commutative square consisting of absolute epimorphisms always an absolute pushout?

4.3 Exact Sequences and Base Change

In the study of group or module extensions, functoriality of Yoneda's Ext-functor in its first variable relies on pulling a given short exact sequence $K \triangleright \rightarrow X \rightarrow Q$ back along a morphism $f: R \rightarrow Q$. Thus we obtain a new short exact sequence $K \triangleright \rightarrow X' \rightarrow R$. By virtue of the (PNE)-Axiom, we show in (4.3.2) that this construction is available in any homological category. Thus, given a short exact sequence ε , as in the bottom row of the diagram below, form the pullback of q along an arbitrary morphism $f: R \rightarrow Q$:

$$\begin{array}{ccccc}
 & & K \triangleright & \xrightarrow{k'} & \bar{X} & \xrightarrow{\bar{q}} & R \\
 & & \vdots & & \downarrow \bar{f} & \circlearrowleft & \downarrow f \\
 f^* \varepsilon & & & & & & \\
 (1, \bar{f}, f) \downarrow & & & & & & \\
 \varepsilon & & K \triangleright & \xrightarrow{k} & X & \xrightarrow{q} & Q
 \end{array} \tag{4.3.1}$$

We find that the top row is a short exact sequence, denoted $f^* \varepsilon$. We refer to it as the short exact sequence obtained by *pulling* ε *back along* f or by *base change along* f .

Combined with the Short 5-Lemma we will be well positioned to define Ext as a contravariant functor in the first variable; see Section 4.5, which relies on technical preparation developed here.

4.3.2 Proposition

Base change preserves short exact sequences - H

If the sequence $K \twoheadrightarrow X \twoheadrightarrow Q$ is short exact, then a morphism $f: R \rightarrow Q$ yields a morphism of short exact sequences, as in (4.3.1).

Proof The normal epimorphism q pulls back to a normal epimorphism by the (PNE)-condition. By (1.6.1) we may represent $\ker(\bar{q})$ by a map k' so that the map of kernels induced by (\bar{f}, f) is the identity. \square

Next, we present properties of pullbacks, including tools to identify a commutative square as a pullback. We know already that pullbacks preserve monomorphisms (A.1.12). Here, we are establish the following converse:

4.3.3 Proposition

Pullbacks preserve/reflect monomorphisms - H

In the pullback square

$$\begin{array}{ccc} K & \xrightarrow{\bar{h}} & L \\ \bar{k} \downarrow & \circlearrowleft & \downarrow k \\ X & \xrightarrow{h} & A \end{array}$$

the map \bar{k} is a monomorphism if and only if k is a monomorphism.

Proof We know already (A.1.12) that base change preserves monomorphisms. For the converse, suppose \bar{k} is a monomorphism. Then $K(k) = K(\bar{k}) = 0$ by combining (1.5.8) and (1.6.1). The monomorphism recognition criterion (3.1.6) implies that k is a monomorphism. \square

4.3.4 Corollary

Pullback along normal epi preserves/reflects (normal) monos - H

Pullback along a normal epimorphism preserves and reflects monomorphisms and normal monomorphisms.

Proof That base change preserves and reflects monomorphisms holds by (4.3.3). It preserves normal monomorphisms by (1.5.4). Finally, pulling a normal epimorphism back along any map γ yields a morphism of short exact sequences. If γ pulls back to a normal monomorphism β , then we have a totally normal sequence of monomorphisms as in (2.5.2). So, γ is a normal monomorphism because every homological category is homologically self-dual. \square

4.3.5 Corollary

Pullbacks and preservation/reflection of normal maps - H

About the pullback diagram below the following are true:

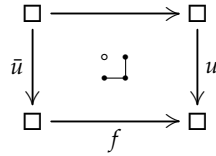

- (i) If u is a normal map, then so is its pullback \bar{u} along f .
- (ii) Suppose f is a normal epimorphism. If \bar{u} is a normal map, then so is u .

Proof That a pullback along an arbitrary map preserves normal maps follows from the fact that pullbacks preserve normal monomorphisms (1.5.8) as well as image factorizations (3.2.6). If f is a normal epimorphism, then the pullback along f also reflects normal monomorphisms (4.3.4) and, hence, normal maps. \square

We may now extend (1.6.2) as follows:

4.3.6 Lemma

Pullback recognition: kernel side II - H

[17] In the commutative diagram below, suppose the sequence at the top is short exact, and $\alpha' = \ker(q')$. Then the following hold:

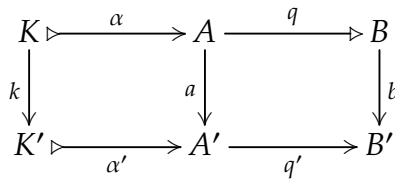

- (i) The left hand square is a pullback if and only if b is a monomorphism.
- (ii) If b is a monomorphism, then k is a monomorphism if and only if a is a monomorphism.

Proof (i) If b is a monomorphism, the left hand square is a pullback by (1.6.2). Conversely, if the left hand square is a pullback then (1.5.8.i) tells us that $\alpha = K(q'a)$. As q is a cokernel of α , we see that $bq = q'a$ is the normal epi/mono image factorization (3.2.12) of $q'a$. Consequently, b is a monomorphism.

(ii) If b is a monomorphism then the square on the left is a pullback by (i). The result now follows, since pullbacks preserve and reflect (4.3.3) monomorphisms. \square

4.3.7 Corollary

Monomorphism recognition - H

Consider a morphism of exact sequences.

$$\begin{array}{ccccccc}
 A & \xrightarrow{\alpha} & B & \xrightarrow{\beta} & C & \longrightarrow & 0 \\
 a \downarrow & & \downarrow b & & \downarrow c & & \\
 X & \xrightarrow{\xi} & Y & \xrightarrow{\eta} & Z & \longrightarrow & 0
 \end{array}
 \quad (L)$$

If the square (L) is a pullback, then c is a monomorphism.

Proof The maps α and ξ are normal maps because the horizontal sequences are exact in B and Y , respectively. Thus, upon inserting the normal factorizations of α and ξ , we obtain this commutative diagram:

$$\begin{array}{ccccccc}
 A & \xrightarrow{\alpha} & B & \xrightarrow{\beta} & C & & \\
 \downarrow a & \searrow & \downarrow b & \searrow & \downarrow c & & \\
 X & \xrightarrow{\xi} & Y & \xrightarrow{\eta} & Z & & \\
 \downarrow & \swarrow & \downarrow & \swarrow & \downarrow & & \\
 & & & & & &
 \end{array}
 \quad (U) \quad (V)$$

$\alpha \xrightarrow{\quad} I(\alpha) = K(\beta) \xrightarrow{\quad} \beta \xrightarrow{\quad} C$
 $\xi \xrightarrow{\quad} I(\xi) = K(\eta) \xrightarrow{\quad} \eta \xrightarrow{\quad} Z$

As (L) is a pullback, we infer with Proposition 3.2.6 that both (U) and (V) are pullbacks, and so c is a monomorphism by (4.3.6). \square

The following proposition extends categorical pullback cancellation; see A.1.6.

4.3.8 Proposition

2-out-of-3 property for pullbacks - H

[10, p. 242], [9, p. 36f], [53] In the commutative diagram below assume that x is a normal epimorphism.

$$\begin{array}{ccccc}
 A & \longrightarrow & B & \longrightarrow & C \\
 \downarrow & & \downarrow & & \downarrow \\
 X & \xrightarrow{x} & Y & \longrightarrow & Z
 \end{array}$$

If two out of three of the commutative rectangles in this diagram are pullbacks, then so is the third.

Proof By Proposition A.1.6 we only need to consider the case where the outer rectangle and the square on the left are pullbacks. To see that the right hand square is a pullback as

well, consider the commutative diagram below.

$$\begin{array}{ccccc}
 A & \longrightarrow & B & \longrightarrow & C \\
 \searrow \bar{x}^* f & & \searrow f & & \parallel \\
 \cong \downarrow & & & & \downarrow \\
 x^* y^* C & \xrightarrow{\bar{x}} & y^* C & \longrightarrow & C \\
 \hat{c} \swarrow & & \bar{c} \swarrow & & \parallel \\
 a=b^* \downarrow & & b \downarrow & & \downarrow \\
 X & \xrightarrow{x} & Y & \xrightarrow{y} & Z \\
 & & \swarrow \bar{c} & & \swarrow c
 \end{array}$$

The bottom square on the right is constructed as a pullback. We want to show that the comparison map f is an isomorphism. Indeed, via the (PNE)-Axiom, the normal epimorphism x pulls back along \bar{c} to the normal epimorphism \bar{x} . By commutativity of the top left square f is a normal epimorphism, using (3.2.7). Next, the upper left square is a pullback by pullback cancellation (A.1.6), applied to the left hand side of the diagram. As pullbacks reflect monomorphisms (4.3.3) we see that f is a monomorphism. So f is an isomorphism by (1.5.7). \square

Our next objective is to establish a converse of (1.6.1): if a morphism of short exact sequences presents an isomorphism of kernel objects, then the square of cokernels is a pullback. Actually, we already did part of the work in (4.2.8) where we showed that the desired conclusion holds for a morphism of *split short exact sequences*. To make the transition, we employ the following strategy: we prove an intermediate lemma in which kernels are replaced by kernel pairs. The kernel pair construction turns an ordinary short exact sequence into a split short exact sequence to which we can apply (4.2.8). So, here is the transitional lemma, a theorem of Barr and Kock.

4.3.9 Theorem

Barr–Kock - H

In the diagram below, assume that the square (R) commutes, with f be a normal epimorphism. Then form the left hand side by taking kernel pairs of f and f' , respectively.

$$\begin{array}{ccccc}
 KP(f) & \begin{array}{c} \xrightarrow{p_1} \\ \xleftarrow{e} \\ \xrightarrow{p_2} \end{array} & X & \xrightarrow{f} & Y \\
 u \downarrow & & \downarrow x & \text{(R)} & \downarrow y \\
 KP(f') & \begin{array}{c} \xrightarrow{p'_1} \\ \xleftarrow{e'} \\ \xrightarrow{p'_2} \end{array} & X' & \xrightarrow{f'} & Y'
 \end{array}$$

If at least one of squares given by $x p_1 = p'_1 u$ or $x p_2 = p'_2 u$ is a pullback, then the square on the right is a pullback as well.

Proof Consider the case where the square given by $x p_1 = p'_1 e$ is a pullback. The remaining case is similar.

$$\begin{array}{ccccc}
 KP(f) & \xrightarrow{u} & KP(f') & \xrightarrow{p'_2} & X' \\
 p_1 \downarrow & & \circlearrowleft \downarrow & & \circlearrowleft \downarrow \\
 X & \xrightarrow{x} & X' & \xrightarrow{f'} & Y'
 \end{array}$$

Both squares in the diagram above are pullbacks. So the outer rectangle is a pullback as well (A.1.6). Now this outer rectangle reappears in the commutative diagram below.

$$\begin{array}{ccccc}
 KP(f) & \xrightarrow{p_2} & X & \xrightarrow{x} & X' \\
 p_1 \downarrow & & \circlearrowleft \downarrow & & \circlearrowleft \downarrow \\
 X & \xrightarrow{f} & Y & \xrightarrow{y} & Y'
 \end{array}$$

Since f is a normal epimorphism, the 2-out-of-3 property for pullbacks (4.3.8) shows that the right hand square is a pullback, as desired. \square

In the statement of (4.3.9) it is important to notice here that the morphism f' is *not* assumed to be a normal epimorphism. This is used in Proposition (4.3.10) below.

4.3.10 Proposition **Pullback recognition by kernel isomorphism - H**
 In the commutative diagram below, suppose the top sequence is short exact, and $l = \ker(g)$.

$$\begin{array}{ccccccc}
 0 & \longrightarrow & A & \xrightarrow{k} & B & \xrightarrow{f} & C \longrightarrow 0 \\
 & & a \downarrow & & b \downarrow & & c \downarrow \\
 0 & \longrightarrow & X & \xrightarrow{l} & Y & \xrightarrow{g} & Z
 \end{array}$$

Then the map a is an isomorphism if and only if the square on the right is a pullback.

Proof We use kernel pairs to reduce the right side pullback recognition for a morphism of short exact sequences to right side pullback recognition for a morphism of split short

exact sequences: take kernel pairs of f and g to obtain the diagram below.

$$\begin{array}{ccccc}
 KP(f) & \begin{array}{c} \xrightarrow{p_1} \\ \xleftarrow{e} \\ \xrightarrow{p_2} \end{array} & B & \xrightarrow{f} & C \\
 \downarrow r & & \downarrow b & & \downarrow c \\
 KP(g) & \begin{array}{c} \xrightarrow{p'_1} \\ \xleftarrow{e'} \\ \xrightarrow{p'_2} \end{array} & Y & \xrightarrow{g} & Z
 \end{array}$$

Then a is part of the following morphism of split short exact sequences.

$$\begin{array}{ccccc}
 A & \triangleright & KP(f) & \begin{array}{c} \xrightarrow{p_1} \\ \xleftarrow{e} \end{array} & B \\
 \downarrow a \cong & & \downarrow r & & \downarrow b \\
 X & \triangleright & KP(g) & \begin{array}{c} \xrightarrow{p'_1} \\ \xleftarrow{e'} \end{array} & Y
 \end{array}$$

Pullback recognition for split short exact sequences (4.2.8) shows that the square on the right is a pullback. Now, the claim follows with Theorem 4.3.9 of Barr–Kock. \square

4.3.11 Proposition **Normal epimorphism in morphism of short exact sequences - H**
 A morphism of short exact sequences has the properties stated below.

$$\begin{array}{ccccc}
 K & \xrightarrow{k} & X & \xrightarrow{q} & Q \\
 \downarrow \kappa & & \downarrow \xi & & \downarrow \rho \\
 L & \xrightarrow{l} & Y & \xrightarrow{r} & R
 \end{array}$$

- (i) If κ is an isomorphism, then ξ is a normal epimorphism if and only ρ is one such.
- (ii) If ρ is an isomorphism, then κ is a normal epimorphism if and only ξ is one such.

Proof (i) If ξ is a normal epimorphism, then so is ρ by (3.2.7). For the converse, note first that the square on the right is a pullback by (4.3.10). If ρ is a normal epimorphism, the pullbacks preserve it via (PNE), and so ξ is a normal epimorphism as well.

(ii) If ρ is an isomorphism, then (1.6.2) the left hand square is a pullback. If ξ is a normal epimorphism, then it pulls back to the normal epimorphism κ . Now assume that κ is a normal epimorphism. The commutative diagram of short exact sequences below results

from applying functoriality of image factorizations (A.4.4) to ξ and ρ .

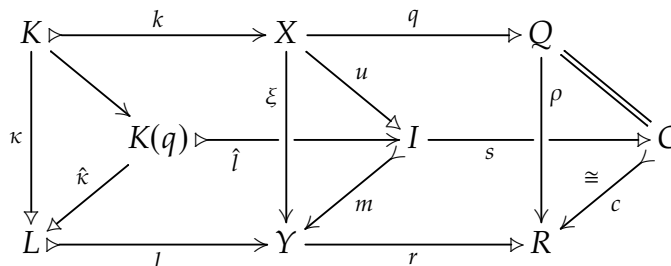

The maps $\hat{\kappa}$ and s are normal epimorphisms by (3.2.7). But $\hat{\kappa}$ is also a monomorphism because $l\hat{\kappa} = m\hat{i}$ is monic. So, κ is an isomorphism by (1.5.7). By part (i), m is a normal epimorphism. As m is also a monomorphism, it is an isomorphism, again by (1.5.7). But then ξ is a normal epimorphism, as was to be shown. \square

4.3.12 Corollary Normal monomorphism in morphism of short exact sequences - H

In the situation of (4.3.10) suppose a is an isomorphism, and c is a normal monomorphism. Then b is also a normal monomorphism.

Proof From (4.3.10) we know that the right hand square is a pullback. So the claim follows from the fact that pullbacks preserve normal monomorphism (1.6.1). \square

Notes

On the Barr–Kock Theorem The original version of Theorem 4.3.9—see [10, Lemma A.5.8], [3], [16]—was considered in the much more general context of a regular category (in the sense of Definition A.4.11). We will, however, not need that stronger version of the result for our purposes.

Exercises

4.3.13 Exercise

Equivalent split extensions

For an arbitrary abelian group A show that the following three short exact sequences are equivalent:

$$\begin{array}{ccccc} A & \xrightarrow{i_1} & A \oplus A & \xrightarrow{pr_2} & A \\ A & \xrightarrow{(1_A, -1_A)} & A \oplus A & \xrightarrow{(1_A, 1_A)} & A \\ A & \xrightarrow{i_2} & A \oplus A & \xrightarrow{pr_1} & A \end{array}$$

4.3.14 Exercise

Give an example of two short exact sequences in a homological category whose sum is not exact.

4.3.15 Exercise

Find an example in the category of groups which shows that the converse of (1.6.3) does not hold:

i.e. in the diagram in (1.6.3) assume y is an isomorphism. Then the left hand square need not be a pushout. - Use (4.3.10) to conclude that properties of pushouts in a homological category are not just duals of properties of pullbacks.

4.4 Normal Pushouts in Homological Categories

For the purpose of constructing di-extensions, normal pushouts have proven to be a useful tool because they are di-extensive. In a homological category, normal pushouts are particularly easy to recognize: Via the recognition criterion of normal pushouts 4.4.2, a pushout is di-extensive if and only if it is normal. Proving this proposition and deriving consequences is the objective of this section. - We will repeatedly refer to the diagram below for notation of a morphism of short exact sequences.

$$\begin{array}{ccccc}
 K & \xrightarrow{k} & X & \xrightarrow{q} & Q \\
 \downarrow \kappa & & \downarrow \xi & & \downarrow \rho \\
 L & \xrightarrow{l} & Y & \xrightarrow{r} & R
 \end{array} \quad (4.4.1)$$

4.4.2 Proposition

Seminormal pushout recognition - H

In a homological category, given a morphism of short exact sequences, as in (4.4.1), the square (R) is a seminormal pushout if and only if κ is a normal epimorphism.

Proof If (R) is a seminormal pushout, then k is a normal epimorphism by (2.9.3). Conversely, suppose k is a normal epimorphism. Consider this commutative diagram whose bottom right square is the pullback of r along ρ .

$$\begin{array}{ccccccc}
 K & \xrightarrow{k} & X & \xrightarrow{q} & Q & & \\
 \downarrow \kappa & \searrow \kappa & \downarrow \xi & \searrow \bar{\xi} & \downarrow \rho & & \\
 L & \xrightarrow{\hat{k}} & P & \xrightarrow{\bar{r}} & Q & & \\
 \downarrow \kappa & \searrow \kappa & \downarrow \xi & \searrow \bar{\rho} & \downarrow \rho & & \\
 L & \xrightarrow{l} & Y & \xrightarrow{r} & R & & \\
 & & & & & & \\
 & & & & & & \\
 & & & & & & \\
 & & & & & & \\
 & & & & & &
 \end{array} \quad (4.4.2)$$

So, the normal epimorphism r pulls back to a normal epimorphism \bar{r} . This makes the upward facing part of the diagram a morphism of short exact sequences. So, $\bar{\xi}$ is a normal epimorphism by (4.3.11), which means that (R) is a seminormal pushout. \square

4.4.3 Corollary

Pullback stability of (semi)normal pushouts - H

In a homological category, a commutative cube of maps has the following properties:

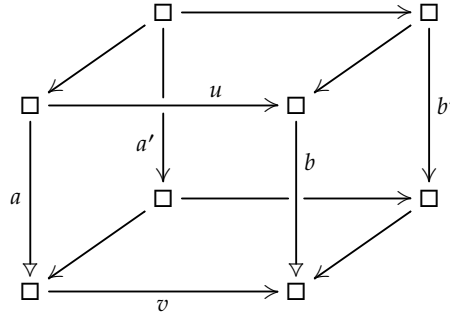

- (i) Suppose the front face is a seminormal pushout with a and b normal epimorphisms. If the two squares on the side are pullbacks, then the back face is a seminormal pushout in which a' and b' are normal epimorphisms.
- (ii) Suppose the front face is a normal pushout. If the side faces as well as the top and bottom faces are pullbacks, then the back face is a normal pushout.

Proof (i) If the front face is a seminormal pushout, then the induced map $K(a) \rightarrow K(b)$ is a normal epimorphism. If the side faces are pullbacks, then both a' and b' are normal epimorphisms. Moreover, we have isomorphisms $K(a) \cong K(a')$ and $K(b) \cong K(b')$ by (1.6.1). But then the induced map $K(a') \rightarrow K(b')$ is a normal epimorphism. So the back face is a seminormal pushout by (4.4.2). The proof (ii) is similar. \square

4.4.4 Corollary

Di-extensive pushouts are normal - H

A pushout square of normal epimorphisms is a di-extensive if and only if it is a normal pushout.

Proof We know from (2.9.5) that every normal pushout in a homologically self-dual category, hence in a homological category, is di-extensive. With Proposition 4.4.2, we see that a di-extensive pushout is a normal pushout. \square

4.4.5 Corollary

Homological \Rightarrow (DPN) - H

Every homological category has the (DPN)-property.

Proof Given a normal map with antinormal decomposition, as in (L) of (4.4.1), then κ is a normal epimorphism. So (R) is a normal pushout, hence is di-extensive. With (2.6.2), we see that dinversion preserves the normal map ξk . \square

4.4.6 Corollary

Sectioned epi of normal epis is normal pushout - H

If square (R) below suppose $(q, r): (\xi \downarrow \alpha) \rightarrow (\rho \downarrow \beta)$ is a morphism of sectioned epimorphisms. Then (R) is a normal pushout.

$$\begin{array}{ccccc}
 K & \xrightarrow{k} & X & \xrightarrow{q} & Q \\
 \downarrow \kappa & & \downarrow \xi \uparrow \alpha & & \downarrow \rho \uparrow \beta \\
 L & \xrightarrow{l} & Y & \xrightarrow{r} & R
 \end{array} \quad (R)$$

Proof We claim that κ is an absolute epimorphism. Indeed, a map $\sigma: L \rightarrow K$ with $k\sigma = \alpha l$ comes from the fact that $q\alpha l = \beta r l = 0$. That $\kappa\sigma = 1_L$ comes from the monic property of l via the computation

$$l\sigma\kappa = \xi k\sigma = \xi\alpha l = l$$

Thus σ is a section of κ . So, κ is a normal epimorphism by (4.1.2). Hence, (R) is a normal pushout by (4.4.2). \square

4.4.7 Corollary

Normal components in morphism of short exact sequences - H

A morphism of short exact sequences, such as (4.4.1) has the following properties.

- (i) If k is an isomorphism, then u is normal, respectively a normal monomorphism, if and only if v is normal, respectively a normal monomorphism.
- (ii) If k is a normal epimorphism, then u is normal if and only if v is normal.
- (iii) If v is a monomorphism, and u is normal, then k is normal.

Proof (i) If k is an isomorphism, then (R) is a pullback (4.3.10). Since r is a normal epimorphism, pulling back along it preserves and reflects normal monomorphisms (4.3.4) and normal maps by (4.3.5).

(ii) If k is a normal epimorphism, then (R) is a seminormal pushout by (4.4.2). Thus, if we factor the given morphism of short exact sequences via the pullback of r along v , then the map \bar{u} in the diagram (4.4.2) is a normal epimorphism. Thus $I(u) = I(\bar{v})$. So u is normal if and only if \bar{v} is normal. By (i), \bar{v} is normal if and only if v is normal.

(iii) If v is a monomorphism, then (L) is a pullback (1.6.2). It preserves the normal map u by (4.4.7). So k is normal. \square

Another way of formulating (4.4.7.ii) is: In a homological category, seminormal pushouts preserve and reflect normal maps.

4.4.8 Corollary

Normal pushout of coproduct/product comparison maps - H

A pair of normal epimorphisms $u: X \rightarrow X'$ and $v: Y \rightarrow Y'$ induces a normal pushout diagram of coproduct/product comparison maps:

$$\begin{array}{ccc} X + Y & \xrightarrow{\gamma_{X,Y}} & X \times Y \\ u+v \downarrow & & \downarrow u \times v \\ X' + Y' & \xrightarrow{\gamma_{X',Y'}} & X' \times Y' \end{array}$$

Proof Via Proposition 4.2.10, we know that the horizontal maps are normal epimorphisms. The map $u + v: X + Y \rightarrow X' + Y'$ is a normal epimorphism because colimits commute with colimits. The map $u \times v$ is a normal epimorphism (3.2.7). To see that the square is a normal pushout, it suffices (4.4.2) to show that the map

$$\gamma_{X,Y}|: K(u + v) \longrightarrow K(u \times v) \cong K(u) \times K(v)$$

is a normal epimorphism. This is indeed the case: $K(u) + K(v)$ maps into $K(u + v)$ and its coproduct/product comparison map is a normal epimorphism to $K(u) \times K(v)$. By (3.2.7) the map $K(u + v) \rightarrow K(u) \times K(v)$ is a normal epimorphism as well, and the claim follows. \square

Any morphism of short exact sequences allows us to construct an associated seminormal pushout as follows:

4.4.9 Lemma

(Semi)normal pushout from morphism of short exact sequences - H

Given a morphism of short exact sequences as on the left, the associated square on the right is a seminormal pushout.

$$\begin{array}{ccccc} K & \xrightarrow{k} & X & \xrightarrow{q} & Q \\ \kappa \downarrow & & \xi \downarrow & & \downarrow \rho \\ L & \xrightarrow{l} & Y & \xrightarrow{r} & R \end{array} \qquad \begin{array}{ccc} L + X & \xrightarrow{\langle 0, q \rangle} & Q \\ \langle l, \xi \rangle \downarrow & & \downarrow \rho \\ X & \xrightarrow{r} & R \end{array}$$

The square on the right is a normal pushout if and only if ρ is a normal epimorphism.

Proof Consider the commutative diagram below; its floor is the pullback of r along ρ ,

and the horizontal sequences are short exact.

$$\begin{array}{ccccc}
 K' & \xrightarrow{\quad} & L + X & \xrightarrow{\langle 0, q \rangle} & R \\
 \downarrow \kappa' & \searrow \kappa' & \downarrow \langle l, \xi \rangle & \searrow & \downarrow \rho \\
 L & \xrightarrow{\quad} & Y \times_R Q & \xrightarrow{\quad} & V \\
 \downarrow \kappa' & \nearrow & \downarrow \bar{\rho} & \nearrow & \downarrow \rho \\
 L & \xrightarrow{l} & Y & \xrightarrow{r} & R
 \end{array}$$

The map κ' is a normal epimorphism because it is sectioned by the coproduct inclusion $i_L: L \rightarrow L + X$ factored through to K' . This renders the front face on the right a seminormal pushout by (4.4.2). So, the comparison map $L + X \rightarrow Y \times_R Q$ is a normal epimorphism. If now ρ is a normal epimorphism, then so are $\bar{\rho}$ and, hence, $\langle l, \xi \rangle$. So, the square on the right is a normal pushout, as was to be shown. \square

The following corollary complements (3.2.10).

4.4.10 Corollary Normal epimorphism recognition - cokernel side - H

In the morphism of short exact sequences in (4.4.1), the maps l and ξ are jointly extremally epimorphic if and only if ρ is a normal epimorphism.

Proof If the maps l and ξ are jointly extremally epimorphic, then ρ is a normal epimorphism by (3.2.10). Conversely, if ρ is a normal epimorphism, then so is $\langle l, \xi \rangle$ by (4.4.9). So, l and ξ are jointly extremally epimorphic. \square

4.4.11 Proposition Normal pushout recognition by kernel pair - H

Assume that the diagram below consists of a commutative square (R) of normal epimorphisms, together with the kernel pairs of f and f' .

$$\begin{array}{ccccc}
 KP(f) & \begin{array}{c} \xleftarrow{p_1} \\ \xrightarrow{e} \\ \xrightarrow{p_2} \end{array} & X & \xrightarrow{f} & Y \\
 \downarrow r & & \downarrow x & & \downarrow y \\
 KP(f') & \begin{array}{c} \xleftarrow{p'_1} \\ \xrightarrow{e'} \\ \xrightarrow{p'_2} \end{array} & X' & \xrightarrow{f'} & Y'
 \end{array} \quad (R)$$

Then the square (R) is a normal pushout if and only if r is a normal epimorphism.

Proof As in the proof of (4.3.10), the kernels of p_1 and p'_1 yield the following morphism of split short exact sequences:

$$\begin{array}{ccccccc}
 0 & \longrightarrow & K(f) & \longrightarrow & KP(f) & \xrightleftharpoons[p_1]{e} & X \longrightarrow 0 \\
 & & \downarrow k & & \downarrow r & \text{(S)} & \downarrow x \\
 0 & \longrightarrow & K(f') & \longrightarrow & KP(f') & \xrightleftharpoons[p'_1]{e'} & X' \longrightarrow 0
 \end{array}$$

By (4.4.7.ii), square (S) is a normal pushout if and only if k is a normal epimorphism. Now if k is a normal epimorphism, then (4.4.7.ii) tells us that r is a normal epimorphism as well. On the other hand, if r is a normal epimorphism, then (4.4.6) says that (S) is a normal pushout, and so k is a normal epimorphism. \square

4.4.12 Proposition

Pullback / seminormal pushout recognition - H

If in the morphism of short exact sequence (4.4.1) the map v is an isomorphism, and k is a normal epimorphism, then (L) is a pullback and a seminormal pushout.

Proof From (4.3.11) we see that u is a normal epimorphism. Next, square (L) is a pullback follows from (1.6.2). But then $K(\alpha) \rightarrow K(\beta)$ is an isomorphism, and so (L) is a seminormal pushout by (4.4.2). \square

4.4.13 Corollary

Normal pushout recognition - H

In the morphism of short exact sequence presented in (4.4.1), square (R) is a normal pushout if and only if k and v are normal epimorphisms. \diamond

Notes

Normal epimorphisms in $\text{SEpi}(\mathcal{X})$ In a homological category \mathcal{X} , any diagram as in (4.4.6) is actually a normal epimorphism in the functor category $\text{SEpi}(\mathcal{X})$ of sectioned epimorphisms in \mathcal{X} . This is so because (co)limits in that functor category are computed object-wise. Thus we may paraphrase (4.4.6) by saying that a normal epimorphism in the category of sectioned epimorphisms over \mathcal{X} has an underlying normal pushout in the \mathcal{X} .

In particular, any double sectioned epimorphism, when considered as a square in \mathcal{X} , is a normal pushout—compare with (A.2.8) and (4.2.7).

Alternate view of the axiom (KSG) Corollary (4.4.10) specializes to axiom (KSG) by choosing $q := \rho := 1_R$. In this case, Lemma 4.4.9 is especially interesting because we find this morphism of split short exact sequences

$$\begin{array}{ccccc}
 K' & \longrightarrow & L + R & \xleftarrow{i_R} & R \\
 \varepsilon \downarrow & & \downarrow \langle l, \varepsilon \rangle & \xleftarrow{\langle 0, 1_R \rangle} & \parallel \\
 L & \xrightarrow{l} & Y & \xleftarrow[\xi]{q} & R
 \end{array}$$

Following [21], we will interpret Y as the 'semidirect product' $Y = L \rtimes_{\varepsilon} R$ of L and R with respect to the 'internal action' given by $\varepsilon: K' \rightarrow L$.

Exercises

4.4.14 Exercise

Short exact sequence / regular pushout-pullback - H

In a homological category, show that a diagram $X \xrightarrow{x} Y \xrightarrow{y} Z$ is a short exact sequence if and only if the square below is a seminormal pushout and a pullback.

$$\begin{array}{ccc} X & \longrightarrow & 0 \\ x \downarrow & & \downarrow \\ Y & \xrightarrow{y} & Z \end{array}$$

4.4.15 Exercise

Morphism of short exact sequences - special case - H

In the morphism of short exact sequences below, assume that a is a normal epimorphism.

$$\begin{array}{ccccc} K & \xrightarrow{k} & X & \xrightarrow{q} & Q \\ \kappa \downarrow & & \xi \downarrow & & \downarrow \rho \\ L & \xrightarrow{l} & Y & \xrightarrow{r} & R \end{array}$$

Show that the induced map $\kappa: K(\xi) \rightarrow K(\rho)$ is a normal epimorphism. - Hint: Apply Exercise 1.9.9 to the morphism (κ, β, η) of composite zero maps.

4.4.16 Exercise

Detection of normal pullbacks fails - H

In a homological category consider a commutative square of normal monomorphisms. If the map of cokernels of two opposing arrows is a normal monomorphism show that the square need not be normal pullback.

4.4.17 Exercise

Linear category from normal pullbacks - H

In a homological category \mathcal{X} , assume that for all objects X and Y the pullback of the canonical inclusions $(1_X, 0): X \rightarrow X \times Y$ and $(0, 1_Y): Y \rightarrow X \times Y$ is a normal pullback. Show that \mathcal{X} is a linear category.

4.5 The (Short) 5-Lemma

In Section 1.11 we proved a version of the Short 5-Lemma, namely (1.11.2), which we termed ‘primordial’ because we needed to assume the map u in a morphism (κ, ξ, ρ) of short exact sequences is a normal map. In the structurally richer environment of a homological category, we can eliminate this assumption and prove the Short 5-Lemma (4.5.1) in the form familiar from abelian categories. It then provides a stepping stone for proving (variants of) the 5-Lemma; see (4.5.2) and (4.5.3).

The Short 5-Lemma provides a useful tool for identifying when a given morphism is an isomorphism. We close this section by explaining how it plays a key role in the definition of the functor Ext^1 .

4.5.1 Theorem

Short 5-Lemma - H

[10, p. 275f] Consider a morphism of short exact sequences.

$$\begin{array}{ccccc}
 K & \xrightarrow{k} & X & \xrightarrow{q} & Q \\
 \kappa \downarrow & & \xi \downarrow & (R) & \downarrow \rho \\
 L & \xrightarrow{\lambda} & Y & \xrightarrow{r} & R
 \end{array}$$

If κ and ρ are isomorphisms, then ξ is an isomorphism as well.

Proof As κ is an isomorphism, the square (R) is a pullback by (4.3.10). Thus ξ is the pullback of the isomorphism ρ . So ξ is an isomorphism as well. \square

Since the proof of the Short 5-Lemma is very concise, let us emphasize that, ultimately, it relies on the (KSG)-property of homological categories: For a split short exact sequence it says that the middle object is generated by the end objects. If then those generating objects are communicated isomorphically by a morphism of split short exact sequences, then so is the middle object. This is the content of the Split Short 5-Lemma (4.2.4). In the previous section, we explained how the kernel pair construction may be used to lift split short exact sequence information to short exact sequence information. This was critical in proving the pullback recognition criterion (4.3.10) which led to the above short proof of (4.5.1).

Some classical diagram lemmas follow immediately from the Short 5-Lemma:

4.5.2 Corollary

5-Lemma - H

4.5.4 Proposition

Product recognition via kernel splitting - H

Consider a short exact sequence such as

$$0 \longrightarrow A \begin{array}{c} \xrightarrow{k} \\ \xleftarrow{q} \end{array} B \xrightarrow{f} C \longrightarrow 0$$

If $qk = 1_A$, then $(q, f): B \rightarrow A \times C$ is an isomorphism, so that (B, q, f) forms a product of A and C .

Proof Together, the maps q and f form this morphism of short exact sequences:

$$\begin{array}{ccccccc} 0 & \longrightarrow & A & \begin{array}{c} \xrightarrow{k} \\ \xleftarrow{q} \end{array} & B & \xrightarrow{f} & C \longrightarrow 0 \\ & & \parallel & & \downarrow (q,f) & & \parallel \\ 0 & \longrightarrow & A & \xrightarrow{(1_A, 0)} & A \times C & \xrightarrow{\pi_C} & C \longrightarrow 0 \end{array}$$

The Short 5-Lemma 4.5.1 shows that (q, f) is an isomorphism. □

4.5.5 Proposition

Pullbacks reflect isomorphisms - H

Consider the morphism of normal epimorphisms below.

$$\begin{array}{ccc} X & \xrightarrow{u} & Y \\ p \downarrow & & \downarrow q \\ R & \xlongequal{\quad} & R \end{array}$$

If pulling this diagram back along $f: S \rightarrow R$ induces an isomorphism $\bar{u}: \bar{X} \rightarrow \bar{Y}$, then u is an isomorphism.

Proof The situation at hand leads to the commutative diagram below.

$$\begin{array}{ccccccc} & & \bar{L} & \xrightarrow{\cong} & L & & \\ & \nearrow \bar{\kappa} & \downarrow & & \downarrow \kappa & \searrow & \\ \bar{K} & \xrightarrow{\cong} & K & & K & & \\ \downarrow & & \downarrow & & \downarrow & & \\ \bar{X} & \xrightarrow{\bar{u}} & \bar{Y} & \xrightarrow{\quad} & Y & & \\ \downarrow & \nearrow \cong & \downarrow & & \downarrow & \nearrow u & \\ \bar{X} & \xrightarrow{\quad} & X & \xrightarrow{f} & R & & \\ \downarrow & & \downarrow \bar{q} & & \downarrow p & & \\ S & \xrightarrow{f} & S & \xrightarrow{f} & R & & \\ \downarrow \bar{p} & & \downarrow & & \downarrow & & \\ S & \xrightarrow{f} & R & & R & & \end{array}$$

The front and back faces of the bottom cube are pullbacks, and the top cube is formed from the kernels of p, q, \bar{p}, \bar{q} . Therefore (1.6.1) the maps $\bar{K} \rightarrow K$ and $\bar{L} \rightarrow L$ are isomorphisms. By the 5-Lemma $\bar{\kappa}$ is an isomorphism. It follows that κ is an isomorphism. Now, apply the Short 5-Lemma (4.5.1) to the right hand side of the diagram to see that u is an isomorphism. This was to be shown. \square

This is closely related to another view on homological categories, as explained in Section 4.10; see, in particular, Definition 4.10.6. As a sibling to the pullback cancellation results (A.1.6) and (4.3.8), we have:

4.5.6 Theorem

2-out-of-3 property for pullbacks II - H

[10, p. 242], [9, p. 36f], [53] In the commutative diagram below let e be a normal epimorphism.

$$\begin{array}{ccccc} A & \longrightarrow & B & \longrightarrow & C \\ \downarrow & & \downarrow e & & \downarrow \\ X & \longrightarrow & Y & \longrightarrow & Z \end{array}$$

If two out of three of the commutative rectangles in this diagram are pullbacks, then so is the third.

Proof By Proposition A.1.6 it only remains to consider the case where the outer rectangle and the square on the left are pullbacks. In the commutative diagram below, note that \bar{c} is a normal epimorphism because e is one such; see (3.2.7.i).

$$\begin{array}{ccccccc} A & \longrightarrow & B & \longrightarrow & C & \longrightarrow & C \\ \searrow^{x^*f} & & \searrow^f & & \parallel & & \\ \cong \downarrow & & & & & & \\ x^*y^*C & \xrightarrow{\bar{x}} & y^*C & \longrightarrow & C & \longrightarrow & C \\ \hat{c} \swarrow & & \bar{c} \swarrow & & \parallel & & \\ a=\bar{b} \downarrow & & e \downarrow & & \downarrow & & \\ X & \xrightarrow{x} & Y & \xrightarrow{y} & Z & \xrightarrow{c} & C \end{array}$$

Now we have two normal epimorphisms to pull back along x :

- (1) e pulls back to a because the left hand square is a pullback.
- (2) \bar{c} pulls back to \hat{c} .

The map x^*f is an isomorphism because both, the front outer diagram and the bottom outer diagram are pullbacks along one and the same map yx . But then f is an isomorphism because (4.5.5) pulling the normal epimorphisms e and \bar{c} back along x reflects isomorphisms. \square

We close this section by taking a first step toward the construction of a fundamental invariant used in homological algebra: the extension functor. We begin by introducing relevant terminology.

4.5.7 Terminology

Extension / morphism of extensions

Recall (1.9.1) that given a short exact sequence

$$\varepsilon \quad K \twoheadrightarrow U \longrightarrow V$$

we refer to ε as an *extension of K over Q* , or a *cover of Q by K* .

A morphism from an extension ε to an extensions μ is given by a morphism of the underlying short exact sequences:

$$(k,u,v) \begin{array}{c} \varepsilon \\ \downarrow \\ \mu \end{array} \quad \begin{array}{ccccc} K & \twoheadrightarrow & U & \longrightarrow & V \\ k \downarrow & & u \downarrow & & v \downarrow \\ L & \twoheadrightarrow & X & \longrightarrow & V \end{array}$$

4.5.8 Definition

Equivalent extensions

Two extensions ε and μ of K over Q are *equivalent* if they admit a morphism of the form $(1_K, \beta, 1_Q)$:

$$(1_K, u, 1_V) \begin{array}{c} \varepsilon \\ \downarrow \\ \mu \end{array} \quad \begin{array}{ccccc} K & \twoheadrightarrow & X & \longrightarrow & V \\ 1_K \downarrow & & u \downarrow & & 1_V \downarrow \\ K & \twoheadrightarrow & Y & \longrightarrow & V \end{array}$$

In (4.5.8), the map u is an isomorphism by the Short 5-Lemma (4.5.1). Thus an equivalence of extensions provides a very selected form of isomorphism between their middle objects, resulting in an equivalence relation on the class of all extensions of K and over Q . This leads to:

4.5.9 Definition

Extension equivalence class - H

Given objects K and Q , we define

$$\text{ext}(V, K) := \{\text{extensions of } K \text{ over } V\} / \text{'equivalence'}$$

Let's analyze what happens in the definition of $\text{ext}(V, K)$: Often times, the collection of extensions of K over V forms a proper class on which 'equivalence of extensions' is an equivalence relation. Even in the category Ab of abelian groups, equivalence classes are

proper classes themselves. So, strictly speaking, $\text{ext}(V, K)$ is a conglomerate. In many varieties, it is possible to choose representatives of the equivalence classes in $\text{ext}(V, K)$ which form a proper set. In those cases, $\text{ext}(V, K)$ may be treated as a proper set, and

$$\text{ext}(-, K) : \mathcal{X} \rightarrow \text{Set}_* : V \mapsto \text{ext}(V, K).$$

is a contravariant functor. - For a summary of the early history of Ext we refer the reader to the notes in Mac Lane [62, p. 103].

Notes

Retractionable normal monomorphism vs. sectionable normal epimorphism Proposition 4.5.4 says that whenever a normal monomorphism admits a left inverse, then this left inverse is a product projection. Recalling that the notion of short exact sequence is self-dual, let's examine this!

The dual of (4.5.4) is: 'If a normal epimorphism admits a right inverse, then this right inverse is a product inclusion'. While true in abelian categories, in general, it is false in the category Grp of groups. Why? - A right inverse of f is a monomorphism which, in a semiabelian environment, *is not necessarily normal*. Consequence: if f admits a right inverse i which happens to be a kernel, then i is a product inclusion. . . as may be seen by dualizing the proof of (4.5.4).

Exercises

4.5.10 Exercise

Suppose in a semiabelian category \mathcal{X} , the inclusion of an object X into the sum $X + Y$ is normal. Show that the canonical map $X + Y \rightarrow X \times Y$ is an isomorphism.

Biproduct recognition

4.5.11 Exercise

Show that these two extensions in the category Ab of abelian groups are equivalent by filling in the missing arrow in the middle.

$$\begin{array}{ccccc} \mathbb{Z}/2 & \xrightarrow{\Delta} & \mathbb{Z}/2 \oplus \mathbb{Z}/2 & \xrightarrow{+} & \mathbb{Z}/2 \\ \parallel & & \vdots & & \parallel \\ \mathbb{Z}/2 & \xrightarrow{(1,0)} & \mathbb{Z}/2 \oplus \mathbb{Z}/2 & \xrightarrow{pr_2} & \mathbb{Z}/2 \end{array}$$

4.5.12 Exercise

For a prime number $p \in \mathbb{Z}$, show that there are p distinct equivalence classes of abelian group extensions of \mathbb{Z}/p over \mathbb{Z}/p .

$\text{Ext}(\mathbb{Z}/p, \mathbb{Z}/p)$

4.5.13 Exercise

In each of the categories familiar to you, e.g., Ab, Grp, . . . find inequivalent extensions with isomorphic middle objects; see the remark after (4.5.8).

Inequivalent extensions with isomorphic middle objects

4.5.14 Exercise

Short 5-lemma in Set_*

Compare with Exercise 5.1.3. Show that the short 5-lemma holds in the category Set_* of pointed sets, even though Set_* does *not* satisfy the (KSG)-condition, hence is not a homological category.

4.6 The (3×3) -Lemma

In Section 2.6, we already found necessary and sufficient conditions under which the four border cases of the 3×3 -Lemma hold. In the axiomatically richer environment of a homological category, we show that the ‘middle cases’ of the (3×3) -Lemma are valid as well; see (4.6.1).

Given a di-extension, we then explain in (4.6.2) how its initial, central, and terminal objects are related.

4.6.1 Theorem

(3×3) -Lemma - H

[9, p. 45f], [10, p. 279] In the commutative diagram below, assume that each column is a short exact sequence, and that $eb = 0$.

$$\begin{array}{ccccc}
 M & \xrightarrow{a} & L & \xrightarrow{d} & I \\
 \downarrow u & & \downarrow v & & \downarrow w \\
 & \text{(NM)} & & & \\
 K & \xrightarrow{b} & X & \xrightarrow{e} & Q \\
 \downarrow x & & \downarrow y & & \downarrow z \\
 & \text{(NE)} & & & \\
 J & \xrightarrow{c} & R & \xrightarrow{f} & S
 \end{array} \tag{4.6.1}$$

If any two of the rows are exact, then so is the third.

Proof *Border cases: the middle row is known to be short exact* From (4.4.5), we know that homological categories enjoy the (DPN)-property. So, if the middle row is exact, then the claim follows from (2.6.3).

Middle case: the top and bottom rows are known to be short exact Since d and f are normal epimorphisms, (4.4.13) shows that (NE) is a normal pushout. So, e is a normal epimorphism.

Thus, we find ourselves in this situation:

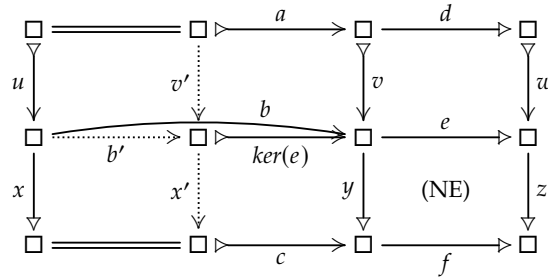

Via the kernel property of $\ker(e)$ we obtain maps v' and b' , unique with the properties

$$va = \ker(e)v' \quad \text{and} \quad \ker(e)b' = b.$$

Here, we need the hypothesis $eb = 0$. Finally, the kernel property of c yields x' , unique with $cx' = y\ker(e)$. A border case of the (3×3) -Lemma shows that the sequence $x'v'$ is short exact.

We claim that the two squares on the left commute. Indeed,

$$\ker(e)b'u = bu = va = \ker(e)v'.$$

So, the monomorphic property of $K(e)$ shows that $v' = b'u$. Moreover,

$$cx = yb = y\ker(e)b' = cx'b'$$

So, the monomorphic property of c shows that $x = x'b'$. By the Short 5-Lemma (4.5.1), b' is an isomorphism, and so we see that the middle row of the original diagram is short exact. - This completes the proof. \square

Next, we explain how, in a di-extension, the initial, central, and terminal objects are related. This involves the meet and join of the normal subobjects of the central object.

4.6.2 Proposition

Internal structure of a di-extension - H

If $K, L \triangleleft X$ are normal subobjects that fit a di-extension, such as (4.6.1), then the sequences below are short exact.

$$\begin{array}{ccc} K \wedge L & \xrightarrow{va=bu} & X \xrightarrow{(y,e)} R \times_S Q \\ K \vee L & \longrightarrow & X \xrightarrow{fy=ze} S \end{array}$$

In particular, $K \wedge L = M$ and $K \vee L = K(fy)$ are normal subobjects of X .

Proof To establish the first of the short exact sequences, note that $M = K \wedge L$ since the top left square in (4.6.1) is a pullback. Next, construct the commutative diagram below by pulling the vertical sequence on the right of (4.6.1) back along f .

$$\begin{array}{ccccccc}
 M & \xrightarrow{a} & L & \xrightarrow{d} & I & \xlongequal{\quad} & I \\
 \parallel & & \downarrow v & \circlearrowleft & \downarrow & & \downarrow w \\
 M & \xrightarrow{\quad} & X & \xrightarrow{\gamma} & R \times_S Q & \xrightarrow{\quad} & Q \\
 & & \downarrow y & & \downarrow & \circlearrowleft & \downarrow z \\
 & & R & \xlongequal{\quad} & R & \xrightarrow{f} & S
 \end{array}$$

Then the comparison map γ induced by e and y is a normal epimorphism as the square (NE) in (4.6.1) is a regular pushout. The top middle square is then a pullback by (4.3.6). Consequently, $K(\gamma) = K(d) = M = K \wedge L$ by (1.6.1).

To prove that the second sequence is exact, first consider the morphism of short exact sequences

$$\begin{array}{ccccc}
 K \wedge L & \xrightarrow{a} & L & \xrightarrow{d} & I \\
 \downarrow u & \circlearrowleft & \downarrow v' & & \downarrow i \\
 K & \xrightarrow{b'} & K \vee L & \xrightarrow{q} & (K \vee L)/K
 \end{array}$$

where v' and b' are the induced factorizations of v and b through the join. Further, q is the cokernel of the normal monomorphism b' . The induced map i is a monomorphism by (4.3.6), and is a normal epimorphism by (4.4.10). So, i is an isomorphism. Now consider the (3×3) -diagram

$$\begin{array}{ccccc}
 K & \xrightarrow{b'} & K \vee L & \xrightarrow{q} & (K \vee L)/K \\
 \parallel & & \downarrow & & \downarrow wi \\
 K & \xrightarrow{b} & X & \xrightarrow{e} & Q \\
 \downarrow & & \downarrow ze & & \downarrow z \\
 0 & \longrightarrow & S & \xlongequal{\quad} & S
 \end{array}$$

and use the (3×3) -Lemma (4.6.1) to conclude that its middle column is a short exact sequence. \square

4.6.3 Corollary

The join in a di-extension - H

If K and L are normal subobjects of X , that fit a di-extension such as (4.6.1), then the two

exact sequences of Proposition 4.6.2 may be spliced to form the exact sequence

$$0 \longrightarrow K \wedge L \longrightarrow K \vee L \longrightarrow R \times_S Q \longrightarrow S \longrightarrow 0.$$

Proof This is an application of the Pure Snake Lemma 2.2.1. \square

4.6.4 Corollary

2-step extensions from di-extension - H

Associated to a di-extension such as (4.6.1) is this commutative diagram of 2-step extensions:

$$\begin{array}{ccccccccc}
 0 & \longrightarrow & M & \longrightarrow & L & \xrightarrow{wd} & Q & \longrightarrow & S & \longrightarrow & 0 \\
 & & \parallel & & \downarrow i_L & & \uparrow pr_Q & & \parallel & & \\
 0 & \longrightarrow & M & \longrightarrow & K \vee L & \xrightarrow{\xi} & Q \times_S R & \longrightarrow & S & \longrightarrow & 0 \\
 & & \parallel & & \uparrow b' & & \downarrow pr_R & & \parallel & & \\
 0 & \longrightarrow & M & \longrightarrow & K & \xrightarrow{cx} & R & \longrightarrow & S & \longrightarrow & 0
 \end{array}$$

Proof The 2-step extension in the middle comes from applying the Pure Snake Lemma 2.2.1 to this morphism of short exact sequences:

$$\begin{array}{ccccccc}
 0 & \longrightarrow & M = K \wedge L & \xrightarrow{va=bu} & X & \longrightarrow & Q \times_S R \longrightarrow 0 \\
 & & \downarrow & & \parallel & & \downarrow \\
 0 & \longrightarrow & K \vee L & \longrightarrow & X & \xrightarrow{ze=fy} & S \longrightarrow 0
 \end{array}$$

We know that $\xi = (e, y) \circ i$. This implies the commutativity of square (I) and (II). \square

4.6.5 Corollary

Chinese Remainder Theorem - H

If $K, L \triangleleft X$ are such that $K \vee L = X$, then there is a functorial isomorphism

$$\frac{X}{K \wedge L} \cong \frac{X}{L} \times \frac{X}{K}.$$

Proof As in the proof of (5.5.6), we obtain the di-extension

$$\begin{array}{ccccc}
 K \wedge L & \longrightarrow & L & \longrightarrow & L/(K \wedge L) \\
 \downarrow & & \downarrow & & \parallel \\
 K & \longrightarrow & X & \longrightarrow & X/K \\
 \downarrow & & \downarrow & & \downarrow \\
 K/(K \wedge L) & \xlongequal{\quad} & X/L & \longrightarrow & 0
 \end{array}$$

The result now follows from the first sequence in Proposition 4.6.2. □

4.6.6 Corollary **Quotient of join is product - H**
 If $K, L \triangleleft K \vee L \leq X$, then there is a functorial isomorphism

$$\frac{K \vee L}{K \wedge L} \cong \frac{K}{K \wedge L} \times \frac{L}{K \wedge L}.$$

Proof This is a combination of (4.6.5) and (5.5.6). □

Notes **On the join of two normal subobjects**

In a homological category, if K and L are normal subobjects of an object X which fit into a di-extension, then we found in (4.6.2) that their join is again normal in X .

This prompts the question: can we say anything about the join $K \vee L$ of two arbitrarily given normal subobjects K and L of X ? The answer is ‘yes’, and we will come back to this topic in Section 5.5.

Exercises

4.6.7 Exercise **Kernel pair of a normal epimorphism - H**
 Given a short exact sequence

$$N \triangleright \xrightarrow{\alpha} X \xrightarrow{f} \triangleright Q$$

show that $N \times N \rightarrow KP(f) \rightarrow Q$ is a short exact sequence as well.

4.6.8 Exercise **Product of short exact sequences - H**
 In a homological category \mathcal{X} do the following:

- (i) Use the (3×3) -Lemma (4.6.1) to show that the product of two short exact sequences in a semiabelian category is short exact.
- (ii) For a fixed object X in \mathcal{X} , determine if the functor $X \times -: \mathcal{X} \rightarrow \mathcal{X}$ is exact.
- (iii) For a fixed object X , and a short exact sequence $A \xrightarrow{\alpha} B \xrightarrow{\beta} C$ in \mathcal{X} , show that the sequences below are short exact.

$$X \times A \xrightarrow{1_X \times \alpha} X \times B \xrightarrow{\beta \text{pr}_B} C \quad \text{and} \quad A \xrightarrow{(0, \alpha)} X \times B \xrightarrow{1_X \times \beta} X \times C$$

4.6.9 Exercise **Third Isomorphism Theorem from (3×3) -Lemma - H**
 If K and N are normal subobjects of X such that $K \leq N$, then N/K is normal in X/K , and the sequence below is short exact.

$$N/K \triangleright \longrightarrow X/K \longrightarrow \triangleright X/N$$

4.6.10 Exercise

Image / kernel in $\text{SES}(\mathcal{X})$ - H

In the category $\text{SES}(\mathcal{X})$ associated to a homological category \mathcal{X} the following conditions are equivalent for a morphism $(\kappa, \xi, \rho): \varepsilon \rightarrow \varphi$:

- (i) (κ, ξ, ρ) admits a pointwise image factorization in $\text{SES}(\mathcal{X})$.
- (ii) (κ, ξ, ρ) has a pointwise kernel in $\text{SES}(\mathcal{X})$.
- (iii) The sequence $K(\kappa) \rightarrow K(\xi) \rightarrow K(\rho)$ in \mathcal{X} is short exact.

4.6.11 Exercise

Normal closure of image / Cokernel in $\text{SES}(\mathcal{X})$ - H

In the category $\text{SES}(\mathcal{X})$ associated to a homological category \mathcal{X} the following conditions are equivalent for a morphism $(\kappa, \xi, \rho): \varepsilon \rightarrow \varphi$:

- (i) The sequence of normal closures $\overline{I(\kappa)} \rightarrow \overline{I(\xi)} \rightarrow \overline{I(\rho)}$ in \mathcal{X} is short exact.
- (ii) (κ, ξ, ρ) has a pointwise cokernel in $\text{SES}(\mathcal{X})$.

4.6.12 Exercise

Normal image / kernel / cokernel in $\text{SES}(\mathcal{X})$ - H

In the category $\text{SES}(\mathcal{X})$ associated to a homological category \mathcal{X} the following conditions are equivalent for a morphism $(\kappa, \xi, \rho): \varepsilon \rightarrow \varphi$ for which κ, ξ, ρ have normal images in \mathcal{X} .

- (i) (κ, ξ, ρ) admits a pointwise image factorization in $\text{SES}(\mathcal{X})$.
- (ii) (κ, ξ, ρ) admits a pointwise kernel in $\text{SES}(\mathcal{X})$.
- (iii) (κ, ξ, ρ) has a pointwise cokernel in $\text{SES}(\mathcal{X})$.
- (iv) The sequence $K(\kappa) \rightarrow K(\xi) \rightarrow K(\rho)$ in \mathcal{X} is short exact.

4.7 Commuting Morphisms

Two subgroups K and L of a group G *commute* if the identity $kl = lk$ holds for every $k \in K$ and $l \in L$. In this section make the notion of commuting subobjects and, more generally, of commuting maps, categorical. This provides a foundation for the study of abelian group objects in a homological category, see Section 4.8, and enables a study of central subobjects later on. The approach taken here is based on the work of Bourn [15, 18], Huq [49] and Borceux–Bourn [10].

Recall (A.3) that a pair of maps $(r: A \rightarrow X, s: B \rightarrow X)$ in a category \mathcal{C} is *jointly extremal-*

epimorphic provided in any commutative diagram

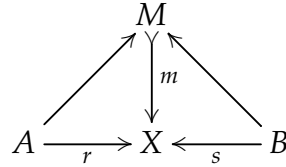

in which m is a monomorphism, it is necessarily an isomorphism. The intuition is that ' r and s together generate all of X '. If \mathcal{C} has binary sums, then this is equivalent to saying that the arrow $\langle r, s \rangle: A + B \rightarrow X$ is an extremal epimorphism.

A pointed category with finite limits is said to be *unital* when for any pair of objects A, B , the product inclusions

$$A \xrightarrow{(1_A, 0)} A \times B \xleftarrow{(0, 1_B)} B$$

are jointly extremal-epimorphic. This is the case, for example, in the category of groups, the category of rings, and categories of modules over a ring, as is easily checked by hand. In fact, all homological categories are unital, as follows immediately from the (KSG)-axiom (Definition 4.1.1). Here, the condition is equivalent to asking that the comparison map $\gamma_{A,B}: A + B \rightarrow A \times B$ is an extremal epimorphism, for all A and B .

In unital categories, the notion of commuting maps is well defined:

4.7.1 Definition

Commuting morphisms

Two maps $f: A \rightarrow X$ and $g: B \rightarrow X$ in a unital category *commute* if there exists a morphism $\mu_{f,g}$ which renders the diagram

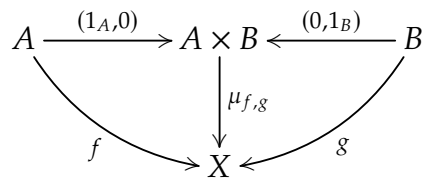

commutative. The map $\mu_{f,g}$ is called the *multiplication*² of f by g .

Using the comparison map $\gamma_{A,B}: A + B \rightarrow A \times B$ in the context of a homological category, the maps f and g in (4.7.1) commute if and only if the universal map $\langle f, g \rangle: A + B \rightarrow X$ factors through $\gamma_{A,B}$ as shown in the square below, which is a seminormal pushout by

²In [10] this map is called the *collaborator* of f and g .

(4.4.2).

$$\begin{array}{ccc}
 A + B & \xrightarrow{\gamma_{A,B}} & A \times B \\
 \langle f, g \rangle \downarrow & & \downarrow \mu_{f,g} \\
 X & \xlongequal{\quad} & X
 \end{array}$$

In Proposition 4.7.2 and its corollaries (4.7.9) and (4.7.10) we present basic properties of commuting maps.

4.7.2 Proposition

Properties of commuting maps

Given commuting maps $f: A \rightarrow X$ and $g: B \rightarrow X$ the following hold:

- (i) The multiplication map $\mu_{f,g}$ of f by g is unique.
- (ii) If $\varphi: A' \rightarrow A$ and $\psi: B' \rightarrow B$ are arbitrary maps, then $f\varphi$ commutes with $g\psi$, and $\mu_{f\varphi, g\psi} = \mu_{f,g} \circ (\varphi \times \psi)$.
- (iii) If $\xi: X \rightarrow Y$ is arbitrary, then ξf commutes with ξg , and $\mu_{\xi f, \xi g} = \xi \mu_{f,g}$.
- (iv) If $u: R \rightarrow Y$ commutes with $v: S \rightarrow Y$, then $f \times u: A \times R \rightarrow X \times Y$ commutes with $g \times v: B \times S \rightarrow X \times Y$. If $\tau_{R,B}: R \times B \rightarrow B \times R$ denotes the twist map, then $\mu_{f \times u, g \times v} = (\mu_{f,g} \times \mu_{u,v}) \circ (1_A \times \tau_{R,B} \times 1_S)$.

Proof (i) By assumption, the inclusions $(1_A, 0): A \rightarrow A \times B$ and $(0, 1_B): B \rightarrow A \times B$ are jointly epimorphic. So, if $\mu_{f,g}$ exists, then it is unique.

(ii), (iii), (iv) are left as exercises. □

4.7.3 Definition

Central map

A morphism $f: A \rightarrow X$ in a unital category is called *central* if it commutes with the identity map on X .

4.7.4 Proposition

Properties of central maps

For central maps $f: A \rightarrow X$ and $g: B \rightarrow X$ the following hold:

- (i) f commutes with g , and $\mu_{f, 1_X} \circ (1_X \times g) = \mu_{f,g} = \mu_{1_X, g} \circ (f \times 1_X)$.
- (ii) $\langle f, g \rangle: A + B \rightarrow X$ is central and, if $H = (1_A \times \tau_{B,X}) \circ (\gamma_{A,B} \times 1_X)$, then

$$\mu_{f, 1_X} \circ (1_A \times \mu_{1_X, g}) \circ H = \mu_{\langle f, g \rangle, 1_X} = \mu_{1_X, g} \circ (\mu_{f, 1_X} \times 1_B)$$

Proof We give a compact proof involving coproducts; the general case is left as an exercise. A proof of (i) may be read off of this commutative diagram:

$$\begin{array}{ccccccc}
 A \times B & \xleftarrow{\gamma_{A,B}} & A + B & \xlongequal{\quad} & A + B & \xlongequal{\quad} & A + B & \xrightarrow{\gamma_{A,B}} & A \times B \\
 \downarrow 1_A \times g & & \downarrow 1_{A+g} & & \downarrow & & \downarrow f+1_B & & \downarrow f \times 1_B \\
 A \times X & \xleftarrow{\gamma_{A,X}} & A + X & & \langle f, g \rangle & & X + B & \xrightarrow{\gamma_{X,B}} & X \times B \\
 \downarrow \mu_{f,1_X} & & \downarrow \langle f, 1_X \rangle & & \downarrow & & \downarrow \langle 1_X, g \rangle & & \downarrow \mu_{1_X, g} \\
 X & \xlongequal{\quad} & X & \xlongequal{\quad} & X & \xlongequal{\quad} & X & \xlongequal{\quad} & X
 \end{array}$$

To check the claim of (ii), consider this commutative diagram:

$$\begin{array}{ccccccc}
 (A + B) \times X & \xrightarrow{\gamma_{A,B} \times 1_X} & A \times B \times X & \xrightarrow{1_A \times \tau_{B,X}} & A \times X \times B & \xrightarrow{1_A \times \mu_{1_X, g}} & A \times X \\
 & \searrow H & & & \downarrow \mu_{f,1_X} \times 1_B & & \downarrow \mu_{f,1_X} \\
 & & & & X \times B & \xrightarrow{\mu_{1_X, g}} & X
 \end{array}$$

Using (i), we find that

$$\mu_{\langle f, g \rangle, 1_X} \circ (1_{A+B}, 0) = \mu_{f, g} \circ \gamma_{f, g} = \langle f, g \rangle$$

Further, $\mu_{\langle f, g \rangle, 1_X} \circ (0, 1_X): X \rightarrow (A + B) \times X$ equals 1_X . So, (ii) holds. \square

Finally, we single out the special case where the identity map on an object commutes with itself:

4.7.5 Definition

Commutative object

An object in a unital category is called *commutative* if 1_X commutes with itself.

A commutative object always carries the structure of a commutative unital magma which is unique:

4.7.6 Proposition

Commutative object is commutative monoid

In a unital category \mathcal{C} , any commutative object carries the structure of an internal commutative monoid (X, μ) .

Proof We treat the case where \mathcal{C} has coproducts. The general case is left as an exercise.

If $\mu: X \times X \rightarrow X$ multiplies the identity map on X by itself, then μ automatically satisfies the requirements for a unitary magma structure on X . To see that the multiplication μ is

commutative, consider the twist map on $X \times X$:

$$\tau = (pr_2, pr_1): X \times X \longrightarrow X \times X$$

Then $\mu\tau$ is also a unitary magma structure on X . Such a structure is unique, and so $\mu = \mu\tau$; i.e., μ is commutative.

To see that μ is associative, we want to know that the rectangle below commutes.

$$\begin{array}{ccccc} X + (X \times X) & \xrightarrow{\gamma := \gamma_{X, X \times X}} & X \times (X \times X) & \xrightarrow[\cong]{\alpha} & X \times X \times X & \xrightarrow{1 \times \mu} & X \times X \\ & & & & \mu \times 1 \downarrow & & \downarrow \mu \\ & & & & X \times X & \xrightarrow{\mu} & X \end{array}$$

Since $\alpha\gamma$ is an epimorphism, it suffices to show that the composites

$$\mu(1 \times \mu)\alpha\gamma \quad \text{and} \quad \mu(\mu \times 1)\alpha\gamma$$

are equal. This is, indeed, the case. On the summand $X \times X$ we find that both composites equal μ , while on the summand X we find that both composites equal 1_X . Thus the square commutes, and this proves that μ is associative; i.e., (X, μ) is an internal commutative monoid. \square

4.7.7 Commuting subobjects

In the special case where commuting maps f and g represent A and B as subobjects, we say that the subobjects commute. This is legitimate, since any two monomorphisms representing the same subobject are related by a unique isomorphism. The terminology of commuting maps / subobjects is motivated by examples such as (4.7.13), (4.7.14), and (4.7.15). In the context of a homological category, commuting maps and commuting subobjects are related via the following results.

4.7.8 Proposition

Normal quotient of commuting maps - H

Given commuting maps $f: A \rightarrow X$ and $g: B \rightarrow X$ in a homological category, if $f = f'p$ and $g = g'q$ with normal epimorphisms p and q , then f' commutes with g' , and $\mu_{f,g} = \mu_{f',g'} \circ (p \times q)$. \diamond

4.7.9 Corollary

Commuting maps vs. commuting images - H

Two maps $f: A \rightarrow X$ and $g: B \rightarrow X$ commute if and only if the image of f commutes with the image of g .

Proof Using the image factorizations $A \xrightarrow{p} I \xrightarrow{i} X$ and $B \xrightarrow{q} J \xrightarrow{j} X$ of f and g respectively, the claim follows from (4.7.8). \square

4.7.10 Corollary **Direct images preserve commuting subobjects - H**
 Let K and L be commuting subobjects of X . If $f: X \rightarrow Y$ is a normal epimorphism, then $f(K)$ and $f(L)$ commute as well. \diamond

Let us now turn to situations in which two normal subobjects commute.

4.7.11 Theorem **Normal subobjects with zero intersection commute - H**
 If two subobjects K and L of X have intersection 0 and are normal in their join, that is $K, L \triangleleft K \vee L \leq X$, then K and L commute.

Proof With $K \wedge L = 0$, (4.6.6) tells us that

$$K \vee L \cong \frac{K \vee L}{K \wedge L} \cong \frac{K}{K \wedge L} \times \frac{L}{K \wedge L} \cong K \times L$$

So, if k and l represent K and L as subobjects of X , then $\langle k, l \rangle$ factors uniquely through $K \times L$. \square

4.7.12 Corollary **Quotient to make normal subobjects commute - H**
 Given normal subobjects K and L of X , let $q: X \rightarrow Y := X/(K \wedge L)$ be the quotient map. Then $q(K)$ and $q(L)$ are commuting normal subobjects of Y .

Proof We show that $q(K)$ and $q(L)$ are normal subobjects of Y whose intersection is 0 . So, the claim follows with (4.7.11). Indeed, both of K and L contain $K \wedge L$ as a subobject. So, (4.9.2) implies that $q(K)$ and $q(L)$ are normal subobjects of Y . Now construct the cube below from the pullback faces on the left and on the right, together with q and its restrictions to K and L .

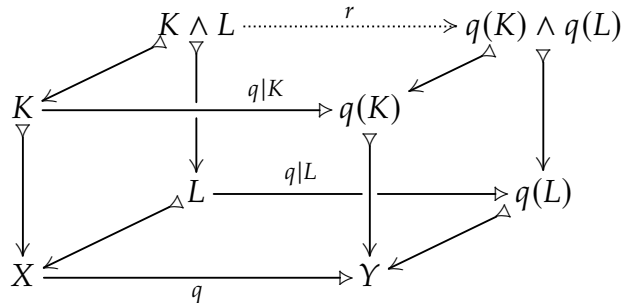

Then the horizontal maps of the front and bottom faces have $K \wedge L$ as a common kernel. So these faces are pullbacks by 4.3.10. The pullback property of the right hand face yields

a map $r: (K \wedge L) \rightarrow (q(K) \wedge q(L))$, which renders the entire diagram commutative. The back face is seen to be a pullback by combining pullback concatenation (A.1.6) and the 2-of-3-property of pullbacks in a homological category (4.3.8). But then r is a normal epimorphism by the (PNE)-condition. Its image is $q(K) \wedge q(L) = q(K \wedge L) = 0$. This implies the claim. \square

4.7.13 Example

Commuting subgroups

If K and L are subgroups of a (multiplicative) group X , such that every element of K commutes with every element of L , then the inclusion functions of K and L in X conspire to define a group morphism

$$\mu = \mu_{K,L}: K \times L \rightarrow X: (k, l) \mapsto k \cdot l.$$

Conversely, if the inclusions of K and L into X admit a multiplication map $\mu: K \times L \rightarrow X$, then

$$k \cdot l = \mu(k, 1) \cdot \varphi(1, l) = \mu((k, 1) \cdot (1, l)) = \mu((1, l) \cdot (k, 1)) = \mu(1, l) \cdot \mu(k, 1) = l \cdot k.$$

So K and L commute in X . — In short, ‘different factors in a product of groups commute with one another’ is what we use for a categorical definition of commuting subgroups and commuting morphisms.

Applied to the special case where $K = L = X$, we see that X commutes with itself as a subobject if and only if the group operation on X is commutative.

4.7.14 Example

Commuting Lie subalgebras

Two sub-Lie-algebras K and L of a Lie algebra X commute as subobjects of X if and only if the bracket $[k, l] \in X$ vanishes whenever $k \in K$ and $l \in L$. To see this, consider first the case where the inclusions of K and L in X admit a multiplication $\mu = \mu_{K,L}$. We then find

$$\mu(k, l) = \mu((k, 0) + (0, l)) = \mu(k, 0) + \mu(0, l) = k + l.$$

Consequently,

$$[k, l] = [\mu(k, 0), \mu(0, l)] = \mu([k, 0], [0, l]) = \mu(0, 0) = 0.$$

On the other hand, if $[k, l] = 0$ whenever $k \in K$ and $l \in L$, then the linear map defined by $\psi(k, l) = k + l$ is a morphism of Lie algebras, because

$$\begin{aligned} [\psi(k, l), \psi(k', l')] &= [k + l, k' + l'] = [k, k'] + [k, l'] + [l, k'] + [l, l'] \\ &= [k, k'] + [l, l'] = \psi([k, k'], [l, l']) \\ &= \psi([(k, l), (k', l')]). \end{aligned}$$

So ψ is the multiplication induced by K and L .

4.7.15 Example

Commuting subobjects of associative algebras

If K and L are subalgebras of an associative algebra X , then subobjects K and L commute if and only if for each $k \in K$ and $l \in L$ we have that $kl = 0$. The argument is similar to the one given for Lie algebras.

Notes

On the origin of ‘commuting morphisms’ In [15, 18], D. Bourn builds on earlier work of S. A. Huq [49], extending definitions and results from a context which is essentially equivalent to that of semiabelian categories, to the new and far more general setting of unital categories.

Indeed, the property of being a unital category is much weaker than being homological: a variety of universal algebras is unital if and only if it contains a unique constant 0 , and a binary operation $+$ satisfying the identities $x + 0 = x = 0 + x$; see [10].

Weaker conditions First of all, let us notice that the notions of commuting maps and commutative object are fully viable whenever the maps in (4.7.1) are jointly epimorphic. In particular, Proposition 4.7.6 still holds. Such categories are called *weakly unital* in [66].

Exercises

4.7.16 Exercise

Properties of central maps - H

For arbitrary objects A and X , show the following:

- (i) The zero map $0: A \rightarrow X$ is central.
- (ii) $f: A \rightarrow X$ is central if and only if f commutes with every map $g: B \rightarrow X$; compare (4.7.4).
- (iii) If $f: A \rightarrow X$ is central, and $g: X \rightarrow Y$ is a normal epimorphism, then $gf: A \rightarrow Y$ is central.

4.7.17 Exercise

Normal closure of diagonal - H

Given an object X , show that the inclusion of X into the normal closure \bar{X} of the diagonal in $X \times X$ is a split monomorphism.

4.7.18 Exercise

Complete the proof of (4.7.4) and (4.7.6).

Write versions of these proofs which don't involve coproducts.

4.8 Commutative Objects in Homological Categories

In Section 4.7, we introduced the concept of commutative object. Then we showed in (4.7.6) that it is always a commutative monoid. Here, we prove the remarkable result ([20, 3.D], [10]) which says that, in a homological category, a commutative object is actually an internal abelian group; see (4.8.2). For this reason, we shall refer to a commutative object in a homological category as an *abelian object*.

To this end, we rely on the following lemma.

4.8.1 Lemma Unitary magma structure is product projection - H

If (X, μ) is a unitary magma structure in a homological category, then $(X \times X, pr_1, \mu)$ is a product.

Proof We use the 2-out-of-3 property for pullbacks (4.5.6) on this diagram:

$$\begin{array}{ccccc}
 & & & & 1_X \\
 & & & & \curvearrowright \\
 X & \xrightarrow{(0,1_X)} & X \times X & \xrightarrow{\mu} & X \\
 \downarrow & & \downarrow pr_1 & & \downarrow \\
 0 & \longrightarrow & X & \longrightarrow & 0
 \end{array}$$

The outer rectangle as well as the square on the left are pullbacks. Since pr_1 is a split epimorphism, it is a normal epimorphism, and so the theorem tells us that the square on the right is a pullback. So, $(X \times X, pr_1, \mu)$ is a product. \square

Summarizing what we found about commutative objects in Section 4.7 combined with present developments, we obtain:

4.8.2 Theorem Internal abelian group in a homological category - H

For an object X in a homological category the following hold:

- (i) X admits an internal unitary magma structure (X, μ) if and only if 1_X commutes with itself.
- (ii) If (X, μ) is an internal unitary magma structure on X , then μ is commutative and associative, and there exists a unique map $i: X \rightarrow X$ such that (X, μ, i) is an internal abelian group.

Proof In view of Proposition 4.7.6, it only remains to find an inversion $i: X \rightarrow X$ so that (X, μ, i) is an internal abelian group. By Lemma 4.8.1, $(X \times X, pr_1, \mu)$ is a product. With (4.2.9) we obtain a unique map $(1_X, i): X \rightarrow X \times X$ so that $pr_1 \circ (1_X, i) = 1_X$ and

$\mu \circ (1_X, i) = 0$. So, i is a multiplicative right inverse for μ . Since μ is commutative, i is also a multiplicative left inverse. With (6.1.3) we conclude that $i: X \rightarrow X$ is the one and only two-sided inverse operation on the commutative monoid X which turns it into an internal abelian group. \square

4.8.3 Definition

An *abelian object* in a homological category is an object X which admits a (necessarily unique) internal abelian group structure (X, μ, i) .

By the above, any commutative object in a homological category is an abelian object.

4.8.4 Corollary Intersection of commuting subobjects is abelian - H

If subobjects K and L of X commute, then $K \wedge L$ is an abelian object.

Proof The cube below commutes and explains why the multiplication induced by the inclusions k and l of K and L into X give rise to a multiplication $\mu_{k \wedge l, k \wedge l}$ of the inclusion $k \wedge l$ of $K \wedge L$ into X with itself.

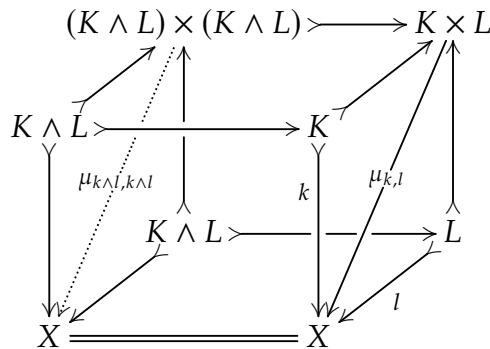

Proposition 4.2.10 tells us that the vertical arrow on the left in the diagram

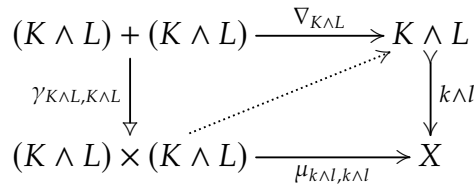

is a normal and, hence, a strong epimorphism. The induced lifting is a multiplication of $1_{K \wedge L}$ with itself. Theorem 4.8.2 implies that $K \wedge L$ is an internal abelian group. \square

Combining (4.8.4) with Corollary 4.7.12 yields:

4.8.5 Corollary

Direct image of intersection - H

Given normal subobjects K and L of X , let $q: X \rightarrow Y := X/(K \wedge L)$ be the quotient map. Then $q(K) \wedge q(L) \leq Y$ is an abelian object. \diamond

4.8.6 Corollary

Subdiagonal of subobject of an abelian object - H

If $f: C \rightarrow A$ represents C as a subobject of an abelian object (A, μ, i) , then the sequence below is short exact.

$$C \rightrightarrows \xrightarrow{(1_C, f)} C \times A \xrightarrow{\mu \circ ((i \circ f) \times 1_A)} A$$

Proof With the information available, we construct this commutative diagram:

$$\begin{array}{ccccc}
 0 & \longrightarrow & A & \xlongequal{\quad} & A \\
 \downarrow & & \downarrow (0, 1_A) & & \downarrow \\
 C & \xrightarrow{(1_C, f)} & C \times A & \xrightarrow{\mu \circ ((i \circ f) \times 1_A)} & A \\
 \parallel & & \downarrow pr_C & & \downarrow \\
 C & \xlongequal{\quad} & C & \longrightarrow & 0
 \end{array}$$

The columns, as well as the top and bottom rows are short exact. The composite of the maps in the middle row vanishes. With the (3×3) -lemma (4.6.1) we conclude that the middle row is short exact as well. \square

As a companion to Theorem 4.8.2 we have the Proposition 4.8.7 below.

4.8.7 Proposition

Recognizing abelian object via normal diagonal - H

An object X admits an internal abelian group structure (X, μ, i) if and only if the diagonal Δ_X is a normal monomorphism. If so, then the sequence below is short exact.

$$X \rightrightarrows \xrightarrow{\Delta_X} X \times X \xrightarrow{\mu(i \times 1_X)} X$$

Proof If X admits an internal abelian group structure then the stated sequence is short exact by Corollary (4.8.6). Conversely, if the monomorphism Δ_X is normal, then we construct a multiplication on X from a suitable choice of $D: X \times X \rightarrow Q$ representing $coker(\Delta_X)$. This construction proceeds through the following steps.

1. First we show that we may choose $Q = X$ in a manner so that D may be interpreted as ‘addition of first coordinate minus second coordinate’.
2. From D we extract a candidate $i: X \rightarrow X$ for an internal inverse operation on X .
3. Then $\mu := D(1_X \times i)$ is the addition on X .

Step 1 With an arbitrary representation $q: X \times X \rightarrow Q$ of $\text{coker}(\Delta_X)$, we obtain the short exact sequence in the commutative diagram below.

$$\begin{array}{ccccc} X & \xrightarrow{\Delta_X} & X \times X & \xrightarrow{q} & Q \\ \parallel & & \downarrow pr_2 & \circlearrowleft & \downarrow \\ X & \xlongequal{\quad} & X & \longrightarrow & 0 \end{array}$$

The right hand square is a pullback, implying that $q \circ (1_X, 0): X \rightarrow Q = K(Q \rightarrow 0)$ is an isomorphism. Therefore $D := [q(1_X, 0)]^{-1}q$ also represents a cokernel for Δ_X with the property that $D(1_X, 0) = 1_X$.

Step 2 Since $D(1_X, 0) = 1_X$ while $D\Delta_X = 0$, we take $i := D(0, 1_X)$ as a candidate for the inverse operation i . It is seen to be an isomorphism on X via the following diagram:

$$\begin{array}{ccccc} X & \xrightarrow{\Delta_X} & X \times X & \xrightarrow{D} & X \\ \parallel & & \downarrow pr_1 & \circlearrowleft & \downarrow \\ X & \xlongequal{\quad} & X & \longrightarrow & 0 \end{array}$$

Again, the right hand square is a pullback, implying that $i := D \circ (0, 1_X)$ is the induced isomorphism $K(pr_1) \rightarrow K(X \rightarrow 0)$. To show that the proposed Step 3 is applicable, we need to confirm that $i^2 = 1_X$. To this end, we check that the diagram below commutes by verifying that this is the case for each of the maps in the jointly extremal collection $(1_X, 0, 0), (0, 1_X, 0), (0, 0, 1_X)$.

$$\begin{array}{ccccc} X \times X \times X & \xrightarrow{1_X \times \Delta_X \times 1_X} & X \times X \times X \times X & \xrightarrow{1_X \times 1_X \times (pr_2, pr_1)} & X \times X \times X \times X \\ (pr_1, pr_3) \downarrow & & & & \downarrow D \times D \\ X \times X & \xrightarrow{D} & X & \xleftarrow{D} & X \times X \end{array}$$

Now, we find:

$$\begin{aligned} i^2 &= [D \circ (0, 1_X)] \circ [D \circ (0, 1_X)] \\ &= D \circ (0, D \circ (0, 1_X)) \\ &= D \circ (D \circ (1_X, 1_X), D \circ (0, 1_X)) \\ &= D \circ (D \times D) \circ (1_X \times 1_X \times (pr_2, pr_1)) \circ (1_X \times \Delta_X \times 1_X) \circ (1_X, 1_X, 0) \\ &= D \circ (pr_1, pr_3) \circ (1_X, 1_X, 0) \\ &= D \circ (1_X, 0) = 1_X \end{aligned}$$

Step 3 With $\mu := D \circ (1_X \times i)$ we now find $\mu \circ (1_X, 0) = D \circ (1_X, 0) = 1_X$ by design, and

$$\begin{aligned}
 \mu \circ (0, 1_X) &= D \circ (1_X, i) \circ (0, 1_X) \\
 &= D \circ (0, i) \\
 &= D \circ (0, D \circ (0, 1_X)) \\
 &= [D \circ (0, 1_X)] \circ [D \circ (0, 1_X)] \\
 &= i^2 = 1_X
 \end{aligned}$$

Thus μ is an internal magma structure on X and, hence, determines uniquely the structure of an internal abelian group object on X . \square

If (A, μ, i) is an internal abelian group object in a homological category then we use Proposition 4.8.7 to identify the kernel of μ :

4.8.8 Definition

Antidiagonal in abelian group object - H

If (A, μ, i) is an abelian group object, then the *antidiagonal* in $A \times A$ is the subobject represented by $(i, 1_A): A \rightarrow A \times A$.

4.8.9 Proposition

Kernel of multiplication in an abelian group object - H

If (A, μ, i) is an abelian group object, then its antidiagonal is the kernel of μ .

Proof From (4.8.7) we know that $\Delta_A = K(\mu \circ (i \times 1_A))$. In the composite

$$[\mu \circ (i \times 1_A)] \circ \Delta_A = \mu \circ [(i \times 1_A) \circ \Delta_A] = \mu \circ (i, 1_A)$$

the map $(i \times 1_A)$ is an isomorphism, and this implies the claim. \square

Notes

On recognizing abelian objects via a normal diagonal map Proposition 4.8.7 is a variation on Proposition 3.2.15 in [10], where the concept of a normal subobject is strictly weaker from what we consider here. The two approaches coincide in the context of a semiabelian category.

On the collection of all abelian objects in a homological, respectively semiabelian, category In Section 7.6, we study the global structure of the collection of these abelian objects. In a homological category \mathcal{X} , they form a left almost abelian category which is full and replete in \mathcal{X} ; see Theorem 7.6.2. If \mathcal{X} is semiabelian, then the abelian objects form an abelian category.

4.9 Alternate Characterizations of Homological Categories

We offer several alternate characterizations of what separates normal categories from homological ones. For example (4.9.1), in the context of a normal category, turning the conclusion of Short 5-Lemma into a structural axiom, implies the validity of the (KSG)-condition. We emphasize that this is far from true in an arbitrary \mathcal{Z} -exact category which does not satisfy the (AEN)-condition. This is explained in detail in Section 4.10.

Building on (4.9.1), we present in (4.9.2) further criteria which characterize the separation between normal and homological categories. Among these, we single out criterion (IV) which already appeared in the work of Hofmann [48, Ax. XII]. For additional information on early works generalizing the framework of abelian categories to non-commutative settings, see [51].

4.9.1 Proposition

Short 5-Lemma implies the (KSG)-Axiom - \mathbb{N}

Any normal category in which the Split Short 5-Lemma holds is homological.

Proof We verify the (KSG)-property. Let $m: M \rightarrow X$ be a monomorphism through which k and x factor via morphisms $\tilde{k}: K \rightarrow M$ and $\tilde{x}: Q \rightarrow M$. Then we obtain the diagram below in which $k = m\tilde{k}$ and $x = m\tilde{x}$:

$$\begin{array}{ccccc}
 K & \xrightarrow{\tilde{k}} & M & \begin{array}{c} \xrightarrow{q \circ m} \\ \xleftarrow{\tilde{x}} \end{array} & Q \\
 \parallel & & \downarrow m & & \parallel \\
 K & \xrightarrow{k} & X & \begin{array}{c} \xrightarrow{q} \\ \xleftarrow{x} \end{array} & Q
 \end{array}$$

Then \tilde{x} is a section for qm . Further, $\tilde{k} = \ker(qm)$ follows by direct verification. Thus, the diagram above is a morphism of split short exact sequence to which we apply the Split Short 5-Lemma, and conclude that m is an isomorphism. So, the (KSG)-condition holds. \square

4.9.2 Corollary

Conditions which are equivalent to (KSG) - \mathbb{N}

In a normal category \mathcal{X} , the following conditions are equivalent:

- (I) \mathcal{X} is homological.
- (II) The Short 5-Lemma holds in \mathcal{X} .
- (III) The Split Short 5-Lemma holds in \mathcal{X} .

(IV) \mathcal{X} satisfies *Hofmann's Axiom* [48, Ax. XII]: whenever in a morphism of short exact sequences, as in (4.9.2) below, the map ξ is a monomorphism and ρ is a normal monomorphism, then ξ is a normal monomorphism.

(V) For a morphism of short exact sequences in \mathcal{X} ,

$$\begin{array}{ccccc}
 K & \xrightarrow{k} & X & \xrightarrow{q} & Q \\
 \parallel & & \downarrow \xi & & \downarrow \rho \\
 K & \xrightarrow{\xi k} & Y & \xrightarrow{r} & R
 \end{array} \tag{4.9.2}$$

whenever ρ is a normal monomorphism, then ξ is a normal monomorphism.

(VI) For a morphism of short exact sequences in \mathcal{X} ,

$$\begin{array}{ccccc}
 K & \xrightarrow{k} & X & \xrightarrow{r\xi} & Q \\
 \downarrow \kappa & & \downarrow \xi & & \parallel \\
 L & \xrightarrow{l} & Y & \xrightarrow{r} & Q
 \end{array} \tag{4.9.2}$$

whenever κ is a normal epimorphism, then ξ is a normal epimorphism.

Proof The implication (I) \Rightarrow (II) is Theorem 4.5.1; (II) \Rightarrow (III) is clear. (III) \Rightarrow (I) is (4.9.1); (I) \Rightarrow (V) by (4.4.7.i); (I) \Rightarrow (VI) by (4.4.13); (V) \Rightarrow (IV) is clear.

To see that (IV) \Rightarrow (II), consider the commutative diagram below which is constructed from the morphism of short exact sequences in the front. Assuming that κ and ρ are isomorphisms, we need to show that ξ is an isomorphism.

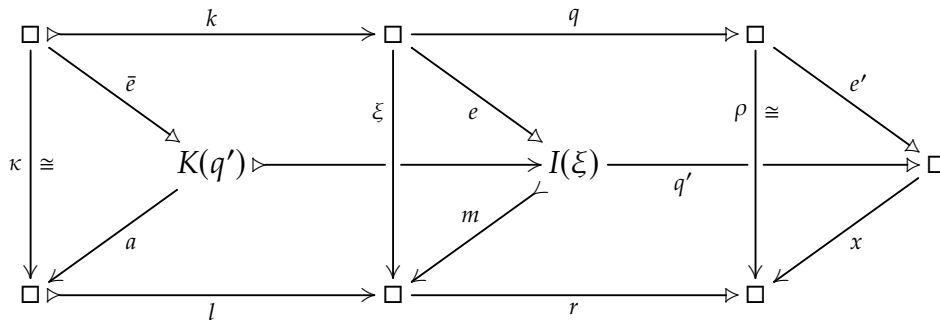

In the above diagram, the composite $\xi = me$ is the image factorization of ξ . The upward square on the right is the pushout of e along q . So, q' and e' are normal epimorphisms. The pushout property of this square yields the map x , uniquely rendering the right hand

side of the diagram commutative. But then e' is a monomorphism as well, hence is an isomorphism.

The universal property of the kernel $K(q')$ yields \bar{e} uniquely rendering the upward square on the left commutative. This face is a pullback since e' is monic. So \bar{e} is a normal epimorphism via the (PNE)-property. The universal property of the kernel l yields a uniquely rendering the downward square on the left commutative. The monic property of l shows that the triangle on the left commutes as well. But then the normal epimorphism \bar{e} is also monic, hence is an isomorphism. The Primordial Short 5-Lemma (1.11.2) shows that e is an isomorphism.

Thus a and x are isomorphisms as well. By hypothesis (IV), m is a normal monomorphism. Another application of the Primordial Short 5-Lemma shows that m is an isomorphism. So, ξ is an isomorphism, as was to be shown.

To see that (VI) \Rightarrow (II), consider the situation where κ in (4.9.2) is an isomorphism. Then ξ is a normal epimorphism by (VI), hence an isomorphism by the Primordial Short 5-Lemma 1.11.2, which holds in homologically self-dual categories and, hence, in normal categories. \square

Note how (V) and (VI) supplement the (HSD)-conditions in Section 2.5.

Notes **On Hofmann's approach to generalizing abelian categories**

In [48], F. Hofmann presents an axiomatic framework which, while inspired by that of abelian categories, includes non-abelian categories such as Grp as well. He works with (normal) monomorphisms and (normal) epimorphisms under the assumption that every morphism has an essentially unique epi/mono factorization; his axioms (V) and (VI). Later he also assumes that every epimorphism is normal; Ax (XI). Combined with his Ax (XII), this implies that the (ANN)-condition holds. So, as we would predict, he is then able to prove that the border cases of the (3×3) -Lemma hold. - The axiom we single out in (4.9.2) is his Ax (XII.2).

4.10 Protomodularity and the Fibration $\text{SEpi}(\mathcal{X}) \rightarrow \mathcal{X}$

In this section, we explain the relationship between homological categories, as presented here, and Bourn's pioneering work [14] which led to the crucial concept of *protomodularity*. Given a category \mathcal{X} , Bourn analyzed the associated category whose objects are sectioned epimorphisms³; see (A.2.1) for background.

The category $\text{SEpi}(\mathcal{X})$ is a functor category. To see this, let \mathfrak{r} denote the category whose graph is . . .

$$\mathfrak{r} := \quad 0 \begin{array}{c} \xrightarrow{\pi} \\ \xleftarrow{\sigma} \end{array} 1 \quad \pi\sigma = 1_1$$

Then $\text{SEpi}(\mathcal{X}) = \mathcal{X}^{\mathfrak{r}}$. Consequently:

4.10.1 Proposition

(Co)Limits in $\text{SEpi}(\mathcal{X})$

Given a category \mathcal{X} , assume that \mathcal{X} admits (co)limits over a small category D . Then $\text{SEpi}(\mathcal{X})$ admits (co)limits over D , and these are computed object-wise. \diamond

4.10.2 Corollary

Inheritance of properties of $\text{SEpi}(\mathcal{X})$ from \mathcal{X}

If \mathcal{X} is z-exact, linear, di-exact, normal, homological, semiabelian, or abelian, then so is $\text{SEpi}(\mathcal{X})$. \diamond

The inclusion of $[0] \rightarrow \mathfrak{r}$ which sends 0 to 1 induces the forgetful functor $\pi: \text{SEpi}(\mathcal{X}) \rightarrow \mathcal{X}$. It sends a sectioned epimorphism $(p \downarrow x)$ where $p: X \rightarrow Y$ to its codomain Y . Proposition A.2.5 and A.2.6 together show that the functor π is a Grothendieck bifibration⁴ as soon as pullbacks of split epimorphisms and pushouts of split monomorphisms exist in \mathcal{X} . For a given object R in \mathcal{X} , we consider the fiber of π over R :

4.10.3 Definition

Sectioned category over a fixed object

For a fixed object R in a category \mathcal{X} , the category of sectioned epimorphisms over R is $\text{SEpi}_R(\mathcal{X})$ has

- (i) *objects* all objects of $\text{SEpi}(\mathcal{X})$ of the form $(p: E \rightarrow R \text{ with section } x: R \rightarrow E)$;
- (ii) *morphisms* all morphisms of sectioned epimorphisms of the form

$$\begin{array}{ccc} X & \xrightarrow{h} & Y \\ \begin{array}{c} \uparrow \downarrow \\ q \uparrow \downarrow \\ \downarrow \uparrow \\ R \end{array} & & \begin{array}{c} \uparrow \downarrow \\ r \uparrow \downarrow \\ \downarrow \uparrow \\ R \end{array} \\ & & \text{=====} \\ & & R \end{array} \quad (4.10.3)$$

³As we know from Example 3.1.4, such a sectioned epimorphism need not a normal map.

⁴For a finitely complete category \mathcal{X} , the functor $\pi: \text{SEpi}(\mathcal{X}) \rightarrow \mathcal{X}$ is also known as the *fibration of points*.

4.10.4 Proposition

$\text{SEpi}_R(\mathcal{X})$ is pointed

For any object R in any category \mathcal{X} , the category $\text{SEpi}_R(\mathcal{X})$ has a zero object given by $(1_R \downarrow 1_R)$. \diamond

If the category \mathcal{X} be finitely bicomplete, then a morphism $f: Q \rightarrow R$, yields the *change-of-base functors* $f^*: \text{SEpi}_R(\mathcal{X}) \rightarrow \text{SEpi}_Q(\mathcal{X})$ and $f_*: \text{SEpi}_R(\mathcal{X}) \rightarrow \text{SEpi}_Q(\mathcal{X})$ defined, respectively, by pulling back and pushing out, as in (A.2.5) and (A.2.6).

4.10.5 Definition

Conservative functor

A functor $F: \mathcal{X} \rightarrow \mathcal{Y}$ is *conservative* if it reflects isomorphisms.

Thus F is conservative if, whenever it sends a morphism h in \mathcal{X} to an isomorphism $F(h)$ in \mathcal{Y} , then h is an isomorphism. Here is Bourn's view of protomodularity, cf. (4.5.5):

4.10.6 Definition

Protomodularity

[14, 16] A finitely complete category \mathcal{X} is (*Bourn*) *protomodular* if, for every morphism $f: Q \rightarrow R$ in \mathcal{X} , its change-of-base functor $f^*: \text{SEpi}_R(\mathcal{X}) \rightarrow \text{SEpi}_Q(\mathcal{X})$ is conservative.

This condition is particularly interesting when \mathcal{X} is pointed, because the change-of-base functor along $0: 0 \rightarrow R$

$$0^*: \text{SEpi}_R(\mathcal{X}) \longrightarrow \text{SEpi}_0(\mathcal{X}) \cong \mathcal{X}$$

returns the kernel of a given sectioned epimorphism as in this morphism in $\text{SEpi}(\mathcal{X})$:

$$\begin{array}{ccc} K(q) & \triangleright \longrightarrow & X \\ 0=\bar{q} \downarrow \uparrow \bar{x}=0 & & q \downarrow \uparrow x \\ 0 & \longrightarrow & R \end{array}$$

Thus 0^* takes a sectioned epimorphism $(q \downarrow r)$ and sends it to $K(q)$, viewed as a sectioned epimorphism over 0 . We may thus think of it as the *kernel functor* and denote it $K_R: \text{SEpi}_R(\mathcal{X}) \rightarrow \mathcal{X}$. Accordingly, a morphism $(h, 1_R): (q \downarrow x) \rightarrow (r \downarrow y)$ yields the commutative diagram below.

$$\begin{array}{ccccc} K(q) & \xrightarrow{\ker(q)} & X & \begin{array}{c} \xleftarrow{q} \\ \xrightarrow{x} \end{array} & R \\ K_R(h) \downarrow & & \downarrow h & & \parallel \\ K(r) & \xrightarrow{\ker(r)} & Y & \begin{array}{c} \xleftarrow{r} \\ \xrightarrow{y} \end{array} & R \end{array}$$

4.10.7 Proposition

Protomodularity for pointed categories

A finitely complete pointed category \mathcal{X} is protomodular if and only if, for each object R of \mathcal{X} , the kernel functor $K_R: \text{SEpi}_R(\mathcal{X}) \rightarrow \mathcal{X}$ reflects isomorphisms.

Proof To see why \Leftarrow is true, consider change-of-base along $f: Q \rightarrow R$, as in the diagram below.

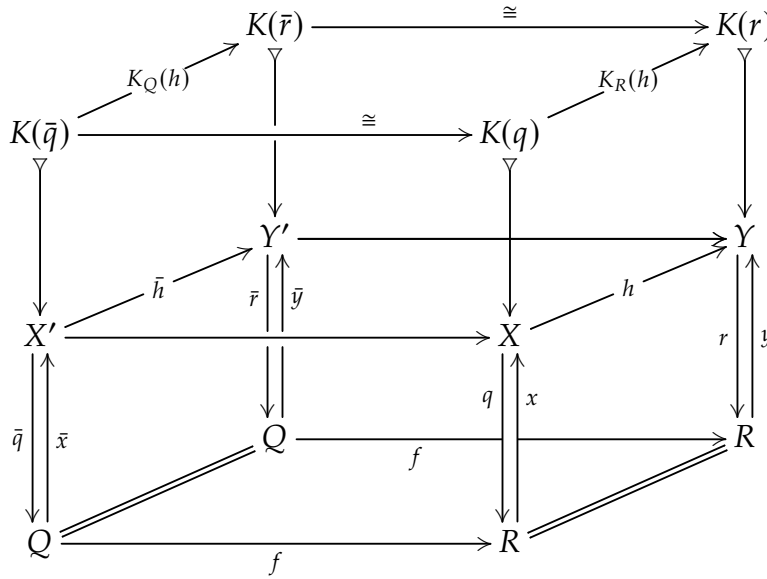

The front and back faces of the bottom block are constructed as pushouts. Therefore, the top two horizontal maps are isomorphisms; which yields the identity $K_Q \circ f^* \cong K_R$.

If \bar{h} is an isomorphism, then we must show that h is an isomorphism. But if \bar{h} is an isomorphism, then so is $K_Q(\bar{h})$ and, hence, $K_R(h)$. Since K_R is an isomorphism, so is h . This means that f^* is conservative, as was to be shown. \square

In any homological category, the (KSG)-condition is satisfied by definition, while (4.2.4) implies that K_R reflects isomorphisms for every object R . So by (4.10.7), any homological category is protomodular. Actually, the equivalence between protomodularity and (KSG) is true in a far more general context:

4.10.8 Corollary

Protomodularity vs. the (KSG)-condition

A finitely complete pointed category \mathcal{X} is Bourn protomodular if and only if the (KSG)-condition holds.

Proof First suppose \mathcal{X} is protomodular. To see that the (KSG)-condition is satisfied, consider a sectioned epimorphism $(q \downarrow x)$, whose section and kernel lift through a monomor-

phism m , as in this diagram:

$$\begin{array}{ccccc}
 K & \xrightarrow{\kappa} & M & \xrightleftharpoons[q \circ m]{\sigma} & Q \\
 \parallel & & \downarrow m & & \parallel \\
 K & \xrightarrow{k} & X & \xrightleftharpoons[x]{q} & Q
 \end{array}$$

As in the proof of (4.9.1), we see that $k = \ker(qm)$. By protomodularity, m is an isomorphism. So k and x are extremally epimorphic; i.e., the (KSG)-condition holds.

Now assume that (KSG) holds and consider the diagram

$$\begin{array}{ccccc}
 K & \xrightarrow{k} & X & \xrightleftharpoons[x]{q} & R \\
 \cong \downarrow \bar{h} & & \downarrow h & & \parallel \\
 L & \xrightarrow{l} & Y & \xrightleftharpoons[y]{r} & R
 \end{array}$$

where k, l are the respective kernels of q and r and the restriction of h to a map $K \rightarrow L$ is an isomorphism. Taking kernel pairs vertically, by (A.1.8) we find a following split epimorphism of effective equivalence relations, together with its kernel.

$$\begin{array}{ccccc}
 K & \xrightarrow{\bar{k}} & KP(h) & \xrightleftharpoons[\bar{x}]{\bar{q}} & R \\
 \parallel \parallel \parallel \parallel \parallel & & \uparrow m \downarrow & & \parallel \parallel \parallel \parallel \parallel \\
 K & \xrightarrow{k} & X & \xrightleftharpoons[x]{q} & R
 \end{array}$$

By the (KSG)-property, the upward pointing arrow m is a monomorphism. Again from (A.1.8), we deduce that h is a monomorphism. Now we may use the (KSG)-property once more to see that h is an isomorphism. \square

We may ask if a pointed finitely complete category in which the conclusion of the Split Short 5-Lemma holds satisfies the (KSG)-condition. The answer is ‘no’, as is demonstrated by the following example.

4.10.9 Example

Split Short 5-Lemma but not (KSG)

Theorem 4.1 in [68] implies that a version of the Split Short 5-Lemma (where the split epimorphisms in the diagram are supposed to be normal epis) holds in the category consisting of all Hopf algebras over a given field. However, by the results of [36], this category does not satisfy the (KSG)-condition.

Conclusion: The protomodularity condition is subtly stronger than asking that the Split Short 5-Lemma holds. On the other hand, recall (4.9.1) which says, in a normal category, the Split Short 5-Lemma is equivalent to the (KSG)-condition.

4.10.10 Borceux–Bourn homological categories

In the notes to Section 4.1 we called a category is *Borceux–Bourn homological* when it is pointed, finitely complete, admits coequalizers of kernel pairs, preserves normal epimorphisms under base change, and has the (KSG)-property. We explain now that this agrees with the original definition of Borceux and Bourn: a pointed, regular (A.4.11) and protomodular category.

4.10.11 Proposition

BB-homological categories

A category is Borceux–Bourn homological if and only if it is pointed, regular and protomodular.

Proof Corollary 4.10.8 takes care of the equivalence between protomodularity and the (KSG)-condition. Then, in both situations—pointed plus (KSG) plus the given (co)limits on the one hand, pointed plus protomodular plus the given (co)limits on the other—normal and regular epimorphisms coincide, so that regularity is equivalent to pullback-stability of normal epimorphisms. \square

Notes

On the classifying properties of the fibration of points A red thread in the foundational work of D. Bourn is the interpretation of categorical-algebraic properties in terms of the fibration of points. We saw that protomodularity amounts to the condition that the change-of-base functors are conservative. Another example is the fact that a pointed finitely bicomplete category is abelian if and only if the change-of-base functors are equivalences (4.10.14). See [11] and the references there for a proof of this fact and for further examples.

Relationship to internal actions The category of points over an object R may be interpreted as a category of non-abelian modules over R . We will develop this point of view within the context of *internal R -actions*.

Exercises

4.10.12 Exercise

Isomorphisms in $\text{SEpi}_R(\mathcal{X})$

Given an arbitrary category \mathcal{X} , identify the isomorphisms in $\text{SEpi}_R(\mathcal{X})$.

4.10.13 Exercise

(Co)limits in $\text{SEpi}_R(\mathcal{X})$

If the category \mathcal{X} admits (co)limits modeled on a small category D , show that so does $\text{SEpi}_R(\mathcal{X})$.

4.10.14 Exercise

Show that a pointed finitely bicomplete category is abelian if and only if each of the change-of-base functors K_R is an equivalence.

Abelianness and the functors K_R

4.11 The Mal'tsev Property

We explain how being a homological category relates to a property of internal relations (6.3): each internal reflexive relation is automatically an equivalence relation. This connects to work of Mal'tsev in the context of universal algebra [64].

4.11.1 Definition

Mal'tsev category

A finitely complete category is a *Mal'tsev category* if every reflexive relation is an equivalence relation.

4.11.2 Example

Mal'tsev varieties

A variety of algebras is a Mal'tsev category if and only if it is a Mal'tsev variety; that is, there exists a ternary operation $p(x, y, z)$ such that

$$p(x, x, z) = z \quad \text{and} \quad p(x, z, z) = x.$$

This operation defines a non-commutative affine structure via the interpretation $p(x, y, z)$ gives the 'vector sum' of x and z relative to y . The defining equations may thus be seen as a version of the parallelogram rule. For example, for a group G , setting

$$p(x, y, z) := xy^{-1}z$$

turns G into a non-commutative affine space: any $y \in G$ may be turned into a neutral element by placing it into the second coordinate.

4.11.3 Example

Monoids

The variety of monoids is not a Mal'tsev variety. Indeed, the order relation \leq may be considered as an internal relation on the monoid \mathbb{N} of natural numbers. It is a reflexive relation which is not symmetric.

The following result explains the terminology used in (4.2.7):

4.11.4 Proposition

Characterization of Mal'tsev categories

For a finitely complete category \mathcal{X} , the following conditions are equivalent:

(I) in a double sectioned epimorphism

$$\begin{array}{ccc}
 U & \xleftarrow{n} & V \\
 \uparrow s & \xrightarrow{g} & \uparrow t \\
 X & \xleftarrow{m} & Y \\
 \downarrow u & \xrightarrow{f} & \downarrow v
 \end{array}$$

which forms a pullback square $fu = vg$, the sections s and n are jointly extremal-epimorphic;

(II) every reflexive relation is transitive;

(III) every reflexive relation is symmetric;

(IV) \mathcal{X} is a Mal'tsev category; see (4.11.1).

Proof We start with the proof that (I) implies (II). Let (R, d_1, d_2, e) be a reflexive relation on an object X and consider the pullback

$$\begin{array}{ccc}
 R \times_X R & \xleftarrow{e_2} & R \\
 \uparrow \pi_1 & \xrightarrow{\pi_2} & \uparrow d_1 \\
 R & \xleftarrow{e} & X
 \end{array}$$

By assumption, e_1 and e_2 are jointly extremal-epimorphic. Hence in the square

$$\begin{array}{ccc}
 R + R & \xrightarrow{\nabla_R} & R \\
 \downarrow \langle e_1, e_2 \rangle & \searrow \rho & \downarrow (d_1, d_2) \\
 R \times_X R & \xrightarrow{(d_1 \pi_1, d_2 \pi_2)} & X \times X
 \end{array}$$

there is a lifting ρ showing that R is a transitive relation.

For the other implications, given any relation (R, d_1, d_2) from X to Y , we shall write S for the reflexive relation on R defined by $(a, b)S(c, d)$ if and only if aRd . In other words, S is the pullback of $(d_1, d_2): R \rightarrow X \times Y$ along the map $d_1 \times d_2: R \times R \rightarrow X \times Y$ as in the diagram

$$\begin{array}{ccc}
 S & \xrightarrow{\quad} & R \\
 \downarrow (d'_1, d'_2) & \circlearrowleft & \downarrow (d_1, d_2) \\
 R \times R & \xrightarrow{d_1 \times d_2} & X \times Y
 \end{array}$$

For the proof that (II) implies (III), let R be a reflexive relation on an object X and S the induced reflexive relation. Assume that aRb . Then $(b, b)S(a, b)$ and $(a, b)S(a, a)$. Since S is transitive, we have $(b, b)S(a, a)$, so that bRa . It follows that R is symmetric.

To see that (III) implies (II), let R be a reflexive relation on an object X and S the induced reflexive relation. Assume that aRb and bRc . Then cRb by symmetry of R . Hence $(a, a)S(c, b)$, so that $(c, b)S(a, a)$ by symmetry of S . It follows that cRa , so that aRc and R is a transitive relation.

We see that either (II) or (III) implies (IV). To show that (IV) implies (I), consider a double sectioned epimorphism as in the statement of condition (I). Consider a monomorphism $m: M \rightarrow U$ through which s and n factor as $s': X \rightarrow M$ and $n': V \rightarrow M$ such that $ms' = s$ and $mn' = n$. We have to prove that m is an isomorphism. This amounts to showing that aMb for all $(a, b): A \rightarrow X \times V$. Note that M is indeed a relation from X to V . It induces a reflexive relation S on M as above. This S is an equivalence relation on M by assumption. Now $(a, tfa)S(mvb, tfa)$ and $(mvb, tfa)S(mvb, b)$ so that $(a, tfa)S(mvb, b)$ which implies aRb . \square

We know from Exercise A.2.12 that a diagram as in (4.11.4) is always pushout of sectioned epis and a pullback of sectioned monos. In the following corollary we characterize when it is a pullback of sectioned epimorphisms.

4.11.5 Corollary

When is a split epi of split epis a pullback?

In a Mal'tsev category a diagram as in (4.11.4) is a pullback of sectioned epimorphisms if and only if u and g are jointly monomorphic.

Proof If the diagram is a pullback, then u and g are seen as jointly monomorphic. Conversely, they are jointly monomorphic, then the comparison to the pullback of v along f . This comparison is an extremal epimorphism and a monomorphism, hence an isomorphism. \square

4.11.6 Corollary

Homological implies Mal'tsev - H

Any homological category is a Mal'tsev category.

Proof This combines Proposition 4.11.4 with Corollary 4.2.7. \square

Comment on the origins of the concept of a Mal'tsev category

Mal'tsev discovered [64] that a variety satisfies what we now call the Mal'tsev identities (4.11.2) exactly when all of its reflexive relations are equivalence relations. Since this latter condition can be formulated in purely categorical terms, it has been studied in settings which are far wider than varieties of algebras: see, for instance, [25, 24, 10, 31] and the references there.

Chapter 5

Semiabelian Categories

We introduce the environment of semiabelian category to combine features of di-exact categories and homological categories: A semiabelian category is a homological category which is also di-exact. Thus, in a semiabelian category all of the diagram lemmas established in Chapter 4 are valid. In addition, useful computational tools become available, such as Theorem 2.4.4, plus results that will be developed here.

From a logician's perspective, it is of interest that, through the validity of the di-exactness axiom, semi-abelian categories allow self-dual proofs of results which are still valid in a homological context, but do not permit a self-dual proof there. An example of this phenomenon is the Snake Lemma.

Historical perspective Let us review the key steps leading to the conception of semiabelian categories: In the 1960's, Gerstenhaber, Huq, Orzech [49, 37, 70] looked for a generalization of Grothendieck's abelian categories which would also include the categories of groups, Lie-algebras, loops, non-unitary rings, etc. They presented several systems of structural axioms. However, at the time, these competing systems of structural axioms appeared dissimilar, and no favorite emerged over the next couple of decades.

Some thirty to forty years later, Janelidze, Márki, and Tholen discovered that these dissimilar seeming structural axiom systems were all equivalent. Their discovery was based on more recent developments in categorical algebra and, in particular, on the pivotal concepts of 'Barr exactness' [3], and 'Bourn protomodularity' [14, 17]. From these unifying insights emerged the much younger concepts of *semiabelian category*, introduced in [51], and *homological category*, introduced in [10].

We now have a fairly fine grained homological view of categorical algebra. A relationship of many of the well investigated algebraic categories to this view is presented in the

introduction to the current part of the text, starting from page 8.

Leitfaden for Chapter 5

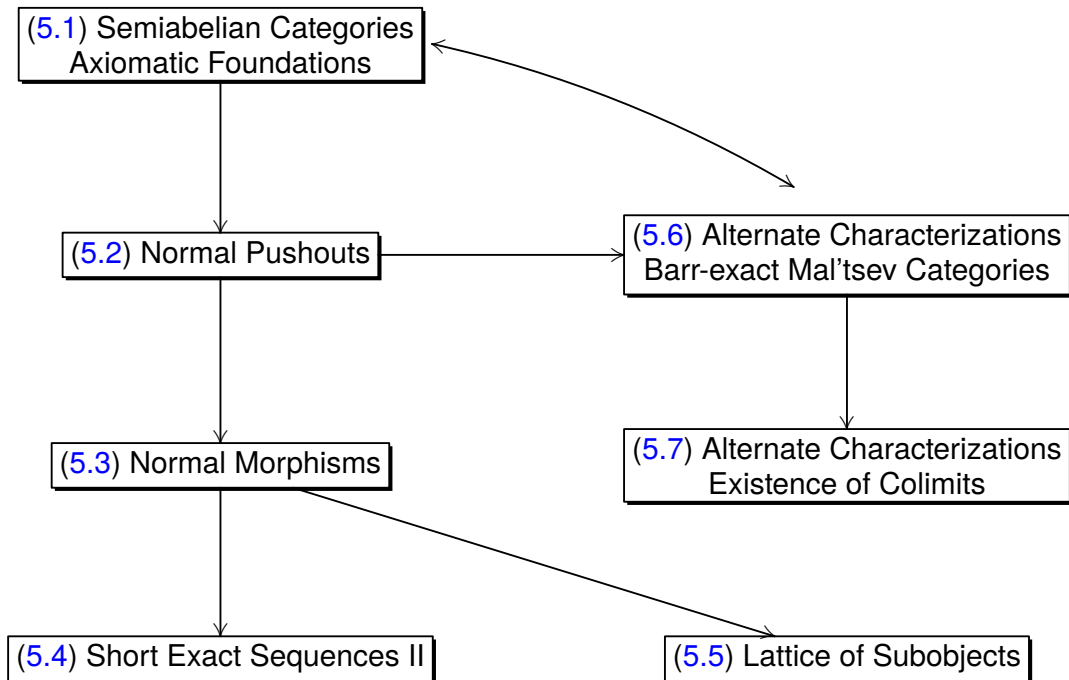

5.1 Semiabelian Categories

With the concept of a semiabelian category, we combine features of di-exact categories and homological categories. For convenience, here is a complete set of structural axioms which characterize a semiabelian category.

5.1.1 Definition

Semiabelian category

A category \mathcal{X} is semiabelian if the following structural axioms are satisfied:

- ▶ *Zero object*: \mathcal{X} has a zero object; see (1.2.1).
- ▶ *Functorially finitely complete*: For every functor $F: J \rightarrow \mathcal{X}$, with J finite, $\lim(F)$ exists; see (A.1).
- ▶ *Functorially finitely cocomplete*: For every functor $F: J \rightarrow \mathcal{X}$, with J finite, $\operatorname{colim}(F)$ exists; see (A.1).
- ▶ *(PNE) Pullbacks preserve normal epimorphisms*: The pullback \bar{g} of a normal epimorphism g along any morphism f in \mathcal{X} is a normal epimorphism.

$$\begin{array}{ccc}
 P & \longrightarrow & Z \\
 \bar{g} \downarrow & \circlearrowleft & \downarrow g \\
 X & \xrightarrow{f} & Y
 \end{array}$$

- ▶ *(KSG) Kernel and section generate*: For a morphism $q: X \rightarrow Q$ with any given section $x: Q \rightarrow X$ (so that $qx = 1_Q$),

$$K \xrightarrow{k} X \begin{array}{c} \xrightarrow{q} \\ \xleftarrow{x} \end{array} Q$$

the morphisms x and $k = \ker(q)$ are jointly extremal-epimorphic; see (A.3.1).

- ▶ *(ANN) Every antinormal map is normal*.

Thus, among the types of categories we have introduced, the most prominent ones are:

- ▶ Every finitely bicomplete category with a zero object is *z-exact*.
- ▶ *Di-exact categories* are z-exact, and satisfy the condition (ANN).
- ▶ *Normal categories* are finitely bicomplete, have a zero object, and satisfy the conditions (PNE) and (AEN)—absolute epimorphisms are normal.

- *Homological categories* are finitely bicomplete, have a zero object, and satisfy the (PNE) and (KSG)-conditions.
- *Semiabelian categories* are homological and satisfy the (ANN)-condition. Thus a semiabelian category is at the same time homological and di-exact.

We already discussed the nature of these structural axioms individually. We point out that any variety of algebras is bicomplete. So, it is automatically z-exact when it has a zero object. Further, if a pointed variety is homological, then it is automatically semiabelian. This is remarkable, because outside a homological context, a z-exact variety need *not* be di-exact.

Notes

In Definition 5.1.1, we characterized a semiabelian category by the requirements that it has a zero object, is finitely bicomplete, pullbacks preserve normal epimorphisms (PNE), it satisfies the (KSG)-condition, and antinormal maps are normal (ANN). Sections 5.6 and 5.7 lead up to Theorem 5.7.3 which tells us that this collection of structural axioms is equivalent to the ones proposed by Janelidze–Márki–Tholen in [51].

An early version of the concept of a semiabelian category goes back to Huq [49] in the late 1960's. Around the same time other competing axiom systems were proposed. All of these developments remained largely dormant until Janelidze–Márki–Tholen in [51] managed to connect the pivotal concept of Barr exactness with the work of Huq and others. We draw the reader's attention to the introduction of [51] for a more detailed historical perspective.

Next to being valid in any variety of algebras, Barr exactness had long been understood to form part of the structure of an abelian category, and also that of an elementary topos. Rooted in the study of categories of sectioned epimorphisms, called 'points' by Bourn, he studied what is now called *Bourn protomodularity*, that is (KSG) and its equivalent versions—see (4.9) and (4.10). From the beginning, he recognized the relevance of protomodularity toward the goals of Huq and others and provided further insight into this topic in [15, 17].

Full recognition of Bourn's accomplishment only arrived with the works of Bourn–Janelidze [21] and, in particular, [51] where it is explained how protomodularity acts as the link between the development surrounding Barr exactness and the works of Huq and others. — In the words of Janelidze–Márki–Tholen, their main result is that 'old = new'.

As a consequence of this discovery, the need to compare seemingly competing notions of semiabelian categories vanished: via 'old = new', there is a single notion left, which, as we shall see, is equivalent to the one defined above.

Exercises

5.1.2 Exercise

Cokernel and retraction co-generate in \mathbf{Set}_*

In the category \mathbf{Set}_* of pointed sets, show that any monomorphism is a normal map which is also retractable. Then consider a short exact sequence

$$K \triangleright \xrightarrow{k} X \xrightarrow{q} \triangleright Q$$

in Set_* and show that $X \cong K + Q$.

5.1.3 Exercise

Set_* is co-semiabelian

We know already that the category Set_* of pointed sets is bicomplete. Show that it is also co-semiabelian and, hence, that Set_*^{op} is semiabelian:

- (i) (PNM) Pushouts preserve normal monomorphisms.
- (ii) (CRC) Cokernel and retraction co-generate Given a retracted monomorphism $(m \uparrow r)$, let $q := \text{coker}(m)$. Then r and q are jointly extremally monomorphic.
- (iii) (ANN) Every antinormal map is normal.

5.1.4 Exercise

Set_* is not p-exact

In Set_* show that there are morphisms which are not normal; i.e., show that Set_* is not a p-exact category.

5.2 Normal Pushouts in a Semiabelian Category

In a homologically self-dual category, we know from Section 2.9 that every (semi-)normal pushout square actually enjoys the universal property expected of a pushout. A special feature of a semiabelian category is that every pushout of normal epimorphisms is a normal pushout.

5.2.1 Proposition Pushout of normal epimorphisms in a semiabelian category - SA

In a semiabelian category, every pushout of a normal epimorphism along another is a normal pushout.

Proof Via the (ANN)-condition, we know from (2.8.2) that every pushout of normal epimorphism q along another ξ is di-extensive; that is we obtain the morphism of short exact sequences below.

$$\begin{array}{ccccc}
 K(q) \triangleright & \longrightarrow & X & \xrightarrow{q} & Q \\
 \kappa \downarrow & & \xi \downarrow & \lrcorner \circ & \downarrow \underline{\xi} \\
 K(\underline{q}) \triangleright & \longrightarrow & Y & \xrightarrow{\underline{q}} & R
 \end{array}$$

In particular, the map κ is a normal epimorphism. The square on the right is a normal pushout square by (4.4.13). \square

Via normal pushouts we obtain the following view of the separation between homological and semiabelian categories:

5.2.2 Proposition

(ANN)-condition in terms of normal pushouts - H

For a homological category \mathcal{X} , the following conditions are equivalent.

- (I) \mathcal{X} is semiabelian.
- (II) \mathcal{X} is di-exact.
- (III) The category \mathcal{X} has the (ANN)-property: any antinormal composite is a normal map.
- (IV) In \mathcal{X} , the pushout of two normal epimorphisms with a common domain is a normal pushout.

Proof (I), (II) and (III) are equivalent by definition. (III) \Rightarrow (IV) was proved in (5.2.1). For the proof that (IV) implies (III), given an antinormal map composed of a normal monomorphism k and a normal epimorphism r , construct the morphism of short exact sequences below from the pushout of $\text{coker}(k)$ along f .

$$\begin{array}{ccccc}
 K & \xrightarrow{k} & X & \xrightarrow{\text{coker}(k)} & Q \\
 \downarrow \kappa & & \downarrow f & \lrcorner & \downarrow \\
 L & \xrightarrow{l} & Y & \longrightarrow & R
 \end{array}$$

By hypothesis, the square on the right is a normal pushout. So, κ is a normal epimorphism. This means that $l\varphi$ is an image factorization of fk . Thus the (ANN)-condition is satisfied. \square

Notes Relation with Barr-exactness

The equivalence in (5.2.2) will allow us in (5.6) to prove the following:

- a semiabelian category is always a Barr-exact Mal'tsev category,
- In a finitely bicomplete pointed category satisfying the (PNE)-condition, the (ANN)-condition is equivalent to Barr-exactness.

This amounts to saying that *a homological category is di-exact if and only if it is Barr exact*.

(5.2.2) is closely related to the question whether a join of two normal subobjects is normal and, in turn, to the (3×3) -lemma (4.6.1), one of the key results of Section 4.6. In particular, we prove in (5.5.8) that in a homological category joins of pairs of normal subobjects are normal if and only if the (ANN)-condition is satisfied.

Exercises

5.2.3 Exercise

Normal pushout vs. square of normal epimorphisms - SA

In a semiabelian category give an example of a commutative square of normal epimorphisms which is not a pushout square.

5.3 Normal Morphisms in a Semiabelian Category

Let us recall (1.8.9) that a morphism $f: X \rightarrow Y$ in a z-exact category \mathcal{X} is normal if it admits a factorization $f = me$ in which e is a normal epimorphism and m is a normal monomorphism. Here we establish properties of normal morphisms which hold in semiabelian categories but may not hold in a z-exact category, and we derive consequences thereof.

The next result is a companion to (4.3.6); the difference being that we do not require α or ξ to be kernels here. However, we are requiring them to appear in exact sequences. So, each of them is a normal map.

5.3.1 Proposition

Induced map of cokernel of square - SA

If in the morphism of exact sequences below the map b is normal, then so is $Q(\alpha, \beta)$.

$$\begin{array}{ccccccccc}
 0 & \longrightarrow & K(\alpha) & \longrightarrow & A & \xrightarrow{\alpha} & B & \longrightarrow & Q(\alpha) & \longrightarrow & 0 \\
 & & \downarrow K(\alpha, \beta) & & \downarrow a & & \downarrow b & & \downarrow Q(\alpha, \beta) & & \\
 0 & \longrightarrow & K(\beta) & \longrightarrow & X & \xrightarrow{\beta} & Y & \longrightarrow & Q(\beta) & \longrightarrow & 0
 \end{array}$$

Proof Inserting (normal) image factorizations into the square on the right, we find the following situation:

$$\begin{array}{ccc}
 B & \xrightarrow{\pi} & Q(\alpha) \\
 e \downarrow & & \downarrow \varepsilon \\
 \square & \xrightarrow{\lambda} & \square \\
 m \downarrow & & \downarrow \mu \\
 Y & \xrightarrow{\rho} & Q(\beta)
 \end{array}$$

The composite $\varepsilon\pi$ is a normal epimorphism, and so λ is a normal epimorphism. Consequently, the $\mu\lambda$ is the image factorization of the antinormal composite ρm . Via the (ANN)-condition we see that μ is a normal monomorphism. So $Q(\alpha, \beta)$ is a normal map. □

5.3.2 Example

Conclusion of (5.3.1) not for kernels

In the setting of (5.3.1) the reader may wonder whether $K(\alpha, \beta)$ is normal whenever a is. In general, the answer is 'no', since this would imply that a composite of two normal monomorphisms is again normal. Here is an explicit example in Grp: Let $C_2 = \{-1, +1\}$ be the cyclic group of order 2, and let $\mathbb{Z}[C_2]$ be its integral group ring. When regarded as a module over itself, there is an underlying action of C_2 on $\mathbb{Z}[C_2]$. With the associated semidirect product we may form the square of proper maps on the right, along with the indicated kernels.

$$\begin{array}{ccccc}
 \mathbb{Z} \cdot (+1) & \xrightarrow{\quad} & \mathbb{Z}[C_2] & \xrightarrow{\quad} & \mathbb{Z} \\
 K(\alpha, \beta) \downarrow & & \downarrow & & \downarrow \\
 \mathbb{Z}[C_2] \rtimes C_2 & \xlongequal{\quad} & \mathbb{Z}[C_2] \rtimes C_2 & \xrightarrow{\quad} & 0
 \end{array}$$

Evidently, the map $K(\alpha, \beta)$ is not normal.

5.3.3 Proposition

Pushouts along normal epis preserve normal maps - SA

In a semiabelian category, a pushout along a normal epimorphism preserves normal maps.

Proof In the commutative diagram below, we see the pushout of a normal map $f = me$ along a normal epimorphism φ broken down as a concatenation of two steps.

The long rectangle and the left hand square are constructed as pushouts. So, the underlined maps are normal epimorphisms. The antinormal composite $\underline{\varphi}m$ is a normal map by the (ANN)-condition. Its normal factorization $\mu\rho$ may be constructed as

$$\mu = \ker(\text{coker}(\underline{\varphi}m)) = \text{coker}(\underline{\varphi}f) = \text{coker}(\underline{f}\varphi) = \text{coker}(\underline{f})$$

Here, we used repeatedly that a map α , and α precomposed by a normal epimorphism have the same cokernels; see (1.5.9). The map \underline{f} factors through μ via ε . To see that ε is a normal epimorphism, we argue as follows. The universal property of the pushout on the left yields the map t which renders the entire diagram commutative. We conclude that t is a normal epimorphism via (1.5.9). So, t is a composite of two normal epimorphisms,

hence is itself a normal epimorphism by (3.2.7). - Thus f pushes forward to the normal map $\mu\varepsilon$. \square

Notes

On the (ANN)-condition In a homological category, the conclusion of (5.3.1) is equivalent to the (ANN)-condition. Indeed, consider an antinormal map qk as in this diagram.

$$\begin{array}{ccc} K & \xrightarrow{k} & X \\ e \downarrow & & \downarrow q \\ I & \xrightarrow{m} & Q \end{array}$$

The composite me is the image factorization of qk as in (3.2.3). Supplementing the kernels of e and q , we obtain a pullback diagram, since m is monic. Via the conclusion of (5.3.1), we see that m is normal as well, as was to be shown.

Normal diagonal maps and semiabelian vs. abelian A defining property of an abelian category \mathcal{A} is that every monomorphism is a normal monomorphism. Therefore every morphism in \mathcal{A} is normal. Perhaps surprisingly, this exact same property also separates a semiabelian category from being abelian. An even more minimalistic criterion is: A semiabelian category \mathcal{X} is abelian if and only if every diagonal map $\Delta_X: X \rightarrow X \times X$ is a normal monomorphism.

Exercises

5.3.4 Exercise

Product of normal monomorphisms - SA

Given monomorphisms $f: A \rightarrow X$ and $g: A \rightarrow Y$ in a semiabelian category, show the following:

- (i) If $(f, g): A \rightarrow X \times Y$ is normal, then f and g are normal.
- (ii) If f and g are normal, find an example in which (f, g) is not normal.
- (iii) In the category Grp of groups, show that f and g are normal if and only if f is central in X and g is central in Y .

5.4 The Category of Short Exact Sequences - II

In a di-exact category \mathcal{X} and, hence, in a semiabelian category a short exact sequence in $\text{SES}(\mathcal{X})$ is a di-extension in \mathcal{X} ; see Proposition 2.8.5. Here, we show that $\text{SES}(\mathcal{X})$ is homological whenever \mathcal{X} is semiabelian.

5.4.1 Theorem \mathcal{X} semiabelian implies $\text{SES}(\mathcal{X})$ is homological - SA

If \mathcal{X} is a semiabelian category, then the category $\text{SES}(\mathcal{X})$ of short exact sequences in \mathcal{X} is homological.

Proof We already know from Theorem 1.10.1 that $\text{SES}(\mathcal{X})$ is a category with zero-object which is finitely bicomplete.

To verify that the (PNE)-condition holds in $\text{SES}(\mathcal{X})$, we show that it holds in the equivalent category $\text{NM}(\mathcal{X})$. Consider the commutative cube below.

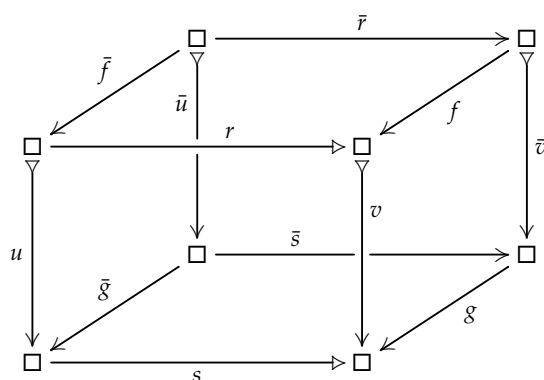

The front face is a normal epimorphism in $\text{NM}(\mathcal{X})$, given by a pair (r, s) of normal epimorphism (r, s) in \mathcal{X} ; see (2.8.6). Pulling (r, s) back along the morphism (f, g) in $\text{NM}(\mathcal{X})$ is accomplished via the bottom and top pullback squares of the cube by (1.10.2). The normal epimorphisms r and s pull back to normal epimorphisms \bar{r} and \bar{s} by (4.1.1). Thus, the normal epimorphism (r, s) in $\text{NM}(\mathcal{X})$ pulls back to the normal epimorphism (\bar{r}, \bar{s}) , again (2.8.6).

The (KSG)-condition is satisfied because in $\text{NM}(\mathcal{X})$, sectioned epimorphisms, kernels and monomorphisms are all given by their pointwise counterparts. \square

5.4.2 Proposition Adjunctions with the category of morphisms - SA

Associated to semiabelian category \mathcal{X} are these adjunctions

$$\text{Arr}(\text{SES}(\mathcal{X})) \begin{array}{c} \xrightarrow{\quad} \\ \xleftarrow{\perp} \end{array} \text{SES}(\text{SES}(\mathcal{X})) \qquad \text{Arr}(\text{SES}(\mathcal{X})) \begin{array}{c} \xrightarrow{\quad} \\ \xleftarrow{\top} \end{array} \text{SES}(\text{SES}(\mathcal{X}))$$

The right adjoint of the adjunction on the left sends a short exact sequence of short exact sequences, i.e., a di-extension, to its normal monomorphic part. Its left adjoint constructs from a morphism (μ, ξ, η) of short exact sequences the di-extension shown on the right below.

$$\begin{array}{ccc}
 K \triangleright \xrightarrow{k} X \twoheadrightarrow Q \\
 \downarrow \kappa \quad \downarrow \xi \quad \downarrow \rho \\
 L \triangleright \xrightarrow{l} Y \twoheadrightarrow R
 \end{array}
 \qquad
 \begin{array}{ccccc}
 K(\kappa) \triangleright \xrightarrow{\hat{k}} K(\xi) \twoheadrightarrow Q(\hat{k}) \\
 \downarrow \alpha \quad \downarrow \beta \quad \downarrow \gamma \\
 K \triangleright \xrightarrow{k} X \twoheadrightarrow Q \\
 \downarrow \quad \downarrow \quad \downarrow \\
 Q(\alpha) \triangleright \xrightarrow{\quad} Q(\beta) \twoheadrightarrow Q(\gamma)
 \end{array}$$

The left adjoint of the adjunction on the right ‘forgets to normal epimorphisms of short exact sequences’. The right adjoint constructs from (κ, ξ, ρ) a di-extension by taking the cokernel of its kernel. \diamond

Notes

SES(\mathcal{X}) if \mathcal{X} is abelian For the category Ab of abelian groups, its associated category SES(Ab) is preabelian but fails to be abelian. It is homological, but fails to be semiabelian.

5.5 The Lattice of Subobjects

In any category \mathcal{X} the subobjects of a given object X form a class $Sub(X)$ which is partially ordered by inclusion ‘ \leq ’. Here, we analyze $(Sub(X), \leq)$ further in the two settings where \mathcal{X} is homological, respectively semiabelian.

The partial order $Sub(X)$ has X itself as its greatest element, and has the zero objects as its least element. We investigate the additional structures given by ‘meet’ and ‘join’.

In a homological category \mathcal{X} , the meet of two subobjects K and L of X exists, and may be constructed as the pullback of $K \rightarrow X \leftarrow L$; see (A.1.17). If \mathcal{X} has underlying sets, then this yields the set-intersection of K and L .

In (1.1.8), we characterized the join $K \vee L$ of K and L as the least subobject of X containing K and L , provided such a least subobject exists. Under appropriate conditions, it may be constructed as the ‘intersection’ of all subjects of X containing K and L ; see (1.1.9). In a homological category, the situation is simpler: $K \vee L$ may be constructed as the image of the canonical map $K + L \rightarrow X$; see (5.5.1). Thus, meet and join determine a bounded lattice structure on $Sub(X)$.

Whenever the class $Sub(X)$ is small for every X in \mathcal{X} , we obtain a category $SOb(\mathcal{X})$ with

- ▶ *objects* the bounded lattices $Sub(X)$, with X in \mathcal{X} , and
- ▶ *morphisms* the order preserving functions $Sub(X) \rightarrow Sub(Y)$.

The operation which sends an object X to its lattice of subobjects is a contravariant functor $Sub^* : \mathcal{X} \rightarrow SOb(\mathcal{X})$. This is so because pullbacks preserve monomorphisms.

Similarly, we have the lattice $NSub(X)$ of normal subobjects of X . The meet of two normal subobjects is again normal, by (1.7.1). Their join, however, need not be normal in general. In a homological category \mathcal{X} we show that joins of normal subobjects are always normal if and only if \mathcal{X} is semiabelian; see (5.5.7).

As applications of these general properties of the join and meet operations, we show:

- ▶ (5.5.4) Given a split extension, the join of the end objects is equals the middle object. - H
- ▶ (5.5.5) A normal subobject $K \leq X$ and a subobject $Y \leq X$ determine a split short exact sequence if and only if $K \wedge Y = 0$ and $K \vee Y = X$. - H
- ▶ (5.5.6) The Second Isomorphism Theorem. - H

Turning to details:

5.5.1 Proposition Construction of join of subobjects via image factorization - H

In a homological category, the join of subobjects $m : M \rightarrow X$ and $n : N \rightarrow X$ exists and is represented by the monomorphism $i : I \rightarrow X$ in the image factorization

$$\begin{array}{ccccc}
 & & \langle m, n \rangle & & \\
 & & \curvearrowright & & \\
 M + N & \xrightarrow{q = \langle m', n' \rangle} & I & \xrightarrow{i} & X
 \end{array}$$

of $\langle m, n \rangle : M + N \rightarrow X$.

Proof From (3.2.5) we know that the normal epimorphism $q = \langle m', n' \rangle$ is an extremal epimorphism. This means that m' and n' are jointly extremally epimorphic. By (A.3.16), $i : I \rightarrow X$ represents the join of m and n . \square

In following corollary is a well known property of many familiar varieties of algebras.

5.5.2 Corollary Join of normal subobjects - SA

In a semiabelian category, the join of two normal subobjects of a given object exists and is again normal.

Proof The pullback square of two normal subobjects K and L of X forms the initial square of a di-extension by (2.8.2). Then Proposition 4.6.2 explains why $K \vee L$ is normal in X . \square

5.5.3 Corollary **Universal map from sum with normal constituents - SA**
 If $f: X \rightarrow Z$ and $g: Y \rightarrow Z$ are normal, then so is $\langle f, g \rangle: X + Y \rightarrow Z$.

Proof By (3.2.11) the image of $\langle f, g \rangle$ is the join of the images of f and g . Now the claim follows from (5.5.2). \square

5.5.4 Proposition **Split short exact sequence and join - H**
 In a split short exact sequence, as below, $X = K \vee Y$.

$$K \rightrightarrows X \begin{matrix} \xleftarrow{s} \\ \xrightarrow{f} \end{matrix} Y$$

Proof The structure maps from K and Y into their sum yield this commutative diagram:

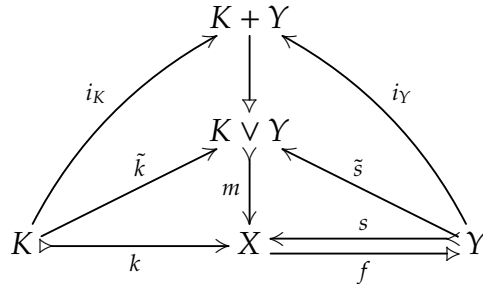

By Axiom 4.1.1, k and s are jointly extremally epimorphic. So, m is an isomorphism; i.e., $K \vee Y = X$. \square

5.5.5 Corollary **Split extension as a pair of subobjects - H**
 For any object X in a homological category the following conditions are equivalent:

(I) X is the middle object in a split short exact sequence:

$$K \rightrightarrows X \begin{matrix} \xleftarrow{s} \\ \xrightarrow{f} \end{matrix} Y$$

(II) $K \triangleleft X$ and $Y \leq X$ such that $K \wedge Y = 0$ and $K \vee Y = X$.

Proof (i) \Rightarrow (ii) With (5.5.4), we see that $K \vee Y = X$. Further, $k = K(f)$ is a normal subobject of X , while s represents Y as a subobject of X . To see that $K \wedge Y = 0$, consider this pullback diagram:

$$\begin{array}{ccc} K \wedge Y & \xrightarrow{\bar{k}} & Y \\ \bar{s} \downarrow & \circlearrowleft & \downarrow s \\ K & \xrightarrow{k} & X \end{array}$$

The map \bar{k} is a monomorphism by (1.5.8). Also, we have $s\bar{k} = k\bar{s}$ and, hence,

$$\bar{k} = fs\bar{k} = fk\bar{s} = 0$$

Thus $K \wedge Y$ is the zero subobject of X .

(ii) \Rightarrow (i) From $K \triangleleft X$ and $Y \leq X$, we construct this commutative diagram:

$$\begin{array}{ccccc} 0 & \longrightarrow & Y & \xlongequal{\quad} & Y \\ \downarrow & & \circlearrowleft & & \downarrow f\sigma \\ K & \xrightarrow{k} & X & \xrightarrow{f} & Q(k) \end{array}$$

The pullback construction (A.1.17) of $K \wedge Y$ yields the square on the left. So, $f\sigma$ is a monomorphism by Lemma 4.3.6. By Corollary 4.4.10 it is a normal epimorphism as well. By (1.5.7) it is an isomorphism. So, $s := \sigma \circ (f\sigma)^{-1}$ is a section of f . \square

5.5.6 Theorem

Second Isomorphism Theorem - H

For subobjects $K, L \leq X$ with $L \triangleleft (L \vee K)$, we have that

$$\frac{K}{L \wedge K} \cong \frac{L \vee K}{L}.$$

Proof From the subobjects K and L of $L \vee K$, we construct the commutative square on the left as a pullback. The map $\bar{\lambda}$ is a normal monomorphism by (1.5.8). So, taking cokernels, yields this morphism of short exact sequences:

$$\begin{array}{ccccc} L \wedge K & \xrightarrow{\bar{\lambda}} & K & \longrightarrow & K/(L \wedge K) \\ \bar{u} \downarrow & & \circlearrowleft & & \downarrow v \\ L & \xrightarrow{\lambda} & L \vee K & \longrightarrow & (L \vee K)/L, \end{array}$$

The map v is a monomorphism by Lemma 4.3.6. By the join recognition criterion (A.3.16), the inclusions of K and L are jointly extremal-epimorphic. With (4.4.10) we see that v is a normal epimorphism. By (1.5.7), v is an isomorphism. \square

5.5.7 Proposition

Normality of join in a homological category - H

Given an object X in a homological category, the following conditions are equivalent for normal subobjects K and L of X :

- (I) K and L determine a di-extension with central object X .
- (II) $K \vee L$ is normal in X .
- (III) The pushout of $X \rightarrow X/K$ and $X \rightarrow X/L$ is a normal pushout.

Proof (I) \Rightarrow (II) follows via Proposition 4.6.2.

(I) \Rightarrow (III) follows via the (semi)normal pushout recognition criterion (4.4.2).

(III) \Rightarrow (I) follows from via (2.8.2).

(II) \Rightarrow (I) If $K \vee L$ is normal in X , then we obtain this morphism of short exact sequences:

$$\begin{array}{ccccc}
 L & \twoheadrightarrow & X & \longrightarrow & X/L \\
 \downarrow & & \parallel & & \downarrow \\
 K \vee L & \twoheadrightarrow & X & \longrightarrow & X/(K \vee L)
 \end{array}$$

Combining the Pure Snake Lemma with (5.5.6), we obtain this exact sequence:

$$\begin{array}{ccccccc}
 L & \twoheadrightarrow & K \vee L & \longrightarrow & X/L & \longrightarrow & X/(K \vee L) \\
 & & \downarrow & & \uparrow & & \\
 & & K \vee L/L & \xlongequal{\quad} & K/(K \wedge L) & &
 \end{array}$$

Similarly, we obtain the short exact sequence $L/K \wedge L \twoheadrightarrow X/K \longrightarrow X/K \wedge L$. This yields the di-extension.

$$\begin{array}{ccccc}
 K \wedge L & \twoheadrightarrow & K & \longrightarrow & K/L \wedge K \\
 \downarrow & & \downarrow & & \downarrow \\
 L & \twoheadrightarrow & X & \longrightarrow & X/L \\
 \downarrow & & \downarrow & & \downarrow \\
 L/L \wedge K & \twoheadrightarrow & X/K & \longrightarrow & X/K \vee L
 \end{array}$$

The proof of (5.5.7) is complete. □

5.5.8 Corollary

Join of normal subobjects is normal iff di-exact - H

In a homological category \mathcal{X} , the join of a pair of normal subobjects of an object X is normal if and only if \mathcal{X} is di-exact. ◇

5.5.9 Corollary

Universal map from sum normal iff di-exact - H

In a homological category \mathcal{X} , the sum of two normal maps is a normal map if and only if \mathcal{X} is di-exact. \diamond

Proof We know (5.5.3) that, in a semiabelian category the sum of two normal maps is normal. Conversely, (5.5.8) shows that, if the sum of normal maps is normal, then \mathcal{X} is semiabelian. \square

Consequently, a homological category is semiabelian if and only if every universal map out of a binary sum with normal constituents is again a normal map.

Next, we infer the well-known fact that the lattice of $NSub(X)$ of normal subobjects of an object X in a semiabelian category is a *modular* lattice. This means that for all $K, L, M \triangleleft X$ where $M \leq L$, the equality $M \vee (K \wedge L) = (M \vee K) \wedge L$ holds. Here we freely use (5.5.2).

5.5.10 Proposition

Modularity of lattice of normal subobjects - SA

For normal subobjects $K, L, M \triangleleft X$ with $M \leq L$,

$$M \vee (K \wedge L) = (M \vee K) \wedge L$$

as normal subobjects of X .

Proof Consider this commutative diagram whose rows are short exact:

$$\begin{array}{ccccc}
 K \wedge L & \longrightarrow & K & \longrightarrow & K/(K \wedge L) \\
 \downarrow & & \downarrow & & \downarrow v \\
 M \vee (K \wedge L) & \longrightarrow & M \vee K & \longrightarrow & (M \vee K)/(M \vee (K \wedge L)) \\
 \downarrow & & \downarrow & & \downarrow w \\
 L & \longrightarrow & K \vee L & \longrightarrow & (K \vee L)/L
 \end{array}$$

Note that by (5.5.2), all subobjects in this diagram are normal. The desired identity follows, once we show that the rectangle on the bottom left is a pullback. Indeed, the rectangle $(K \wedge L) \rightrightarrows (M \vee K)$ is a pullback. As in the proof of Corollary 5.5.6 the composite $w \circ v$ is an isomorphism. Thus v is monic, and the top left square is a pullback by (1.6.2).

We claim that v is an isomorphism as well. Here, we used that the extremal epimorphism $M + K \rightarrow M \vee K$ factors through $(M \vee (M \wedge L)) + K$, which implies that the inclusions of $M \vee (M \wedge L)$ and K in $M \vee K$ are jointly extremally epimorphic as well.

Consequently, w is an isomorphism. By Proposition 1.6.2 the bottom left square is a pullback, as claimed. \square

The following example shows that working with normal subobjects is essential for the modularity result (5.5.10) to hold.

5.5.11 Example

Non-modularity of the lattice of all subobjects

The lattice of subgroups of a group need not be modular. For an example consider the lattice of subgroups of the dihedral group of order 8.

Exercises

5.5.12 Exercise

Properties of meet and join

Determine whether all subobject lattices in a semiabelian category are distributive; i.e. are the constructions $A \wedge (B \vee C)$ and $(A \wedge B) \vee (A \wedge C)$ on subobjects A, B, C of a given object X always isomorphic?

5.6 Alternate Characterizations: Barr-exact Mal'tsev Categories

The first important insight presented in this section is Theorem 5.6.2, which says that, in a semiabelian category, any reflexive relation (R, d_1, d_2, e) on an object X is an effective equivalence relation, so a kernel pair of a morphism $q: X \rightarrow Q$. For convenience, we can always let q be the coequalizer of d_1 and d_2 , and thus obtain a diagram

$$\begin{array}{ccc}
 R & \xrightarrow{d_1} & X \\
 d_2 \downarrow & \square & \downarrow q \\
 X & \xrightarrow{q} & Q
 \end{array}$$

which is both a pushout and a pullback. This implies that a semiabelian category is at the same time a Mal'tsev category (Definition 4.11.1) and a Barr-exact category (Definition 6.3.14). Actually, the former conclusion holds in homological categories; see (4.11.6). But the latter happens to be characteristic of the separation between homological and semiabelian categories. In other words, *a homological category is di-exact if and only if it is Barr-exact* (5.6.6): proving this is the main objective of this section.

5.6.1 Example

Barr-exactness of Grp We explain why the category Grp of groups is Barr exact: Suppose $R \subseteq X \times X$ is an internal reflexive relation on a group X . To prove that R is a symmetric relation, take $(x, y) \in R$. Then also (x^{-1}, x^{-1}) and (y^{-1}, y^{-1}) are in R , by reflexivity. Using that R is a subgroup of $X \times X$, we see that $(y^{-1}, x^{-1}) = (x^{-1}, x^{-1})(x, y)(y^{-1}, y^{-1}) \in R$. Then

also $(y, x) \in R$, for the same reason. Hence R is symmetric. Similar reasoning shows that R is transitive.

5.6.2 Theorem

Semiabelian categories are Barr-exact Mal'tsev - SA

In a semiabelian category \mathcal{X} , every reflexive relation is an effective equivalence relation. As a consequence, \mathcal{X} is a Barr-exact Mal'tsev category.

Proof Let (R, d_1, d_2, e) be a reflexive relation on an object X of \mathcal{X} . Since d_1 and d_2 are normal epimorphisms, their pushout is a normal pushout (5.2.2):

$$\begin{array}{ccc} R & \xrightarrow{d_1} & X \\ d_2 \downarrow & \lrcorner \circ & \downarrow q' \\ X & \xrightarrow{q} & Q \end{array}$$

Furthermore, $q = qd_2e = q'd_1e = q'$. So taking the pullback of q along q' , yields the kernel pair of q . The comparison arrow $R \rightarrow KP(q)$ is now both a normal epimorphism (normal pushout property of the square) and a monomorphism (R is a relation). So (1.5.7), it is an isomorphism. In particular, the reflexive relation R is a kernel pair. \square

Theorem 5.6.2 allows us to obtain a recognition criterion for reflexive coequalizers, valid in semi-abelian categories (but not in homological categories!). Let

$$\begin{array}{ccccc} R & \begin{array}{c} \xrightarrow{d_1} \\ \xleftarrow{e} \end{array} & B & \xrightarrow{f} & A \\ & \searrow^{d_2} & \nearrow_{\pi_1} & & \\ & & KP(f) & & \\ & \swarrow_{r=(d_1, d_2)} & \nearrow_{\pi_2} & & \end{array} \quad (5.6.2)$$

be a reflexive graph with its coequaliser f , the induced kernel pair $(KP(f), \pi_1, \pi_2)$ and the comparison morphism r . By (5.2.2), also r is normal epimorphism. But in fact, the converse also holds:

5.6.3 Proposition

Coequalizer recognition criterion - SA

In (5.6.2), suppose a normal epimorphism f satisfies $fc = fd$. Then f is the coequalizer of c and d if and only if r is a normal epimorphism.

Proof One implication is explained above; the other is a variation on the proof of Proposition 1.5.9, item (ii). \square

To continue, recall the direct image of a relation along a normal epimorphism (6.3.18).

5.6.4 Proposition

Normal pushout recognition via kernel pairs - H

In a homological category the following conditions are equivalent:

- (I) A direct image of an effective equivalence relation is again an effective equivalence relation.
- (II) Every pushout of a normal epimorphism along a normal epimorphism is a normal pushout.

Proof The proof follows the lines of the proof of (5.2.2): it suffices to replace kernels by kernel pairs, and use (4.4.11) instead of (4.4.13). \square

Recall, however, that in a homological category, equivalence relations are always preserved by direct images: Lemma 6.3.19.

5.6.5 Proposition

Barr-exactness implies the (ANN)-condition - H

In a homological category, if every equivalence relation is a kernel pair, then the (ANN)-condition holds.

Proof We know by Lemma (6.3.19) that the direct image of an equivalence relation along a normal epimorphism is still an equivalence relation. So if every equivalence relation is effective, then effective equivalence relations are preserved by direct images. Hence every pushout of a normal epimorphism along a normal epimorphism is a normal pushout by Proposition (5.6.4), so that Proposition (5.2.2) gives the (ANN)-condition. \square

5.6.6 Theorem

Semiabelian iff Barr exact for homological categories - H

A homological category is semiabelian if and only if it is Barr exact. \diamond

5.7 Alternate Characterizations: On the Existence of Colimits

The Mal'tsev property allows us to prove that in a finitely complete pointed category \mathcal{X} which satisfies the (PNE), (KSG), and (ANN)-conditions, the existence of binary coproducts and coequalizers of kernel pairs implies that \mathcal{X} is finitely cocomplete. It is this condition which separates Barr-exact Borceux-Bourn-homological categories from semiabelian ones.

Here, we clarify the role played by the existence of coproducts: we show that any Barr-exact Mal'tsev category with finite coproducts is finitely cocomplete. In (5.7.2) we show that, if binary sums exist in a BB-homological category \mathcal{X} where every equivalence relation is effective, then \mathcal{X} is finitely cocomplete. So, it is semiabelian.

5.7.1 Proposition **Colimits by coproducts and coequalizers of kernel pairs**
Any Barr-exact Mal'tsev category with finite coproducts is finitely cocomplete.

Proof We know, see for instance [63], that every finite colimits may be constructed as the coequalizer of a pair of parallel arrows between suitable finite sums. Here all finite coproducts exist by assumption. In this context, any coequalizer may be obtained as the coequalizer of a reflexive graph. Indeed, given a pair of parallel arrows $p_1, p_2: G \rightarrow X$, we may obtain the coequalizer of p_1, p_2 as the coequalizer of

$$G + X \begin{array}{c} \xrightarrow{\langle p_1, 1_X \rangle} \\ \xleftarrow{\iota_2} \\ \xrightarrow{\langle p_2, 1_X \rangle} \end{array} X$$

because for any morphism $f: X \rightarrow Y$, we have $f \circ p_1 = f \circ p_2$ if and only if $f \circ \langle p_1, 1_X \rangle = f \circ \langle p_2, 1_X \rangle$.

So, we must construct coequalizers of reflexive graphs from coequalizers of kernel pairs. If every kernel pair admits a coequalizer, then this is done as follows. Given a reflexive graph

$$G \begin{array}{c} \xrightarrow{p_1} \\ \xleftarrow{i} \\ \xrightarrow{p_2} \end{array} X$$

we wish to obtain the coequalizer of p_1, p_2 . First we factor $(p_1, p_2): G \rightarrow X \times X$ as a regular epimorphism $q: G \rightarrow R$, followed by a monomorphism $(d_1, d_2): R \rightarrow X \times X$. This is possible because a Barr-exact category is always regular, so that it admits regular image factorizations: see (A.4.12). We thus obtain a reflexive relation (R, d_1, d_2, e) , where $e = qi: X \rightarrow R$ is a common splitting for d_1 and d_2 . Now, a coequalizer of d_1, d_2 is also a

coequalizer of p_1, p_2 . So we reduced the problem to constructing coequalizers of reflexive relations. Since we are in a Barr-exact Mal'tsev category, these are all effective equivalence relations. This completes the proof. \square

5.7.2 Corollary

Existence of finite colimits

In a BB-homological category where every equivalence relation is effective, the existence of binary coproducts implies that \mathcal{X} is finitely cocomplete.

Proof In a pointed category with binary coproducts, all finite coproducts exist, since they may be obtained as repeated binary coproducts—with the exception of the nullary case, where the coproduct is given by the zero object. By (4.11.6), we find ourselves in a Barr-exact Mal'tsev category. Hence we may apply Proposition 5.7.1, which proves that the category is finitely cocomplete. \square

5.7.3 Theorem

Janelidze–Márki–Tholen definition of semiabelian categories

A category is semiabelian in the sense of (5.1.1) if and only if it is pointed, Barr-exact and Bourn-protomodular with finite coproducts.

Proof Proposition 4.10.11 already tells us that a category is pointed, finitely complete, with coequalizers of kernel pairs, and such that (PNE) and (KSG) hold, if and only if it is pointed, regular and protomodular.

Together with (5.6.2) this implies that a semiabelian category is always pointed, Barr-exact and Bourn-protomodular with finite coproducts.

For the converse, we use (5.7.2) on those axioms to find a homological category—which is then semiabelian by Proposition 5.6.5. \square

Chapter 6

Internal Structures

Leitfaden for Chapter 6

(6.1) Internal Magmas, Monoids, Groups



(6.2) Biproducts and Linear Categories

(6.3) Internal Graphs and Internal Relations

6.1 Internal Magmas, Monoids, Groups

Whenever we equip a set with the structural data for a group G , then every set X yields a group $\text{Hom}(X, G)$ under pointwise multiplication: the product of copies of G indexed by the elements of X . Thus $\text{Hom}(-, G)$ is a contravariant functor from the category of sets into the category of groups. Here we explain how this phenomenon applies, more generally, to categories with a which admit finite products and, hence, have a terminal object.

6.1.1 Definition

Internal magma, monoid, group

Let \mathcal{X} be a category with finite products and terminal object t . An *internal magma* structure on an object X in \mathcal{X} is given by a couple (X, μ) , with $\mu: X \times X \rightarrow X$ an arbitrary morphism. A unit in X is given by a morphism $e: \tau \rightarrow X$. An (*internal*) *unitary magma* (X, μ, e) is a magma (X, μ) with a unit e for which the diagrams (U) below commute.

$$\begin{array}{ccc}
 X & \xlongequal{\quad} & X & \xlongequal{\quad} & X \\
 \Delta_X \downarrow & & \uparrow \mu & & \downarrow \Delta_X \\
 X \times X & \xrightarrow{1_X \times \hat{e}} & X \times X & \xleftarrow{\hat{e} \times 1_X} & X \times X
 \end{array}
 \quad (U)
 \qquad
 \begin{array}{ccc}
 X \times X \times X & \xrightarrow{1_X \times \mu} & X \times X \\
 \mu \times 1_X \downarrow & & \downarrow \mu \\
 X \times X & \xrightarrow{\quad \mu \quad} & X
 \end{array}
 \quad (A)$$

Here \hat{e} is the composite $X \rightarrow \tau \xrightarrow{e} X$. An internal unitary magma is an *internal monoid* if diagram (A) above commutes. An internal *group* is a quadruple (X, μ, e, i) in which (X, μ, e) is an internal monoid, and the map $i: X \rightarrow X$ renders the diagram below commutative.

$$\begin{array}{ccccc}
 X & \xrightarrow{\Delta_X} & X \times X & \xrightarrow{1_X \times i} & X \times X \\
 \Delta_X \downarrow & & & \searrow \hat{e} & \downarrow \mu \\
 X \times X & \xrightarrow{i \times 1_X} & X \times X & \xrightarrow{\quad \mu \quad} & X
 \end{array}$$

Any of these internal structures is *commutative* if the diagram below commutes.

$$\begin{array}{ccc}
 X \times X & \xrightarrow{\quad \mu \quad} & X \\
 & \searrow \tau & \nearrow \mu \\
 & X \times X &
 \end{array}$$

Here $\tau := (pr_2, pr_1)$ is the *twist map*.

6.1.2 Example

Magma / monoid / group

An internal group in the category Set of sets is what we normally call a group; similarly for the structures of (commutative) magma or monoid. \diamond

In (6.1.1), if the category \mathcal{X} is pointed, then $e = 0$ is the unique unit in every object X . The commutativity of the diagram involving the map i may be conceptualized by saying that i is a two-sided inverse with respect to μ . The following lemma asserts that, if an internal monoid admits a two-sided inverse operation, then this inverse operation is unique.

6.1.3 Lemma

Inverse operation on monoid is unique

In the setting of (6.1.1), if $i, i': X \rightarrow X$ are two-sided inverse operations turning the monoid (X, μ, e) into an internal group, then $i = i'$.

Whenever an object X in a category \mathcal{X} carries one of the internal structures defined in (6.1.1), then $\text{Hom}_{\mathcal{X}}(-, X)$ is canonically a functor from \mathcal{X}^{op} to the category of those structures, and vice versa:

6.1.4 Theorem

Internal magma yields magma Hom-sets

In a category \mathcal{X} , an internal unitary magma structure (X, μ, e) on an object X determines a factorization M of $\text{Hom}_{\mathcal{X}}(-, X)$ through the category Mag of unitary magmas, as in the diagram

$$\begin{array}{ccc} & & \text{Mag} \\ & \nearrow M & \downarrow u \\ \mathcal{X}^{op} & \xrightarrow{\text{Hom}_{\mathcal{X}}(-, X)} & \text{Set}_* \end{array}$$

Furthermore,

- (i) If μ is associative, respectively commutative, then so is the unitary magma $M(A)$, for every A in \mathcal{X} .
- (ii) If (X, μ, e, i) is an internal group, then $M: \mathcal{X}^{op} \rightarrow \text{Grp}$.
- (iii) If (X, μ, e, i) is an internal commutative group, then $M: \mathcal{X}^{op} \rightarrow \text{Ab}$.

Proof First, we note that every A in \mathcal{X} , the set $H_A := \text{Hom}_{\mathcal{X}}(A, X)$ has a distinguished element e_A , namely the composite $A \rightarrow t \xrightarrow{e} X$. Moreover, for every $u: A \rightarrow B$ in \mathcal{X} , we have the commuting diagram

$$\begin{array}{ccccc} A & \xrightarrow{\quad} & t & \xrightarrow{e} & X \\ \downarrow u & & \nearrow & & \\ B & & & & \end{array}$$

This shows that $u^*(e_B) = e_A$ so that the contravariant functor $Hom_{\mathcal{X}}(-, X)$ actually takes values in the category Set_* of pointed sets. A unitary magma structure on $M(A) := H_A$ is given by $\mu_A: H_A \times H_A \rightarrow H_A$, the function which sends $f, g: A \rightarrow X$ to the composite

$$\begin{array}{ccc} A & \xrightarrow{\mu_A(f,g)} & X \\ \Delta_A \downarrow & & \uparrow \mu \\ A \times A & \xrightarrow{f \times g} & X \times X \end{array}$$

To see that M is a functor, we observe that a map $u: B \rightarrow A$ renders the diagram below commutative.

$$\begin{array}{ccccc} B & \xrightarrow{u} & A & \xrightarrow{\mu_A(f,g)} & X \\ \Delta_B \downarrow & & \Delta_A \downarrow & & \uparrow \mu \\ B \times B & \xrightarrow{u \times u} & A \times A & \xrightarrow{f \times g} & X \times X \end{array}$$

Defining $u^*: Hom_{\mathcal{X}}(A, X) \rightarrow Hom_{\mathcal{X}}(B, X)$, by $u^*(f) := fu$, we conclude that $u^*\mu_A(f, g) = \mu_B(u^*f, u^*g)$. Via similar reasoning, associativity and commutativity of μ_A follow from the corresponding properties of μ . If i is the inverse operation of the internal group X , then $i_*: H_A \rightarrow H_A$ is the inverse operation on the associative monoid H_A . (iii) follows by similar reasoning. \square

6.1.5 Theorem

Magma Hom-sets yield internal magma

In a category \mathcal{X} with finite products, a factorization of $H := Hom_{\mathcal{X}}(-, X)$ as a composite

$$\begin{array}{ccc} & & \text{Mag} \\ & \nearrow M & \downarrow U \\ \mathcal{X}^{op} & \xrightarrow{Hom_{\mathcal{X}}(-, X)} & \text{Set}_* \end{array}$$

determines uniquely the structure of an internal unitary magma (X, μ, e) on X with the property that

$$\mu_A(f, g) = \mu \circ (f \times g) \circ \Delta_A, \quad \text{for all } f, g: A \rightarrow X.$$

Here (H_A, μ_A) is the internal magma structure on $H_A := H(A) = Hom_{\mathcal{X}}(A, X)$. If the codomain of M is the category of (commutative) monoids, then μ is (commutative) associative. If the codomain of M is Grp , then there is a unique $i: X \rightarrow X$ such that (X, μ, e, i) is an internal group in \mathcal{X} . If the codomain of M is Ab , then (X, μ, e, i) is an internal abelian group.

Proof To construct the internal multiplication on X , let $pr_1, pr_2: X \times X \rightarrow X$ be the projections onto the first and second factor. Then $\mu := \mu_{X \times X}(pr_1, pr_2): X \times X \rightarrow X$ is an internal magma structure on X . Then the magma operation μ_A on H_A is given by μ because any two morphisms $f, g: A \rightarrow X$ determine $(f, g): A \rightarrow X \times X$ for which the functor property of M renders this diagram commutative:

$$\begin{array}{ccc}
 M_{X \times X} \times M_{X \times X} & \xrightarrow{\mu_{X \times X}} & M_{X \times X} \\
 (f, g)^* \times (f, g)^* \downarrow & & \downarrow (f, g)^* \\
 M_A \times M_A & \xrightarrow{\mu_A} & M_A
 \end{array}
 \qquad
 \begin{array}{ccc}
 (pr_1, pr_2) & \xrightarrow{\quad} & \mu \\
 \downarrow & & \downarrow \\
 (f, g) & \xrightarrow{\quad} & \mu \circ (f, g) \\
 & & \mu_A(f, g)
 \end{array}$$

If M takes values in the category of unitary magmas, then each M_A contains a designated element $e_A: A \rightarrow X$ such that

$$\mu_A(f, e_A) = f = \mu_A(e_A, f)$$

If τ is a terminal object in \mathcal{X} , let $t_A: A \rightarrow \tau$ be the unique map. Then functoriality of M yields:

$$e_A = t_A^*(e_\tau) = e_\tau \circ t_A, \quad A \xrightarrow{t_A} \tau \xrightarrow{e_\tau} X$$

Then (X, μ, e) is an internal unitary magma structure on X because neutrality of e on the right follows from this computation.

$$\mu \circ (1_X \times \hat{e}) \circ \Delta_X = \mu \circ (1_X, \hat{e}) = \mu_X(1_X, \hat{e}) = 1_X$$

Neutrality of e on the left follows similarly.

To see that μ is unique, suppose $\mu': X \times X \rightarrow X$ is another map with

$$\mu_A(f, g) = \mu' \circ (f \times g) \circ \Delta_A$$

for all $f, g: A \rightarrow X$. Then, using that $(pr_1 \times pr_2) \circ \Delta_{X \times X} = 1_{X \times X}$, we see:

$$\mu = \mu \circ (pr_1 \times pr_2) \circ \Delta_{X \times X} = \mu_{X \times X}(pr_1, pr_2) = \mu' \circ (pr_1 \times pr_2) \circ \Delta_{X \times X} = \mu'.$$

Next, if $M: \mathcal{X}^{op} \rightarrow \mathbf{Mnd}$, we need to show that μ is associative. We know that the diagram below commutes. So, the projections $pr_1, pr_2, pr_3: X^3 \rightarrow X$ are mapped as shown on the right.

$$\begin{array}{ccc}
 M_{X^3} \times M_{X^3} \times M_{X^3} & \xrightarrow{1 \times \mu_{X^3}} & M_{X^3} \times M_{X^3} \\
 \mu_{X^3} \times 1 \downarrow & & \downarrow \mu_{X^3} \\
 M_{X^3} \times M_{X^3} & \xrightarrow{\mu_{X^3}} & M_{X^3}
 \end{array}
 \qquad
 \begin{array}{ccc}
 (pr_1, pr_2, pr_3) & \xrightarrow{\quad} & (pr_1, \mu \circ (pr_2, pr_3)) \\
 \downarrow & & \downarrow \\
 (\mu \circ (pr_1, pr_2), pr_3) & \xrightarrow{\quad} & \mu \circ (pr_1, \mu \circ (pr_2, pr_3)) \\
 & & \mu \circ (\mu \circ (pr_1, pr_2), pr_3)
 \end{array}$$

Spelling out in detail how the two composites on the bottom right are formed, we arrive at this diagram:

$$\begin{array}{ccccccc}
 X^3 & \xrightarrow{\Delta_{X^3}} & X^3 \times X^3 \times X^3 & \xrightarrow{pr_1 \times pr_2 \times pr_3} & X \times X \times X & \xrightarrow{1_X \times \mu} & X \times X \\
 & & & & \downarrow \mu \times 1_X & & \downarrow \mu \\
 & & & & X \times X & \xrightarrow{\mu} & X
 \end{array}$$

The clockwise composite $X^3 \rightarrow X$ is $\mu \circ (pr_1, \mu \circ (pr_2, pr_3))$, and the counterclockwise composite is $\mu \circ (\mu \circ (pr_1, pr_2), pr_3)$. Now, notice that $(pr_1 \times pr_2 \times pr_3) \circ \Delta_{X^3} = 1_{X^3}$, and the associativity of μ follows.

Finally, if $M: \mathcal{X}^{op} \rightarrow \text{Grp}$, we just established the structure (X, μ, e) of an internal monoid. For it to become an internal group structure, we need an internal inverse operation i on X . Let $I: M \Rightarrow M$ be the natural transformation, unique by (6.1.3), such that (M_A, μ_A, E_A, I_A) is a group object structure on $M_A = \text{Hom}_{\mathcal{X}}(A, X)$. We claim that $i := I_X(1_X)$ yields an internal group (X, μ, e, i) . To see this, note that this composite is \hat{e} :

$$\begin{array}{ccccccc}
 M_X & \xrightarrow{\Delta_X} & M_X \times M_X & \xrightarrow{1_X \times I_X} & M_X \times M_X & \xrightarrow{\mu_X} & M_X \\
 1_X & \longmapsto & (1_X, 1_X) & \longmapsto & (1_X, i) & \longmapsto & \mu_X(1_X, i) = \hat{e}
 \end{array}$$

Since $\mu_X(1_X, i)$ is given by the composite $X \xrightarrow{\Delta_X} X \times X \xrightarrow{1_X \times i} X \times X \xrightarrow{\mu} X$, we see that i is a right inverse. A similar argument shows that i acts as left inverse, and the proof is complete. \square

6.1.6 Corollary $i^2 = i \circ i = 1$ for inverse operation of internal group
 If (X, μ, e, i) is an internal group, then $i^2 = 1_X$.

Proof From Theorem 6.1.4 and the proof of part (ii), we know that $G := \text{Hom}(X, X)$ is a group. The left inverse of $f \in G$ is given by $i \circ f$. It follows that, for all $g \in G$,

$$\mu \circ (f, i \circ f) = e = \mu \circ (i \circ f, f), \quad \text{hence} \quad \mu \circ (i^2 \circ f, i \circ f) = e = \mu \circ (f, i \circ f)$$

This means that, in the group G ,

$$f \cdot (i \circ f) = (i^2 \circ f) \cdot (i \circ f) \quad \text{and so} \quad f = i^2 \circ f$$

This means that i^2 is a left identity in the monoid $(\text{Hom}(X, X), \circ)$, and so $i^2 = 1_X$. \square

6.1.7 Definition

Morphism of internal magmas/monoids/groups

In a category \mathcal{X} with finite products, let S denote any of the internal structures (commutative) magma, monoid, group. A *morphism of S -objects* X and Y is given by a morphism $f: X \rightarrow Y$ which commutes with the S -structures diagrams in Definition 6.1.1.

A morphism $f: X \rightarrow Y$ of S -objects induces, for every object U in \mathcal{X} a morphism of S -structures on Hom-sets.

$$f_*: \text{Hom}_{\mathcal{X}}(U, X) \longrightarrow \text{Hom}_{\mathcal{X}}(U, Y)$$

Remarkable is that f is a morphism of any of the structures (commutative) unitary magma, monoid, group if and only if f is a morphism of the underlying unitary magmas.

Comment on the approach taken in this section

In our discussion of internal objects, we used elementary methods only. However, we also point out that a treatment which is both more efficient and more conceptual is possible using Yoneda embeddings—see [10], for instance.

Exercises

6.1.8 Exercise

Recognizing a morphism of internal magmas/monoids/groups

In the setting of Definition 6.1.7, show the following about an \mathcal{X} -morphism $f: X \rightarrow Y$:

- (i) For every object U in \mathcal{X} , f induces a morphism of S -structures $f_*: \text{Hom}_{\mathcal{X}}(U, X) \rightarrow \text{Hom}_{\mathcal{X}}(U, Y)$.
- (ii) f is a morphism of underlying S -structures if and only if f is a morphism of underlying unitary magmas.

6.2 Biproducts and Linear Categories

Here we provide categorical foundations for a discussion of internal abelian group objects and abelian categories. Thus we are working in a category \mathcal{X} which is enriched over pointed sets; see Section 1.3.

Already the environment of a pointed category supports a discussion of biproducts familiar from abelian categories: If objects X and Y admit both a coproduct and a product, then there is a canonical comparison map $\gamma_{X,Y}: X + Y \rightarrow X \times Y$. Whenever $\gamma_{X,Y}$ is an isomorphism, we can ‘compress’ it into a single object via (6.2.4), called a biproduct of X and Y , denoted $X \oplus Y$.

Quite useful is that a zero object in \mathcal{X} can be recognized by the property that it is neutral with respect to the formation of biproducts: An object I is a zero object if and only if, for every A in \mathcal{X} , $A \oplus I = A = I \oplus A$.

A bit deeper is that, whenever an object X in a pointed category \mathcal{X} admits finite biproducts, then the map $\mu = \langle 1_X, 1_X \rangle: X \oplus X \rightarrow X$ turns X into an internal commutative monoid object in \mathcal{X} with ‘neutral element’ given by the morphism $0: 0 \rightarrow X$. Moreover, μ is the one and only internal monoid map on X ; see (6.2.8). While this kind of result is familiar from additive categories, we see here that it holds in much greater generality.

Proposition 6.2.8 motivates the concept of ‘linear category’ (6.2.9), that is a pointed category in which the biproduct $X \oplus Y$ of any two objects exists. Consequently, every object in a linear category \mathcal{X} carries a unique structure of an internal commutative monoid. So, \mathcal{X} has Hom-sets which are commutative monoids. Moreover, this commutative monoid structure on Hom-sets responds biadditively to composition of morphisms, and so \mathcal{X} is enriched in the category \mathbf{CMon} of commutative monoids.

Since categories which are \mathbf{CMon} -enriched are \mathbf{Set}_* -enriched, the concept of a biproduct makes sense. Remarkable is that the commutative monoid structure on Hom-sets enables us to identify a biproduct structure diagram without referring to either of its universal properties; see (6.2.11). As an immediate application we show that, whenever a category \mathcal{X} is enriched over \mathbf{CMon} , then any product cone and any coproduct cocone admits a unique expansion to a biproduct; see (6.2.12).

This implies (6.2.14) that a category with finite sums or finite products is linear if and only if it is enriched in the category \mathbf{CMon} of commutative monoids. Consider then a finitely complete category and form the full subcategory $\mathbf{CMon}(\mathcal{X})$ of internal commutative monoids. As the product of any two commutative monoids is again one such, $\mathbf{CMon}(\mathcal{X})$ has finite products, hence is linear; see (6.2.15).

To get started, let \mathcal{X} be a category, enriched over pointed sets. Assume that, for a pair X and Y of objects in \mathcal{X} , both their coproduct $(X + Y, i_X, i_Y)$ and their product $(X \times Y, pr_X, pr_Y)$ exist. Using the zero-map of \mathcal{X} enables us to construct the map

$$\gamma_{X,Y} := (\langle 1_X, 0 \rangle, \langle 0, 1_Y \rangle) = \langle \langle 1_X, 0 \rangle, \langle 0, 1_Y \rangle \rangle: X + Y \rightarrow X \times Y.$$

We refer to $\gamma_{X,Y}$ as the *coproduct/product comparison map* of X and Y .

6.2.1 Proposition

Properties of the coproduct/product comparison map

In a category enriched over pointed sets, the coproduct/product comparison map of X

and Y fits into the commutative diagram

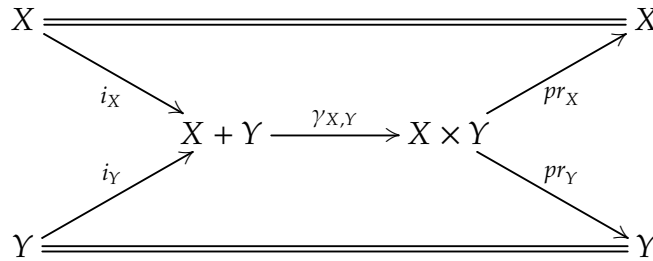

with the properties $pr_Y \gamma_{X,Y} i_X = 0_{YX}$ and $pr_X \gamma_{X,Y} i_Y = 0_{XY}$.

Proof To see that the top part of the diagram commutes, we compute:

$$pr_X \gamma_{X,Y} i_X = pr_X \langle (1_X, 0), (0, 1_Y) \rangle i_X = pr_X (1_X, 0) = 1_X$$

That the bottom part of the diagram commutes follows via a similar argument. Now

$$pr_Y \gamma_{X,Y} i_X = pr_Y \langle (1_X, 0_{YX}), (0_{XY}, 1_Y) \rangle i_X = \langle 1_X, 0_{YX} \rangle i_X = 0_{YX} i_X = 0_{YX}.$$

A similar computation shows that $pr_X \gamma_{X,Y} i_Y = 0_{XY}$. □

If $\gamma_{X,Y}$ is an epimorphism, the $pr_Y = \text{coker}((1_X, 0))$; see Exercise 6.2.19. Next, we single out the special case where the coproduct/product comparison map is the identity map.

6.2.2 Definition

Biproduct

In a Set_* -enriched category \mathcal{X} we say that objects X and Y admit a biproduct if and only if there exists an object B in \mathcal{X} , together with a commutative diagram of maps

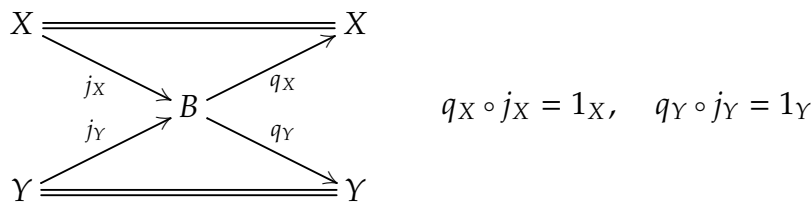

such that the following conditions hold:

- (i) (B, j_X, j_Y) is a coproduct of X and Y ;
- (ii) (B, q_X, q_Y) is a product of X and Y ;
- (iii) $q_Y j_X = 0_{YX}$, and $q_X j_Y = 0_{XY}$.

In this situation, we write $B = X \oplus Y$.

6.2.3 Remark

Biproduct inclusions and projections are canonical

In Definition 6.2.2, the interpretation of B as a product of X and Y allows us to write $j_X = (1_X, 0)$ and $j_Y = (0, 1_Y)$. Dually, $q_X = \langle 1_X, 0 \rangle$ and $q_Y = \langle 0, 1_Y \rangle$.

6.2.4 Proposition

Existence of biproducts

In a Set_* -enriched category \mathcal{X} , objects X and Y admit a biproduct if and only if both the sum and the product of X and Y exist, and the coproduct/product comparison map for X and Y is an isomorphism.

Proof If X and Y admit a biproduct $X \oplus Y$, then $X + Y \cong X \oplus Y \cong X \times Y$ by universality. This implies that the coproduct/product comparison map for X and Y is an isomorphism. Conversely, if $\gamma_{X,Y}$ is an isomorphism, set

$$B := X + Y, \quad j_X := i_X, \quad j_Y := i_Y, \quad q_X := pr_X \gamma_{X,Y}, \quad q_Y := pr_Y \gamma_{X,Y}$$

Then properties (i) and (iii) are satisfied by design. It remains to show that (B, q_X, q_Y) is a product of X and Y . If $f: A \rightarrow X$ and $g: A \rightarrow Y$ be given, then there exists $(f, g): A \rightarrow X \times Y$ unique with

$$pr_X(f, g) = f \quad \text{and} \quad pr_Y(f, g) = g.$$

Put $\phi := \gamma_{X,Y}^{-1}(f, g): A \rightarrow B$. Then

$$q_X \phi = pr_X(f, g) = f \quad \text{and} \quad q_Y \phi = pr_Y(f, g) = g.$$

Moreover, if $\psi: A \rightarrow B$ is arbitrary with $q_X \psi = f$ and $q_Y \psi = g$, then $\gamma_{X,Y} \psi = (f, g)$, and so $\phi = \psi$. \square

6.2.5 Corollary

Zero object via biproduct, I

In a category enriched over pointed sets, an object I is a zero object if and only if for each object A , the diagram

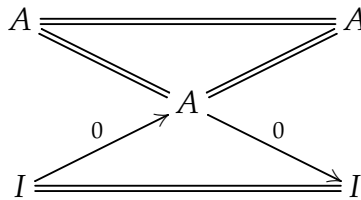

commutes and represents A as a biproduct of A and I .

Proof If I is a zero object and A is arbitrary then the diagram commutes; we encourage the reader to verify the biproduct recognition conditions of Proposition 6.2.4.

For the converse, we prove that I is terminal. Then I is initial by duality. For a given object A , we show that $0: A \rightarrow I$ is the only map. Indeed, for an arbitrary $a: A \rightarrow I$, the product

property of the right hand part of the diagram tells us that the diagram of solid arrows below is rendered commutative by the filler c .

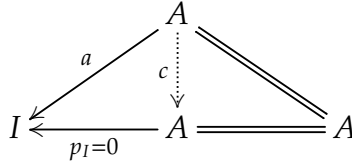

It follows that $c = 1_A$ and, hence, $a = p_I = 0$. - This completes the proof. □

6.2.6 Corollary

Zero object via biproduct, II

In a category enriched over pointed sets, an object I is a zero object if and only if, for each object A , every one of the maps

$$A \oplus I \begin{matrix} \xrightarrow{\langle 1_A, 0 \rangle} \\ \xleftarrow{(1_A, 0)} \end{matrix} A \begin{matrix} \xrightarrow{(0, 1_A)} \\ \xleftarrow{\langle 0, 1_A \rangle} \end{matrix} I \oplus A$$

is an isomorphism. ◇

6.2.7 Remark

Finite Biproducts

If a category admits binary biproducts, then it admits biproducts for any finite collection of objects. The details are a bit intricate, and we organize an approach in Exercise [A.1.19](#).

Let us now turn to a fundamental relationship between biproducts in a pointed category and internal monoids.

6.2.8 Proposition

Commutative internal monoid from biproduct

In a pointed category \mathcal{X} , suppose an object X admits a biproduct $X \oplus X$. Then

$$\mu := \langle 1_X, 1_X \rangle: X \oplus X \rightarrow X$$

forms an internal commutative monoid (X, μ) with unit $e: 0 \rightarrow X$. Moreover, μ is the only internal unitary magma structure on X .

Proof Via the sum property, diagram (U) in (6.1.1) shows that μ is unitary and unique, and that diagram (C) commutes. Note that here we make implicit use of Remark 6.2.3. - This was to be shown. □

6.2.9 Definition

Linear category

A pointed category \mathcal{X} is called *linear* or *half-additive* if for any pair of objects X and Y the sum and product exists and if the comparison map $\gamma_{X,Y}: X+Y \rightarrow X \times Y$ is an isomorphism.

In other words, a linear category is a category *with finite biproducts*: it is pointed and for any finite collection of objects X_1, \dots, X_n , $n \geq 1$, their biproduct $X_1 \oplus \dots \oplus X_n$ exists; see (6.2.7).

6.2.10 Proposition

Linear category and commutative monoids

If \mathcal{X} is a linear category, then we have an equivalence $\text{CMon}(\mathcal{X}) = \mathcal{X}$.

Proof If X is an object of \mathcal{X} , then Proposition 6.2.8 tells us that the fold map $\langle 1_X, 1_X \rangle$ on X is an internal commutative monoid on X , and it is the only such structure. So, it remains to check that each morphism $f: X \rightarrow Y$ in \mathcal{X} is a morphism of internal monoid structures. To see this, verify that the identity $\langle 1_Y, 1_Y \rangle \circ (f + f) = f \circ \langle 1_X, 1_X \rangle$ holds on the summands of $X + X$. \square

With Corollary 6.2.15 below we provide a converse to this statement: each category of internal monoids in a category with finite products is linear.

Combined, Propositions 6.1.4 and 6.2.8 show that all objects in a linear category \mathcal{X} carry a unique internal commutative monoid structure and, hence, that each Hom-set $\text{Hom}_{\mathcal{X}}(A, X)$ carries a commutative monoid structure which responds biadditively to composition. In other words, \mathcal{X} is a category *enriched over commutative monoids*.

We are now going to prove the converse, and obtain Proposition 6.2.14 which says that a category with finite sums or finite products is linear if and only if it is enriched over the category CMon of commutative monoids.

6.2.11 Lemma

Recognizing a biproduct via CMon -enrichment

In a category enriched over commutative monoids, a commutative diagram

$$\begin{array}{ccc}
 X & \xrightarrow{\quad\quad\quad} & X \\
 & \searrow^{i_X} & \nearrow_{p_X} \\
 & & B \\
 & \nearrow_{i_Y} & \searrow_{p_Y} \\
 Y & \xrightarrow{\quad\quad\quad} & Y
 \end{array}
 \quad p_X \circ i_X = 1_X, \quad p_Y \circ i_Y = 1_Y \quad (6.2.11)$$

describes B as a biproduct of X and Y if and only if

$$p_Y i_X = 0_{YX} \quad \text{and} \quad p_X i_Y = 0_{XY} \quad \text{and} \quad i_X p_X + i_Y p_Y = 1_B.$$

Proof Suppose the diagram describes B as a biproduct. Then

$$p_X(i_X p_X + i_Y p_Y) = p_X \quad \text{and} \quad p_Y(i_X p_X + i_Y p_Y) = p_Y$$

so that $i_X p_X + i_Y p_Y = 1_B$ by the universal property of the product.

Conversely, if the morphisms in the diagram satisfy the stated identities, then i_X and i_Y are structure maps for the sum of X and Y . To see this, suppose $f_X: X \rightarrow Z$ and $f_Y: Y \rightarrow Z$ are given. Then $\varphi := f_X p_X + f_Y p_Y$ satisfies $\varphi i_X = f_X$ and $\varphi i_Y = f_Y$. To see that the map φ is unique with this property, suppose $\psi: B \rightarrow Z$ satisfies $\psi i_X = f_X$ and $\psi i_Y = f_Y$. Then

$$\psi = \psi(i_X p_X + i_Y p_Y) = f_X p_X + f_Y p_Y = \varphi(i_X p_X + i_Y p_Y) = \varphi$$

Dual reasoning shows that p_X and p_Y are structure maps for a product. \square

6.2.12 Proposition

Biproduct from product or coproduct

For any two objects X and Y in a category enriched over \mathbf{CMon} the following hold:

- (i) Any product cone $X \xleftarrow{p_X} B \xrightarrow{p_Y} Y$ admits an expansion to a biproduct diagram (6.2.11). Moreover, this expansion is unique.
- (ii) Any coproduct cocone $X \xrightarrow{i_X} B \xleftarrow{i_Y} Y$ admits an expansion to a biproduct diagram (6.2.11). Moreover, this expansion is unique.

Proof We prove (i), the verification of (ii) is dual. As candidates for coproduct structure maps, we propose $i_X = (1_X, 0)$ and $i_Y = (0, 1_Y)$. It then remains to check that the resulting diagram of shape (6.2.11) meets the requirements of the biproduct recognition criterion (6.2.11). By design, diagram (6.2.11) commutes, and the diagonal composites vanish. Via the universal property of the product, the following computations imply that $i_X p_X + i_Y p_Y = 1_B$:

$$p_X(i_X p_X + i_Y p_Y) = p_X + 0 = p_X 1_X \quad \text{and} \quad p_Y(i_X p_X + i_Y p_Y) = 0 + p_Y = p_Y 1_B$$

Finally, to see that the maps i_X and i_Y are the only maps which complete p_X and p_Y to a biproduct, we compute

$$j_X = 1_X j_X = (i_X p_X + i_Y p_Y) j_X = i_X + 0 = i_X$$

A similar argument shows that $j_Y = i_Y$, and this completes the proof. \square

6.2.13 Corollary

Initial / terminal object is zero-object

If in a category enriched over commutative monoids an initial or a terminal object exists, then this category is pointed.

Proof We show that an initial object is also a terminal object. Dualizing will then complete the proof. So, consider the situation where I is initial and A is any object. Note first that the left hand side of the diagram below is the cocone of A as a coproduct of A

and I .

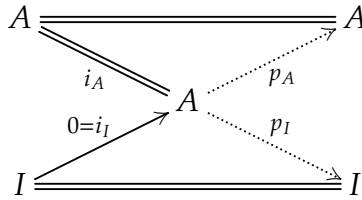

By (6.2.12) there exist $p_A: A \rightarrow A$ and $p_I: A \rightarrow I$ such that the right hand side of the diagram is the structure diagram of the product of A by I . Clearly $p_A = 1_A$. As $p_I i_A = 0$, we have $p_I = 0$. The result now follows from Corollary 6.2.5. \square

6.2.14 Corollary **Linear if and only if enriched in commutative monoids**
 A category \mathcal{X} with either finite sums or finite products is linear if and only if it is enriched in the category of commutative monoids.

Proof If \mathcal{X} is linear then (6.2.8) is the key to showing that \mathcal{X} is enriched over commutative monoids.

Conversely, if \mathcal{X} is enriched over commutative monoids. Then the existence of either finite sums or finite products implies that \mathcal{X} is pointed (by Corollary 6.2.13, since a nullary sum is an initial object, while a nullary product is a terminal object) and has biproducts (by Proposition 6.2.12). So, \mathcal{X} is linear. \square

6.2.15 Corollary **Internal commutative monoids form linear category**
 The category $\text{CMon}(\mathcal{X})$ of internal commutative monoids in any category with finite products \mathcal{X} is linear.

Proof Motivated by (6.2.14), we show that $\text{CMon}(\mathcal{X})$ admits binary products via the following construction. For commutative monoids (A, μ) and (B, ν) , their product $A \times B$ in \mathcal{X} is again a commutative monoid, with the structure map

$$(A \times B) \times (A \times B) \xrightarrow{1_A \times \tau \times 1_B} (A \times A) \times (B \times B) \xrightarrow{\mu \times \nu} A \times B$$

Here $\tau = (pr_A, pr_B): B \times A \rightarrow A \times B$ denotes the twist map. - The proof is left to the reader. \square

6.2.16 Example **Categories enriched in commutative monoids**
 Examples of linear categories include the category of commutative monoids, the category Ab of abelian groups, or the category of modules over a given ring. In the latter two examples Hom-sets are actually abelian groups.

Summarizing, we state:

6.2.17 Theorem Recognizing a category of commutative monoid objects

For a pointed category \mathcal{X} with finite products the following are equivalent:

- (i) \mathcal{X} is a linear category;
- (ii) \mathcal{X} is enriched in the category \mathbf{CMon} of commutative monoids;
- (iii) every object in \mathcal{X} carries the structure of an internal commutative monoid such that, for every object A every morphism $f: X \rightarrow Y$ induces a morphism of commutative monoids $f_*: \mathit{Hom}(A, X) \rightarrow \mathit{Hom}(A, Y)$;
- (iv) $\mathcal{X} \simeq \mathbf{CMon}(\mathcal{X})$.

Proof The equivalence of (i) and (ii) is given by (6.2.14). The implication (ii) \Rightarrow (iii) is given by (6.1.5). The implication (iii) \Rightarrow (ii) is given by (6.1.4). The equivalence between (iv) and (i) is given by Corollary 6.2.15 and Proposition 6.2.10. \square

Notes on the comparison map $\gamma_{X,Y}$

Given objects X and Y , we constructed the coproduct/product comparison map explicitly as $\gamma_{X,Y} := \langle (1_X, 0), (0, 1_Y) \rangle = \langle (1_X, 0), (0, 1_Y) \rangle$. Remarkably, the maps $\gamma_{X,Y}$ are isomorphisms if there exists any natural family of isomorphisms $\psi_{X,Y}: X + Y \cong X \times Y$; see [57, 3].

Exercises

6.2.18 Exercise Internal monoid in preadditive category
Show that an internal monoid in a category that is enriched in \mathbf{Ab} is an internal abelian group.

6.2.19 Exercise Product projection normal epi - z-Ex
If the comparison map $\gamma_{X,Y}: X + Y \rightarrow X \times Y$ is an epimorphism, then the projection $pr_Y: X \times Y \rightarrow Y$ is the cokernel of the inclusion $(1_X, 0)$.

6.2.20 Exercise (Normal) subobjects in \mathbb{N}
In the commutative monoid $\mathbb{N} = \{0, 1, 2, \dots\}$ show the following:

- (i) A subset $S \subseteq \mathbb{N}$ is a subobject of \mathbb{N} if and only if there are $a_1, \dots, a_k \in \mathbb{N}$ such that

$$S = \{t_1 a_1 + \dots + t_k a_k \mid t_1, \dots, t_k \in \mathbb{N}\}$$

- (ii) A subset $S \subseteq \mathbb{N}$ is a normal subobject of \mathbb{N} if and only if there is $a \in \mathbb{N}$ such that $S = a\mathbb{N}$.
- (iii) In \mathbb{N} , the join (as subobjects) of two normal subobjects need not be a normal subobject.
- (iv) In \mathbf{CMon} a pullback of normal monomorphisms need not be a normal pullback.

6.2.21 Exercise Biproduct induces special relation - H
In a homological category, use (4.5.6) to show that if $X \times X \cong X + X$ is a biproduct (6.2.2), then $(X \oplus X, \pi_1, \nabla_X)$ is a relation (6.3) on X . (Compare with 4.8.1.)

6.3 Internal Graphs and Internal Relations

The notion of (equivalence) relation admits categorical conceptualization as in (6.3.2). Thus, an internal relation on an object X in a category with binary products \mathcal{X} is a subobject of the product $X \times X$. We present the notion of internal relation, along with any of the optional properties of being reflexive, symmetric, or transitive. Thus we arrive at the concept of an internal equivalence relation.

Given a morphism $f: X \rightarrow Y$ in a category \mathcal{X} , we are most interested in the relation given by its kernel pair $(KP(f), d_1, d_2)$. If \mathcal{X} is a variety of algebras, then this relation on X is an equivalence relation, and its equivalence classes are the fibers of f .

More generally, a graph from X to Y is a map $g: G \rightarrow X \times Y$. So, a relation is a special kind of graph. These concepts actually admit a formulation which does not involve products at all:

6.3.1 Definition

Internal graph

In any category an *internal (directed) graph from X to Y* is given by a span $X \xleftarrow{g_1} G \xrightarrow{g_2} Y$.

6.3.2 Definition

Internal relation

In any category, an *internal relation from X to Y* is an internal graph $X \xleftarrow{g_1} G \xrightarrow{g_2} Y$ in which the pair (g_1, g_2) is jointly monomorphic. An *internal relation on X* is an internal relation from X to X .

In a category with binary products, an internal graph is fully determined by a map $g = (g_1, g_2): G \rightarrow X \times Y$. Such g is an internal relation if and only if it represents a subobject of $X \times Y$.

6.3.3 Notation

aRb

Given an internal relation $X \xleftarrow{d_1} R \xrightarrow{d_2} Y$, whenever a span $X \xleftarrow{x} A \xrightarrow{y} Y$ factors through (d_1, d_2) via a map $f: A \rightarrow R$, then the map f is unique, and we write aRb .

6.3.4 Example

Relation on a set

When working with a relation on a set X , given by a subset of $X \times X$, a pair $(x, y) \in X \times X$ belongs to R if and only if the corresponding function $(x, y): A \rightarrow X \times X$ factors through R . This motivates the notation xRy in general.

Recall from Section 1.1 that subobjects of a given object are partially ordered. Thus, in a category with binary products, we obtain an induced partial ordering of the relations from X to Y . Proceeding analogously, we also obtain a partial ordering on such relations in

categories which may not admit binary products. As such adjustments are straightforward to make in general, we will henceforth consider graphs and relations in categories with binary products.

6.3.5 Example

Discrete relation

The *discrete relation* on an object X is given by the diagonal map $\Delta_X = (1_X, 1_X): X \rightarrow X \times X$.

Discrete relations appear ‘naturally’ as the kernel pairs of monomorphisms; see (A.1.8).

6.3.6 Definition

Reflexive relation

A relation $d = (d_1, d_2): R \rightarrow X \times X$ on an object X is *reflexive* if the discrete relation on X factors through d .

In (6.3.6), the relation R is reflexive exactly when the diagram below has a (necessarily unique) filler e :

$$\begin{array}{ccc}
 X & \xrightarrow{\quad e \quad} & R \\
 \searrow \Delta_X & & \swarrow d \\
 & X \times X &
 \end{array}$$

Interpreted in Set , this means that every $x \in X$ is related to itself. In the notation of (6.3.3), a relation $d: R \rightarrow X \times X$ is reflexive if and only if aRa for all $a: A \rightarrow X$. - The discrete relation on X is least among all reflexive relations on X .

Note also, that, for every reflexive relation (R, d_1, d_2, e) on X , both d_1 and d_2 are absolute epimorphisms sectioned by e .

6.3.7 Definition

Opposite / symmetric relation

The *opposite*¹ relation of a relation (R, d_1, d_2) on X is the relation $(R^\circ, d_1^\circ, d_2^\circ) := (R, d_2, d_1)$. The relation (R, d_1, d_2) is said to be *symmetric* when $R = R^\circ$ as subobjects of $X \times X$.

Thus, a relation $r: R \rightarrow X \times X$ is symmetric if the twist map $\tau := (pr_2, pr_1): X \times X \rightarrow X \times X$ lifts to a map $\tilde{\tau}: R \rightarrow R$ as in this commutative diagram:

$$\begin{array}{ccc}
 R & \xrightarrow{\quad r \quad} & X \times X \\
 \tilde{\tau} \downarrow \text{dotted} & & \downarrow \tau \\
 R & \xrightarrow{\quad r \quad} & X \times X
 \end{array}$$

¹This terminology is in line with the concept of the opposite of a category: both are special cases of the opposite of a directed graph.

Whenever such $\tilde{\tau}$ exists, it is necessarily unique. Moreover, it equals its own inverse, as $\tau \circ \tau = 1_{X \times X}$.

In the notation of (6.3.3), we may express symmetry as the condition that aRb implies bRa . Thus, aRb iff $aR^\circ b$ iff bRa when R is symmetric. Conversely, $d_1 R d_2$ implies $d_2 R d_1$, so that $R^\circ \leq R$, from which $R = R^\circ$ follows.

6.3.8 Definition

Transitive relation

In a category with pullbacks, a relation R is called *transitive* if the diagram below can be filled by a (necessarily unique) map ρ as indicated.

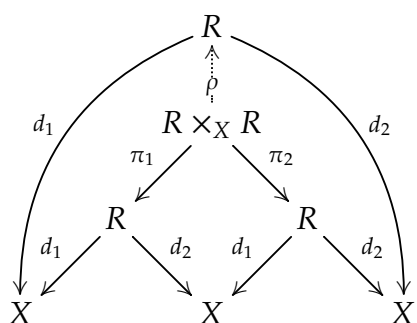

In this diagram, the square in the center is a pullback.

In the notation of (6.3.3), transitivity amounts to the condition that aRb and bRc imply aRc . Indeed, if aRb and bRc for $a, b, c: A \rightarrow X$, then (a, b) and $(b, c): A \rightarrow R$ are such that $d_2 \circ (a, b) = d_1 \circ (b, c)$. The universally induced factorization $(a, b, c): A \rightarrow R \times_X R$ composes to a morphism $\rho \circ (a, b, c): A \rightarrow R$ that satisfies $d_i \circ \rho \circ (a, b, c) = d_i \circ \pi_i \circ (a, b, c)$, which is equal to a when $i = 1$ and to c when i is 2. This shows that aRc .

6.3.9 Definition

Equivalence relation

In a category with pullbacks, an internal relation is an *internal equivalence relation* if it is reflexive, symmetric and transitive.

6.3.10 Example

Indiscrete relation

The *indiscrete relation* on X is represented by the identity $1_{X \times X}: X \times X \rightarrow X \times X$. It is an equivalence relation on X , and is greatest among all relations on X .

6.3.11 Example

Kernel pair is equivalence relation

In a category with pullbacks, the kernel pair of a morphism $f: X \rightarrow Y$ is an equivalence relation.

Proof Reflexivity of the kernel pair relation is assured via the map s in the diagram below.

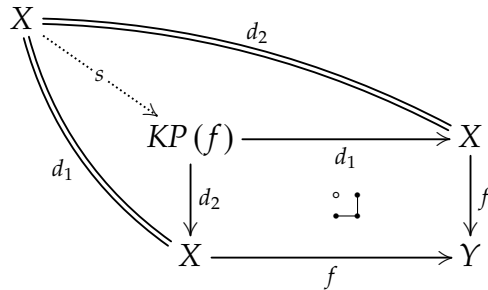

Symmetry of the kernel pair relation is established via the map T below.

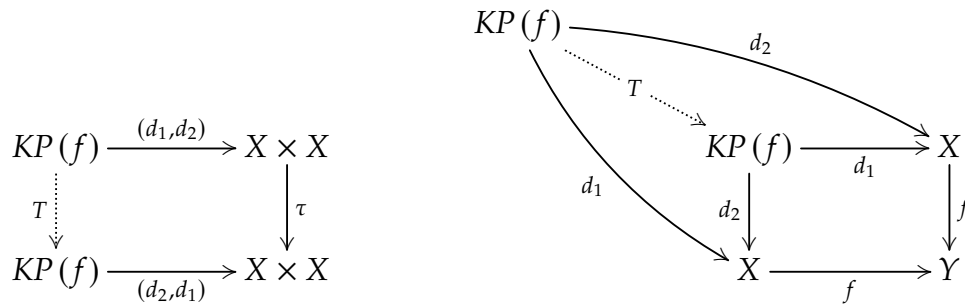

Transitivity of the kernel pair relation holds because the solid arrows in the diagram

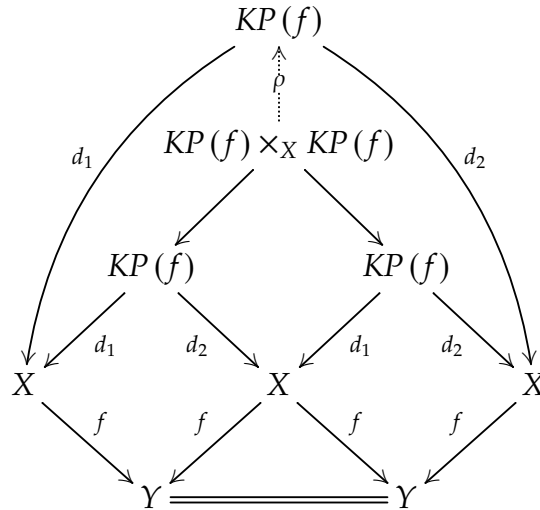

yield a universal map ρ which renders the entire diagram commutative. □

We will see below that there are equivalence relations which are not realizable as a kernel pair. Thus, whenever an equivalence relation is realizable as the kernel pair of some map, it is special, hence merits a name of their own:

6.3.12 Definition

Effective equivalence relation

An equivalence relation which may be obtained as the kernel pair of some morphism is called an *effective* equivalence relation.

Not every equivalence relation is effective, as the following example shows.

6.3.13 Example

Example of a non-effective equivalence relation

In the category $\text{Grp}(\text{Top})$ of topological groups, a subobject is a subgroup whose inclusion is continuous. Hence an equivalence relation (R, d_1, d_2, e) on a topological group X is an equivalence relation (in the usual, set-theoretic sense) on the group underlying X , equipped with a topology such that the inclusion $(d_1, d_2): R \rightarrow X \times X$ is a continuous group homomorphism. This allows for the topology on R to be any refinement of the subspace topology of its image in $X \times X$.

On the other hand, if R is an effective equivalence relation, then necessarily the group R carries the subspace topology induced by $X \times X$, as all limits in Top do. So, as soon as a set X , equipped with the indiscrete topology, has two elements or more, the largest equivalence relation $\nabla_X = (X \times X, \pi_1, \pi_2, 1_X)$ on $X \times X$ equipped with the discrete topology is a non-effective equivalence relation on X in the category $\text{Grp}(\text{Top})$.

6.3.14 Definition

Barr exactness

A regular category (A.4.11) is called *Barr exact* if every equivalence relation is effective.

It is known that all algebraic varieties of algebras are Barr exact. By the above, we know that the category of topological groups is not. Here is another example:

6.3.15 Example

Ab_{tf} is not Barr exact

We give an example of a non-effective equivalence relation in the additive category Ab_{tf} of torsion-free abelian groups. While Ab_{tf} is a homological category (7.5), it is not abelian. We prove that it is not Barr exact by considering the relation (R, d_1, d_2) on \mathbb{Z} defined by mRn if and only if $m - n = 2k$ for some $k \in \mathbb{Z}$. In Ab_{tf} , the coequalizer $q: \mathbb{Z} \rightarrow Q$ of the projections d_1, d_2 is zero, so that the kernel pair of q is $\mathbb{Z} \times \mathbb{Z}$, which contains R as a proper subobject.

6.3.16 Proposition

Effective equivalence relation as a special square

In a finitely bicomplete category, the following conditions are equivalent for an equivalence relation (R, d_1, d_2, e) on an object X :

- (I) (R, d_1, d_2) is an effective equivalence relation.
- (II) (d_1, d_2) is the kernel pair of some morphism $f: X \rightarrow Y$.

(III) (d_1, d_2) is its kernel pair of the coequalizer q of d_1 and d_2 .

(IV) The pushout of d_1 and d_2 yields a bicartesian square:

$$\begin{array}{ccc} R & \xrightarrow{d_1} & X \\ d_2 \downarrow & \square & \downarrow q \\ X & \xrightarrow{q} & Q \end{array}$$

Proof The equivalence between (I) and (II) holds by definition of an effective equivalence relation. (III) \Rightarrow (II) holds by definition.

(II) \Rightarrow (III) If R is the kernel pair of f , we find ourselves in this situation:

$$\begin{array}{ccc} R & \xrightarrow{d_1} & X \\ d_2 \downarrow & \square & \downarrow q \\ X & \xrightarrow{q} & Q \end{array} \quad \begin{array}{c} \searrow f \\ \downarrow t \\ \searrow f \end{array} \quad \begin{array}{c} \\ \\ \rightarrow Y \end{array}$$

The coequalizer of d_1 and d_2 is given by the pushout of d_1 along d_2 ; see (A.2.14). So, there is a universal map t which renders the entire diagram commutative. Via t , the pullback property of the square $R \rightrightarrows Y$ yields the pullback property of the square $R \rightrightarrows Q$. So, (d_1, d_2) is the kernel pair of q .

(IV) \Rightarrow (III) holds by definition. Conversely, if (d_1, d_2) is the kernel pair of the coequalizer q of d_1 and d_2 . Then the associated commutative square is a pullback and, reasoning as in the implication from (II) to (III), a pushout. - This completes the proof. \square

The following proposition (see [32, Proposition 3.9] and [17, Corollary 6]) is an interpretation of (6.3.16) in homological categories. It refines some ideas used in the construction of the image factorization in regular categories (A.4.12).

6.3.17 Proposition

Reflexive graph in homological category - \mathbf{N}

In a normal category \mathcal{X} , consider a reflexive graph on an object X :

$$R \begin{array}{c} \xrightarrow{d_1} \\ \xleftarrow{e} \\ \xrightarrow{d_2} \end{array} X \quad d_1 e = 1_X = d_2 e$$

Write $k: K \rightarrow R$ for the kernel of d_1 . Then the following hold:

- (i) The cokernel of $d_2k: K \rightarrow X$ is the coequalizer of d_1 and d_2 .
- (ii) (R, d_1, d_2) is a relation on X if and only if $d_2k: K \rightarrow X$ is a monomorphism.
- (iii) If \mathcal{X} is homological, then (R, d_1, d_2) is an effective equivalence relation on X if and only if $d_2k: K \rightarrow X$ is a normal monomorphism.

Proof The maps d_1 and d_2 are normal epimorphisms by the (AEN)-condition (3.1.1). From (A.2.14) we know that the pushout of d_1 along d_2 yields the coequalizer $q: X \rightarrow Q$ of d_1 and d_2 :

$$\begin{array}{ccccc}
 K & \xrightarrow{k} & R & \xrightarrow{d_1} & X \\
 \parallel & & \downarrow d_2 & \lrcorner & \downarrow q \\
 K & \xrightarrow{d_2k} & X & \xrightarrow{q} & Q
 \end{array}$$

The top row is a short exact sequence. So $q = \text{coker}(d_2k)$ by (1.5.9.i). - This proves (i).

(ii) If R is a relation then d_1 and d_2 are jointly monic. So, $d_1k = 0$ and d_2k are jointly monic as well. So d_2k is a monomorphism. To see the converse, take the factorization of $(d_1, d_2): R \rightarrow X \times X$ as a normal epimorphism e followed by a monomorphism (m_1, m_2) . Then the kernel $l: L \rightarrow X$ of e is such that $d_2l = m_2el = 0$. So, it factors through k as a morphism $l': L \rightarrow K$ such that $kl' = l$. Now $d_2kl' = m_2el = 0$, so if d_2k is a monomorphism then $l' = 0$. It follows that e is an isomorphism and (R, d_1, d_2) is a relation on X .

(iii) If R is an effective equivalence relation then the square on the right is a pullback. So, $K(q)$ may be represented by d_2k . In particular, d_2k is a normal monomorphism. Conversely, if d_2k is a normal monomorphism, then it is the kernel of its cokernel q , which implies that the square on the right is a pullback by Proposition 4.3.10. So, (d_1, d_2) is an effective equivalence relation on X . \square

6.3.18 Definition

Direct image of a relation - H

In a homological category the *direct image* of a relation (R, d_1, d_2) on an object X under a normal epimorphism $f: X \rightarrow Y$ is (f_*R, d'_1, d'_2) , given by the image factorization of $(f \times f)(d_1, d_2)$, as in the commutative diagram below.

$$\begin{array}{ccc}
 R & \xrightarrow{(d_1, d_2)} & X \times X \\
 \downarrow & & \downarrow f \times f \\
 f_*R & \xrightarrow{(d'_1, d'_2)} & Y \times Y
 \end{array}$$

6.3.19 Lemma

Direct image preserves equivalence relations - H

The 'direct image' operation preserves equivalence relations.

Proof sketch First verify directly that the direct image of a reflexive, symmetric relation along a normal epimorphism is also reflexive and symmetric. To explain why transitivity is preserved, show that when S is the image of R along a normal epimorphism $f: X \rightarrow Y$, then the induced map $R \times_X R \rightarrow S \times_Y S$ is a normal epimorphism. This follows from Corollary 4.4.3 combined with Corollary 4.4.6. \square

Notes

On the relevance of Barr exactness to categorical algebra We will show that all varieties of algebras are Barr exact. They are also a key ingredient in the definition of an abelian category—see Chapter 7. Further, in Section 5.6, we prove that a homological category is Barr exact if and only if it is di-exact; i.e., every antinormal map is normal. As a consequence, every homological variety of algebras is semiabelian.

Chapter 7

Abelian Categories

Efforts toward categorically capturing selected features of abelian groups go back at least as far as Mac Lane in the late 1940's. Beginning with the observation that interpreting certain properties of abelian groups in diagram language reveals an otherwise less obvious form of duality, he conceives of this possibility [61, p. 494]: *'One of our chief objectives is that of providing a background in which the proofs for axiomatic homology theory become exactly dual to those for cohomology theory.'*

Then Cartan–Eilenberg published the first-ever textbook on homological algebra [26]. While its focus is on deriving functors between categories of modules, in its appendix, Buchsbaum applies Mac Lane's axiomatization ideas to the particulars of homological algebra; see also [22]. The result is an abstract categorical setting in which the methods of homological algebra, as presented by Cartan–Eilenberg, are applicable.

Grothendieck's notion of abelian category in [43] extends the scope of homological algebra considerably. For example, if \mathcal{A} is an abelian category, then so is the category of functors from a small category J to \mathcal{A} . Thus any category of presheaves with values in an abelian category forms an abelian category, as does any category of sheaves. Thus, Grothendieck provides a setting whose scope encompasses in a unifying manner what Cartan–Eilenberg presented in module categories as well as Leray's sheaf cohomology [58, 59]. Standard references for abelian categories include [43, 33, 6, 83, 2].

Here, we encounter abelian categories from at least three points of view:

- (A) Coming from a background of abelian categories, homological categories and semiabelian categories appear as vast generalizations.
- (B) Coming from a background of \mathbb{Z} -exact, normal, homological, or semiabelian categories, abelian categories appear as a specialization, with particularly nice features.

(C) Every homological category \mathcal{X} has a *left almost abelian* core $ab(\mathcal{X})$, the full subcategory of objects in \mathcal{X} which admit an internal abelian group structure. If \mathcal{X} is semiabelian, then its abelian core is an abelian category, contained in \mathcal{X} as a full and replete subcategory. It is closed under subobjects and quotients.

Abelian group objects in a homological category are particularly easy to identify: We show that every internal magma in a homological category is automatically an abelian group object. ‘Tierney’s equation’

$$\text{abelian} = \text{additive} + \text{exact}$$

(Theorem 7.5.8) expresses that a Barr exact category is an abelian category if and only if it admits biproducts and a zero object. In particular, for a semiabelian category to be abelian, it suffices that for any two objects A and B the comparison morphism $\gamma_{A,B}: A + B \rightarrow A \times B$ from Proposition 4.2.10 is not just a regular epimorphism, but also a monomorphism, so that binary sums and binary products coincide (they are *biproducts* 6.2.2). A category that satisfies this condition is called a *linear* category (6.2.9), so that

$$\text{abelian} = \text{semiabelian} + \text{linear}.$$

We saw that a pointed category is linear precisely when it is enriched in commutative monoids (6.2.14), so additivity is equivalent to the existence of inverses to the sum in the hom-monoids. The calculus of relations allows us to view this fact differently: a homological category is abelian if and only if every monomorphism is normal (7.6.3). Yet another viewpoint connects right away with the approach in Chapter 2: we have that

$$\text{abelian} = \text{additive} + \text{di-exact}.$$

On the other hand, the fundamental non-self-dual nature of semiabelian categories is reflected in the fact that

$$\text{abelian} = \text{semiabelian} + \text{co-semiabelian}.$$

All of these diverse takes on the concept of an abelian category will be treated in the current chapter.

We will use select combinations of following properties a category \mathcal{X} may have:

- (P.1) (a) \mathcal{X} has finite products.
 (b) \mathcal{X} has kernels.
 (c) \mathcal{X} is finitely complete.
- (P.2) (a) \mathcal{X} has finite sums.

- (b) \mathcal{X} has cokernels.
- (c) \mathcal{X} is finitely cocomplete.
- (P.3) Pushouts preserve normal monomorphisms.
- (P.4) (PNE): Pullbacks preserve normal epimorphisms.
- (P.5) Every monomorphism in \mathcal{X} is a normal monomorphism.
- (P.6) Every epimorphism in \mathcal{X} is a normal epimorphism.
- (P.7) \mathcal{X} is enriched in the category Ab of abelian groups. This means: for all objects X and Y in \mathcal{X} , the set $\text{Hom}_{\mathcal{X}}(X, Y)$ carries the structure of an abelian group. Furthermore, with respect to these abelian group structures, the composition function

$$\text{Hom}_{\mathcal{X}}(Y, Z) \times \text{Hom}_{\mathcal{X}}(X, Y) \longrightarrow \text{Hom}_{\mathcal{X}}(X, Z)$$

is bilinear.

Using combinations of the above properties, a hierarchy of types of categories appears in the literature. Here are the definitions of these types of categories. A discussion of their basic properties forms part of the body of this chapter.

7.0.1 Definition

Hierarchy leading to abelian categories

- (Ab.1) A category \mathcal{X} is *preadditive* if it is enriched in Ab ; i.e. (P.7) holds. By forgetting structure, we have that \mathcal{X} is enriched in CMon ; cf. Section 6.2.
- (Ab.2) A category \mathcal{X} is *additive* if it preadditive and admits finite sums; i.e. (P.2.a) holds. By the results in (6.2) then, \mathcal{X} is linear, so we obtain Proposition 7.1.3 saying that this is equivalent to the existence of finite products (P.1.a). Furthermore, the category is pointed, and each finite sum is actually a finite biproduct, see (7.1.3). On the other hand, in any additive category, the (KSG)-condition holds (7.2.10) and by self-duality, also the dual of this condition.
- (Ab.3) A category \mathcal{X} is *preabelian* if it is additive and every morphism has a kernel and a cokernel. So a preabelian category is, in particular, z -exact. In other words, a category is preabelian when it is enriched in Ab , has a zero object, and is finitely complete and finitely cocomplete; see (7.3.1). The validity of (KSG) now implies that a preabelian category is both protomodular and co-protomodular (4.10).
- (Ab.4) A category is *left almost abelian* if it is preabelian and (P.4) holds: a pullback of a normal epimorphism is again a normal epimorphism, condition (PNE). Since also

(KSG) holds, a left almost abelian category is always homological (4.1). Dually, a *right almost abelian* category is preabelian with pushout-stable normal monomorphisms. It is always a co-homological category. An *almost abelian category* satisfies both conditions. Left almost abelian, right almost abelian, and almost abelian categories coincide with so-called left quasi-abelian, right quasi-abelian and quasi-abelian categories, respectively. We show that a category is quasi-abelian/almost abelian when it is simultaneously homological and co-homological.

(Ab.5) A category is *abelian* if it is a preabelian category in which conditions (P.5) and (P.6) hold. We show (7.5.8) that in an additive context, this is equivalent to p-exactness; i.e., all morphisms are normal. As a consequence, an additive category is abelian if and only if it is di-exact (7.5.9). We further explain that a category is abelian if and only if it is both semiabelian and co-semiabelian, if and only if it is both additive and Barr-exact.

Organization of the sections in this chapter

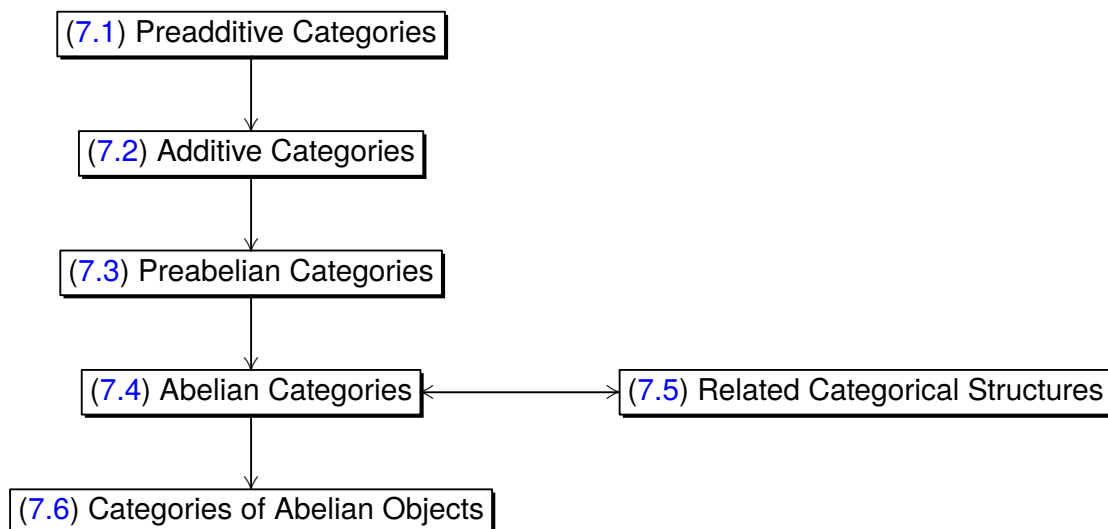

7.1 Preadditive Categories

By definition, a preadditive category is enriched in abelian groups and, hence, is found among categories which are enriched in commutative monoids; see Section 6.2. Thus, in a preadditive category \mathcal{X} , any finite product is also a coproduct, and any finite coproduct is also a product; see (6.2.12). This means that in a preadditive category, properties (P.2.a) and (P.1.a) are equivalent, and each implies the existence of a zero object.

Wording differently, for objects A and B in a preadditive category \mathcal{X} , their sum exists if and only if their product exists, and this happens if and only if the comparison map $\gamma_{A,B}: A + B \rightarrow A \times B$ is an isomorphism. By (6.2.11), this is equivalent to the existence of a commutative diagram

$$\begin{array}{ccc}
 A & \xrightarrow{\quad\quad\quad} & A \\
 & \searrow i_A & \nearrow p_A \\
 & X & \\
 & \nearrow i_B & \searrow p_B \\
 B & \xrightarrow{\quad\quad\quad} & B
 \end{array} \tag{7.1.1}$$

in which (X, i_A, i_B) is a coproduct of A and B , and (X, p_A, p_B) is a product of A and B , while $p_B i_A = 0_{BA}$, and $p_A i_B = 0_{AB}$.

Moreover, one can recognize a biproduct via diagram (7.1.1), plus the condition that $i_A p_A + i_B p_B = 1_X$; i.e. one obtains a universal property via a criterion which makes no mention whatsoever of universality (!); see (7.1.2). It enables us to show that any binary (co-)product diagram admits an expansion to a biproduct diagram which, moreover, is unique; see (6.2.12).

In particular, an initial object or a terminal object in a preadditive category is automatically a zero-object; see (6.2.13). However, the preadditive categories are segregated into two classes, namely the ones with zero object and the ones without; see Exercise 7.1.6.

Via the additive inverse operation in the Hom-groups of a preadditive category \mathcal{X} we obtain a new criterion for when two morphisms $f, g: A \rightarrow B$ are equal: this happens if and only if $g - f = 0$. Taking advantage of this criterion, we obtain nice recognition criteria for detecting a monomorphism, respectively an epimorphism, as in (7.1.4).

7.1.2 Lemma

Recognizing a biproduct via Ab-enrichment

In a preadditive category diagram (7.1.1) describes X as a biproduct of A and B if and only if

$$p_B i_A = 0_{BA} \quad \text{and} \quad p_A i_B = 0_{AB} \quad \text{and} \quad i_A p_A + i_B p_B = 1_X.$$

Proof This is a special case of Lemma 6.2.11. □

7.1.3 Proposition

Biproduct from product or coproduct

For any two objects A and B in a preadditive category the following hold:

- (i) Any product cone $A \xleftarrow{p_A} X \xrightarrow{p_B} B$ admits an expansion to a biproduct diagram (7.1.1). Moreover, this expansion is unique.
- (ii) Any coproduct cocone $A \xrightarrow{i_A} X \xleftarrow{i_B} B$ admits an expansion to a biproduct diagram (7.1.1). Moreover, this expansion is unique. \diamond

7.1.4 Proposition

Recognizing mono/epimorphism in a preadditive category

In a preadditive category \mathcal{X} the following hold:

- (i) A morphism $f: A \rightarrow B$ in \mathcal{X} is a monomorphism if and only if for every $z: Z \rightarrow A$, $fz = 0$ implies $z = 0$.
- (ii) A morphism $f: A \rightarrow B$ in \mathcal{X} is an epimorphism if and only if for every $\omega: B \rightarrow Z$, $\omega f = 0$ implies $\omega = 0$.

Proof Suppose $fz = 0$ implies $z: Z \rightarrow A$. To see that f is a monomorphism, consider $u, v: Z \rightarrow A$ with $fu = fv$. Then $f(v - u) = 0$, implying that $v - u = 0$ and, hence, $u = v$. The proof of (ii) is similar. \square

Exercises

7.1.5 Exercise

Show that every category \mathcal{X} can be embedded into a preadditive category. Hint: Consider each Hom-set as a basis for a free abelian group.

7.1.6 Exercise

Preadditive categories not pointed

Show that a preadditive category need not have a zero object. Still, it has an underlying enrichment in Set_* .

7.2 Additive Categories

An *additive category* is a preadditive category which admits finite sums. So, it has a zero object because the sum over the empty category is an initial object, hence also a terminal object by (6.2.13). Further, via (6.2.12) the existence of finite sums implies that finite products as well as finite biproducts exist. Thus a category is additive if and only if its opposite is additive.

One feature an additive category has which need not be shared by a preadditive one is that the addition in Hom-sets is given by the diagram in Proposition 7.2.1.

An alternate perspective of additive categories follows from the development in Section 6.2. There we proved that a pointed category with binary sums and products is a linear category (6.2.9) if and only if it is enriched in commutative monoids; see (6.2.14). Thus a category is additive if and only if it is linear and its Hom-monoids are groups. As a consequence every object carries a canonical internal abelian group structure; see (6.1.5). — We use the tag **Add** to identify additive categories.

As in Theorem 6.1.5, addition in Hom-sets may be computed as follows:

7.2.1 Proposition

Hom-addition in an additive category - **Add**

In an additive category the sum of two morphisms $f, g: A \rightarrow B$ may be computed via this commutative diagram:

$$\begin{array}{ccc} A & \xrightarrow{f+g} & B \\ \Delta_A \downarrow & & \uparrow \nabla_B \\ A \oplus A & \xrightarrow{f \oplus g} & B \oplus B \end{array}$$

In other words, $f + g = \nabla_B \circ (f \oplus g) \circ \Delta_A$. ◇

Additive categories need not admit kernels or cokernels. The following result can help identify situations where they do exist. Observe how the presence of a zero object extends the scope of the criterion by which we identify monomorphisms and epimorphisms in a preadditive category (7.1.4):

7.2.2 Proposition

(Co-)equalizers in an additive category - **Add**

In an additive category two maps $f, g: A \rightarrow B$ admit a (co-)equalizer if and only if $g - f$ admits a (co-)kernel. When this happens, (co-)equalizers of f and g and (co-)kernels of $g - f$ agree. ◇

For the following result recall that a monomorphism is regular when it is the equalizer of a pair of maps.

7.2.3 Corollary **Regular monos and epis are normal - Add**

In an additive category, every regular epimorphism is a normal epimorphism, and every regular monomorphism is a normal monomorphism. ◇

7.2.4 Proposition **Recognizing mono/epi-morphisms in an additive category - Add**

In an additive category the following hold:

- (i) If $f: A \rightarrow B$ has a kernel, then f is a monomorphism if and only if $\ker(f) = (0 \rightarrow A)$.
- (ii) If $f: A \rightarrow B$ has a cokernel, then f is an epimorphism if and only if $\operatorname{coker}(f) = (B \rightarrow 0)$.

Proof (i) If f is a monomorphism, then (1.5.6) tells us that $K(f) = 0$. Conversely, if $u: Z \rightarrow A$ is such that $fu = 0$, then u factors uniquely through $K(f) = 0$. So $u = 0$ and f is a monomorphism by (7.1.4). — Dualizing, we verify (ii). □

7.2.5 Corollary **Hom-recognition of kernels - Add**

If $f: A \rightarrow B$ is a morphism in an additive category, then $\kappa: K \rightarrow A$ is a kernel for f if and only if, for each object U in \mathcal{X} , the induced sequence below is exact.

$$0 \longrightarrow \operatorname{Hom}_{\mathcal{X}}(U, K) \xrightarrow{\kappa_*} \operatorname{Hom}_{\mathcal{X}}(U, A) \xrightarrow{f_*} \operatorname{Hom}_{\mathcal{X}}(U, B) \quad \diamond$$

7.2.6 Corollary **Hom-recognition of cokernels - Add**

If $f: A \rightarrow B$ is a morphism in an additive category, then $\omega: B \rightarrow Q$ is a cokernel for f if and only if, for each object W in \mathcal{X} , the induced sequence below is exact.

$$0 \longrightarrow \operatorname{Hom}_{\mathcal{X}}(Q, W) \xrightarrow{\omega^*} \operatorname{Hom}_{\mathcal{X}}(B, W) \xrightarrow{f^*} \operatorname{Hom}_{\mathcal{X}}(A, W) \quad \diamond$$

7.2.7 Proposition **Pullback / pushout via exactness - Add**

In an additive category \mathcal{X} , given the diagram (C) below, construct the sequence on the right as indicated.

$$\begin{array}{ccc}
 A & \xrightarrow{a} & U \\
 b \downarrow & & \downarrow u \\
 V & \xrightarrow{v} & Z
 \end{array}
 \quad \text{(C)}
 \quad
 \begin{array}{ccc}
 A & \xrightarrow{(a,b)} & U \oplus V & \xrightarrow{\langle u, -v \rangle} & Z
 \end{array}$$

Then the following hold:

- (i) (C) commutes if and only if the composite $\langle u, -v \rangle \circ (a, b) = 0$.
- (ii) (C) is a pullback diagram if and only if $(a, b) = \ker(\langle u, -v \rangle)$.
- (iii) (C) is a pushout diagram if and only if $\langle u, -v \rangle = \text{coker}((a, b))$.
- (iv) (C) is both a pullback and a pushout diagram if and only if the sequence is short exact; see (1.9.1).

Proof (i) follows from $\langle u, -v \rangle \circ (a, b) = (ua) + (-v)b = ua - vb$; see (7.2.15) and (7.2.12). To see (ii), observe that, for any $r = (r_U, r_V): R \rightarrow U \oplus V$,

$$0 = \langle u, -v \rangle \circ (r_U, r_V) = (ur_U) - (vr_V) \quad \text{if and only if} \quad ur_U = vr_V$$

Thus the pullback property of diagram (C) corresponds to the kernel property of (a, b) . Statement (iii) follows from (ii) by duality, and (iv) combines (ii) and (iii). \square

7.2.8 Corollary

Pullbacks and monos, pushouts and epis - Add

For a commutative diagram (C) in additive category the following hold:

$$\begin{array}{ccc} A & \xrightarrow{a} & U \\ b \downarrow & (C) & \downarrow u \\ V & \xrightarrow{v} & Z \end{array}$$

- (i) If (C) is a pullback diagram then it preserves and reflects monomorphisms.
 - (ii) If (C) is a pushout diagram then it preserves and reflects epimorphisms.
- Proof** (i) We know from (1.5.8) that $K(u) \cong K(b)$. Thus, if one of these two maps is monic, then both kernels vanish, and so (7.2.4) both maps are monomorphisms. — The proof of (ii) is dual. \square

7.2.9 Related categorical properties

We saw in (7.2.3) that, in an additive category, normal and regular epimorphisms coincide. This property is a prominent feature of normal categories, see (3.2.5). So, we may ask whether additive categories normal. The answer is ‘no’ for two reasons. Firstly, an additive category need not admit finite limits nor colimits. Second, pullbacks need not preserve normal epimorphisms.

The key difference between normal categories and homological ones is the validity of the (KSG)-condition; see (4.1.1). Perhaps surprisingly, all additive categories satisfy it.

7.2.10 Proposition

Additive categories and the (KSG)-condition - Add

In every additive category the (KSG)-condition holds.

Proof Consider a map p , sectioned by s , and a kernel $\kappa = \ker(p)$.

$$K \xrightarrow{\kappa} X \begin{array}{c} \xleftarrow{s} \\ \xrightarrow{p} \end{array} Y$$

Assume $m: M \rightarrow X$ is a monomorphism through which κ and s factor as $\lambda: K \rightarrow M$ and $t: Y \rightarrow M$, respectively; that is $m \circ \lambda = \kappa$ and $m \circ t = s$. We notice that $p \circ (1_X - s \circ p) = 0$. Thus there exists $q: X \rightarrow K$ unique with $\kappa \circ q = 1_X - s \circ p$. Therefore:

$$1_X = \kappa \circ q + s \circ p = m \circ \lambda \circ q + m \circ t \circ p = m \circ (\lambda \circ q + t \circ p)$$

This means that the monomorphism m is also an absolute epimorphism, hence an isomorphism by (A.2.10). \square

Exercises

7.2.11 Exercise

(Co-)equalizers in an additive category

Prove (7.2.2): In an additive category two morphisms $f, g: A \rightarrow B$ admit a (co-)equalizer if and only if $g - f: A \rightarrow B$ admits a (co-)kernel.

7.2.12 Exercise

Additive inverse operation and composition in Hom-groups

Given composable maps $A \xrightarrow{f} B \xrightarrow{g} C$ in an additive category show that

$$g \circ (-f) = -(g \circ f) = (-g) \circ f$$

7.2.13 Exercise

Hom-addition in an additive category

For morphisms $f, g: A \rightarrow B$ in an additive category show that $f + g = \nabla_B \circ (f \oplus g) \circ \Delta_A$; see (7.2.1).

7.2.14 Exercise

Alternate description of Hom-addition

For morphisms $f, g: A \rightarrow B$ in an additive category show that $\nabla_B \circ (f, g) = f + g = \langle f, g \rangle \circ \Delta_A$.

7.2.15 Exercise

Addition of composites

In an additive category, consider morphisms

$$u: A \rightarrow B, \quad v: A \rightarrow C \quad \text{and} \quad f: B \rightarrow D, \quad g: C \rightarrow D$$

Show that $(fu) + (gv) = \langle f, g \rangle \circ (u, v)$.

7.3 Preabelian Categories

By definition (Ab.3), a category is preabelian if it is enriched in abelian groups, admits finite sums, and has kernels and cokernels. With (7.2.2) we conclude that it is finitely bicomplete.

Equivalently, a category is preabelian if and only if it is additive and z-exact. Thus every morphism admits a normal mono factorization and a normal epi factorization. So, the notion of (short) exact sequence may be adopted from Section 1.9.

Here is how we can recognize preabelian categories among preadditive categories:

7.3.1 Proposition Recognizing a preabelian category among preadditive ones

For a preadditive category \mathcal{X} , the following conditions are equivalent:

- (I) \mathcal{X} is preabelian;
- (II) \mathcal{X} has a zero object and is finitely bicomplete;
- (III) \mathcal{X} has a zero object and admits arbitrary pullbacks and pushouts.

Proof (II) implies (I), (III) follows from the definitions. To see that (I) implies (II), recall the general fact that a category with finite sums and coequalizers is finitely cocomplete. In the case at hand, a preabelian category has finite products and coproducts. Further, it admit (co)equalizers via Proposition 7.2.2. - Similar reasoning shows that (III) implies (II). \square

7.3.2 Proposition Recognizing mono/epi-morphisms in a preabelian category

In a preabelian category \mathcal{X} , a morphism f has the following properties:

- (i) f is a monomorphism if and only if $\ker(f) = (0 \rightarrow A)$.
- (ii) f is an epimorphism if and only if $\operatorname{coker}(f) = (B \rightarrow 0)$.

Proof In the preabelian category \mathcal{X} , $\ker(f)$ exists. So, (i) follows from (7.2.4). Dual reasoning proves (ii). \square

7.3.3 Related categorical structures

We know already that an additive category satisfies the (KSG)-condition. Thus, a preabelian category is protomodular (4.10.8). Noting that additive and preabelian categories are self-dual notions, we conclude that additive categories also satisfy the co(KSG)-condition, and that preabelian categories are also coprotomodular.

The following result provides a partial converse in the context of homological (4.1) linear categories:

7.3.4 Theorem **Recognizing preabelian categories among homological ones - H**
 A homological satisfying any of the conditions below is preabelian.

- (i) \mathcal{X} is enriched in the category Mag of unitary magmas.
- (ii) \mathcal{X} is linear.

Proof (i) If \mathcal{X} is enriched in Mag , then every object admits a unitary magma structure by (6.1.5.i). Thus every object is an internal abelian group by (4.8.2). With (6.1.5.iii) we see that \mathcal{X} is enriched in Ab . So, \mathcal{X} is preadditive and finitely bicomplete. It is preabelian by (7.3.1).

(ii) follows from (i) because every linear category is enriched in the category CMon of commutative monoids and, hence, in Mag . □

Exercises

7.3.5 Exercise **Split extension in a preabelian category - recognize**

In a preabelian category, consider a short exact sequence $K \twoheadrightarrow X \twoheadrightarrow Y$. Prove that if either $K \twoheadrightarrow X$ is a retractable monomorphism or if $X \twoheadrightarrow Y$ is a sectionable epimorphism, then $X \cong K \oplus Y$. In either case, there is an isomorphism of short exact sequences

$$\begin{array}{ccccc}
 K & \twoheadrightarrow & X & \twoheadrightarrow & Y \\
 \parallel & & \downarrow \cong & & \parallel \\
 K & \twoheadrightarrow & K \oplus Y & \twoheadrightarrow & Y \\
 & (1_K, 0) & & p_{r_Y} &
 \end{array}$$

7.4 Abelian Categories

Building on previous sections, we present a view of abelian categories. In the process, we take advantage of the relationship with homological and semiabelian categories. We refer the reader to [43, 33, 34, 83, 2] for a self-contained development of the foundations of abelian categories.

7.4.1 Definition

Abelian category

A preabelian category \mathcal{X} is *abelian* if every monomorphism is a kernel (condition (P.5)) and every epimorphism is a cokernel (condition (P.6)).

7.4.2 Lemma

Pullback of normal epi is pushout - Ab

In an abelian category, any pullback of a normal epimorphism is also a pushout; any pushout of a normal monomorphism is also a pullback.

Proof We consider a commutative diagram (C) as in (7.2.8). If (C) is a pullback and u is a normal epimorphism, then the associated sequence $0 \rightarrow A \rightarrow U \oplus V \rightarrow Z \rightarrow 0$ is short exact, by item (ii) in (1.1.13) combined with the hypothesis (P.6) that all epimorphisms are normal. It follows that (C) is both a pullback and a pushout diagram. The second statement follows by duality. \square

7.4.3 Proposition

Pullback-stability of normal epimorphisms - Ab

In an abelian category, normal epimorphisms are pullback-stable, and normal monomorphisms are pushout-stable: properties (P.4) and (P.3) hold.

Proof We consider a commutative diagram (C) as in (7.2.8). If u is a normal epimorphism, then (1.6.3) tells us that $Q(b) = Q(u) = 0$. Thus b is an epimorphism by (7.3.2), and a normal epimorphism by the assumption (P.6) that all epimorphisms are normal. The second statement follows by duality. \square

7.4.4 Theorem

Abelian implies homological - Ab

Any abelian category is homological and co-homological.

Proof The given category is pointed and bicomplete by (7.3.1). Condition (KSG) holds by (7.2.10), while (PNE) follows from (7.4.3). \square

7.4.5 Theorem

Every map is normal - Ab

In an abelian category every morphism is a normal map.

Proof We know that any abelian category is homological by (7.4.4). So given $f: A \rightarrow B$, we may consider its image factorization $f = me$, where m is a monomorphism and e is a normal epimorphism. Now by (P.5), m is normal as well. \square

7.4.6 Theorem

Abelian implies semiabelian - Ab

Any abelian category is semiabelian and co-semiabelian.

Proof The given category is homological by Theorem 7.4.4. Since every map in \mathcal{X} is normal (7.4.5), the (ANN)-condition is satisfied. So, \mathcal{X} is semiabelian (5.1.1). Further, \mathcal{X} is co-semiabelian, because an abelian category is also co-abelian. \square

Exercises

7.4.7 Exercise

Isomorphism recognition in abelian categories

In an abelian category show that a morphism $f: A \rightarrow B$ is an isomorphism if and only if it is an epimorphism and a monomorphism.

7.4.8 Exercise

Formal difference in abelian categories

Recall the construction of the difference object $D(X)$ in normal categories (3.4.4), and the associated formal difference of maps $f, g: X \rightarrow Y$. In an abelian category \mathcal{X} show the following:

- (i) The difference object functor D is naturally equivalent to the identity functor on \mathcal{X} .
- (ii) Via the natural equivalence in (i), the formal difference $f - g$ agrees with the difference given by the abelian group enrichment of \mathcal{X} .

7.5 Related categorical structures

In this section, we elaborate on the relationship between abelian categories and the categorical structures we developed earlier, notably p-exact, homological, and semiabelian categories, as well as categories which are enriched in abelian groups. As a refinement, we insert the following intermediate concepts: *almost abelian categories* [78], *quasi-abelian categories* [84, 78, 80], and the corresponding one-sided notions.

7.5.1 Definition

Left almost abelian category

A preabelian category is *left almost abelian* or *left quasi-abelian* if pullbacks preserve normal epimorphisms; Property (P.4) holds.

Thus, a preabelian category is left almost abelian if it satisfies the (PNE)-condition. —
Dually:

7.5.2 Definition

Right almost abelian category

A preabelian category is *right almost abelian* or *right quasi-abelian* if pushouts preserve normal monomorphisms; Property (P.3) holds.

7.5.3 Definition

Almost abelian category

A preabelian category is *almost abelian* or *quasi-abelian* if it is both left and right almost abelian.

From (7.4.3), it follows immediately that every abelian category is almost abelian:

7.5.4 Lemma

Abelian implies almost abelian

Every abelian category is an almost abelian category. \diamond

7.5.5 Example

Examples of almost abelian categories

The categories of topological abelian groups, locally compact abelian groups, topological vector spaces, normed spaces, Banach spaces, locally convex spaces and Fréchet spaces are almost abelian—see [78].

7.5.6 Theorem

Homological category vs. left almost abelian category

A preabelian category is left almost abelian if and only if it is homological. Further, a homological category is left almost abelian if and only if it is additive.

Proof By definition, a homological category satisfies the (PNE)-condition. Therefore, any homological preabelian category is left almost abelian.

To see that a left almost abelian category is homological, recall first that any preabelian category has a zero object and is finitely bicomplete, see Proposition 7.3.1. By definition of a left almost abelian category, the (PNE)-condition is satisfied. The (KSG)-condition holds in any additive category by Proposition 7.2.10 and, hence, in any preabelian category.

Now consider a homological category. If it is left almost abelian, then it is additive by definition. If it is additive, then it is preabelian because it is pointed and finitely bicomplete. Finally, pullbacks preserve normal epimorphisms by the (PNE)-condition of homological categories. So, it is left almost abelian. \square

By combining (7.5.6) and its dual, we see that an almost abelian category is both homological and co-homological. A result due to G. Janelidze [77] shows that the converse also holds.

7.5.7 Theorem

Almost abelian = homological + co-homological

A category is almost abelian if and only if it is both homological and co-homological.

Proof By (7.5.6), it suffices to prove that a category \mathcal{X} which is both homological and

co-homological is additive. Given two objects A and B , consider this diagram in \mathcal{X} :

$$A \begin{array}{c} \xrightarrow{i_A} \\ \xleftarrow{\langle 1_A, 0 \rangle} \end{array} A + B \begin{array}{c} \xrightarrow{\langle 0, 1_B \rangle} \\ \xleftarrow{i_B} \end{array} B$$

In the homological \mathcal{X}^{op} , it is the product decomposition diagram from (4.2.9). Thus the diagram consists of two short exact sequences. The property of being short exact is self dual. So, the diagram, as constructed in \mathcal{X}^{op} consists of two short exact sequences. Via (4.2.9), the middle object is the product of the end objects. So, the diagram above is a biproduct diagram. This means that the category \mathcal{X} is linear and \mathcal{X} homological as well. So, it is preabelian by (7.3.4). Since it is homological and co-homological, it is almost abelian. \square

We now consider characterizations of abelianness in relation to additive, p-exact, homological, and semiabelian categories.

7.5.8 Theorem

Abelian is additive plus p-exact

A category is abelian if and only if it is p-exact and additive.

Proof An abelian category is additive by definition. Maps are normal by Theorem 7.4.5. So, an abelian category is also p-exact.

Conversely, given an additive p-exact category, we know that (P.5) and (P.6) hold. So, it has kernels and cokernels by or by Exercise 2.7.8. So, it is abelian. \square

7.5.9 Theorem

Abelian is additive plus di-exact

A category is abelian if and only if it is di-exact and additive.

Proof An abelian category is additive by definition. It is di-exact by (7.4.5).

Conversely, in a pointed additive category, a morphism $f: X \rightarrow Y$ may be factored as the normal monomorphism $(1_X, 0): X \rightarrow X \oplus Y$ followed by the normal epimorphism $\langle f, 1_Y \rangle: X \oplus Y \rightarrow Y$. So, f is normal by the (ANN)-condition. Hence the given category is both p-exact and additive, hence abelian by (7.5.8). \square

7.5.10 Corollary

Abelian is additive plus semiabelian

A category is abelian if and only if it is semiabelian and additive.

Proof If a category \mathcal{X} is abelian, then it is additive by definition. It is semiabelian by (7.4.6). Conversely, if \mathcal{X} is semiabelian and additive, then it is di-exact and additive, hence abelian by (7.5.9). \square

7.5.11 Corollary

Abelian is semiabelian plus co-semiabelian

A category is abelian if and only if it is semiabelian and co-semiabelian.

Proof If a category \mathcal{X} is abelian, then it is semiabelian and co-semiabelian by (7.4.6).

Conversely, if \mathcal{X} is semiabelian and co-semiabelian then it is almost abelian by (7.5.7). In particular, it is additive, so it is abelian by (7.5.10). \square

7.5.12 Theorem

Abelian is additive plus Barr-exact

A category is abelian if and only if it is Barr-exact and additive.

Proof By (7.5.10), a category is abelian if and only if semiabelian and additive. By (5.6.2), any semiabelian category is Barr-exact.

Conversely, by definition, any additive category \mathcal{X} is pointed with binary products and coproducts. Furthermore (7.2.10), (KSG) holds in \mathcal{X} . Barr-exactness adds finite completeness. Hence, being pointed, regular and protomodular (4.10.8), the category \mathcal{X} is BB-homological by (4.10.11). On the other hand, by (4.2.7) and (4.11.4), the Mal'tsev property holds for \mathcal{X} . So \mathcal{X} has all finite colimits (5.7.1). Hence \mathcal{X} is an additive homological category. Di-exactness follows from (5.6.5), and abelianness from (7.5.9). \square

This result is often called the *Tierney Equation* after Myles Tierney who discovered it.

7.5.13 Example

Almost abelian but not abelian

In [78, Corollary in Section 4], it is shown that a category is almost abelian if and only if it is the torsion or torsion-free class in an abelian category. For instance, the categories of torsion and torsion-free abelian groups are almost abelian categories which are not Barr-exact.

In view of (7.5.12), a variety of algebras is abelian if and only if it is an additive category. The following more precise analysis appears in [33]:

7.5.14 Example

Abelian varieties of algebras

A variety of algebras is an abelian category if and only if it is equivalent to a category of modules over a ring R . If $F(1)$ denotes the free object on a single generator, then R is the ring of endomorphisms $End(F(1))$ of $F(1)$. \diamond

Notes Palamodov and Raïkov semiabelian categories

In the literature, the term 'semiabelian category' is used to refer to at least three non-equivalent kinds of structure:

- Semiabelian categories in the sense of Janelidze–Márki–Tholen [51] are discussed here in Chapter 5.

- Semiabelian categories in the sense of Raïkov [76] are the same as the almost abelian categories of Definition 7.5.3.
- Semiabelian categories in the sense of Palamodov [71], see also [72, 44, 78]. The full definition is given below; see (7.5.15). Any almost abelian category is Palamodov-semiabelian (7.5.16). But, as explained in [79], the converse does not hold. For example, the category of bornological spaces is Palamodov-semiabelian but not almost abelian [5].

For context for the definition of Palamodov-semiabelian categories, recall that, in a z-exact category, every morphism f admits a normal epi factorization and a normal mono factorization whose factoring objects are uniquely related by a unique comparison map

$$EM(f): Q(\ker(f)) \rightarrow K(\operatorname{coker}(f))$$

7.5.15 Definition

Palamodov-semiabelian category

A preabelian category is *Palamodov-semiabelian* if for every morphism $f: X \rightarrow Y$, the comparison map $EM(f)$ is simultaneously a monomorphism and an epimorphism.

This is clearly equivalent to asking that every morphism in the given category has both an image and a coimage factorization (see (1.8.8)). Since homological categories have images, while co-homological categories have coimages, any almost abelian category is Palamodov-semiabelian by (7.5.7).

7.5.16 Theorem

(Almost) abelian implies Palamodov-semiabelian

Any (almost) abelian category is Palamodov-semiabelian. \diamond

7.5.17 Proposition

Images vs. pullback of normal epi is epi

In a preabelian category, pullbacks send normal epimorphisms to epimorphisms if and only if every morphism admits an image factorization.

Proof First suppose that pullbacks send normal epimorphisms to epimorphisms. We show that any morphism f admits a decomposition $f = ve$, with e a normal epimorphism and v a monomorphism. Consider its normal epi factorization as in this diagram:

$$\begin{array}{ccccc}
 K(f) & \xrightarrow{k} & X & \xrightarrow{f} & Y \\
 \bar{e} \downarrow & \circlearrowleft & \downarrow e & & \parallel \\
 K(v) & \xrightarrow{l} & Q(k) & \xrightarrow{v} & Y
 \end{array}$$

We know that $l\bar{e} = ek = 0$. So, $K(v) = 0$ because \bar{e} is epic, as a pullback (1.6.2) of the normal epimorphism e . Hence v is monic by (7.1.4.i).

For the converse, we first prove that when image factorizations exist, any pullback of a normal epimorphism is also a pushout (cf. (7.4.2)). Consider a diagram (C) such as in (7.2.7) and assume that u is a normal epimorphism. Let $r: P \rightarrow Z$ be the induced comparison from the pushout of a and b to Z . Taking f to be $\langle u, -v \rangle$, we have that $EM(f)$ and r coincide by points (ii) and (iii) in (7.2.7) combined. Now $r = EM(f)$ is a monomorphism by hypothesis, though which the strong epimorphism u factors. Hence r is an isomorphism, so that (C) is a pushout.

Now it follows from (1.6.3) that a pullback of any normal epimorphism has a trivial cokernel, so that by (7.3.2) it is an epimorphism. \square

We see that Palamodov-semiabelian categories may be characterized in terms of a weak form of the conditions (P.3) and (P.4).

7.5.18 Corollary

Characterization of Palamodov-semiabelian categories

A preabelian category is Palamodov-semiabelian if and only if pushouts send normal monos to monos and pullbacks send normal epis to epis. \diamond

Exercises

7.5.19 Exercise

Alternate verification of (KSG) in an abelian category

Show that any abelian category satisfies (KSG) by showing that $Q(m) = 0$ in the diagram in the proof of (7.2.10); i.e. m is a monomorphism and an epimorphism.

7.5.20 Exercise

Normality check in pointed additive context

Check the claim of normality for the two morphisms in (7.5.9).

7.6 Categories of abelian objects

When considering abelian group objects in a finitely complete category \mathcal{X} , we encounter two quite different scenarios:

- ▶ Category \mathcal{X} is such that an object may carry two or more distinct abelian group structures. This happens, for example in the category Set of sets. The category of all abelian group objects in Set is the category of abelian groups. In general, the collection of all internal abelian group objects in \mathcal{X} is an additive category; see (7.6.1).
- ▶ Category \mathcal{X} is such that if an object X carries an abelian group structure, then this structure is unique and is a property of X . In this case the collection of all abelian group objects in \mathcal{X} determines a full and replete subcategory of \mathcal{X} which we call the *abelian core* $ab(\mathcal{X})$ of \mathcal{X} . This happens, for example in every homological category, where the abelian core consists of all abelian objects. Below, we develop basic properties of $ab(\mathcal{X})$.

7.6.1 Proposition

Abelian group objects form additive category

Given a category \mathcal{X} with finite products, the collection of abelian group objects $\text{Ab}(\mathcal{X})$ in \mathcal{X} forms an additive category.

Proof With Theorem 6.1.5 we see that $\text{Ab}(\mathcal{X})$ is enriched in Ab . With (6.2.12), we see that \mathcal{X} has finite biproducts, hence is an additive category. \square

In the remainder of this section we consider abelian group objects in a homological or in a semiabelian category \mathcal{X} . From Section 4.8 we already know that, (a) whenever an object X in \mathcal{X} admits the structure of an internal unitary magma, then this structure is unique, and (b) this magma structure on X is commutative, associative, and associated with a unique inverse operation, so that it is actually an internal abelian group object. In (4.8) we called such X an *abelian object*.

7.6.2 Theorem

Abelian objects in a homological category - H

In a homological category \mathcal{X} the abelian objects form a left almost abelian category $ab(\mathcal{X})$. It is full and replete in \mathcal{X} , and is closed under subobjects and quotients.

Proof We begin by showing that $ab(\mathcal{X})$ is full in \mathcal{X} . So, let (X, μ) and (Y, ν) be abelian group objects, and let $f: X \rightarrow Y$ be a morphism in \mathcal{X} . To see that f is also a morphism $(X, \mu) \rightarrow (Y, \nu)$ consider the diagram below.

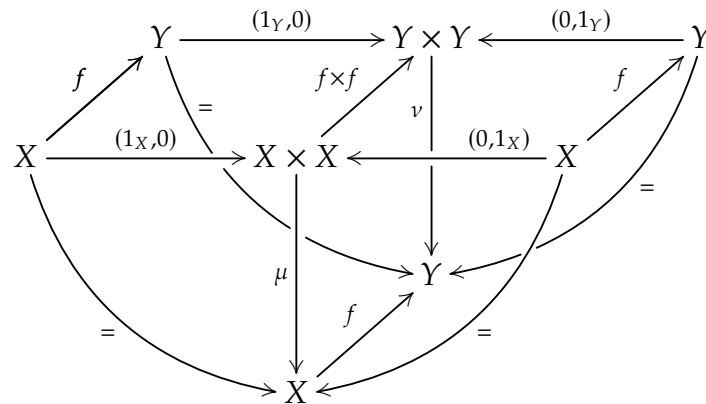

The top squares and the front/back facing triangles commute. The identity $\nu \circ (f \times f) = f \mu$ follows via checking on the factors of $X \times X$. This means that f is a morphism of internal abelian group objects; i.e. $ab(\mathcal{X})$ is full in \mathcal{X} .

That $ab(\mathcal{X})$ is closed under subobjects follows from (4.7.2.ii). It remains to show that $ab(\mathcal{X})$ is closed under quotients. Given (A, μ) and a normal epimorphism $q: A \rightarrow Q$ in \mathcal{X} , let $\kappa: K \rightarrow A$ be the kernel of q . By (3.2.8), we obtain this diagram of short exact sequences

$$\begin{array}{ccccc}
 K \times K & \xrightarrow{\kappa \times \kappa} & A \times A & \xrightarrow{q \times q} & Q \times Q \\
 \sigma \downarrow & & \downarrow \mu & & \downarrow \nu \\
 K & \xrightarrow{\kappa} & A & \xrightarrow{q} & Q
 \end{array}$$

The left hand square commutes because the subobject κ of A belongs to the full subcategory $ab(\mathcal{X})$. Then $q\mu(\kappa \times \kappa) = 0$. Thus there is a map $\nu: q \times q \rightarrow Q$ unique with $q\mu = \nu(q \times q)$.

By (4.7.2.iii) $q\mu$ is the multiplication of q by q . Using $q = 1_Q \circ q$ in (4.7.8) shows that v is the multiplication of 1_Q by itself.

It remains to show that $ab(\mathcal{X})$ is finitely bicomplete. Finite products exist by (4.7.2.iv), and these are biproducts by (7.1.3). We conclude that $ab(\mathcal{X})$ has coequalizers because it is closed under quotients. So $ab(\mathcal{X})$ is finitely cocomplete. Further $ab(\mathcal{X})$ has equalizers: If $f: A \rightarrow B$ is a morphism in $ab(\mathcal{X})$, then its kernel $\kappa: K \rightarrow A$ in \mathcal{X} is a subobject of A , hence belongs to $ab(\mathcal{X})$. The defining property of 'kernel' tells us that κ is the kernel of f in $ab(\mathcal{X})$ as well. So, $ab(\mathcal{X})$ is finitely complete.

Pullbacks and normal epimorphisms in $ab(\mathcal{X})$ are as in \mathcal{X} . We know that, in \mathcal{X} , pullbacks preserve normal epimorphisms. So, this property also holds in $ab(\mathcal{X})$. Hence $ab(\mathcal{X})$ satisfies condition (P.4). So, it is left almost abelian. \square

7.6.3 Corollary

Recognizing (left almost) abelian categories - H

For a homological category \mathcal{X} the following hold:

- (i) \mathcal{X} is left almost abelian if and only if the diagonal map $\Delta_X: X \rightarrow X \times X$ is a normal monomorphism for every object X ;
- (ii) \mathcal{X} is abelian if and only if every monomorphism is normal.

Proof (i) By Proposition 4.8.7, the diagonal Δ_X is normal precisely when X is an internal abelian group object of \mathcal{X} . So $\mathcal{X} = ab(\mathcal{X})$ when this is true for all objects of \mathcal{X} . By Theorem 7.6.2, this is equivalent to \mathcal{X} being left almost abelian.

(ii) If every monomorphism is normal, then \mathcal{X} is left almost abelian by (i), and we only need to show that every epimorphism is normal. Given an epimorphism $f: A \rightarrow B$ in \mathcal{X} , consider its image factorization:

$$A \xrightarrow{q} I \xrightarrow{m} B$$

(Note: In the original image, there is a curved arrow labeled 'f' from A to B above the straight arrows.)

We just saw that the monomorphism m is normal. It is an epimorphism by (1.1.13.ii), hence an isomorphism by (1.5.7.iii). So, f is normal by (1.5.9.ii). - This completes the proof. \square

7.6.4 Theorem

Internal abelian group objects in a semiabelian category - SA

In a semiabelian category \mathcal{X} , the abelian objects form an abelian category $ab(\mathcal{X})$. It is full and replete in \mathcal{X} , and is closed under subobjects and quotients.

Proof The category \mathcal{X} is homological, so that by Corollary 7.6.3, we only need to show that all monomorphisms in the left almost abelian category $ab(\mathcal{X})$ are normal. So, consider

a monomorphism $m: M \rightarrow X$. By (4.8.6), the subdiagonal map $(1_M, m): M \rightarrow M \times X$ is a normal monomorphism in \mathcal{X} . Then via the (ANN)-condition, the commutative diagram

$$\begin{array}{ccc} M & \xrightarrow{(1_M, m)} & M \times X \\ \parallel & & \downarrow pr_X \\ M & \xrightarrow{m} & X \end{array}$$

in \mathcal{X} shows that m is a normal monomorphism in \mathcal{X} , so that it is a normal monomorphism in $ab(\mathcal{X})$ as well. \square

7.6.5 Example

Examples of abelian cores

From (4.7.13) we learn that a group is an abelian object in Grp if and only if it is an abelian group. Hence $ab(\text{Grp}) = \text{Ab}$.

Let R be a ring and let Lie_R be the semiabelian variety of Lie algebras over R . Example 4.7.14 explains that a Lie algebra is abelian if and only if its bracket is trivial. Thus we find the category $\text{Mod}(R)$ of R -modules (equipped with a zero multiplication) as $ab(\text{Lie}_R)$.

The case of associative algebras over a ring R is very similar to the case of Lie algebras. An object is abelian if and only if the algebra multiplication is zero, so that we find the category of R -modules.

A loop which carries an internal unitary magma structure is the same thing as a unitary magma that carries an abelian group structure; in other words, a loop admits such structure if and only if it is an abelian group. Hence a loop is an abelian object in Loop if and only if its multiplication is at the same time associative and commutative. In other words, $ab(\text{Loop}) = \text{Ab}$.

Since any subobject of an abelian object in a semiabelian category is again an abelian object, abelianness of the full subcategory of all abelian objects tells us that such a subobject is automatically normal, which gives us the next result. We chose to add a direct proof to this argument, because it is interesting in its own right.

7.6.6 Corollary

Subobject of abelian object is normal - SA

In a semiabelian category, any subobject of an abelian object is a normal subobject.

Proof Let $m: M \rightarrow X$ represent a subobject of an abelian object X . We denote its abelian group structure (X, μ, i) and write $t = \mu \circ (1_X \times i): X \times X \rightarrow X$. Pulling back t

along m , we find a commutative square, which we can complete to the diagram below.

$$\begin{array}{ccccc}
 M & \xrightarrow{\quad k \quad} & R & \xrightarrow{\quad \bar{t} \quad} & M \\
 \downarrow m & & \downarrow r & \circlearrowleft & \downarrow m \\
 X & \xrightarrow{\quad (1_X, 0) \quad} & X \times X & \xrightarrow{\quad t \quad} & X
 \end{array}$$

The map k comes via the universal property of the pullback. But then the left hand square is a pullback as well by (A.1.6). Then k is a normal monomorphism because so is $(1_X, 0)$.

By definition, $t \circ \Delta_X = 0$. So, the universal property of the pullback yields the morphism $(\Delta_X, 0): X \rightarrow R$, unique with $r(\Delta_X, 0) = \Delta_X$ and $\bar{t}(\Delta_X, 0) = 0$. Setting $r_1 = pr_1 \circ r$ we see that

$$r_1(\Delta_X, 0) = pr_1 r(\Delta_X, 0) = pr_1 \Delta_X = 1_X$$

This means that r_1 is a split epimorphism, hence a normal epimorphism. Further,

$$r_1 k = pr_1 r k = pr_1 (1_X m) = m = m 1_M$$

With the (ANN)-condition we conclude that m is a normal monomorphism. This was to be shown. \square

Part II
Appendix

Appendix A

Background from Category Theory

We assume that the reader is familiar with the concepts of category and functor, and has had contact with examples of categories such as the category Set of sets, the category Grp of groups, etc. Further we assume some basic familiarity with the concepts of limit and colimit. For references on categories, we recommend [63], [1], and [7, 8].

Here we present more specialized categorical concepts which will be used extensively. Also, we introduce notational conventions.

A.1 Limits and Colimits

A category J is called *small* if its class of morphisms is a proper set. This implies that the object set of J is proper. Similarly, J is *finite* if its class of morphisms and, hence, the class of its objects is a finite set. Thus, every finite category is small.

A.1.1 Limits and colimits

Let \mathcal{X} be an arbitrary category, and let J be a small category. The limit of a functor $F: J \rightarrow \mathcal{X}$ is given by a *limit cone* $\lambda: \lim_J(F) \Rightarrow F$ which we may visualize as the blue part of this commutative diagram in \mathcal{X} :

$$\begin{array}{ccc} A & \xrightarrow{\quad a \quad} & \lim_J(F) \\ \alpha_j \downarrow & \swarrow \alpha_k & \downarrow \lambda_k \\ \dots & F(j) \xrightarrow{F(u)} F(k) & \dots \end{array}$$

The limit cone λ is terminal among all cones $\alpha: A \Rightarrow F$: Every such cone factors uniquely through $\lim_J(F)$. This implies that the morphisms λ_j of the limit cone are jointly monomorphic.

Dually, the colimit of F is given by a cocone $\gamma: F \Rightarrow \text{colim}^J(F)$ which is initial among all cocones $F \Rightarrow Z$. Consequently, the family of morphisms γ_j of the colimit cocone is jointly epimorphic.

We say that \mathcal{X} is (finitely) complete if all (finite) limits in \mathcal{X} exist. Similarly, \mathcal{X} is (finitely) cocomplete if all (finite) colimits in \mathcal{X} exist. A (finitely) bicomplete category is (finitely) complete and (finitely) cocomplete.

A.1.2 Functoriality of limits and colimits

While (co)limits are unique up to unique isomorphism, it is convenient to assume that functorial (co)limits are available in the following sense.

A.1.3 Definition

Functorial (co)limits*

Fix a small category J , and consider the embedding $\Phi: \mathcal{X} \rightarrow \mathcal{X}^J$, which sends an object X in \mathcal{X} to the constant functor $J \rightarrow \mathcal{X}$ with value X . Functorial limits over J in \mathcal{X} are given by a right adjoint $\lim_J: \mathcal{X}^J \rightarrow \mathcal{X}$ of Φ , and functorial colimits over J in \mathcal{X} are given by a left adjoint $\text{colim}^J: \mathcal{X}^J \rightarrow \mathcal{X}$ of Φ . A (co)limit is called *finite* when J is a finite category.

A.1.4 Sum and product*

If J is a discrete category (every morphism is an identity) then a functor $F: J \rightarrow \mathcal{X}$ has

- ▶ as its limit: $\lim_J(F)$ the product $\prod_{j \in J} F(j)$;
- ▶ as its colimit: $\text{colim}^J(F)$ the coproduct $\coprod_{j \in J} F(j)$.

If $J = \{0, 1\}$ contains two objects only, it is standard to write $F(0) \times F(1)$ for the limit of F ; i.e. the product of $F(0)$ by $F(1)$. A morphism from an object A to this product is then uniquely determined by two maps $f: A \rightarrow F(0)$ and $g: A \rightarrow F(1)$. The associated map into the product is denoted

$$\langle f, g \rangle: A \rightarrow F(0) \times F(1)$$

Dually, for $F: \{0, 1\} \rightarrow \mathcal{X}$, we write $F(0) + F(1)$ for the colimit of F ; i.e. the sum of $F(0)$ and $F(1)$. A morphism from $F(0) + F(1)$ to an object Z is uniquely determined by two maps $u: F(0) \rightarrow Z$ and $v: F(1) \rightarrow Z$. The associated map out of the sum is denoted

$$\langle u, v \rangle: F(0) + F(1) \rightarrow Z$$

A.1.5 Pullbacks*

Choosing J to be the category $a \rightarrow t \leftarrow b$, yields the category of diagrams in \mathcal{X} of the shape $A \xrightarrow{f} T \xleftarrow{g} B$. 'Pullback' is the name for the limit of such a diagram. We state its universal property in terms of this diagram:

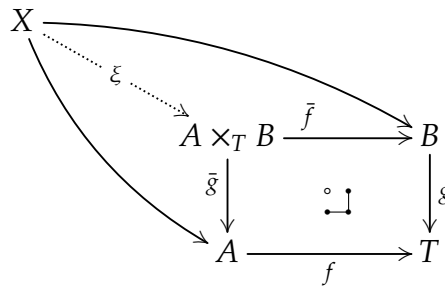

The universal property the pullback square asserts that any commutative diagram of solid arrows, as shown above, has a unique filler ξ which renders the entire diagram commutative.

The morphism \bar{g} depends functorially on the diagram $A \xrightarrow{f} T \xleftarrow{g} B$ and is said to be the *base change* of g along f . Similarly, \bar{f} is said to be the base change of f along g . Base change preserves monomorphisms and isomorphisms, (A.1.12), but fails to preserve epimorphisms in general. On the other hand, in many categories, such as Set, Grp, module categories etc., base change does preserve epimorphisms.

A.1.6 Proposition

Pullbacks and concatenated squares

In an arbitrary category consider the commutative diagram below.

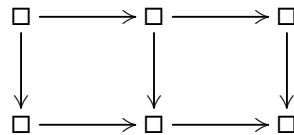

- (i) *Pullback composition* If both squares are pullbacks, so is the outer rectangle.
- (ii) *Pullback cancellation* If the right hand square and the outer rectangle are pullbacks, then the left hand square is a pullback as well. ◇

A frequently used pullback construction is that of a kernel pair of a morphism:

A.1.7 Definition

Kernel pair

In a category with pullbacks, the *kernel pair* $KP(f) = (X \times_Y X, pr_1, pr_2)$ of a morphism $f: X \rightarrow Y$ is given by the pullback diagram below.

$$\begin{array}{ccc}
 X \times_Y X & \xrightarrow{pr_1} & X \\
 pr_2 \downarrow & \circlearrowleft & \downarrow f \\
 X & \xrightarrow{f} & Y
 \end{array}$$

We will sometimes abuse notation by writing $KP(f)$ for the object $X \times_Y X$.

The maps pr_1 and pr_2 are jointly monomorphic. Moreover these maps have a common left inverse, namely the map Δ_X in the diagram below.

$$\begin{array}{ccc}
 X & & X \\
 \Delta_X \swarrow & & \downarrow f \\
 X \times_Y X & \xrightarrow{pr_1} & X \\
 pr_2 \downarrow & \circlearrowleft & \downarrow f \\
 X & \xrightarrow{f} & Y
 \end{array}$$

Via the kernel pair construction we characterize monomorphisms by a limit property.

A.1.8 Proposition

Kernel pair and monomorphism

In the kernel pair of a map $f: X \rightarrow Y$, the structure maps pr_1 and pr_2 have a unique common section $\Delta_X: X \rightarrow X \times_Y X$. Moreover, the following conditions are equivalent.

- (i) f is a monomorphism.
- (ii) pr_1 is a monomorphism.
- (iii) pr_1 is an isomorphism.
- (iv) Δ_X is an isomorphism.
- (v) Δ_X is an epimorphism.
- (vi) $pr_1 = pr_2$

◇

A.1.9 Pushouts

The notion of pushout is dual to that of a pullback, and the notion of cobase change is dual to that of base change. Thus a pushout diagram in a category \mathcal{X} is a commutative

square which has this universal property:

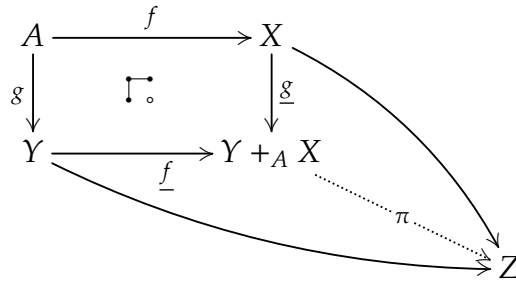

For every commutative diagram of solid arrows, there exists a unique filler π which renders the entire diagram commutative. - We refer to the morphism \underline{g} as the *cobase change* of g along f .

A.1.10 Proposition

Pushouts and concatenated squares

In an arbitrary category consider the commutative diagram below.

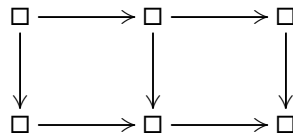

- (i) *Pushout composition* If both squares are pushouts, so is the outer rectangle.
- (ii) *Pushout cancellation* If the left hand square and the outer rectangle are pushouts, then the right hand square is a pushout as well. \diamond

Notes

Existence, preservation, reflection of finite (co)limits Sufficient conditions for the existence of finite (co-)limits are given in [63, Section V.2]. Further, any functor $F: \mathcal{X} \rightarrow \text{Set}$ with a left adjoint preserves all limits in \mathcal{X} . If the adjunction is monadic, then F reflects limits. In fact, it actually *creates* them in the sense of [1, Theorem 23.11].

Functorial (co)limits It may be advantageous to work with (co)limits which respond functorially to a change of the template category J . An appropriate context for this discussion is: The operation which sends a small category J to the functor category \mathcal{X}^J is a functor $\Phi: \text{Cat}^{op} \rightarrow \text{CAT}$, with Cat the category of small categories, and CAT the huge category of locally small categories. The associated Grothendieck category $\mathcal{G}r^\circ(\Phi)$ contains $\mathcal{X} \cong \mathcal{X}^{[0]}$ as a full subcategory. Functorial colimits in \mathcal{X} are given by a left adjoint to the inclusion $\mathcal{X} \rightarrow \mathcal{G}r^\circ(\Phi)$.

Exercises

A.1.11 Exercise

Jointly monomorphic maps

In a complete category \mathcal{X} show the following:

- (i) If e is an epimorphism, respectively an isomorphism, show that ε is an epimorphism, respectively an isomorphism.
- (ii) In the category Set of sets, show that if e is injective, then so is ε .

A.1.15 Exercise

Cobase change resulting in isomorphism

In any category suppose $a: A \rightarrow B$ is the composite $A \xrightarrow{f} X \xrightarrow{g} B$. If f is an epimorphism, and the square below is a pushout, show that \hat{f} is an isomorphism.

$$\begin{array}{ccc}
 A & \xrightarrow{f} & X \\
 a \downarrow & \lrcorner \circ & \downarrow \hat{a} \\
 B & \xrightarrow{\hat{f}} & P
 \end{array}$$

A.1.16 Exercise

Pushouts and concatenated squares

Prove (A.1.10): A composite of pushout squares is a pushout square, and pushout cancellation.

A.1.17 Exercise

Constructing the intersection of subobjects using a pullback

In a category which admits pullbacks, let $m: M \rightarrow X$ and $n: N \rightarrow X$ represent subobjects of X . In the pullback diagram below, show that $m\bar{n} = n\bar{m}: P \rightarrow X$ represents $M \wedge N$ as a subobject of X .

$$\begin{array}{ccc}
 P & \xrightarrow{\bar{n}} & M \\
 \bar{m} \downarrow & \lrcorner \circ & \downarrow m \\
 N & \xrightarrow{n} & X
 \end{array}$$

A.1.18 Exercise

Isomorphic kernel pairs

[20, 2.16] In a category with pullbacks, suppose a morphism g fits into the diagram below:

$$\begin{array}{ccc}
 & & f \\
 X & \xrightarrow{\quad} & Y \\
 & \searrow s & \swarrow \\
 & & Z \\
 & \swarrow g & \searrow h
 \end{array}$$

If $fs = 1_Y$, show that the kernel pair of g is isomorphic to the kernel pair of f if and only if h is monic.

A.1.19 Exercise

Finite (co-)products from binary (co-)products

In an arbitrary category \mathcal{X} show the following:

- (i) If \mathcal{X} admits binary products, show that objects X_1, X_2, \dots, X_n admit a product.
- (ii) If \mathcal{X} admits binary coproducts, show that objects X_1, X_2, \dots, X_n admit a coproduct.
- (iii) If \mathcal{X} admits binary biproducts, show that objects X_1, X_2, \dots, X_n admit a biproduct.

- (iv) If the comparison map $X_1 + \cdots + X_n \rightarrow X_1 \times \cdots \times X_n$ is an isomorphism, show that the n -ary biproduct of X_1, \dots, X_n exists.

A.1.20 Exercise

In any category with binary products and pullbacks show the following. If $a: A \rightarrow X$ and $b: B \rightarrow X$ are arbitrary morphisms, then the universal objects in the pullback diagrams below are naturally isomorphic.

$$\begin{array}{ccc}
 P & \xrightarrow{(\alpha, \beta)} & A \times B \\
 p \downarrow & \circlearrowleft & \downarrow a \times b \\
 X & \xrightarrow{\Delta_X} & X \times X
 \end{array}
 \qquad
 \begin{array}{ccc}
 Q & \xrightarrow{\varphi} & B \\
 \psi \downarrow & \circlearrowleft & \downarrow b \\
 A & \xrightarrow{a} & X
 \end{array}$$

Pullback of maps with common codomain

A.2 Diagrams with Absolute Properties

In [63, I.1], Mac Lane defines a category to be a graph with certain properties. It then makes sense to say a *diagram* D in a category \mathcal{X} is a subgraph of \mathcal{X} . We say a property P of a diagram D in \mathcal{X} is *absolute* if, for every functor $F: \mathcal{X} \rightarrow \mathcal{Y}$, the diagram $F(D)$ has property P as well. Elementary examples of absolute diagram properties include:

- ▶ An equality between (composites of) morphisms is an absolute property of a diagram. In particular, being commutative is an absolute property of a diagram D .
- ▶ Being an isomorphism is an absolute property of a diagram which consists of a single morphism.
- ▶ Being an idempotent is an absolute property of an endomorphism e of object X .

Below, we single out certain diagrams with absolute properties, often (co)limit (co)cones, which occur frequently.

A.2.1 Absolute epimorphisms

An epimorphism (1.1.10) in a category \mathcal{X} is absolute if $F(f)$ is an epimorphism for every functor $F: \mathcal{X} \rightarrow \mathcal{Y}$. We show that this happens if and only if f admits a section.

A.2.2 Definition

Sectionable / sectioned morphism

A morphism $q: X \rightarrow Q$ is called *sectionable*, also *splittable*, if there exists $x: Q \rightarrow X$ such that $q \circ x = 1_Q$. A choice of such x is called a *section* or a *splitting* of q , and we say that q is sectioned by x . We write $(q \downarrow x)$ for a morphism q sectioned by a morphism x .

If x is a section of q , then q is a left inverse of x , and x is a right inverse of q . Being a sectionable epimorphism is an absolute property. Direct verification shows that every sectionable morphism is an absolute epimorphism. The converse also holds:

A.2.3 Proposition

Sectionable epi if and only if absolute epi

A morphism $q: X \rightarrow Q$ is sectionable if and only if it is an absolute epimorphism. In this case, every section of q is an absolute monomorphism.

Proof If q admits a section x , then $F(q)$ also admits a section, namely $F(x)$. So, admitting a section is an absolute property. Conversely, suppose $q: X \rightarrow Q$ is an absolute epimorphism. Then the functor $Hom(Q, -): \mathcal{X} \rightarrow Set$ sends q to the epimorphism, i.e., surjective function, $q_*: Hom(Q, X) \rightarrow Hom(Q, Q)$ in Set . So, there is a morphism $x: Q \rightarrow X$ in \mathcal{X} such that $q \circ x = 1_Q$. This makes x is a section of q . \square

Dually, a morphism $m: M \rightarrow X$ is *retractable* if there exists $r: X \rightarrow M$ such that $rm = 1_M$. In this situation we refer to r as the retraction of X to M and write $(m \uparrow r)$. Being a retractable morphism is an absolute property. Such a map is always monic. Dualizing (A.2.3), we find:

A.2.4 Proposition

Retractable if and only if absolute mono

A map $m: M \rightarrow X$ is retractable if and only if m is an absolute monomorphism. \diamond

To clarify, a sectioned epimorphism $(q \downarrow x)$ has an associated retracted monomorphism $(x \uparrow q)$ and vice versa. We must distinguish between the two structures because, in general, neither does q determine x uniquely, nor does x determine q uniquely. So, it matters which of the two maps is given first and then coupled with a *choice* of the other.

The collection of sectioned epimorphisms in \mathcal{X} forms a category $SEpi(\mathcal{X})$. A morphism $(f, g): (q \downarrow x) \rightarrow (r \downarrow y)$ in this category¹ is given by a diagram with commuting properties stated below.

$$\begin{array}{ccc}
 X & \xrightarrow{f} & Y \\
 q \downarrow \uparrow x & & r \downarrow \uparrow y \\
 Q & \xrightarrow{g} & R
 \end{array} \tag{A.2.4}$$

With $q \circ x = 1_Q$ and $r \circ y = 1_R$, the vertical structures are objects in $SEpi(\mathcal{X})$. For (f, g) to form a morphism in $SEpi(\mathcal{X})$, we require $g \circ q = r \circ f$, and $f \circ x = y \circ g$.

¹In the literature, a split epimorphism is sometimes referred to as a *point*. Accordingly, the category $SEpi(\mathcal{X})$ is known as *the category of points in \mathcal{X}* .

A.2.5 Proposition

Pullback of a sectioned epimorphism

In any category consider an epimorphism $r: Y \rightarrow R$, sectioned by $y: R \rightarrow Y$ and pulled back along $f: Q \rightarrow R$:

$$\begin{array}{ccc} P & \xrightarrow{\bar{f}} & Y \\ \bar{r} \downarrow \uparrow \bar{y} & \circ \downarrow & r \downarrow \uparrow y \\ Q & \xrightarrow{f} & R \end{array}$$

Then \bar{r} is sectionable, and there is exactly one section \bar{y} with the property $\bar{f}\bar{y} = yf$. Thus we obtain the morphism $(\bar{f}, f): (\bar{r} \downarrow \bar{y}) \rightarrow (r \downarrow y)$ in $\text{SEpi}(\mathcal{X})$. Moreover, Q is a pullback of y along \bar{f} . \diamond

A.2.6 Proposition

Pushout of a sectioned monomorphism

In any category consider a monomorphism $x: Q \rightarrow X$, with retraction $q: X \rightarrow Q$ and pushed out along $f: Q \rightarrow R$:

$$\begin{array}{ccc} X & \xrightarrow{\underline{f}} & P \\ q \downarrow \uparrow x & \circ \downarrow & \underline{q} \downarrow \uparrow \underline{x} \\ Q & \xrightarrow{f} & R \end{array}$$

Then \underline{x} is retractable, and there is exactly one retraction with the property $\underline{q}\underline{f} = f\underline{q}$. Thus we obtain the morphism $(\underline{f}, f): (\underline{q} \downarrow \underline{x}) \rightarrow (q \downarrow x)$ in $\text{SEpi}(\mathcal{X})$. Moreover, \underline{q} is a pushout of q along \underline{f} . \diamond

Certain morphisms in $\text{SEpi}(\mathcal{X})$ yield absolute diagrams:

A.2.7 Proposition

Pushout / pullback from morphism in $\text{SEpi}(\mathcal{X})$

For a morphism $(f, g): (q \downarrow x) \rightarrow (r \downarrow y)$, as in (A.2.4), the following hold:

(i) If f is an epimorphism, then the square $X \rightrightarrows R$ is a pushout.

(ii) If f is a monomorphism, then the square $Q \rightrightarrows Y$ is a pullback. \diamond

A.2.8 Corollary

Absolute pushout / pullback from sectioned morphism in $\text{SEpi}(\mathcal{X})$

Consider a sectioned morphism in $\text{SEpi}(\mathcal{X})$; i.e.,

$$(f, g): (q \downarrow x) \rightarrow (r \downarrow y) \quad \text{and} \quad (\varphi, \gamma): (r \downarrow y) \rightarrow (q \downarrow x)$$

are morphisms of sectioned epimorphisms, and $(\varphi, \gamma) \circ (f, g) = 1_{(q \downarrow x)}$.

$$\begin{array}{ccc}
 X & \begin{array}{c} \xrightarrow{f} \\ \xleftarrow{\varphi} \end{array} & Y \\
 \begin{array}{c} \uparrow q \\ \downarrow x \end{array} & & \begin{array}{c} \downarrow r \\ \uparrow y \end{array} \\
 Q & \begin{array}{c} \xrightarrow{g} \\ \xleftarrow{\gamma} \end{array} & R
 \end{array} \tag{A.2.8}$$

Then the square $X \rightrightarrows R$ is an absolute pushout, and the square $R \rightrightarrows X$ is an absolute pullback. \diamond

A.2.9 Proposition **Absolute coequalizer from kernel pair of absolute epimorphism**
 In any category \mathcal{X} , if the kernel pair of an absolute epimorphism $f: X \rightarrow Y$ exists, then the diagram

$$KP(f) \begin{array}{c} \xrightarrow{pr_1} \\ \xrightarrow{pr_2} \end{array} \rightrightarrows X \xrightarrow{f} Y$$

is an absolute coequalizer.

Exercises

A.2.10 Exercise

On sectionable epimorphisms

In an arbitrary category \mathcal{X} show the following:

- (i) Every sectionable epimorphism (A.2.2) is an epimorphism.
- (ii) If a morphism f is both an absolute epimorphism and a monomorphism, then it is an isomorphism.

A.2.11 Exercise

Absolute epimorphism need not be an isomorphism

Give examples of categories in which an absolute epimorphism need not be an isomorphism.

A.2.12 Exercise

Morphism of sectioned epimorphisms: Properties

Given a morphism $(f, g): (q \downarrow x) \rightarrow (r \downarrow y)$ of sectioned epimorphisms, as in (A.2.4), do the following:

- (i) Prove (A.2.7.i) and (A.2.7.ii).
- (ii) Prove (A.2.8).
- (iii) Give an example which shows that, for (i), the assumption that f is an epimorphism is essential.
- (iv) Give an example which shows that, for (ii), the assumption that f is a monomorphism is essential.

A.2.13 Exercise

Double absolute epimorphisms

Is a commutative square consisting of absolute epimorphisms always an absolute pushout?

A.2.14 Exercise

Coequalizer by pushout

Suppose two epimorphisms $f, g: X \rightarrow Y$ admit a common section $e: Y \rightarrow X$. Show that the coequalizer of f and g is given by the pushout

$$\begin{array}{ccc} X & \xrightarrow{f} & Y \\ g \downarrow & \lrcorner & \downarrow u \\ Y & \xrightarrow{v} & Z \end{array}$$

If at least one of f or g is a normal epimorphism, conclude that $u = v$ is a normal epimorphism.

A.3 Around Surjectivity

A function of sets $f: X \rightarrow Y$ is surjective if, for every $y \in Y$, its fiber $f^{-1}(y)$ under f is not empty. If the objects in a category \mathcal{X} do not have underlying sets, an approach to defining surjectivity of a morphism in \mathcal{X} via the fiber of its morphisms is not available. Instead, we look for properties of functions which are independent of underlying sets and give an alternate characterization of surjectivity.

We already encountered one such property: a function $f: X \rightarrow Y$ is surjective if and only if it has the right cancellation property in composites: $uf = vf$ implies $u = v$. This condition can be formulated in any category, and gives the definition of an epimorphism (1.1.10); see Section 1.1. We will work with several more alternate characterizations of surjective functions. When interpreted in a category with pullbacks they all imply the epimorphism property, yet they differ subtly in other respects. Thus they are known as types of epimorphisms.

The graphic below presents the types of epimorphisms we encounter. Solid arrows indicate implication of property in any category with the appropriate properties, as indicated by their labels.

1. An undecorated arrow indicates an implication which holds in every category.
2. In a category with finite limits, the implications labeled 'L' hold.
3. In a normal category (3.1.1) and, hence, in homological category, the implications labeled 'N', or 'L' hold. ; see Section 3.2.
4. In an abelian category all implications hold, also the one labeled 'A'.

In a normal category then, the properties of normal, regular, effective, strong, and extremal epimorphisms all coincide; see (3.2.5). Therefore, we mostly work with three types of epimorphisms: split epimorphisms, normal epimorphisms (equivalently cokernels),

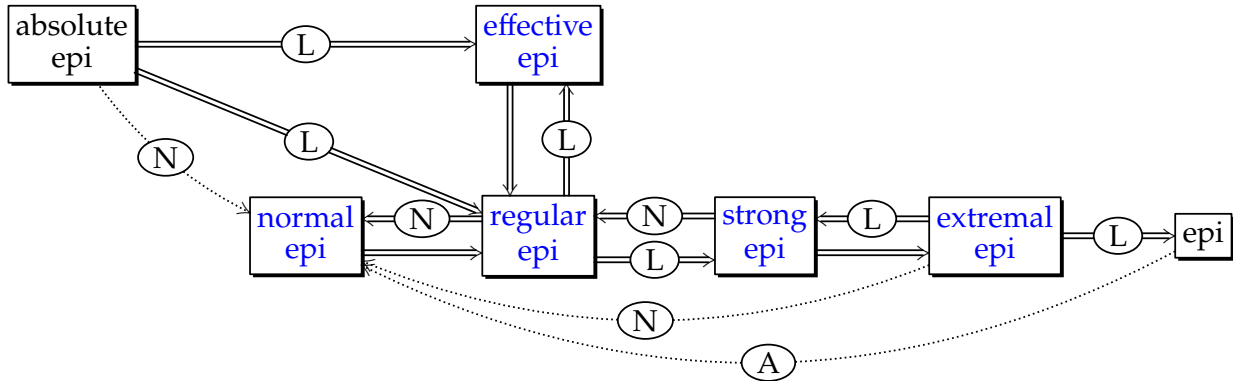

Figure A.1: Several types of epimorphisms

and epimorphisms. Using the defining property of an equivalent type is only of occasional advantage. In the more specialized context of abelian categories, we only need to distinguish between epimorphisms and split epimorphisms.

In a variety of algebras \mathcal{V} , surjective morphisms are the same as effective/regular/strong epimorphisms. On other hand, in general, a regular epimorphisms need not be a surjective algebra morphism. - Let us now turn to details.

A.3.1 Definition

Extremal epimorphism

A morphism $f: X \rightarrow Y$ is called an *extremal epimorphism* if it *only* factors through the subobject of Y represented by 1_Y .

Thus an extremal epimorphism does not factor through any proper subobject of its codomain. If f admits an image factorization, then f is extremal if and only if its image is the codomain of f . It is useful to express definition (A.3.1) in diagram language: f is a extremal epimorphism if and only if, for every factorization of f through a monomorphism m , the map m is an isomorphism.

$$\begin{array}{ccc}
 & & M \\
 & \nearrow x & \downarrow m \\
 X & \xrightarrow{f} & Y
 \end{array}$$

More generally, a pair of maps $(r: A \rightarrow X, s: B \rightarrow X)$ in \mathcal{C} is *jointly extremal-epimorphic*

provided in any commutative diagram

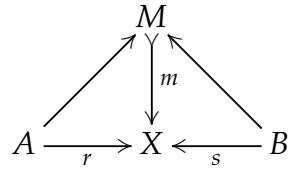

in which m is a monomorphism, it is necessarily an isomorphism. The intuition is that ' r and s together generate all of X '. In a category with binary sums, this is equivalent to saying that the arrow $\langle r, s \rangle: A + B \rightarrow X$ is an extremal epimorphism.

From its definition, it is not at all apparent that an extremal epimorphism is actually an epimorphism. That this is, indeed, the case is the content of the following lemma.

A.3.2 Proposition **Extremal epimorphism is epimorphism**

In a category with equalizers, an extremal epimorphism is an epimorphism.

Proof Suppose $f: X \rightarrow Y$ is an extremal epimorphism, and consider maps $u, v: Y \rightarrow Z$ with $uf = vf$. We then find ourselves in the situation depicted below.

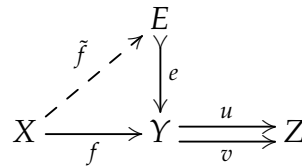

Here e is an equalizer of u and v , hence is monic. Via its universal property, f admits the indicated factorization \tilde{f} . As f is an extremal epimorphism, e is an isomorphism, implying that $u = v$. So f is an epimorphism. □

The following alternate characterization of 'extremal epimorphism' achieves compatibility with factorization systems (Section A.4) and strong epimorphisms (A.3.4).

A.3.3 Proposition **Extremal epimorphism via lifting**

A map $f: X \rightarrow Y$ in a category \mathcal{X} is an extremal epimorphism if and only if every commutative square as shown below admits a filler which renders the entire diagram commutative.

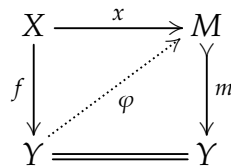

Proof The lifting condition means that m is a split epimorphism and a monomorphism, hence an isomorphism; see (A.2.10). Conversely, if m is an isomorphism then $\varphi = m^{-1}$ is the one and only lifting φ . \square

Once a category has pullbacks, the lifting property in (A.3.3) turns out to be equivalent to an *a priori* stronger condition, namely:

A.3.4 Definition

Strong epimorphism

In any category, a morphism $f: X \rightarrow Y$ is a *strong epimorphism* if every commutative square, with m a monomorphism admits a unique filler φ which renders the entire diagram commutative.

$$\begin{array}{ccc}
 X & \xrightarrow{x} & M \\
 f \downarrow & \nearrow \varphi & \downarrow m \\
 Y & \xrightarrow{y} & Z
 \end{array}$$

A.3.5 Proposition

Extremal vs. strong epimorphism

Every strong epimorphism is extremal. In a category with pullbacks, every extremal epimorphism is strong. \diamond

A.3.6 Definition

Regular/effective epimorphism

A morphism $f: X \rightarrow Y$ is called a *regular epimorphism* if it is the coequalizer of some parallel pair of arrows. It is called an *effective epimorphism* if it is the coequalizer of its kernel pair.

A.3.7 Proposition

Regular vs. effective epimorphism

In a category with pullbacks, a morphism is a regular epimorphism if and only if it is an effective epimorphism.

Proof Comparing definitions shows that an effective epimorphism is regular. To see that the converse holds, consider a regular epimorphism $f: X \rightarrow Y$, expressed as the coequalizer of maps $u, v: W \rightarrow X$. Let $KP(f) = (X \times_Y X, \pi_1, \pi_2)$ be the kernel pair of f and $g: X \rightarrow Z$ a morphism which satisfies $gu = gv$.

The universal property of the kernel pair yields a map $\gamma: W \rightarrow X \times_Y X$, unique with the properties $\pi_1\gamma = u$ and $\pi_2\gamma = v$. We conclude

$$gu = g\pi_1\gamma = g\pi_2\gamma = gv.$$

So the universal property of the coequalizer f yields a map $t: Y \rightarrow Z$, unique with the property $tf = g$. This proves that f is a coequalizer of its kernel pair. \square

A normal epimorphism (1.4.4) is always a regular epimorphism. Whenever a category has pullbacks, the following hold.

A.3.8 Lemma **Absolute epi implies regular epi implies strong epi**
 In an arbitrary category \mathcal{X} , consider the following properties a morphism $f: X \rightarrow Y$:

- (i) f is an absolute epimorphism;
- (ii) f is an effective epimorphism;
- (iii) f is a regular epimorphism;
- (iv) f is an extremal epimorphism;
- (v) f is a strong epimorphism.

If \mathcal{X} has pullbacks, then (i) \Rightarrow (ii) \Leftrightarrow (iii) \Rightarrow (iv) \Leftrightarrow (v).

Proof (i) \Rightarrow (ii) Suppose $x: Y \rightarrow X$ is a section of f . We show directly that f satisfies the universal property required of a coequalizer of its kernel pair. If $(KP(f), \pi_1, \pi_2)$ is the kernel pair of f , consider $g: X \rightarrow Z$ with $g\pi_1 = g\pi_2$. We claim that $gx: Y \rightarrow Z$ is the unique factorization of f through f . Uniqueness follows from the epimorphic property of f . To see that $g = (gx)f$, let $\eta: X \rightarrow KP(f)$ be the universal map induced by $(1_X, sf)$.

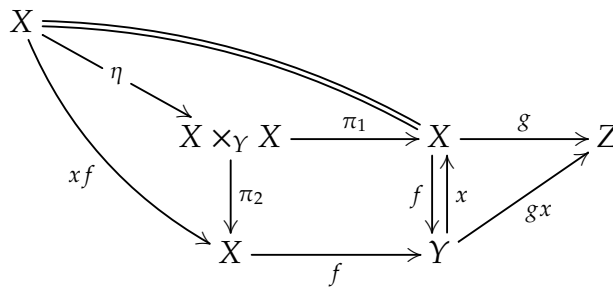

Then we find, as required:

$$g = g\pi_1\eta = g\pi_2\eta = gfx$$

(ii) \Leftrightarrow (iii) is Proposition A.3.7.

(iii) \Rightarrow (iv) consider a regular epimorphism $f: X \rightarrow Y$, expressed as the coequalizer of maps $u, v: W \rightarrow X$. Assume $f = m\tilde{f}$ where m is a monomorphism. Then by the universal property of m we have $\tilde{f}u = \tilde{f}v$. Since f is the coequalizer of u and v , we have a unique $n: Y \rightarrow M$ such that $nm = 1_Y$, from which it follows that m is an isomorphism.

(iv) \Leftrightarrow (v) is Proposition A.3.5. □

A.3.9 Proposition

Strong epi implies regular epi in regular category

In a regular category (A.4.11), any strong epimorphism is a regular epimorphism.

Proof Consider a strong epimorphism f and factor it as a regular epimorphism ε followed by a monomorphism μ . This yields the following commutative square of solid arrows.

$$\begin{array}{ccc} X & \xrightarrow{\varepsilon} & M \\ f \downarrow & \nearrow \varphi & \downarrow \mu \\ Y & \xlongequal{\quad} & Y \end{array}$$

Since f is a strong epimorphism, a dotted filler φ exists. Now μ is both a monomorphism and a split epimorphism, which makes it an isomorphism. It follows that f is a regular epimorphism. \square

A.3.10 Example

An epimorphism which is not regular

In the category \mathbf{URng} of unital rings the inclusion $i: \mathbb{Z} \rightarrow \mathbb{Q}$ is an epimorphism, even though it is not a surjective ring homomorphism. To see this, consider morphisms of rings $f, g: \mathbb{Q} \rightarrow R$ satisfying $f \circ i = g \circ i$. Writing $q \in \mathbb{Q}$ as a quotient $\frac{a}{b}$ with $a, b \in \mathbb{Z}$, we find:

$$\begin{aligned} f(q) &= f\left(\frac{a}{b}\right) = f\left(\frac{1}{b}a\right) = f\left(\frac{1}{b}\right)f(a) = f\left(\frac{1}{b}\right)g(a) = f\left(\frac{1}{b}\right)g\left(b\frac{a}{b}\right) = f\left(\frac{1}{b}\right)g(b)g\left(\frac{a}{b}\right) \\ &= f\left(\frac{1}{b}\right)f(b)g\left(\frac{a}{b}\right) = f\left(\frac{b}{b}\right)g\left(\frac{a}{b}\right) = f(1)g\left(\frac{a}{b}\right) = g(1)g\left(\frac{a}{b}\right) = g\left(1\frac{a}{b}\right) = g(q). \end{aligned}$$

Since a regular epimorphism in \mathbf{URng} is a quotient function of underlying sets, i is an epimorphism which is not regular.

Example A.3.10 also shows that a morphism which is both epic and monic need not be an isomorphism.

A.3.11 Example

Epimorphisms in Grp

A surjective group homomorphism is an epimorphism of underlying sets, hence is an epimorphism of groups. The converse is also true. But the proof is a bit of a challenge; see Exercise 1.1.14.

Exercises

A.3.12 Exercise

'Being an epimorphism' is a colimit property

In any category show that $f: X \rightarrow Y$ is an epimorphism if and only if the diagram below has the pushout property.

$$\begin{array}{ccc} X & \xrightarrow{f} & Y \\ f \downarrow & & \parallel \\ Y & \xlongequal{\quad} & Y \end{array}$$

Then formulate and prove the dual of this statement.

A.3.13 Exercise

Extremal epimorphism - properties

Show that following holds in an arbitrary category:

- (i) If $g \circ f$ is an extremal epimorphism, then g is an extremal epimorphism.
- (ii) A morphism f is an isomorphism if and only if it is an extremal epimorphism and a monomorphism.

A.3.14 Exercise

Strong epimorphism - properties

Show that following holds in an arbitrary category:

- (i) If $g \circ f$ is a strong epimorphism, and f is an epimorphism, then g is a strong epimorphism.
- (ii) Any composite of two strong epimorphisms is a strong epimorphism.

A.3.15 Exercise

Strong epi / mono factorization unique

In the commutative square below, assume that e and ε are strong epimorphisms, and that m and μ are monomorphisms.

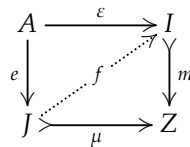

Show that there is an isomorphism $f: J \rightarrow I$ which is unique with the property that it renders the entire diagram commutative.

A.3.16 Exercise

Extremal epimorphism characterization of join

In any category, given two subobjects $m: M \rightarrow X$ and $n: N \rightarrow X$ of an object X , a monomorphism $i: I \rightarrow X$ represents the join of m and n if and only if the following two conditions hold:

- (i) m and n factor through i via $m': M \rightarrow I$ and $n': N \rightarrow I$, and
- (ii) the morphisms m' and n' are jointly extremal-epimorphic. ◇

A.3.17 Exercise

Extremal epi vs. strong epi

Prove (A.3.5): Every strong epimorphism is extremal. In a category with pullbacks, every extremal epimorphism is a strong epimorphism.

A.3.18 Exercise

Exact diagram of sets

A diagram of sets

$$A \xrightarrow{k} X \begin{array}{c} \xrightarrow{u} \\ \xrightarrow{v} \end{array} Y$$

is said to be *exact* if, for every $x \in X$ with $u(x) = v(x)$ there exists a unique $a \in A$ such that $k(a) = x$. Show the following

- (i) The diagram of sets above is exact if and only if k is an equalizer of u and v in the category Set of sets.
- (ii) In the category Grp of groups, show that $\kappa: K \rightarrow X$ is a kernel of $f: X \rightarrow Y$ if and only if the diagram of underlying sets and functions below is exact.

$$K \xrightarrow{\kappa} X \begin{array}{c} \xrightarrow{f} \\ \xrightarrow{0} \end{array} Y$$

A.3.19 Exercise

Hom-view of effective epimorphism

In a category which admits kernel pairs show that the following conditions of a morphism $f: X \rightarrow Y$ are equivalent.

- (i) f is an effective epimorphism; see (A.3.6).
- (ii) For every object T in \mathcal{X} this diagram of Hom-sets is an exact diagram of sets:

$$\text{Hom}(Y, T) \xrightarrow{\text{Hom}(f, T)} \text{Hom}(X, T) \begin{array}{c} \xrightarrow{\text{Hom}(pr_1, T)} \\ \xrightarrow{\text{Hom}(pr_2, T)} \end{array} \text{Hom}(KP(f), T)$$

- (iii) [75, p. 4.3] For every $\alpha: X \rightarrow T$ satisfying

$$[\text{for all } u, v: A \rightarrow X \text{ with } fu = fv] \Rightarrow [\alpha u = \alpha v]$$

there exists a unique $\beta: Y \rightarrow T$ with $\beta f = \alpha$.

A.3.20 Exercise

In an arbitrary category with pullbacks, assume that the front and back faces in the diagram below are pullbacks.

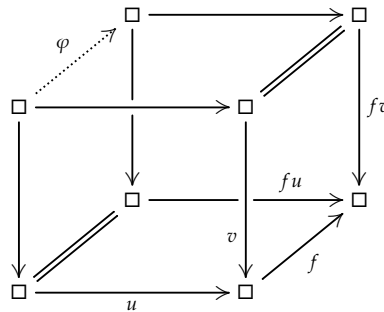

- (i) Show that there exists a unique map φ which renders the entire cube commutative.
- (ii) If f is a monomorphism, show that φ is an isomorphism.
- (iii) [20, p. 173] If $u = v$ is a split epimorphism, and φ is an isomorphism, show that f is a monomorphism.
- (iv) [20, p. 176] In a semiabelian category, assume $u = v$ is a normal epimorphism. Then φ is an isomorphism, if and only if f is a monomorphism.

A.4 Factorization Systems

Here we collect background relevant to the theory of factorizations in general, and image factorizations in particular. Thus, in a category \mathcal{C} we consider two classes of morphisms \mathcal{E} and \mathcal{M} , assuming formally the role played by surjections / injections in image factorizations of functions of sets. Then, an arbitrary morphism $f: X \rightarrow Y$ in \mathcal{C} should be a composite $f = me$ with $e \in \mathcal{E}$ and $m \in \mathcal{M}$ in a functorial manner; that is, any commutative diagram of solid arrows in \mathcal{C} of the kind displayed below should admit a unique filler as indicated.

$$\begin{array}{ccccc}
 & & f & & \\
 & & \curvearrowright & & \\
 A & \xrightarrow{e} & I & \xrightarrow{m} & B \\
 \downarrow a & & \downarrow \varphi & & \downarrow b \\
 X & \xrightarrow{e'} & J & \xrightarrow{n} & Y \\
 & & \curvearrowleft & & \\
 & & g & &
 \end{array}$$

A composite $f = me$ is called an $(\mathcal{E}, \mathcal{M})$ -factorization of f . Functoriality of such decompositions is elegantly achieved (A.4.4) by requiring the pair $(\mathcal{E}, \mathcal{M})$ to form an orthogonal prefactorization system, see (A.4.2).

A.4.1 Definition

Left / right orthogonal

In a category \mathcal{C} , a morphism $e: A \rightarrow B$ is said to be *left orthogonal* to $m: U \rightarrow V$, and m is said to be *right orthogonal* to e if every one of these commutative squares in \mathcal{C} admits a unique filler φ as indicated.

$$\begin{array}{ccc}
 A & \xrightarrow{u} & U \\
 \downarrow e & \nearrow \varphi & \downarrow m \\
 B & \xrightarrow{v} & V
 \end{array}$$

A.4.2 Definition

Orthogonal prefactorization system

A pair of classes of morphisms $(\mathcal{E}, \mathcal{M})$ in a category \mathcal{C} is said to form an *orthogonal prefactorization system* (OPFS) if these two conditions are satisfied:

- (i) \mathcal{E} is the *left orthogonal complement* of \mathcal{M} , meaning: $e \in \mathcal{E}$ if and only if e is left orthogonal to every $m \in \mathcal{M}$.
- (ii) \mathcal{M} is the *right orthogonal complement* of \mathcal{E} , meaning: $m \in \mathcal{M}$ if and only if m is right orthogonal to every $e \in \mathcal{E}$.

A.4.3 Definition

Orthogonal factorization system

An *orthogonal factorization system* (OFS) in a category \mathcal{C} is given by an orthogonal prefactorization system $(\mathcal{E}, \mathcal{M})$ such that every morphism $f : X \rightarrow Y$ in \mathcal{C} admits a factorization $f = me$, with $m \in \mathcal{M}$ and $e \in \mathcal{E}$.

A.4.4 Proposition

OFS-factorizations are functorial

If $(\mathcal{E}, \mathcal{M})$ is an OFS in a category \mathcal{C} , then $(\mathcal{E}, \mathcal{M})$ -factorizations of morphisms are functorial.

Proof The need for a functorial filler on the left below may be rearranged into the lifting problem presented on the right.

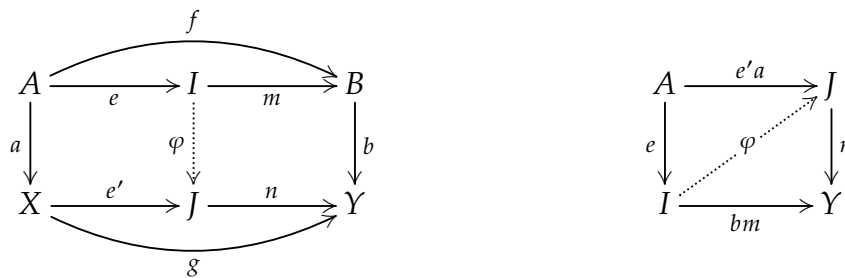

Thus φ exists and is unique as required. □

In particular, (A.4.4) tells us that $(\mathcal{E}, \mathcal{M})$ -factorizations of a given map are unique up to unique isomorphism.

Orthogonal prefactorization systems are easy to construct:

A.4.5 Proposition

Construction of OPFS

Given any class \mathcal{W} of morphisms in a category \mathcal{C} , each of the following two constructions yields an OPFS:

- (i) $(\mathcal{E}, \mathcal{M})$, with \mathcal{E} the left orthogonal complement of \mathcal{W} , and \mathcal{M} be the right orthogonal complement of \mathcal{E} .
- (ii) $(\mathcal{E}, \mathcal{M})$, with \mathcal{M} the right orthogonal complement of \mathcal{W} , and \mathcal{E} be the left orthogonal complement of \mathcal{M} . ◇

While it is easy to check the truth of (A.4.5) directly, we point out that this is an example of a Galois correspondence. Motivated by image factorizations encountered for morphisms between groups, Lie algebras, objects in an abelian category, etc., we are particularly interested in an OPFS $(\mathcal{E}, \mathcal{M})$ in which \mathcal{M} is the class of monomorphisms. This suggests (see also (A.3.4)):

A.4.6 Definition

Strong epimorphism

A morphism f in a category \mathcal{C} is called a *strong epimorphism* if it is left orthogonal to every monomorphism in \mathcal{C} .

According to (A.4.5), we obtain in an arbitrary category \mathcal{C} an OPFS $(\mathcal{E}, \mathcal{M})$ in which \mathcal{E} is the left orthogonal complement of the class of monomorphisms in \mathcal{C} , and \mathcal{M} is the right orthogonal complement of \mathcal{E} . In general, there is then nothing that tells us that every strong epimorphism is actually an epimorphism, see Section A.3 nor is there any guarantee that every map in \mathcal{M} is a monomorphism. However, all of this goes well under mild additional assumptions, which is what we are going to explain now.

A.4.7 Proposition

OPFS: (strong epis, monos) in cat with coequalizers

In a category \mathcal{C} which admits coequalizers, an OPFS is given by \mathcal{M} the class of monomorphisms of \mathcal{C} , and \mathcal{E} the strong epimorphisms.

A.4.8 Corollary

OPFS: (strong epis, monos) and strong epi is epi

In a category which admits equalizers and coequalizers an OPFS $(\mathcal{E}, \mathcal{M})$ is given by strong epimorphisms and monomorphisms. Moreover, every strong epimorphism is epic. \diamond

A.4.9 Corollary

OPFS: in reflective subcategory

In a finitely complete and cocomplete category \mathcal{C} , let \mathcal{R} be a full and replete reflective subcategory. Then the following hold:

- (i) The OPFS $(\mathcal{E}, \mathcal{M})$ on \mathcal{C} given by (strong epimorphisms, monomorphisms) restricts to an OPFS on \mathcal{R} .
- (ii) If $(\mathcal{E}, \mathcal{M})$ is a factorization system on \mathcal{C} , and \mathcal{R} is closed under subobjects, then the inclusion functor $G: \mathcal{R} \rightarrow \mathcal{C}$ creates image factorizations in \mathcal{R} .

Proof (i) Both categories are finitely complete and cocomplete. So, in each, an OPFS is given by (strong epimorphisms, monomorphism). Further, a map m is a monomorphism in \mathcal{R} if and only if it is a monomorphism in \mathcal{X} . So, for X, Y are in \mathcal{R} , the strong epimorphisms in $Hom_{\mathcal{R}}(X, Y)$ and in $Hom_{\mathcal{C}}(X, Y)$ are the same, because \mathcal{R} is full in \mathcal{X} . - This proves (i)

(ii) If $f: X \rightarrow Y$ is a morphism in \mathcal{R} , let $X \xrightarrow{q} I \xrightarrow{i} Y$ be its image factorization in \mathcal{X} . Then i and, hence q are in \mathcal{R} because \mathcal{R} is closed under subobjects. By (i), q is a strong epimorphism in \mathcal{R} , and i is a monomorphism in \mathcal{R} . So, the image factorization of f in \mathcal{X} is also an image factorization of f in \mathcal{R} . \square

We turn to the question under which conditions the kind of OPFS encountered in (A.4.8) is actually an OFS. Thus, we require of every morphism $f: X \rightarrow Y$ that it admits a

factorization

$$X \xrightarrow{q} \twoheadrightarrow I(f) \xrightarrow{m} Y$$

with q in \mathcal{E} and m in \mathcal{M} . Such a factorization is called an *image factorization* of f , and the *image* of f is the subobject of Y represented by m .

There are essentially two mutually complementary approaches:

- (1) Given a morphism $f: X \rightarrow Y$, assume that the intersection $m: I \rightarrow Y$ of all subobjects of Y through which f factors exists. Then $f = mp$, and p can be shown to be an extremal epimorphism, hence an epimorphism which is strong. So $f = mp$ is the desired image factorization of f , which is then automatically functorial by (A.4.4).
- (2) We perform a construction on f which achieves $f = \mu p$, with p a strong epimorphism. If we can then show that μ is a monomorphism, we have the desired image factorization.

The following two variations of approach (2) are particularly relevant to us:

- (2.a) Take the kernel pair of f and p its coequalizer. This approach is classical [4], and probably the best one can do in a regular category if the KSG-property is not guaranteed. For this, existence of coequalizers of kernel pairs suffices. See A.4.12.
- (2.b) Take the kernel of f and p its cokernel. This works in varieties such as module categories, groups, Lie algebras. It is the approach taken here in section 3.2 in the context of a normal category, and relies heavily on the KSG-axiom which asserts that, in a split short exact sequence, the middle object is generated by the subobjects at its ends. We prefer this approach over (2.a) because it is technically less involved.

A.4.10 Image Factorization in Regular Categories

We explain how regular categories provide a kind of image factorization which is particularly well adapted to varieties of universal algebras; see [39, 1.14].

A.4.11 Definition

Regular category

A finitely complete category with coequalizers of kernel pairs is *regular* if pullbacks preserve regular epimorphisms.

We show that this is equivalent to the existence of pullback-stable image factorizations²:

²Here things are really different from what happens in Proposition 3.2.4. So we need a new proof.

Given a morphism $f: X \rightarrow Y$, we rely on the following construction:

$$\begin{array}{ccccc}
 KP(f) & \begin{array}{c} \xrightarrow{\pi_1} \\ \xleftarrow{e} \\ \xrightarrow{\pi_2} \end{array} & X & \xrightarrow{q:=\text{coeq}(\pi_1,\pi_2)} & I \\
 & & & \searrow f & \downarrow m \\
 & & & & Y
 \end{array}$$

A.4.12 Proposition

Images in regular categories

In a regular category, the map m in the diagram above is a monomorphism.

Proof Consider the situation where r in the diagram diagram below is an epimorphism.

$$\begin{array}{ccccc}
 KP(f) & \begin{array}{c} \xrightarrow{\pi_1} \\ \xleftarrow{e} \\ \xrightarrow{\pi_2} \end{array} & X & \xrightarrow{f} & Y \\
 \downarrow r & & \downarrow q & & \parallel \\
 KP(m) & \begin{array}{c} \xrightarrow{\pi'_1} \\ \xleftarrow{e'} \\ \xrightarrow{\pi'_2} \end{array} & I & \xrightarrow{m} & Y
 \end{array}$$

Then $\pi'_1 = \pi'_2$, because $\pi'_1 r = q\pi_1 = q\pi_2 = \pi'_2 r$. So, m is a monomorphism by (A.1.8). To see that r is epic consider the diagram below in which every square is a pullback:

$$\begin{array}{ccccc}
 KP(f) & \xrightarrow{r_1} & P & \xrightarrow{r_2} & KP(m) \\
 (\pi_1,\pi_2)\downarrow & & \downarrow & & \downarrow (\pi'_1,\pi'_2) \\
 X \times X & \xrightarrow{1_X \times q} & X \times I & \xrightarrow{q \times 1_X} & I \times I \\
 \swarrow \pi_2 & & \swarrow \pi_2 & & \swarrow \pi_1 \\
 X & \xrightarrow{q} & I & & X & \xrightarrow{q} & I
 \end{array}$$

All horizontal arrows are pulled back from the regular epimorphism q ; so they are regular epimorphisms. Thus $r = r_2 r_1$ is an epimorphism as a composite of two regular epimorphisms. \square

A.4.13 Corollary

Orthogonal factorization system in regular category

In a regular category, an orthogonal factorization system $(\mathcal{E}, \mathcal{M})$ is given by \mathcal{E} the class of regular, hence strong, epimorphisms, and \mathcal{M} the class of monomorphisms. \diamond

A.4.14 Corollary

Recognizing a regular category

A finitely complete category with coequalizers of kernel pairs is regular if and only if it satisfies the following two properties:

1. Every morphism f admits a factorization $f = \mu \circ \varepsilon$ in which ε is a regular epimorphism and μ is a monomorphism.
2. Every such factorization is preserved under pullbacks. ◇

Note that in this setting, regular epimorphisms and normal epimorphisms need not coincide. On the other hand, extremal, strong, effective and regular epimorphisms do; see Section A.3.

A.5 Reflective Subcategories

A.5.1 Definition

Reflective subcategory

Given a category \mathcal{C} , a subcategory \mathcal{R} of \mathcal{C} is called *reflective* if the inclusion functor $G: \mathcal{R} \rightarrow \mathcal{C}$ has a left adjoint, say $T: \mathcal{C} \rightarrow \mathcal{R}$. The functor T is called a *reflector* of \mathcal{C} in \mathcal{R} .

When working with a reflection of \mathcal{C} in \mathcal{R} , we will always assume that \mathcal{R} is full and replete in \mathcal{C} . As is explained in [63, IV.3], such a reflection may equivalently be given by a pair (T, η) , where

1. $T: \mathcal{C} \rightarrow \mathcal{R}$ is a functor, and
2. $\eta: 1_{\mathcal{C}} \Rightarrow GT$ is a natural transformation with this universal property: For every pair of objects X in \mathcal{C} , and A in \mathcal{R} , every morphism $f: X \rightarrow GA$ in \mathcal{C} may be uniquely as shown in the diagram on the left:

$$\begin{array}{ccc}
 X & \xrightarrow{\eta_X} & GTX \\
 f \downarrow & \swarrow \tilde{f} & \\
 GA & &
 \end{array}
 \qquad
 \begin{array}{ccc}
 X & \xrightarrow{\eta_X} & TX \\
 f \downarrow & \swarrow \tilde{f} & \\
 A & &
 \end{array}$$

The natural transformation η is the *adjunction unit* of the reflection. Since G is an inclusion functor, we will often simplify the exposition by omitting it. Thus, the triangle on the left above turns into the less precise but more economical triangle on the right. For A in \mathcal{R} , the map $\eta_A: A \rightarrow TA$ is an isomorphism; see (A.5.12). Consequently, the commutative square below explains why T is idempotent in the strong sense that, for every object X in \mathcal{C} , the adjunction unit is an isomorphism $T\eta_X = \eta_{TX}: TX \rightarrow T^2X$:

$$\begin{array}{ccc}
 X & \xrightarrow{\eta_X} & TX \\
 \eta_X \downarrow & & \cong \downarrow \eta_{TX} \\
 TX & \xrightarrow{\cong} & T^2X \\
 & T\eta_X &
 \end{array}$$

Limits and colimits of a category \mathcal{C} are strongly related to limits and colimits in any reflective subcategory. Here are the details.

A.5.2 Theorem

Colimits in a reflective subcategory

Let $T: \mathcal{C} \rightarrow \mathcal{R}$ be a reflector, and let $G: \mathcal{R} \rightarrow \mathcal{C}$ be the inclusion. For a functor $\phi: D \rightarrow \mathcal{C}$ from a small category D into \mathcal{C} the following hold:

- (i) T constructs colimits in \mathcal{R} : If $\phi: D \rightarrow \mathcal{C}$, then $\phi \Rightarrow \text{colim}(G\phi) \xrightarrow{\eta} T\text{colim}(G\phi)$ is a colimit cocone in \mathcal{R} , provided $\text{colim}(G\phi)$ exists in \mathcal{C} .
- (ii) T preserves colimits: If $\gamma: \phi \Rightarrow C$ is a colimit cocone for ϕ , then $T \circ \gamma: T \circ \phi \Rightarrow TC$ is a colimit cocone in \mathcal{R} .

Proof (i) follows via the universal property of η . (ii) is a property of all functors which admit a right adjoint. \square

A.5.3 Theorem

Limits in a reflective subcategory

Let $T: \mathcal{C} \rightarrow \mathcal{R}$ be a reflector, and let $G: \mathcal{R} \rightarrow \mathcal{C}$ be the inclusion. For a functor $\phi: D \rightarrow \mathcal{R}$ from a small category D into \mathcal{R} the following hold:

- (i) G preserves limits: If $\lambda: L \Rightarrow \phi$ is a limit cone for ϕ in \mathcal{R} , then it is also a limit cone for $G\phi$ in \mathcal{C} .
- (ii) G creates limits in \mathcal{R} : If $\phi: D \rightarrow \mathcal{R}$, and $\lambda: L \rightarrow G\phi$ is a limit cone in \mathcal{C} , then L is in \mathcal{R} , and $\lambda: L \rightarrow G\phi = \phi$ is a limit cone in \mathcal{R} .

Proof (i) holds because the inclusion of \mathcal{R} in \mathcal{X} is full and faithful. (ii) is a property of all functors which admit a left adjoint. \square

We turn to the question: How do we recognize whether a given subcategory of \mathcal{C} is reflective? Discussing this question benefits from orthogonality between morphism and object in the following sense.

A.5.4 Definition

Categorical orthogonality: morphism / object

In a category \mathcal{C} an object Z is *orthogonal* to a morphism $u: A \rightarrow B$ if the induced function of morphism sets below is a bijection

$$u^*: \text{Hom}_{\mathcal{C}}(B, Z) \rightarrow \text{Hom}_{\mathcal{C}}(A, Z), \quad f \mapsto f \circ u.$$

$$\begin{array}{ccc} B & \xrightarrow{f} & Z \\ \uparrow u & \nearrow f \circ u & \\ A & & \end{array}$$

A.5.5 Definition

Orthogonal complement

The *orthogonal complement* of a class of morphisms M in \mathcal{C} is M^\perp , the collection of all objects Z which are orthogonal to every morphism in M . The *orthogonal complement of a class of objects* O in \mathcal{C} is O^\perp , the collection of all morphisms which are orthogonal to every object in O .

A.5.6 Definition

Orthogonal pair

An *orthogonal pair* (M, O) in a category \mathcal{C} is given by a class of morphisms M and a class of objects O in \mathcal{C} such that

$$M^\perp = O \quad \text{and} \quad M = O^\perp$$

To explain why orthogonal pairs are relevant to the discussion of reflectors on a category, we introduce the following concepts:

A.5.7 Definition

Equivalence / local object of reflections

Given a reflection (T, η) of \mathcal{C} in a subcategory \mathcal{R} of \mathcal{C} , we say:

- (i) A morphism $f: X \rightarrow Y$ in \mathcal{C} is a *T-equivalence* if Tf is an isomorphism.
- (ii) An object Z in \mathcal{C} is *T-local* if $\eta_Z: Z \rightarrow TZ$ is an isomorphism.

A.5.8 Proposition

Reflector yields orthogonal pair

If $T: \mathcal{C} \rightarrow \mathcal{R}$ is a reflector from a category \mathcal{C} to a full and replete subcategory \mathcal{R} , let \mathcal{W} denote the class of *T-equivalences*, and let \mathcal{L} be the class of *T-local objects*. Then $\mathcal{L} = \text{Ob}(\mathcal{R})$ is the object class of \mathcal{R} , and $(\mathcal{W}, \mathcal{L})$ is an orthogonal pair.

Proof We show first that every object Z in \mathcal{R} is *T-local*. Indeed, the universal property of η_Z yields a left inverse γ of η_Z via the triangle on the left,



Via the identity $(\eta_Z \circ \gamma) \circ \eta_Z = \eta_Z$, the diagram on the right explains why γ is also a right inverse of η_Z . So $\text{Ob}(\mathcal{R}) \subseteq \mathcal{L}$. Conversely, if X in \mathcal{C} is *T-local*, then $\eta_X: X \rightarrow TX$ is an isomorphism to an object in \mathcal{R} . So, X itself is in \mathcal{R} because \mathcal{R} is replete; i.e. $\mathcal{L} \subseteq \text{Ob}(\mathcal{R})$.

Next, we show that every *T-local* object Z is orthogonal to every *T-equivalence* $u: A \rightarrow B$.

Given $v: A \rightarrow Z$, the commutative diagram below shows that $v = \eta_Z(Tv)(Tu)^{-1}\eta_B u$.

$$\begin{array}{ccccc}
 & & w & & \\
 & \swarrow & \cdots & \searrow & \\
 Z & \xleftarrow{v} & A & \xrightarrow{u} & B \\
 \eta_Z \downarrow \cong & & \eta_A \downarrow & & \downarrow \eta_B \\
 TZ & \xleftarrow{Tv} & TA & \xrightarrow{Tu} & TB \\
 & \swarrow & \cdots & \searrow & \\
 & & Tw & &
 \end{array}$$

To see that the factorization of v through u is unique, suppose $w: B \rightarrow Z$ satisfies $wu = v$. This gives

$$w = \eta_Z^{-1}T(w)\eta_B = \eta_Z^{-1}T(v)T(u)^{-1}\eta_B,$$

as required. This establishes $\mathcal{L} \subseteq \mathcal{W}^\perp$ and $\mathcal{W} \subseteq \mathcal{L}^\perp$.

Now consider the case where $u: A \rightarrow B$ is orthogonal to every T -local object Z . We claim that u is a T -equivalence. Consider this reflector diagram:

$$\begin{array}{ccc}
 A & \xrightarrow{u} & B \\
 \eta_A \downarrow & \nearrow \bar{\gamma} & \downarrow \eta_B \\
 TA & \xleftarrow{\gamma} & TB \\
 & \xrightarrow{Tu} &
 \end{array}$$

First η_A factors uniquely through u via $\bar{\gamma}$. Then $\bar{\gamma}$ factors uniquely through η_B via $\gamma: TB \rightarrow TA$. We claim that γ is the inverse of Tu . First, we find:

$$(Tu)\gamma\eta_B u = (Tu)\bar{\gamma}u = \eta_A(Tu) = \eta_B u$$

So, $(Tu)\gamma\eta_B = \eta_B$ because u is orthogonal to TB . Then $(Tu)\gamma = 1_{TB}$ via the universal property of η_B . Similarly,

$$\gamma(Tu)\eta_A = \gamma\eta_B u = \bar{\gamma}u = \eta_A$$

So, $\gamma(Tu) = 1_{TA}$ follows. - So u is a T -equivalence; i.e. $\mathcal{L}^\perp \subseteq \mathcal{W}$.

Finally, consider the case where Y in \mathcal{C} is orthogonal to every T -equivalence. Then Y is orthogonal to the T -equivalence η_Y . So, we obtain a left inverse for $\eta_Y: Y \rightarrow TY$, which is seen to be a right inverse as well. So, Y is T -local, and $\mathcal{W}^\perp \subseteq \mathcal{L}$ follows. This completes the proof. \square

We may interpret (A.5.8) as saying that $T: \mathcal{C} \rightarrow \mathcal{R}$ is, up to equivalence of categories, a model for the Gabriel–Zisman localization $\mathcal{C} \rightarrow \mathcal{C}[\mathcal{W}^{-1}]$; see [35]. Thus, while in general, there is no guarantee that the Gabriel–Zisman localization of a locally small category is

again locally small, in the special case where \mathcal{W} is the class of equivalences of a reflector, we do obtain a locally small model for $\mathcal{C} \rightarrow \mathcal{C}[\mathcal{W}^{-1}]$.

Here are the basic properties of orthogonality, and of orthogonal pairs.

A.5.9 Proposition **Properties of orthogonality: morphism/object**
In an arbitrary category \mathcal{C} show that the following hold:

- (i) For every class M of morphisms in a category \mathcal{C} , $M \subseteq M^{\perp\perp}$.
- (ii) For every class O of objects in \mathcal{C} , $O \subseteq O^{\perp\perp}$.
- (iii) If $M \subseteq N$ are classes of morphisms in \mathcal{C} , then $N^{\perp} \subseteq M^{\perp}$.
- (iv) If $O \subseteq P$ are classes of morphisms in \mathcal{C} , then $P^{\perp} \subseteq O^{\perp}$.
- (v) $\perp^3 = \perp$, when applied to a class of objects, as well as a class of morphisms.
- (vi) For any class M of morphisms in \mathcal{C} , $(M^{\perp\perp}, O^{\perp})$ is an orthogonal pair.
- (vii) For any class O of objects in \mathcal{C} , $(O^{\perp}, O^{\perp\perp})$ is an orthogonal pair.

A.5.10 Proposition **Properties of orthogonal pairs**
For an orthogonal pair (M, O) in a category \mathcal{C} the following hold:

- (i) '2 out of 3'-rule in M : given a composite $A \xrightarrow{u} B \xrightarrow{v} C$, if 2 out of u, v , and vu are in M , so is the third.
- (ii) If $u: A \rightarrow B$ is in M and A, B are in O , then u is an isomorphism.
- (iii) The class O is closed under limits: If $\phi: D \rightarrow \mathcal{C}$, D small, has $\phi(j) \in O$, for all $j \in \text{Ob}(J)$, then $\lim(\phi)$ is in O .
- (iv) The class M is closed under arbitrary colimits: i.e. if $\tau: \phi_0 \Rightarrow \phi_1$ is a natural transformation of functors $\phi_0, \phi_1: D \rightarrow \mathcal{C}$, D small, with $\tau_d: \phi_0(d) \rightarrow \phi_1(d)$ in M , for all d in D , then $\text{colim}(\tau): \text{colim}(\phi_0) \rightarrow \text{colim}(\phi_1)$ is in M .

A.5.11 Corollary **When G preserves/reflects monomorphisms / isomorphisms**
Let $G: \mathcal{R} \rightarrow \mathcal{C}$ be the inclusion of a reflective subcategory. Then the following hold:

1. G preserves and reflects isomorphisms.
2. G reflects monomorphisms.
3. If \mathcal{R} admits pullbacks, then the inclusion G preserves monomorphisms.

Proof (i) and (ii) follow from the definitions. (iii) Given a map $f: X \rightarrow Y$ in \mathcal{R} , we know that f is a monomorphism if and only if \bar{f} in the kernel pair diagram below is an isomorphism.

$$\begin{array}{ccc} K & \xrightarrow{\bar{f}} & X \\ \downarrow & \circlearrowleft & \downarrow f \\ X & \xrightarrow{f} & Y \end{array}$$

This pullback diagram in \mathcal{R} is also a pullback diagram in \mathcal{X} by (A.5.3.i). If f is a monomorphism in \mathcal{R} , then \bar{f} is an isomorphism. Applying G to this diagram yields a pullback diagram in \mathcal{X} , and $G\bar{f}$ is an isomorphism. So Gf is a monomorphism. \square

We leave it to the reader to dualize what we said about reflective subcategories and obtain corresponding properties of coreflective subcategories.

Exercises

A.5.12 Exercise

Reflector unit is an isomorphism

If (T, η) is a reflection of \mathcal{C} in \mathcal{R} , show that $\eta_A: A \rightarrow TA$ is an isomorphism for every A in \mathcal{R} .

A.5.13 Exercise

Prove Propositions A.5.9 and A.5.10.

A.5.14 Exercise

Sum of equivalences

Given an orthogonal pair (M, O) in a category \mathcal{C} , show that any coproduct of maps in M belongs also to M .

A.5.15 Exercise

Cobase change preserves equivalences

Given an orthogonal pair (M, O) in a category \mathcal{C} , and f in M , show the following:

- (i) If $g: A \rightarrow X$ is arbitrary, then the map \bar{f} below is also in M .

$$\begin{array}{ccc} A & \xrightarrow{f} & B \\ g \downarrow & \circlearrowleft & \downarrow \bar{g} \\ X & \xrightarrow{\bar{f}} & Y \end{array}$$

- (ii) The common section s of t_1 and t_2 in the cokernel pair construction below is in M .

$$\begin{array}{ccc} A & \xrightarrow{f} & B \\ f \downarrow & \circlearrowleft & \downarrow t_1 \\ B & \xrightarrow{t_2} & D \end{array}$$

Further, if $g_1, g_2: B \rightarrow Z$ satisfy $g_1 f = g_2$, let $g: D \rightarrow Z$ be the universal map induced by the pushout. Show that

Bibliography

- [1] J. Adámek, H. Herrlich, and G. Strecker, *Abstract and concrete categories: the joy of cats*, John Wiley & Sons, New York, 1990. [7](#), [293](#), [297](#)
- [2] P. Aluffi, *Algebra: Chapter 0*, Graduate Studies in Mathematics, vol. 104, AMS, 2009. [267](#), [279](#)
- [3] M. Barr, *Exact categories*, in *Exact categories and categories of sheaves* [4], pp. 1–120. [177](#), [221](#)
- [4] M. Barr, P. A. Grillet, and D. H. van Osdol, *Exact categories and categories of sheaves*, Lecture Notes in Math., vol. 236, Springer, 1971. [iii](#), [152](#), [315](#), [325](#)
- [5] J. Bonnet and S. Dierolf, *The pullback for bornological and ultrabornological spaces*, Note Mat. **25** (2005/06), no. 1, 63–67. [284](#)
- [6] F. Borceux, *Handbook of categorical algebra*, Encyclopedia of Math. Appl., vol. 50, 51 and 52, Cambridge Univ. Press, 1994. [7](#), [267](#)
- [7] ———, *Handbook of categorical algebra 1: Basic category theory*, Encyclopedia Math. Appl., vol. 50, Cambridge Univ. Press, 1994. [293](#)
- [8] ———, *Handbook of categorical algebra 2: Categories and structures*, Encyclopedia Math. Appl., vol. 51, Cambridge Univ. Press, 1994. [293](#)
- [9] ———, *A survey of semi-abelian categories*, Galois Theory, Hopf Algebras, and Semi-abelian Categories (G. Janelidze, B. Pareigis, and W. Tholen, eds.), Fields Inst. Commun., vol. 43, Amer. Math. Soc., 2004, pp. 27–60. [84](#), [87](#), [173](#), [188](#), [191](#)
- [10] F. Borceux and D. Bourn, *Mal'cev, protomodular, homological and semi-abelian categories*, Math. Appl., vol. 566, Kluwer Acad. Publ., 2004. [iii](#), [5](#), [32](#), [56](#), [84](#), [87](#), [149](#), [159](#), [161](#), [162](#), [173](#), [177](#), [185](#), [188](#), [191](#), [196](#), [197](#), [203](#), [204](#), [208](#), [219](#), [221](#), [249](#), [325](#)
- [11] ———, *Mal'cev, protomodular, homological and semi-abelian categories*, vol. 566 of Math. Appl. [10], 2004. [216](#)

- [12] F. Borceux and M. Grandis, *Jordan-Hölder, modularity and distributivity in non-commutative algebra*, Dip. Mat. Univ. Genova **474** (2003), 34p., preprint. [10](#), [11](#)
- [13] F. Borceux, G. Janelidze, and G. M. Kelly, *Internal object actions*, Comment. Math. Univ. Carolinae **46** (2005), no. 2, 235–255. [157](#)
- [14] D. Bourn, *Normalization equivalence, kernel equivalence and affine categories*, Category Theory, Proceedings Como 1990 (A. Carboni, M. C. Pedicchio, and G. Rosolini, eds.), Lecture Notes in Math., vol. 1488, Springer, 1991, pp. 43–62. [iii](#), [159](#), [212](#), [213](#), [221](#)
- [15] ———, *Mal'cev categories and fibration of pointed objects*, Appl. Categ. Structures **4** (1996), 307–327. [196](#), [203](#), [224](#)
- [16] ———, *Normal subobjects and abelian objects in protomodular categories*, J. Algebra **228** (2000), 143–164. [32](#), [177](#), [213](#)
- [17] ———, *3×3 Lemma and protomodularity*, J. Algebra **236** (2001), 778–795. [172](#), [221](#), [224](#), [263](#)
- [18] ———, *Intrinsic centrality and associated classifying properties*, J. Algebra **256** (2002), 126–145. [196](#), [203](#)
- [19] ———, *The denormalized 3×3 lemma*, J. Pure Appl. Algebra **177** (2003), 113–129. [134](#)
- [20] D. Bourn and M. Gran, *Regular, protomodular, and abelian categories*, in Pedicchio and Tholen [[73](#)], pp. 165–211. [32](#), [204](#), [299](#), [311](#)
- [21] D. Bourn and G. Janelidze, *Protomodularity, descent, and semidirect products*, Theory Appl. Categ. **4** (1998), no. 2, 37–46. [157](#), [184](#), [224](#)
- [22] D. A. Buchsbaum, *Exact categories and duality*, Trans. Amer. Math. Soc. **80** (1955), no. 1, 1–34. [iii](#), [4](#), [267](#)
- [23] M. S. Burgin, *Categories with involution, and correspondences in γ -categories*, Trudy Moskov. Mat. Obšč. **22** (1970), 161–228. [4](#), [11](#)
- [24] A. Carboni, G. M. Kelly, and M. C. Pedicchio, *Some remarks on Maltsev and Goursat categories*, Appl. Categ. Structures **1** (1993), 385–421. [219](#)
- [25] A. Carboni, J. Lambek, and M. C. Pedicchio, *Diagram chasing in Mal'cev categories*, J. Pure Appl. Algebra **69** (1991), 271–284. [219](#)
- [26] H. Cartan and S. Eilenberg, *Homological algebra*, Princeton University Press, 1956. [3](#), [267](#)
- [27] Maria Manuel Clementino, *An invitation to topological semi-abelian algebras*, New perspectives in algebra, topology and categories. Summer school, Louvain-la-Neuve,

- Belgium, September 12–15, 2018 and September 11–14, 2019, Cham: Springer, 2021, pp. 27–66. [62](#)
- [28] Maria Manuel Clementino, Nelson Martins-Ferreira, and Andrea Montoli, *On the categorical behaviour of preordered groups*, J. Pure Appl. Algebra **223** (2019), no. 10, 4226–4245. [11](#), [162](#)
- [29] Auguste Dick, *Emmy Noether 1882–1935*, Birkhäuser, 1981. [3](#)
- [30] Jean Dieudonné, *A History of Algebraic and Differential Topology 1900–1960*, Mathematics Studies, no. 77, Birkhäuser Boston, Inc., Boston, MA, 1989. [3](#)
- [31] T. Everaert, J. Goedecke, T. Janelidze-Gray, and T. Van der Linden, *Relative Mal'tsev categories*, Theory Appl. Categ. **28** (2013), no. 29, 1002–1021. [219](#)
- [32] T. Everaert and T. Van der Linden, *Baer invariants in semi-abelian categories II: Homology*, Theory Appl. Categ. **12** (2004), no. 4, 195–224. [263](#)
- [33] P. Freyd, *Abelian categories*, Harper and Row, New York, 1964, Republished in: *Reprints in Theory and Applications of Categories*, no. 3 (2003). [267](#), [279](#), [283](#)
- [34] P. Freyd and A. Scedrov, *Categories, Allegories*, North-Holland, 1990. [10](#), [52](#), [279](#)
- [35] Peter Gabriel and Michel Zisman, *Calculus of Fractions and Homotopy Theory*, Erg. Math. Grenzgeb., vol. 35, Springer-Verlag, 1967. [320](#)
- [36] X. García-Martínez and T. Van der Linden, *A note on split extensions of bialgebras*, Forum Math. **30** (2018), no. 5, 1089–1096. [11](#), [117](#), [215](#)
- [37] M. Gerstenhaber, *A categorical setting for the Baer extension theory*, Applications of Categorical Algebra, New York 1968, Proc. Sympos. Pure Math., vol. XVII, Amer. Math. Soc., Providence, R.I., 1970, pp. 50–64. [iii](#), [221](#)
- [38] M. Gran, G. Kadjo, and J. Vercauteren, *A torsion theory in the category of cocommutative Hopf algebras*, Appl. Categ. Structures **24** (2016), no. 3, 269–282. [11](#)
- [39] Marino Gran, *An introduction to regular categories*, New perspectives in algebra, topology and categories. Summer school, Louvain-la-Neuve, Belgium, September 12–15, 2018 and September 11–14, 2019, Cham: Springer, 2021, pp. 113–145. [315](#)
- [40] Marino Gran, Florence Sterck, and Joost Vercauteren, *A semi-abelian extension of a theorem by Takeuchi*, J. Pure Appl. Algebra **223** (2019), no. 10, 4171–4190. [11](#)
- [41] M. Grandis, *Homological algebra, the interplay of homology with distributive lattices and orthodox semigroups*, World Scientific Publishing, Singapore, 2012. [10](#), [52](#)

- [42] ———, *Homological algebra, in strongly non-abelian settings*, World Scientific Publishing, Singapore, 2013. [6](#), [10](#), [11](#), [15](#), [39](#), [52](#), [68](#)
- [43] A. Grothendieck, *Sur quelques points d'algèbre homologique*, Tohoku J. Math. **9** (1957), 119–221. [iii](#), [4](#), [267](#), [279](#)
- [44] Laurent Gruson, *Complétion abélienne*, Bull. Sci. Math. (2) **90** (1966), 17–40. [5](#), [284](#)
- [45] M. Hartl and B. Loiseau, *A characterization of semi-abelian categories*, Cah. Topol. Géom. Différ. Catég. **52** (2011), no. 1, 77–80.
- [46] Peter Hilton, *A Brief, Subjective History of Homology and Homotopy Theory in This Century*, Mathematics Magazine **61** (1988), no. 5, 282–291. [56](#)
- [47] Friedrich Hirzebruch, *Emmy Noether and topology*, The heritage of Emmy Noether. Proceedings of the conference, Bar-Ilan University, Ramat-Gan, Israel, December 2–3, 1996, Ramat-Gan: Bar-Ilan Univ., The Emmy Noether Research Institute of Mathematics, 1999, pp. 57–65. [3](#)
- [48] Fridolin Hofmann, *Über eine die Kategorie der Gruppen umfassende Kategorie*, Bayerische Akademie der Wissenschaften (1960), 163–204. [209](#), [210](#), [211](#)
- [49] S. A. Huq, *Commutator, nilpotency and solvability in categories*, Q. J. Math. **19** (1968), no. 2, 363–389. [iii](#), [196](#), [203](#), [221](#), [224](#)
- [50] Witold Hurewicz, *On duality theorems (abstract)*, Bulletin of The American Mathematical Society **47** (1941), no. 7, 562–563. [56](#)
- [51] G. Janelidze, L. Márki, and W. Tholen, *Semi-abelian categories*, J. Pure Appl. Algebra **168** (2002), no. 2–3, 367–386. [iii](#), [4](#), [209](#), [221](#), [224](#), [283](#)
- [52] G. Janelidze, L. Márki, and A. Ursini, *Ideals and clots in pointed regular categories*, Appl. Categ. Structures **17** (2009), 345–350. [157](#)
- [53] G. Janelidze, M. Sobral, and W. Tholen, *Beyond Barr exactness: Effective descent morphisms*, in Pedicchio and Tholen [73], pp. 359–405. [173](#), [188](#)
- [54] Z. Janelidze, *Subtractive categories*, Appl. Categ. Structures **13** (2005), 343–350. [152](#), [157](#)
- [55] ———, *The pointed subobject functor, 3×3 lemmas, and subtractivity of spans*, Theory Appl. Categ. **23** (2010), no. 11, 221–242. [65](#), [139](#), [140](#), [142](#), [151](#), [157](#)
- [56] J. L. Kelley and E. Pitcher, *Exact homomorphism sequences in homology theory*, Annals of Mathematics. Second Series **48** (1947), 682–709. [56](#)

- [57] Stephen Lack, *Non-canonical isomorphisms*, Journal of Pure and Applied Algebra **216** (2012), no. 3, 593–597. [257](#)
- [58] Jean Leray, *L'anneau d'homologie d'une représentation*, C. R. Acad. Sci. Paris **222** (1946), 1366–1368. [267](#)
- [59] ———, *Structure de l'anneau d'homologie d'une représentation*, C. R. Acad. Sci. Paris **222** (1946), 1419–1422. [267](#)
- [60] J.-L. Loday, *Spaces with finitely many non-trivial homotopy groups*, J. Pure Appl. Algebra **24** (1982), 179–202. [11](#)
- [61] S. Mac Lane, *Duality for groups*, Bull. Amer. Math. Soc. **56** (1950), 485–516. [4](#), [267](#)
- [62] ———, *Homology*, Grundlehren math. Wiss., vol. 114, Springer, 1995. [190](#)
- [63] ———, *Categories for the working mathematician*, second ed., Grad. Texts in Math., vol. 5, Springer, 1998. [7](#), [20](#), [38](#), [240](#), [293](#), [297](#), [300](#), [317](#)
- [64] A. I. Mal'cev, *On the general theory of algebraic systems*, Mat. Sbornik N. S. **35** (1954), no. 6, 3–20. [217](#), [219](#)
- [65] S. Mantovani and G. Metere, *Normalities and commutators*, J. Algebra **324** (2010), no. 9, 2568–2588. [157](#)
- [66] N. Martins-Ferreira, *Low-dimensional internal categorical structures in weakly Mal'cev sesquicategories*, Ph.D. thesis, University of Cape Town, 2008. [203](#)
- [67] B. Mitchell, *Theory of Categories*, Academic Press, 1965. [139](#)
- [68] R. K. Molnar, *Semi-direct products of Hopf algebras*, J. Algebra **47** (1977), 29–51. [215](#)
- [69] Susan Montgomery, *Hopf algebras and their actions on rings*, CBMS Regional Conference Series in Mathematics, vol. 82, Conference Board of the Mathematical Sciences, Washington, DC; by the American Mathematical Society, Providence, RI, 1993. [117](#)
- [70] G. Orzech, *Obstruction theory in algebraic categories I and II*, J. Pure Appl. Algebra **2** (1972), 287–314 and 315–340. [iii](#), [11](#), [221](#)
- [71] V.P. Palamodov, *The projective limit functor in the category of linear topological spaces*, Math. Sb. (N.S.) **75** (117) (1968), no. 4, 567 – 603, English translation: Math. USSR, no. 1, 529–559. [5](#), [284](#)
- [72] ———, *Homological methods in the theory of locally convex spaces*, Usp. Mat. Nauk. **26** (1971), no. 1, 3 – 65, English translation: Russ. Math. Surv. 26 no. 1 (1971) 1–64. [5](#), [284](#)

- [73] M. C. Pedicchio and W. Tholen (eds.), *Categorical foundations: Special topics in order, topology, algebra and sheaf theory*, Encyclopedia of Math. Appl., vol. 97, Cambridge Univ. Press, 2004. [326](#), [328](#)
- [74] H. Poincaré, *Analysis Situs*, Journal de l'École Polytechnique **1** (1895), 1–121. [3](#)
- [75] D. G. Quillen, *Homotopical algebra*, Lecture Notes in Math., vol. 43, Springer, 1967. [iii](#), [4](#), [311](#)
- [76] D. A. Raïkov, *Semi-abelian categories*, Dokl. Akad. Nauk SSSR **188** (1969), no. 5, 1006–1009. [5](#), [284](#)
- [77] Jiří Rosický and Walter Tholen, *Factorization, fibration and torsion*, J. Homotopy Relat. Struct. **2** (2007), no. 2, 295–314. [5](#), [11](#), [281](#)
- [78] W. Rump, *Almost abelian categories*, Cah. Topol. Géom. Différ. Catég. **XLII** (2001), 163–225. [5](#), [11](#), [280](#), [281](#), [283](#), [284](#)
- [79] Wolfgang Rump, *A counterexample to Raïkov's conjecture*, Bull. Lond. Math. Soc. **40** (2008), no. 6, 985–994. [5](#), [284](#)
- [80] Jean-Pierre Schneiders, *Quasi-abelian categories and sheaves*, Mém. Soc. Math. Fr. (N.S.) (1999), no. 76, vi+134. [5](#), [280](#)
- [81] T. Van der Linden, *Simplicial homotopy in semi-abelian categories*, J. K-Theory **4** (2009), no. 2, 379–390. [134](#)
- [82] Ch. A. Weibel, *An introduction to homological algebra*, Cambridge Stud. Adv. Math., vol. 38, Cambridge Univ. Press, 1994. [3](#)
- [83] _____, *An introduction to homological algebra*, Cambridge Stud. Adv. Math., vol. 38, Cambridge Univ. Press, 1994. [267](#), [279](#)
- [84] N. Yoneda, *On Ext and exact sequences*, J. Fac. Sci. Univ. Tokyo **1** (1960), no. 8, 507–576. [5](#), [280](#)

Index

- (3×3)-Lemma, 191
- (3×3)-Lemma
 - border cases, 122
- (3×3)-diagram, 71
- 1-point union of pointed sets, 25
- 5-Lemma, 64, 118, 186
 - easy, 186
- Set_{*}
 - co-semiabelian, 225
 - not p-exact, 225
- n -fold extension, 135
- z-exact category, 34
- 'old = new', 224

- abelian
 - category, 279
 - varieties of algebras, 283
- abelian category, 270
 - if and only if p-exact and additive, 282
 - if and only if p-exact and diexact, 282
 - is semiabelian, 280
- abelian group object
 - antidiagonal, 208
- absolute
 - diagram property, 300
 - epimorphism, 140, 300
- absolute epimorphism
 - + monomorphism is isomorphism, 303
- additive
 - category, 269
- additive category
 - satisfies (KSG)-condition, 275

- almost
 - abelian categories - examples, 281, 283
- almost abelian category, 281
- antidiagonal, 208
- antinormal
 - (de)composition, 72
 - decomposition in abelian category, 82
 - morphism, 72
 - pair, 72
- arrow
 - category, 44

- Barr exact
 - Grp, 237
- Barr exact category, 262
- base change, 295
 - along normal epi preserves/reflects (normal) monos, 171
 - preserves isomorphism, 298
 - preserves monomorphisms, 298
 - preserves surjective function, 298
 - reflects isomorphisms, 187
- bicomplete category, 294
- biproduct
 - in linear category, 254
 - in pointed category, 251
 - in preadditive category, 271
 - recognition, 190
- boundary operator of a chain complex, 92

- category
 - (finitely) bicomplete, 294

- (finitely) cocomplete, 294
- (finitely) complete, 294
- abelian, 270
- additive, 269
- almost abelian, 281
- Barr exact, 262
- di-exact, 74, 75, 270
- discrete, 294
- finite, 293
- homological, 161, 223
- linear, 253
- Mal'tsev, 217
- normal, 140, 152
- of arrows, 44
- of morphisms, 44
- of sectioned epis over R , 212
- of split epimorphisms, 183
- p-exact, 270
- pointed, 21
- preabelian, 269, 277
- preadditive, 269
- quasi abelian, 281
- regular, 315
- semiabelian, 223
- small, 293
- Z. Janelidze-normal, 152
- central
 - morphism, 198
- chain complex, 92
 - boundary operator, 92
 - cosubnormal, 93
 - differential, 92
 - morphism, 98
 - normal, 93
 - subnormal, 93
 - weakly normal, 93
- closed symmetric monoidal
 - structure in Set_* , 26
- co-semiabelian category
 - Set_* , 225
- cobase change, 296, 297
 - preserves epimorphisms, 299
 - preserves extremal epimorphisms, 147
 - preserves isomorphism, 299
 - preserves regular epimorphisms, 147
 - preserves strong epimorphisms, 147
- cocomplete category, 294
- coequalizer
 - in additive category, 276
 - reflexive, 238
- coimage
 - in a normal mono factorization, 47
- cokernel, 29
 - of $0 \rightarrow X$, 33
 - of a composite of maps, 37
 - of an epimorphism, 33
 - of sum of maps, 38
 - same as extremal epimorphism, 145
 - same as strong epimorphism, 145
- colimit
 - in $\text{NE}(\mathcal{X})$, 51
 - in $\text{NM}(\mathcal{X})$, 51
 - in Set_* , 26
 - in Top , 28
 - in Top_* , 28
- commutating
 - morphisms, 197
- commutative
 - internal magma/monoid/group, 244
 - object, 199
- commuting
 - subobjects, 200
- complete category, 294
- composite
 - of normal epimorphisms, 146
- connecting map
 - in Snake Lemma, 86
- conservative
 - functor, 213
- coproduct

- as colimit of discrete diagram, [294](#)
- coproduct/product comparison map, [169](#)
- cosubnormal
 - chain complex, [93](#)
 - morphism, [50](#)
- cover
 - of Q by K , [54](#)
- di-exact category, [74](#), [75](#), [270](#)
 - equivalent siblings, [128](#)
- di-extension, [71](#)
 - from normal antinormal pairs, [73](#)
- di-extensive
 - normal pullback, [121](#)
 - normal pushout, [121](#)
 - pullback, [127](#), [133](#)
 - pushout, [127](#)
 - pushout in $\mathbf{-H}$, [179](#)
- diagram, [300](#)
 - with absolute property, [300](#)
- difference
 - object, [153](#)
 - object in \mathbf{Ab} , [153](#)
- differential of a chain complex, [92](#)
- dinversion, [73](#)
- direct image
 - of a relation under a normal epimorphism, [265](#)
- discrete
 - category, [294](#)
 - relation, [259](#)
- effective
 - epimorphism, [307](#)
 - epimorphism - Hom-view, [311](#)
 - equivalence relation, [262](#)
 - equivalence relation: properties, [263](#)
- epic morphism, [19](#)
- epimorphism, [19](#)
 - absolute, [140](#), [300](#)
 - effective, [307](#)
 - extremal, [305](#), [306](#)
 - is preserved by pushout, [299](#)
 - normal, [30](#)
 - properties, [20](#)
 - regular, [307](#)
 - split, [300](#)
 - strong, [307](#), [309](#)
 - via pushout property, [309](#)
- equalizer
 - in additive category, [276](#)
- equivalence
 - of a reflector, [319](#)
- equivalence relation, [260](#)
 - given by kernel pair, [260](#)
- equivalent
 - extensions, [189](#)
 - monomorphisms, [20](#)
- exact
 - diagram of sets, [310](#)
 - node recognize, [55](#)
 - sequence, [55](#)
 - short exact, [55](#)
- exactness
 - of product of short exact sequence , [195](#)
- extension, [189](#)
 - di-, [71](#)
 - morphism, [189](#)
 - of K by Q , [54](#)
- extremal epimorphism, [305](#), [306](#)
 - same as cokernel, [145](#)
 - same as strong epimorphism, [145](#)
- finite
 - (co-)limit, [294](#)
 - category, [293](#)
- finitely
 - bicomplete category, [294](#)
 - cocomplete category, [294](#)

- complete category, 294
- formal difference
 - of two morphisms, 154
- functor
 - conservative, 213
- graph, 258
 - internal, 258
- group, 244, 245
- higher extension, 135
- homological
 - category, 161
 - category satisfies (DPN), 179
 - self-duality, 111
- homological category, 223
 - is Mal'tsev category, 219
 - torsion-free abelian groups, 163
 - torsion-free groups, 163
- homology
 - functorial, 99
- HSD
 - property of normal category, 142
- image
 - factorization, 315
 - factorization in a normal category, 143
 - factorization: strong epi/mono, 310
 - in a normal epi factorization, 47
 - of a morphism, 315
 - of a morphism in a normal category, 143
- image factorization, 143
- indiscrete
 - relation, 260
- initial
 - normal mono decomposition, 46
 - object, 21
- internal
 - abelian group structure, 204
 - graph from X to Y , 258
 - group, 244
 - magma, 244
 - monoid, 244
 - relation from X to Y , 258
 - unitary magma, 244
 - unitary magma structure, 204
- internal group
 - inverse operation $i^2 = 1$, 248
- intersection
 - of normal subobjects, 42
 - of subobjects, 18
 - of subobjects: existence, 299
- inverse map
 - of internal group, 244
- inversion
 - normal subobjects / quotient objects, 34
- isomorphism
 - recognition, 36
 - recognition in abelian category, 280
- Isomorphism Theorem
 - condition for Third, 111, 113
 - Second, 234
 - Third, 38, 195
- join
 - of (normal) subobjects in \mathbb{N} , 257
 - of subobjects: construction, 19, 232
 - of subobjects: definition, 19
- jointly
 - epimorphic family of maps, 19
 - extremal-epimorphic family of maps, 197, 306
 - monomorphic family - from limit cone, 298
 - monomorphic family - product description, 298
 - monomorphic family of maps, 17
- kernel, 29

- composition, 32
- is monomorphism, 32
- of a composite of maps, 36
- of monomorphism: 0., 35
- of product of maps, 38
- pair of a morphism, 296
- kernel pair
 - equivalence relation, 260
- KSG
 - in additive categories, 275
- lattice
 - modular, 236
- left
 - almost abelian category, 280
 - orthogonal, 148, 312
 - orthogonal complement, 148, 312
 - quasi-abelian category, 280
- limit
 - in $\text{NE}(\mathcal{X})$, 51
 - in $\text{NM}(\mathcal{X})$, 51
 - in Top , 28
 - in Top_* , 28
- linear
 - category, 184
- linear category, 253
- local
 - object w.r. to a reflector, 319
- long exact homology sequence, 102
- long exact sequence, 56
- magma, 245
- Mal'tsev category, 217
- meet
 - of normal subobjects, 42
 - of subobjects: construction, 19
 - of subobjects: definition, 18
 - of subobjects: existence, 299
- modular lattice, 236
- monic morphism, 17
- monoid, 244, 245
- monomorphism, 17
 - is preserved by pullback, 298
 - normal, 30
 - properties, 20
 - recognition by 0-kernel, 142
 - recognition by 0-kernel, 141
 - recognition in map of exact sequences, 173
 - retractable, 301
 - via limit property, 309
- morphism
 - central, 198
 - cosubnormal, 50
 - in $\text{SEpi}_R(\mathcal{X})$, 213
 - normal, 48
 - of chain complexes, 98
 - of extensions, 189
 - of internal magma/monoid/group, 249
 - of zero maps - factorization, 57
 - retractable, 301
 - split, 300
 - split short exact sequences, 164
 - subnormal, 50
 - zero, 21
- multiplication
 - of f by g , 197
- nilpotent
 - group via cosubnormal factorization, 53
- normal
 - map preserved by normal images, 78
 - category, 140, 152
 - category - homologically self-dual, 142
 - chain complex, 93
 - closure - existence, 43
 - closure of a subobject, 42
 - epi decomposition, 45
 - epi decomposition of order r , 52

- epi decomposition, terminal, 46
- epi factorization, 46
- epi from project projection, 257
- epimorphism, 30
 - in short exact sequence, 176
- epimorphism - composite, 146
- epimorphism - product, 146
- epimorphism - properties, 146
- epimorphism - recognition, 182
- epimorphism in $\text{NE}(\mathcal{X})$, 51
- epimorphism in Set_* , 34
- factorization, 48
- factorization - recognize, 48
- factorization, recognize, 46
- images preserve normal monos / epis, 124
- map, 48
- map factored through epic map, 49
- map factored through monic map, 48
- map in morphism of short exact sequences, 180
- mono decomposition, 45
- mono decomposition of order r , 52
- mono decomposition, initial, 46
- mono factorization, 46
- monomorphism, 30
- monomorphism in $\text{NM}(\mathcal{X})$, 51
- monomorphism in Set_* , 34
- monomorphism in morphisms of SESs, 177
- monomorphism: properties, 36
- pullback, 134
- pullback in CMon , 257
- pullback in Grp , 134
- pushout, 131
- pushout recognition, 183
- subobject, 30
- subobject of \mathbb{N} , 257
- subtractive category, 155
- normal epimorphism, 15
 - given by $\langle 1, 0 \rangle: X + Y \rightarrow X$, 38
- normal monomorphism, 15
 - given by $(1, 0): X \rightarrow X \times Y$, 38
- normal pullback, 131
 - di-extensive, 121
- normal pushout, 131
 - di-extensive, 121
- normal subobject / quotient object inversion, 34
- object
 - commutative, 199
 - initial, 21
 - terminal, 21
 - zero, 21
- OFS, 148, 313
- OPFS - orthogonal prefactorization system, 312
- opposite
 - relation, 259
- orthogonal, 318
 - complement, 148, 312
 - factorization system, 148, 313
 - pair, 319
 - prefactorization system, 312
- orthogonal complement
 - of a class of morphisms, 319
 - of a class of objects, 319
- p-exact category, 126, 270
- Palamodov
 - semiabelian category, 284
- pointed
 - category, 21
- preabelian category, 269, 277
 - recognize, 277
- preadditive category, 269
 - need not be pointed, 272
- product
 - as limit of discrete diagram, 294

- as pullback, [23](#)
 - of normal epimorphisms, [146](#)
 - of short exact sequences, [146](#), [195](#)
 - projection is normal epi, [257](#)
 - recognition, [167](#)
 - recognition via kernel splitting, [187](#)
- proper
 - morphism, [48](#)
- pullback, [133](#), [295](#)
 - along normal epi preserves/reflects (normal) monos, [171](#)
 - cancellation, [295](#)
 - cancellation 2-out-of-3, [173](#), [188](#)
 - composition, [295](#)
 - concatenated squares, [295](#)
 - construction of product, [23](#)
 - di-extensive, [127](#)
 - normal, [131](#)
 - preserves monomorphism, [298](#)
 - recognition by kernel isomorphism, [175](#)
 - recognition, kernel side I, [40](#)
 - recognition: kernel side II, [172](#)
 - sectioned epimorphism, [302](#)
 - seminormal, [131](#)
- Puppe
 - exact category, [126](#)
- pure snake
 - condition, [111](#)
- pushout
 - cancellation, [297](#)
 - concatenated squares, [297](#)
 - di-extensive, [127](#)
 - isomorphic cokernels, [41](#)
 - normal, [131](#)
 - of a sectioned monomorphism, [302](#)
 - of normal epimorphisms, [43](#)
 - preserves epimorphism, [299](#)
 - recognition - cokernel side, [41](#)
 - recognition II, [183](#)
 - seminormal, [131](#), [132](#)
- quasi-abelian category, [281](#)
- quotient
 - object, [20](#)
- Raïkov
 - semiabelian category, [284](#)
- reflective subcategory, [317](#)
- reflector, [317](#)
- reflexive coequalizer, [238](#)
- reflexive relation, [259](#)
- regular
 - category, [315](#)
 - epimorphism, [307](#)
 - pushout, [227](#)
- relation, [258](#)
 - discrete, [259](#)
 - from X to Y , [258](#)
 - indiscrete, [260](#)
 - on X , [258](#)
 - opposite, [259](#)
 - reflexive, [259](#)
 - symmetric, [259](#)
 - transitive, [260](#)
- retractable
 - monomorphism, [301](#)
- retractable monomorphism, [301](#)
- right
 - almost abelian category, [280](#)
 - orthogonal, [148](#), [312](#)
 - orthogonal complement, [148](#), [312](#)
 - quasi-abelian category, [280](#)
- Second Isomorphism Theorem, [234](#)
- section, [300](#)
- sectionable
 - epimorphism, [300](#)
 - epimorphism is epimorphism, [303](#)
 - morphism, [300](#)
- sectioned epimorphism

- + monomorphism is isomorphism, 303
- semiabelian category, 223
 - in sense of Palamodov, 284
 - in sense of Raïkov, 284
 - is Barr-exact, 238
 - is Mal'tsev category, 238
- seminormal
 - pullback, 131, 133
 - pushout, 131, 132
 - pushout - pullback stability, 179
 - pushout and HSD, 132, 133
 - pushout recognition, 178
- seminormal pushout
 - recognition II, 183
- sequence
 - short exact, 54
- Short 5-Lemma, 64, 117, 185
- short exact sequence, 54, 55
 - in Set_* , 57
 - of chain complexes, 100
 - product, 146
- small
 - category, 293
- smash product
 - in Set_* , 26
- snake
 - map/morphism, 86
- Snake Lemma
 - classical - conditionally extensive cats, 84
 - classical in (DPN)-normal cat, 149
 - pure version, 83
 - pure version, relaxed, 90
 - relaxed version, 87
 - strong relaxed version, 106
- split
 - monomorphism in Set_* , 27
 - short exact sequence, 140
 - short exact sequence - morphism, 164
 - short exact sequence from split epi - \mathbb{N} , 141
- splitting, 300
- strong epimorphism, 307, 309
 - same as cokernel, 145
 - same as extremal epimorphism, 145
- subnormal
 - chain complex, 93
 - epi decomposition, 50
 - mono decomposition, 50
 - morphism, 50
- subobject, 17
 - in Set , 18
 - in Top , 18, 28
 - in Top_* , 28
 - normal closure, 42
 - of \mathbb{N} , 257
- subobjects
 - intersection: existence, 299
 - intersections, 18
 - join, 19
 - meet, 18
 - meet: existence, 299
 - union, 19
- subtractive
 - normal category, 155
 - variety, 126, 142
- sum
 - of short exact sequences, 177
- sum/product comparison map, 169
- symmetric
 - relation, 259
- terminal
 - normal epi decomposition, 46
 - object, 21
- Third Isomorphism Theorem, 195
- topological
 - monoids, 126
 - variety, 126

- torsion-free
 - abelian groups form homological cat, [163](#)
 - groups form homological cat, [163](#)
- totally
 - normal sequence of epimorphisms, [108](#)
 - normal sequence of monomorphisms, [108](#)
- transitive relation, [260](#)
- twist map, [244](#)

- union
 - of subobjects, [19](#)
- universal property
 - pullback, [295](#)

- variety
 - subtractive, [142](#)

- weakly normal chain complex, [93](#)
- wedge in Set_* , [25](#)

- Z. Janelidze-normal category, [152](#)
- zero
 - morphism, [21](#)
 - object, [21](#)

Index

- a
- $\text{ANP}(\mathcal{X})$ category of antinormal pairs in \mathcal{X} , 76
 - $\text{Arr}(\mathcal{X})$ category of morphisms in \mathcal{X} , 44
- b
- $X \oplus Y$ biproduct of X and Y , 251
- c
- (C, d^C) chain complex C with differential d^C , 92
 - CHTop category of compact Hausdorff spaces, 18
 - $\text{coI}(f)$ codomain of coimage map of f , 47
 - $\text{coim}(f)$ coimage map of f , 47
 - $Q(f)$ cokernel object of f , 29
 - $\text{coker}(f)$ cokernel of f , 29
 - $\text{colim}^J(F)$ colimit of functor $F: J \rightarrow \mathcal{X}$, 294
 - $\coprod_{j \in J} F(j)$ coproduct over discrete category J , 294
 - $\gamma_{A,B}$ comparison map $A + B \rightarrow A \times B$, 169
 - $\bigvee_{k \in K} (X_k, x_k)$ wedge/coproduct in Set_* , 25
- d
- $D(X)$ difference object of X , 153
 - $\text{DEx}(\mathcal{X})$ category of di-extensions in \mathcal{X} , 76
 - $f - g$ formal difference of morphisms, 154
- e
- $Y \twoheadrightarrow Z$ epimorphism, 19
 - $\text{ext}(V, K)$ equivalence classes of extensions, 189
 - $\text{Ex}^n(\mathcal{X})$ category of n -fold extensions in \mathcal{X} , 135
 - $EM(f)$ normal epi / normal mono factorization comparison map, 46
- g

Grp	category of groups, 22
h	
$H_n^c C$	cokernel construction of homology, 94
$H_n^k C$	kernel construction of homology, 95
i	
$M \wedge N$	intersection/meet of M and N , 18
$I(f)$	domain of image map of f , 47
$im(f)$	image map of f , 47
j	
$M \vee N$	join/union of subobjects M and N , 19
$M \wedge N$	intersection/meet of M and N , 42
k	
$K(f)$	kernel object of f , 29
$ker(f)$	kernel of f , 29
$KP(f)$	kernel pair of f , 296
l	
$lim_J(F)$	limit of functor $F: J \rightarrow \mathcal{X}$, 293
m	
$M \wedge N$	intersection/meet of M and N , 18 , 42
$X \hookrightarrow Y$	monomorphism, 17
Mag	category of unitary magmas, 245
n	
$K \triangleleft X$	K is normal subobject of X , 30
$NE(\mathcal{X})$	category of normal epimorphisms in \mathcal{X} , 44 , 58 , 114
$NM(\mathcal{X})$	category of normal monomorphisms in \mathcal{X} , 44 , 58 , 114
$NQuo(X)$	category of normal quotient objects of object X , 34
$NSub(X)$	category of normal subobjects of object X , 34
$\kappa: K \hookrightarrow X$	κ is normal monomorphism, 30
$\pi: Y \twoheadrightarrow Q$	π is normal epimorphism, 30
p	
$\prod_{j \in J} F(j)$	product over discrete category J , 294
$(f, g): A \rightarrow X \times Y$	universal map into a product, 294
$\mathcal{P}(X)$	power set of set X , 18
$f^* \varepsilon$	pullback of short exact sequence ε along f , 170

r

Rng category of rings with or without unit, 22
 $(m \uparrow r)$ mono m retracted by r , 301
URng category of unital rings, 22
 aRb a is related to b , 258

s

$(X, x_0) \wedge (Y, y_0)$ smash of pointed sets, 26
 $M \leq X$ M is subobject of X , 17
SES(\mathcal{X}) category of short exact sequences in \mathcal{X} , 58, 114, 230
SEpi(\mathcal{X}) category of sectioned morphisms in \mathcal{X} , 301
SEpi $_R$ (\mathcal{X}) category of sectioned epis in \mathcal{X} over R , 212
SSES(\mathcal{X}) category of split short exact sequences, 164
 $(q \downarrow x)$ map q sectioned by x , 300
Set category of sets, 23
Set $_*$ category of sets with base point, 22, 23
Sub(X) class of subobjects of X , 17
 $\langle u, v \rangle: X + Y \rightarrow Z$ universal map out of a coproduct / sum, 295

t

Top category of topological spaces, 18

u

$M \vee N$ join/union of subobjects M and N , 19

w

$\bigvee_{k \in K} (X_k, x_k)$ wedge/coproduct in Set $_*$, 25

z

\mathbb{Z} number system of integers, 22, 93
 0_{YX} zero morphism from X into Y , 21
 0 zero object, 21

Index

- a
 - ANK exercise asking a question whose answer we do not know, 63
 - (AEN) condition that absolute epimorphisms are normal maps, 140
 - (ANN) property that antinormal maps are normal, 75, 223
- d
 - (DPN) property that dinversion preserves normal maps, 75, 179
 - DE_x category in which antinormal composites are normal, 74
 - DPN category in which dinversion preserves normal maps, 75
- h
 - (HSD) homological self-duality property, 75
 - H homological category, 161
- k
 - (KSG) for $q: X \rightarrow Q$ sectioned by x , images of x and $\ker(q)$ generate X , 161, 223
- n
 - N normal category, 140
- p
 - (PNE) condition that pullbacks preserve normal epimorphisms, 140, 161
- s
 - SA semiabelian category, 223
- z
 - z-Ex z-exact category, 34