

# Retrieval-Augmented Generation for AI-Generated Content: A Survey

Penghao Zhao, Hailin Zhang, Qinhan Yu, Zhengren Wang, Yunteng Geng, Fangcheng Fu, Ling Yang, Wentao Zhang, Bin Cui, *Fellow, IEEE*

**Abstract**—The development of Artificial Intelligence Generated Content (AIGC) has been facilitated by advancements in model algorithms, scalable foundation model architectures, and the availability of ample high-quality datasets. While AIGC has achieved remarkable performance, it still faces challenges, such as the difficulty of maintaining up-to-date and long-tail knowledge, the risk of data leakage, and the high costs associated with training and inference. Retrieval-Augmented Generation (RAG) has recently emerged as a paradigm to address such challenges. In particular, RAG introduces the information retrieval process, which enhances AIGC results by retrieving relevant objects from available data stores, leading to greater accuracy and robustness. In this paper, we comprehensively review existing efforts that integrate RAG technique into AIGC scenarios. We first classify RAG foundations according to how the retriever augments the generator. We distill the fundamental abstractions of the augmentation methodologies for various retrievers and generators. This unified perspective encompasses all RAG scenarios, illuminating advancements and pivotal technologies that help with potential future progress. We also summarize additional enhancements methods for RAG, facilitating effective engineering and implementation of RAG systems. Then from another view, we survey on practical applications of RAG across different modalities and tasks, offering valuable references for researchers and practitioners. Furthermore, we introduce the benchmarks for RAG, discuss the limitations of current RAG systems, and suggest potential directions for future research. Project Repo: <https://github.com/hymie122/RAG-Survey>.

**Index Terms**—Retrieval-augmented generation, AI-generated content, generative models, information retrieval.

## I. INTRODUCTION

### A. Background

RECENT years have witnessed a surge in interest surrounding Artificial Intelligence Generated Content (AIGC). Various content generation tools have been meticulously crafted to produce diverse objects across various modalities, such as Large Language Models (LLM) including the GPT series [1]–[3] and the LLAMA series [4]–[6] for texts and codes, DALL-E [7]–[9] and Stable Diffusion [10] for images, and Sora [11] for videos. The word “AIGC” emphasizes that the contents are produced by advanced generative models other than human beings or rule-based approaches. These generative models have achieved remarkable performance

due to their utilization of novel model algorithms, expansive foundation model architectures, and massive high-quality datasets. Specifically, sequence-to-sequence tasks have transitioned from utilizing Long Short-Term Memory (LSTM) [12] networks to Transformer-based models [13], while image-generation tasks have shifted from Generative Adversarial Networks (GAN) [14] to latent diffusion models [10]. Notably, the architecture of foundation models, initially constituted by millions of parameters [15], [16], has now grown to incorporate billions of parameters [1], [4]. These advancements are further bolstered by the availability of rich, high-quality datasets [1], [17], which provide ample training examples to fully optimize model parameters.

Information retrieval is another pivotal application within the field of computer science. Different from generation, retrieval aims to locate relevant existing objects from a vast pool of resources. The most prevalent application of retrieval lies in web search engines, which primarily focus on the task of document retrieval [18], [19]. In the present era, efficient information retrieval systems can handle document collections on the order of billions [20], [21]. Besides documents, retrieval has also been applied for other modalities [22]–[25].

Despite the remarkable progress made by advanced generative models, AIGC continues to face a number of well-known challenges, including the struggle to maintain up-to-date knowledge, the inability to incorporate long-tail knowledge [26], and the risk of leaking private training data [27]. Retrieval-Augmented Generation (RAG) is proposed to alleviate, if not completely address, the aforementioned challenges through its adaptable data repository. The knowledge stored for retrieval can be conceptualized as non-parametric memory. Such a form of memory is easily modifiable, capable of accommodating broad long-tail knowledge, and also able to encode confidential data. In addition, retrieval can also be employed to reduce the generation costs. For example, RAG can reduce the size of large generative models [28], provide support for long contexts [29], and eliminate certain generation steps [30].

A typical RAG process is shown in Fig. 1: given an input query, the retriever locates and looks up relevant data sources, then the retrieved results interact with the generator to enhance the overall generation process. The retrieval results can interact with the generation process in different ways: they can serve as augmented input to the generator [31], [32]; they can join at the middle stage of generation as latent representations [33], [34]; they can contribute to the final generation results in the form of logits [35], [36]; they can even influence or omit

• Penghao Zhao and Hailin Zhang contributed equally to this paper.

• Penghao Zhao, Hailin Zhang, Qinhan Yu, Zhengren Wang, Yunteng Geng, Fangcheng Fu, Ling Yang, Wentao Zhang and Bin Cui are with Peking University (e-mail: penghao.zhao@stu.pku.edu.cn, z.hl@pku.edu.cn, yuqinhan@stu.pku.edu.cn, wzr@stu.pku.edu.cn, 1800012997@pku.edu.cn, ccchengff@pku.edu.cn, yangling0818@163.com, wentao.zhang@pku.edu.cn, bin.cui@pku.edu.cn).

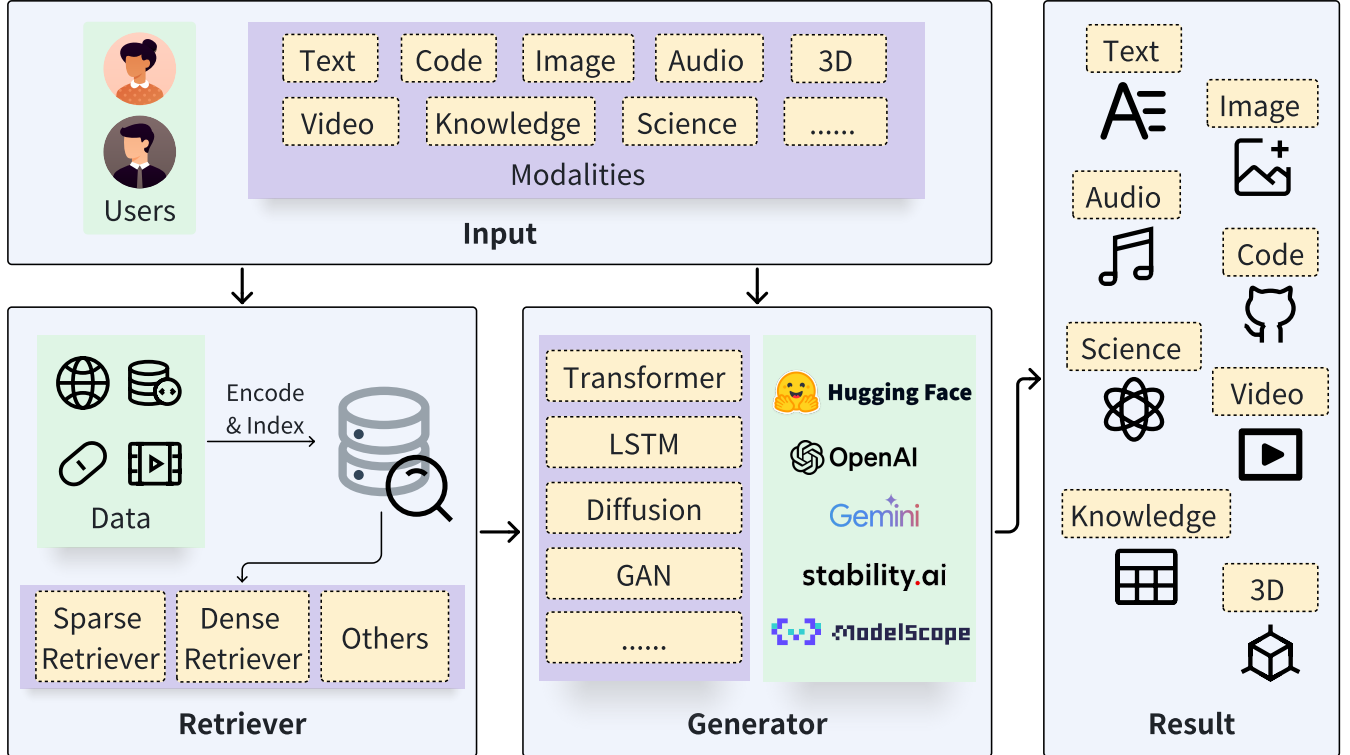

Fig. 1. A generic RAG architecture. The users’ queries, which may be different modality, serve as input to both the retriever and the generator. The retriever searches for relevant data sources in storage, while the generator interacts with the retrieval results and ultimately produces results of various modalities.

certain generation steps [30], [37]. Moreover, built upon the typical, foundational RAG process, numerous enhancements have also been proposed to improve the overall quality. These enhancements encompass methods for specific components as well as optimizations targeting the entire pipeline.

Although the concept of RAG initially emerged in text-to-text generation [32], it has also been adapted to various domains, including codes [38]–[40], audios [41], [42], images [43]–[45], videos [46], [47], 3D [48], [49], knowledge [50]–[52], and AI for science [53], [54]. In particular, the essential idea and process of RAG are largely consistent across modalities. However, it necessitates specific minor adjustments in augmentation techniques, and the selection of retrievers and generators varies depending on the specific modalities and tasks.

Despite recent rapid growth in research on RAG, a systematic review encompassing all foundations, enhancements, and applications is notably absent. The absence of discussion on RAG foundations significantly undermines the practical value of research in this domain, leaving the potential of RAG not fully explored. While the majority of research interest, particularly among LLM researchers, centers on query-based RAG in text-generation tasks, it is essential to acknowledge that other RAG foundation paradigms are also effective techniques with significant potential for usage and further development. The lack of an overview on RAG applications causes researchers and practitioners to overlook RAG’s progress across multiple modalities and remain unaware of how RAG can be effectively

applied. Although text generation is typically considered as the main application of RAG, we emphasize that the development of RAG in other modalities also began at an early stage and has yielded promising advancements. Certain modalities have a rich historical connection to the retrieval technique, infusing RAG with distinctive characteristics. Despite that some surveys on RAG have already been proposed, they mainly focus on partial aspects, such as specific methodologies and tasks. In this paper, our objective is to present a comprehensive survey to provide a systematic overview of RAG.

## B. Contribution

This survey offers a comprehensive overview of RAG, covering foundations, enhancements, applications, benchmarks, limitations, and potential future directions. While retrievers and generators exhibit variations across modalities and tasks, we distill the fundamental abstractions of RAG foundations, considering applications as adaptations stemming from these abstractions. We aim to offer references and guidelines to researchers and practitioners, providing valuable insights for advancing RAG methodologies and related applications. In summary, we list our contributions as follows:

- We conduct a comprehensive review of RAG, and distill the abstractions of RAG foundations for various retrievers and generators.
- We conclude the enhancements on existing RAG pipeline, elaborating the techniques leveraged to enable more effective RAG systems.

- For various modalities and tasks, we survey existing AIGC methods that incorporate RAG techniques, exhibiting how RAG contributes to current generative models.
- We discuss the limitations and promising research directions of RAG, shedding light on its potential future development.

### C. Related Work

With the advancement of research on RAG, several survey papers focusing on RAG have been proposed. Li et al. [55] conducted survey on RAG for text generation. Since it reviews papers up to 2022, many new advancements of RAG for AIGC are not included. Asai et al. [56] delivered a tutorial on retrieval-based language models, introducing the architectures and training paradigms. Gao et al. [57] surveyed RAG for LLMs, especially investigating the enhancements on query-based RAG. The above surveys primarily consider RAG for text-related tasks that are facilitated by LLMs, leaving other modalities as potential extensions. However, the concept of RAG emerges across all modalities at an early stage, making it more suitable for discussion within the broader context of the entire AIGC. Zhao et al. [58] proposed a survey on RAG applications for multiple modalities, but ignoring the discussion on RAG foundations. These surveys either exclusively focus on a single RAG foundation paradigm or provide only a brief overview of RAG augmentation methodologies for limited scenarios. Consequently, while existing research has explored various aspects of RAG, there remains a need for a comprehensive overview that systematically covers RAG foundations, enhancements, and its applicability across different domains. In this paper, we aim to present a systematic overview of RAG that addresses these gaps.

### D. Roadmap

The rest of the paper is organized as follows. Section II elaborates on the preliminary of RAG, introducing retrievers and generators. Section III presents the foundations of RAG and further enhancements on RAG. Section IV reviews existing research on RAG across various applications. Section V investigates the benchmark frameworks for RAG. Section VI discusses current limitations of RAG and potential future directions. Finally, Section VII concludes this paper.

## II. PRELIMINARY

In this section, we first deliver an overview of the general RAG architecture. Subsequently, we delve into the details of the generators and retrievers employed in today’s RAG-based AIGC.

### A. Overview

As shown in Fig. 1, the entire RAG system consists of two core modules: the retriever and the generator. The retriever is responsible for searching relevant information from a constructed data store, and the generator is responsible for producing generated contents. The RAG process unfolds as follows: firstly, the retriever receives the input query and

searches for relevant information; then, the original query and the retrieval results are fed into the generator through a specific augmentation methodology; finally, the generator produces the desired outcomes. In Section III-A, we will introduce the RAG foundations. In Section III-B, we will introduce further enhancement methods based on a constructed RAG system.

### B. Generator

The remarkable performance of generative AI across diverse tasks has ushered in the era of AIGC. Generative AI, powered by its robust generative module, has surpassed even the original expert systems in terms of effectiveness. Within the entire RAG system, the generation module holds significant importance. Different generative models are selected for different scenarios. For instance: transformer model for text-to-text task, VisualGPT [59] for image-to-text task, Stable Diffusion [10] for text-to-image task, and Codex [2] for text-to-code task.

Based on model structure, We categorize the generators into 4 main groups: transformer model, LSTM, diffusion model, and GAN. We will provide a detailed introduction to each category in the following sections.

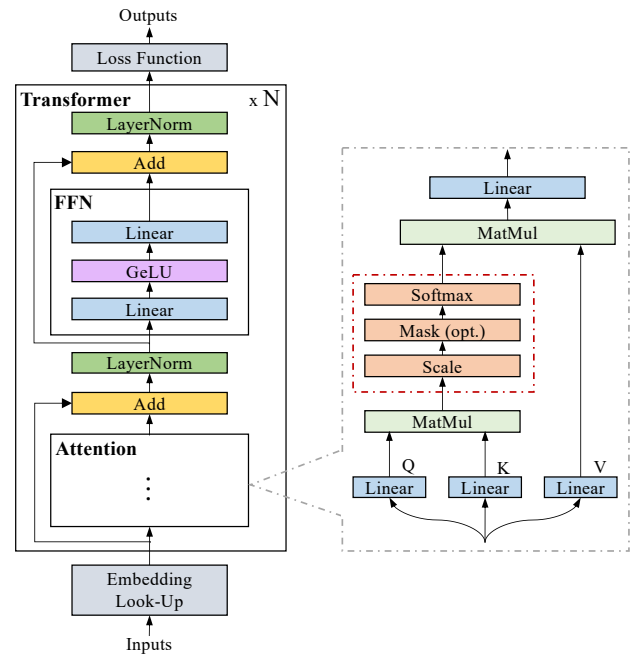

Fig. 2. Architecture of a traditional transformer model.

1) **Transformer Model:** The initial transformer was designed to solve problems in the Neural Language Process (NLP) field, consisting of self attention mechanism, feed forward network, layer normalization module, and residual network [60].

As shown in Fig. 2, the input of the transformer is mapped to a tensor  $x_{in}$  with a shape of  $(b, s, h)$  after the tokenization process and embedding model, where  $b$  represents batch size,  $s$  represents sequence length and  $h$  represents hidden dimension. Next, the position encoding will be sent to the self attention layer along with this tensor. The input  $x_{in}$  and the output  $x_{out}$  of the self-attention module will be connected by the

residual network and the layer normalization module. Finally, the output of the "Add & Norm" module  $x_{out}$  will be sent to the feed forward network. The entire process can be defined as follows:

$$Q = x_{in} * W_q + b_q, K = x_{in} * W_k + b_k, V = x_{in} * W_v + b_v,$$

$$x_{out} = LayerNorm1(Softmax(\frac{Q * K^T}{\sqrt{h}}) * V * W_o + b_o) + x_{in},$$

$$y = LayerNorm2((x_{out} * W_1 + b_1) * W_2 + b_2) + x_{out}.$$

It should be noted that  $w_q, w_k, w_v, w_o$  are learnable tensors with shape  $(h, h)$ ;  $b_q, b_k, b_v, b_o$  are a learnable tensors with shape  $(h)$ .

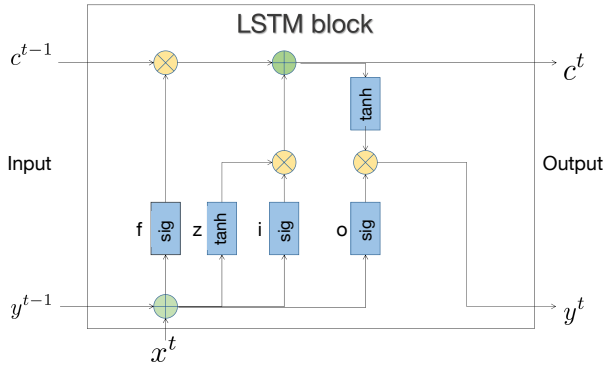

Fig. 3. Architecture of a typical LSTM block with forget gate.

2) **LSTM**: Long Short-Term Memory (LSTM) [61] is a special Recurrent Neural Network (RNN) model that overcomes the exploding/vanishing gradient problems of RNN in processing long-term dependency information by introducing cell state and gate mechanisms. The LSTM model consists of four gates: Input Gate, Forget Gate, Output Gate, and a Cell State. These gates update the cell state by controlling the information flow, enabling the model to remember long-term dependent information. Cell State is the core module of the LSTM model which can memorize and maintain information. The Input Gate decides which input data should be retained in the cell state. Forget Gate determines which cell state information should be discarded to avoid excessive memory. Output Gate determines how the information in the cell state affects the current output. The flow of data and the collaborative work process between components are shown in the Fig. 3.

3) **Diffusion Model**: Diffusion models [62] are a family of deep generative models that can create realistic and diverse samples of data [63]–[70], such as images [71]–[77], texts [78]–[81], videos [82]–[86], and molecules [87]–[91]. As shown in Fig. 4, diffusion models work by gradually adding noise to data until it becomes random, then reversing the process to generate new data from noise. This process is based on probabilistic modeling and neural networks. Diffusion models mainly have three equivalent formulations: denoising diffusion probabilistic models [63]–[65], score-based generative models [66], [67], and stochastic differential equations [68], [69], with following improvements like

DDIM [92], Rectified Flow [93], Consistency Model [94] and RPG-DiffusionMaster [77].

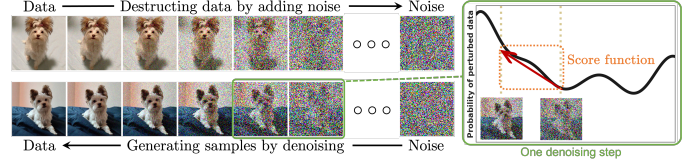

Fig. 4. Diffusion models smoothly perturb data by adding noise, then reverse this process to generate new data from noise. Each denoising step in the reverse process typically requires estimating the score function (see the illustrative figure on the right), which is a gradient pointing to the directions of data with higher likelihood and less noise, *c.f.* [62]

Especially, let  $x_0$  be a random variable that follows the data distribution  $q(x_0)$ , and let  $x_t$  be a random variable that follows the distribution  $q(x_t|x_0)$  after adding noise at time step  $t$ . Then, DDPM can be formulated as follows:

- **Forward Process** The forward process perturbs data with a sequence of Gaussian noise injections, transforming the data distribution  $q(x_0)$  into a simple prior distribution  $q(x_T) \approx N(0, I)$ . The transition kernel at each time step is given by

$$q(x_t|x_{t-1}) = N(x_t; \sqrt{1 - \beta_t}x_{t-1}, \beta_t I),$$

where  $\beta_t \in (0, 1)$  is a hyperparameter. The marginal distribution of  $x_t$  conditioned on  $x_0$  is

$$q(x_t|x_0) = N(x_t; \sqrt{\bar{\alpha}_t}x_0, (1 - \bar{\alpha}_t)I),$$

where  $\alpha_t = 1 - \beta_t$  and  $\bar{\alpha}_t = \prod_{s=0}^t \alpha_s$ .

- **Reverse Process** The reverse process generates new data samples by reversing the forward process with a learnable Markov chain. The prior distribution is  $p(x_T) = N(x_T; 0, I)$  and the transition kernel is

$$p_\theta(x_{t-1}|x_t) = N(x_{t-1}; \mu_\theta(x_t, t), \Sigma_\theta(x_t, t)),$$

where  $\theta$  denotes model parameters, and  $\mu_\theta(x_t, t)$  and  $\Sigma_\theta(x_t, t)$  are parameterized by deep neural networks. The reverse process starts from sampling  $x_T \sim p(x_T)$  and iteratively samples  $x_{t-1} \sim p_\theta(x_{t-1}|x_t)$  until  $t = 0$ .

- **Model Training** For each sample  $x_0 \sim q(x_0)$ , the model training objective is to maximizing the variational lower bound (VLB) of the log-likelihood of the data  $x_0$ . The simplified form  $\mathcal{L}_{VLB}(x_0)$  is given by

$$\mathbb{E}_{q(x_{1:T}|x_0)} \left[ -\log p(x_T) - \sum_{t=1}^T \log \frac{p_\theta(x_{t-1}|x_t)}{q(x_t|x_{t-1})} \right]$$

With simplification and reparameterization trick, the overall objective  $\mathbb{E}_{q(x_0)} [\mathcal{L}_{VLB}(x_0)]$  can be simplified into the final form

$$\mathbb{E}_{t \sim U[1, T], x_0 \sim q(x_0), \epsilon \sim \mathcal{N}(0, I)} [\lambda(t) \|\epsilon - \epsilon_\theta(x_t, t)\|]$$

where  $\lambda(t)$  is a positive weighting function,  $U[1, T]$  is a uniform distribution over the set  $\{1, 2, \dots, T\}$ , and  $\epsilon_\theta$  is a deep neural network with parameter  $\theta$  that predicts the noise vector  $\epsilon$  given  $x_t$  and  $t$ . Note that, the overall



objective is also equivalent to matching the joint distribution of the reverse process  $p_{\theta}(x_0, x_1, \dots, x_T)$  to that of the forward process  $q(x_0, x_1, \dots, x_T)$  by minimizing the KL divergence between them.

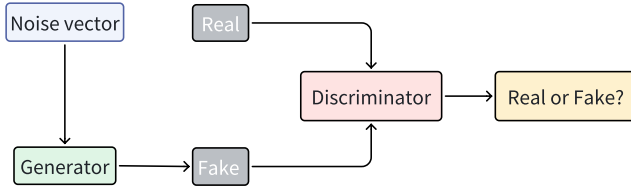

Fig. 5. Architecture of a typical Generative Adversarial Network (GAN).

4) **GAN**: Generative Adversarial Networks (GANs) [95] are highly anticipated deep learning models with amazing capabilities which can simulate and generate realistic images, audio, and other data. Due to its outstanding performance, GANs have achieved significant achievements in various fields [96]. The design inspiration of GANs comes from the zero-sum game in game theory.

As shown in Fig. 5, a typical GAN consists of two main components: a generator and a discriminator. These two parts compete with each other through adversarial learning, allowing the generator to continuously improve its ability to generate realistic samples, while the discriminator continuously improves its ability to distinguish between true and false samples.

### C. Retriever

Retrieval is to identify and obtain information system resources that are relevant to an information need. Specifically, let's consider information resources that can be conceptualized as a key-value store  $\{(k_i, v_i)\}_{i=1}^N$ , where each key  $k_i$  corresponds to a value  $v_i$  (often,  $k_i$  and  $v_i$  are identical). Given a query  $q$ , the objective is to search for the top- $k$  most similar keys using a similarity function  $s$ , and obtain the paired values. Based on different similarity functions, existing retrieval methods can be categorized into sparse retrieval, dense retrieval, and others. For widely used sparse and dense retrieval, the whole process can be divided into two distinct phases: in the first phase, each object is encoded into a specific representation; and in the second phase, an index is constructed to organize the data source for efficient search.

1) **Sparse Retriever**: Sparse retrieval methods are widely used in document retrieval, where the keys are actually documents to be searched (values are the same documents in this scenario). These methods leverage term matching metrics such as TF-IDF [97], query likelihood [98], and BM25 [18], which analyze word statistics from texts and construct inverted indices for efficient searching. Among them, BM25 is a hard-to-beat baseline in industrial-scale web search. For a query  $q$  containing keywords  $\{q_i\}_{i=1}^n$ , the BM25 score of a document  $D$  is:

$$s(q, D) = \sum_{i=1}^n IDF(q_i) \cdot \frac{f(q_i, D) \cdot (a + 1)}{f(q_i, D) + a \cdot (1 - b + b \cdot \frac{|D|}{avgdl})}$$

where  $IDF$  is the inverse document frequency weight,  $f(q_i, D)$  is the number of times that  $q_i$  occurs in the document  $D$ ,  $|D|$  is the length of  $D$ ,  $avgdl$  is the average document length in the corpus collection,  $a$  and  $b$  are tunable parameters.

$IDF$  is computed as:

$$IDF(q_i) = \ln\left(\frac{N - n(q_i) + 0.5}{n(q_i) + 0.5} + 1\right)$$

where  $N$  is the number of documents, and  $n(q_i)$  is the number of documents containing  $q_i$ .  $IDF$  score is also used in TF-IDF.

To enable efficient search, sparse retrieval typically leverages an inverted index to organize documents. Concretely, each term from the query performs a lookup to obtain a list of candidate documents, which are subsequently ranked based on their statistical scores.

2) **Dense Retriever**: Different from sparse retrieval, dense retrieval methods represent queries and keys using dense embedding vectors, and build approximate nearest neighbor (ANN) index to speed up the search. This paradigm can be applied to all modalities. For text data, recent advancements in pre-trained models, including BERT [15] and RoBERTa [99], are employed as encoders to encode queries and keys separately [19], [100]–[103]. Similar to text, models have been proposed to encode code data [24], [104], [105], audio data [25], [106], image data [23], [107], and video data [108], [109]. The similarity score between dense representations can be computed using methods such as cosine, inner product, L2-distance.

During training, dense retrieval usually follows a contrastive learning paradigm, making positive samples more similar and negative samples less similar. Several hard negative techniques [100], [110] have been proposed to further improve the model quality. During inference, approximate nearest neighbor (ANN) methods are applied for efficient searching. Various indices are developed to serve ANN search, such as tree [111], [112], locality sensitive hashing [113], neighbor graph index (e.g., HNSW [114], DiskANN [115], HMANN [116]), the combination of graph index and inverted index (e.g., SPANN [117]).

3) **Others**: In addition to sparse retrieval and dense retrieval, there are alternative methods for retrieving relevant objects. Instead of calculating representations, some research works directly use the edit distance between natural language texts [118] or abstract syntax trees (AST) of code snippets [119], [120]. For knowledge graph, entities are linked with relations, which can be regarded as a pre-built index for retrieval searching. Therefore, RAG methods which involve knowledge graph can use k-hop neighbor search as retrieval process [121], [122]. Named entity recognition (NER) [123], [124] is another way of retrieval, where the input is the query and the entities are the keys.

## III. METHODS

In this section, we first introduce the RAG foundations within the context of AIGC. Subsequently, we outline the enhancement methods that further improve the effectiveness of RAG.

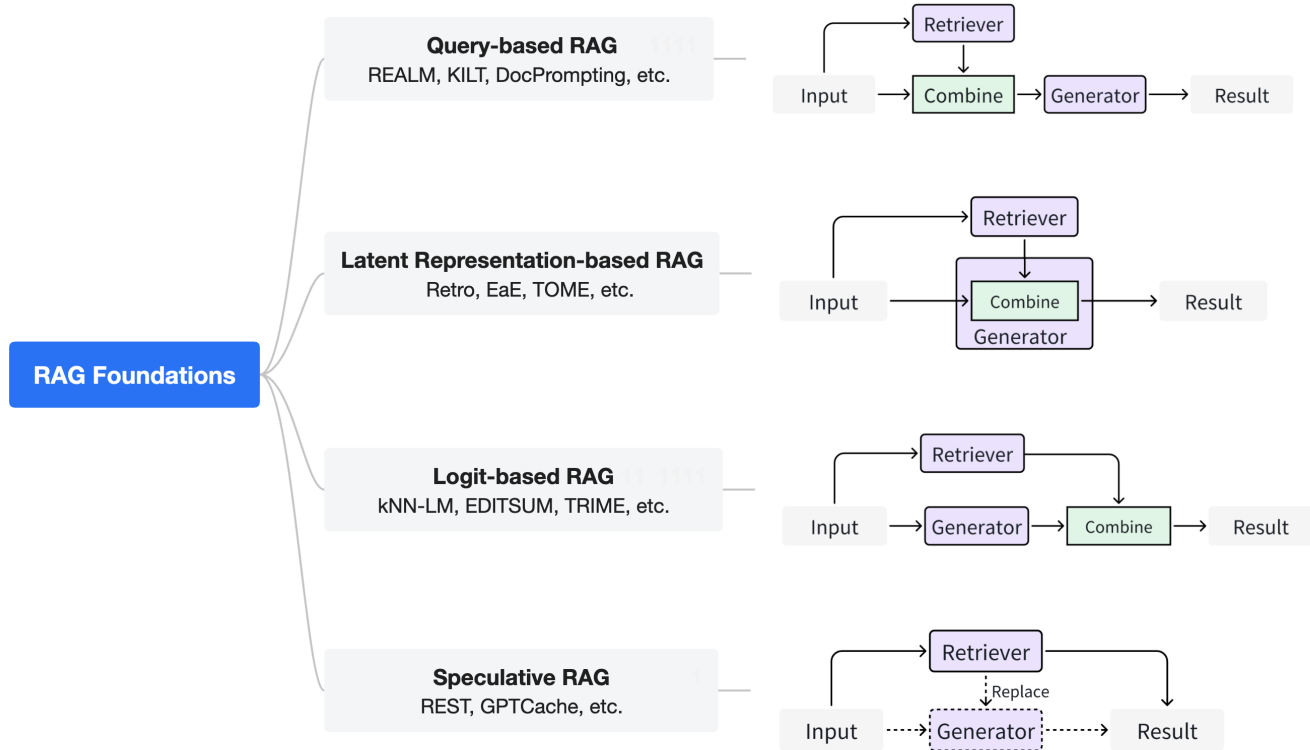

Fig. 6. Taxonomy of RAG foundations.

### A. RAG Foundations

Based on how the retriever augments the generator, we classify the RAG foundation paradigms into 4 distinct classes, as shown in Fig. 6.

1) **Query-based RAG**: Query-based RAG is also called prompt augmentation. It integrates the user’s query with insights from documents fetched during the retrieval process, directly into the initial stage of the language model’s input. This paradigm stands as a widely adopted approach within the applications of RAG. Once documents are retrieved, their content is merged with the original user query to create a composite input sequence. This enhanced sequence is subsequently fed into a pre-trained language model to generate responses.

REALM [31] employs a dual-BERT framework to streamline knowledge retrieval and integration, marrying pre-trained models with knowledge extractors. The initial BERT module processes the input question alongside documents to facilitate retrieval, utilizing MIPS for selecting the top-k documents with the highest probability and periodically updating the index. The document snippets obtained are then integrated with the query, feeding into the second BERT module to produce multiple outputs that are aggregated into a singular, comprehensive response. RAG [32] synergizes pre-trained language models with knowledge retrieval mechanisms, leveraging DPR and BART structures to accomplish retrieval-augmented generation tasks. DPR serves as the retrieval component, sourcing pertinent information from vast document databases, while BART uses this information for text generation. RAG-Token

and RAG-Sequence differ in their retrieval timings, with the former retrieving information at each token generation and the latter conducting a single retrieval for the entire sequence. KILT [125] focuses on ensuring information accuracy and reliability by aligning Wikipedia pages with specific snapshots and pinpointing the most pertinent text ranges through BLEU score evaluations. It filters out lower-quality data to maintain a high standard of information mapping, offering a variety of retrieval system options like Tf-idf, DPR, RAG, and BLINK + flair to support evidence-based predictions or citations according to task requirements. SELF-RAG [126] enhances the accuracy and relevance of responses by integrating a retrieval and critique strategy. Initially, the model employs a retriever to search for information paragraphs closely related to the input question. Subsequently, the critique model evaluates these paragraphs to determine their relevance and level of support of the retrieved text, assessing their impact on the generation of responses. Finally, the generator model constructs responses based on this information and evaluates the quality of these responses through critique marks.

Recently, some methods have proposed to implement RAG without modifying the language model architecture, which is particularly suitable for scenarios where language models are accessed through APIs. REPLUG [127] illustrates this methodology by treating the language model as a “black box,” utilizing Contriever to seamlessly incorporate relevant external documents into the query. REPLUG LSR, a variant with LM-Supervised Retrieval, further refines this process by optimizing

retrieval through language model-supervised insights, aiming to reduce perplexity scores and improve model performance by enriching its contextual understanding. RALM [128] uses the BM25 algorithm for document retrieval and predictive reranking to select pertinent documents for input integration.

In contemporary multimodal application research, integrating retrieved content into inputs has proven highly effective in enhancing the performance of various tasks. This strategy is applicable across several key fields, including code generation, audio generation, and Knowledge Base Question Answering (KBQA).

For text-to-code task, APICoder [129] and DocPrompting [40] demonstrate how effectively integrating retrieved information into language models can improve the accuracy and relevance of generated code. In automatic program repair task, CEDAR [130] and InferFix [131] utilize retrieved code snippets to aid the repair process, enhancing the model’s understanding and application of repair strategies by combining them with the original input. For code completion task, ReACC [132] employs a prompting mechanism, leveraging retrieved code snippets as part of the new input to increase the accuracy and efficiency of code completion.

In the audio generation field, MakeAnAudio [42] leverages retrieval to construct captions of language-free audio, so as to mitigate the data sparsity for text-to-audio training.

Recent research in KBQA has shown significant effects of combining retrieval and language models. Uni-Parser [133], RNG-KBQA [121], and ECBRF [134] effectively improve the performance and accuracy of QA systems by merging queries and retrieved information into prompts. BLLM augmentation [135] represents an innovative attempt at zero-shot KBQA using black-box large language models. This method, by directly integrating retrieved information into the model input without the need for additional sample training, demonstrates the great potential of combining retrieval and language models to enhance the model’s generalization ability in understanding and answering unseen questions.

In the scientific domain of RAG technology, GeneGPT [54] is utilized to address genomics inquiries, whereas Chat-Orthopedist [136] aims to provide support for shared decision-making among adolescents with idiopathic scoliosis. Both approaches enhance the application effectiveness and information accuracy of large language models by integrating retrieved information into the prompts of these models.

In the task of image generation, RetrieveGAN [43] enhances the relevance and accuracy of generated images by integrating retrieved information, including selected image patches and their corresponding bounding boxes, into the input stage of the generator. IC-GAN [137] modulates the specific conditions and details of the generated images by concatenating noise vectors with instance features.

In the field of 3D generation, RetDream [48] initially utilizes CLIP to retrieve relevant 3D assets, effectively merging the retrieved content with the user input during the input phase.

2) **Latent Representation-based RAG:** In the framework of Latent Representation-based RAG, the generative models interact with latent representations of retrieved objects, thereby

enhancing the model’s comprehension abilities and the quality of the content generated.

The FiD [33] technique leverages both BM25 and DPR for sourcing supportive paragraphs. It concatenates each retrieved paragraph and its title with the query, processing them individually through the encoder. FiD reduces computational complexity and efficiently utilizes relevant information to generate answers by fusing information from multiple retrieved paragraphs in the decoder, rather than processing each paragraph in the encoder. The application of Fusion-in-Decoder methodologies transcends the realm of textual content processing, demonstrating substantial potential and adaptability in processing code, structured knowledge, and diverse multimodal datasets. Specifically within the code-related domain, technologies such as EDITSUM [138], BASH-EXPLAINER [139], and RetrieveNEdit [140] adopt the FiD approach, facilitating integration through encoder-processed fusion. Re2Com [141] and RACE [141], among other methods, also feature the design of multiple encoders for different types of inputs. In the field of Knowledge Base Question Answering (KBQA), the FiD method has been widely adopted, demonstrating significant effectiveness. UniK-QA [142], DECAF [143], SKP [144], KD-CoT [145], and ReSKGC [146] have effectively enhanced the performance of QA systems through the application of Fusion-in-Decoder technology. This illustrates that by integrating RAG for KBQA, the efficiency and accuracy of QA systems can be significantly improved. In the field of Science, RetMolRetMol [53] and DeepICL [147] employ the Fusion-in-Decoder strategy, integrating information at the decoder stage to enhance the relevance and quality of the generated molecular structures.

Retro [34] pioneers the integration of retrieved text via “Chunked Cross-Attention,” a novel mechanism that segments the input sequence into discrete chunks. Each chunk independently executes cross-attention operations, thereby mitigating computational burdens. This technique enables the model to selectively retrieve and assimilate distinct documents for varied sequence segments, fostering dynamic retrieval throughout the generation process. This enhances the model’s adaptability and enriches the contextual backdrop of generated content. In the domain of image generation, cross-attention mechanisms have been widely adopted within RAG frameworks. Methods such as Re-Imagen [148], KNN-Diffusion [149], RDM [150] and LAION-RDM & ImageNet-RDM [151] utilize cross-attention to integrate multiple retrieval results, effectively enhancing the overall performance of the models. On the other hand, Li [152] introduces the ACM, a text-image affine combination module, which notably does not employ any form of attention mechanism.

Distinctly, TOME [153] shifts the focus towards comprehensive mention encodings, prioritizing the granularity of mention over mere entity representations. It meticulously generates encodings for each entity mention across Wikipedia, populating a repository with approximately 150 million entries. This repository, encompassing key and value encodings alongside entity IDs, empowers the retrieval of much more fine-grained information. TOME integrates an initial transformer block to process input texts, followed by TOME

blocks with memory attention layers, facilitating the synthesis of multifaceted information sources and enhancing inferential reasoning capabilities, even for unencountered entities. Memorizing Transformers [29] revolutionize long document processing through the integration of a kNN-augmented attention mechanism within a Transformer layer. This innovation triggers a kNN search amidst input sequence processing, fetching data based on similarities between the sequence and stored key-value pairs, thereby elevating performance without necessitating complete retraining. This approach not only bolsters processing efficiency but also broadens the model’s memory span, enabling self-retrieval from its generated outputs and fine-tuning for extensive knowledge bases or code repositories. Unlimiformer [154], by embedding a k-nearest neighbors (kNN) index within a pre-trained encoder-decoder transformer framework, pioneers handling inputs of indefinite length. Storing hidden states of input tokens in the kNN index allows for the efficient retrieval of highly relevant tokens during decoding. This innovation extends the model’s capacity to manage prolonged sequences.

Diverging from prior methods for knowledge, EaE [155] empowers language models to internalize explicit entity knowledge. EaE introduces an entity-specific parameterization, optimizing inference efficacy through an entity memory layer embedded within the transformer architecture. This layer directly acquires entity representations from textual data, utilizing a sparse retrieval strategy to fetch the nearest entities based on their embeddings, thus refining the model’s comprehension through a calculated aggregation of entity-specific information.

In the field of 3D generation, ReMoDiffuse [49] introduces a semantics-modulated attention mechanism. This technology enhances the accuracy of generating corresponding 3D motions based on textual descriptions. AMD [156] achieves efficient conversion from text to 3D motion by fusing the original diffusion process with the reference diffusion process.

In the audio domain, Koizumi [41] utilizes a pre-trained large-scale language model, incorporating dense features generated by VGGish and embedding networks in the attention module to guide the generation of audio captions. Re-AudioLDM [157] extracts deep features from text and audio using T5 and AudioMAE, and integrates these features within the attention mechanism of its Latent Diffusion Model (LDM).

In the field of video captioning, R-ConvED [46] employs a convolutional encoder-decoder network architecture, which processes retrieved video-sentence pairs with the aid of an attention mechanism to generate hidden states and subsequently produce captions. CARE [158] introduces a concept detector as an input to the decoder and embeds concept representations within a hybrid attention mechanism. EgoInstructor [47] employs gated-cross attention to integrate these textual inputs with encoded video features, enhancing the relevance and coherence of the generated captions for egocentric video content.

3) **Logit-based RAG:** In Logit-based RAG, generative models combine retrieval information through logits during the decoding process. Typically, the logits are summed or combined through models to produce the probability for step-wise generation.

The kNN-LM [35] model integrates a pre-trained neural language model with the k-nearest neighbor search. It employs the pre-trained model to generate a list of candidate words and their probability distribution, while simultaneously performing retrieval from a data repository to find the k most relevant neighbors based on the current context, thus enhancing the output of the original language model. The innovation at the core of this model lies in its ability for dynamic retrieval of information from a broad text corpus, significantly improving the accuracy and relevance of its predictions, particularly in addressing rare patterns and adapting to various fields. He [36] introduces a new framework that is predicated on performing retrieval operations only when necessary, aimed at enhancing the inference efficiency of the kNN-LM model through an adaptive retrieval. This framework accelerates the model’s inference speed by training a retrieval adapter, which automatically identifies and eliminates unnecessary retrieval actions in certain scenarios. This method allows the model to dynamically decide on the necessity of retrieval based on the current context, thereby balancing the trade-off between performance and efficiency, and substantially increasing inference speed while maintaining model performance.

Unlike previous methods that only merge memories during the testing time, TRIME [159] achieves memory merging during both training and testing phases, treating in-batch examples as accessible memory. TRIME leverages new data batching and memory construction techniques to effectively utilize external memory. TRIME employs BM25 scores to pack paragraphs with high lexical overlap into the same batch, constructing the training memory to further optimize model performance. NPM [160] is a non-parametric masked language model comprised of an encoder and a reference corpus. Unlike traditional models that apply a softmax over a finite vocabulary, NPM models a non-parametric distribution over the corpus. The encoder’s role is to map phrases from the corpus into fixed-size vectors, filling in [MASK] by retrieving the phrase most similar to the masked position.

Beyond the text domain, other modalities such as code and image also utilize methods that integrate retrieved content with language models in the final output stage.

For code-to-text conversion task, Rencos [119] generates multiple summary candidates in parallel from the retrieved code. It then normalizes these candidates using edit distance and calculates the final probability to select the summary output that best matches the original code. In code summarization task, EDITSUM [138] enhances the quality of summary generation by integrating prototype summaries at the probability level. For text-to-code tasks, the kNN-TRANX [161] model employs a combination of a confidence network and meta-knowledge to merge retrieved code fragments. It utilizes a seq2tree structure to generate target code that closely matches the input query, thereby increasing the accuracy and relevance of code generation.

In image captioning tasks, MA [162] combines an attention-based encoder-decoder, using the image encoder to extract visual features to construct the semantic part, and decodes it word by word with the information retrieved. MA interpolates between two distributions generated by the caption decoder



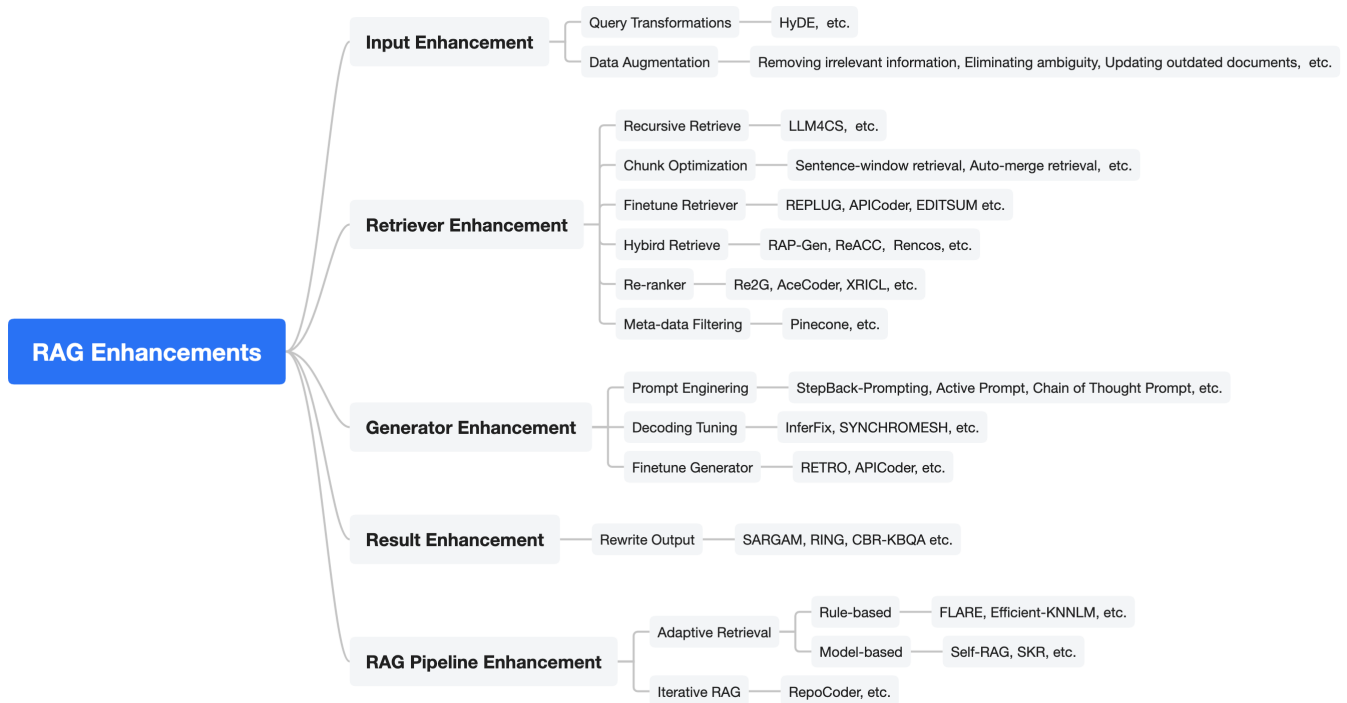

Fig. 7. Taxonomy of RAG Enhancements.

and the memory-augmented module to determine the distribution of the next word.

4) **Speculative RAG**: Speculative RAG looks for opportunities to use retrieval instead of generation to save resources and accelerate response speed. REST [30] replaces the small models in speculative decoding [163] with retrieval, so as to generate drafts. GPTCache [37] tries to solve the problem of high latency when using the API of LLMs by building a semantic cache for storing LLM responses.

## B. RAG Enhancements

In this section, we will introduce methods to enhance RAG performance. We categorize existing methods into 5 distinct groups based on their enhancement targets: input, retriever, generator, result, and the entire pipeline.

1) **Input Enhancement**: The input refers to the user’s query, which is initially fed into the retriever. The quality of the input significantly impacts the final outcome of the retrieval stage. Consequently, enhancing the input becomes essential. In this section, we introduce two methods: query transformation and data augmentation.

a) **Query Transformation**: Query transformation can enhance the result of retrieval by modifying the input query. Query2doc [164] and HyDE [165] first use query to generate a pseudo document, and then use this document as a key for retrieval. The advantage of doing so is that the pseudo document will contain more rich relevant information, which helps to retrieve more accurate results.

b) **Data Augmentation**: Data augmentation refers to improving the data in advance before retrieval, such as removing irrelevant information, eliminating ambiguity, updating

outdated documents, synthesize new data, etc. which can effectively improve the performance of the final RAG system. MakeAnAudio [42] uses captioning and audio-text retrieval to generate caption for language-free audio to mitigate data sparsity, and adds random concept audio to improve the original audio.

2) **Retriever Enhancement**: In the RAG system, the process of retrieval is crucial. Generally, the better the content quality, the easier it is to stimulate the ability of LLMs in-context learning as well as other generators and paradigms. The worse the content quality, the more likely it is to cause model hallucinations. Therefore, in this section, we will discuss how to efficiently improve the effectiveness of the retrieval process.

a) **Recursive Retrieve**: Recursive retrieve is the process of splitting a query before retrieval, and performing multiple searches to retrieve more and higher quality content. Jagerman et al. [166] uses Chain-of-Thought(COT) [167] to enable the model to break queries down gradually and provide more rich related knowledge. LLMCS [168] applies this technology to the conversational system and obtained better retrieval results by rewriting the conversation record.

b) **Chunk Optimization**: Chunk optimization technique refers to adjusting the size of the chunk to achieve better retrieval results. Sentence-window retrieval [169] is an efficient approach that enhances retrieval by fetching small chunks of text and returning a window of relevant sentences surrounding the retrieved segment. This method ensures that the context before and after the targeted sentence is included, providing a more comprehensive understanding of the retrieved information. Auto-merge retrieval is another advanced RAG method

of LlamaIndex [169] which organizes the document in a tree-like structure, with the parent node containing the content of all children nodes. For example, articles and paragraphs, as well as paragraphs and sentences, all follow a parent-child relationship. In the retrieve process, fine-grained search for children nodes ultimately returns the parent node, effectively providing richer information.

*c) Finetune Retriever:* As a core component in the RAG system, the retriever plays a crucial role in the entire system operation process. A good embedding model can bring semantically similar content closer together in vector space. The stronger the retriever's ability, the more useful information can be provided for the subsequent generator, thereby improving the effectiveness of the RAG system. Therefore, the ability of the embedding model [170]–[173] is crucial for the overall effectiveness of the RAG system.

In addition, for embedding models that already have good expression power, we can still finetune them using high-quality domain data or task related data to improve their performance in specific domains or tasks. REPLUG [127] treats LM as a black box and update the retriever model based on the final results. APICoder [129] finetunes the retriever with python files and api names, signature, description. EDITSUM [138] finetunes the retriever to decrease the jaccard distance between summaries after retrieval. SYNCHROMESH [120] adds tree distance os ASTs in the loss and uses Target Similarity Tuning to finetune the Retriever. R-ConvED [46] finetunes the Retriever with the same data as generator.

*d) Hybrid Retrieve:* Hybrid retrieve refers to the simultaneous use of multiple types of retrieval methods. RAP-Gen [174] and ReACC [132] use both dense retriever and sparse retriever to improve the quality of retrieval. Rencos [119] uses sparse retriever to retrieve similar code snippets on syntactic-level and usse dense retriever to retrieve similar code snippets on semantic-level. BASHEXPLAINER [139] first uses dense retriever to capture semantic information and then uses sparse retriever to acquire lexical information. RetDream [48] first retrieves with text and then retrieves with the image embedding.

*e) Re-ranking:* The Rerank technique refers to reordering the retrieved content in order to achieve greater diversity and better results. Re2G [175] applies a re-ranker [176] model after the traditional retriever. The effect of the re-ranker model is to re-rank retrieved documents, the purpose of which is to reduce the impact of information loss caused by compressing text into vectors on the quality of retrieval. AceCoder [177] rerank the retrieved programs with a selector. The purpose of introducing the selector is to reduce redundant programs and obtain diverse retrieved programs. XRICL [178] uses a distillation-based exemplar reranker after retrieval.

*f) Meta-data Filtering:* Meta-data filtering [179] is another method to help processing retrieved documents which uses metadata (such as time, purpose, etc.) to filter the retrieved documents for better results.

3) **Generator Enhancement:** In RAG systems, the quality of the generator often determines the quality of the final output results. Therefore, the ability of the generator determines the upper limit of the entire RAG system's effectiveness.

*a) Prompt Engineering:* Technologies in prompt engineering [180] that focus on improving the quality of LLMs' output, such as Prompt compression, Stepback Prompt [181], Active Prompt [182], Chain of Thought Prompt [167], etc., are all applicable to LLM generators in RAG systems. LLM-Lingua [183] applies a small model to compresses the overall length of the query to accelerate model inference, relieving the negative impact of irrelevant information on the model and alleviating the phenomenon of "Lost in the Middle" [184]. ReMoDiffuse [49] decomposes complex descriptions into anatomical text scripts by using ChatGPT. ASAP [185] add exemplar tuples to the prompt for better results. An exemplar tuple is composed of the input code, a function definition, the results of analyzing that definition and its associated comment. CEDAR [130] uses a designed prompt template to organize code demonstration, query, and natural language instructions into a prompt. XRICL [178] utilizes COT technology to add translation pairs as an intermediate step in cross linguistic semantic parsing and inference. MakeAnAudio [42] is able to use other modalities as input which can provide much richer information for the following process.

*b) Decoding Tuning:* Decoding tuning refers to adding additional controls during the generator processing, which can be achieved by adjusting hyperparameters to achieve greater diversity, limiting the output vocabulary in some form, and so on. InferFix [131] balances the diversity and quality of results by adjusting the temperature in decoder. SYNCHROMESH [120] limits the output vocabulary of the decoder by implementing a completion engine to eliminate implementation errors. DeepICL [147] controls the randomness of the generation according to an additional temperature factor.

*c) Finetune Generator:* The finetuning of the generator can enhance the model's ability to have more precise domain knowledge or better fit with the retriever. RETRO [34] fixes the parameters of the retriever and uses the chunked cross attention mechanism in the generator to combine the content of the query and retriever. APICoder [129] finetunes the generator CODEGEN-MONO 350M [186] with a shuffled new file combined with API information and code blocks. CARE [158] first uses image data, audio data and vedio-text pairs to train encoders and then finetune the decoder (generator) with the target of decreasing caption loss and concept detection loss together, during which the encoders and the retriever are frozen. Animate-A-Story [187] optimizes the video generator with image data, and then finetunes a LoRA [188] adapter to capture the appearance details of the given character. Ret-Dream [48] finetunes a LoRA adapter [188] with the rendered images.

4) **Result Enhancement:** In many scenarios, the final result of RAG may not achieve the expected effect, and some techniques of Result Enhancement can help alleviate this problem.

*a) Rewrite Output:* SARGAM [189] modifies the generated results in code-related task by classifying Deletion Classifier, Placeholder Classifier and Insertion Classifier with Levenshtein Transformer to better adapt to the actual code context. Ring [190] obtains diversity results by reranking

candidates based on the average of per token log probabilities produced by the generator. CBR-KBQA [52] revises the result by aligning generated relations with those presented in the local neighborhood of the query entity in knowledge graph.

#### 5) *RAG Pipeline Enhancement:*

*a) Adaptive Retrieval:* Some studies and practices on RAG have shown that retrieval is not always beneficial for the final generated results. When the parameterized knowledge of the model itself is sufficient to answer relevant questions, excessive retrieval will cause resource waste and may increase the model’s confusion. Therefore, in this chapter, we will discuss two types of methods for determining whether to retrieve, named rule-based and model-based methods.

**Rule-based:** FLARE [191] actively decides whether and when to search through the probability in the generation process. Efficient-KNNLM [36] combines the generation probability of KNN-LM [35] and NPM [160] with a hyperparameter  $\lambda$  to determine the proportion of generation and retrieval. Mallen et al. [192] conducts statistical analysis on questions before generating answers, allowing the model to directly answer high-frequent questions, and introducing RAG for low-frequent questions. Jiang et al. [193] studies Model Uncertainty, Input Uncertainty, and Input Statistics to comprehensively assess the confidence level of the model. Ultimately, based on the confidence level of the model, a decision is made whether to retrieve. Kandpal et al. [194] assists in determining whether a retrieval is needed by studying the relationship between the number of relevant documents in the training dataset and the degree to which the model masters relevant knowledge.

**Model-based:** Self-RAG [126] uses a trained generator to determine whether to perform a retrieval based on the retrieve token under different instructions, and evaluates the relevance and level of support of the retrieved text through the Self-Reflection token. Finally, the quality of the final output result is evaluated based on the Critique token. Ren et al. [195] uses "Judgment Prompting" to determine whether LLMs can answer relevant questions and whether their answers are correct or not, thereby assisting in determining the necessity of a retrieval. SKR [196] uses the ability of LLMs themselves to judge in advance whether they can answer the question, and if they can answer, no retrieval is performed.

*b) Iterative RAG:* RepoCoder [197] applies an iterative retrieval-generation pipeline to better utilize the useful information scattered in different files in the code completion tasks. It augments the retrieval query during the  $i$ -th iteration with previously generated code and obtain greater results. ITER-RETGEN [198] synergizes retrieval and generation in an iterative manner. The current output of the generator can to some extent reflect the knowledge it still lacks, and the retrieve can retrieve the missing information as contextual information for the next round, which helps to improve the quality of the generated content in the next round.

## IV. APPLICATIONS

In this chapter, we will introduce the popular RAG applications in different fields.

### A. *RAG for Text*

In this section, we will introduce some popular work for text generation using RAG methods.

*1) Question Answering:* Question Answering involves the process of providing responses to posed questions by drawing from a vast and comprehensive collection of textual sources.

FID [33] and REALM [31] identify the top  $k$  most pertinent article snippets based on the query and forward each snippet along with the question to large language models (LLMs) to generate  $k$  responses. These responses are then synthesized into a final answer. Toutanova et al. [199] substituted the text corpus in REALM with subgraphs from a knowledge graph, yielding impressive results. Atlas [28] demonstrated that leveraging Retrieval-Augmented Generation (RAG) to assist LLMs in open-domain question answering tasks significantly enhances few-shot learning capabilities. RETRO [34] employs attention mechanisms to integrate the question with relevant retrieved documents within the model to produce the final answer. SKR [196] observed that using RAG does not invariably benefit Question Answering and thus explored guiding the model to evaluate its grasp of pertinent knowledge, subsequently adapting its use of external resources for retrieval enhancement. KAPING [200] enhances the quality of LLM responses by incorporating structured knowledge from knowledge graphs into the input via constructed prompts. TOG [201] introduced an innovative knowledge graph-augmented LLM framework, which excels by fostering interactions between LLMs and the Knowledge Graph and by expanding the inference path space with beam search. Addressing the long-tail issue. NPM [160] pioneered the use of nonparametric data distributions in lieu of the softmax layer, enabling models with fewer parameters to perform effectively. Self-RAG [126] improves answer quality by learning to discern when to retrieve, assess the retrieved content’s relevance, and evaluate the final generated results using four types of reflective tokens. CL-ReLKT [202] employs a language-generalized encoder to bridge the gap between question-document pairs across languages, thus better leveraging multilingual data. CORE [203] mitigates language resource disparities by introducing a novel dense passage retrieval algorithm and a multilingual autoregressive generation model. Lastly, EAE [155] enhances answer quality by retrieving entity embeddings for query entities and integrating these with hidden states for further processing. UR-QA [204] found that when encountering unseen problems, retrieving QA pairs has a better final effect; When encountering problems that have not been seen before, the retrieve text chunk performs better. Therefore, it is proposed to simultaneously retrieve QA pairs and text chunks, and select the final answer by comparing the calibrated confidences.

*2) Fact Verification:* Fact Verification involves assessing the veracity of information, a critical function in disciplines such as Natural Language Processing (NLP), Information Retrieval, and Data Mining. In today’s digital era, characterized by an exponential increase in data, particularly across social media and online news platforms, there is a rapid proliferation of unchecked information. Fact verification plays an essential role in countering the spread of fake news, deceptive content,

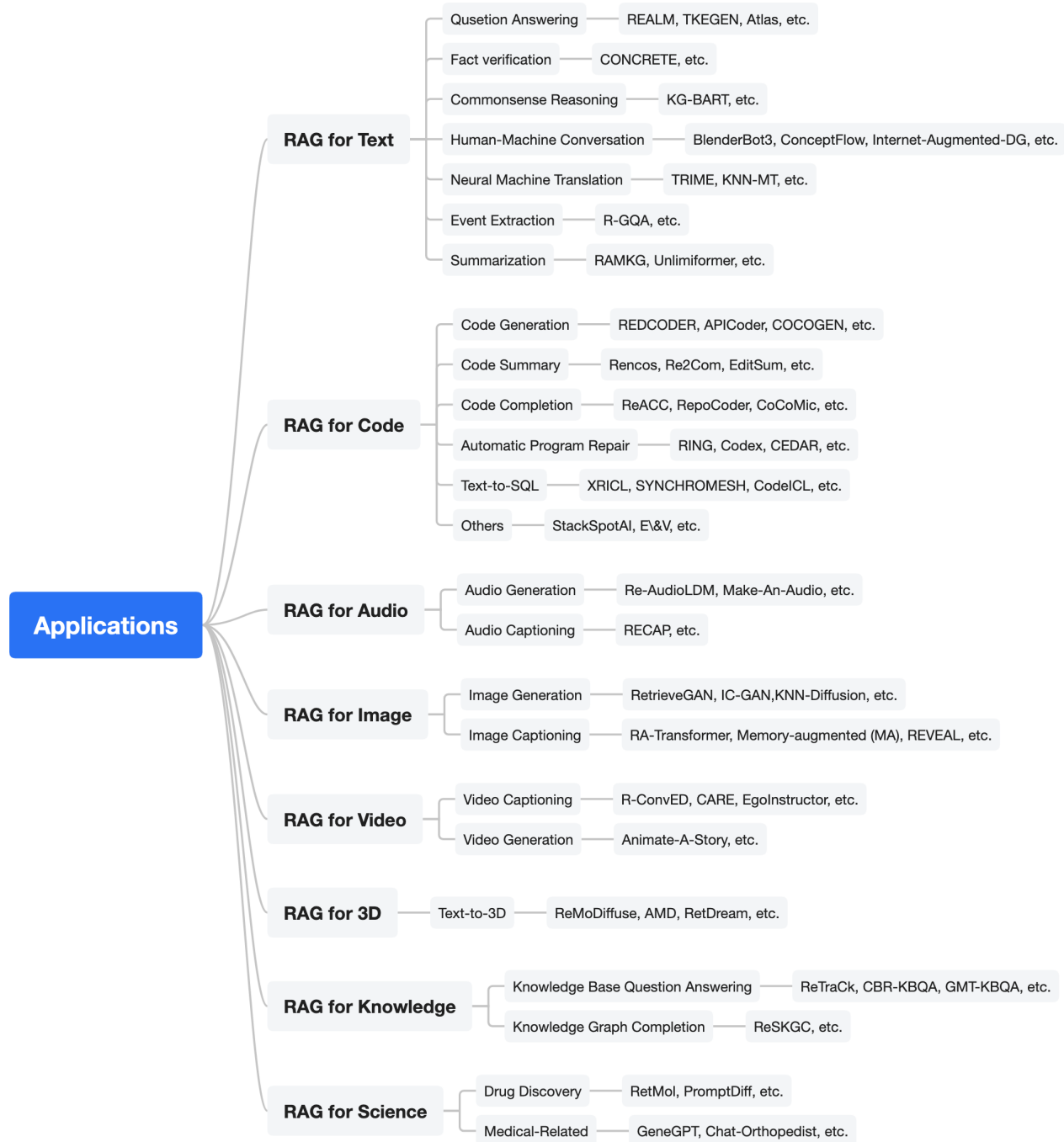

Fig. 8. Taxonomy of multiple applications in multimodality.

and rumors, thereby preserving the integrity of the information landscape and ensuring the public's access to accurate knowledge. Consequently, automated fact verification systems are of immense importance, with broad applications and significant practical value.

CONCRETE [205] leverages cross-lingual retrieval mechanisms to tap into a wealth of multilingual evidence, effectively bridging the gap in resources for languages that are underrepresented in fact-checking datasets.

3) **Commonsense Reasoning**: Commonsense Reasoning entails the capability of machines to infer or make decisions on problems or tasks in a human-like manner, drawing upon their acquired external knowledge and its application. However, the vast scope of common sense knowledge and the intricacies of reasoning processes make Commonsense Reasoning a perennially challenging and prominent area of research within the field of Natural Language Processing (NLP).

KG-BART [206] expands the conceptual landscape by incorporating intricate interrelations among diverse concepts

within a knowledge graph. It employs graph attention mechanisms to aid large language models (LLMs) in crafting more nuanced and logically coherent sentences. This approach not only improves the models' generalization capabilities but also significantly bolsters their Commonsense Reasoning proficiency.

4) **Human-Machine Conversation:** Human-Machine Conversation encompasses the ability of machines to comprehend natural language and adeptly employ this skill to engage with humans seamlessly. This capability represents a significant challenge within the realms of Artificial Intelligence and Natural Language Processing and offers a broad spectrum of practical applications. As such, Human-Machine Conversation continues to be a focal point of research for many scholars.

ConceptFlow [207] leverages a commonsense knowledge graph to structure conversations, directing the flow of dialogue based on attention scores, and propelling the conversation forward. This method achieves commendable results even with a substantial reduction in model parameters. Cai et al. [208] reimagines the text generation task as a cloze test by retrieving and distilling the essence of past conversational history, leading to notable outcomes. Komeili et al. [209] augments dialogue generation quality by harnessing advanced search engine technologies to source pertinent content from the internet. BlenderBot3 [210] broadens its search horizon, not only mining relevant internet content but also local dialogue history, and employs entity extraction among other techniques to refine the quality of the resulting dialogue. Kim et al. [211] improves the caliber of non-English conversations by incorporating cross-lingual knowledge, effectively addressing the scarcity of non-English datasets and enhancing the quality of the generated dialogue.

5) **Neural Machine Translation:** Neural Machine Translation (NMT) is the automated process of translating text from a source language to a target language. It is a pivotal task in the domain of Natural Language Processing (NLP) and represents a significant objective in the pursuit of Artificial Intelligence (AI), boasting considerable scientific and practical significance.

Cai et al. [212] propose an innovative approach that utilizes monolingual corpora alongside multilingual learning techniques, challenging the traditional dependency on bilingual corpora in Neural Machine Translation. This approach ensures that the retrieval system provides ample information while simultaneously optimizing both the retrieval mechanism and the translation model, culminating in impressive performance. KNN-MT [213] executes translation tasks at the token level by computing vector space distances. TRIME [159] effectively minimizes the discrepancy between training and inference phases by jointly training the retrieval system and the generation model, thereby enhancing the precision of translations.

6) **Event Extraction:** Event Extraction is a specialized task within Natural Language Processing (NLP) that focuses on pinpointing and extracting instances of particular event types from unstructured textual data. An event is generally characterized by a central action or predicate and the related entities, which can include participants, temporal indicators, locations, and other relevant attributes. The objective of event

extraction is to convert the nuanced details embedded within text into a structured format, thereby facilitating advanced analysis, efficient information retrieval, and practical downstream applications.

R-GQA [214] employs a retrieval-based approach to enhance the context of a given issue by identifying and utilizing the most closely aligned Question-Answer pair from a repository, thereby enriching the information available for processing the current query.

7) **Summarization:** In the realm of Natural Language Processing (NLP), Summarization is a task aimed at distilling the essential information from lengthy texts and producing a concise, coherent summary that encapsulates the primary themes. Summarization enables users to quickly grasp the essence of a text, thereby conserving time that would otherwise be spent on reading extensive material. There are two main approaches to Summarization: Extractive and Abstractive.

Extractive Summarization involves the automatic selection and compilation of key phrases directly from the source text. A key phrase succinctly captures the main themes, content, or perspectives of the text and is typically composed of one or several words. The generation of key phrases is instrumental for understanding, categorizing, retrieving, and organizing textual information. It is extensively applied in fields such as search engine optimization, academic research, text summarization, and more. This technique refrains from creating new sentences, instead repurposing segments from the original text.

Abstractive Summarization, on the other hand, entails comprehending the original text's meaning and reformulating it into new sentences. This approach can convey the source's intent more fluidly but poses greater challenges in terms of implementation due to its complexity.

RAMKG [215] effectively leverages a comprehensive English corpus to bolster the performance of Keyphrase Generation in non-English contexts. It does so by enhancing the alignment of keywords extracted from texts in different languages that share similar subject matter. Unlimiformer [154] addresses the issue of input length constraints in transformer-based models by retrieving and utilizing the top-k most relevant hidden states, thereby extending the model's capacity to handle longer inputs.

## B. RAG for Code

Code-related tasks, including code generation, code summarization, code auto-completion, automatic program repair, etc., are always a focus in the field of software engineering. Retrieval and generation are previously two separate ways to resolve these tasks. For retrieval, similar code snippets can be found through similar Abstract Syntax Trees or text edit distances, while natural languages can be found through sparse retrieval or dense retrieval. For generation, considering that code has a sequential data form, many sequence-to-sequence models are applied, from LSTM, Transformers, to current decoder-only LLMs. Recent research leverages both techniques to achieve better performance, augmenting the generation process with the retrieved results.



1) **Code Generation:** The goal of code generation is to transform natural language (NL) descriptions into code implementation, which can be seen a process of text-to-code. Therefore, LSTM and transformer models are widely used for generator. Whether to use code-specific retrieval or text-based retrieval depends on the contents to be searched.

Retrieval-based prompt engineering in few-shot learning is one of the most prevalent scenarios of RAG in code generation. Few-shot learning, or say in-context learning, includes training samples in prompts as the input for sequence-to-sequence generative models. Retrieval techniques are adopted to find similar training samples to the test input, so that the prompt can be more informative and related. REDCODER [38] retrieves similar NL descriptions using dense retriever CodeBert [24], then concatenates the NL texts, their paired codes, for downstream generator PLBART [39]. APICoder [129] first train a Bert-based deep retriever to align the embeddings of NL descriptions and API documentation; then, it retrieves relevant API information to build prompt for the generator CODEGEN-MONO [216]. COCOGEN [217] aims at commonsense reasoning, which generates code-based reasoning-graphs with Codex [2] given NL inputs; it adds an evaluation setting of dynamic prompt selection, which actually retrieves relevant examples for prompts. In DocPrompting [40] given an NL intent, the retriever retrieves relevant documentations, then the generator generates codes based on the NL and retrieved documents. It evaluates both sparse retrievers and dense retrievers, and also tries different generators in experiments. CodeT5+ [218] adopts the CodeT5 [105] model for both the retriever and generator, leveraging only the encoder part in the retrieval process. AceCoder [177] fixes the retriever to BM25 [18], and tests several LLM generators for code generation.

Retrieval results can be applied during the generation process as well. RECODE [118] retrieves similar NL descriptions using the edit distance, then extracts n-gram action subtrees from retrieved sentences' corresponding target code abstract syntax trees (AST). During LSTM-based generation, the patterns of processed subtrees are leveraged to increase the corresponding word probability at each decoding step. kNN-TRANX [161] uses seq2tree model BertranX [219] to convert NL to code AST. It constructs a datastore for each code prefix and NL pair; i.e., for each NL-code pair, the context representation of the i-th context is obtained by encoding NL and the i-th prefix of code's AST through the seq2tree model. During generation, at each decoding step the hidden representations are searched within the datastore to form a new probability, which is later combined with the seq2tree model's output using a confidence network.

2) **Code Summary:** The goal of code summary is to transform code into natural language (NL) descriptions, which is a process of code-to-text. Same to code generation, many sequence-to-sequence models are applied as generator.

In many research works, the retrieval results are processed by additional encoders. Rencos [119] utilizes two different methods to retrieve similar code snippets, syntactic similarity between abstract syntax trees (AST) and cosine similarity between dense representations. For generator, it adopts attention-

based LSTM. There are three encoders for the code input and two retrieval results respectively, and the decoder combines three probabilities for final generation. Re2Com [220] and EditSum [138] both retrieve similar code using sparse retrieval BM25 and generate summary using LSTM. They separately encode the input, the retrieved code, and the corresponding summary, then combine the middle representations or probabilities in the decoder. HGNN [221] instead uses code edit distance for retrieval, and substitutes the encoders for codes with hybrid GNN on their Code Property Graphs (CPG) [222]. RACE [141] aims at generating commit message for code difference. It leverages dense retrieval for similar examples and transformer model for generation. It also uses three encoders for the input, the retrieved code difference, and corresponding commit message, then combines the results before feeding into the decoder. BASHEXPLAINER [139] shares the similar idea. Its dense retrieval module is based on CodeBert [24], and for generation, the output representations of the input and the similar code from CodeBert are directly fused for transformer-based decoder.

RAG for in-context learning, which retrieves similar examples and build prompt for generation, also works in code summary. REDCODER [38] works for both code generation and summary, and it replaces the retriever with GraphCodeBert [104] for code summary task. ASAP [185] retrieves similar code with BM25, and generates summary with GPT models.

3) **Code Completion:** Code completion can be thought of as the coding equivalent of the "next sentence prediction" task. ReACC [132] follows the few-shot learning paradigm, retrieving similar codes to build prompts for generation. For retrieval, it uses hybrid retriever, which combines sparse and dense retrieval; for generation, it uses CodeGPT-adapted [223]. RepoCoder [197] steps further to perform iterative retrieval and generation to bridge the gap between the retrieval context and the intended completion target. In each iteration, for retrieval, the code query is augmented with previously generated code; for generation, the prompt is formed by combining the newest retrieved codes with the code query. Other than combining retrieval results in prompts, the retrieval-and-edit framework [140] first retrieves similar training examples using dense retrieval, then encodes the input and the retrieved result separately, finally combine them through attention for later LSTM decoder. CoCoMic [224] builds a project context graph for the whole code project, and retrieves top-k neighbors of the input source code. It generates representations of both source code and retrieved contexts, then jointly processes the embeddings to complete the code.

4) **Automatic Program Repair:** Buggy code can take a lot of effort to fix. Automatic program repair leverages generative models to output the correct version. RAG technique is widely used for few-shot learning in automatic program repair [130], [131], [174], [189], [190]. Among them, RING [190] retrieves similar error messages based on both sparse and dense vectors, then builds prompt for the generator Codex [2]. CEDAR [130] applies for both assertion generation and program repairs tasks; it uses sparse and dense retrieval to search for similar codes, then forms prompt for Codex to generate results.

InferFix [131] crafts a prompt carrying the bug type, location, relevant syntax hierarchies, and similar fixes through dense retrieval. Then it also uses Codex for generation. RAP-Gen [174] also retrieves similar buggy codes and corresponding fixes through hybrid retriever (including both sparse and dense retriever). It finetunes CodeT5 [105] with this RAG paradigm. SARGAM [189] searches similar buggy code using dense retrieval, generates patches using augmented input, then applies another model to modify the final result. These research works also involve error localization, which is not our focus.

5) **Text-to-SQL and Code-based Semantic Parsing:** Semantic parsing is the task of translating natural language utterances to unambiguous structured meaning representations, where code language is often leveraged to augment this process. SQL is not only a programming language but can also be considered as a structured representation, so we place text-to-SQL (a special case of code generation) in this subsection. Related research works all apply retrieval-augmented few-shot learning. XRICL [178] focuses on the problem of translating non-English utterances into SQL queries. It searches and reranks English utterance using non-English ones by dense retrieval, then builds prompt for Codex to generate SQL queries. SYNCHROMESH [120] proposes constrained semantic decoding to enforce rich syntactic and semantic constraints during generation of SQL or other languages. It uses the similarity between abstract syntax trees (AST) to finetune the dense retriever S-Bert. During inference, similar NL and SQL are retrieved to form the prompt of GPT-3. CodeICL [225] uses Python for semantic parsing, and augments prompts with a structured domain description for GPT generation. In few-shot learning setting, it leverages BM25 sparse retrieval to find similar training examples.

6) **Others:** There are several other code-related tasks that adopt RAG paradigm. In [226] for numerical reasoning task, the Chain-of-Thought is replaced with the programs as the intermediate reasoning step, and dense retrieval-based similar examples are augmented in prompt for downstream LLMs. E&V [227] leverages an LLM-based agent for program static analysis. The agent uses source code retrieval, pseudo-code execution, execution specifications verification, and other tools to form intermediate results. The retrieval is implemented by AST pattern matching. StackSpotAI [228] builds an AI coding assistant, which incorporates many code-related tasks. It implements an RAG component, identifying the most relevant pieces of information which serve as the context for GPT generation.

### C. RAG for Audio

1) **Audio Generation:** The goal of audio generation is to generate audio with natural language input. Re-AudioLDM [157] adopts dense retriever CLAP [25] to retrieve similar caption-audio pairs given input prompt. The generator, latent diffusion model and VAE-based decoder, take the representations of input text and retrieved pairs as input and generate output audio. Make-An-Audio [42] uses dense retriever CLAP [25] to augment data, retrieving related audio given natural language text. It then constructs pseudo prompts for diffusion-based text-to-audio model training.

2) **Audio Captioning:** The goal of audio captioning is to generate natural language data with audio data, which is basically a sequence-to-sequence task. RECAP [229] leverages CLAP [25] to retrieve related captions given audio data. The retrieved captions are then included into the prompt input for GPT-2 model, which interacts with audio embeddings through cross attention. In [41], dense retriever VGGish [106] is adopted to produce dense embedding of audio data, and GPT-2 is adopted to generate representations of the retrieved captions which are paired with similar audios. After obtaining the representations of audios and captions, an extra multi-head attention block and a linear layer fuses all the information and generates the output. Some research studies transform audio modality to text, in order to leverage advancements in LLMs [230]–[232]. They take advantage of deep retrieval models, aligning the modalities into the same latent space for downstream text generation.

### D. RAG for Image

1) **Image Generation:** RAG enhances generative models by incorporating an information retrieval system. For image generation [43], [137], [148]–[150], [150]–[152], [233], this means leveraging retrieved data to produce high-fidelity and faithful images, even for rare or unseen entities. Meanwhile, this approach can also reduce the parameter count and computational cost of the generative model.

RetrieveGAN [43] uses a differentiable retrieval process to select compatible patches from other images as reference for the generation. It adopts the Gumbel-softmax trick to make the retrieval process differentiable, enabling the end-to-end training and the optimization of the embedding function. It also encourages the selection of mutually compatible patches with additional objective functions. RetrieveGAN can generate realistic and diverse images from scene descriptions, where the retrieved patches are reasonable and coherent. IC-GAN [137] models the data distribution as a mixture of conditional distributions around each training instance. It conditions both the generator and the discriminator on instance features, which are obtained from a pre-trained feature extractor. It also uses the nearest neighbors of the conditioning instance as real samples for the discriminator. IC-GAN can generate realistic and diverse images for both labeled and unlabeled datasets, and can transfer to unseen datasets by changing the conditioning instances. IC-GAN can also control the semantics and style of the generated images by swapping the class labels or the instance features. However, using training data itself for retrieval potentially limits the generalization capacity.

KNN-Diffusion [149] uses large-scale retrieval methods to train a diffusion-based model without any text data. The model is conditioned on two inputs: a text or image embedding extracted by CLIP, and the  $k$  nearest neighbors of the embedding from a large image database. The  $k$ NN embeddings help to bridge the gap between the text and image distributions, and to generate images from different domains by simply swapping the database. The model also enables text-driven local semantic manipulations without masks, by fine-tuning the model to predict the original image from a

manipulated version. RDM [150] combines a small diffusion or autoregressive model with a large external image database into a semi-parametric model. During training, the model retrieves a set of nearest neighbors from the database for each training image and conditions the generative model on their CLIP embeddings. This way, the model learns to compose new scenes based on the retrieved visual content. During inference, the model can generalize to novel domains, tasks, and conditions by changing the database or the retrieval strategy. Re-imagen [148] retrieved information from an external multi-modal knowledge base to produce realistic and faithful images, especially for rare or unseen entities. It is based on a cascaded diffusion model that conditions its generation on both the text prompt and the retrieved image-text pairs. It also proposed an interleaved classifier-free guidance schedule to balance the alignment between the text and the retrieval conditions. Re-imagen achieves state-of-the-art performance on COCO and WikiImages datasets, and significantly improves the fidelity of generated images on a new benchmark called EntityDrawBench. X&Fuse [233] is a general approach for conditioning on visual information when generating images from text. It works by concatenating the conditioned image and the noised image before each attention block in a U-Net architecture, and allowing interaction between them via self-attention. Retrieve&Fuse is a special case of X&Fuse, where the conditioned image is retrieved from a large bank of images using a text or image index. X&Fuse has several advantages over alternative methods, such as robustness to spatial differences, no information loss. RPG [77] retrieves representative images to construct informative in-context examples (i.e., image-region pairs), and utilizes multimodal chain-of-thought reasoning [234] to plan out complementary subregions for compositional text-to-image diffusion.

2) **Image Captioning:** Retrieval-augmented Image Captioning is an innovative approach inspired by retrieval-augmented language generation. Unlike traditional image captioning methods that rely solely on the input image, this novel technique usually generates descriptive sentences by leveraging a set of captions retrieved from a datastore in addition to the image itself. Memory-augmented (MA) [162] exploits explicit knowledge from a memory bank to improve the caption generation. The memory bank is constructed by encoding the history context and the target word of each image-text pair in the training data, i.e., image features and past sentence (key) and target word (value). During inference, the model queries the memory bank with the current context vector and retrieves the most similar entries. Then, it computes a distribution over the vocabulary based on the retrieved entries and interpolates it with the original model’s prediction. The main highlights of MA are that it is non-parametric, compatible with any captioning model, and can adapt to larger datasets without additional training. RAMP [235] enhances image paragraph captioning by incorporating the best-retrieved candidate captions through adversarial training. It uses these captions as reference during the training of the discriminator, prompting the generator to include informative content from the retrieved captions into the generated caption. Additionally, RAMP employs a dynamic memory-augmented attention

network to track coverage information and attention history, which helps in avoiding repetitive or incomplete descriptions. A copying mechanism is also integrated, allowing the selection of words from retrieved captions to improve the fluency and informativeness of the generated captions. RA-Transformer [44] adopts a kNN memory to retrieve relevant captions from an external corpus and augment the generation process. It consists of a Transformer-decoder architecture with a kNN-augmented attention layer that combines masked self-attention over the input tokens and cross-attention over the retrieved captions. A learned gate is used to balance the contribution of the local context and the external memory. For retrieval, it employs a CLIP-based visual encoder to perform approximate kNN searches in a visual-semantic space. RA-Transformer achieves competitive performance on the COCO dataset and demonstrates the effectiveness of retrieval abilities for image captioning. EXTRA [236] enhances image captioning by incorporating captions retrieved from similar images. It uses a pretrained Vision and Language (V&L) BERT encoder to jointly process the image and the retrieved captions, creating a rich cross-modal representation. The decoder then attends to both visual and linguistic representations, benefiting from the additional textual context. EXTRA shows that retrieving a sufficient number of captions (e.g.,  $k=5$ ) indeed improves captioning quality. REVEAL [237] is a retrieval-augmented visual language model that learns to encode and retrieve world knowledge from a large-scale memory, using a unified encoder and a diverse set of multimodal sources. It consists of four components: the memory, the encoder, the retriever, and the generator. For image captioning, REVEAL takes an image as input, retrieves relevant knowledge entries from the memory, and fuses them with the image features by introducing an attentive fusion layer that injects retrieval score into the attention calculation procedure. REVEAL is pre-trained on a massive image-text corpus with four knowledge sources: Wikipedia passages and images, web images with alt-text captions, knowledge graph triplets, and visual question answering pairs. SMALLCAP [45] generates a caption conditioned on an input image and related captions retrieved from a datastore of text via image-to-text retrieval. It uses a pre-trained CLIP vision encoder and GPT-2 language decoder, connected by trainable cross-attention layers. The retrieved captions are used as a prompt to the decoder, providing a task demonstration tailored to the input image. SMALLCAP differs from previous work in two main ways, i.e. SMALLCAP employs a straightforward prompt-based conditioning method, wherein retrieved captions are used as a prompt to a language model. Moreover, SMALLCAP is the first to leverage retrieval augmentation for training-free domain transfer and generalization in image captioning task. The Cross-Modal Retrieval and Semantic Refinement (CRSR) method [238] enhances remote sensing image captioning by introducing a novel approach that combines cross-modal retrieval with semantic refinement. It starts by employing a cross-modal retrieval model to fetch relevant sentences for each image, using these sentences as primary semantic information to support the captioning process. To refine this information, a semantic refinement module filters out misleading details and emphasizes visually salient

semantic content. Additionally, a Transformer Mapper network is introduced to expand the representation of image features with learnable queries, capturing more intricate details within the images. The integration of refined semantic tokens and enriched visual features into a cross-modal decoder results in accurate and contextually rich captions.

### E. RAG for Video

1) **Video Captioning:** Video captioning is to describe the visual content with a descriptive utterance. R-ConvED [46] introduces retrieval-augmented mechanism to facilitate the word prediction. It uses Dual Encoding [108] for video-text retrieval, and proposes a convolutional encoder-decoder network for generation. For a given input video, R-ConvED first retrieves top-k relevant sentences and their corresponding video from training set, then feeds these pairs and the input video into the generator separately. The obtained decoder hidden states are combined through attention-like read operation, so that the target word can be predicted using the final representation. CARE [158] utilizes visual encoder, audio encoder, and text encoder for frame, audio, and retrieved texts, respectively. It uses CLIP as retriever, and transformer decoder as generator. The embeddings of the three modalities are combined to augment the decoder, producing global semantic guidance which attends the input embedding, and local semantic guidance which attends the attention layer. EgoInstructor [47] generates captions for first-person view videos. It retrieves relevant exocentric videos and corresponding texts via dense retrieval, then encodes the input egocentric video and the retrieved exocentric videos through a CLIP-based visual encoder and a transformer-decoder-based bottleneck module. Then it generates captions through decoder-based LLM which takes the retrieved texts as input and interacts with encoded videos in gated cross-attention layer.

2) **Video Generation:** Text-to-video generation is to generate video given natural language descriptions. Animate-A-Story [187] develops a framework which can generate high-quality storytelling videos based on texts. It first separates the text into individual plots, and decorates the description using LLM. It then retrieves relevant videos for each plot through a dense retriever [109]. It generates videos through a latent diffusion model, consisting of two branches: a text encoder CLIP, and a structure encoder which takes the estimated depth of the retrieved videos as structure control.

### F. RAG for 3D

1) **Text-to-3D:** Retrieval can be applied to augment the generation of 3D contents. ReMoDiffuse [49] aims at generating motions using diffusion models. It first retrieves relevant motion entities through CLIP given text input, then leverages the information of the text and the retrieved entities through a semantic-modulated attention layer. AMD [156] designs two branches of motion diffusion for fidelity and diversity. The first branch inputs the original prompt text for diffusion; the second branch decomposes the input text into anatomical scripts and retrieve similar reference motions for diffusion. A transformer-based fusion module is further applied to adaptively balance

the result from two branches. RetDream [48] targets general 3D generation, using retrieved 3D assets to augment the process of variational score distillation from 2D diffusion models. Given an input query, it retrieves relevant 3D assets through CLIP, then utilizes the retrieved assets to provide geometric prior and adapted 2D prior. Concretely, retrieved assets not only impose an additional velocity on particles for distribution initialization, but also help optimize the 2D diffusion model through low-rank adaptation.

### G. RAG for Knowledge

Structured knowledge, including knowledge base and knowledge graph, is widely used in language tasks. It usually serves as the retrieval source to augment generation.

1) **Knowledge Base Question Answering:** Knowledge base question answering involves leveraging a knowledge base to identify the correct answer to a question. Many semantic parsing methods are proposed, which generate logical forms (e.g. SPARQL) given a question.

ReTraCk [239] links entities using mention detection, and retrieves schema items using dense retriever Bert. It then generates logical forms by LSTM, incorporating retrieved items through knowledge-specific rules. For a given query, Unseen Entity Handling [51] retrieves topic entities through FreeBase [240], and concatenates the query with the entity for an encoder-decoder to generate SPARQL output. CBR-KBQA [52] retrieves relevant questions and corresponding logical form answers with roberta-based deep retrieval, then concatenates the question and the retrieved pairs for encoder-decoder transformer model. It also revises the final generation result to align the generated relations with relations present in the local neighborhood of the query entity in the knowledge graph. GMT-KBQA [50] first retrieves relevant entities and relations through bert-based deep retrieval, then concatenates the information for T5 generation. To improve the retrieval result, it leverages cross-encoder to rerank the candidates, and uses the same T5 structure to conduct relation classification and entity disambiguation. RNG-KBQA [121] enumerates candidate logical forms in the knowledge graph, then ranks the candidates and concatenates them with query to form the prompt input to generate final logical form through a T5 model. Based on this idea, TIARA [122] also retrieve entity and schema besides logical forms, while a following work [241] retrieves top-k questions with BM25. Uni-Parser [133] retrieves relevant entities from knowledge graph using mention detection, cross-encoder ranker, and 2-hop paths extraction. It also considers enumerating tables and columns from databases. On obtaining the relevant information, it concatenates the top-k primitives with the query and generates logical forms through T5. UniK-QA [142] concatenates the text forms of the components in a triplet and build document pool for retrieval. For a given question, it leverages dense retriever for relevant documents, then performs fusion-in-decoder technique to incorporate the information for answer generation. SKP [144] performs similar operations as UniK-QA in inference, but adds a pretraining stage with a knowledge-aware MLM loss on triplets and knowledge contrastive loss with respect to the retrieved items.

BLLM augmentation [135] uses TIARA as the retrieval for relevant knowledge base elements, then performs in-context learning through black-box LLM such as GPT-4 for generating logical forms. ECBRF [134] follows the case-based reasoning paradigm [242], retrieving similar triplet with dense retriever and constructing prompt input for BART or GPT-2 in-context learning. DECAF [143] forms Resource Description Format knowledge base triplets into sentences, then concatenates sentences with the same head entity into documents. It retrieves relevant documents using BM25 sparse retrieval or Bert dense retrieval, then leverages Fusion-in-Decoder technique to generate logical form and direct answer given each (query, document) pair as input. It combines the output to obtain the final answer. KD-CoT [145] uses the same dense retriever and fusion-in-decoder generator as DECAF. It follows a Chain-of-Thought paradigm, iteratively performing retrieval, generation, and verification until the CoT is finished. FC-KBQA [243] extracts relevant class, relation, and entity given a question. For class and relation, it uses BM25 as retriever and a Bert-based cross-encoder as re-ranker. For entity, it follows the mention detection paradigm. To compose all the component candidates, it applies T5 model to generate logical expression. Keqing [244] first decomposes a complex question into simple sub-questions through finetuned LLM, then retrieves similar sub-question template by dense retriever RoBERTa to extract candidate entities from knowledge graph, and finally generates answer through ChatGPT given relevant entities as context input. To probe the deep understanding of natural language in LLMs with formal languages, a research work [245] explores the capability of formal language understanding and formal language generation. It leverages retrieved pairs to perform in-context learning. For understanding, it uses tree edit distance to retrieve similar logical forms, while for generation, it uses BM25 to retrieve similar natural language queries.

2) **Knowledge Graph Completion:** Knowledge graph is consisted of triplets, including head entity, relation, and tail entity. The task of knowledge graph completion is to predict the missing entity in an incomplete triplet.

ReSKGC [146] linearizes all training triplets into text by concatenation, then retrieves relevant triplets using BM25, and generates completed triplet using T5 with fusion-in-decoder.

## H. RAG for Science

RAG has also emerged as a promising research direction for many interdisciplinary applications, such as strengthening molecular generation and guiding medical tasks.

1) **Drug Discovery:** The goal of drug discovery is to generate molecules that concurrently fulfill diverse properties. RetMol [53] incorporates a lightweight retrieval mechanism into a pre-trained encoder-decoder generative model. This approach adopts the SMILES string [246] representation of molecules along with the ChemFormer model [247], involving the retrieval and fusion of exemplar molecules with the input molecule. It also utilizes an iterative refinement process to dynamically update both the generated molecules and the retrieval database. Targeted at structure-based drug design (SBDD) [248], [249], PromptDiff [250] proposes an

innovative interaction-based retrieval-augmented 3D molecular diffusion model to facilitate target-aware molecule generation. PromptDiff retrieves a curated set of ligand references, *i.e.*, those with desired properties such as high binding affinity, to steer the diffusion model towards synthesizing ligands that satisfy design criteria. DeepICL [147] constitutes an interaction-focused 3D molecular generative framework with a specific emphasis on modeling protein-ligand interactions, aimed at facilitating a generalizable pocket-constrained ligand design. Utilizing a VAE architecture [251], the encoder module processes protein-ligand complexes into a latent vector, which is combined with retrieved prior knowledge from interaction conditions. This combined information guides the sequential, atom-wise generation of the ligand structure by the decoder module, ensuring that ligand atoms are appropriately placed to facilitate the desired interaction with the target.

2) **Medical Applications:** Several recent studies have improved the expressiveness of LLM by retrieving information from biomedical domain-specific databases, thereby augmenting the model’s capabilities to provide valuable guidance for tasks in the medical field. GeneGPT [54] is a novel method in training a LLM to effectively employ the Web API offered by the National Center for Biotechnology Information (NCBI) for addressing genomics inquiries. It enhances the LLM by integrating domain-specific tools, thereby refining its ability to access biomedical information through the retrieval of such data from the NCBI via API calls. When tasked with GeneTuring tests, GeneGPT instructs Codex [2] to utilize NCBI Web APIs through in-context learning and an augmented decoding algorithm proficient in detecting and executing API calls. Chat-Orthopedist [136] establishes an external knowledge base with information on adolescent idiopathic scoliosis (AIS) disease and treatment options, and develops a retrieval-augmented ChatGPT to feed LLMs with AIS domain knowledge, providing accurate and comprehensible responses to patient inquiries. Utilizing an external AIS knowledge base and a dense retriever, Chat-Orthopedist enhances LLMs with domain-specific knowledge related to scoliosis, avoiding the issue of “molecular hallucinations”.

## V. BENCHMARK

Chen et al. [252] proposed an RAG benchmark, which evaluates RAG from four aspects: Noise Robustness, Negative Rejection, Information Integration, and Counterfactual Robustness, respectively. Noise Robustness evaluates whether LLMs could extract the necessary information from documents containing noisy information. The noisy information is relevant to the input query but useless for answering it. Negative Rejection measures whether LLMs would reject to respond the query when the retrieved content is not enough. Information Integration assesses whether LLMs could acquire knowledge and make responses by integrating multiple retrieved contents. Counterfactual Robustness refers to the ability of LLMs to identify counterfactual errors in the retrieved content.

Another three benchmarks, RAGAS [253], ARES [254] and TruLens [255], considers three different aspects: Faithfulness, Answer Relevance, and Context Relevance, respectively. Faithfulness focuses on the factual errors in the results when the



correct answers can be inferred from the retrieved contents. Answer Relevance measures whether the generated results actually address the problems (i.e., queries) or not. Context Relevance judges whether the retrieved contents contain as much knowledge as possible to answer the queries, and as little irrelevant information as possible.

CRUD-RAG [256] divides all RAG tasks into four categories, which are Create, Read, Update, and Delete, respectively, and also evaluates each category using text continuation, question answering (with single- and multi-document questions), hallucination modification, and open-domain multi-document summary.

## VI. DISCUSSION

### A. Limitations

Despite the widespread adoption of RAG in various applications, there are indeed some limitations in terms of effectiveness and efficiency. In this paper, we summarize the limitations of RAG and deliver in-depth discussion.

1) **Noises in Retrieval Results:** Information retrieval cannot yield perfect results because information loss appears in representations generated by encoder models. Additionally, ANN search can also provide approximate results rather than exact ones. Consequently, certain degree of noise is inevitable in retrieval results, manifesting as irrelevant objects or misleading information, which may cause failure points in RAG systems [257]. Though the common sense is that increasing the accuracy of retrieval will contribute to the effectiveness of RAG, a recent study surprisingly shows that noisy retrieval results may conversely help improve the generation quality [258]. A possible explanation is that diversity in retrieval results may also be necessary for prompt construction [259]. As a result, the impact of noise in retrieval results remains uncertain, leading to confusion regarding which metric to employ for retrieval and how to facilitate the interaction between the retriever and the generator. Subsequent research on this topic is anticipated to demystify the confusion.

2) **Extra Overhead:** While retrieval can help mitigate the costs of generation in certain cases [28]–[30], the incorporation of retrieval sometimes introduces non-negligible overhead. Considering that RAG is primarily employed to improve the performance of existing generative models, the inclusion of additional retrieval and interaction processes leads to increased latency. Worse still, when combined with complex enhancement methods, such as recursive retrieval [166] and iterative RAG [197], the extra overhead will become even more significant. Furthermore, as the scale of retrieval expands, the storage and access complexity associated with data sources will also increase. In presence, RAG systems exhibit a trade-off between costs and benefits. Looking ahead, we anticipate further optimization to alleviate the associated overhead.

3) **Interaction of Retrieval and Generation:** Achieving seamless integration between the retrieval and generation components requires meticulous design and optimization. Given that the objectives of the retriever and generator are not aligned, and that the two models may not share the same latent space, designing and optimizing the interaction between

these two components encounter challenges. As introduced in Section III, numerous approaches have been proposed to enable effective RAG, and these approaches either disentangle the retrieval and generation processes or integrate them at an intermediate stage. While the former is more modularized, the latter could potentially benefit from joint training. Till not, there lacks a sufficient comparison of different ways of interaction across various scenarios.

The tuning of RAG systems is also challenging. A recent study on the trade-off between attribution and fluency in prompt-augmentation-style RAG demonstrates that using top-k retrieval for generation improves attribution, but hurts fluency in turns [260]. The counter effects of different aspects in RAG, such as metric selection and hyper-parameter tuning, remains unexplored. Therefore, further refinement of RAG systems, both in terms of algorithms and deployment, is necessary to fully unlock their potentials.

4) **Long Context Generation:** One of the primary challenges in early stage RAG, which leverages prompt augmentation, is the inherent context length limitation of the generators. The research advancements in prompt compression [183] and long-context support [261] have partially mitigated this challenge, albeit with a slight trade-off in accuracy or costs. Given this challenge, a recent notion appears that “long-context models like Gemini 1.5 will replace RAG”. Nevertheless, this assertion does not hold true — RAG exhibits greater flexibility in managing dynamic information, encompassing both up-to-date and long-tail knowledge [262]. We believe that RAG in the future will take advantage of long context generation to achieve even better performance, rather than simply being weeded out by it.

### B. Potential Future Directions

Last but not least, we wish to identify a series of possible directions for the future research and applications of RAG.

1) **More Advanced Research on RAG Methodologies, Enhancements, and Applications:** A straight-forward research direction is to develop more advanced methodologies, enhancements, and applications of RAG.

As introduced in Section III-A, existing works have explored various interaction patterns between retrievers and generators. However, since the optimization target of these two components are distinct, the practical augmentation process has a large impact on the final generation results. Investigation of more advanced foundations for augmentation holds promise for fully unleashing the potential of RAG.

Based on a constructed RAG system, enhancements are helpful to improve the effectiveness of certain components or the entire pipeline. Given the inherent complexity of the system, there exists significant potential for RAG to improve, necessitating proper tuning and careful engineering. We look forward to further experimental analysis and in-depth exploration that will contribute to the development of more effective and more robust RAG systems.

As introduced in Section IV, RAG is a general technique that has been applied across diverse modalities and tasks. Yet most of existing works straightforwardly integrate external

knowledge with the specific generation tasks, without thoroughly taking into account the key characteristics of the target domains. Therefore, for generation tasks that do not fully leverage the power of RAG, we are confident that designing proper RAG system will be beneficial.

2) **Efficient Deployment and Processing:** Currently, several deployment solutions of query-based RAG for LLMs have been proposed, such as LangChain [263] and LLAMA-Index [169]. However, for other types of RAG and generation tasks, there lacks a plug-and-play solution. In addition, given the extra overhead introduced by retrieval, and considering that the complexities of both the retriever and generator will continue to grow, achieving efficient processing in RAG remains a challenge, necessitating targeted system optimization.

3) **Incorporating Long-tail and Real-time Knowledge:** While a key motivation of RAG is to harness real-time and long-tail knowledge, the pipeline for knowledge updating and expansion remains unexplored. Many existing works make up the retrieval sources with merely the training data of generators, thereby neglecting the dynamic and flexible information advantages that could have been offered by retrieval. As a consequence, designing a useful RAG system with continuously updated knowledge and/or flexible knowledge sources, along with corresponding system-level optimizations, is a growing research direction. With the capability of utilizing long-tail knowledge, we also expect RAG to leverage personalized information and features, so as to adapt to today’s web service.

4) **Combined with Other Techniques:** In essential, RAG is orthogonal to other techniques that share the goal of improving AIGC effectiveness, including fine tuning, reinforcement learning, chain-of-thought, agent-based generation, and other potential optimizations. However, the exploration of simultaneously applying these techniques is still in its early stages, calling for further research to delve into algorithm design and fully leverage their potential.

## VII. CONCLUSION

In this paper, we conduct a thorough and comprehensive survey on RAG in the scenarios related to AIGC, with a particular focus on augmentation foundations, enhancements, and practical applications. We first systematically organize and summarize the foundation paradigms in RAG, providing insights into the interaction between the retriever and the generator. Based on constructed RAG systems, we review the enhancements that further improve the effectiveness of RAG, including the enhancements on input, retriever, generator, and results. To facilitate researchers across diverse domains, we showcase practical applications of RAG in a range of modalities and tasks. Finally, we also present existing benchmarks for RAG, discuss current limitations of RAG, and shed light on promising future directions.

## REFERENCES

[1] T. B. Brown, B. Mann, N. Ryder, M. Subbiah, J. Kaplan, P. Dhariwal, A. Neelakantan, P. Shyam, G. Sastry, A. Askell, S. Agarwal, A. Herbert-Voss, G. Krueger, T. Henighan, R. Child, A. Ramesh, D. M. Ziegler, J. Wu, C. Winter, C. Hesse, M. Chen, E. Sigler, M. Litwin, S. Gray, B. Chess, J. Clark, C. Berner,

S. McCandlish, A. Radford, I. Sutskever, and D. Amodei, “Language models are few-shot learners,” in *Advances in Neural Information Processing Systems 33: Annual Conference on Neural Information Processing Systems 2020, NeurIPS 2020, December 6-12, 2020, virtual*, H. Larochelle, M. Ranzato, R. Hadsell, M. Balcan, and H. Lin, Eds., 2020. [Online]. Available: <https://proceedings.neurips.cc/paper/2020/hash/1457c0d6bfbcb4967418bfb8ac142f64a-Abstract.html>

[2] M. Chen, J. Tworek, H. Jun, Q. Yuan, H. P. de Oliveira Pinto, J. Kaplan, H. Edwards, Y. Burda, N. Joseph, G. Brockman, A. Ray, R. Puri, G. Krueger, M. Petrov, H. Khlaaf, G. Sastry, P. Mishkin, B. Chan, S. Gray, N. Ryder, M. Pavlov, A. Power, L. Kaiser, M. Bavarian, C. Winter, P. Tillet, F. P. Such, D. Cummings, M. Plappert, F. Chantzis, E. Barnes, A. Herbert-Voss, W. H. Guss, A. Nichol, A. Paino, N. Tezak, J. Tang, I. Babuschkin, S. Balaji, S. Jain, W. Saunders, C. Hesse, A. N. Carr, J. Leike, J. Achiam, V. Misra, E. Morikawa, A. Radford, M. Knight, M. Brundage, M. Murati, K. Mayer, P. Welinder, B. McGrew, D. Amodei, S. McCandlish, I. Sutskever, and W. Zaremba, “Evaluating large language models trained on code,” *CoRR*, vol. abs/2107.03374, 2021. [Online]. Available: <https://arxiv.org/abs/2107.03374>

[3] OpenAI, “GPT-4 technical report,” *CoRR*, vol. abs/2303.08774, 2023. [Online]. Available: <https://doi.org/10.48550/arXiv.2303.08774>

[4] H. Touvron, T. Lavril, G. Izacard, X. Martinet, M. Lachaux, T. Lacroix, B. Rozière, N. Goyal, E. Hambro, F. Azhar, A. Rodriguez, A. Joulin, E. Grave, and G. Lample, “Llama: Open and efficient foundation language models,” *CoRR*, vol. abs/2302.13971, 2023. [Online]. Available: <https://doi.org/10.48550/arXiv.2302.13971>

[5] H. Touvron, L. Martin, K. Stone, P. Albert, A. Almahairi, Y. Babaei, N. Bashlykov, S. Batra, P. Bhargava, S. Bhosale, D. Bikel, L. Blecher, C. Canton-Ferrer, M. Chen, G. Cucurull, D. Esiobu, J. Fernandez, J. Fu, W. Fu, B. Fuller, C. Gao, V. Goswami, N. Goyal, A. Hartshorn, S. Hosseini, R. Hou, H. Inan, M. Kardas, V. Kerkez, M. Khabsa, I. Kloumann, A. Korenev, P. S. Koura, M. Lachaux, T. Lavril, J. Lee, D. Liskovitch, Y. Lu, Y. Mao, X. Martinet, T. Mihaylov, P. Mishra, I. Molybog, Y. Nie, A. Poulton, J. Reizenstein, R. Rungta, K. Saladi, A. Schelten, R. Silva, E. M. Smith, R. Subramanian, X. E. Tan, B. Tang, R. Taylor, A. Williams, J. X. Kuan, P. Xu, Z. Yan, I. Zarov, Y. Zhang, A. Fan, M. Kambadur, S. Narang, A. Rodriguez, R. Stojnic, S. Edunov, and T. Scialom, “Llama 2: Open foundation and fine-tuned chat models,” *CoRR*, vol. abs/2307.09288, 2023. [Online]. Available: <https://doi.org/10.48550/arXiv.2307.09288>

[6] B. Rozière, J. Gehring, F. Gloeckle, S. Sootla, I. Gat, X. E. Tan, Y. Adi, J. Liu, T. Remez, J. Rapin, A. Kozhevnikov, I. Evtimov, J. Bitton, M. Bhatt, C. Canton-Ferrer, A. Grattafiori, W. Xiong, A. Défossez, J. Copet, F. Azhar, H. Touvron, L. Martin, N. Usunier, T. Scialom, and G. Synnaeve, “Code llama: Open foundation models for code,” *CoRR*, vol. abs/2308.12950, 2023. [Online]. Available: <https://doi.org/10.48550/arXiv.2308.12950>

[7] A. Ramesh, M. Pavlov, G. Goh, S. Gray, C. Voss, A. Radford, M. Chen, and I. Sutskever, “Zero-shot text-to-image generation,” in *Proceedings of the 38th International Conference on Machine Learning, ICML 2021, 18-24 July 2021, Virtual Event*, ser. *Proceedings of Machine Learning Research*, M. Meila and T. Zhang, Eds., vol. 139. PMLR, 2021, pp. 8821–8831. [Online]. Available: <http://proceedings.mlr.press/v139/ramesh21a.html>

[8] A. Ramesh, P. Dhariwal, A. Nichol, C. Chu, and M. Chen, “Hierarchical text-conditional image generation with CLIP latents,” *CoRR*, vol. abs/2204.06125, 2022. [Online]. Available: <https://doi.org/10.48550/arXiv.2204.06125>

[9] J. Betker, G. Goh, L. Jing, T. Brooks, J. Wang, L. Li, L. Ouyang, J. Zhuang, J. Lee, Y. Guo et al., “Improving image generation with better captions,” *Computer Science*. <https://cdn.openai.com/papers/dall-e-3.pdf>, vol. 2, no. 3, p. 8, 2023.

[10] R. Rombach, A. Blattmann, D. Lorenz, P. Esser, and B. Ommer, “High-resolution image synthesis with latent diffusion models,” in *IEEE/CVF Conference on Computer Vision and Pattern Recognition, CVPR 2022, New Orleans, LA, USA, June 18-24, 2022*. IEEE, 2022, pp. 10 674–10 685. [Online]. Available: <https://doi.org/10.1109/CVPR52688.2022.01042>

[11] OpenAI, “Video generation models as world simulators,” <https://openai.com/research/video-generation-models-as-world-simulators>, 2024.

[12] S. Hochreiter and J. Schmidhuber, “Long short-term memory,” *Neural Comput.*, vol. 9, no. 8, pp. 1735–1780, 1997. [Online]. Available: <https://doi.org/10.1162/neco.1997.9.8.1735>

[13] A. Vaswani, N. Shazeer, N. Parmar, J. Uszkoreit, L. Jones, A. N. Gomez, L. Kaiser, and I. Polosukhin, “Attention is all you need,” in *Advances in Neural Information Processing*

- Systems 30: Annual Conference on Neural Information Processing Systems 2017, December 4-9, 2017, Long Beach, CA, USA, I. Guyon, U. von Luxburg, S. Bengio, H. M. Wallach, R. Fergus, S. V. N. Vishwanathan, and R. Garnett, Eds., 2017, pp. 5998–6008. [Online]. Available: <https://proceedings.neurips.cc/paper/2017/hash/3f5ee243547dee91fbd053c1c4a845aa-Abstract.html>
- [14] I. J. Goodfellow, J. Pouget-Abadie, M. Mirza, B. Xu, D. Warde-Farley, S. Ozair, A. C. Courville, and Y. Bengio, “Generative adversarial networks,” *Commun. ACM*, vol. 63, no. 11, pp. 139–144, 2020. [Online]. Available: <https://doi.org/10.1145/3422622>
- [15] J. Devlin, M. Chang, K. Lee, and K. Toutanova, “BERT: pre-training of deep bidirectional transformers for language understanding,” in *Proceedings of the 2019 Conference of the North American Chapter of the Association for Computational Linguistics: Human Language Technologies, NAACL-HLT 2019, Minneapolis, MN, USA, June 2-7, 2019, Volume 1 (Long and Short Papers)*, J. Burstein, C. Doran, and T. Solorio, Eds. Association for Computational Linguistics, 2019, pp. 4171–4186. [Online]. Available: <https://doi.org/10.18653/v1/n19-1423>
- [16] C. Raffel, N. Shazeer, A. Roberts, K. Lee, S. Narang, M. Matena, Y. Zhou, W. Li, and P. J. Liu, “Exploring the limits of transfer learning with a unified text-to-text transformer,” *J. Mach. Learn. Res.*, vol. 21, pp. 140:1–140:67, 2020. [Online]. Available: <http://jmlr.org/papers/v21/20-074.html>
- [17] J. Kaplan, S. McCandlish, T. Henighan, T. B. Brown, B. Chess, R. Child, S. Gray, A. Radford, J. Wu, and D. Amodei, “Scaling laws for neural language models,” *CoRR*, vol. abs/2001.08361, 2020. [Online]. Available: <https://arxiv.org/abs/2001.08361>
- [18] S. E. Robertson and H. Zaragoza, “The probabilistic relevance framework: BM25 and beyond,” *Found. Trends Inf. Retr.*, vol. 3, no. 4, pp. 333–389, 2009. [Online]. Available: <https://doi.org/10.1561/1500000019>
- [19] V. Karpukhin, B. Oguz, S. Min, P. S. H. Lewis, L. Wu, S. Edunov, D. Chen, and W. Yih, “Dense passage retrieval for open-domain question answering,” in *Proceedings of the 2020 Conference on Empirical Methods in Natural Language Processing, EMNLP 2020, Online, November 16-20, 2020*, B. Webber, T. Cohn, Y. He, and Y. Liu, Eds. Association for Computational Linguistics, 2020, pp. 6769–6781. [Online]. Available: <https://doi.org/10.18653/v1/2020.emnlp-main.550>
- [20] J. Johnson, M. Douze, and H. Jégou, “Billion-scale similarity search with gpus,” *IEEE Trans. Big Data*, vol. 7, no. 3, pp. 535–547, 2021. [Online]. Available: <https://doi.org/10.1109/TBDDATA.2019.2921572>
- [21] Q. Chen, B. Zhao, H. Wang, M. Li, C. Liu, Z. Li, M. Yang, and J. Wang, “SPANN: highly-efficient billion-scale approximate nearest neighborhood search,” in *Advances in Neural Information Processing Systems 34: Annual Conference on Neural Information Processing Systems 2021, NeurIPS 2021, December 6-14, 2021, virtual*, M. Ranzato, A. Beygelzimer, Y. N. Dauphin, P. Liang, and J. W. Vaughan, Eds., 2021, pp. 5199–5212. [Online]. Available: <https://proceedings.neurips.cc/paper/2021/hash/299dc35e747eb77177d9cea10a802da2-Abstract.html>
- [22] R. Datta, D. Joshi, J. Li, and J. Z. Wang, “Image retrieval: Ideas, influences, and trends of the new age,” *ACM Comput. Surv.*, vol. 40, no. 2, pp. 5:1–5:60, 2008. [Online]. Available: <https://doi.org/10.1145/1348246.1348248>
- [23] A. Radford, J. W. Kim, C. Hallacy, A. Ramesh, G. Goh, S. Agarwal, G. Sastry, A. Askell, P. Mishkin, J. Clark et al., “Learning transferable visual models from natural language supervision,” in *International conference on machine learning*. PMLR, 2021, pp. 8748–8763.
- [24] Z. Feng, D. Guo, D. Tang, N. Duan, X. Feng, M. Gong, L. Shou, B. Qin, T. Liu, D. Jiang, and M. Zhou, “Codebert: A pre-trained model for programming and natural languages,” in *Findings of the Association for Computational Linguistics: EMNLP 2020, Online Event, 16-20 November 2020*, ser. Findings of ACL, T. Cohn, Y. He, and Y. Liu, Eds., vol. EMNLP 2020. Association for Computational Linguistics, 2020, pp. 1536–1547. [Online]. Available: <https://doi.org/10.18653/v1/2020.findings-emnlp.139>
- [25] Y. Wu, K. Chen, T. Zhang, Y. Hui, T. Berg-Kirkpatrick, and S. Dubnov, “Large-scale contrastive language-audio pretraining with feature fusion and keyword-to-caption augmentation,” in *IEEE International Conference on Acoustics, Speech and Signal Processing ICASSP 2023, Rhodes Island, Greece, June 4-10, 2023*. IEEE, 2023, pp. 1–5. [Online]. Available: <https://doi.org/10.1109/ICASSP49357.2023.10095969>
- [26] A. Mallen, A. Asai, V. Zhong, R. Das, D. Khashabi, and H. Hajishirzi, “When not to trust language models: Investigating effectiveness of parametric and non-parametric memories,” in *Proceedings of the 61st Annual Meeting of the Association for Computational Linguistics (Volume 1: Long Papers)*, ACL 2023, Toronto, Canada, July 9-14, 2023, A. Rogers, J. L. Boyd-Graber, and N. Okazaki, Eds. Association for Computational Linguistics, 2023, pp. 9802–9822. [Online]. Available: <https://doi.org/10.18653/v1/2023.acl-long.546>
- [27] N. Carlini, F. Tramèr, E. Wallace, M. Jagielski, A. Herbert-Voss, K. Lee, A. Roberts, T. B. Brown, D. Song, Ú. Erlingsson, A. Oprea, and C. Raffel, “Extracting training data from large language models,” in *30th USENIX Security Symposium, USENIX Security 2021, August 11-13, 2021*, M. D. Bailey and R. Greenstadt, Eds. USENIX Association, 2021, pp. 2633–2650. [Online]. Available: <https://www.usenix.org/conference/usenixsecurity21/presentation/carlini-extracting>
- [28] G. Izacard, P. S. H. Lewis, M. Lomeli, L. Hosseini, F. Petroni, T. Schick, J. Dwivedi-Yu, A. Joulin, S. Riedel, and E. Grave, “Atlas: Few-shot learning with retrieval augmented language models,” *J. Mach. Learn. Res.*, vol. 24, pp. 251:1–251:43, 2023. [Online]. Available: <http://jmlr.org/papers/v24/23-0037.html>
- [29] Y. Wu, M. N. Rabe, D. Hutchins, and C. Szegedy, “Memorizing transformers,” in *The Tenth International Conference on Learning Representations, ICLR 2022, Virtual Event, April 25-29, 2022*. OpenReview.net, 2022. [Online]. Available: <https://openreview.net/forum?id=TrjbxzRcnf->
- [30] Z. He, Z. Zhong, T. Cai, J. D. Lee, and D. He, “REST: retrieval-based speculative decoding,” *CoRR*, vol. abs/2311.08252, 2023. [Online]. Available: <https://doi.org/10.48550/arXiv.2311.08252>
- [31] K. Guu, K. Lee, Z. Tung, P. Pasupat, and M. Chang, “REALM: retrieval-augmented language model pre-training,” *CoRR*, vol. abs/2002.08909, 2020. [Online]. Available: <https://arxiv.org/abs/2002.08909>
- [32] P. S. H. Lewis, E. Perez, A. Piktus, F. Petroni, V. Karpukhin, N. Goyal, H. Küttler, M. Lewis, W. Yih, T. Rocktäschel, S. Riedel, and D. Kiela, “Retrieval-augmented generation for knowledge-intensive NLP tasks,” in *Advances in Neural Information Processing Systems 33: Annual Conference on Neural Information Processing Systems 2020, NeurIPS 2020, December 6-12, 2020, virtual*, H. Larochelle, M. Ranzato, R. Hadsell, M. Balcan, and H. Lin, Eds., 2020. [Online]. Available: <https://proceedings.neurips.cc/paper/2020/hash/6b493230205f780e1bc26945df7481e5-Abstract.html>
- [33] G. Izacard and E. Grave, “Leveraging passage retrieval with generative models for open domain question answering,” in *Proceedings of the 16th Conference of the European Chapter of the Association for Computational Linguistics: Main Volume, EACL 2021, Online, April 19 - 23, 2021*, P. Merlo, J. Tiedemann, and R. Tsarfaty, Eds. Association for Computational Linguistics, 2021, pp. 874–880. [Online]. Available: <https://doi.org/10.18653/v1/2021.eacl-main.74>
- [34] S. Borgeaud, A. Mensch, J. Hoffmann, T. Cai, E. Rutherford, K. Millican, G. van den Driessche, J. Lespiau, B. Damoc, A. Clark, D. de Las Casas, A. Guy, J. Menick, R. Ring, T. Hennigan, S. Huang, L. Maggiore, C. Jones, A. Cassirer, A. Brock, M. Paganini, G. Irving, O. Vinyals, S. Osindero, K. Simonyan, J. W. Rae, E. Elsen, and L. Sifre, “Improving language models by retrieving from trillions of tokens,” in *International Conference on Machine Learning, ICML 2022, 17-23 July 2022, Baltimore, Maryland, USA*, ser. Proceedings of Machine Learning Research, K. Chaudhuri, S. Jegelka, L. Song, C. Szepesvári, G. Niu, and S. Sabato, Eds., vol. 162. PMLR, 2022, pp. 2206–2240. [Online]. Available: <https://proceedings.mlr.press/v162/borgeaud22a.html>
- [35] U. Khandelwal, O. Levy, D. Jurafsky, L. Zettlemoyer, and M. Lewis, “Generalization through memorization: Nearest neighbor language models,” in *8th International Conference on Learning Representations, ICLR 2020, Addis Ababa, Ethiopia, April 26-30, 2020*. OpenReview.net, 2020. [Online]. Available: <https://openreview.net/forum?id=Hk1BjCEKvH>
- [36] J. He, G. Neubig, and T. Berg-Kirkpatrick, “Efficient nearest neighbor language models,” in *Proceedings of the 2021 Conference on Empirical Methods in Natural Language Processing, EMNLP 2021, Virtual Event / Punta Cana, Dominican Republic, 7-11 November, 2021*, M. Moens, X. Huang, L. Specia, and S. W. Yih, Eds. Association for Computational Linguistics, 2021, pp. 5703–5714. [Online]. Available: <https://doi.org/10.18653/v1/2021.emnlp-main.461>
- [37] zilliztech. (2023) Gptcache. [Online]. Available: <https://github.com/zilliztech/GPTCache>
- [38] M. R. Parvez, W. U. Ahmad, S. Chakraborty, B. Ray, and K. Chang, “Retrieval augmented code generation and summarization,” in *Findings of the Association for Computational Linguistics: EMNLP 2021, Virtual Event / Punta Cana, Dominican Republic, 16-20 November, 2021*, M. Moens, X. Huang, L. Specia, and S. W. Yih, Eds. Association

- for Computational Linguistics, 2021, pp. 2719–2734. [Online]. Available: <https://doi.org/10.18653/v1/2021.findings-emnlp.232>
- [39] W. U. Ahmad, S. Chakraborty, B. Ray, and K. Chang, “Unified pre-training for program understanding and generation,” in *Proceedings of the 2021 Conference of the North American Chapter of the Association for Computational Linguistics: Human Language Technologies, NAACL-HLT 2021, Online, June 6-11, 2021*, K. Toutanova, A. Rumshisky, L. Zettlemoyer, D. Hakkani-Tür, I. Beltagy, S. Bethard, R. Cotterell, T. Chakraborty, and Y. Zhou, Eds. Association for Computational Linguistics, 2021, pp. 2655–2668. [Online]. Available: <https://doi.org/10.18653/v1/2021.naacl-main.211>
- [40] S. Zhou, U. Alon, F. F. Xu, Z. Jiang, and G. Neubig, “Docprompting: Generating code by retrieving the docs,” in *The Eleventh International Conference on Learning Representations, ICLR 2023, Kigali, Rwanda, May 1-5, 2023*. OpenReview.net, 2023. [Online]. Available: <https://openreview.net/pdf?id=ZTCxT2t2Ru>
- [41] Y. Koizumi, Y. Ohishi, D. Niizumi, D. Takeuchi, and M. Yasuda, “Audio captioning using pre-trained large-scale language model guided by audio-based similar caption retrieval,” *CoRR*, vol. abs/2012.07331, 2020. [Online]. Available: <https://arxiv.org/abs/2012.07331>
- [42] R. Huang, J. Huang, D. Yang, Y. Ren, L. Liu, M. Li, Z. Ye, J. Liu, X. Yin, and Z. Zhao, “Make-an-audio: Text-to-audio generation with prompt-enhanced diffusion models,” in *International Conference on Machine Learning, ICML 2023, 23-29 July 2023, Honolulu, Hawaii, USA*, ser. *Proceedings of Machine Learning Research*, A. Krause, E. Brunskill, K. Cho, B. Engelhardt, S. Sabato, and J. Scarlett, Eds., vol. 202. PMLR, 2023, pp. 13 916–13 932. [Online]. Available: <https://proceedings.mlr.press/v202/huang23i.html>
- [43] H.-Y. Tseng, H.-Y. Lee, L. Jiang, M.-H. Yang, and W. Yang, “Retrievegan: Image synthesis via differentiable patch retrieval,” in *Computer Vision–ECCV 2020: 16th European Conference, Glasgow, UK, August 23–28, 2020, Proceedings, Part VIII 16*. Springer, 2020, pp. 242–257.
- [44] S. Sarto, M. Cornia, L. Baraldi, and R. Cucchiara, “Retrieval-augmented transformer for image captioning,” in *Proceedings of the 19th International Conference on Content-based Multimedia Indexing, 2022*, pp. 1–7.
- [45] R. Ramos, B. Martins, D. Elliott, and Y. Kementchedjheva, “Smallcap: lightweight image captioning prompted with retrieval augmentation,” in *Proceedings of the IEEE/CVF Conference on Computer Vision and Pattern Recognition, 2023*, pp. 2840–2849.
- [46] J. Chen, Y. Pan, Y. Li, T. Yao, H. Chao, and T. Mei, “Retrieval augmented convolutional encoder-decoder networks for video captioning,” *ACM Trans. Multim. Comput. Commun. Appl.*, vol. 19, no. 1s, pp. 48:1–48:24, 2023. [Online]. Available: <https://doi.org/10.1145/3539225>
- [47] J. Xu, Y. Huang, J. Hou, G. Chen, Y. Zhang, R. Feng, and W. Xie, “Retrieval-augmented egocentric video captioning,” *CoRR*, vol. abs/2401.00789, 2024. [Online]. Available: <https://doi.org/10.48550/arXiv.2401.00789>
- [48] J. Seo, S. Hong, W. Jang, I. H. Kim, M. Kwak, D. Lee, and S. Kim, “Retrieval-augmented score distillation for text-to-3d generation,” *CoRR*, vol. abs/2402.02972, 2024. [Online]. Available: <https://doi.org/10.48550/arXiv.2402.02972>
- [49] M. Zhang, X. Guo, L. Pan, Z. Cai, F. Hong, H. Li, L. Yang, and Z. Liu, “Remodiffuse: Retrieval-augmented motion diffusion model,” in *IEEE/CVF International Conference on Computer Vision, ICCV 2023, Paris, France, October 1-6, 2023*. IEEE, 2023, pp. 364–373. [Online]. Available: <https://doi.org/10.1109/ICCV51070.2023.00040>
- [50] X. Hu, X. Wu, Y. Shu, and Y. Qu, “Logical form generation via multi-task learning for complex question answering over knowledge bases,” in *Proceedings of the 29th International Conference on Computational Linguistics, COLING 2022, Gyeongju, Republic of Korea, October 12-17, 2022*, N. Calzolari, C. Huang, H. Kim, J. Pustejovsky, L. Wanner, K. Choi, P. Ryu, H. Chen, L. Donatelli, H. Ji, S. Kurohashi, P. Paggio, N. Xue, S. Kim, Y. Hamm, Z. He, T. K. Lee, E. Santus, F. Bond, and S. Na, Eds. International Committee on Computational Linguistics, 2022, pp. 1687–1696. [Online]. Available: <https://aclanthology.org/2022.coling-1.145>
- [51] X. Huang, J. Kim, and B. Zou, “Unseen entity handling in complex question answering over knowledge base via language generation,” in *Findings of the Association for Computational Linguistics: EMNLP 2021, Virtual Event / Punta Cana, Dominican Republic, 16-20 November, 2021*, M. Moens, X. Huang, L. Specia, and S. W. Yih, Eds. Association for Computational Linguistics, 2021, pp. 547–557. [Online]. Available: <https://doi.org/10.18653/v1/2021.findings-emnlp.150>
- [52] R. Das, M. Zaheer, D. Thai, A. Godbole, E. Perez, J. Y. Lee, L. Tan, L. Polymenakos, and A. McCallum, “Case-based reasoning for natural language queries over knowledge bases,” in *Proceedings of the 2021 Conference on Empirical Methods in Natural Language Processing, EMNLP 2021, Virtual Event / Punta Cana, Dominican Republic, 7-11 November, 2021*, M. Moens, X. Huang, L. Specia, and S. W. Yih, Eds. Association for Computational Linguistics, 2021, pp. 9594–9611. [Online]. Available: <https://doi.org/10.18653/v1/2021.emnlp-main.755>
- [53] Z. Wang, W. Nie, Z. Qiao, C. Xiao, R. Baraniuk, and A. Anandkumar, “Retrieval-based controllable molecule generation,” in *The Eleventh International Conference on Learning Representations, 2022*.
- [54] Q. Jin, Y. Yang, Q. Chen, and Z. Lu, “Genegpt: Augmenting large language models with domain tools for improved access to biomedical information,” *ArXiv*, 2023.
- [55] H. Li, Y. Su, D. Cai, Y. Wang, and L. Liu, “A survey on retrieval-augmented text generation,” *CoRR*, vol. abs/2202.01110, 2022. [Online]. Available: <https://arxiv.org/abs/2202.01110>
- [56] A. Asai, S. Min, Z. Zhong, and D. Chen, “Acl 2023 tutorial: Retrieval-based language models and applications,” *ACL 2023*, 2023.
- [57] Y. Gao, Y. Xiong, X. Gao, K. Jia, J. Pan, Y. Bi, Y. Dai, J. Sun, Q. Guo, M. Wang, and H. Wang, “Retrieval-augmented generation for large language models: A survey,” *CoRR*, vol. abs/2312.10997, 2023. [Online]. Available: <https://doi.org/10.48550/arXiv.2312.10997>
- [58] R. Zhao, H. Chen, W. Wang, F. Jiao, D. X. Long, C. Qin, B. Ding, X. Guo, M. Li, X. Li, and S. Joty, “Retrieving multimodal information for augmented generation: A survey,” in *Findings of the Association for Computational Linguistics: EMNLP 2023, Singapore, December 6-10, 2023*, H. Bouamor, J. Pino, and K. Bali, Eds. Association for Computational Linguistics, 2023, pp. 4736–4756. [Online]. Available: <https://aclanthology.org/2023.findings-emnlp.314>
- [59] J. Chen, H. Guo, K. Yi, B. Li, and M. Elhoseiny, “Visualgpt: Data-efficient adaptation of pretrained language models for image captioning,” in *IEEE/CVF Conference on Computer Vision and Pattern Recognition, CVPR 2022, New Orleans, LA, USA, June 18-24, 2022*. IEEE, 2022, pp. 18 009–18 019. [Online]. Available: <https://doi.org/10.1109/CVPR52688.2022.01750>
- [60] Y. Tay, M. Dehghani, D. Bahri, and D. Metzler, “Efficient transformers: A survey,” *ACM Comput. Surv.*, vol. 55, no. 6, pp. 109:1–109:28, 2023. [Online]. Available: <https://doi.org/10.1145/3530811>
- [61] G. V. Houdt, C. Mosquera, and G. Nápoles, “A review on the long short-term memory model,” *Artif. Intell. Rev.*, vol. 53, no. 8, pp. 5929–5955, 2020. [Online]. Available: <https://doi.org/10.1007/s10462-020-09838-1>
- [62] L. Yang, Z. Zhang, Y. Song, S. Hong, R. Xu, Y. Zhao, W. Zhang, B. Cui, and M.-H. Yang, “Diffusion models: A comprehensive survey of methods and applications,” *ACM Computing Surveys*, vol. 56, no. 4, pp. 1–39, 2023.
- [63] J. Sohl-Dickstein, E. Weiss, N. Maheswaranathan, and S. Ganguli, “Deep unsupervised learning using nonequilibrium thermodynamics,” in *International conference on machine learning*. PMLR, 2015, pp. 2256–2265.
- [64] J. Ho, A. Jain, and P. Abbeel, “Denoising diffusion probabilistic models,” *Advances in neural information processing systems*, vol. 33, pp. 6840–6851, 2020.
- [65] A. Q. Nichol and P. Dhariwal, “Improved denoising diffusion probabilistic models,” in *International Conference on Machine Learning*. PMLR, 2021, pp. 8162–8171.
- [66] Y. Song and S. Ermon, “Generative modeling by estimating gradients of the data distribution,” *Advances in neural information processing systems*, vol. 32, 2019.
- [67] Song, Yang and Ermon, Stefano, “Improved techniques for training score-based generative models,” *Advances in neural information processing systems*, vol. 33, pp. 12 438–12 448, 2020.
- [68] Y. Song, J. Sohl-Dickstein, D. P. Kingma, A. Kumar, S. Ermon, and B. Poole, “Score-based generative modeling through stochastic differential equations,” *arXiv preprint arXiv:2011.13456*, 2020.
- [69] Y. Song, C. Durkan, I. Murray, and S. Ermon, “Maximum likelihood training of score-based diffusion models,” *Advances in Neural Information Processing Systems*, vol. 34, pp. 1415–1428, 2021.
- [70] L. Yang, H. Qian, Z. Zhang, J. Liu, and B. Cui, “Structure-guided adversarial training of diffusion models,” *arXiv preprint arXiv:2402.17563*, 2024.
- [71] X. Zhang, L. Yang, Y. Cai, Z. Yu, J. Xie, Y. Tian, M. Xu, Y. Tang, Y. Yang, and B. Cui, “Realcompo: Dynamic equilibrium between realism and compositionality improves text-to-image diffusion models,” *arXiv preprint arXiv:2402.12908*, 2024.

- [72] R. Rombach, A. Blattmann, D. Lorenz, P. Esser, and B. Ommer, “High-resolution image synthesis with latent diffusion models,” 2021.
- [73] A. Ramesh, P. Dhariwal, A. Nichol, C. Chu, and M. Chen, “Hierarchical text-conditional image generation with clip latents,” *arXiv preprint arXiv:2204.06125*, vol. 1, no. 2, p. 3, 2022.
- [74] H. Li, Y. Yang, M. Chang, S. Chen, H. Feng, Z. Xu, Q. Li, and Y. Chen, “Srdiff: Single image super-resolution with diffusion probabilistic models,” *Neurocomputing*, vol. 479, pp. 47–59, 2022.
- [75] J. Ho, C. Saharia, W. Chan, D. J. Fleet, M. Norouzi, and T. Salimans, “Cascaded diffusion models for high fidelity image generation,” *The Journal of Machine Learning Research*, vol. 23, no. 1, pp. 2249–2281, 2022.
- [76] L. Yang, J. Liu, S. Hong, Z. Zhang, Z. Huang, Z. Cai, W. Zhang, and B. Cui, “Improving diffusion-based image synthesis with context prediction,” *Advances in Neural Information Processing Systems*, vol. 36, 2024.
- [77] L. Yang, Z. Yu, C. Meng, M. Xu, S. Ermon, and B. Cui, “Mastering text-to-image diffusion: Recaptioning, planning, and generating with multimodal llms,” *arXiv preprint arXiv:2401.11708*, 2024.
- [78] S. Gong, M. Li, J. Feng, Z. Wu, and L. Kong, “Diffuseq: Sequence to sequence text generation with diffusion models,” *arXiv preprint arXiv:2210.08933*, 2022.
- [79] X. Li, J. Thickstun, I. Gulrajani, P. S. Liang, and T. B. Hashimoto, “Diffusion-lm improves controllable text generation,” *Advances in Neural Information Processing Systems*, vol. 35, pp. 4328–4343, 2022.
- [80] J. Austin, D. D. Johnson, J. Ho, D. Tarlow, and R. Van Den Berg, “Structured denoising diffusion models in discrete state-spaces,” *Advances in Neural Information Processing Systems*, vol. 34, pp. 17 981–17 993, 2021.
- [81] T. Chen, R. Zhang, and G. Hinton, “Analog bits: Generating discrete data using diffusion models with self-conditioning,” *arXiv preprint arXiv:2208.04202*, 2022.
- [82] J. Ho, W. Chan, C. Saharia, J. Whang, R. Gao, A. Gritsenko, D. P. Kingma, B. Poole, M. Norouzi, D. J. Fleet et al., “Imagen video: High definition video generation with diffusion models,” *arXiv preprint arXiv:2210.02303*, 2022.
- [83] W. Harvey, S. Naderiparizi, V. Masrani, C. Weilbach, and F. Wood, “Flexible diffusion modeling of long videos,” *Advances in Neural Information Processing Systems*, vol. 35, pp. 27 953–27 965, 2022.
- [84] R. Yang, P. Srivastava, and S. Mandt, “Diffusion probabilistic modeling for video generation,” *Entropy*, vol. 25, no. 10, p. 1469, 2023.
- [85] M. Zhang, Z. Cai, L. Pan, F. Hong, X. Guo, L. Yang, and Z. Liu, “Motiondiffuse: Text-driven human motion generation with diffusion model,” *IEEE Transactions on Pattern Analysis and Machine Intelligence*, 2024.
- [86] L. Yang, Z. Zhang, Z. Yu, J. Liu, M. Xu, S. Ermon, and B. CUI, “Cross-modal contextualized diffusion models for text-guided visual generation and editing,” in *International Conference on Learning Representations*, 2024.
- [87] N. Anand and T. Achim, “Protein structure and sequence generation with equivariant denoising diffusion probabilistic models,” *arXiv preprint arXiv:2205.15019*, 2022.
- [88] M. Xu, L. Yu, Y. Song, C. Shi, S. Ermon, and J. Tang, “Geodiff: A geometric diffusion model for molecular conformation generation,” *arXiv preprint arXiv:2203.02923*, 2022.
- [89] E. Hoogeboom, V. G. Satorras, C. Vignac, and M. Welling, “Equivariant diffusion for molecule generation in 3d,” in *International conference on machine learning*. PMLR, 2022, pp. 8867–8887.
- [90] B. Jing, G. Corso, J. Chang, R. Barzilay, and T. Jaakkola, “Torsional diffusion for molecular conformer generation,” *Advances in Neural Information Processing Systems*, vol. 35, pp. 24 240–24 253, 2022.
- [91] Z. Huang, L. Yang, X. Zhou, Z. Zhang, W. Zhang, X. Zheng, J. Chen, Y. Wang, B. CUI, and W. Yang, “Protein-ligand interaction prior for binding-aware 3d molecule diffusion models,” in *International Conference on Learning Representations*, 2024.
- [92] J. Song, C. Meng, and S. Ermon, “Denoising diffusion implicit models,” *arXiv preprint arXiv:2010.02502*, 2020.
- [93] X. Liu, C. Gong, and Q. Liu, “Flow straight and fast: Learning to generate and transfer data with rectified flow,” *arXiv preprint arXiv:2209.03003*, 2022.
- [94] Y. Song, P. Dhariwal, M. Chen, and I. Sutskever, “Consistency models,” *arXiv preprint arXiv:2303.01469*, 2023.
- [95] I. Goodfellow, J. Pouget-Abadie, M. Mirza, B. Xu, D. Warde-Farley, S. Ozair, A. Courville, and Y. Bengio, “Generative adversarial networks,” *Communications of the ACM*, vol. 63, no. 11, pp. 139–144, 2020.
- [96] J. Gui, Z. Sun, Y. Wen, D. Tao, and J. Ye, “A review on generative adversarial networks: Algorithms, theory, and applications,” *IEEE Trans. Knowl. Data Eng.*, vol. 35, no. 4, pp. 3313–3332, 2023. [Online]. Available: <https://doi.org/10.1109/TKDE.2021.3130191>
- [97] S. E. Robertson and S. Walker, “On relevance weights with little relevance information,” in *SIGIR ’97: Proceedings of the 20th Annual International ACM SIGIR Conference on Research and Development in Information Retrieval, July 27-31, 1997, Philadelphia, PA, USA*, N. J. Belkin, A. D. Narasimhalu, P. Willett, W. R. Hersh, F. Can, and E. M. Voorhees, Eds. ACM, 1997, pp. 16–24. [Online]. Available: <https://doi.org/10.1145/258525.258529>
- [98] J. D. Lafferty and C. Zhai, “Document language models, query models, and risk minimization for information retrieval,” in *SIGIR 2001: Proceedings of the 24th Annual International ACM SIGIR Conference on Research and Development in Information Retrieval, September 9-13, 2001, New Orleans, Louisiana, USA*, W. B. Croft, D. J. Harper, D. H. Kraft, and J. Zobel, Eds. ACM, 2001, pp. 111–119. [Online]. Available: <https://doi.org/10.1145/383952.383970>
- [99] Y. Liu, M. Ott, N. Goyal, J. Du, M. Joshi, D. Chen, O. Levy, M. Lewis, L. Zettlemoyer, and V. Stoyanov, “Roberta: A robustly optimized BERT pretraining approach,” *CoRR*, vol. abs/1907.11692, 2019. [Online]. Available: <http://arxiv.org/abs/1907.11692>
- [100] L. Xiong, C. Xiong, Y. Li, K. Tang, J. Liu, P. N. Bennett, J. Ahmed, and A. Overwijk, “Approximate nearest neighbor negative contrastive learning for dense text retrieval,” in *9th International Conference on Learning Representations, ICLR 2021, Virtual Event, Austria, May 3-7, 2021*. OpenReview.net, 2021. [Online]. Available: <https://openreview.net/forum?id=zeFrfgyZln>
- [101] H. Zhang, Y. Gong, Y. Shen, J. Lv, N. Duan, and W. Chen, “Adversarial retriever-ranker for dense text retrieval,” in *The Tenth International Conference on Learning Representations, ICLR 2022, Virtual Event, April 25-29, 2022*. OpenReview.net, 2022. [Online]. Available: <https://openreview.net/forum?id=MR7XubKUFb>
- [102] Y. Qu, Y. Ding, J. Liu, K. Liu, R. Ren, W. X. Zhao, D. Dong, H. Wu, and H. Wang, “Rocketqa: An optimized training approach to dense passage retrieval for open-domain question answering,” in *Proceedings of the 2021 Conference of the North American Chapter of the Association for Computational Linguistics: Human Language Technologies, NAACL-HLT 2021, Online, June 6-11, 2021*, K. Toutanova, A. Rumshisky, L. Zettlemoyer, D. Hakkani-Tür, İ. Beltagy, S. Bethard, R. Cotterell, T. Chakraborty, and Y. Zhou, Eds. Association for Computational Linguistics, 2021, pp. 5835–5847. [Online]. Available: <https://doi.org/10.18653/v1/2021.naacl-main.466>
- [103] L. Gao and J. Callan, “Condenser: a pre-training architecture for dense retrieval,” in *Proceedings of the 2021 Conference on Empirical Methods in Natural Language Processing, EMNLP 2021, Virtual Event / Punta Cana, Dominican Republic, 7-11 November, 2021*, M. Moens, X. Huang, L. Specia, and S. W. Yih, Eds. Association for Computational Linguistics, 2021, pp. 981–993. [Online]. Available: <https://doi.org/10.18653/v1/2021.emnlp-main.75>
- [104] D. Guo, S. Ren, S. Lu, Z. Feng, D. Tang, S. Liu, L. Zhou, N. Duan, A. Svyatkovskiy, S. Fu, M. Tufano, S. K. Deng, C. B. Clement, D. Drain, N. Sundaresan, J. Yin, D. Jiang, and M. Zhou, “Graphcodebert: Pre-training code representations with data flow,” in *9th International Conference on Learning Representations, ICLR 2021, Virtual Event, Austria, May 3-7, 2021*. OpenReview.net, 2021. [Online]. Available: <https://openreview.net/forum?id=jLoC4ez43PZ>
- [105] Y. Wang, W. Wang, S. R. Joty, and S. C. H. Hoi, “Codet5: Identifier-aware unified pre-trained encoder-decoder models for code understanding and generation,” in *Proceedings of the 2021 Conference on Empirical Methods in Natural Language Processing, EMNLP 2021, Virtual Event / Punta Cana, Dominican Republic, 7-11 November, 2021*, M. Moens, X. Huang, L. Specia, and S. W. Yih, Eds. Association for Computational Linguistics, 2021, pp. 8696–8708. [Online]. Available: <https://doi.org/10.18653/v1/2021.emnlp-main.685>
- [106] S. Hershey, S. Chaudhuri, D. P. W. Ellis, J. F. Gemmeke, A. Jansen, R. C. Moore, M. Plakal, D. Platt, R. A. Saurous, B. Seybold, M. Slaney, R. J. Weiss, and K. W. Wilson, “CNN architectures for large-scale audio classification,” in *2017 IEEE International Conference on Acoustics, Speech and Signal Processing, ICASSP 2017, New Orleans, LA, USA, March 5-9, 2017*. IEEE, 2017, pp. 131–135. [Online]. Available: <https://doi.org/10.1109/ICASSP.2017.7952132>
- [107] X. Yuan, Z. Lin, J. Kuen, J. Zhang, Y. Wang, M. Maire, A. Kale, and B. Faieta, “Multimodal contrastive training for visual representation learning,” in *Proceedings of the IEEE/CVF Conference on Computer Vision and Pattern Recognition*, 2021, pp. 6995–7004.



- [108] J. Dong, X. Li, C. Xu, S. Ji, Y. He, G. Yang, and X. Wang, “Dual encoding for zero-example video retrieval,” in IEEE Conference on Computer Vision and Pattern Recognition, CVPR 2019, Long Beach, CA, USA, June 16-20, 2019. Computer Vision Foundation / IEEE, 2019, pp. 9346–9355. [Online]. Available: [http://openaccess.thecvf.com/content\\_CVPR\\_2019/html/Dong\\_Dual\\_Encoding\\_for\\_Zero-Example\\_Video\\_Retrieval\\_CVPR\\_2019\\_paper.html](http://openaccess.thecvf.com/content_CVPR_2019/html/Dong_Dual_Encoding_for_Zero-Example_Video_Retrieval_CVPR_2019_paper.html)
- [109] M. Bain, A. Nagrani, G. Varol, and A. Zisserman, “Frozen in time: A joint video and image encoder for end-to-end retrieval,” in 2021 IEEE/CVF International Conference on Computer Vision, ICCV 2021, Montreal, QC, Canada, October 10-17, 2021. IEEE, 2021, pp. 1708–1718. [Online]. Available: <https://doi.org/10.1109/ICCV48922.2021.00175>
- [110] J. Zhan, J. Mao, Y. Liu, J. Guo, M. Zhang, and S. Ma, “Optimizing dense retrieval model training with hard negatives,” in Proceedings of the 44th International ACM SIGIR Conference on Research and Development in Information Retrieval, 2021, pp. 1503–1512.
- [111] J. L. Bentley, “Multidimensional binary search trees used for associative searching,” Communications of the ACM, vol. 18, no. 9, pp. 509–517, 1975.
- [112] W. Li, C. Feng, D. Lian, Y. Xie, H. Liu, Y. Ge, and E. Chen, “Learning balanced tree indexes for large-scale vector retrieval,” in Proceedings of the 29th ACM SIGKDD Conference on Knowledge Discovery and Data Mining, 2023, pp. 1353–1362.
- [113] M. Datar, N. Immorlica, P. Indyk, and V. S. Mirrokni, “Locality-sensitive hashing scheme based on p-stable distributions,” in Proceedings of the twentieth annual symposium on Computational geometry, 2004, pp. 253–262.
- [114] Y. A. Malkov and D. A. Yashunin, “Efficient and robust approximate nearest neighbor search using hierarchical navigable small world graphs,” IEEE transactions on pattern analysis and machine intelligence, vol. 42, no. 4, pp. 824–836, 2018.
- [115] S. Jayaram Subramanya, F. Devvrit, H. V. Simhadri, R. Krishnawamy, and R. Kadekodi, “Diskann: Fast accurate billion-point nearest neighbor search on a single node,” Advances in Neural Information Processing Systems, vol. 32, 2019.
- [116] J. Ren, M. Zhang, and D. Li, “Hm-ann: Efficient billion-point nearest neighbor search on heterogeneous memory,” Advances in Neural Information Processing Systems, vol. 33, pp. 10672–10684, 2020.
- [117] Q. Chen, B. Zhao, H. Wang, M. Li, C. Liu, Z. Li, M. Yang, and J. Wang, “Spann: Highly-efficient billion-scale approximate nearest neighborhood search,” Advances in Neural Information Processing Systems, vol. 34, pp. 5199–5212, 2021.
- [118] S. A. Hayati, R. Olivier, P. Avvaru, P. Yin, A. Tomasic, and G. Neubig, “Retrieval-based neural code generation,” in Proceedings of the 2018 Conference on Empirical Methods in Natural Language Processing, Brussels, Belgium, October 31 - November 4, 2018, E. Riloff, D. Chiang, J. Hockenmaier, and J. Tsujii, Eds. Association for Computational Linguistics, 2018, pp. 925–930. [Online]. Available: <https://doi.org/10.18653/v1/d18-1111>
- [119] J. Zhang, X. Wang, H. Zhang, H. Sun, and X. Liu, “Retrieval-based neural source code summarization,” in ICSE ’20: 42nd International Conference on Software Engineering, Seoul, South Korea, 27 June - 19 July, 2020, G. Rothermel and D. Bae, Eds. ACM, 2020, pp. 1385–1397. [Online]. Available: <https://doi.org/10.1145/3377811.3380383>
- [120] G. Poesia, A. Polozov, V. Le, A. Tiwari, G. Soares, C. Meek, and S. Gulwani, “SynchroMesh: Reliable code generation from pre-trained language models,” in The Tenth International Conference on Learning Representations, ICLR 2022, Virtual Event, April 25-29, 2022. OpenReview.net, 2022. [Online]. Available: <https://openreview.net/forum?id=KmtVD97J43e>
- [121] X. Ye, S. Yavuz, K. Hashimoto, Y. Zhou, and C. Xiong, “RNG-KBQA: generation augmented iterative ranking for knowledge base question answering,” in Proceedings of the 60th Annual Meeting of the Association for Computational Linguistics (Volume 1: Long Papers), ACL 2022, Dublin, Ireland, May 22-27, 2022, S. Muresan, P. Nakov, and A. Villavicencio, Eds. Association for Computational Linguistics, 2022, pp. 6032–6043. [Online]. Available: <https://doi.org/10.18653/v1/2022.acl-long.417>
- [122] Y. Shu, Z. Yu, Y. Li, B. F. Karlsson, T. Ma, Y. Qu, and C. Lin, “TIARA: multi-grained retrieval for robust question answering over large knowledge bases,” CoRR, vol. abs/2210.12925, 2022. [Online]. Available: <https://doi.org/10.48550/arXiv.2210.12925>
- [123] M. Xu, H. Jiang, and S. Watcharawitayakul, “A local detection approach for named entity recognition and mention detection,” in Proceedings of the 55th Annual Meeting of the Association for Computational Linguistics (Volume 1: Long Papers), 2017, pp. 1237–1247.
- [124] X. V. Lin, R. Socher, and C. Xiong, “Bridging textual and tabular data for cross-domain text-to-sql semantic parsing,” arXiv preprint arXiv:2012.12627, 2020.
- [125] F. Petroni, A. Piktus, A. Fan, P. Lewis, M. Yazdani, N. De Cao, J. Thorne, Y. Jernite, V. Karpukhin, J. Maillard et al., “Kilt: a benchmark for knowledge intensive language tasks,” in Proceedings of the 2021 Conference of the North American Chapter of the Association for Computational Linguistics: Human Language Technologies, 2021, pp. 2523–2544.
- [126] A. Asai, Z. Wu, Y. Wang, A. Sil, and H. Hajishirzi, “Self-rag: Learning to retrieve, generate, and critique through self-reflection,” CoRR, vol. abs/2310.11511, 2023. [Online]. Available: <https://doi.org/10.48550/arXiv.2310.11511>
- [127] W. Shi, S. Min, M. Yasunaga, M. Seo, R. James, M. Lewis, L. Zettlemoyer, and W.-t. Yih, “Replug: Retrieval-augmented black-box language models,” arXiv preprint arXiv:2301.12652, 2023.
- [128] O. Ram, Y. Levine, I. Dalmedigos, D. Muhlgay, A. Shashua, K. Leyton-Brown, and Y. Shoham, “In-context retrieval-augmented language models,” arXiv preprint arXiv:2302.00083, 2023.
- [129] D. Zan, B. Chen, Z. Lin, B. Guan, Y. Wang, and J. Lou, “When language model meets private library,” in Findings of the Association for Computational Linguistics: EMNLP 2022, Abu Dhabi, United Arab Emirates, December 7-11, 2022, Y. Goldberg, Z. Kozareva, and Y. Zhang, Eds. Association for Computational Linguistics, 2022, pp. 277–288. [Online]. Available: <https://doi.org/10.18653/v1/2022.findings-emnlp.21>
- [130] N. Nashid, M. Sintaha, and A. Mesbah, “Retrieval-based prompt selection for code-related few-shot learning,” in 45th IEEE/ACM International Conference on Software Engineering, ICSE 2023, Melbourne, Australia, May 14-20, 2023. IEEE, 2023, pp. 2450–2462. [Online]. Available: <https://doi.org/10.1109/ICSE48619.2023.00205>
- [131] M. Jin, S. Shahriar, M. Tufano, X. Shi, S. Lu, N. Sundaresan, and A. Svyatkovskiy, “Inferfix: End-to-end program repair with llms,” in Proceedings of the 31st ACM Joint European Software Engineering Conference and Symposium on the Foundations of Software Engineering, ESEC/FSE 2023, San Francisco, CA, USA, December 3-9, 2023, S. Chandra, K. Blincoe, and P. Tonella, Eds. ACM, 2023, pp. 1646–1656. [Online]. Available: <https://doi.org/10.1145/3611643.3613892>
- [132] S. Lu, N. Duan, H. Han, D. Guo, S. Hwang, and A. Svyatkovskiy, “Reacc: A retrieval-augmented code completion framework,” in Proceedings of the 60th Annual Meeting of the Association for Computational Linguistics (Volume 1: Long Papers), ACL 2022, Dublin, Ireland, May 22-27, 2022, S. Muresan, P. Nakov, and A. Villavicencio, Eds. Association for Computational Linguistics, 2022, pp. 6227–6240. [Online]. Available: <https://doi.org/10.18653/v1/2022.acl-long.431>
- [133] Y. Liu, S. Yavuz, R. Meng, D. Radev, C. Xiong, and Y. Zhou, “Uni-parser: Unified semantic parser for question answering on knowledge base and database,” in Proceedings of the 2022 Conference on Empirical Methods in Natural Language Processing, EMNLP 2022, Abu Dhabi, United Arab Emirates, December 7-11, 2022, Y. Goldberg, Z. Kozareva, and Y. Zhang, Eds. Association for Computational Linguistics, 2022, pp. 8858–8869. [Online]. Available: <https://doi.org/10.18653/v1/2022.emnlp-main.605>
- [134] Z. Yang, X. Du, E. Cambria, and C. Cardie, “End-to-end case-based reasoning for commonsense knowledge base completion,” in Proceedings of the 17th Conference of the European Chapter of the Association for Computational Linguistics, EAACL 2023, Dubrovnik, Croatia, May 2-6, 2023, A. Vlachos and I. Augenstein, Eds. Association for Computational Linguistics, 2023, pp. 3491–3504. [Online]. Available: <https://doi.org/10.18653/v1/2023.eacl-main.255>
- [135] M. Patidar, A. K. Singh, R. Sawhney, I. Bhattacharya, and Mausam, “Combining transfer learning with in-context learning using blackbox llms for zero-shot knowledge base question answering,” CoRR, vol. abs/2311.08894, 2023. [Online]. Available: <https://doi.org/10.48550/arXiv.2311.08894>
- [136] W. Shi, Y. Zhuang, Y. Zhu, H. Iwinski, M. Wattenbarger, and M. D. Wang, “Retrieval-augmented large language models for adolescent idiopathic scoliosis patients in shared decision-making,” in Proceedings of the 14th ACM International Conference on Bioinformatics, Computational Biology, and Health Informatics, 2023, pp. 1–10.
- [137] A. Casanova, M. Careil, J. Verbeek, M. Drozdal, and A. Romero Soriano, “Instance-conditioned gan,” Advances in Neural Information Processing Systems, vol. 34, pp. 27517–27529, 2021.

- [138] J. Li, Y. Li, G. Li, X. Hu, X. Xia, and Z. Jin, “Editsum: A retrieve-and-edit framework for source code summarization,” in *36th IEEE/ACM International Conference on Automated Software Engineering, ASE 2021, Melbourne, Australia, November 15-19, 2021*. IEEE, 2021, pp. 155–166. [Online]. Available: <https://doi.org/10.1109/ASE51524.2021.9678724>
- [139] C. Yu, G. Yang, X. Chen, K. Liu, and Y. Zhou, “Bashexplainer: Retrieval-augmented bash code comment generation based on fine-tuned codebert,” in *IEEE International Conference on Software Maintenance and Evolution, ICSME 2022, Limassol, Cyprus, October 3-7, 2022*. IEEE, 2022, pp. 82–93. [Online]. Available: <https://doi.org/10.1109/ICSME55016.2022.00016>
- [140] T. B. Hashimoto, K. Guu, Y. Oren, and P. Liang, “A retrieve-and-edit framework for predicting structured outputs,” in *Advances in Neural Information Processing Systems 31: Annual Conference on Neural Information Processing Systems 2018, NeurIPS 2018, December 3-8, 2018, Montréal, Canada*, S. Bengio, H. M. Wallach, H. Larochelle, K. Grauman, N. Cesa-Bianchi, and R. Garnett, Eds., 2018, pp. 10073–10083. [Online]. Available: <https://proceedings.neurips.cc/paper/2018/hash/cd17d3ce3b64f227987cd92cd701cc58-Abstract.html>
- [141] E. Shi, Y. Wang, W. Tao, L. Du, H. Zhang, S. Han, D. Zhang, and H. Sun, “RACE: retrieval-augmented commit message generation,” in *Proceedings of the 2022 Conference on Empirical Methods in Natural Language Processing, EMNLP 2022, Abu Dhabi, United Arab Emirates, December 7-11, 2022*, Y. Goldberg, Z. Kozareva, and Y. Zhang, Eds. Association for Computational Linguistics, 2022, pp. 5520–5530. [Online]. Available: <https://doi.org/10.18653/v1/2022.emnlp-main.372>
- [142] B. Oguz, X. Chen, V. Karpukhin, S. Peshterliev, D. Okhonko, M. S. Schlichtkrull, S. Gupta, Y. Mehdad, and S. Yih, “Unik-qa: Unified representations of structured and unstructured knowledge for open-domain question answering,” in *Findings of the Association for Computational Linguistics: NAACL 2022, Seattle, WA, United States, July 10-15, 2022*, M. Carpuat, M. de Marneffe, and I. V. M. Ruiz, Eds. Association for Computational Linguistics, 2022, pp. 1535–1546. [Online]. Available: <https://doi.org/10.18653/v1/2022.findings-naacl.115>
- [143] D. Yu, S. Zhang, P. Ng, H. Zhu, A. H. Li, J. Wang, Y. Hu, W. Y. Wang, Z. Wang, and B. Xiang, “Decaf: Joint decoding of answers and logical forms for question answering over knowledge bases,” in *The Eleventh International Conference on Learning Representations, ICLR 2023, Kigali, Rwanda, May 1-5, 2023*. OpenReview.net, 2023. [Online]. Available: <https://openreview.net/pdf?id=XHc5zRPXqV9>
- [144] G. Dong, R. Li, S. Wang, Y. Zhang, Y. Xian, and W. Xu, “Bridging the kb-text gap: Leveraging structured knowledge-aware pre-training for KBQA,” in *Proceedings of the 32nd ACM International Conference on Information and Knowledge Management, CIKM 2023, Birmingham, United Kingdom, October 21-25, 2023*, I. Frommholz, F. Hopfgartner, M. Lee, M. Oakes, M. Lalmas, M. Zhang, and R. L. T. Santos, Eds. ACM, 2023, pp. 3854–3859. [Online]. Available: <https://doi.org/10.1145/3583780.3615150>
- [145] K. Wang, F. Duan, S. Wang, P. Li, Y. Xian, C. Yin, W. Rong, and Z. Xiong, “Knowledge-driven cot: Exploring faithful reasoning in llms for knowledge-intensive question answering,” *CoRR*, vol. abs/2308.13259, 2023. [Online]. Available: <https://doi.org/10.48550/arXiv.2308.13259>
- [146] D. Yu and Y. Yang, “Retrieval-enhanced generative model for large-scale knowledge graph completion,” in *Proceedings of the 46th International ACM SIGIR Conference on Research and Development in Information Retrieval, SIGIR 2023, Taipei, Taiwan, July 23-27, 2023*, H. Chen, W. E. Duh, H. Huang, M. P. Kato, J. Mothe, and B. Poblete, Eds. ACM, 2023, pp. 2334–2338. [Online]. Available: <https://doi.org/10.1145/3539618.3592052>
- [147] W. Zhung, H. Kim, and W. Y. Kim, “A protein-ligand interaction-focused 3d molecular generative framework for generalizable structure-based drug design,” 2023.
- [148] W. Chen, H. Hu, C. Saharia, and W. W. Cohen, “Re-imagen: Retrieval-augmented text-to-image generator,” *arXiv preprint arXiv:2209.14491*, 2022.
- [149] S. Sheynin, O. Ashual, A. Polyak, U. Singer, O. Gafni, E. Nachmani, and Y. Taigman, “Knn-diffusion: Image generation via large-scale retrieval,” *arXiv preprint arXiv:2204.02849*, 2022.
- [150] A. Blattmann, R. Rombach, K. Oktay, J. Müller, and B. Ommer, “Retrieval-augmented diffusion models,” *Advances in Neural Information Processing Systems*, vol. 35, pp. 15 309–15 324, 2022.
- [151] R. Rombach, A. Blattmann, and B. Ommer, “Text-guided synthesis of artistic images with retrieval-augmented diffusion models,” *arXiv preprint arXiv:2207.13038*, 2022.
- [152] B. Li, P. H. Torr, and T. Lukaszewicz, “Memory-driven text-to-image generation,” *arXiv preprint arXiv:2208.07022*, 2022.
- [153] M. de Jong, Y. Zemlyanskiy, N. FitzGerald, F. Sha, and W. W. Cohen, “Mention memory: incorporating textual knowledge into transformers through entity mention attention,” in *International Conference on Learning Representations*, 2021.
- [154] A. Bertsch, U. Alon, G. Neubig, and M. R. Gormley, “Unlimiformer: Long-range transformers with unlimited length input,” *CoRR*, vol. abs/2305.01625, 2023. [Online]. Available: <https://doi.org/10.48550/arXiv.2305.01625>
- [155] T. Févry, L. B. Soares, N. Fitzgerald, E. Choi, and T. Kwiatkowski, “Entities as experts: Sparse memory access with entity supervision,” in *Proceedings of the 2020 Conference on Empirical Methods in Natural Language Processing (EMNLP)*, 2020, pp. 4937–4951.
- [156] B. Jing, Y. Zhang, Z. Song, J. Yu, and W. Yang, “Amd: Anatomical motion diffusion with interpretable motion decomposition and fusion,” *arXiv preprint arXiv:2312.12763*, 2023.
- [157] Y. Yuan, H. Liu, X. Liu, Q. Huang, M. D. Plumbley, and W. Wang, “Retrieval-augmented text-to-audio generation,” *CoRR*, vol. abs/2309.08051, 2023. [Online]. Available: <https://doi.org/10.48550/arXiv.2309.08051>
- [158] B. Yang, M. Cao, and Y. Zou, “Concept-aware video captioning: Describing videos with effective prior information,” *IEEE Trans. Image Process.*, vol. 32, pp. 5366–5378, 2023. [Online]. Available: <https://doi.org/10.1109/TIP.2023.3307969>
- [159] Z. Zhong, T. Lei, and D. Chen, “Training language models with memory augmentation,” in *Proceedings of the 2022 Conference on Empirical Methods in Natural Language Processing, EMNLP 2022, Abu Dhabi, United Arab Emirates, December 7-11, 2022*, Y. Goldberg, Z. Kozareva, and Y. Zhang, Eds. Association for Computational Linguistics, 2022, pp. 5657–5673. [Online]. Available: <https://doi.org/10.18653/v1/2022.emnlp-main.382>
- [160] S. Min, W. Shi, M. Lewis, X. Chen, W. Yih, H. Hajishirzi, and L. Zettlemoyer, “Nonparametric masked language modeling,” in *Findings of the Association for Computational Linguistics: ACL 2023, Toronto, Canada, July 9-14, 2023*, A. Rogers, J. L. Boyd-Graber, and N. Okazaki, Eds. Association for Computational Linguistics, 2023, pp. 2097–2118. [Online]. Available: <https://doi.org/10.18653/v1/2023.findings-acl.132>
- [161] X. Zhang, Y. Zhou, G. Yang, and T. Chen, “Syntax-aware retrieval augmented code generation,” in *Findings of the Association for Computational Linguistics: EMNLP 2023, Singapore, December 6-10, 2023*, H. Bouamor, J. Pino, and K. Bali, Eds. Association for Computational Linguistics, 2023, pp. 1291–1302. [Online]. Available: <https://aclanthology.org/2023.findings-emnlp.90>
- [162] Z. Fei, “Memory-augmented image captioning,” in *Proceedings of the AAAI Conference on Artificial Intelligence*, vol. 35, no. 2, 2021, pp. 1317–1324.
- [163] Y. Leviathan, M. Kalman, and Y. Matias, “Fast inference from transformers via speculative decoding,” in *International Conference on Machine Learning, ICML 2023, 23-29 July 2023, Honolulu, Hawaii, USA*, ser. Proceedings of Machine Learning Research, A. Krause, E. Brunskill, K. Cho, B. Engelhardt, S. Sabato, and J. Scarlett, Eds., vol. 202. PMLR, 2023, pp. 19274–19286. [Online]. Available: <https://proceedings.mlr.press/v202/leviathan23a.html>
- [164] L. Wang, N. Yang, and F. Wei, “Query2doc: Query expansion with large language models,” in *Proceedings of the 2023 Conference on Empirical Methods in Natural Language Processing, EMNLP 2023, Singapore, December 6-10, 2023*, H. Bouamor, J. Pino, and K. Bali, Eds. Association for Computational Linguistics, 2023, pp. 9414–9423. [Online]. Available: <https://aclanthology.org/2023.emnlp-main.585>
- [165] L. Gao, X. Ma, J. Lin, and J. Callan, “Precise zero-shot dense retrieval without relevance labels,” in *Proceedings of the 61st Annual Meeting of the Association for Computational Linguistics (Volume 1: Long Papers), ACL 2023, Toronto, Canada, July 9-14, 2023*, A. Rogers, J. L. Boyd-Graber, and N. Okazaki, Eds. Association for Computational Linguistics, 2023, pp. 1762–1777. [Online]. Available: <https://doi.org/10.18653/v1/2023.acl-long.99>
- [166] R. Jagerman, H. Zhuang, Z. Qin, X. Wang, and M. Bendersky, “Query expansion by prompting large language models,” *CoRR*, vol. abs/2305.03653, 2023. [Online]. Available: <https://doi.org/10.48550/arXiv.2305.03653>
- [167] J. Wei, X. Wang, D. Schuurmans, M. Bosma, B. Ichter, F. Xia, E. H. Chi, Q. V. Le, and D. Zhou, “Chain-of-thought prompting elicits reasoning in large language models,” in *Advances in*

- Neural Information Processing Systems 35: Annual Conference on Neural Information Processing Systems 2022, NeurIPS 2022, New Orleans, LA, USA, November 28 - December 9, 2022, S. Koyejo, S. Mohamed, A. Agarwal, D. Belgrave, K. Cho, and A. Oh, Eds., 2022. [Online]. Available: [http://papers.nips.cc/paper\\_files/paper/2022/hash/9d5609613524ecf4f15af0f7b31abca4-Abstract-Conference.html](http://papers.nips.cc/paper_files/paper/2022/hash/9d5609613524ecf4f15af0f7b31abca4-Abstract-Conference.html)
- [168] K. Mao, Z. Dou, F. Mo, J. Hou, H. Chen, and H. Qian, “Large language models know your contextual search intent: A prompting framework for conversational search,” in *Findings of the Association for Computational Linguistics: EMNLP 2023*, Singapore, December 6-10, 2023, H. Bouamor, J. Pino, and K. Bali, Eds. Association for Computational Linguistics, 2023, pp. 1211–1225. [Online]. Available: <https://aclanthology.org/2023.findings-emnlp.86>
- [169] J. Liu, “LlamaIndex,” 11 2022. [Online]. Available: [https://github.com/jerryliu/llama\\_index](https://github.com/jerryliu/llama_index)
- [170] S. Xiao, Z. Liu, P. Zhang, and N. Muennighoff, “C-pack: Packaged resources to advance general chinese embedding,” 2023.
- [171] J. Chen, S. Xiao, P. Zhang, K. Luo, D. Lian, and Z. Liu, “Bge m3-embedding: Multi-lingual, multi-functionality, multi-granularity text embeddings through self-knowledge distillation,” 2023.
- [172] S. Xiao, Z. Liu, P. Zhang, and X. Xing, “Lm-cocktail: Resilient tuning of language models via model merging,” 2023.
- [173] P. Zhang, S. Xiao, Z. Liu, Z. Dou, and J.-Y. Nie, “Retrieve anything to augment large language models,” 2023.
- [174] W. Wang, Y. Wang, S. Joty, and S. C. H. Hoi, “Rap-gen: Retrieval-augmented patch generation with codet5 for automatic program repair,” in *Proceedings of the 31st ACM Joint European Software Engineering Conference and Symposium on the Foundations of Software Engineering, ESEC/FSE 2023, San Francisco, CA, USA, December 3-9, 2023*, S. Chandra, K. Blincoe, and P. Tonella, Eds. ACM, 2023, pp. 146–158. [Online]. Available: <https://doi.org/10.1145/3611643.3616256>
- [175] M. R. Glass, G. Rossiello, M. F. M. Chowdhury, A. Naik, P. Cai, and A. Gliozzo, “Re2g: Retrieve, rerank, generate,” in *Proceedings of the 2022 Conference of the North American Chapter of the Association for Computational Linguistics: Human Language Technologies, NAACL 2022, Seattle, WA, United States, July 10-15, 2022*, M. Carpuat, M. de Marneffe, and I. V. M. Ruíz, Eds. Association for Computational Linguistics, 2022, pp. 2701–2715. [Online]. Available: <https://doi.org/10.18653/v1/2022.naacl-main.194>
- [176] R. F. Nogueira and K. Cho, “Passage re-ranking with BERT,” *CoRR*, vol. abs/1901.04085, 2019. [Online]. Available: <http://arxiv.org/abs/1901.04085>
- [177] J. Li, Y. Zhao, Y. Li, G. Li, and Z. Jin, “Acecoder: Utilizing existing code to enhance code generation,” *arXiv preprint arXiv:2303.17780*, 2023.
- [178] P. Shi, R. Zhang, H. Bai, and J. Lin, “XRICL: cross-lingual retrieval-augmented in-context learning for cross-lingual text-to-sql semantic parsing,” in *Findings of the Association for Computational Linguistics: EMNLP 2022, Abu Dhabi, United Arab Emirates, December 7-11, 2022*, Y. Goldberg, Z. Kozareva, and Y. Zhang, Eds. Association for Computational Linguistics, 2022, pp. 5248–5259. [Online]. Available: <https://doi.org/10.18653/v1/2022.findings-emnlp.384>
- [179] <https://www.pinecone.io>.
- [180] E. Saravia, “Prompt Engineering Guide,” <https://github.com/dair-ai/Prompt-Engineering-Guide>, 12 2022.
- [181] H. S. Zheng, S. Mishra, X. Chen, H. Cheng, E. H. Chi, Q. V. Le, and D. Zhou, “Take a step back: Evoking reasoning via abstraction in large language models,” *CoRR*, vol. abs/2310.06117, 2023. [Online]. Available: <https://doi.org/10.48550/arXiv.2310.06117>
- [182] S. Diao, P. Wang, Y. Lin, and T. Zhang, “Active prompting with chain-of-thought for large language models,” *CoRR*, vol. abs/2302.12246, 2023. [Online]. Available: <https://doi.org/10.48550/arXiv.2302.12246>
- [183] H. Jiang, Q. Wu, C. Lin, Y. Yang, and L. Qiu, “Lmlingua: Compressing prompts for accelerated inference of large language models,” in *Proceedings of the 2023 Conference on Empirical Methods in Natural Language Processing, EMNLP 2023, Singapore, December 6-10, 2023*, H. Bouamor, J. Pino, and K. Bali, Eds. Association for Computational Linguistics, 2023, pp. 13 358–13 376. [Online]. Available: <https://aclanthology.org/2023.emnlp-main.825>
- [184] N. F. Liu, K. Lin, J. Hewitt, A. Paranjape, M. Bevilacqua, F. Petroni, and P. Liang, “Lost in the middle: How language models use long contexts,” *CoRR*, vol. abs/2307.03172, 2023. [Online]. Available: <https://doi.org/10.48550/arXiv.2307.03172>
- [185] T. Ahmed, K. S. Pai, P. Devanbu, and E. T. Barr, “Automatic semantic augmentation of language model prompts (for code summarization),” 2024.
- [186] E. Nijkamp, B. Pang, H. Hayashi, L. Tu, H. Wang, Y. Zhou, S. Savarese, and C. Xiong, “A conversational paradigm for program synthesis,” *CoRR*, vol. abs/2203.13474, 2022. [Online]. Available: <https://doi.org/10.48550/arXiv.2203.13474>
- [187] Y. He, M. Xia, H. Chen, X. Cun, Y. Gong, J. Xing, Y. Zhang, X. Wang, C. Weng, Y. Shan, and Q. Chen, “Animate-a-story: Storytelling with retrieval-augmented video generation,” *CoRR*, vol. abs/2307.06940, 2023. [Online]. Available: <https://doi.org/10.48550/arXiv.2307.06940>
- [188] E. J. Hu, Y. Shen, P. Wallis, Z. Allen-Zhu, Y. Li, S. Wang, L. Wang, and W. Chen, “Lora: Low-rank adaptation of large language models,” in *The Tenth International Conference on Learning Representations, ICLR 2022, Virtual Event, April 25-29, 2022*. OpenReview.net, 2022. [Online]. Available: <https://openreview.net/forum?id=nZeVKeeFYf9>
- [189] C. Liu, P. Çetin, Y. Patodia, S. Chakraborty, Y. Ding, and B. Ray, “Automated code editing with search-generate-modify,” *CoRR*, vol. abs/2306.06490, 2023. [Online]. Available: <https://doi.org/10.48550/arXiv.2306.06490>
- [190] H. Joshi, J. P. C. Sánchez, S. Gulwani, V. Le, G. Verbruggen, and I. Radicek, “Repair is nearly generation: Multilingual program repair with llms,” in *Thirty-Seventh AAAI Conference on Artificial Intelligence, AAAI 2023, Thirty-Fifth Conference on Innovative Applications of Artificial Intelligence, IAAI 2023, Thirteenth Symposium on Educational Advances in Artificial Intelligence, EAAI 2023, Washington, DC, USA, February 7-14, 2023*, B. Williams, Y. Chen, and J. Neville, Eds. AAAI Press, 2023, pp. 5131–5140. [Online]. Available: <https://doi.org/10.1609/aaai.v37i4.25642>
- [191] Z. Jiang, F. F. Xu, L. Gao, Z. Sun, Q. Liu, J. Dwivedi-Yu, Y. Yang, J. Callan, and G. Neubig, “Active retrieval augmented generation,” *arXiv preprint arXiv:2305.06983*, 2023.
- [192] A. Mallen, A. Asai, V. Zhong, R. Das, D. Khashabi, and H. Hajishirzi, “When not to trust language models: Investigating effectiveness of parametric and non-parametric memories,” in *Proceedings of the 61st Annual Meeting of the Association for Computational Linguistics (Volume 1: Long Papers), ACL 2023, Toronto, Canada, July 9-14, 2023*, A. Rogers, J. L. Boyd-Graber, and N. Okazaki, Eds. Association for Computational Linguistics, 2023, pp. 9802–9822. [Online]. Available: <https://doi.org/10.18653/v1/2023.acl-long.546>
- [193] Z. Jiang, J. Araki, H. Ding, and G. Neubig, “How can we know when language models know? on the calibration of language models for question answering,” *Trans. Assoc. Comput. Linguistics*, vol. 9, pp. 962–977, 2021. [Online]. Available: [https://doi.org/10.1162/tacl\\_a\\_00407](https://doi.org/10.1162/tacl_a_00407)
- [194] N. Kandpal, H. Deng, A. Roberts, E. Wallace, and C. Raffel, “Large language models struggle to learn long-tail knowledge,” in *International Conference on Machine Learning, ICML 2023, 23-29 July 2023, Honolulu, Hawaii, USA, ser. Proceedings of Machine Learning Research, A. Krause, E. Brunskill, K. Cho, B. Engelhardt, S. Sabato, and J. Scarlett, Eds., vol. 202*. PMLR, 2023, pp. 15 696–15 707. [Online]. Available: <https://proceedings.mlr.press/v202/kandpal23a.html>
- [195] R. Ren, Y. Wang, Y. Qu, W. X. Zhao, J. Liu, H. Tian, H. Wu, J. Wen, and H. Wang, “Investigating the factual knowledge boundary of large language models with retrieval augmentation,” *CoRR*, vol. abs/2307.11019, 2023. [Online]. Available: <https://doi.org/10.48550/arXiv.2307.11019>
- [196] Y. Wang, P. Li, M. Sun, and Y. Liu, “Self-knowledge guided retrieval augmentation for large language models,” in *Findings of the Association for Computational Linguistics: EMNLP 2023, Singapore, December 6-10, 2023*, H. Bouamor, J. Pino, and K. Bali, Eds. Association for Computational Linguistics, 2023, pp. 10 303–10 315. [Online]. Available: <https://aclanthology.org/2023.findings-emnlp.691>
- [197] F. Zhang, B. Chen, Y. Zhang, J. Keung, J. Liu, D. Zan, Y. Mao, J. Lou, and W. Chen, “Repocoder: Repository-level code completion through iterative retrieval and generation,” in *Proceedings of the 2023 Conference on Empirical Methods in Natural Language Processing, EMNLP 2023, Singapore, December 6-10, 2023*, H. Bouamor, J. Pino, and K. Bali, Eds. Association for Computational Linguistics, 2023, pp. 2471–2484. [Online]. Available: <https://aclanthology.org/2023.emnlp-main.151>
- [198] Z. Shao, Y. Gong, Y. Shen, M. Huang, N. Duan, and W. Chen, “Enhancing retrieval-augmented large language models with iterative retrieval-generation synergy,” in *Findings of the Association for Computational Linguistics: EMNLP 2023, Singapore, December 6-10, 2023*, H. Bouamor, J. Pino, and K. Bali, Eds. Association for Computational Linguistics, 2023, pp. 9248–9274. [Online]. Available: <https://aclanthology.org/2023.findings-emnlp.620>

- [199] O. Agarwal, H. Ge, S. Shakeri, and R. Al-Rfou, “Knowledge graph based synthetic corpus generation for knowledge-enhanced language model pre-training,” in *Proceedings of the 2021 Conference of the North American Chapter of the Association for Computational Linguistics: Human Language Technologies, NAACL-HLT 2021*, Online, June 6-11, 2021, K. Toutanova, A. Rumshisky, L. Zettlemoyer, D. Hakkani-Tür, I. Beltagy, S. Bethard, R. Cotterell, T. Chakraborty, and Y. Zhou, Eds. Association for Computational Linguistics, 2021, pp. 3554–3565. [Online]. Available: <https://doi.org/10.18653/v1/2021.naacl-main.278>
- [200] J. Baek, A. F. Aji, and A. Saffari, “Knowledge-augmented language model prompting for zero-shot knowledge graph question answering,” *CoRR*, vol. abs/2306.04136, 2023. [Online]. Available: <https://doi.org/10.48550/arXiv.2306.04136>
- [201] J. Sun, C. Xu, L. Tang, S. Wang, C. Lin, Y. Gong, H. Shum, and J. Guo, “Think-on-graph: Deep and responsible reasoning of large language model with knowledge graph,” *CoRR*, vol. abs/2307.07697, 2023. [Online]. Available: <https://doi.org/10.48550/arXiv.2307.07697>
- [202] P. Limkonchotiwat, W. Ponwitayarat, C. Udomcharoenchaikit, E. Chuangsuwanich, and S. Nutanong, “Cl-relkt: Cross-lingual language knowledge transfer for multilingual retrieval question answering,” in *Findings of the Association for Computational Linguistics: NAACL 2022*, Seattle, WA, United States, July 10-15, 2022, M. Carpuat, M. de Marneffe, and I. V. M. Ruíz, Eds. Association for Computational Linguistics, 2022, pp. 2141–2155. [Online]. Available: <https://doi.org/10.18653/v1/2022.findings-naacl.165>
- [203] A. Asai, X. Yu, J. Kasai, and H. Hajishirzi, “One question answering model for many languages with cross-lingual dense passage retrieval,” in *Advances in Neural Information Processing Systems 34: Annual Conference on Neural Information Processing Systems 2021, NeurIPS 2021*, December 6-14, 2021, virtual, M. Ranzato, A. Beygelzimer, Y. N. Dauphin, P. Liang, and J. W. Vaughan, Eds., 2021, pp. 7547–7560. [Online]. Available: <https://proceedings.neurips.cc/paper/2021/hash/3df07fdae1ab273a967aaa1d355b8bb6-Abstract.html>
- [204] K. Lee, S. Han, S. Hwang, and M. Lee, “When to read documents or QA history: On unified and selective open-domain QA,” in *Findings of the Association for Computational Linguistics: ACL 2023*, Toronto, Canada, July 9-14, 2023, A. Rogers, J. L. Boyd-Graber, and N. Okazaki, Eds. Association for Computational Linguistics, 2023, pp. 6420–6432. [Online]. Available: <https://doi.org/10.18653/v1/2023.findings-acl.401>
- [205] K. Huang, C. Zhai, and H. Ji, “CONCRETE: improving cross-lingual fact-checking with cross-lingual retrieval,” in *Proceedings of the 29th International Conference on Computational Linguistics, COLING 2022*, Gyeongju, Republic of Korea, October 12-17, 2022, N. Calzolari, C. Huang, H. Kim, J. Pustejovsky, L. Wanner, K. Choi, P. Ryu, H. Chen, L. Donatelli, H. Ji, S. Kurohashi, P. Paggio, N. Xue, S. Kim, Y. Hamm, Z. He, T. K. Lee, E. Santus, F. Bond, and S. Na, Eds. International Committee on Computational Linguistics, 2022, pp. 1024–1035. [Online]. Available: <https://aclanthology.org/2022.coling-1.86>
- [206] Y. Liu, Y. Wan, L. He, H. Peng, and P. S. Yu, “KG-BART: knowledge graph-augmented BART for generative commonsense reasoning,” in *Thirty-Fifth AAAI Conference on Artificial Intelligence, AAAI 2021, Thirty-Third Conference on Innovative Applications of Artificial Intelligence, IAAI 2021, The Eleventh Symposium on Educational Advances in Artificial Intelligence, EAAI 2021*, Virtual Event, February 2-9, 2021. AAAI Press, 2021, pp. 6418–6425. [Online]. Available: <https://doi.org/10.1609/aaai.v35i7.16796>
- [207] H. Zhang, Z. Liu, C. Xiong, and Z. Liu, “Grounded conversation generation as guided traverses in commonsense knowledge graphs,” in *Proceedings of the 58th Annual Meeting of the Association for Computational Linguistics, ACL 2020*, Online, July 5-10, 2020, D. Jurafsky, J. Chai, N. Schluter, and J. R. Tetraault, Eds. Association for Computational Linguistics, 2020, pp. 2031–2043. [Online]. Available: <https://doi.org/10.18653/v1/2020.acl-main.184>
- [208] D. Cai, Y. Wang, W. Bi, Z. Tu, X. Liu, W. Lam, and S. Shi, “Skeleton-to-response: Dialogue generation guided by retrieval memory,” in *Proceedings of the 2019 Conference of the North American Chapter of the Association for Computational Linguistics: Human Language Technologies, NAACL-HLT 2019*, Minneapolis, MN, USA, June 2-7, 2019, Volume 1 (Long and Short Papers), J. Burstein, C. Doran, and T. Solorio, Eds. Association for Computational Linguistics, 2019, pp. 1219–1228. [Online]. Available: <https://doi.org/10.18653/v1/n19-1124>
- [209] M. Komeili, K. Shuster, and J. Weston, “Internet-augmented dialogue generation,” in *Proceedings of the 60th Annual Meeting of the Association for Computational Linguistics (Volume 1: Long Papers)*, ACL 2022, Dublin, Ireland, May 22-27, 2022, S. Muresan, P. Nakov, and A. Villavicencio, Eds. Association for Computational Linguistics, 2022, pp. 8460–8478. [Online]. Available: <https://doi.org/10.18653/v1/2022.acl-long.579>
- [210] K. Shuster, J. Xu, M. Komeili, D. Ju, E. M. Smith, S. Roller, M. Ung, M. Chen, K. Arora, J. Lane, M. Behrooz, W. Ngan, S. Poff, N. Goyal, A. Szlam, Y. Boureau, M. Kambadur, and J. Weston, “Blenderbot 3: a deployed conversational agent that continually learns to responsibly engage,” *CoRR*, vol. abs/2208.03188, 2022. [Online]. Available: <https://doi.org/10.48550/arXiv.2208.03188>
- [211] S. Kim, J. Y. Jang, M. Jung, and S. Shin, “A model of cross-lingual knowledge-grounded response generation for open-domain dialogue systems,” in *Findings of the Association for Computational Linguistics: EMNLP 2021*, Virtual Event / Punta Cana, Dominican Republic, 16-20 November, 2021, M. Moens, X. Huang, L. Specia, and S. W. Yih, Eds. Association for Computational Linguistics, 2021, pp. 352–365. [Online]. Available: <https://doi.org/10.18653/v1/2021.findings-emnlp.33>
- [212] D. Cai, Y. Wang, H. Li, W. Lam, and L. Liu, “Neural machine translation with monolingual translation memory,” in *Proceedings of the 59th Annual Meeting of the Association for Computational Linguistics and the 11th International Joint Conference on Natural Language Processing, ACL/IJCNLP 2021*, (Volume 1: Long Papers), Virtual Event, August 1-6, 2021, C. Zong, F. Xia, W. Li, and R. Navigli, Eds. Association for Computational Linguistics, 2021, pp. 7307–7318. [Online]. Available: <https://doi.org/10.18653/v1/2021.acl-long.567>
- [213] U. Khandelwal, A. Fan, D. Jurafsky, L. Zettlemoyer, and M. Lewis, “Nearest neighbor machine translation,” in *9th International Conference on Learning Representations, ICLR 2021*, Virtual Event, Austria, May 3-7, 2021. OpenReview.net, 2021. [Online]. Available: <https://openreview.net/forum?id=7wCBOJf8hJM>
- [214] X. Du and H. Ji, “Retrieval-augmented generative question answering for event argument extraction,” in *Proceedings of the 2022 Conference on Empirical Methods in Natural Language Processing, EMNLP 2022*, Abu Dhabi, United Arab Emirates, December 7-11, 2022, Y. Goldberg, Z. Kozareva, and Y. Zhang, Eds. Association for Computational Linguistics, 2022, pp. 4649–4666. [Online]. Available: <https://doi.org/10.18653/v1/2022.emnlp-main.307>
- [215] Y. Gao, Q. Yin, Z. Li, R. Meng, T. Zhao, B. Yin, I. King, and M. R. Lyu, “Retrieval-augmented multilingual keyphrase generation with retriever-generator iterative training,” in *Findings of the Association for Computational Linguistics: NAACL 2022*, Seattle, WA, United States, July 10-15, 2022, M. Carpuat, M. de Marneffe, and I. V. M. Ruíz, Eds. Association for Computational Linguistics, 2022, pp. 1233–1246. [Online]. Available: <https://doi.org/10.18653/v1/2022.findings-naacl.92>
- [216] E. Nijkamp, B. Pang, H. Hayashi, L. Tu, H. Wang, Y. Zhou, S. Savarese, and C. Xiong, “A conversational paradigm for program synthesis,” *CoRR*, vol. abs/2203.13474, 2022. [Online]. Available: <https://doi.org/10.48550/arXiv.2203.13474>
- [217] A. Madaan, S. Zhou, U. Alon, Y. Yang, and G. Neubig, “Language models of code are few-shot commonsense learners,” in *Proceedings of the 2022 Conference on Empirical Methods in Natural Language Processing, EMNLP 2022*, Abu Dhabi, United Arab Emirates, December 7-11, 2022, Y. Goldberg, Z. Kozareva, and Y. Zhang, Eds. Association for Computational Linguistics, 2022, pp. 1384–1403. [Online]. Available: <https://doi.org/10.18653/v1/2022.emnlp-main.90>
- [218] Y. Wang, H. Le, A. Gotmare, N. D. Q. Bui, J. Li, and S. C. H. Hoi, “CodeT5+: Open code large language models for code understanding and generation,” in *Proceedings of the 2023 Conference on Empirical Methods in Natural Language Processing, EMNLP 2023*, Singapore, December 6-10, 2023, H. Bouamor, J. Pino, and K. Bali, Eds. Association for Computational Linguistics, 2023, pp. 1069–1088. [Online]. Available: <https://aclanthology.org/2023.emnlp-main.68>
- [219] N. Beau and B. Crabbé, “The impact of lexical and grammatical processing on generating code from natural language,” in *Findings of the Association for Computational Linguistics: ACL 2022*, Dublin, Ireland, May 22-27, 2022, S. Muresan, P. Nakov, and A. Villavicencio, Eds. Association for Computational Linguistics, 2022, pp. 2204–2214. [Online]. Available: <https://doi.org/10.18653/v1/2022.findings-acl.173>
- [220] B. Wei, Y. Li, G. Li, X. Xia, and Z. Jin, “Retrieve and refine: Exemplar-based neural comment generation,” in *35th IEEE/ACM International Conference on Automated Software Engineering, ASE 2020*, Melbourne, Australia, September 21-25, 2020. IEEE, 2020, pp. 349–360. [Online]. Available: <https://doi.org/10.1145/3324884.3416578>
- [221] S. Liu, Y. Chen, X. Xie, J. K. Siow, and Y. Liu, “Retrieval-augmented generation for code summarization via hybrid GNN,”

- in 9th International Conference on Learning Representations, ICLR 2021, Virtual Event, Austria, May 3-7, 2021. OpenReview.net, 2021. [Online]. Available: <https://openreview.net/forum?id=zv-typlgPxA>
- [222] F. Yamaguchi, N. Golde, D. Arp, and K. Rieck, "Modeling and discovering vulnerabilities with code property graphs," in 2014 IEEE Symposium on Security and Privacy, SP 2014, Berkeley, CA, USA, May 18-21, 2014. IEEE Computer Society, 2014, pp. 590–604. [Online]. Available: <https://doi.org/10.1109/SP.2014.44>
- [223] S. Lu, D. Guo, S. Ren, J. Huang, A. Svyatkovskiy, A. Blanco, C. B. Clement, D. Drain, D. Jiang, D. Tang, G. Li, L. Zhou, L. Shou, L. Zhou, M. Tufano, M. Gong, M. Zhou, N. Duan, N. Sundaresan, S. K. Deng, S. Fu, and S. Liu, "Codexglue: A machine learning benchmark dataset for code understanding and generation," in Proceedings of the Neural Information Processing Systems Track on Datasets and Benchmarks 1, NeurIPS Datasets and Benchmarks 2021, December 2021, virtual, J. Vanschoren and S. Yeung, Eds., 2021. [Online]. Available: <https://datasets-benchmarks-proceedings.neurips.cc/paper/2021/hash/c16a5320fa475530d9583c34fd356ef5-Abstract-round1.html>
- [224] Y. Ding, Z. Wang, W. U. Ahmad, M. K. Ramanathan, R. Nallapati, P. Bhatia, D. Roth, and B. Xiang, "Cocomic: Code completion by jointly modeling in-file and cross-file context," CoRR, vol. abs/2212.10007, 2022. [Online]. Available: <https://doi.org/10.48550/arXiv.2212.10007>
- [225] B. Bogin, S. Gupta, P. Clark, and A. Sabharwal, "Leveraging code to improve in-context learning for semantic parsing," arXiv preprint arXiv:2311.09519, 2023.
- [226] Z. Jie and W. Lu, "Leveraging training data in few-shot prompting for numerical reasoning," arXiv preprint arXiv:2305.18170, 2023.
- [227] Y. Hao, W. Chen, Z. Zhou, and W. Cui, "E&v: Prompting large language models to perform static analysis by pseudo-code execution and verification," arXiv preprint arXiv:2312.08477, 2023.
- [228] G. Pinto, C. de Souza, J. B. Neto, A. de Souza, T. Gotto, and E. Monteiro, "Lessons from building stackspot ai: A contextualized ai coding assistant," 2024.
- [229] S. Ghosh, S. Kumar, C. K. R. Evuru, R. Duraiswami, and D. Manocha, "RECAP: retrieval-augmented audio captioning," CoRR, vol. abs/2309.09836, 2023. [Online]. Available: <https://doi.org/10.48550/arXiv.2309.09836>
- [230] B. Elizalde, S. Deshmukh, and H. Wang, "Natural language supervision for general-purpose audio representations," CoRR, vol. abs/2309.05767, 2023. [Online]. Available: <https://doi.org/10.48550/arXiv.2309.05767>
- [231] T. Kouzelis and V. Katsouros, "Weakly-supervised automated audio captioning via text only training," CoRR, vol. abs/2309.12242, 2023. [Online]. Available: <https://doi.org/10.48550/arXiv.2309.12242>
- [232] S. Deshmukh, B. Elizalde, D. Emmanouilidou, B. Raj, R. Singh, and H. Wang, "Training audio captioning models without audio," CoRR, vol. abs/2309.07372, 2023. [Online]. Available: <https://doi.org/10.48550/arXiv.2309.07372>
- [233] Y. Kirstain, O. Levy, and A. Polyak, "X&fuse: Fusing visual information in text-to-image generation," arXiv preprint arXiv:2303.01000, 2023.
- [234] Z. Zhang, A. Zhang, M. Li, H. Zhao, G. Karypis, and A. Smola, "Multimodal chain-of-thought reasoning in language models," arXiv preprint arXiv:2302.00923, 2023.
- [235] C. Xu, M. Yang, X. Ao, Y. Shen, R. Xu, and J. Tian, "Retrieval-enhanced adversarial training with dynamic memory-augmented attention for image paragraph captioning," Knowledge-Based Systems, vol. 214, p. 106730, 2021.
- [236] R. Ramos, D. Elliott, and B. Martins, "Retrieval-augmented image captioning," arXiv preprint arXiv:2302.08268, 2023.
- [237] Z. Hu, A. Iscen, C. Sun, Z. Wang, K.-W. Chang, Y. Sun, C. Schmid, D. A. Ross, and A. Fathi, "Reveal: Retrieval-augmented visual-language pre-training with multi-source multimodal knowledge memory," in Proceedings of the IEEE/CVF Conference on Computer Vision and Pattern Recognition, 2023, pp. 23 369–23 379.
- [238] Z. Li, W. Zhao, X. Du, G. Zhou, and S. Zhang, "Cross-modal retrieval and semantic refinement for remote sensing image captioning," Remote Sensing, vol. 16, no. 1, p. 196, 2024.
- [239] S. Chen, Q. Liu, Z. Yu, C. Lin, J. Lou, and F. Jiang, "Retrack: A flexible and efficient framework for knowledge base question answering," in Proceedings of the Joint Conference of the 59th Annual Meeting of the Association for Computational Linguistics and the 11th International Joint Conference on Natural Language Processing, ACL 2021 - System Demonstrations, Online, August 1-6, 2021, H. Ji, J. C. Park, and R. Xia, Eds. Association for Computational Linguistics, 2021, pp. 325–336. [Online]. Available: <https://doi.org/10.18653/v1/2021.acl-demo.39>
- [240] K. D. Bollacker, C. Evans, P. K. Paritosh, T. Sturge, and J. Taylor, "Freebase: a collaboratively created graph database for structuring human knowledge," in Proceedings of the ACM SIGMOD International Conference on Management of Data, SIGMOD 2008, Vancouver, BC, Canada, June 10-12, 2008, J. T. Wang, Ed. ACM, 2008, pp. 1247–1250. [Online]. Available: <https://doi.org/10.1145/1376616.1376746>
- [241] Y. Shu and Z. Yu, "Data distribution bottlenecks in grounding language models to knowledge bases," CoRR, vol. abs/2309.08345, 2023. [Online]. Available: <https://doi.org/10.48550/arXiv.2309.08345>
- [242] D. Leake and D. J. Crandall, "On bringing case-based reasoning methodology to deep learning," in Case-Based Reasoning Research and Development - 28th International Conference, ICCBR 2020, Salamanca, Spain, June 8-12, 2020, Proceedings, ser. Lecture Notes in Computer Science, I. Watson and R. O. Weber, Eds., vol. 12311. Springer, 2020, pp. 343–348. [Online]. Available: [https://doi.org/10.1007/978-3-030-58342-2\\_22](https://doi.org/10.1007/978-3-030-58342-2_22)
- [243] L. Zhang, J. Zhang, Y. Wang, S. Cao, X. Huang, C. Li, H. Chen, and J. Li, "FC-KBQA: A fine-to-coarse composition framework for knowledge base question answering," in Proceedings of the 61st Annual Meeting of the Association for Computational Linguistics (Volume 1: Long Papers), ACL 2023, Toronto, Canada, July 9-14, 2023, A. Rogers, J. L. Boyd-Graber, and N. Okazaki, Eds. Association for Computational Linguistics, 2023, pp. 1002–1017. [Online]. Available: <https://doi.org/10.18653/v1/2023.acl-long.57>
- [244] C. Wang, Y. Xu, Z. Peng, C. Zhang, B. Chen, X. Wang, L. Feng, and B. An, "keqing: knowledge-based question answering is a nature chain-of-thought mentor of LLM," CoRR, vol. abs/2401.00426, 2024. [Online]. Available: <https://doi.org/10.48550/arXiv.2401.00426>
- [245] J. Liu, S. Cao, J. Shi, T. Zhang, L. Hou, and J. Li, "Probing structured semantics understanding and generation of language models via question answering," CoRR, vol. abs/2401.05777, 2024. [Online]. Available: <https://doi.org/10.48550/arXiv.2401.05777>
- [246] D. Weininger, "Smiles, a chemical language and information system. 1. introduction to methodology and encoding rules," Journal of Chemical Information and Computer Sciences, 1988.
- [247] R. Irwin, S. Dimitriadis, J. He, and E. J. Bjerrum, "Chemformer: a pre-trained transformer for computational chemistry," Machine Learning: Science and Technology, 2022.
- [248] A. C. Anderson, "The process of structure-based drug design," Chemistry & biology, vol. 10, no. 9, pp. 787–797, 2003.
- [249] M. Batool, B. Ahmad, and S. Choi, "A structure-based drug discovery paradigm," International journal of molecular sciences, vol. 20, no. 11, p. 2783, 2019.
- [250] L. Yang, Z. Huang, X. Zhou, M. Xu, W. Zhang, Y. Wang, X. Zheng, W. Yang, R. O. Dror, S. Hong et al., "Prompt-based 3d molecular diffusion models for structure-based drug design," 2023.
- [251] D. P. Kingma and M. Welling, "Auto-encoding variational bayes," arXiv preprint arXiv:1312.6114, 2013.
- [252] J. Chen, H. Lin, X. Han, and L. Sun, "Benchmarking large language models in retrieval-augmented generation," CoRR, vol. abs/2309.01431, 2023. [Online]. Available: <https://doi.org/10.48550/arXiv.2309.01431>
- [253] S. ES, J. James, L. E. Anke, and S. Schockaert, "RAGAS: automated evaluation of retrieval augmented generation," CoRR, vol. abs/2309.15217, 2023. [Online]. Available: <https://doi.org/10.48550/arXiv.2309.15217>
- [254] J. Saad-Falco, O. Khattab, C. Potts, and M. Zaharia, "ARES: an automated evaluation framework for retrieval-augmented generation systems," CoRR, vol. abs/2311.09476, 2023. [Online]. Available: <https://doi.org/10.48550/arXiv.2311.09476>
- [255] <https://github.com/truera/trulens>.
- [256] Y. Lyu, Z. Li, S. Niu, F. Xiong, B. Tang, W. Wang, H. Wu, H. Liu, T. Xu, and E. Chen, "CRUD-RAG: A comprehensive chinese benchmark for retrieval-augmented generation of large language models," CoRR, vol. abs/2401.17043, 2024. [Online]. Available: <https://doi.org/10.48550/arXiv.2401.17043>
- [257] S. Barnett, S. Kurniawan, S. Thudumu, Z. Brannelly, and M. Abdelrazek, "Seven failure points when engineering a retrieval augmented generation system," CoRR, vol. abs/2401.05856, 2024. [Online]. Available: <https://doi.org/10.48550/arXiv.2401.05856>
- [258] F. Cuconasu, G. Trappolini, F. Siciliano, S. Filice, C. Campagnano, Y. Maarek, N. Tonello, and F. Silvestri, "The power of noise: Redefining retrieval for RAG systems," CoRR, vol. abs/2401.14887, 2024. [Online]. Available: <https://doi.org/10.48550/arXiv.2401.14887>

- [259] L. Qiu, P. Shaw, P. Pasupat, T. Shi, J. Herzig, E. Pitler, F. Sha, and K. Toutanova, "Evaluating the impact of model scale for compositional generalization in semantic parsing," *arXiv preprint arXiv:2205.12253*, 2022.
- [260] R. Aksitov, C. Chang, D. Reitter, S. Shakeri, and Y. Sung, "Characterizing attribution and fluency tradeoffs for retrieval-augmented large language models," *CoRR*, vol. abs/2302.05578, 2023. [Online]. Available: <https://doi.org/10.48550/arXiv.2302.05578>
- [261] C. Han, Q. Wang, W. Xiong, Y. Chen, H. Ji, and S. Wang, "Lm-infinite: Simple on-the-fly length generalization for large language models," *CoRR*, vol. abs/2308.16137, 2023. [Online]. Available: <https://doi.org/10.48550/arXiv.2308.16137>
- [262] S. Jindal, "Did google gemini 1.5 really kill rag?" <https://analyticsindiamag.com/did-google-gemini-1-5-really-kill-rag/>, 2024.
- [263] H. Chase, "Langchain," <https://github.com/langchain-ai/langchain>, 2022.