SingVisio: Visual Analytics of Diffusion Model for Singing Voice Conversion

Liumeng Xue^{a,*}, Chaoren Wang^{a,*}, Mingxuan Wang^a, Xueyao Zhang^a, Jun Han^a, Zhizheng Wu^{a,b}

^aSchool of Data Science, The Chinese University of Hong Kong, Shenzhen (CUHK-Shenzhen), China

^bShanghai AI Lab

ABSTRACT

In this study, we present SingVisio, an interactive visual analysis system that aims to explain the diffusion model used in singing voice conversion. SingVisio provides a visual display of the generation process in diffusion models, showcasing the step-by-step denoising of the noisy spectrum and its transformation into a clean spectrum that captures the desired singer’s timbre. The system also facilitates side-by-side comparisons of different conditions, such as source content, melody, and target timbre, highlighting the impact of these conditions on the diffusion generation process and resulting conversions. Through comprehensive evaluations, SingVisio demonstrates its effectiveness in terms of system design, functionality, explainability, and user-friendliness. It offers users of various backgrounds valuable learning experiences and insights into the diffusion model for singing voice conversion.

Keywords: Machine Learning, Explainable AI, Visual Analytics, Audio Processing

1. Introduction

Deep generative models have become increasingly prevalent in a myriad of data generation tasks, ranging from image generation to audio generation. Among these, diffusion-based generative models have emerged as a cutting-edge research focus and the go-to methodology for such applications [1]. In the field of computer vision, diffusion models have gained significant popularity [2, 3], particularly in applications such as text-to-image synthesis [4, 5, 5], video generation [3] and editing [6]. In the audio community, there have been extensive studies of diffusion models in waveform synthesis [7, 8], sound effects generation [9, 10], speech generation [11, 12], and music generation [13, 14]. Given their wide-ranging utility and impressive performance, there is a burgeoning curiosity and necessity to unravel the intricacies of the diffusion process underpinning these generative tasks. However, the complexity of the involved Markov chains and their abstruse mathematical formulations pose a significant hurdle to novices in the field. In recent years, visual and interactive methodologies have proven instrumental in deciphering the structures and working mechanisms in various deep-learning models. This insight has spurred us to develop interactive visual tools aimed at broader audiences, facilitating a deeper comprehension of diffusion-based generative models. The paper represents a stride forward in our endeavor to demystify the diffusion-based generative paradigm.

Owing to its exceptional capabilities, the diffusion-based generative model has quickly risen as a formidable contender in single voice conversion (SVC). This advanced technique adeptly alters one singer’s voice to another’s, meticulously preserving the song’s original content and melody, as investigated in the studies [15, 16, 17]. When juxtaposed with other generative models, such as Generative Adversarial Networks (GANs) [18] and Variational Auto-Encoders (VAEs) [19], diffusion-based models resolve the issue of unsatisfactory audio quality via incrementally introducing noise into the data and iteratively learning to eliminate noise. Due to iterative noising and denoising processes in synthesizing high-quality data, comprehending the changes in the diffusion process is difficult. Furthermore, grasping the impact of various conditions on the generation process, such as the source voice’s content and melody and the target singer’s unique timbre in SVC, remains highly challenging. Users need to be actively and engagingly involved for a more profound comprehension and learning experience. However, the current pedagogical approaches for beginners learning about diffusion-based models are overly dependent on textual explanations and mathematical descriptions. Methods involving visualization and exploratory interaction are less common, as evidenced by examples such as [20] and [21], which do not offer users an immersive understanding of the diffusion process. This highlights an urgent demand for comprehensive, interactive, and visually intuitive tools designed for diffusion-based generative models to fill this gap.

To address the aforementioned difficulties, we have developed SingVisio, a specialized visual analytic system for diffusion-based SVC¹. SingVisio aims to demystify the entire

*Equal contribution

e-mail: xueliumeng@cuhk.edu.cn (Liumeng Xue),
chaorenwang@link.cuhk.edu.cn (Chaoren Wang),
mingxuanwang1@link.cuhk.edu.cn (Mingxuan Wang),
xueyaozhang@link.cuhk.edu.cn (Xueyao Zhang),
hanjun@cuhk.edu.cn (Jun Han), wuzhizheng@cuhk.edu.cn (Zhizheng Wu)

¹SingVisio can be accessed via <https://dsvc.openmmlab.org.cn/>

diffusion process by extracting and rendering the hidden features of the diffusion model under diverse conditions. These features are then mapped onto a two-dimensional plane to facilitate visual comparisons and uncover patterns. The system also incorporates Mel spectrograms to vividly depict audio quality at various stages of the diffusion process. These spectrograms provide an intricate view of the pitch variations as they evolve, thereby enhancing our understanding of the musical melody’s fidelity.

Furthermore, SingVisio introduces a novel pairwise comparative visualization strategy. This approach allows users to intuitively investigate and juxtapose two different diffusion conditions within the same category. The utility of this comparative design lies in its ability to facilitate direct comparisons between different conditions and deepen the user’s insight into the specific impact each condition has on the diffusion process. By embedding source and target audio references directly into the visualization interface, SingVisio offers users a comprehensive perspective on the audio transformation journey from the initial state to the final output under various conditions. This integrated approach offers a richer, more contextualized user experience, enabling a thorough understanding of the voice conversion process enabled by diffusion-based generative models.

The contributions of this work can be summarized as follows:

- **A visual analytics system for understanding SVC.** To the best of our knowledge, this is the first system supporting the exploration, visualization, and comparison of the diffusion model within the context of SVC. It offers a versatile platform for comparing various aspects of the diffusion process, SVC modes, and evaluation metrics, allowing for a thorough exploration.
- **Novel interactive exploration approach to understanding diffusion-based SVC.** We have supported three core interactive exploration modes within our system: **data-driven** exploration, which is steered by varying melodies, **condition-driven** exploration that pivots on the specific inputs provided to the diffusion model, and **evaluation-driven** exploration, which is based on the audio quality assessment metric. These interactive modes are thoughtfully designed to aid users in comprehending and navigating the diffusion process integral to SVC.
- **A comprehensive evaluation of SingVisio.** We conducted a comprehensive evaluation of our system, including a case study involving two beginners, an expert study with two experts, and a formal user study encompassing both subjective and objective assessments for general users. Such evaluation shows the effectiveness of our system.

2. Related Work

2.1. Singing Voice Conversion

The early singing voice conversion research aims to design parametric statistical models such as HMM [22] or GMM [23, 24] to learn the spectral features mapping of the parallel data.

Since the parallel singing voice corpus is challenging to collect on a large scale, the non-parallel SVC [25, 26], or recognition-synthesis SVC [27], has been popular in recent years, whose pipeline is displayed in Fig. 1. In the non-parallel SVC pipeline, the acoustic model conducts the feature conversion from source to target. It can be various types of generative models, including autoregressive models [26], GAN-based models [28, 29], VAE-based models [30, 31], or Flow-based models [31]. Besides, adopting a diffusion-based acoustic model is also promising for VC [32, 33] and SVC [15, 16, 17]. Recently, more and more research has verified the strong performance of diffusion models in modeling audio areas [13, 8, 12, 34].

Although the diffusion model has shown impressive quality and performance when applied to SVC, our understanding of its internal mechanisms is still limited. Firstly, the existing diffusion models are still based on black-box neural networks. Visualizing how it achieves singing voice conversion through step-by-step denoising would greatly deepen researchers’ comprehension of the diffusion model’s operating principles. Secondly, the SVC conditions, which serve as inputs to the diffusion model, are crucial factors influencing the final conversion results. However, we are still unclear about how different conditions affect the performance of the diffusion model. Motivated by that, this paper will conduct a systematic analysis of diffusion-based SVC under different diffusion steps and diverse SVC conditions, like varied sources and targets.

2.2. Visual Analysis for Explainable AI

EXplainable Artificial Intelligence (XAI) [35] has become increasingly important as machine learning models, especially deep learning models, grow in complexity and usage in critical applications [36]. Visual analysis tools have been developed to make these models more interpretable and trustworthy to users. CNN Explainer simplifies the understanding of Convolutional Neural Networks (CNNs) by visualizing their feature extraction process [37]. LSTMVis [38] and DQNViz [39] offer insights into the decision-making processes of LSTM networks and Deep Q-Networks, respectively. M2Lens [40] and CNNVis [41] are designed to dissect the intricate layers of CNNs, providing a detailed examination of filter activations and network architectures. AttentionViz focuses on the attention mechanisms in models, revealing how models prioritize different parts of the input data for decision-making [42].

Additionally, the interpretation of generative models through visualization addresses the challenge of understanding complex data generation processes. Adversarial-Playground [43], GAN-Lab [44] and GANViz [45] are interactive tools for exploring and interpreting Generative Adversarial Networks (GANs). Research on analyzing the training processes of deep generative models uncovers the dynamics and stability issues inherent in these models. Further, DrugExplorer [46] exemplifies the application of visualization techniques in domain-specific areas. Recently, diffusion models have shown exceptional capabilities in generative tasks, and accordingly the visualization tool, aiming at making the diffusion process comprehensible to humans, is investigated [47]. Besides, Diffusion Explainer concentrates on demystifying the stable diffusion process, offering an un-

derstanding of the transformation from text prompts into images [48]. In our work, we design an interactive visual analysis system for the diffusion model applied in singing voice conversion. It illustrates how the noisy spectrum is gradually denoised under the influence of conditions, ultimately converting the spectrum to the target singer’s timbre.

3. Background: Diffusion-based Singing Voice Conversion

In this section, we will introduce the classic pipeline of SVC (Section 3.1) and our chosen diffusion-based SVC model to visualize and analyze (Section 3.2). Besides, we will describe the common evaluation metrics of SVC and how this paper visualizes them (Section 3.3).

3.1. Singing Voice Conversion Pipeline

SVC aims to transform the voice in a singing signal to match that of a target singer, while preserving the original lyrics and melody [49]. We display the classic pipeline of SVC in Fig. 1. The process begins with the extraction of content (i.e., lyrics) and melody features from the source, alongside the speaker identity features (i.e., timbre) from the target. These features are then combined to form the conditions for SVC, which are fed into generative models, also known as acoustic models, to generate the converted acoustic features such as the Mel spectrogram. The final step involves using waveform synthesizers (i.e., vocoders) to synthesize the actual audio.

It is important to note that the acoustic model is responsible for mapping the features from the source to the target. In this study, the term ‘diffusion-based singing voice conversion’ is used to denote that the acoustic model in the SVC system is a diffusion model.

3.2. DiffWaveNetSVC

In this study, we select DiffWaveNetSVC [50, 16] as the SVC’s acoustic model to visualize and analyze. The internal module of the DiffWaveNetSVC is based on Bidirectional Non-Causal Dilated CNN [15, 8], which is similar to WaveNet [51]. Its architecture, workflow, and implementation will be detailed as follows.

3.2.1. Architecture and Workflow

The architecture of DiffWaveNetSVC is shown in Fig. 2. It consists of multiple residual layers, within which it adopts Bidirectional Non-Causal Dilated CNN (“Bi-Dilated Conv” in Fig. 2) like [51, 8, 15]. During training (i.e., the forward process of diffusion model), we extract the content, melody, and speaker features from the same sample (which means the source and target in Fig. 1 are the same) and add them to obtain the SVC conditions \mathbf{c} . At the step $t \in [0, 1, 2, \dots, T]$, we sample a Gaussian noise $\epsilon_t \sim N(\mathbf{0}, \mathbf{I})$ and obtain the noisy Mel spectrogram:

$$\mathbf{y}_t = \sqrt{\alpha_t} \mathbf{y}_0 + \sqrt{1 - \alpha_t} \epsilon_t, \quad (1)$$

where α_t is the noise weight in diffusion model [52]. And the training objective can be considered to predict the noise ϵ_t using

the neural network:

$$\begin{aligned} \hat{\epsilon}_t &= \text{DiffWaveNetSVC}(t, \mathbf{y}_t, \mathbf{c}), \\ \mathcal{L}_t &= \text{MSE}(\hat{\epsilon}_t, \epsilon_t), \end{aligned} \quad (2)$$

where **DiffWaveNetSVC** represents the whole encoder based on the residual layers and **MSE** means the mean squared error loss function.

During inference/conversion (the reverse process of diffusion model), given the source and target, we extract the content and melody features from the source, extract the speaker features from the target, and add them as the SVC conditions \mathbf{c} . We feed a Gaussian noise $\hat{\mathbf{y}}_T \sim N(\mathbf{0}, \mathbf{I})$ to DiffWaveNetSVC and employ deep denoising implicit models [52] with T denoising steps to produce Mel spectrogram $\hat{\mathbf{y}}_0$.

3.2.2. Implementation Details

In this paper, we follow the Amphion’s implementation [50]² for DiffWaveNetSVC. Specifically, the layer number N is 20, and the diffusion step number T is 1000. Following Zhang et al. [16], we adopt both Whisper [53] and ContentVec [54] as the content features, we use Parselmouth³ [55] to extract F0 as the melody features, and we adopt look-up table to obtain the one-hot speaker ID as the speaker features. We utilize the DiffWaveNetSVC checkpoint of Zhang et al. [16] to conduct the inference, conversion, and visualization analysis, which is pre-trained on 83.1 hours of speech (111 speakers) and 87.2 hours of singing data (96 singers). The detailed information about the dataset is described in Appendix B. For waveform synthesizer, we use the pre-trained Amphion Singing BigVGAN⁴ to produce waveform from Mel spectrogram.

3.3. Evaluation Metrics of Singing Voice Conversion

Accurately and effectively assessing the results of singing voice conversion remains a challenging task. Typically, the assessment includes both objective and subjective evaluations. Objective evaluation involves measuring system performance in areas such as spectrogram distortion, F0 modeling, intelligibility, and speaker similarity. However, these objective metrics, calculated based on certain acoustic features or abstract representations, may not always align with human perception [56, 49]. For subjective evaluation, most research employs Mean Opinion Score (MOS) based listening tests, focusing primarily on metrics like naturalness and similarity. Yet, the reliability of MOS scores hinges on having a sufficiently large number of listeners and tests, which is not always feasible [56].

With a vast array of synthesized samples to evaluate – for instance, 1000 samples at 1000 diffusion steps for just a single source and target combination – conducting Mean Opinion Score (MOS) evaluations becomes impractical. To address this, we adopt the evaluation methodology from Amphion [50]⁵ for our objective assessment. This includes metrics such as

²<https://github.com/open-mmlab/Amphion/tree/main/egs/svc/MultipleContentsSVC>

³<https://parselmouth.readthedocs.io/en/stable/index.html>

⁴https://huggingface.co/amphion/BigVGAN_singing_bigdata

⁵<https://github.com/open-mmlab/Amphion/tree/main/egs/metrics>

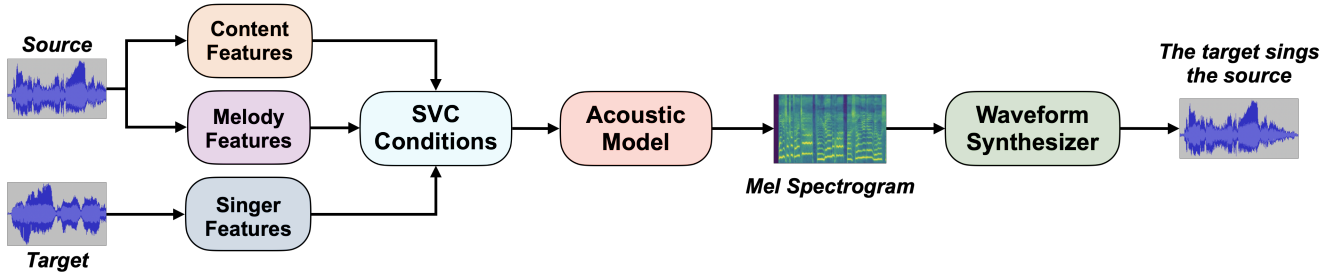

Fig. 1: The classic pipeline of SVC system. In this study, we use “diffusion-based singing voice conversion” to refer that the acoustic model in the SVC system is a diffusion model.

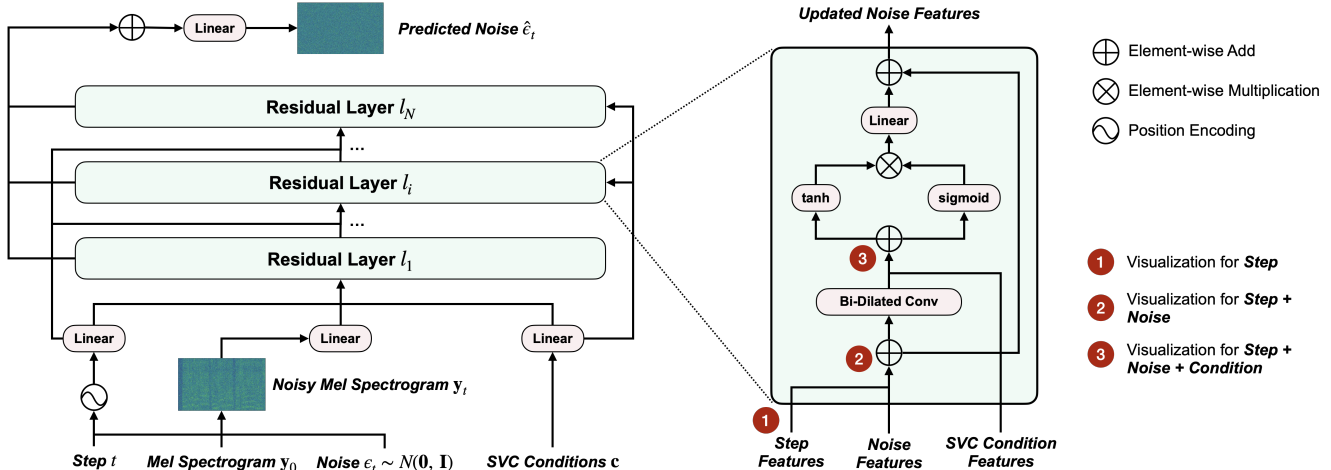

Fig. 2: The architecture of DiffWaveNetSVC [50, 16]. We select the *Step*, *Step+Noise*, and *Step+Noise+Condition* to project and visualize in SingVisio’s Project View (Section 5.4)

Singer Similarity (Dembed) with Resemblyzer⁶, **F0 Pearson Correlation Coefficient (F0CORR)**, **Fréchet Audio Distance (FAD)**, **F0 Root Mean Square Error (F0RMSE)**, and **Mel-cepstral Distortion (MCD)**. These metrics are designed to measure the outcomes of singing voice conversion comprehensively. Detailed definitions of these metrics are provided in Appendix C

4. Design Requirements

4.1. Expert Interview

Through a series of interviews with experts in audio signal processing and machine learning, we identified three critical tasks that our system needs to support for effective analysis and interpretation of the diffusion model for SVC.

C1: In-Depth Temporal Dynamics Analysis of Diffusion Generation Process

Experts highlighted the importance of visualizing the temporal dynamics of the diffusion generation process in singing voice conversion. The objective is to create detailed visual representations that effectively trace the step-by-step evolution occurring in voice conversion at each diffusion stage. This involves visualizing the progression of various acoustic parameters, such as frequency components and harmonics that

evolve over time. The visualizations are expected to provide users with an intuitive understanding of the voice transformation, highlighting the nuanced evolution from a noisy beginning to a structured and coherent output, thereby making the process more transparent and understandable to users without deep technical expertise in machine learning or signal processing.

C2: Comprehensive Performance Metrics Evaluation in Singing Voice Synthesis

This task is centered on tracking evaluation metrics that gauge the quality of the converted voice at each step of the diffusion generation process. These metrics include pitch accuracy, timbre consistency, naturalness, and speech quality. The system should enable a detailed analysis of how each metric evolves with every diffusion step, offering insights into the conversion quality at different phases of the generation process. This comprehensive evaluation is pivotal in identifying aspects where the conversion achieves optimal quality or, conversely, where improvements are needed. This visual representation enhances the interpretability of the evaluation results and fosters insights into the underlying dynamics of the diffusion generation process.

C3: Comparative Analysis of Different Source Singers, Songs, and Target Singers

Through visualization, we aim to systematically compare how different characteristics of source singers, such as vocal tone, pitch range, and singing style, influence the conversion outcome. This will help in identifying specific attributes of

⁶<https://github.com/resemble-ai/Resemblyzer>

source singers that are more amenable to conversion. Additionally, the complexity and structure of the song itself are crucial variables. Songs with intricate melodic lines or complex rhythms might pose more significant challenges in conversion processes. Equally important is the analysis of the target singers’ characteristics. The system should visualize how well the model adapts the source singer’s voice to match the timbre of the target singers. This could lead to valuable insights, such as identifying particularly challenging source-target pairings or songs that consistently yield high-quality conversions. Such analysis is not only crucial for understanding the current model’s performance but also for guiding future improvements and applications in singing voice conversion technology.

These tasks, shaped by expert insights, outline the foundational requirements for our visual analytic system, ensuring that it addresses the key aspects of understanding the diffusion model for singing voice conversion.

4.2. Analytical Tasks

Our system is a visualization system designed specifically for diffusion-based singing voice conversion tasks. Diffusion-based singing voice conversion itself involves two aspects: in the realm of machine learning, it involves the diffusion generative model, and in the field of audio signal processing, it pertains to singing voice conversion. Therefore, the analytical tasks supported by our visualization system can be divided into two major categories.

In the aspect of machine learning, particularly in the diffusion model, to investigate the evolution and quality of the generated result from each step in the diffusion generation process, our system should support the following two tasks.

T1: Step-wise Diffusion Generation Comparison. Examining the generated result of each step in the diffusion generation process helps in understanding the model’s behavior. Analyzing these early outputs can help us understand how the model initially handles noise. As each step incrementally adds detail and structure to the output, by inspecting intermediate steps, we can observe the step-by-step improvement in content quality. (C1)

T2: Step-wise Metric Comparison. As the diffusion steps progress, the generated content becomes clearer and more refined. Analyzing the objective evaluation metrics and their corresponding curves along the diffusion steps serves as a useful tool for assessing both the quantitative and qualitative aspects of the generated content. By tracking these metrics over the diffusion steps, we gain insights into how the model refines its output over time. (C2)

Regarding SVC, as described in Section 3, there are three factors (content, melody, singer timbre) that have a direct impact on the results of SVC and, therefore, should be considered during the conversion process. To explore the impact of different factors on the converted results, the system needs to provide support for the following three tasks.

T3: Pair-wise SVC Comparison with Different Target Singers. Pair-wisely comparing SVC under two different conditions of the target singer at different diffusion steps. This task helps us to understand the impact of the timbre of the target

singer that should be converted to the converted results of SVC, particularly in terms of singer similarity. (C1, C3)

T4: Pair-wise SVC Comparison with Different Source Singers. Pair-wisely comparing SVC under two different conditions of source singer at different diffusion steps. This task benefits us in exploring the impact of the melody of the source that should be kept on the converted results of SVC, particularly in terms of F0CORR, FORMSE. (C1, C3)

T5: Pair-wise SVC Comparison with Different Songs. Pair-wisely comparing SVC under two different conditions of the song at different diffusion steps. This task facilitates us to explore the impact of the content information conveyed in the song that should be maintained on the converted results of SVC, particularly in terms of MCD. (C1, C3)

5. Explainer System

Fig. 3 shows the overview of the explainer system which consists of five components: **Control Panel** allows users to modify the display mode and choose data for visual comprehension; **Step View** provides users with an overview of the diffusion generation process; **Comparison View** makes it easy for users to compare converted results between different conditions; **Projection View** helps users observe the trajectory of diffusion steps with or without conditions; **Metric View** displays objective metrics evaluated on the diffusion-based SVC model, enabling users to interactively examine metric trends across diffusion steps.

5.1. Control Panel

The control panel consists of six components, including two drop-down boxes to enable users to select display mode and projection embedding, three checkboxes to select source singer, source song, and target singer, and a step controller to enable users to control the diffusion step.

- **Display Mode** We design five types of display modes, including Step Comparison, Source Singer Comparison, Song Comparison, Target Singer Comparison, and Metric Comparison. Users can click the drop-down box of “Display Mode ” to choose a specific model.
 - **Step Comparison** This mode primarily focuses on step-wise comparing the diffusion steps in the generation process. It (1) provides an animation of random noise gradually refined for users to have an overview of the whole denoising process in **Step View**, (2) enables users to flexibly select and detailedly compare the generated results from different diffusion steps in **Comparison View**.
 - **Source Singer Comparison** This mode focuses on the pair-wise comparison of converting two different source singers’ audio with the same song to the same target singer. It (1) allows users to select two different source singers, a source song and a target singer, (2) provides the details (including Mel spectrogram, pitch contour, and audible audio) of the

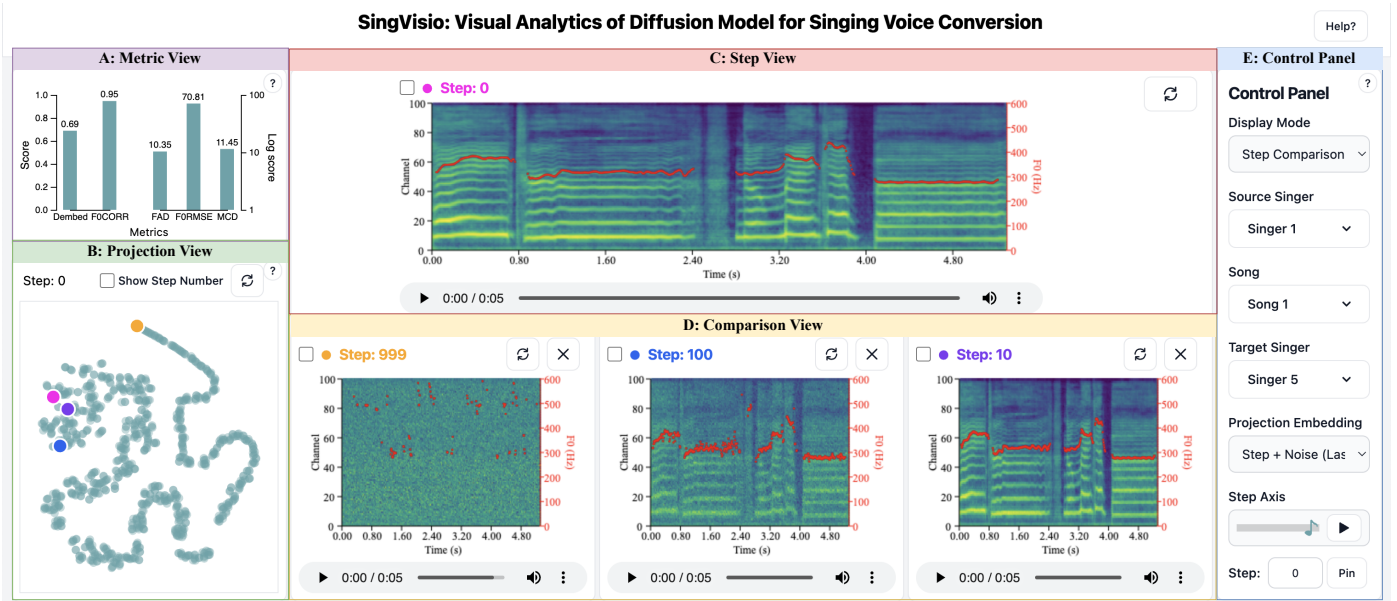

Fig. 3: Visual system for diffusion-based singing voice conversion. The system consists of five views. (A) *Metric View* shows objective evaluation results on the singing voice conversion model, allowing users to interactively explore the performance trend along diffusion steps. (B) *Projection View* aids users in tracking the data patterns of diffusion steps in the embedding space under different input conditions. (C) *Step View* provides users with the visualization of Mel spectrogram and pitch contour at one diffusion step. (D) *Comparison View* facilitates users to compare voice conversion results among different diffusion steps or singers. (E) *Control Panel* enables users to select various comparison modes and choose different source and target singers to visually understand and analyze the model behavior.

two source audio and the target audio in the *Comparison View*, (3) presents two conversion animations wherein random noise undergoes gradual refinement to transform into the singing voice of the target speaker in the *Step View*.

- **Song Comparison** This mode focuses on the pair-wise comparison of converting two different source audios that are derived from the same singer but contain different songs to the same target singer. It (1) allows users to select a source singer, a target singer but two songs, (2) provides the details (including Mel spectrogram, pitch contour, and audible audio) of the two source singers’ audio and the target singer’s audio in the *Comparison View*, (3) supplies two conversion animations illustrating the progressive refinement of random noise into the singing voice of the target in the *Step View*.
- **Target Singer Comparison** This mode focuses on the pair-wise comparison of converting the same source singing voice (also means the same song) to two different target singers. It (1) enables users to select a source singer and a source song, but two target singers, (2) provides the details (including Mel spectrogram, pitch contour, and audible audio) of the source singer’s audio, and two target singers’ audio in the *Comparison View*, (3) provides the two corresponding conversion animations of random noise gradually refined to the target speaker singing voice in the *Step View*.
- **Metric Comparison** This mode presents five objective evaluation metric results of the diffusion-based

SVC model represented by a bar chart. It (1) enables users to click on a specific metric bar and then the system filters out an example that gains the best on the corresponding metric and displays metric curves along diffusion steps in the *Comparison View*, (3) enables users to hover over and slide the mouse along the step axis of the metric curve, and then system will display the values of that metric at different steps in the *Comparison View* while synchronously showing the generated results at different steps in the *Step View*.

- **Source Singer/Source Song/Target Singer** Three dropdown boxes offer users options for source singer, source song, and target singer.
- **Projection Embedding** A drop-down box to enable users to choose different projection embeddings from different layers. Then, the system displays 2D t-SNE visualization results of the high-dimensional diffusion steps in the *Projection View*. Specifically, the projection embedding can be the diffusion steps, the combined embeddings of the step and noise, or step, noise and conditions. These embeddings can come from the first, middle, or final residual layer in the diffusion model, as illustrated in Fig. 2.
- **Step Controller** The Step Controller includes (1) a step slider to smoothly control the diffusion step, (2) a tooltip to display or input a specific step number, and (3) a button named ‘Pin’ enables users to add a specific step’s generated result in the *Comparison View*.

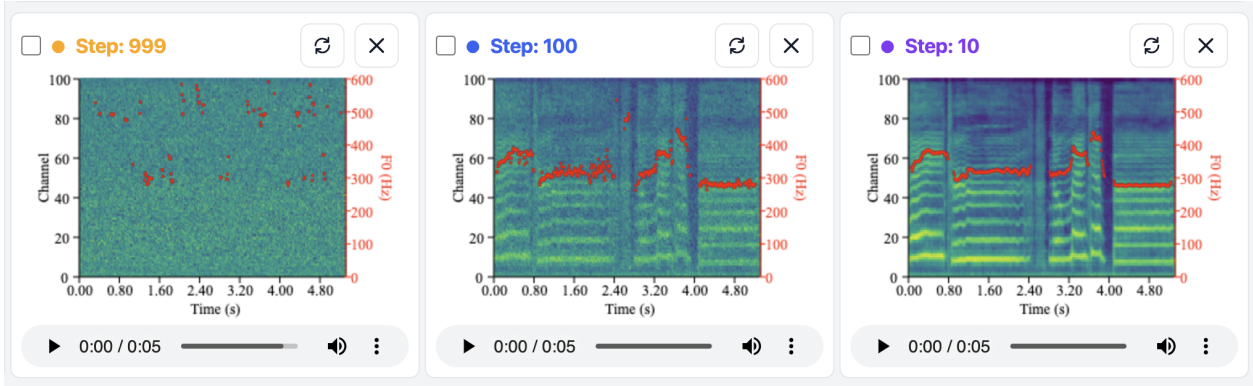

Fig. 4: Comparison view under the step comparison mode. This view, by default, shows the outcomes of three diffusion steps, including step 999, step 100, and step 10, each marked with a distinct color.

5.2. Step View

This view enables users to visualize the whole generation process of diffusion in the context of singing voice conversion tasks, which means users can observe how the spectral characteristics change over time as noise is subsequently removed, leading to the desired singing voice conversion. Specifically, it can be observed that the Mel spectrogram transitions from being completely noisy to gradually becoming clearer, and the fundamental frequency curve also transforms from scattered points into a smooth curve. The audio also undergoes a process of gradual optimization from being pure noise to having improved sound quality and intelligibility.

The control panel, mentioned earlier, allows users to interact with the diffusion process by smoothly sliding the step slider. Users can adjust the diffusion time step to observe the intermediate results of the generation process, enlarge the Mel spectrogram to observe detailed information through a brush operation, and restore it back to the original Mel spectrogram using the refresh button in the top right corner in the *Step View*.

In the *Step Comparison* and *Condition Comparison* modes, the content presented in the *Step View* is slightly different. In the *Step Comparison* mode, we focus on comparing and analyzing the converted results from different steps, so only one diffusion process animation is displayed in the view. While, in the *Condition Comparison* mode, the main objective is to compare the conversion results under different conditions, e.g., source singer, song, and target singer. At this time, the *Step View* shows pair-wise diffusion process animations for two different conditions.

5.3. Comparison View

To facilitate a more convenient and detailed observation of the intermediate results generated by the diffusion model, we introduce a *Comparison View*, as shown in Fig. 4. This view provides basic information, including the audible audio, its corresponding Mel spectrogram, and fundamental frequency contour. All the information related to a clip of audio forms a basic block, which we refer to as the ‘basic display unit’. In Fig. 4, there are three basic display units.

On this basic display unit, we can observe the range of the F0 and the pattern of the F0 contour. Through the brush operation,

we can synchronously magnify all Mel spectrograms illustrated in this view, thus enabling a more detailed comparison and examination of the spectral differences. When there are multiple basic display units, users can select the checkboxes in the top left corner of any two basic display units. The page will then pop up the visualization of the difference in the Mel spectrogram between these two basic display units, as shown in Fig. 5, allowing for a clearer and more convenient comparison. Specifically, the differences are represented by colors. Warmer colors like reds and oranges signify larger differences, while cooler colors like blues and greens represent smaller differences between the two selected Mel spectrograms.

Furthermore, the components displayed in the *Comparison View* differs between the *Step Comparison Mode* and the *Condition Comparison Mode*. The *Step Comparison Mode* is primarily used to compare the results of different diffusion steps. In this mode, the *Comparison View* will display basic display units from three different steps, based on the steps selected by the user. The relative position of different basic display units (corresponding to different steps) can be directly adjusted by dragging. On the other hand, the *Condition Comparison Mode* sports a similar layout, but mainly compares the results of SVC under different conditions. In this mode, the *Comparison View* primarily displays the basic display units corresponding to different audios of the source and target singers selected by users. Additionally, in *Metric Comparison Mode*, the *Comparison View* illustrates the metric curve over the diffusion step, which is described in Section 5.5.

5.4. Projection View

High-dimensional diffusion steps can be challenging to interpret directly. t-SNE reduces the dimensionality, projecting the steps into a lower-dimensional space. It allows researchers to gain insights into the intricate structure and relationships within the high-dimensional diffusion step space. By projecting these steps into a lower-dimensional space, t-SNE reveals patterns and trajectories of the diffusion steps, enabling a visual exploration of similarities, differences, and the dynamic evolution of the diffusion process of different generation samples.

Consequently, we design *Projection View* to present the two-dimensional space obtained by projecting high-dimensional dif-

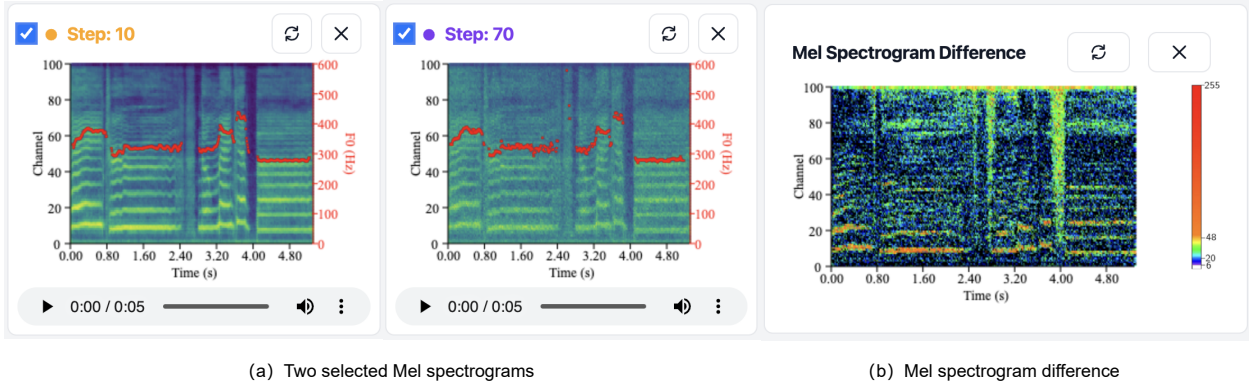

Fig. 5: The Mel spectrogram difference between two selected Mel spectrograms. When any two Mel spectrograms displayed in the comparison view are selected (via the checkboxes in the top left corner of the basic display unit) (a), a view showing the Mel spectrogram difference will pop up (b).

fusion step embeddings (i.e., the step features in Fig. 2), as shown in Fig. 3. Each point represents a diffusion step, and all 1000 diffusion steps together form a trajectory in space. Users can hover their mouse over the points and slide to inspect the step trajectory. While sliding the mouse, users can simultaneously observe the SVC results transition from a coarse state to a fine state in *Step View*.

noise and condition, as indicated by the red solid dots in Fig. 2. By examining the projection embedding results of combining diffusion step with noise and condition, users can compare the differences in diffusion step trajectories under different condition scenarios.

5.5. Metric View

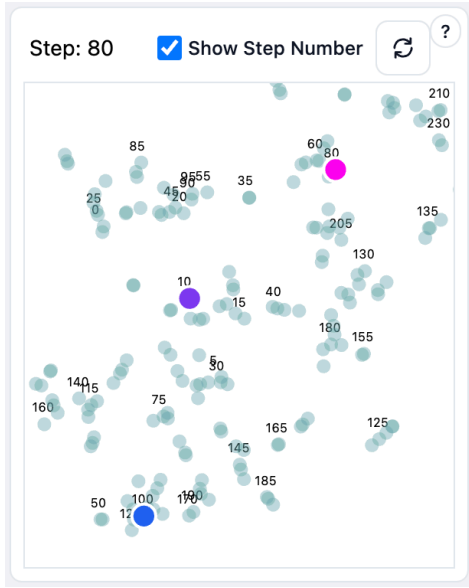

Fig. 6: Projection View zoomed in with ‘Show Step Number’ checked

Additionally, users can enable the “Show Step Number” checkbox to display the step number associated with each step. By scrolling the mouse wheel, they can zoom in or out on the points in the space to explore the distribution of diffusion steps. By clicking on a specific step point, a basic display unit corresponding to the step will be added into the *Comparison View*. For example, Fig. 6 shows points for three diffusion steps: 100 (blue), 80 (magenta), and 10 (purple).

As described in Section 5.1, the drop-down menu of projection embedding in the control panel provides multiple projection embedding sources, including not only the vanilla diffusion step but also the combination of the diffusion step with

Metric View is designed to show the overall objective metrics evaluated on the model. The five metrics, including Dembed, FOCORR, FAD, FORMSE, and MCD, are divided into two groups based on whether the values of the metrics are positively or negatively correlated with model performance and drawn in histograms. Here, the labels of the x-axis denote different metrics, and the labels of the y-axis are scores (the higher the better) and log scores (the lower the better). Each bar in the histogram is labeled with the calculated result corresponding to the metric. In the top right corner of this view, there is a button represented by a question mark. When users click this button, a tip box will appear providing descriptions of the definitions of each metric.

The *Metric View* represents an average of all samples within the testing data pool, providing a comprehensive overview of the model performance with five objective metrics. Upon hovering over a particular metric, the system automatically identifies and selects the best-performing sample. This selection triggers a detailed visualization of the diffusion step for that sample within the *Projection View*. Additionally, for the chosen sample, the system dynamically computes and displays evaluation metrics, which are then used to plot the “Metric Curve over Diffusion Step” in *Comparison View*, as shown in Fig. 7.

At the top of the curve, five legends denoted as five different metrics are present with distinct colors. The x-axis shows different steps ranging from 999 to 0 as diffusion generates data, and the y-axis displays scores for evaluation metrics. The user can check the specific metric value for each step by hovering on the curve. Also, the step preview will update as the cursor moves on the curve. The interactive feature of *Metric View* allows users to not only see aggregate metric performance but also delve into the variation trend of metrics with diffusion step during the diffusion generation process.

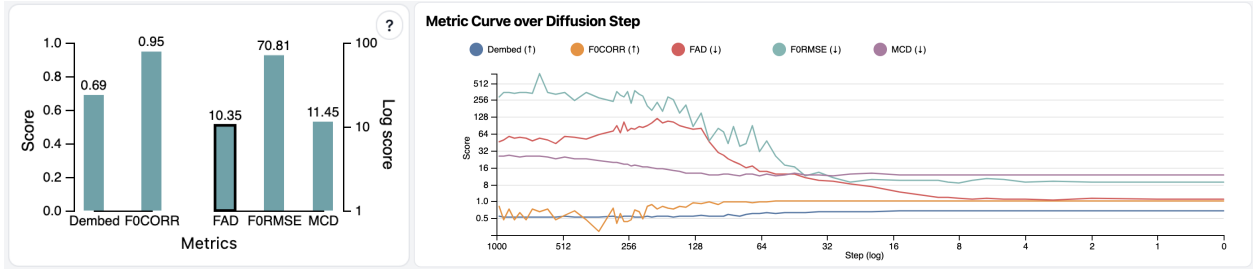

Fig. 7: The left part is the *Metric View* with FAD metric selected. The right part is the corresponding “Metric Curve over Diffusion Step” for the best-performing sample on the FAD metric.

6. Evaluation

This section details the evaluation approach for the SingVisio, aimed at understanding its effectiveness in demonstrating the processes of the diffusion model. The evaluation is carried out through a structured user study, designed to assess both objective understanding and subjective experiences of the users. Given the novel nature of SingVisio, it stands as a unique tool in the field of audio generation, thus a direct comparison with existing systems is not feasible. As such, the focus of the evaluation is on the system’s standalone capabilities in usability, facilitating analysis and affecting users’ perception of the singing voice conversion process.

6.1. User Study Set-up

The user study of SingVisio was designed to gather insights into how effectively the system aids users in visualizing and analyzing the complex process and outcomes of the diffusion model for SVC.

Participants A diverse group of individuals participated in the study. We recruited 20 participants (P1-P20), including students and professionals with backgrounds in machine learning, signal or music processing, and related fields. Their ages ranged from 20 to 35 years, with varied levels of experience in machine learning and music and singing processing, ranging from less than one year to more than three years. This mix of participants ensured a broad perspective on the system’s performance across different user groups.

Questionnaire The questionnaire was designed to capture both objective and subjective aspects of the SingVisio. It comprised 36 questions, among which 17 were objective, as listed in Table A.1 in Appendix A; 14 were subjective, shown in Fig. 9.

- Objective Questions (O1-O17) evaluate the participants’ understanding of SingVisio’s functions and the insights they can derive about the process of diffusion model from its use. These questions are directly related to the five analytical tasks (T1-T5) previously detailed in Section 4.2, assessing the participants’ grasp of the system’s analytical capabilities.
- Subjective Questions (S1-S14) focus on gathering participants’ overall impressions and evaluations of SingVisio. It is structured around four key aspects: explainability, analysis functionality, design effectiveness, and usability.

These aspects were selected based on the recommendations by Rossi *et al.* [57], ensuring a comprehensive evaluation framework that aligns with established user experience principles. The responses are recorded using a 5-point Likert scale, ranging from 1 (strongly disagree) to 5 (strongly agree).

Procedure The user study was structured into several sessions. Participants were first oriented with a comprehensive tutorial about SingVisio, ensuring they were familiar with its functions and capabilities. They were then asked to engage with the system to try out its key features during the hands-on session. Following this, participants completed the formal assessment in the form of an online questionnaire, which included both objective and subjective queries. Finally, an optional feedback section was provided for any additional comments or suggestions.

6.2. Results and Analysis

The completion time for the questionnaire averaged 1 hour 44 minutes ($\mu = 6227.36$, $\sigma = 6521.96$). The objective evaluation showed an average accuracy of 85.88% ($\sigma = 0.35$), while the subjective evaluation averaged 4.44 out of 5 ($\sigma = 0.79$). Fig. 8 and 9 provide a detailed summary of the objective and subjective evaluation results, respectively.

6.2.1. Objective Evaluation

The analysis of users’ objective responses informs the discussion of analytical tasks in Section 4.2. Overall, the average accuracy is high (85.88%). Among the five analytical tasks, **T1 recorded the highest accuracy at 91.25% on average**, with T3 following at 90.00%. In contrast, T5 gains the lowest accuracy at 78.33% on average.

Step-wise Diffusion Generation Comparison (T1). We designed four questions (O1-O4) related to the diffusion generation process in SVC. These questions involve (1) the transition of Mel spectrograms from noisy to clear, (2) the F0 curve transitions from blurred to clear, and (3) the improvement in the quality of generated audio from unintelligibility to intelligibility, enabling users to understand and perceive the audio generation process in the diffusion model. From the objective results shown in Fig. 8, we can see that the accuracy ranking for these four questions is: O4, O3, O1/O2. O4 received the

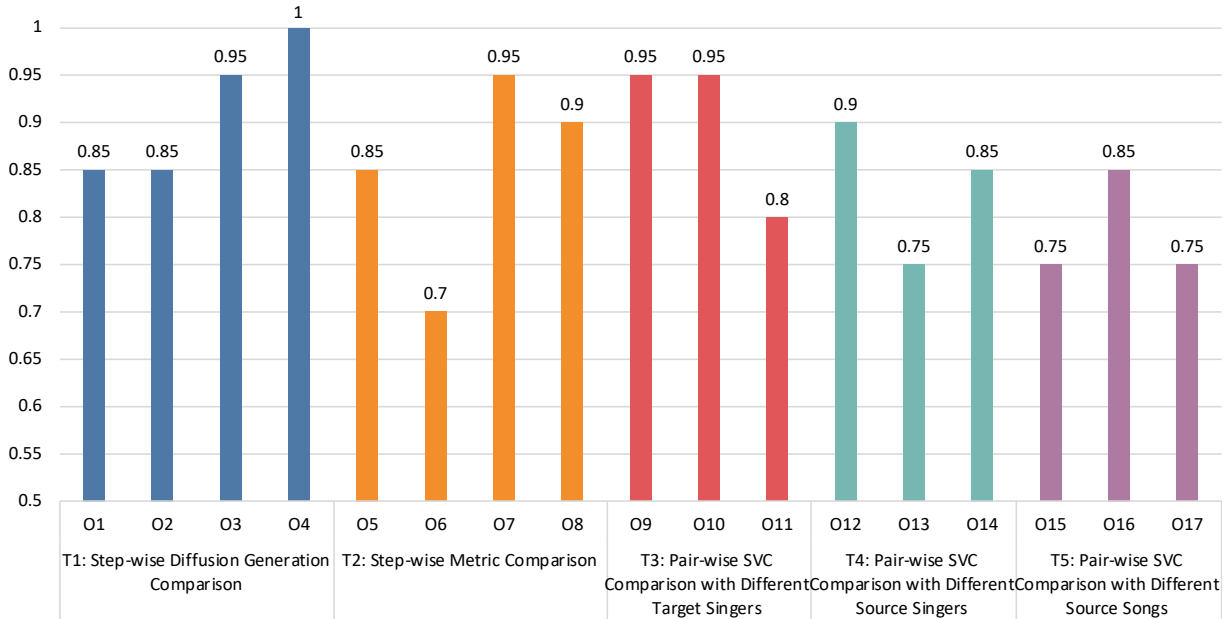

Fig. 8: The results of objective evaluation. The histogram shows the accuracy of each question.

highest score ($\mu = 100.00\%$, $\sigma = 0$), indicating that our system effectively facilitates user understanding of the quality of the converted singing voice. **It’s worth noting that the result of Q4 can be obtained through both visual observations of the Mel spectrogram and auditory perception of the audio, highlighting the characteristic of our system that combines both visual and auditory elements.** The high accuracy of O3 ($\mu = 95.00\%$, $\sigma = 0.22$) indicates that our system allows users to clearly observe the F0 range of the audio. The scores for O1/O2 ($\mu = 85.00\%$, $\sigma = 0.36$) demonstrate the effectiveness of our system for the understanding and analysis of the diffusion generation process at each step.

Step-wise Metric Comparison (T2). For task T2, we designed four questions encompassing: (1) understanding the model evaluation metrics themselves (O6), (2) the relationship between evaluation metrics and model performance (O5), (3) the trend of metric changes during the diffusion conversion process (O7), and (4) the iterative generation paradigm of the diffusion model implied by this trend (O8). The accuracy ranking for these questions is O7, O8, O5, O6. The highest score for O7 ($\mu = 95.00\%$, $\sigma = 0.22$) indicates that our system obviously demonstrates the relationship between evaluation metrics and model performance, which also forms the foundation for understanding T2, underpinning the validity and reliability of the outcomes for other questions in T2. O8, with the second-highest score, shows that our system effectively allows users to understand the relationship between changes in evaluation metrics and the underlying diffusion model generation paradigm, validating our system design for visualizing the diffusion generation mechanism.

O6, a relatively simpler concept about the model evaluation metrics themselves, scored the lowest. Users reported unfamiliarity with the metric, although we provided a help button in the top right corner of the metric view, displaying a metric tips

dialog box with definitions, calculation methods, and relationships to model performance. We analyzed two reasons for O6’s low score: users might not have thoroughly reviewed the system introduction before the user study, which detailed system operation guides; alternatively, the help button might not have been sufficiently prominent, leading to users overlooking or being unaware of it. To address this, we further improved the system by setting the button to a question mark shape, making the help button more prominent and user-friendly.

Pair-wise SVC Comparison with Different Target Singers (T3). Regarding this task, three questions were designed, encompassing: (1) the influence of the target singer on the outcome of the SVC, where differences in timbre among various target singers are the main focus. To aid user understanding, the system provides audio references from different target singers for evaluative listening, with O9 addressing the discernibility of timbre differences; (2) Additionally, since F0 and timbre are correlated, the system presents the corresponding F0 contour to help users better grasp the distinctiveness of target singers, and in O10, we assess whether the system enables users to compare the F0 range differences in the reference audio of different target singers; (3) Finally, O11 deals with the comparison of SVC results under different target singers during the diffusion generation process, touching both on the understanding of the SVC task and the diffusion model.

The accuracy ranking for these questions is O9/O10, O11. O9 and O10 both achieved a 95.00% accuracy rate, indicating the system’s effectiveness in comparing the differences between various target singers; O11 had an 80.00% accuracy rate, which is comparatively lower. We believe this issue is related to the user’s academic and professional background. The question involves the technical term “harmonic”, defined as horizontal bright lines in the Mel spectrogram. For users with a purely musical background (P11), it’s challenging to distinguish the

differences in terms of spectrum.

Pair-wise SVC Comparison with Different Source Singers

(T4). T4 aims to analyze and understand SVC under different source conditions. For T4, three questions were designed: (1) the timbre differences between two different sources (O12); (2) The differences of the motion trajectories of diffusion steps with two different source melody conditions (O13); (3) The patterns in timbre and fundamental frequency range of the final conversion results (at diffusion step 0) when converting two different sources to the same target singer (O14).

The accuracy ranking for these questions is O12, O14, O13. O12 scored the highest ($\mu = 90.00\%$, $\sigma = 0.30$), indicating that the system effectively displays the timbre differences between different sources. O14 scored the second-highest ($\mu = 85.00\%$, $\sigma = 0.36$), showing the system’s effectiveness in demonstrating conversions of two different sources to the same target. O13 scored the lowest ($\mu = 75.00\%$, $\sigma = 0.43$), with most incorrect answers concentrated on option 2, i.e., “It is unclear what the motion trajectories look like.” Upon revisiting participant P20, who chose this incorrect option, and after further discussion, it was revealed that there was a misunderstanding regarding option 2 of O13. When asked again, they provided the correct answer. Overall, the results reflect that users can understand the differences in SVC under various source conditions through our system, affirming its effectiveness for completing T4.

Pair-wise SVC Comparison with Different Source Songs

(T5). In cases where the singing voices of the same singer performing different songs are used as two distinct sources, when converted to the same target, the timbre in the converted results is the same, but the content of the songs is different. T5 aims to analyze this scenario in SVC. To this end, three questions were designed: (1) verify if the system can demonstrate that singing voices of the same singer with different songs have different contents (O15); (2) and (3) assess if the system can aid users in understanding the specific details in terms of the timbre (O16) and content (O17) in the conversion results, when converting two sources with different content from the same singer to the same target.

The accuracy ranking for these questions is O16, O15/O17. O16 has the highest accuracy ($\mu = 85.00\%$, $\sigma = 0.36$), indicating the system effectively displays the detailed information for the SVC, such as the delivering of timbre in conversion results. However, the accuracy in content (O17) is relatively lower. The most incorrect choices in O17 were for option 1 “The singing content in Target (Singer 13)”. Participant P11, a music student, unfamiliar with the task of the SVC, understandably chose incorrectly. However, P16 and P17, doctoral students in the field of audio generation, were revisited and it was found they had not read the question carefully, overlooking that it asked about two conversion results, not just one, and that there is a corresponding relationship between the two results and the options provided. After understanding the question clearly, they made the correct choice. The accuracy for O15 and O17 is the same ($\mu = 75.00\%$, $\sigma = 0.43$). We believe the users who chose incorrectly in O15 did not take the task seriously, as a comparative listening of the singing voice audios presented by the system would reveal whether the contents in the audio are consistent or

not.

6.2.2. Subjective Evaluation

We conduct subjective evaluations of four aspects, including explainability, functionality, effectiveness, and usability. Overall, the assessment results yield an average score of 4.44 ($\sigma = 0.79$). Notably, **it achieved the highest score in analysis functionality** ($\mu = 4.65$, $\sigma = 0.53$) **and also performed well in explainability** ($\mu = 4.46$, $\sigma = 0.77$). Detailed results for each dimension and question are presented in Fig. 9.

Explainability The primary goal in designing SingVisio is to use visual analysis techniques to demystify the black-box nature of complex neural network-based models and enhance the interpretability of diffusion models, in the context of singing voice conversion tasks. As shown in Fig. 9, the subjective assessment results across four dimensions indicate that explainability scored the second highest, demonstrating the effectiveness of SingVisio in interpreting diffusion models and singing voice conversion.

To validate explainability of SingVisio, we designed four questions: (1) Whether the system facilitates to compare diffusion results at different steps, which is the foundation for the other three questions (S1); (2) Whether the metrics curves aid in understanding changes during the diffusion generation process (S2); (3) Whether comparing converted results under two different source conditions helps in deep understanding the singing voice conversion task (S3); (4) Whether the system is helpful in understanding the working mechanism of the iterative generation process of the diffusion model (S4).

Among these questions, S3 scored the highest ($\mu = 4.65$, $\sigma = 0.47$), indicating the system’s effectiveness in aiding users to understand and explain SVC under different conditions. S1, S2, and S4 received identical high scores ($\mu = 4.65$), further confirming that our system provides a comprehensive understanding and explanation for the diffusion model in the context of the SVC task.

A user specializing in speech enhancement research mentioned that SingVisio is particularly helpful for beginners, “From a beginner’s perspective, SingVisio greatly aids in understanding the diffusion model process. The automatically playing Mel spectrogram changing from noisy to clean with diffusion step evolution, vividly demonstrates the diffusion generation process. Moreover, the system clarifies the relationship between evaluation metrics and model performance, enabling the understanding of how different metrics impact different facets of the synthesized voice. Comparing singing voice conversions across different source singers, target signers, and songs further validates which metrics relate to content and which to timbre or gender. For a beginner, this system has been immensely educational about singing voice conversion.”

Analysis Functionality The test results reveal that in the subjective assessment across four dimensions, the score in the analysis functionality dimension is the highest ($\mu = 4.65$, $\sigma = 0.53$). This dimension’s subjective evaluation is designed to verify the system’s support for analysis across tasks T1-T5 and includes four specific questions: (1) Whether the system supports interactive selection and comparison of results at different diffusion

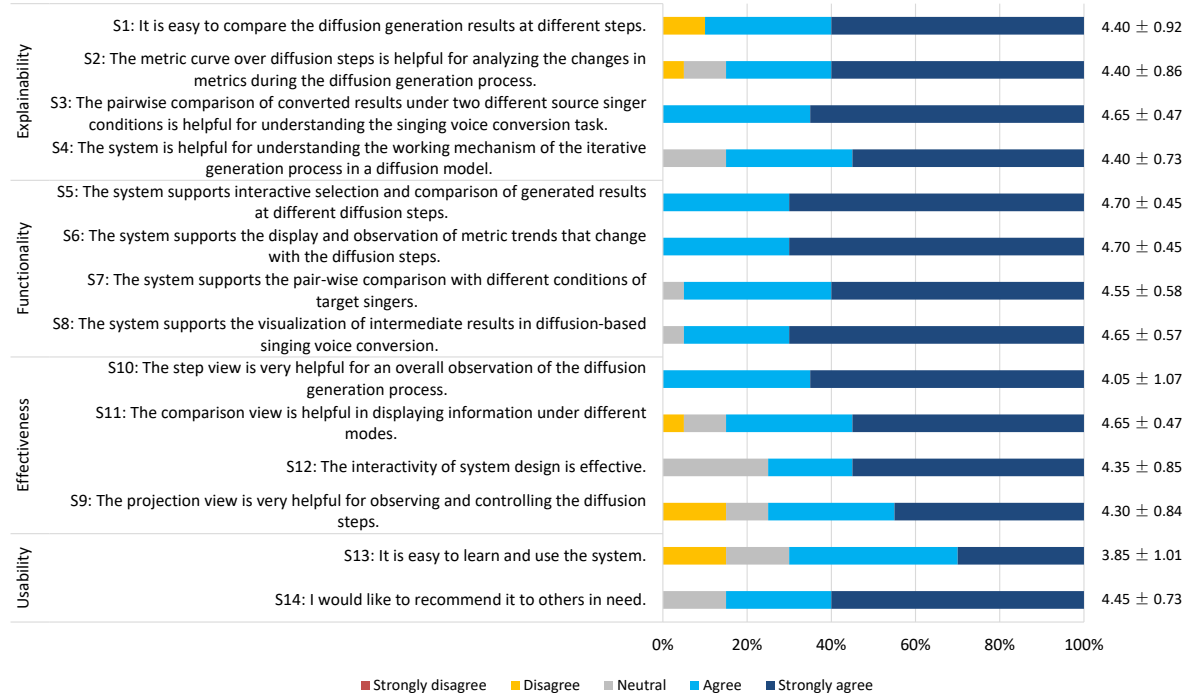

Fig. 9: Description and results of subjective questionnaires. The leftmost column lists four assessment aspects. The rightmost column shows mean \pm standard deviation.

steps (S5); (2) Whether the system displays metrics curves that change with diffusion steps (S6); (3) Whether the system supports comparison of converting the same source to two different target singers (S7); (4) Whether the system supports visualization of intermediate results in the diffusion model (S8).

Among these questions, S5 and S6 scored the highest ($\mu = 4.70$, $\sigma = 0.45$), with all users agreeing or strongly agreeing that SingVisio supports the comparison of generated results at different diffusion steps (T1) and the analysis of evaluation metrics (T2). S7, designed for the analysis tasks T3-T5, received agree and strongly agree from all but one neutral user, indicating that SingVisio effectively supports analysis for T3-T5.

Visual Design Effectiveness To validate the effectiveness of our system design, we formulate four questions, encompassing: (1) Whether the **Projection View** effectively aids in observing the dynamic motion trajectory of diffusion steps and in controlling them (S9); (2) The effectiveness of the **Step View** in understanding the entire diffusion generation process (S10); (3) Whether the **Comparison View** effectively displays useful information across five modes (S11); (4) An overarching question: the effectiveness of the interactive design of the SingVisio (S12).

All four questions scored above 4 points, indicating that all users agree or strongly agree that our views' design and the system's interactive design are effective. S10 received the highest score ($\mu = 4.65$, $\sigma = 0.47$), and S11 gained the second highest ($\mu = 4.35$, $\sigma = 0.85$), demonstrating that **Step View** and **Comparison View**, designed specifically for T1-T5, are effective.

Usability Participants in the user study included those with

over three years of experience in machine learning and signal processing, some new to these fields, and others with a purely musical background. More than two-thirds of these users strongly believed in the user-friendly user interface and ease of learning of SingVisio (S13). Over half of the users strongly recommended SingVisio to others who could benefit from its use (S14). This demonstrates that our system is user-friendly for diverse users, regardless of their background. *Particularly noteworthy is the feedback from a student specializing in signal processing, who found the visualization of SingVisio in audio generation extremely interesting and innovative. SingVisio helped him to understand audio generation from a new perspective, and he is highly motivated to recommend this system to his research group.*

7. Case Study

We invited two beginners in machine learning and signal processing, E1 and E2, to participate in a case study to verify whether the system could make the model interpretable and help beginner users understand the working mechanism of the diffusion model applied in SVC tasks.

E1 showed great interest in understanding the principles and mechanisms of diffusion models, as well as how to use diffusion models for singing voice conversion. Upon opening the SingVisio system, **Step View** at the top displays an animation showing the Mel spectrogram transitioning from pure noise to clarity, alongside audio that became progressively intelligible. *E1 commented that this dynamic display intuitively demonstrated the*

entire process of singing voice conversion, making the generation process more interpretable and comprehensible. Moreover, E1 mentioned that listening to the voice transition from one blurred timbre to another clear timbre was quite fascinating.

The overall evaluation from E2 was very positive. E2 described the system as a comprehensive and user-friendly visualization tool for diffusion models in SVC tasks that allows for both an overview and a detailed study. E2 praised the system’s interactivity, particularly enjoying the ability to see the changes in the Mel spectrogram at different steps by moving the mouse, clearly showcasing the entire diffusion process. Furthermore, E2 liked the metric comparison feature, stating that *I used to know only that higher metrics are better, lower metrics are worse, and what they specifically represent. But this is the first time I’ve directly observed the fluctuations of different metrics throughout the diffusion process, from the starting point to the gradually stabilizing endpoint, and I could also hear the sounds corresponding to different steps.*

8. Expert Study

We invite two domain experts (E3 and E4) to participate in an expert study to evaluate the system based on its usability and effectiveness. They were not involved in the system design process, nor did they participate in the user study and case study. E3 is a researcher who has been engaged in machine learning and voice conversion research for more than 3 years. E4 is also a researcher primarily focusing on singing voice conversion and is strongly interested in XAI.

8.1. Procedure

We carried out an expert study, engaging with each expert individually in semi-structured interviews that spanned 60 minutes. Initially, we presented our research’s goal, the architecture of diffusion-based SVC, and our visualization tool, i.e., SingVisio. Subsequently, we encouraged the experts to examine and assess the system’s features. We then gathered their opinions on the system’s general usability and user interactions. Our findings and the feedback from the experts are summarized below.

8.2. System Usefulness

Both experts acknowledged SingVisio as a valuable tool for validating domain knowledge. They observed that the system clearly demonstrates each step’s results during the data generation process in the diffusion model; E3 said that it vividly displays the denoising process of the diffusion model, showing the Mel spectrogram gradually becoming clearer, and the converted audio progressively moving from unintelligible to intelligible.

E3 also stated, “The system facilitates the comparison of results among different source speakers, target speakers, and songs, generating and displaying corresponding conversion results for straightforward comparison.” E3 also suggested incorporating a tooltip feature in the metric view, which would display descriptions of each metric when the mouse hovers over them, ensuring users clearly understand the metrics. However, there is already a help button in the top right corner of the metric

view. Clicking this button opens a dialog box with metric tips, explaining the meanings of the metrics and their relationship to model performance. Upon being informed of this existing feature, E3 agreed that this design choice was satisfactory.

8.3. Visual Designs and Interactions

E3 and E4 both agree that the system exhibits excellent interactivity. In **Control Panel**, they could select different source singers, songs, and target singers. **Comparison View** allowed them to easily compare the differences among various source singers, songs, and target singers. Furthermore, **Step View** clearly displays the generated results under different conditions. Overall, the system conveniently facilitated their exploration and comparison. E3 stated, “This feature enables users to intuitively assess the differences in conversion performance between different speakers and songs, empowering them to make informed decisions based on their specific needs.”

8.4. Insight and Inspiration

Both domain experts believe the system provides them with valuable insights. E3 mentioned that SingVisio aids in understanding the working principles of the diffusion model for SVC deeply. E4 highlighted that *for practitioners in the voice conversion field, especially in singing voice conversion, by exploring comparisons of source songs, source singers, and target singers, we can observe that the diffusion model’s learning capability varies across different samples. For instance, it performs poorly with samples having very low F0. This insight significantly informs us about which samples are challenging for the model and which are easier.*

Additionally, E4 noted that *the metric comparison perspective reveals the limitations of existing objective metrics used in voice conversion. For example, in a 1000-step diffusion model, almost all metric curves approach convergence within about the last 30 steps, showing no significant improvement beyond that point. However, from the step comparison perspective, we can see (and hear) a substantial difference in sound quality between the generated results at step 30 and step 0, indicating areas for further enhancement.*

9. Conclusion

In this work, we introduce SingVisio, a visual analysis system designed to interactively explain the diffusion model for singing voice conversion. Specifically, SingVisio visually exhibits the stepwise generation process of diffusion models, illustrating the gradual denoising of the noisy spectrum, ultimately resulting in a clean spectrum that captures the target singer’s timbre. The system also supports pairwise comparisons between different conditions, such as content and melody in source audio, and timbre from the target audio, revealing the impact of these conditions on the diffusion generation process and converted results. Through comprehensive evaluations, SingVisio demonstrates its effectiveness in terms of system design, functionalities, explainability, and usability. It provides diverse users with fresh learning experiences and valuable insights into the diffusion model for singing voice conversion.

References

- [1] Yang, L, Zhang, Z, Song, Y, Hong, S, Xu, R, Zhao, Y, et al. Diffusion models: A comprehensive survey of methods and applications. *ACM Computing Surveys* 2023;56(4):1–39.
- [2] Zhang, C, Zhang, C, Zhang, M, Kweon, IS. Text-to-image diffusion model in generative AI: A survey. *arXiv preprint arXiv:230307909* 2023;.
- [3] Xing, Z, Feng, Q, Chen, H, Dai, Q, Hu, H, Xu, H, et al. A survey on video diffusion models. *arXiv preprint arXiv:231010647* 2023;.
- [4] Xu, X, Wang, Z, Zhang, G, Wang, K, Shi, H. Versatile diffusion: Text, images and variations all in one diffusion model. In: *IEEE/CVF International Conference on Computer Vision*. 2023, p. 7754–7765.
- [5] Rombach, R, Blattmann, A, Lorenz, D, Esser, P, Ommer, B. High-resolution image synthesis with latent diffusion models. In: *Proceedings of the IEEE/CVF conference on computer vision and pattern recognition*. 2022, p. 10684–10695.
- [6] Ceylan, D, Huang, CHP, Mitra, NJ. Pix2video: Video editing using image diffusion. In: *IEEE/CVF International Conference on Computer Vision*. 2023, p. 23206–23217.
- [7] Chen, B, Sainath, TN, Pang, RJ, Vaswani, A, Shazeer, N, Parmar, N. WaveGrad: Estimating gradients for generative audio modeling. In: *International Conference on Learning Representations*. 2021;.
- [8] Kong, Z, Ping, W, Huang, J, Zhao, K, Catanzaro, B. DiffWave: A versatile diffusion model for audio synthesis. In: *International Conference on Learning Representations*. 2020;.
- [9] Liu, H, Chen, Z, Yuan, Y, Mei, X, Liu, X, Mandic, D, et al. AudioLDM: Text-to-audio generation with latent diffusion models. *arXiv preprint arXiv:230112503* 2023;.
- [10] Huang, J, Ren, Y, Huang, R, Yang, D, Ye, Z, Zhang, C, et al. Make-An-Audio 2: Temporal-enhanced text-to-audio generation. *arXiv preprint arXiv:230518474* 2023;.
- [11] Popov, V, Vovk, I, Gogoryan, V, Sadekova, T, Kudinov, M. GradTTS: A diffusion probabilistic model for text-to-speech. In: *International Conference on Machine Learning*. 2021, p. 8599–8608.
- [12] Shen, K, Ju, Z, Tan, X, Liu, Y, Leng, Y, He, L, et al. NaturalSpeech 2: Latent diffusion models are natural and zero-shot speech and singing synthesizers. In: *International Conference on Learning Representations*. 2024;.
- [13] Liu, J, Li, C, Ren, Y, Chen, F, Zhao, Z. DiffSinger: Singing voice synthesis via shallow diffusion mechanism. In: *AAAI Conference on Artificial Intelligence*. 2022, p. 11020–11028.
- [14] Schneider, F, Kamal, O, Jin, Z, Schölkopf, B. Moûsai: Text-to-music generation with long-context latent diffusion. *arXiv preprint arXiv:230111757* 2023;.
- [15] Liu, S, Cao, Y, Su, D, Meng, H. DiffSVC: A diffusion probabilistic model for singing voice conversion. In: *Automatic Speech Recognition and Understanding Workshop*. IEEE; 2021, p. 741–748.
- [16] Zhang, X, Gu, Y, Chen, H, Fang, Z, Zou, L, Xue, L, et al. Leveraging content-based features from multiple acoustic models for singing voice conversion. *Machine Learning for Audio Workshop, Neural Information Processing Systems* 2023;.
- [17] Lu, Y, Ye, Z, Xue, W, Tan, X, Liu, Q, Guo, Y. Comosvc: Consistency model-based singing voice conversion. *arXiv preprint arXiv:240101792* 2024;.
- [18] Goodfellow, I, Pouget-Abadie, J, Mirza, M, Xu, B, Warde-Farley, D, Ozair, S, et al. Generative adversarial networks. *Communications of the ACM* 2020;63(11):139–144.
- [19] Kingma, DP, Welling, M. Auto-encoding variational bayes. In: Bengio, Y, LeCun, Y, editors. *International Conference on Learning Representations*. 2014;.
- [20] Sergios Karagiannakos, NA. Diffusion models: toward state-of-the-art image generation. <https://theaisummer.com/diffusion-models/>; 2022.
- [21] O’Connor, R. Diffusion models for machine learning: Introduction. <https://www.assemblyai.com/blog/diffusion-models-for-machine-learning-introduction/>; 2024.
- [22] Türk, O, Büyük, O, Haznedaroglu, A, Arslan, LM. Application of voice conversion for cross-language rap singing transformation. In: *International Conference on Acoustics, Speech and Signal Processing*. 2009, p. 3597–3600.
- [23] Kobayashi, K, Toda, T, Neubig, G, Sakti, S, Nakamura, S. Statistical singing voice conversion with direct waveform modification based on the spectrum differential. In: *International Speech Communication Association*. 2014, p. 2514–2518.
- [24] Kobayashi, K, Toda, T, Neubig, G, Sakti, S, Nakamura, S. Statistical singing voice conversion based on direct waveform modification with global variance. In: *International Speech Communication Association*. 2015, p. 2754–2758.
- [25] Nachmani, E, Wolf, L. Unsupervised singing voice conversion. In: *International Speech Communication Association*. 2019, p. 2583–2587.
- [26] Chen, X, Chu, W, Guo, J, Xu, N. Singing voice conversion with non-parallel data. In: *Multimedia Information Processing and Retrieval*. 2019, p. 292–296.
- [27] Huang, WC, Yang, SW, Hayashi, T, Toda, T. A comparative study of self-supervised speech representation based voice conversion. *IEEE Journal of Selected Topics in Signal Processing* 2022;16(6):1308–1318.
- [28] Liu, S, Cao, Y, Hu, N, Su, D, Meng, H. FastSVC: Fast cross-domain singing voice conversion with feature-wise linear modulation. In: *International Conference on Multimedia and Expo*. 2021, p. 1–6.
- [29] Takahashi, N, Singh, MK, Mitsufoji, Y. Robust one-shot singing voice conversion. *arXiv 2022;abs/2210.11096*.
- [30] Luo, Y, Hsu, C, Agres, K, Herremans, D. Singing voice conversion with disentangled representations of singer and vocal technique using variational autoencoders. In: *International Conference on Acoustics, Speech and Signal Processing*. 2020, p. 3277–3281.
- [31] SVC-Develop-Team, . SoftSVC VITS Singing Voice Conversion. <https://github.com/svc-develop-team/so-vits-svc>; 2023.
- [32] Popov, V, Vovk, I, Gogoryan, V, Sadekova, T, Kudinov, MS, Wei, J. Diffusion-based voice conversion with fast maximum likelihood sampling scheme. In: *International Conference on Learning Representations*. 2022;.
- [33] Choi, H, Lee, S, Lee, S. Diff-HierVC: Diffusion-based hierarchical voice conversion with robust pitch generation and masked prior for zero-shot speaker adaptation. In: *International Speech Communication Association*. 2023, p. 2283–2287.
- [34] Wang, Y, Ju, Z, Tan, X, He, L, Wu, Z, Bian, J, et al. AUDIT: audio editing by following instructions with latent diffusion models. In: *Neural Information Processing Systems*. 2022;.
- [35] Arrieta, AB, Díaz-Rodríguez, N, Del Ser, J, Bennetot, A, Tabik, S, Barbado, A, et al. Explainable artificial intelligence (XAI): Concepts, taxonomies, opportunities and challenges toward responsible AI. *Information Fusion* 2020;58:82–115.
- [36] Hohman, F, Kahng, M, Pienta, R, Chau, DH. Visual analytics in deep learning: An interrogative survey for the next frontiers. *IEEE Transactions on Visualization and Computer Graphics* 2018;25(8):2674–2693.
- [37] Wang, ZJ, Turko, R, Shaikh, O, Park, H, Das, N, Hohman, F, et al. CNN Explainer: learning convolutional neural networks with interactive visualization. *IEEE Transactions on Visualization and Computer Graphics* 2020;27(2):1396–1406.
- [38] Strobel, H, Gehrmann, S, Pfister, H, Rush, AM. LSTMVis: A tool for visual analysis of hidden state dynamics in recurrent neural networks. *IEEE Transactions on Visualization and Computer Graphics* 2017;24(1):667–676.
- [39] Wang, J, Gou, L, Shen, HW, Yang, H. DQNViz: A visual analytics approach to understand deep q-networks. *IEEE Transactions on Visualization and Computer Graphics* 2018;25(1):288–298.
- [40] Wang, X, He, J, Jin, Z, Yang, M, Wang, Y, Qu, H. M2Lens: Visualizing and explaining multimodal models for sentiment analysis. *IEEE Transactions on Visualization and Computer Graphics* 2021;28(1):802–812.
- [41] Liu, M, Shi, J, Li, Z, Li, C, Zhu, J, Liu, S. Towards better analysis of deep convolutional neural networks. *IEEE Transactions on Visualization and Computer Graphics* 2016;23(1):91–100.
- [42] Yeh, C, Chen, Y, Wu, A, Chen, C, Viégas, F, Wattenberg, M. AttentionViz: A global view of transformer attention. *arXiv preprint arXiv:230503210* 2023;.
- [43] Norton, AP, Qi, Y. Adversarial-playground: A visualization suite showing how adversarial examples fool deep learning. In: *IEEE Symposium on Visualization for Cyber Security*. 2017, p. 1–4.
- [44] Kahng, M, Thorat, N, Chau, DH, Viégas, FB, Wattenberg, M. GAN Lab: Understanding complex deep generative models using interactive visual experimentation. *IEEE Transactions on Visualization and Computer Graphics* 2018;25(1):310–320.
- [45] Wang, J, Gou, L, Yang, H, Shen, HW. GANViz: A visual analyt-

- ics approach to understand the adversarial game. *IEEE Transactions on Visualization and Computer Graphics* 2018;24(6):1905–1917.
- [46] Wang, Q, Huang, K, Chandak, P, Zitnik, M, Gehlenborg, N. Extending the nested model for user-centric xai: A design study on gnn-based drug repurposing. *IEEE Transactions on Visualization and Computer Graphics* 2022;29(1):1266–1276.
- [47] Park, JH, Ju, YJ, Lee, SW. Explaining generative diffusion models via visual analysis for interpretable decision-making process. *Expert Systems with Applications* 2024;:123231.
- [48] Lee, S, Hoover, B, Strobel, H, Wang, ZJ, Peng, S, Wright, A, et al. Diffusion explainer: Visual explanation for text-to-image stable diffusion. *arXiv preprint arXiv:230503509* 2023;.
- [49] Huang, WC, Violeta, LP, Liu, S, Shi, J, Yasuda, Y, Toda, T. The singing voice conversion challenge 2023. In: *Automatic Speech Recognition and Understanding Workshop*. 2023, p. 1–8.
- [50] Zhang, X, Xue, L, Wang, Y, Gu, Y, Chen, X, Fang, Z, et al. Amphion: An open-source audio, music and speech generation toolkit. *arXiv* 2023;abs/2312.09911.
- [51] van den Oord, A, Dieleman, S, Zen, H, Simonyan, K, Vinyals, O, Graves, A, et al. WaveNet: A generative model for raw audio. In: *Speech Synthesis Workshop*. ISCA; 2016, p. 125.
- [52] Ho, J, Jain, A, Abbeel, P. Denoising diffusion probabilistic models. *Neural Information Processing Systems* 2020;33:6840–6851.
- [53] Radford, A, Kim, JW, Xu, T, Brockman, G, McLeavey, C, Sutskever, I. Robust speech recognition via large-scale weak supervision. In: *International Conference on Machine Learning*. PMLR; 2023, p. 28492–28518.
- [54] Qian, K, Zhang, Y, Gao, H, Ni, J, Lai, CI, Cox, D, et al. ContentVec: An improved self-supervised speech representation by disentangling speakers. In: *International Conference on Machine Learning*. PMLR; 2022, p. 18003–18017.
- [55] Jadoul, Y, Thompson, B, de Boer, B. Introducing Parselmouth: A Python interface to Praat. *Journal of Phonetics* 2018;71:1–15.
- [56] Sisman, B, Yamagishi, J, King, S, Li, H. An overview of voice conversion and its challenges: From statistical modeling to deep learning. *IEEE/ACM Transactions on Audio, Speech, and Language Processing* 2020;29:132–157.
- [57] Rossi, PH, Lipsey, MW, Freeman, HE. Evaluation: A systematic approach. *Canadian Journal of University Continuing Education* 2010;36(2).
- [58] Wang, Y, Wang, X, Zhu, P, Wu, J, Li, H, Xue, H, et al. Opencpop: A high-quality open source chinese popular song corpus for singing voice synthesis. In: *International Speech Communication Association*. 2022, p. 4242–4246.
- [59] Yamagishi, J, Veaux, C, MacDonald, K, et al. CSTR VCTK Corpus: English multi-speaker corpus for cstr voice cloning toolkit (version 0.92). *University of Edinburgh The Centre for Speech Technology Research* 2019;.
- [60] Huang, R, Chen, F, Ren, Y, Liu, J, Cui, C, Zhao, Z. Multi-Singer: Fast multi-singer singing voice vocoder with A large-scale corpus. In: *ACM International Conference on Multimedia*. ACM; 2021, p. 3945–3954.
- [61] Zhang, L, Li, R, Wang, S, Deng, L, Liu, J, Ren, Y, et al. M4singer: A multi-style, multi-singer and musical score provided mandarin singing corpus. In: *Neural Information Processing Systems*. 2022;.

Appendix A. Objective Questions

Table A.1 provides a comprehensive overview of the objective questions corresponding to five distinct analytical tasks outlined in Section 4.2, labeled from O1 to O17. The first row of the table describes the task, the second row provides background information for answering questions under different tasks, and from the third row to the last, there are detailed descriptions of specific questions for each task.

Appendix B. Dataset

We use five datasets for our diffusion-based SVC model training: Openpop [58], SVCC training data [49], VCTK [59], OpenSinger [60], and M4Singer [61]. In total, these datasets contain 83.1 hours of speech and 87.2 hours of singing data. The mapping between the singer name defined in the dataset and the singer ID displayed in the SingVisio system is listed in Table B.2. The mapping between the song name defined in the dataset and song ID in the SingVisio system is listed in Table C.3.

Table B.2: Mapping of singer name and singer ID

Dataset	Singer Name	Gender	Singer ID
SVCC	SF1	Female	Singer 1
	SM1	Male	Singer 2
	CDF1	Female	Singer 3
	CDM1	Male	Singer 4
	IDF1	Female	Singer 5
	IDM1	Male	Singer 6
M4Singer	Alto-1	Female	Singer 7
	Alto-7	Female	Singer 8
	Bass-1	Male	Singer 9
	Soprano-2	Female	Singer 10
	Tenor-5	Male	Singer 11
	Tenor-6	Male	Singer 12
	Tenor-7	Male	Singer 13
Openpop	Openpop	Female	Singer 14

Appendix C. Metrics Definition

- **Singer Similarity (Dembed)** quantitatively assesses the similarity between the timbre of the original singer’s voice and the converted voice. It’s calculated using the cosine similarity between feature vectors representing the timbre characteristics of the two voices. A higher similarity score indicates more timbre similarity.
- **F0 Pearson Correlation Coefficient (F0CORR)** measures the Pearson Correlation Coefficient between the F0 values of the converted singing voice and the target voice. It assesses the linear relationship between the F0 contours of the two voices. A higher F0CORR indicates a stronger correlation and better F0 similarity.
- **Fréchet Audio Distance (FAD)** is a reference-free evaluation metric to evaluate the quality of audio samples. FAD correlates more closely with human perception. A lower FAD score indicates a higher quality of the audio.

- **F0 Root Mean Square Error (F0RMSE)** measures the Root Mean Square Error of the Fundamental Frequency (F0) values between the converted singing voice and the target voice. It quantifies how accurately the F0 of the converted voice matches that of the target voice. A lower F0RMSE indicates better F0 accuracy.
- **Mel-cepstral Distortion (MCD)** assesses the quality of the generated speech by comparing the discrepancy between generated and ground-truth singing voice. It measures how different the two sequences of mel cepstra are. A lower MCD indicates better quality.

Table C.3: Mapping of song name and song ID.

Dataset	Utterance ID	Song ID	Lyrics
SVCC	30001	Song 1	Hey Jude, don’t make it bad.
	30002	Song 2	Take a sad song and make it better.
	30003	Song 3	Remember to let her into your heart.
	10001	Song 4	Everything is fine.
	10030	Song 5	Were you lying all the time?
	10120	Song 6	Now, I need
	10140	Song 7	Hey, I love you.
	30005	Song 15	You know that its fool who plays it cool.
	30006	Song 16	Na, na, na, na, na, na, na, na, na, na, na, hey, Jude.
	30009	Song 17	When they all should let us be.
	30016	Song 18	Let it be. Let it be. Let it be.
	30022	Song 19	Take my breath away
	30019	Song 20	Watching every motion In my foolish lover’s game
	M4Singer	Alto-1_美错_0014	Song 8
Bass-1_十年_0008		Song 9	陪在一个陌生人左右
Soprano-2_同桌的你_0018		Song 10	谁遇见多愁善感的你
Tenor-5_爱笑的眼睛_0010		Song 11	这爱的城市虽然拥挤
Alto-7_寂寞沙洲冷_0000		Song 12	河畔的风放肆拼命的吹, 无端拨弄离人的眼泪
Tenor-6_寂寞沙洲冷_0002		Song 12	
Alto-7_寂寞沙洲冷_0011		Song 13	当记忆的线缠绕过往支离破碎, 是慌乱占据了心扉
Tenor-7_寂寞沙洲冷_0013		Song 13	
Tenor-6_寂寞沙洲冷_0020		Song 13	
Bass-1_寂寞沙洲冷_0021		Song 14	

Table A.1: Objective questions correspond to five analytical tasks in Section 4.2, denoted as O1 to O17.

Task	T1: Step-wise Diffusion Generation Comparison.	T2: Step-wise Metric Comparison.	T3: Pair-wise SVC Comparison with Different Target Singers.	T4: Pair-wise SVC Comparison with Different Source Singers.	T5: Pair-wise SVC Comparison with Different Songs.
Context	In the Step Comparison mode, answer the following questions (O1-O4).	In the Metric Comparison mode, answer the following questions (O5-O8).	In the Target Singer Comparison mode, answer the following questions (O9-O11).	In the Source Singer Comparison mode, when converting the singing voice of source singers 8 and 12 with song 12 to target singer 13, respectively, please answer the following questions (O12-O14).	In the Song Comparison mode, when converting the timbre of the source singer 12 to target singer 13 under the conditions of song 12 and song 13, answer the following questions (O15-O17).
Objective Questions	O1: How does the audio quality of the converted singing voice evolve throughout the diffusion generation process?	O5: What is the relationship between the F0CORR (F0 Correlation) metric and the model's performance?	O9: Is there a difference in timbre between target singer 8 and target singer 13?	O12: What are the timbre types of source singer 8 and singer 12, respectively?	O15: Are the contents of the two sources (Singer 12 Song 12 and Singer 12 Song 13) consistent with the content of the target (Singer 13)?
	O2: What is the trend in the changes of the F0 curve and Mel spectrogram during the diffusion generation process?	O6: What aspect of audio does the FAD (Fréchet Audio Distance) metric evaluate?	O10: What are the fundamental frequency ranges of target singer 8 and target singer 9, respectively?	O13: From the project embedding of Step + Noise + Condition (Last layer) shown in the projection view, what conclusion can be drawn from the motion trajectories of the steps corresponding to two conversion processes?	O16: For the final two converted results at step 0 (Song 12: Singer 12 -> Singer 13 and Song 13: Singer 12 -> Singer 13), into whose singer identity should they be converted?
	O3: What's the F0 range in the final converted results (Step 0) with the condition of source singer 1, song 1, and target singer 5?	O7: What is the trend of the MCD (Mel-cepstral Distortion) curve with the change of time steps during the diffusion generation process?	O11: With source singer as 12, song as 12, and target speakers as 8 and 9, respectively, at diffusion step 30, which result has clearer harmonics (horizontal bright lines) in the Mel spectrogram?	O14: What are the timbre types and fundamental frequency range of the final generated results at diffusion step 0?	O17: For the final two converted results at step 0 (Song 12: Singer 12 -> Singer 13 and Song 13: Singer 12 -> Singer 13), which singing content do they match?
	O4: At which step does the result of the converted singing voice become intelligible without noise under the system's default display?	O8: What does the changing trend of Dembed (Singer Similarity) during the diffusion generation process indicate?			