DefInt: A Default-interventionist Framework for Efficient Reasoning with Hybrid Large Language Models

Yu Shang^{*1} Yu Li^{*2} Fengli Xu¹ Yong Li¹

Abstract

Large language models (LLMs) have shown impressive emergent abilities in a wide range of tasks, but still face challenges in handling complex reasoning problems. Previous works like chain-of-thought (CoT) and tree-of-thoughts (ToT) have predominately focused on enhancing accuracy, but overlook the rapidly increasing token cost, which could be particularly problematic for open-ended real-world tasks with huge solution spaces. Motivated by the dual process theory of human cognition, we propose a Default-Interventionist framework (DefInt) to unleash the synergistic potential of hybrid LLMs. By default, DefInt uses smaller-scale language models to generate low-cost reasoning thoughts, which resembles the fast intuitions produced by *System 1*. If the intuitions are considered with low confidence, DefInt will invoke the reflective reasoning of scaled-up language models as the intervention of *System 2*, which can override the default thoughts and rectify the reasoning process. Experiments on five representative reasoning tasks show that DefInt consistently achieves state-of-the-art reasoning accuracy and solution diversity. More importantly, it substantially reduces the token cost by 49%~79% compared to the second accurate baselines. Specifically, the open-ended tasks have an average 75% token cost reduction. Code repo with all prompts will be released upon publication.

1. Introduction

Initially conceived for autoregressive text generation, large language models (LLMs), such as GPT (Brown et al., 2020;

^{*}Equal contribution ¹Department of Electronic Engineering, Tsinghua University, Beijing, China ²Harbin Institute of Technology, Shenzhen, China. Correspondence to: Fengli Xu <fenglixu@tsinghua.edu.cn>, Yong Li <liyong07@tsinghua.edu.cn>.

In-working paper.

Radford et al., 2018; 2019) and PaLM (Chowdhery et al., 2023), have been shown to exhibit emergent abilities for wide range of tasks as they scale up (Wei et al., 2022a). A recent landmark study reveals LLMs can unlock their capability of mathematical, commonsense and symbolic reasoning by employing prompts to produce natural language intermediate steps for reasoning. This approach, known as the “Chain of Thought” (CoT) framework (Wei et al., 2022b), adeptly mimics the sequential thought processes of human reasoners. The later “Tree of Thoughts” (ToT) framework (Yao et al., 2023) further allows LLMs to deliberate on multiple reasoning paths and make high-quality global decisions via tree search. Search methods like ToT are believed to resemble the reflective reasoning mode found in human cognition, offering greater accuracy but at the expense of significantly more resources. For example, finding a solution for “Game of 24” with ToT consumes approximately 100 times more tokens compared to CoT (Yao et al., 2023). Specifically, many open-ended real-world problems (Zheng et al., 2023) with considerably larger solution spaces could pose significant challenges to this effortful reasoning framework. Consequently, a critical research problem arises for practical LLM reasoning: Can we strike a more effective balance between reasoning accuracy and efficiency? And if possible, how might we integrate these elements into a novel reasoning framework?

Our study is motivated by human cognition’s ability to efficiently tackle complex problems. The prevalent “dual process” theory suggests (Evans, 2010) there are two distinct systems in human reasoning: *System 1*, capable of rapid, preconscious and intuitive responses; and *System 2*, adept at high-effort, reflective reasoning. Research indicates that everyday decision-making is predominantly governed by *System 1* (Evans, 2010), providing fast responses with minimum resources through the intuition of associative experiences. Although *System 1* makes accurate decisions most of the time, it is also identified as the source of various cognitive biases (Kahneman, 2011), rendering it prone to errors if not properly monitored. On the contrary, *System 2* can avoid intuitive biases through effortful reflection, which is widely encouraged in critical decision-making (Croskerry, 2009). Human cognition has been observed to effectively reconcile these two competing systems (Evans, 2007), un-

leashing their synergistic power to simultaneously enhance both reasoning accuracy and efficiency. However, previous works on LLM reasoning have predominantly focused on boosting the reasoning accuracy with various *System 2*-like deliberation mechanisms (Yao et al., 2023; Wang et al., 2023b; Liang et al., 2023), often neglecting the efficiency advantage of *System 1*. Therefore, exploring the synergistic potential of *System 1* and *System 2* presents a promising direction for achieving both efficient and accurate LLM reasoning.

We draw inspiration from the popular *default-interventionist* model in the realm of dual-process theory (Evans, 2007). It hypothesizes the two competing systems are reconciled by using *System 1* to generate low-effort *default* responses, which may be *intervened* upon with the reflection of high-effort *System 2* if the confidence is low. We thus design a novel *default-interventionist* framework (DefInt) for efficient problem solving with LLMs (see Figure 1). To mimic the fast, low-effort *System 1*, DefInt prompts smaller-scale language models to efficiently generate *default* reasoning steps. Specifically, DefInt employs a variety of language models from diverse sources (e.g., GPT-3.5, PaLM2, and Gemini) to emulate the intuitions derived from different associative experiences (i.e., different pre-training data sets of these language models). The parallel “intuitions” are summarized into one reasoning step with an independent confidence evaluator, which also monitors the overall quality of these default steps. Should it be deemed necessary, DefInt will invoke the *intervention* of scaled-up language models, i.e., GPT-4. This *intervention* resembles the effortful, reflective *System 2* reasoning that has the capability to override the *default* steps and rectify the reasoning process. Besides, DefInt introduces a *gatekeeping* mechanism that passively activates the *intervention* of GPT-4 at intervals of T reasoning steps, with the objective of ensuring the reasoning path remains on course. DefInt is designed to harness the synergistic potential of larger and smaller language models and is expected to deliver human-like efficient and accurate reasoning.

Empirically, we conduct extensive experiments on five complex reasoning tasks, including both close-ended (Game of 24 (Yao et al., 2023), Logic Grid Puzzle (Srivastava et al., 2022)) and open-ended problems (Trivia Creative Writing (Chen et al., 2023a), Open-ended QA (Chen et al., 2023a), Constrained Generation (Madaan et al., 2023)). The results show that DefInt achieves state-of-the-art reasoning accuracy on all five tasks. More importantly, it substantially reduces the token cost by 49%~79% compared to the second accurate baselines. The token cost reduction in open-ended tasks (75% on average) is higher than the close-ended tasks (51% on average). Besides, we find DefInt can also improve the solution diversity across all tasks, which is probably because the *default* module can retrieve and process more

diverse information. Our further analysis investigates the impact of intervention rate on the balance between reasoning accuracy and efficiency, showing a wide feasible range that could lead to a beneficial synergistic effect.

In summary, our main contributions are as follows:

- We propose DefInt, a novel default-interventionist framework that unleashes the synergistic potential of hybrid LLMs for efficient reasoning.
- We conduct extensive experiments on five reasoning tasks. Empirical results demonstrate that DefInt achieves state-of-the-art reasoning accuracy and solution diversity on all tasks. More importantly, DefInt substantially reduces the token cost by 49% ~ 79% compared to the second accurate baselines.
- We further analyze the feasible range of intervention rates in DefInt, providing useful insights for designing cost-effective LLM reasoning models in practice.

2. Background

In this section, we formulate some existing methods of LLM reasoning to clarify their difference with our method. We use p and s to denote the reasoning problem and solution. We denote reasoning with System 1 (intuitive) as $f_I(\cdot)$, and LLMs with System 2 (reflective) process as $f_R(\cdot)$.

Chain-of-thought (CoT) CoT enhances LLM reasoning abilities by instructing the model to conduct step-by-step thinking: $p \rightarrow z_1, \dots, z_t \rightarrow s$, where z_1, \dots, z_t are intermediate thoughts during reasoning. In each reasoning step, thoughts are generated directly by low-effort LLMs without deliberate thinking (System 1-manner), which is formulated as follows:

$$z_n = f_I(p; \{z_m | m < n\}). \quad (1)$$

Tree-of-Thoughts (ToT) ToT uses LLMs to deliberate on multiple reasoning paths and make high-quality global decisions via tree search (System 2-manner). Formally, at the n -th reasoning step, ToT generates N thought candidates:

$$\{z_n^k | k = 1, 2, \dots, N\} = f_R(p; \{z_m | m < n\}). \quad (2)$$

Then it evaluates all candidate thoughts and selects the best one as the final thought z_n at step n .

The above two well-known methods are typical for LLM reasoning with either System 1 or 2, suffering from either low performance or high token cost. Therefore, they are hard to be applied to real complex reasoning problems. As for most existing multi-agent debate methods (Liang et al., 2023; Du et al., 2023; Wang et al., 2023b), they are also limited to reason with various System 2-like deliberation mechanisms, hard to deploy when facing complex reasoning tasks. To address this issue, we propose an adaptive

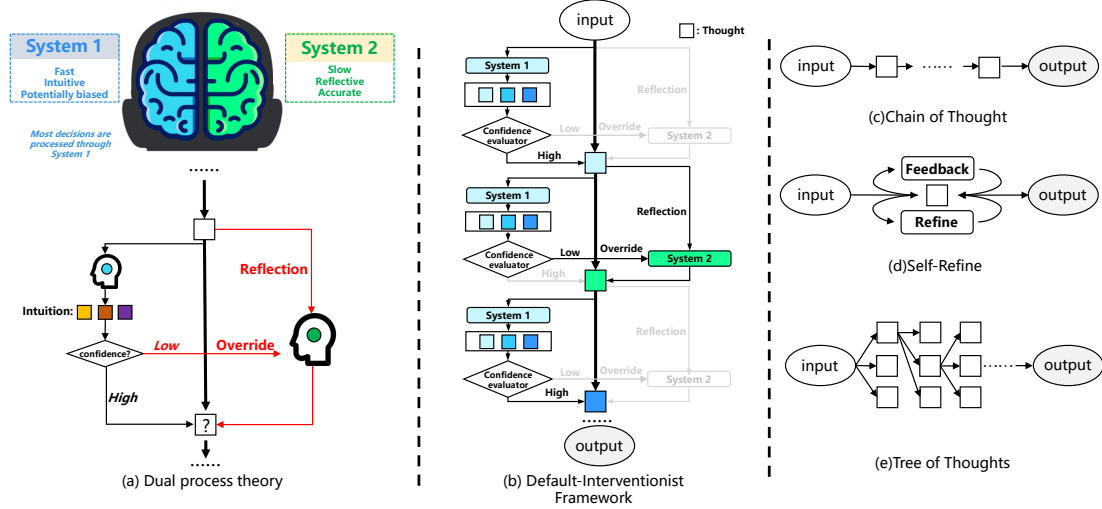

Figure 1. An illustration of dual process theory (a) and the main differences between DefInt (b) and prior works (c) (d) (e). DeInt is designed following the synergy paradigm of dual processes in human reasoning.

collaboration system composed of hybrid LLMs, leveraging the strengths of dual reasoning processes.

3. DefInt: A Default-interventionist Framework for Efficient Reasoning

The evidence suggests that intuition is the dominant basis for real-world decision-making and is often effective; however, it also shows that reliance on intuition can be dangerous and that intervention with high-effort and explicit reasoning is often required, especially when problems have novel features. — Evans et al. (Evans, 2010)

Motivated by the above default-interventionist theory, we introduce DefInt, a framework that adaptively integrates two systems for efficient and accurate LLM reasoning. We now detail the implementations of System 1 and System 2, and how our framework synergizes them for efficient reasoning. The whole framework of DefInt is illustrated in Figure 2.

System 1 System 1 is fast, intuitive, and largely dependent on relevant experiences, which is suitable to realize with smaller-scale language models that have not exhibited emergent reasoning abilities (e.g., GPT-3.5, PaLM2). These models are more likely to generate associative responses based on memorized examples but unpromising to acquire reflective reasoning abilities. Although such models are blamed for the potential biases, they are low-effort and responsive to generate default intuitions. For example, according to the report¹, the cost per token of GPT-3.5 is only one-thirtieth of the cost of GPT-4. Considering the existence of diverse experiential intuitions for humans, here we introduce three

¹<https://openai.com/pricing>

Algorithm 1 Algorithm of System 1

Input: Reasoning problem p , LLMs $f_{I1}(\cdot), f_{I2}(\cdot), f_{I3}(\cdot)$
 $H = \{p\}$ // Initialize interaction history
for $k \in \{1, 2, 3\}$ **do**
 $a_k^{(1)} = f_{Ik}(H)$ // Generate initial thoughts
end
for $j \in \{1, 2, 3\}$ **do**
 for $k \in \{1, 2, 3\} \setminus \{j\}$ **do**
 $s_{j \rightarrow k}^{(2)} = f_{Ij}(a_k^{(1)})$ // Multiple-intuition interactions
 end
end
for $k \in \{1, 2, 3\}$ **do**
 $a_k^{(3)} = f_{Ik}(\sum_{j \in \{1, 2, 3\} \setminus \{k\}} s_{j \rightarrow k}^{(2)})$ // Update intuitions
end
 $H = \{a_1^{(3)}, a_2^{(3)}, a_3^{(3)}\}$
return H

distinct smaller-scale LLMs to generate diverse intuitions, denoted as $f_{I1}(\cdot), f_{I2}(\cdot), f_{I3}(\cdot)$, respectively.

Given the reasoning problem p , the three LLMs first propose an initial thought respectively, then we reconcile the competition of diverse intuitive thoughts via interactions to further refine the diverse intuitions. The whole process of achieving System 1 is shown in Algorithm 1.

System 2 System 2 is slow, reflective, and high-effort, which is expected to produce high-quality reasoning. When it comes to reasoning with LLMs, System 2 can be achieved with scaled-up language models (e.g., GPT-4) that have shown emergent inherent reasoning abilities. These models

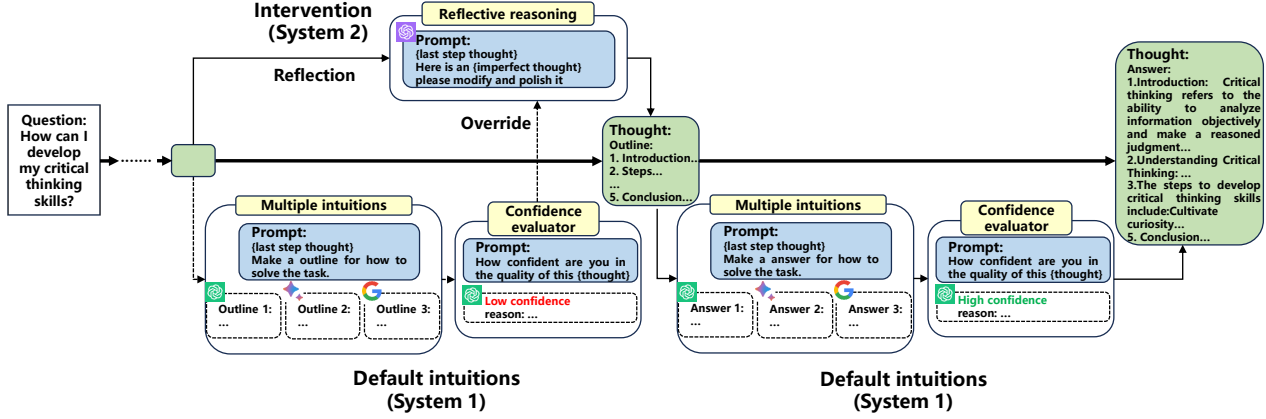

Figure 2. Overview of DefInt. DefInt prioritizes reasoning with default intuitions (System 1). When the confidence of intuitions is low, DefInt will intervene with reflective reasoning (System 2) to override them. Besides, DefInt periodically invokes reflective reasoning as gatekeeping of reasoning quality.

are less dependent on relevant experiences (*i.e.*, few exemplars in prompts) when dealing with novel and complex problems. However, the only shortcoming is the high token cost, thus limiting large-scale applications. Here we adopt a single GPT-4 as a proxy of System 2, denoted as $f_R(\cdot)$. Given the reasoning problem p , the generated solution s based on System 2 is formulated as follows:

$$s = f_R(p). \quad (3)$$

Synergy of dual processes Motivated by the synergy paradigm of dual processes of human reasoning (Evans, 2006; Kahneman et al., 2002; Stanovich, 2011), we follow a *default-interventionist mechanism* to design the synergy framework of two competing systems. It hypothesizes the two competing systems are reconciled by utilizing System 1 to obtain low-effort default responses, which may be intervened upon with the reflection of high-effort System 2 when the confidence is low. In addition to cognitive science, there’s also evidence to support such proposals from neural imaging (Neys et al., 2008; Goel & Dolan, 2003; Tsujii & Watanabe, 2009) and social neuroscience literature (Lieberman, 2007; 2012). Specifically, we have mainly two designs to establish the framework of DefInt:

- **Confidence evaluator** Intuitive thoughts are often blamed for cognitive biases when facing novel and complex problems without much relevant experience, thus intervention with effortful reasoning is necessary (Evans, 2010). Therefore, once System 1 provides multiple intuitions H , an independent evaluator LLM $f_E(\cdot)$ will estimate the confidence of these “parallel” intuitions based on their coherence. The output signal p is:

$$p = \begin{cases} True & \text{if } H \text{ is evaluated to be low-confidence,} \\ False & \text{otherwise.} \end{cases} \quad (4)$$

When the output signal is True, System 2 will intervene and override the low-confidence intuitive thoughts. This mechanism provides an adaptive synergy method of two systems, which is especially significant when biases arise during reasoning.

- **Periodical gatekeeping** Similar to human reasoning, DefInt prioritizes using System 1 to carry out reasoning steps, which is expected to efficiently make default decisions with diverse affordable LLMs. At the same time, DefInt activates System 2 following a periodical manner as a gatekeeping of the reasoning faithfulness. Specifically, we introduce a hyper-parameter T to control the interval of System 2 in the reasoning chain. For example, given a 4-step reasoning task and $T = 2$, it means that System 2 will be activated after two System 1. The corresponding reasoning chain is System 1 \rightarrow System 1 \rightarrow System 2 \rightarrow System 1. This design sets up a fixed and regular synergy paradigm of two systems.

Conceptually, DefInt has several benefits via the harmonious synergy of two systems: (1) *Cost efficiency*. Compared with existing advanced reasoning methods purely relying on high-cost System 2, DefInt can significantly save token cost by using System 1 in many reasoning steps. (2) *Solution diversity*. DefInt introduces diverse experiential intuitions in System 1 to boost the diversity of solutions, which is especially important for open-ended reasoning problems with huge solution space. (3) *Competitive performance*. Although we replace reflective reasoning with intuitions in some steps, the default-interventionist mechanism can timely prevent the spread of bias and ensure the quality of reasoning thoughts. The whole process of reasoning with DefInt is presented in Algorithm 2.

Algorithm 2 The whole framework with DefInt

Input: Reasoning problem p , required reasoning steps N , period of System 2 T , evaluator LLM $f_E(\cdot)$

```

 $t = 0$  // Current reasoning step
 $S = \{p\}$  // Set of current thoughts
while  $t \leq N$  do
     $t = t + 1$ 
    if  $t \% (T + 1) \neq 0$  then
         $H = \text{System 1}(S)$  // Regular System 1
         $p, a = f_E(H)$  // Evaluate and summarize
        if not  $p$  then
             $z_t = a$  // Accept intuitive thoughts
        end
        else
             $S = S + a$  // Wrap proposed intuitive thoughts
             $z_t = \text{System 2}(S)$  // Intervene
        end
    end
    else
         $z_t = \text{System 2}(S)$  // Regular System 2
    end
     $S = \{z_t\}$  // Update thought state
end
return  $S$ 
    
```

4. Theoretical Computation Cost Analysis

To highlight the cost efficiency of DefInt, we conduct a theoretical cost analysis. Given a reasoning task, we have the following hypothesis to give a concise analysis:

Hypothesis 1. We suppose that every demonstration example accounts for X tokens.

Denote $C_{Ii} = C_{Ii}^1 + C_{Ii}^2 + C_{Ii}^3$ and $C_{Io} = C_{Io}^1 + C_{Io}^2 + C_{Io}^3$ are the total input and output per-token cost for LLMs in System 1. The total cost of System 1 is:

$$C_I = (K_{in}C_{Ii} + C_{Io} + 2C_{Ii} + 2C_{Io} + 2C_{Ii} + C_{Io})X, \quad (5)$$

where K_{in} denotes the number of demonstrations in the prompt. The cost of the evaluator LLM is

$$C_J = (3C_{Ji} + C_{Jo})X, \quad (6)$$

where C_{Ji} and C_{Jo} are the input and output per-token cost for the evaluator LLM. If the confidence of intuitions is low, the cost of invoking System 2 is

$$C_R = (C_{Ri} + C_{Ro})X, \quad (7)$$

where C_{Ri} and C_{Ro} are the input and output per-token cost for the LLM in System 2. By comparison, the cost of reasoning with only System 2 is:

$$C_R^{full} = (K_{in}C_{Ri} + C_{Ro})X. \quad (8)$$

Denote the intervention rate as r , when $(1-r)(C_I + C_J) + r(C_I + C_J + C_R) < C_R^{full}$ is satisfied, DefInt is expected to effectively save token cost and the corresponding requirement of r is (taking $K_{in} = 1$ in most cases):

$$r < 1 - \frac{5C_{Ii} + 4C_{Io} + 3C_{Ji} + C_{Jo}}{C_{Ri} + C_{Ro}}. \quad (9)$$

5. Experiments

5.1. Experimental Settings

Task setup. We evaluate DefInt and compared methods on five complex reasoning tasks including two close-ended tasks (Game of 24 (Yao et al., 2023), Logic Grid Puzzle (Srivastava et al., 2022)) and three open-ended tasks (Trivia Creative Writing (Chen et al., 2023a), Open-ended QA (Chen et al., 2023a), Constrained Generation (Madaan et al., 2023)). For each task, we use the same number of demonstration examples with original papers (one-shot in Game of 24 and zero-shot in others).

Baselines. We compare our method with the following competitive methods of LLM reasoning:

- **Chain-of-thought (CoT)** (Wei et al., 2022b): It firstly proposes to guide LLMs to think in a step-by-step manner for reasoning. For a fair comparison, we conduct multiple trials until reaching a similar token cost of our method.
- **Self-refine** (Madaan et al., 2023): It iteratively produces self-feedback and refines the results.
- **Tree-of-thought (ToT)** (Yao et al., 2023): It generates multiple thought paths and searches the best solution with the heuristics method.
- **SPP** (Wang et al., 2023b): It transforms a LLM into different personas and lets them collaborate to solve reasoning problems.
- **Multi-agent debate with judgment (MAD+judge)** (Liang et al., 2023): It designs a multi-agent debate pipeline with judgment for addressing reasoning problems.

Metrics. We evaluate the methods for reasoning tasks from four perspectives.

- **Accuracy:** For two close-ended tasks, accuracy is measured directly by the generated answer and ground truths. For Trivia Creative Writing task, accuracy is calculated by # correct answer mentions/# trivia questions. For other open-ended tasks, we utilize FairEval (Wang et al., 2023a) to test the answer quality, following prior works (Chen et al., 2023a; Chan et al., 2023).

DefInt: A Default-interventionist Framework for Efficient Reasoning with Hybrid Large Language Models

Methods	Accuracy	Diversity	Token cost (\$)	TFLOPS
CoT(best of 1)	4%	1.0	0.87	5.22E+04
CoT(best of 5)	14%	1.1	1.73	1.04E+05
CoT(best of 25)	32%	1.3	6.68	4.01E+05
CoT(best of 100)	58%	1.6	18.70	1.49E+06
Self-refine	20%	1.2	24.83	1.51E+06
ToT	64%	2.1	23.37	1.40E+06
SPP	12%	1.2	29.97	1.80E+06
MAD+judge	22%	1.3	28.09	1.69E+06
DefInt	78%	2.5	11.93	1.00E+06

Table 1. Results on Game of 24 task.

Methods	Accuracy	Token cost (\$)	TFLOPS
CoT(best of 1)	65.8%	6.72	4.03E+05
CoT(best of 5)	67.1%	27.26	1.64E+06
Self-refine	60.6%	33.37	2.00E+06
ToT	66.1%	38.66	2.32E+06
SPP	68.3%	20.68	1.24E+06
MAD+judge	66.8%	45.00	2.70E+06
DefInt	72.0%	9.63	6.41E+05

Table 2. Results on Logic Grid Puzzle task (no need for diversity metric on this task).

- Diversity:** Solution diversity of content generated by LLMs has long been a widely-discussed issue (Kirk et al., 2023; Padmakumar & He, 2023), which is also important for reasoning tasks, especially open-ended problems with huge solution spaces. For Game of 24, we use the number of generated correct answers to measure solution diversity. For Logic Grid Puzzle there’s no concept of diversity. For three open-ended tasks, we transform the prompt of FairEval to let it give a diversity score (from 1 to 10) of two answers from the same model.
- Token cost:** It records the cost of running the method once for each task, with great attention in prior works (Yue et al., 2023; Yao et al., 2023).
- TFLOPS:** It reflects the computational complexity, which is estimated according to the number of parameters following (Kaplan et al., 2020).

DefInt setup. In the implementation of DefInt, we use GPT-3.5, PaLM2 and Gemini to implement System 1, GPT-3.5 as the evaluator LLM, GPT-4 to achieve System 2. On Game of 24 task (4 reasoning steps) we try $T = 1, 2, 3$ respectively, for other tasks (2 reasoning steps) we set $T = 1$.

5.2. Main Results

We present the performance comparison of DefInt and baselines on five reasoning tasks in Table 1 - 5. From the results, we have the following observations:

DefInt achieves the best reasoning accuracy with significantly reduced computation cost among all methods

Methods	Accuracy	Diversity	Token cost (\$)	TFLOPS
CoT(best of 1)	67.1%	3.8	3.37	2.02E+05
Self-refine	78.2%	4.9	17.79	1.07E+06
ToT	76.8%	4.4	27.32	1.64E+06
SPP	79.9%	5.8	10.94	6.56E+05
MAD+judge	77.4%	6.1	17.00	1.02E+06
DefInt	83.4%	6.3	2.75	1.84E+05

Table 3. Results on Trivia Creative Writing task.

Methods	FairEval	Diversity	Token cost (\$)	TFLOPS
DefInt		5.2	4.77	3.03E+05
v.s. CoT(best of 1)	66.5%	3.1	2.27	1.36E+05
v.s. CoT(best of 5)	62.7%	3.3	8.72	5.23E+05
v.s. Self-refine	56.2%	4.2	15.27	9.16E+05
v.s. ToT	61.3%	3.3	19.44	1.17E+06
v.s. SPP	67.6%	3.8	8.33	5.00E+05
v.s. MAD+judge	55.0%	4.9	17.00	1.02E+06

Table 4. Results on Open-ended Question Answer task.

Methods	FairEval	Diversity	Token cost (\$)	TFLOPS
DefInt		6.1	6.66	4.16E+05
v.s. CoT(best of 1)	71.9%	4.2	4.84	2.91E+05
v.s. CoT(best of 5)	68.1%	4.2	20.11	1.21E+06
v.s. Self-refine	61.2%	5.3	31.86	1.91E+06
v.s. ToT	67.3%	4.7	58.52	3.51E+06
v.s. SPP	74.5%	4.6	26.69	1.60E+06
v.s. MAD+judge	63.6%	5.6	36.59	2.20E+06

Table 5. Results on Constrained Generation task.

across different tasks. Broadly, DefInt outperforms all compared methods in terms of reasoning accuracy (or quality evaluation with FairEval). On Game of 24 task, DefInt surpasses the best baseline ToT (78.0% vs 64.0%) at only 51% of its token cost (71% TFLOPS). On Logic Grid Puzzle task, DefInt outperforms the best baseline SPP (72.0% vs 68.3%) at only 47% of its token cost (52% TFLOPS). On Trivia Creative Writing task, DefInt surpasses the best baseline SPP (83.4% vs 79.9%) at only 25% of its token cost (28% TFLOPS). On Open-ended QA task, DefInt surpasses the best baseline MAD+judge at only 29% of its token cost (30% TFLOPS). On Constrained Generation task, DefInt surpasses the best baseline Self-refine at only 21% of its token cost (22% TFLOPS). For a more intuitive comparison, we present the reasoning accuracy, solution diversity versus token costs/TFLOPS on Game of 24 and Trivia Creative Writing tasks in Figure 3. Visualizations on other tasks are shown in Appendix E. Besides, we also try to enhance baselines with multiple trials and select the best results (e.g., CoT(best of 100) on Game of 24). However, these baselines can not surpass DefInt even with more computation costs. These results demonstrate that DefInt achieves the best trade-off between performance and cost efficiency via the effective synergy of larger and smaller language models.

DefInt benefits solution diversity of reasoning tasks. Except for reasoning accuracy, we also pay attention to the

DefInt: A Default-interventionist Framework for Efficient Reasoning with Hybrid Large Language Models

Methods	Accuracy	Diversity	Token cost (\$)	TFLOPS
DefInt (T=0)	82.9%	4.1	3.84	2.30E+05
DefInt (T=1)	83.4%	6.3	2.75	1.84E+05
DefInt (T=2)	81.3%	6.9	1.30	1.74E+05

Table 6. Hyper-parameter study on Trivia Creative Writing task.

solution diversity of reasoning tasks, which is especially vital for some open-ended problems. It can be found that solutions generated by DefInt possess the highest diversity among all methods on four tested tasks. Specifically, DefInt achieves 9.3% diversity improvement on average compared with the best baseline. This might be attributed to the integration of diverse experiential intuitions in System 1 and the further synergy of dual processes.

5.3. In-depth Analysis of DefInt

Analysis of hyper-parameter T . In the design of periodical gatekeeping, the interval of System 2 is controlled by a hyper-parameter T . For Trivia Creative Writing task with two reasoning steps, we vary T in $[0, 1, 2]$ and the results are shown in Table 6. The best performance is also achieved when $T = 1$. The result on Game of 24 is shown in Appendix C. Overall, the computation cost decreases with the increase of T . Considering the best performance-cost trade-off, we choose $T = 1$ for all tasks.

Ablation study. In this part, we explore the effect of two key designs in DefInt: diverse experiential intuitions and intervention with reflective reasoning. Here we only report the results on Trivia Creative Writing in Table 7 due to the page limit. The results on other tasks are shown in Appendix D. To study the effect of diverse experiential intuitions in System 1, we replace three distinct LLMs with one single LLM (w/ 1 GPT-3.5, w/ 1 PaLM2, w/ 1 Gemini) and three identical LLMs (w/ 3 GPT-3.5, w/ 3 PaLM2, w/ 3 Gemini), respectively. From the results, it can be concluded that utilizing diverse experiential intuitions to propose default thoughts can benefit both accuracy and solution diversity. Besides, we also explore the effect of introducing intervention with reflective reasoning when intuitions are inconsistent or biased. It can be seen that reasoning performance becomes worse when dropping the intervention mechanism. Therefore, these designs effectively work together to enhance reasoning performance.

Feasible intervention rate for efficient LLM synergy.

In section 5 we have a theoretical analysis of the required condition of intervention rates to save computation cost using DefInt. Here we conduct a further study combined with empirical statistics to show the practical options of efficient LLM synergy. We present the empirical intervention rate of different synergy options on five reasoning tasks in Appendix B. From the result, the most diverse synergy group

Methods	Accuracy	Diversity	Token cost (\$)	TFLOPS
DefInt full	83.4%	6.3	2.75	1.84E+05
w/ 1 GPT-3.5	78.6%	4.2	2.76	1.79E+05
w/ 3 GPT-3.5	80.3%	5.7	2.84	1.96E+05
w/ 1 PaLM2	77.8%	4.5	2.61	1.86E+05
w/ 3 PaLM2	78.6%	6.0	2.59	2.08E+05
w/ 1 Gemini	78.1%	4.5	2.57	1.68E+05
w/ 3 Gemini	79.7%	5.8	2.59	1.78E+05
w/o intervention	80.9%	6.5	2.64	1.77E+05

Table 7. Ablation study on Trivia Creative Writing task.

(GPT-3.5/PaLM2/Gemini + GPT-4) obtains the lowest intervention rate on the whole. By comparison, some more homogeneous synergy groups such as 3 PaLM2 + GPT-4 and 3 Gemini + GPT-4 receive higher intervention rates. We then analyze whether such intervention rates can support the efficient LLM synergy in DefInt. In terms of the synergy option GPT-3.5/PaLM2/Gemini + GPT-4, we calculate the upper bound of the tolerable intervention rate according to Eq. (9) and token costs shown in Appendix A. The estimated condition is $r < 75.6\%$, which is much higher than the actual value (only 14.2% on average). Similarly, we obtain the upper bound of the r for synergy option 3 GPT-3.5 + GPT-4 is $r < 41.1\%$. For the synergy option 3 PaLM2 + GPT-4 and 3 Gemini + GPT-4, in principal if $r < 100\%$ it’s expected to reduce cost because the two models are cost-free. Overall, the four tested synergy options are all feasible for cost-saving when using DefInt. Such estimation can be easily generalized to any LLM synergy options and provide a quick assessment of the feasibility of efficient LLM synergy.

6. Related Work

Reasoning with LLMs. With the blooming of LLMs, there has been plenty of work utilizing LLMs to address reasoning problems (Wei et al., 2022b; Yao et al., 2023; Wang et al., 2022; Zhou et al., 2022; Zhang et al., 2023). The early method is to feed standard few-shot examples in the prompt and let LLMs directly answer the target question, *i.e.*, standard IO prompting (Brown et al., 2020). However, the resultant performance is very limited, then some more advanced prompting methods are proposed to facilitate the reasoning ability of LLMs. For example, Chain-of-thought (CoT) encourages LLMs to think in a step-by-step manner, which can activate their inherent reasoning abilities (Wei et al., 2022b). Tree-of-thoughts (ToT) further generalizes over CoT, exploring multiple different thought paths and searching in the thought tree with heuristics methods (Yao et al., 2023). Besides, there are also some other advanced mechanisms fused to improve LLM reasoning abilities such as reflection (Shinn et al., 2023) and refinement (Madaan et al., 2023). Another line of work exploring to enhance the reasoning ability of LLMs is to develop a multi-LLM

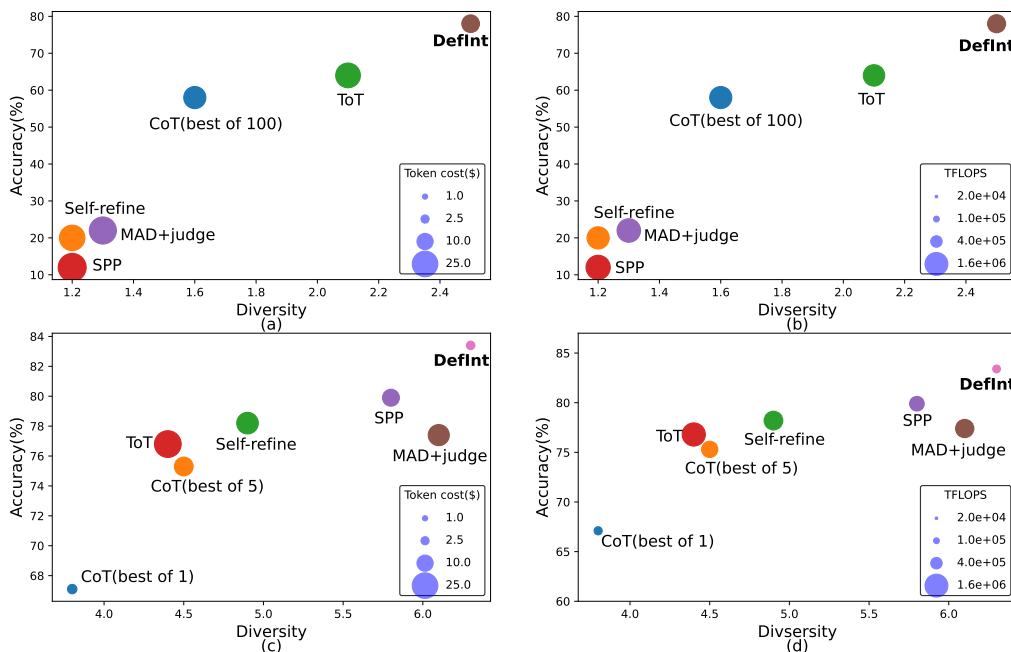

Figure 3. The reasoning accuracy, solution diversity versus token costs/TFLOPS on Game of 24 (a) (b) and Trivia Creative Writing (c) (d). DefInt achieves a better performance-cost trade-off than all compared methods.

collaboration system (Du et al., 2023; Liang et al., 2023; Wang et al., 2023b; Chen et al., 2023b; Sun et al., 2023b). Although the above methods facilitate LLM reasoning performance, it can be found that they all try to enhance reasoning performance with various *System 2*-like deliberation mechanisms but overlook the cost-efficiency issue. Differently, our method explores the harmonious synergy of the dual process to achieve a better balance between reasoning performance and efficiency.

Cost-efficient reasoning with LLMs. Efficiency and cost are critical challenges for LLM reasoning due to the involved complex computations. To improve the speed and cost-effectiveness of LLM reasoning, there have been several approaches, such as quantization (Tao et al., 2022) and model pruning (Sun et al., 2023a). Besides, some works focused on how to utilize the paid API efficiently (Chen et al., 2023c; Šakota et al., 2023). For example, Chen et al. (Chen et al., 2023c) proposed a framework that sends the query to a series of LLMs sequentially if the answers given by the prior model are considered unacceptable. However, all the above methods need to transform the model itself or introduce external fine-tuned verifiers, bringing additional computation costs. Different from the previous model-side modification, we explore a novel path for reducing reasoning cost via diverse LLM synergy, which is training-free and general purpose.

7. Conclusion

We introduce DefInt, an effective hybrid LLM synergy framework for efficient reasoning without any additional training or fine-tuning. Following the default-interventionist mechanism of human decision-making, DefInt can adaptively switch between multiple experiential intuitions and reflective thoughts, thus facilitating a better trade-off between reasoning performance and computation costs. Extensive experiments on broad reasoning tasks emphasize the superiority and generalizability of our method. Compared with the best baseline, DefInt can enhance reasoning accuracy and solution diversity, with only 49% and 25% of its token cost for close-ended and open-ended tasks, respectively. We hope that this work can provide a novel perspective for efficient LLM reasoning with model synergy.

8. Impact Statements

Our work provides a cost-efficient method for solving reasoning problems with LLMs, which is expected to benefit broad organizations, especially those with limited financial budgets such as educational institutions. By designing such a cost-efficient framework, we empower these organizations to harness the reasoning ability of LLMs conveniently, especially for reasoning problems with high complexity. Our work not only makes financial savings but also benefits sustainability development by reducing the carbon emissions brought by extensive computation of LLMs.

References

- Brown, T., Mann, B., Ryder, N., Subbiah, M., Kaplan, J. D., Dhariwal, P., Neelakantan, A., Shyam, P., Sastry, G., Askell, A., et al. Language models are few-shot learners. *Advances in neural information processing systems*, 33: 1877–1901, 2020.
- Chan, C.-M., Chen, W., Su, Y., Yu, J., Xue, W., Zhang, S., Fu, J., and Liu, Z. Chateval: Towards better llm-based evaluators through multi-agent debate. *arXiv preprint arXiv:2308.07201*, 2023.
- Chen, G., Dong, S., Shu, Y., Zhang, G., Sesay, J., Karlsson, B. F., Fu, J., and Shi, Y. Autoagents: A framework for automatic agent generation. *arXiv preprint arXiv:2309.17288*, 2023a.
- Chen, J. C.-Y., Saha, S., and Bansal, M. Reconcile: Round-table conference improves reasoning via consensus among diverse llms. *arXiv preprint arXiv:2309.13007*, 2023b.
- Chen, L., Zaharia, M., and Zou, J. Frugalgpt: How to use large language models while reducing cost and improving performance. *arXiv preprint arXiv:2305.05176*, 2023c.
- Chowdhery, A., Narang, S., Devlin, J., Bosma, M., Mishra, G., Roberts, A., Barham, P., Chung, H. W., Sutton, C., Gehrmann, S., et al. Palm: Scaling language modeling with pathways. *Journal of Machine Learning Research*, 24(240):1–113, 2023.
- Croskerry, P. Clinical cognition and diagnostic error: applications of a dual process model of reasoning. *Advances in health sciences education*, 14:27–35, 2009.
- Du, Y., Li, S., Torralba, A., Tenenbaum, J. B., and Mordatch, I. Improving factuality and reasoning in language models through multiagent debate. *arXiv preprint arXiv:2305.14325*, 2023.
- Evans, J. S. B. The heuristic-analytic theory of reasoning: Extension and evaluation. *Psychonomic bulletin & review*, 13(3):378–395, 2006.
- Evans, J. S. B. On the resolution of conflict in dual process theories of reasoning. *Thinking & Reasoning*, 13(4):321–339, 2007.
- Evans, J. S. B. Intuition and reasoning: A dual-process perspective. *Psychological Inquiry*, 21(4):313–326, 2010.
- Goel, V. and Dolan, R. J. Explaining modulation of reasoning by belief. *Cognition*, 87(1):B11–B22, 2003.
- Kahneman, D. *Thinking, fast and slow*. macmillan, 2011.
- Kahneman, D., Frederick, S., et al. Representativeness revisited: Attribute substitution in intuitive judgment. *Heuristics and biases: The psychology of intuitive judgment*, 49 (49-81):74, 2002.
- Kaplan, J., McCandlish, S., Henighan, T., Brown, T. B., Chess, B., Child, R., Gray, S., Radford, A., Wu, J., and Amodei, D. Scaling laws for neural language models. *arXiv preprint arXiv:2001.08361*, 2020.
- Kirk, R., Mediratta, I., Nalmpantis, C., Luketina, J., Hambro, E., Grefenstette, E., and Raileanu, R. Understanding the effects of rlhf on llm generalisation and diversity. *arXiv preprint arXiv:2310.06452*, 2023.
- Liang, T., He, Z., Jiao, W., Wang, X., Wang, Y., Wang, R., Yang, Y., Tu, Z., and Shi, S. Encouraging divergent thinking in large language models through multi-agent debate. *arXiv preprint arXiv:2305.19118*, 2023.
- Lieberman, M. D. Social cognitive neuroscience: a review of core processes. *Annu. Rev. Psychol.*, 58:259–289, 2007.
- Lieberman, M. D. *What zombies can't do: A social cognitive neuroscience approach to the irreducibility of reflective consciousness*. 2012.
- Madaan, A., Tandon, N., Gupta, P., Hallinan, S., Gao, L., Wiegrefe, S., Alon, U., Dziri, N., Prabhumoye, S., Yang, Y., et al. Self-refine: Iterative refinement with self-feedback. *arXiv preprint arXiv:2303.17651*, 2023.
- Neys, W. D., Vartanian, O., and Goel, V. Smarter than we think: When our brains detect that we are biased. *Psychological Science*, 19(5):483–489, 2008.
- Padmakumar, V. and He, H. Does writing with language models reduce content diversity? *arXiv preprint arXiv:2309.05196*, 2023.
- Radford, A., Narasimhan, K., Salimans, T., Sutskever, I., et al. Improving language understanding by generative pre-training. 2018.
- Radford, A., Wu, J., Child, R., Luan, D., Amodei, D., Sutskever, I., et al. Language models are unsupervised multitask learners. *OpenAI blog*, 1(8):9, 2019.
- Šakota, M., Peyrard, M., and West, R. Fly-swat or cannon? cost-effective language model choice via meta-modeling. *arXiv preprint arXiv:2308.06077*, 2023.
- Shinn, N., Cassano, F., Gopinath, A., Narasimhan, K. R., and Yao, S. Reflexion: Language agents with verbal reinforcement learning. In *Thirty-seventh Conference on Neural Information Processing Systems*, 2023.

- Srivastava, A., Rastogi, A., Rao, A., Shoeb, A. A. M., Abid, A., Fisch, A., Brown, A. R., Santoro, A., Gupta, A., Garriga-Alonso, A., et al. Beyond the imitation game: Quantifying and extrapolating the capabilities of language models. *arXiv preprint arXiv:2206.04615*, 2022.
- Stanovich, K. *Rationality and the reflective mind*. Oxford University Press, USA, 2011.
- Sun, M., Liu, Z., Bair, A., and Kolter, J. Z. A simple and effective pruning approach for large language models. *arXiv preprint arXiv:2306.11695*, 2023a.
- Sun, Q., Yin, Z., Li, X., Wu, Z., Qiu, X., and Kong, L. Corex: Pushing the boundaries of complex reasoning through multi-model collaboration. *arXiv preprint arXiv:2310.00280*, 2023b.
- Tao, C., Hou, L., Zhang, W., Shang, L., Jiang, X., Liu, Q., Luo, P., and Wong, N. Compression of generative pre-trained language models via quantization. *arXiv preprint arXiv:2203.10705*, 2022.
- Tsujii, T. and Watanabe, S. Neural correlates of dual-task effect on belief-bias syllogistic reasoning: a near-infrared spectroscopy study. *Brain research*, 1287:118–125, 2009.
- Wang, P., Li, L., Chen, L., Zhu, D., Lin, B., Cao, Y., Liu, Q., Liu, T., and Sui, Z. Large language models are not fair evaluators. *arXiv preprint arXiv:2305.17926*, 2023a.
- Wang, X., Wei, J., Schuurmans, D., Le, Q., Chi, E., Narang, S., Chowdhery, A., and Zhou, D. Self-consistency improves chain of thought reasoning in language models. *arXiv preprint arXiv:2203.11171*, 2022.
- Wang, Z., Mao, S., Wu, W., Ge, T., Wei, F., and Ji, H. Unleashing the emergent cognitive synergy in large language models: A task-solving agent through multi-persona self-collaboration. *arXiv preprint arXiv:2307.05300*, 2023b.
- Wei, J., Tay, Y., Bommasani, R., Raffel, C., Zoph, B., Borgeaud, S., Yogatama, D., Bosma, M., Zhou, D., Metzler, D., et al. Emergent abilities of large language models. *arXiv preprint arXiv:2206.07682*, 2022a.
- Wei, J., Wang, X., Schuurmans, D., Bosma, M., Xia, F., Chi, E., Le, Q. V., Zhou, D., et al. Chain-of-thought prompting elicits reasoning in large language models. *Advances in Neural Information Processing Systems*, 35: 24824–24837, 2022b.
- Yao, S., Yu, D., Zhao, J., Shafran, I., Griffiths, T. L., Cao, Y., and Narasimhan, K. Tree of thoughts: Deliberate problem solving with large language models. *arXiv preprint arXiv:2305.10601*, 2023.
- Yue, M., Zhao, J., Zhang, M., Du, L., and Yao, Z. Large language model cascades with mixture of thoughts representations for cost-efficient reasoning. *arXiv preprint arXiv:2310.03094*, 2023.
- Zhang, Y., Yang, J., Yuan, Y., and Yao, A. C.-C. Cumulative reasoning with large language models. *arXiv preprint arXiv:2308.04371*, 2023.
- Zheng, L., Chiang, W.-L., Sheng, Y., Zhuang, S., Wu, Z., Zhuang, Y., Lin, Z., Li, Z., Li, D., Xing, E., et al. Judging llm-as-a-judge with mt-bench and chatbot arena. *arXiv preprint arXiv:2306.05685*, 2023.
- Zhou, D., Schärli, N., Hou, L., Wei, J., Scales, N., Wang, X., Schuurmans, D., Cui, C., Bousquet, O., Le, Q. V., et al. Least-to-most prompting enables complex reasoning in large language models. In *The Eleventh International Conference on Learning Representations*, 2022.

A. Token Costs of Used LLMs

Here we show the token costs of different LLMs we use in this work in Table 8. The statistics of GPT-3.5 and GPT-4 are from the official report of OpenAI². The other two LLMs are cost-free when the work is done.

Model	Input /1K tokens	Output /1K tokens
GPT-3.5	\$0.0015	\$0.002
GPT-4	\$0.03	\$0.06
PaLM2	0	0
Gemini	0	0

Table 8. Input and output token cost of different LLMs.

B. Empirical Average Intervention Rates

Here we show the empirical average intervention rates of four LLM synergy options on five reasoning tasks in Table 9, for measuring the practicability to maintain cost-saving by using DefInt.

Synergy options	Game of 24	Logic Grid Puzzle	Creative Writing	OpenQA	Constrained Generation
3 GPT-3.5 + GPT-4	18%	12%	24%	15%	13%
3 PaLM2 + GPT-4	26%	23%	29%	19%	15%
3 Gemini + GPT-4	22%	13%	30%	14%	18%
GPT-3.5/PaLM2/Gemini + GPT-4	16%	8%	21%	11%	15%

Table 9. Empirical average intervention rate on five reasoning tasks.

C. More Hyper-parameter Study

Here we add the results of the hyper-parameter study on Game of 24 task, as shown in Table 10.

Methods	Accuracy	Diversity	Token cost (\$)	TFLOPS
DefInt (T=0)	66%	2.1	24.14	1.45E+06
DefInt (T=1)	78%	2.5	11.93	1.00E+06
DefInt (T=2)	60%	1.9	9.62	8.81E+05
DefInt (T=3)	64%	2.2	7.77	7.89E+05
DefInt (T=4)	38%	1.7	5.63	7.95E+05

Table 10. Hyper-parameter study on Game of 24 task.

D. Ablation Study on More Reasoning Tasks

Here we supplement the results of the ablation study on Game of 24, Logic Grid Puzzle, Open-ended QA and Constrained Generation tasks, as shown in Table 11, 12, 13 and 14. From the results, dropping multiple experiential intuitions in System 1 and the intervention of System 2 will all harm the reasoning performance. Particularly, it seems that PaLM2 performs worse in System 1 compared with GPT-3.5 and Gemini.

²<https://openai.com/pricing>

Methods	Accuracy	Diversity	Token cost (\$)	TFLOPS
DefInt full	78%	2.5	11.93	1.00E+06
w/ 1 GPT-3.5	66%	2.1	10.73	8.48E+05
w/ 3 GPT-3.5	74%	2.3	12.99	1.15E+06
w/ 1 PaLM2	60%	1.9	8.86	9.58E+05
w/ 3 PaLM2	66%	2	8.68	1.33E+06
w/ 1 Gemini	62%	1.9	8.53	7.13E+05
w/ 3 Gemini	70%	2.1	8.38	8.75E+05
w/o intervention	72%	2.2	11.49	9.78E+05

Table 11. Ablation study on Game of 24 task.

Methods	Accuracy	Token cost (\$)	TFLOPS
DefInt full	72.0%	9.63	6.41E+05
w/ 1 GPT-3.5	68.6%	9.72	6.30E+05
w/ 3 GPT-3.5	70.0%	9.89	6.73E+05
w/ 1 PaLM2	63.5%	8.97	6.47E+05
w/ 3 PaLM2	67.3%	8.84	7.17E+05
w/ 1 Gemini	66.0%	8.89	5.78E+05
w/ 3 Gemini	69.2%	8.73	6.14E+05
w/o intervention	70.2%	9.50	6.33E+05

Table 12. Ablation study on Logic Grid Puzzle task.

Methods	FairEval	Diversity	Token cost (\$)	TFLOPS
DefInt full		5.2	4.77	3.03E+05
v.s.w/ 1 GPT-3.5	61.3%	3.2	4.79	2.97E+05
v.s.w/ 3 GPT-3.5	57.8%	4.4	4.88	3.14E+05
v.s.w/ 1 PaLM2	75.1%	3.7	4.72	3.07E+05
v.s.w/ 3 PaLM2	71.2%	4.7	4.66	3.41E+05
v.s.w/ 1 Gemini	63.7%	3.1	4.70	2.91E+05
v.s.w/ 3 Gemini	60.0%	4.6	4.65	3.00E+05
v.s.w/o intervention	54.6%	5.1	4.65	2.96E+05

Table 13. Ablation study on Open-ended Question Answer task.

Methods	FairEval	Diversity	Token cost (\$)	TFLOPS
DefInt full		6.1	6.66	4.16E+05
v.s.w/ 1 GPT-3.5	58.3%	4.4	6.65	4.09E+05
v.s.w/ 3 GPT-3.5	55.6%	5.5	6.73	4.25E+05
v.s.w/ 1 PaLM2	62.0%	4.7	6.68	4.22E+05
v.s.w/ 3 PaLM2	60.6%	5.7	6.81	4.55E+05
v.s.w/ 1 Gemini	59.0%	4.4	6.66	4.02E+05
v.s.w/ 3 Gemini	55.3%	5.4	6.73	4.09E+05
v.s.w/o intervention	54.1%	6.2	6.52	4.08E+05

Table 14. Ablation study on Constrained Generation task.

E. Performance-cost Analysis on More Reasoning Tasks

We conduct more performance-cost analysis on other reasoning tasks including Logic Grid Puzzle, Open-ended QA and Constrained Generation. The results are shown in Figure 4, 5 and 6, respectively. Consistent with the results in the main body, DefInt achieves the best performance-cost trade-off among all methods.

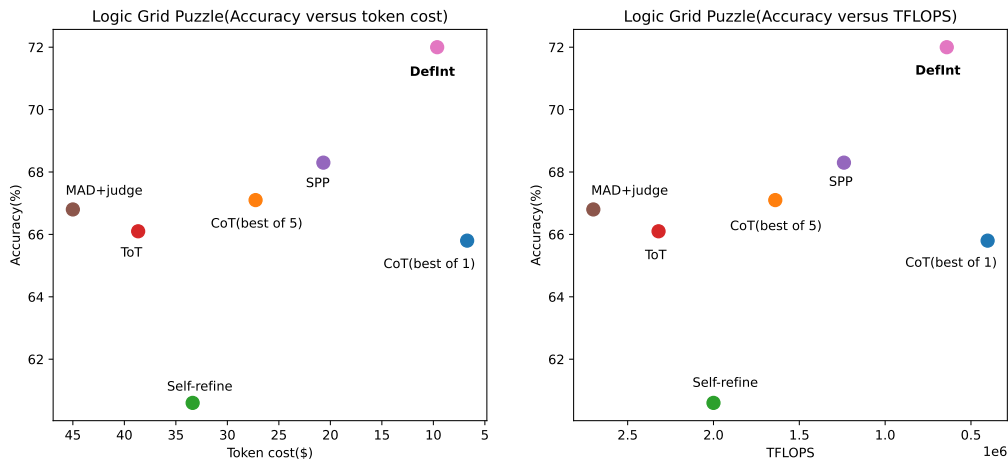

Figure 4. The reasoning accuracy versus token costs/TFLOPS on Logic Grid Puzzle task. DefInt achieves a better performance-cost trade-off than all compared methods.

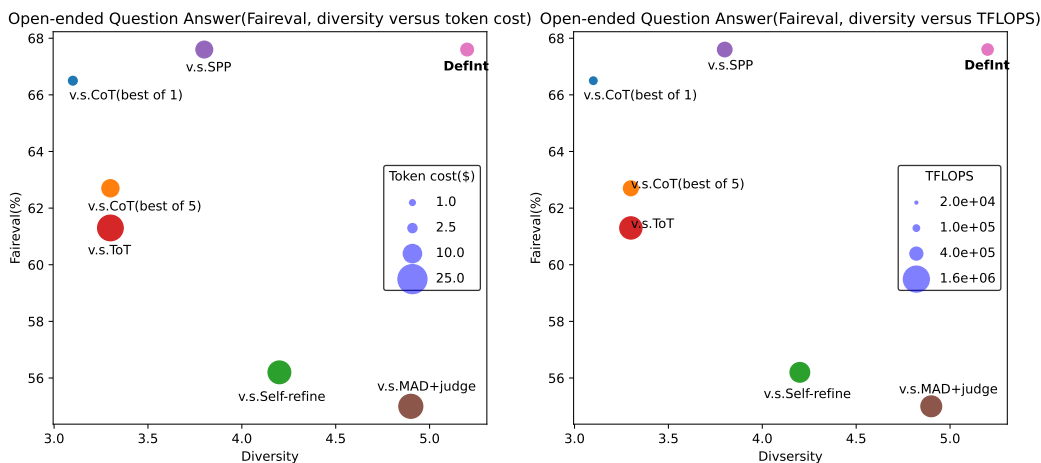

Figure 5. The reasoning accuracy, solution diversity versus token costs/TFLOPS on Open-ended QA task. DefInt achieves a better performance-cost trade-off than all compared methods.

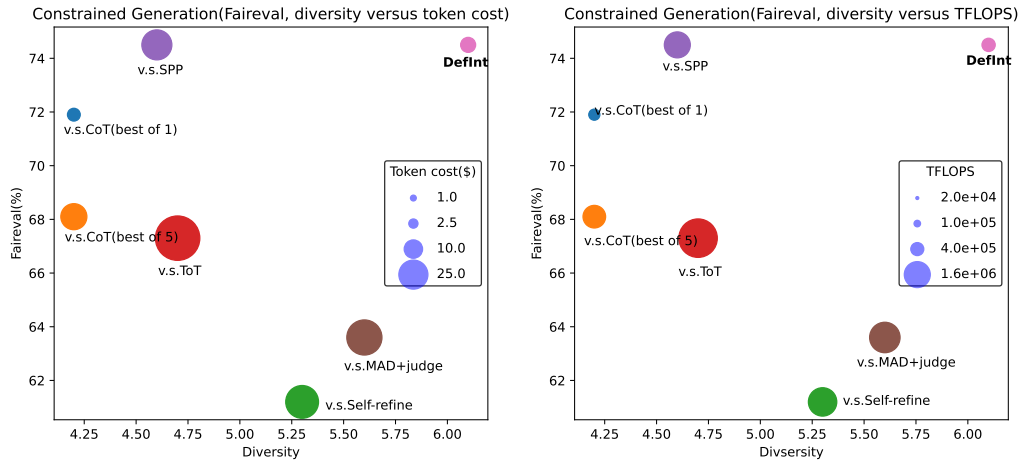

Figure 6. The reasoning accuracy, solution diversity versus token costs/TFLOPS on Constrained Generation task. DefInt achieves a better performance-cost trade-off than all compared methods.

F. Illustrations of DefInt on More Reasoning Tasks

For a better understanding of the scheme of DefInt, here we present some more cases from the other four reasoning tasks. The illustrations on Game of 24, Logic Grid Puzzle, Trivia Creative Writing and Constrained Generation are shown in Figure 7, 8, 9 and 10, respectively.

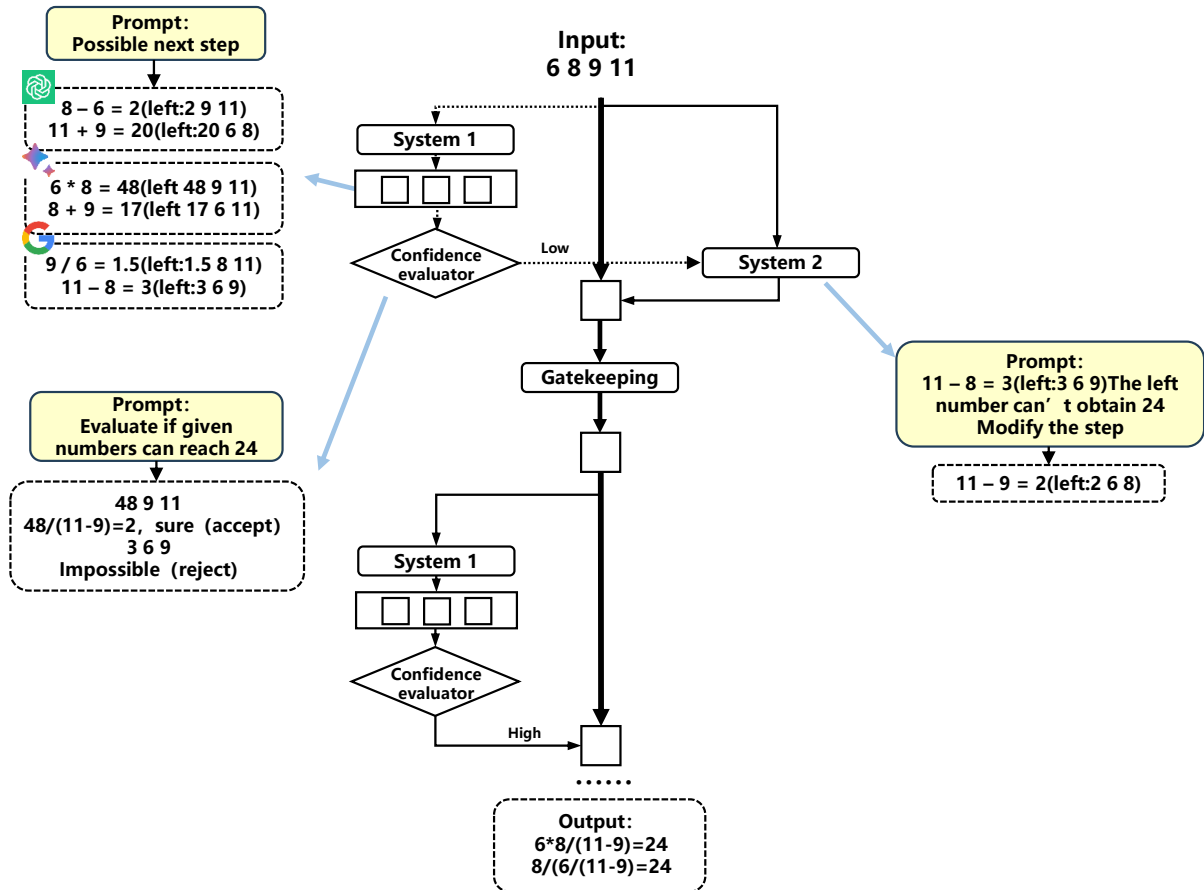

Figure 7. An illustrative example of DefInt from Game of 24 Task.

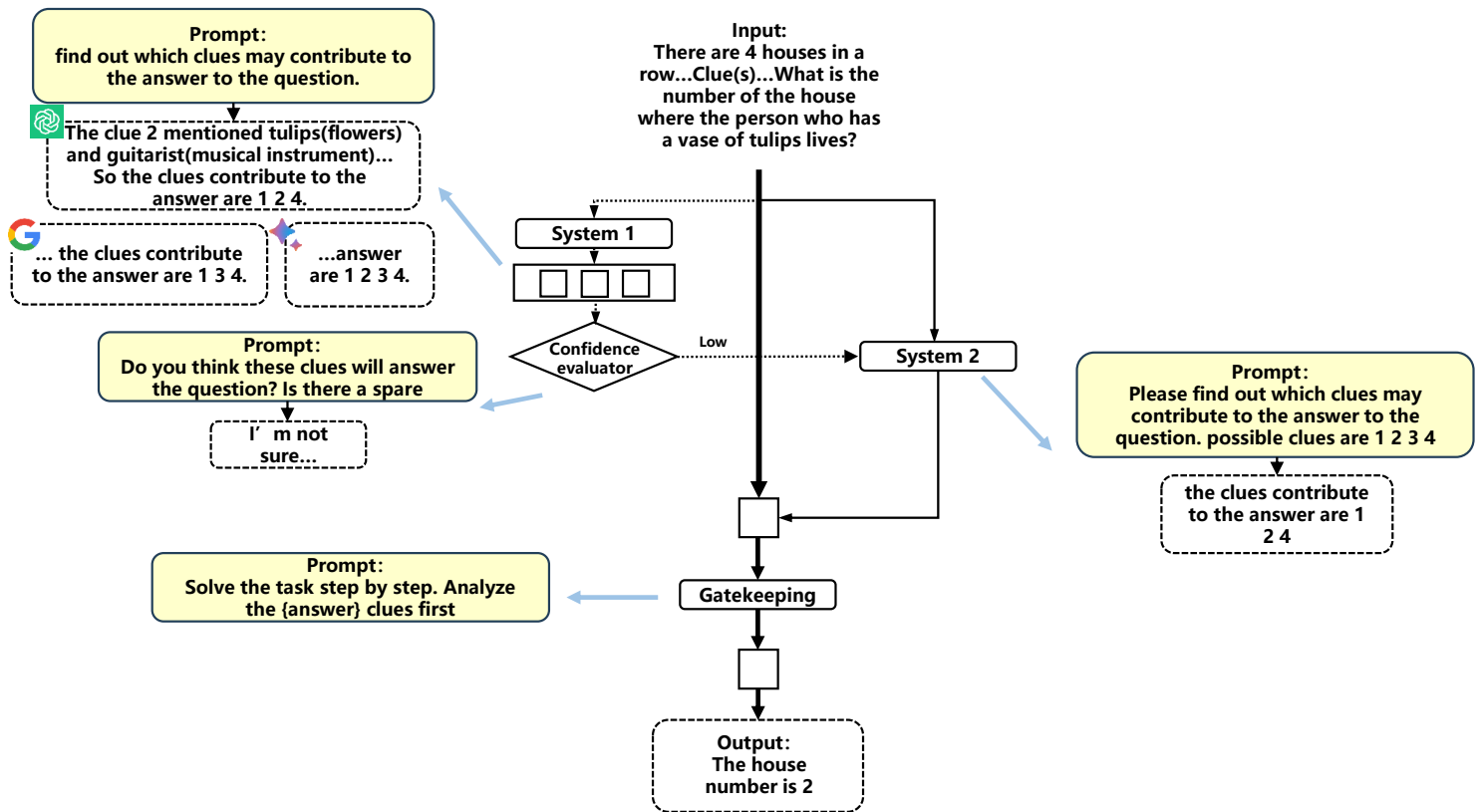

Figure 8. An illustrative example of DefInt from Logic Grid Puzzle Task.

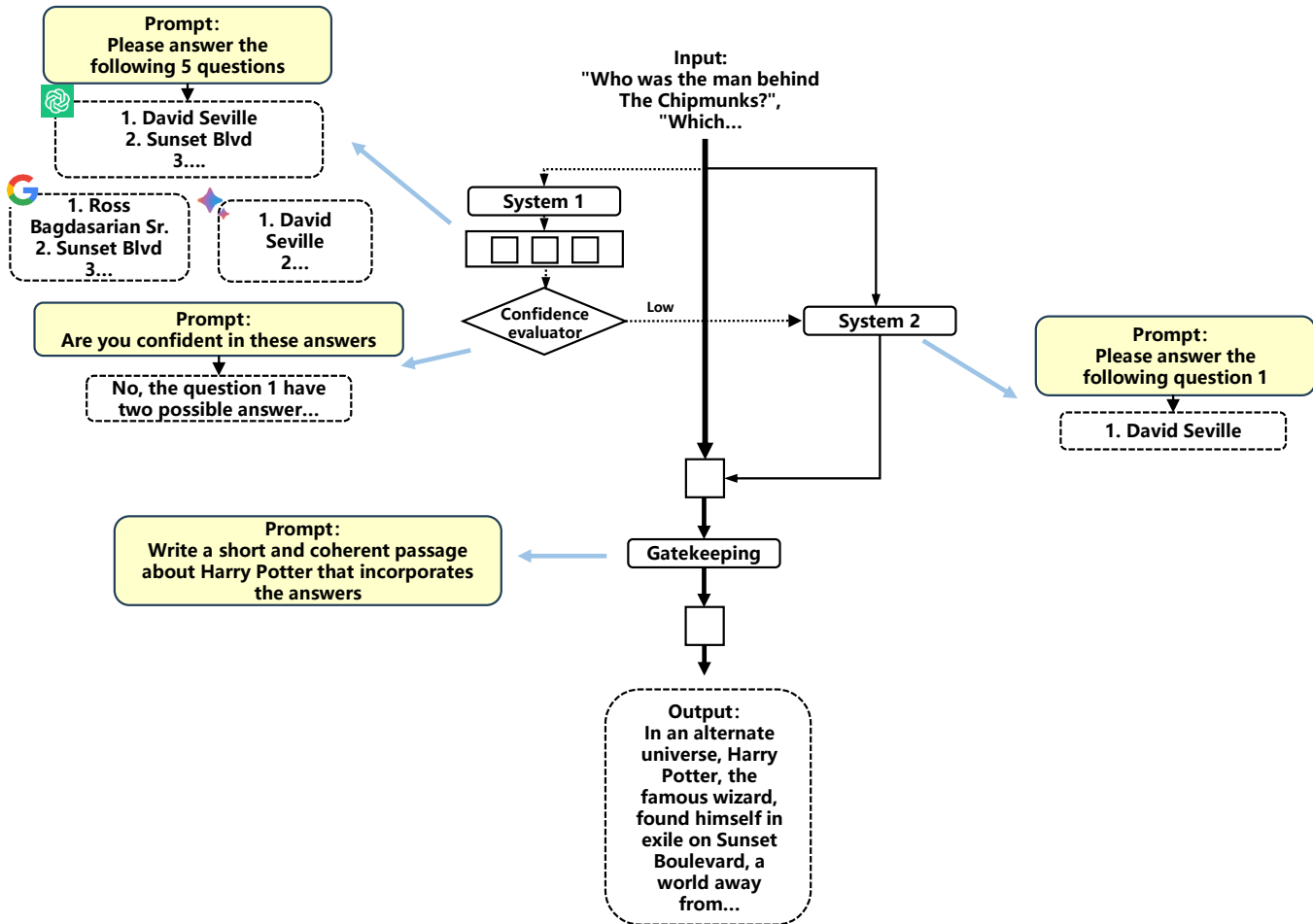

Figure 9. An illustrative example of DefInt from Trivia Creative Writing Task.

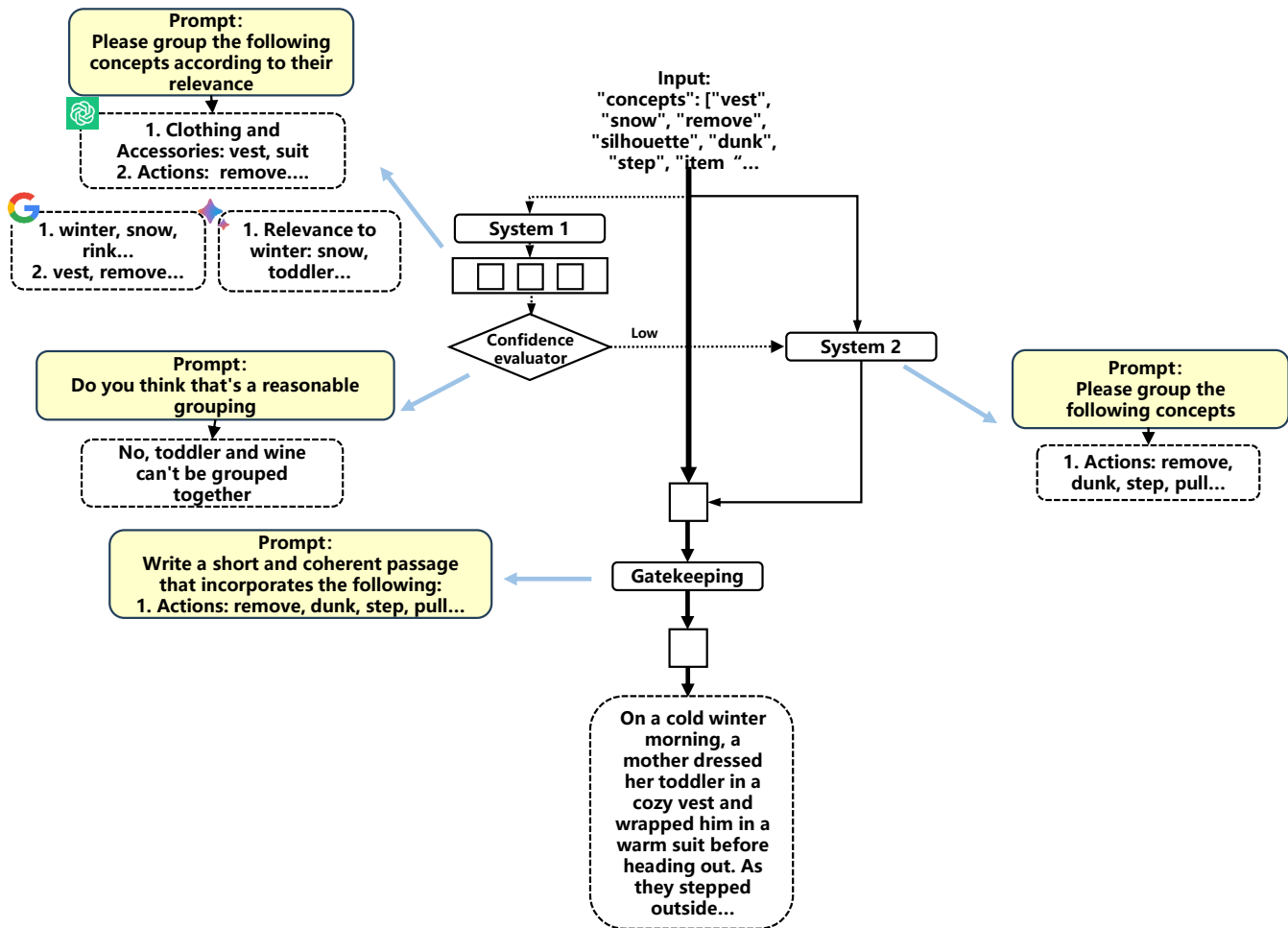

Figure 10. An illustrative example of DefInt from Constrained Generation Task.