

Truck Parking Usage Prediction with Decomposed Graph Neural Networks

Rei Tamaru, Yang Cheng, Steven Parker, Ernie Perry, Bin Ran, and Soyoung Ahn

Abstract—Truck parking on freight corridors faces various challenges, such as insufficient parking spaces and compliance with Hour-of-Service (HOS) regulations. These constraints often result in unauthorized parking practices, causing safety concerns. To enhance the safety of freight operations, providing accurate parking usage prediction proves to be a cost-effective solution. Despite the existing research demonstrating satisfactory accuracy for predicting individual truck parking site usage, few approaches have been proposed for predicting usage with spatial dependencies of multiple truck parking sites. We present the Regional Temporal Graph Neural Network (RegT-GCN) as a predictive framework for assessing parking usage across the entire state to provide better truck parking information and mitigate unauthorized parking. The framework leverages the topological structures of truck parking site distributions and historical parking data to predict occupancy rates across a state. To achieve this, we introduce a Regional Decomposition approach, which effectively captures the geographical characteristics. We also introduce the spatial module working efficiently with the temporal module. Evaluation results demonstrate that the proposed model surpasses other baseline models, improving the performance by more than 20% compared with the original model. The proposed model allows truck parking sites' perception of the topological structures and provides higher performance.

Index Terms—Truck Parking Usage Prediction, Graph Neural Network, Graph Decomposition

I. INTRODUCTION

The Federal Motor Carrier Safety Administration (FMCSA) has implemented regulations to decrease fatigue-related safety hazards for truck drivers by restricting the consecutive and total daily driving hours permissible for truck operators. Despite these efforts, truck drivers still spend considerable time searching for safe parking locations beyond their limited legal working hours [1]. This phenomenon highlights the persistent issue of inadequate truck parking facilities, contributing to unauthorized parking behaviors and breaches of parking regulations [2].

The literature identifies increasing truck drivers' accessibility to real-time parking usage information [3] and drivers' perceptual interpretations [4], [5] as major factors influencing these parking challenges. According to the survey studies in

the region [6], members of the Mid-America Association of State Transportation Officials (MAASTO) from eight states, Indiana, Iowa, Kansas, Kentucky, Michigan, Minnesota, Ohio, and Wisconsin, have collaborated to construct a real-time, multi-state Truck Parking Information Management System (TPIMS) to feed more practical truck parking information for truck drivers [7], [8]. TPIMS, fully operating since January 4th, 2019, provides real-time parking usage information to truck drivers through dynamic message signs, smartphone applications, traveler information websites (e.g., 511 traveler information), and other forms.

In addition to real-time parking site availability information, future usage prediction can better support truck drivers in their decision-making process and route planning. Current prediction models exhibit commendable accuracy in predicting future usage for the subsequent hour [9], [10]. However, it is crucial to recognize that the domain of interest encompasses multiple truck parking sites situated along the highway corridor. Boris and Brewster [1] reported that the most critical aspects of the target parking sites are the proximity to the route/destination followed by the amenity availability. Thus, the primary objective of our prediction models is to capitalize on the wealth of data available from various truck parking sites and leverage their topological structures.

Since 2019, the research team has developed the TPIMS data archiving system (TPIMS-DAS), designed to store effectively and track truck parking information [11]. Leveraging the substantial benefits derived from an abundance of comprehensive and detailed information on truck parking sites, users can extract and aggregate truck parking data from eight states in MAASTO using TPIMS-DAS. It also leads to providing a sufficient number of truck parking data to train reliable models. Using the advantages of wide-range truck parking data with TPIMS-DAS, we fundamentally analyzed truck parking usage patterns. [12]. In this research, we developed a model grounded in spatial dependencies of highway corridors to comprehend how regional relationships of truck parking site locations can contribute to the future usage prediction task.

This study first addresses the topological structures of highway corridors to assess multiple truck parking site usage prediction. We propose a Regional Temporal Graph Neural Network (RegT-GCN) composed of a Graph Neural Network with temporal capability and novel decomposition modules to acquire regional relationships, separated by state (Figure 1). Utilizing the significant parking site information dataset, we could leverage temporal dependencies of the multi-state-wide truck parking usage to acquire more accurate predicted results. We conducted several experiments to evaluate the importance

The Truck Parking Information System (TPIMS) was developed through sponsorship and collaboration with Mid America Freight Coalition (MAFC) and participating states of Mid America Association of State Transportation Officials (MAASTO). The ideas and views expressed in this paper are strictly those of the Traffic Operations and Safety (TOPS) Laboratory at the University of Wisconsin-Madison.

R. Tamaru, Y. Cheng, S. Parker, E. Perry, B. Ran, and S. Ahn are with the Department of Civil and Environmental Engineering, University of Wisconsin-Madison, Madison, Wisconsin, United States, 53705 (email: tamaru@wisc.edu; cheng8@wisc.edu; sparker@engr.wisc.edu; ebperry@wisc.edu; bran@wisc.edu; sue.ahn@wisc.edu;

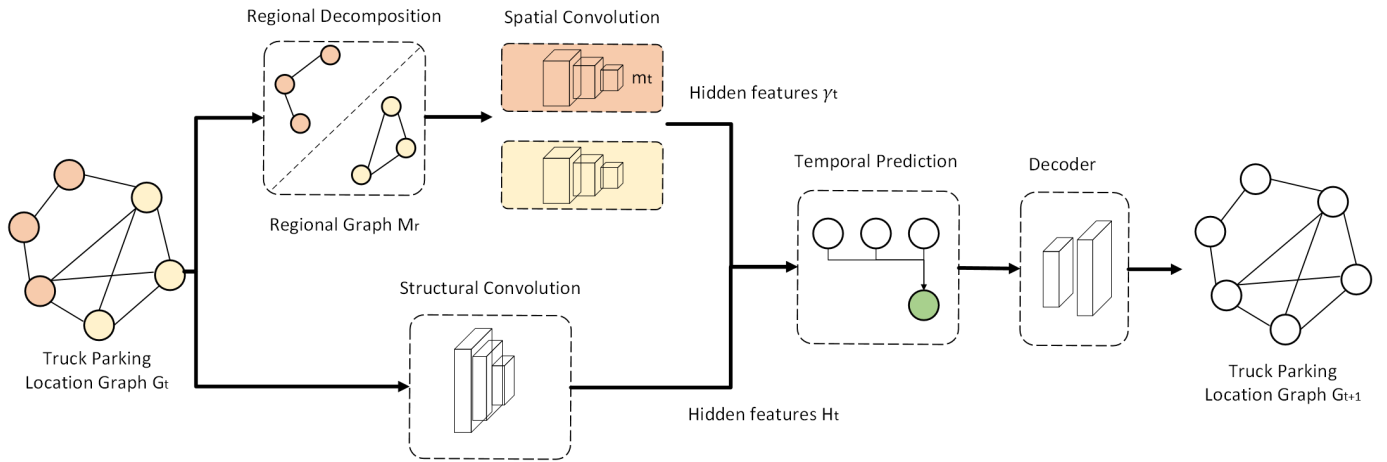

Figure 1. The overview of Regional Temporal Graph Neural Network.

of Regional Decomposition for Graph Neural Networks.

Our technical contributions can be summarized in the following.

- A spatio-temporal model to predict the multiple truck parking usage.
- A novel Regional Decomposition method, which leverages the regional relationships to create subgraphs for each region (i.e., state) and effectively captures the spatio-temporal dependencies.
- The comprehensive truck parking data, which is aggregated across multi-states to train their spatio-temporal dependencies and evaluate the prediction accuracy of occupancy rates.
- Extensive quantitative evaluation, which demonstrates that our RegT-GCN significantly outperforms state-of-the-art baseline models.

II. LITERATURE REVIEW

Parking prediction methods can be classified into two main categories: urban parking prediction, which pertains to parking prediction within cities, and truck parking prediction, which deals with predicting parking usage for trucks. Typically, urban parking prediction methods offer a shorter prediction horizon, ranging from 5 to 15 minutes ahead. In contrast, truck parking prediction provides predictions for up to 1 hour ahead [10]. Regardless of the distinctions in time frames between these parking prediction tasks, it is noteworthy that both tasks often share fundamental concepts and are devised with a broader perspective encompassing diverse parking scenarios.

A. Statistical Prediction Model for Truck Parking Usage

Bayraktar et al. [13] developed an intelligent parking-management system for commercial vehicles in Florida, analyzed data, and created a prediction model for rest area occupancy with a Kalman filter. As the Kalman filter prediction-correction mechanism can be utilized with historical data and adapted to online status, their model achieved better performance. Sadek et al. [9] identified several patterns such as the regular, surplus, discharge, holiday, and weekend patterns.

They proposed two models to predict future usage with lower RMSE. One is the hybrid Fourier model of the Trend Switching model, which predicts usage patterns starting from the regular pattern and switches to surplus or discharge later. Another model, named the Trend Shifting model, shifts the existing pattern to match observed data. Haque et al. [14] compared four different Poisson-related models and stated that the model of Poisson with propensity and threshold-specific constant is the best. The following non-homogeneous Poisson Model proposed in [15] surpasses the other methods, such as the multivariate spatio-temporal model [16] curves similarity and historical average. Moreover, the queuing model has a non-homogeneous arrival rate and time-varying service time distribution. Hamidreza et al. [17] presented a queuing model where the arrivals follow a non-homogeneous Poisson process and predicted parking usage probabilistically from microscopic perspectives of each parking and macroscopic perspectives of aggregated parking information.

B. Machine Learning Prediction Model for General Parking Usage

Although these statistical models successfully predicted with reasonable accuracy, the models depend on sequential data such as parking availability and arrival and departure rates. Recent researchers employ machine learning techniques to integrate all related features such as weather conditions, daily patterns, and parking location and predict future usages with better accuracy [10], [18], [19]. For the research on citywide parking, Zhao and Zhang [18] developed six types of predicting models (FM1, FM2, linear regression, support vector machine (SVM), backpropagation neural network, and autoregressive integrated moving average). SVM and its ensemble model achieved lower RMSE as it is easier to find the global optimum. Zheng et al. [19] first predicted the distribution of parking arrivals and departures pattern with the Markov birth and death process. Then, with parameter estimation, they predicted parking demand for the short term. Hao et al. [10] analyzed the parking usage pattern with data aggregation at several parking sites. They found that there are tendencies in

the on-working period (Sunday night to Friday daytime) and off-working period (others), in which the usage remains lower. They also developed spatio-temporal models with attention modules on the decoder and achieved high precision results. Lastly, Low et al. [20] interestingly focused on predicting the commercial vehicle parking duration. Before putting the data into the regression models, they generated the incomplete field with generative adversarial multiple imputation networks (GAMIN), then output the predicted dwell time.

C. Spatio-Temporal Prediction Model for General Parking Usage

Most prior research on predicted truck parking utilization focuses primarily on historical parking usage data and static variables, such as speed limit and annual average daily traffic [10]. However, it overlooks the inclusion of other salient predictors. As asserted by Boris and Brewster [1], the pivotal determinants guiding truck drivers' decision-making process are parking location and the quality of amenities available. Consequently, integrating topological structures into the predictive model is justified, given its potential to account for spatial variations in the influential factors.

Graph Neural Networks (GNN) [21] are well known for understanding and representing topological structures. GNN has been widely used in the transportation field for its ability to capture spatial dependencies. A road network is naturally usable as a non-Euclidean graph structure [22]. Yang et al. [23] first leveraged Graph-Convolutional Neural Networks (GCN) on urban parking to extract the spatial dependencies of traffic flow in large-scale networks and achieved a low Mean Absolute Error (MAE) in Pittsburgh downtown. They also incorporated Recurrent Neural Networks (RNN) and Long Short Term Memory (LSTM) to capture temporal dependencies with additional related features such as weather data and traffic speed to achieve the parking usage prediction considering spatio-temporal dependencies. Zhang et al. [24] proposed a hierarchical graph convolution structure. They addressed the scarcity of real-time parking availability information with a semi-supervised approach and spatio-temporal dependencies among parking lots. Despite their success in urban parking with spatio-temporal dependencies, they have yet to conduct modeling and experiments on truck parking usage prediction due to the lack of sufficient data.

Compared to the approaches applied to citywide car parking, truck parking is more relative to their route decisions, and critical characteristics such as capacity limitations and diurnal patterns directly affect the predicted results [9]. According to Sadek et al. [9], the fixed capacity of truck parking sites represents a conducive factor in predicting truck parking usage. Besides, most truck drivers routinely work and find their rest except for unexpected situations such as bad weather or traffic congestion: the same drivers occupy most parking lots daily.

This study aims to predict future parking usage patterns considering the highway network's topological structures and spatio-temporal dependencies of the network. Specifically, we develop a graph convolution model to capture these complex

characteristics, enabled by extensive data on highway networks and parking site characteristics, such as the number of amenities and the distance from the nearest city.

III. METHODOLOGICAL APPROACH

A. Problem Formulation

To achieve revolving around the prediction of future truck parking usage, we employ a graph-based framework, denoted as $G = (V, E)$, where individual parking sites are represented as nodes $v \in V$, and the connections between these sites are represented as edges $e \in E$. Within this framework, we denote node embedding as η , essentially numerical representations of each site's characteristics of features.

Our primary challenge is to predict the occupancy rates of truck parking sites over the next T future time intervals. To predict the accurate future occupancy rates, we incorporate information from the K preceding consecutive time intervals from the number of sites i . This approach enables us to capture temporal patterns in truck parking usage.

Our prediction task is formulated by the equation:

$$\eta_{t-K}, \dots, \eta_t \rightarrow \hat{\eta}_{t+1}, \dots, \hat{\eta}_{t+T} \quad (1)$$

In this equation, the left-hand side represents the historical node embeddings for a specific parking site up to time t . These embeddings encode the site's historical characteristics. Our model then processes this information to generate predictions for the occupancy rates in the subsequent time intervals, shown on the right-hand side. These predicted embeddings represent the future occupancy rates.

Then, we generalize the prediction target across all parking sites within our dataset, solving the prediction task:

$$[X_{t-K}, \dots, X_t; E; G] \rightarrow [\hat{X}_{t+1}, \dots, \hat{X}_{t+T}] \quad (2)$$

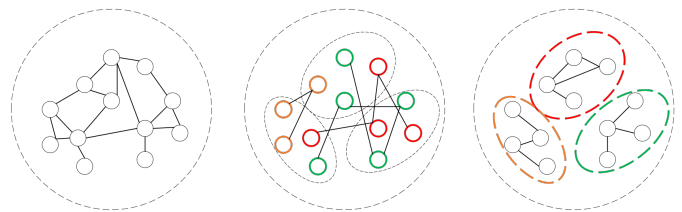

Figure 2. Variety of connectivity on the simple graphs (Left: connected, Middle: randomly connected, Right: regionally connected). Small ellipses represent regional classification. The same color denotes the same group constructing one graph.

To solve the task effectively, this research focuses on identifying spatial dependencies within the truck parking domain, especially regional associations between truck parking sites. Based on the preliminary analysis [12] and insights from previous studies regarding the efficacy of edge reduction techniques [19], [25], we assume that the regional relationship within the parking site network can be leveraged to reduce graph complexity. We hypothesize that a regionally decomposed graph structure, as opposed to one connected graph, offers advantages in terms of both predictive performance and computational expansiveness.

In this paper, we define smaller partitions in the target truck parking sites as an independent region and explore the spatial dependencies of each region's site locations. Site-specific parking behavior deliberates region selection to be grounded in practicality and the unique characteristics exhibited by states [26]. For example, freight plans vary by state, so they recommend different values and strategies for developing, funding, and maintaining shared facilities. From a data aggregation perspective, it is also beneficial to manipulate data by state. Hence, our regional selection prioritizes interpretability and practical outcomes.

Figure 2 illustrates the diversity of connection approaches. We transform the connected graph into a sparser representation by incorporating both random and regional connections. Formally, we define regional graphs as subgraphs of the truck parking site graphs, denoted as $M = (V', E')$ segmented based on regional areas. Each regional graph $M^r \subseteq M$ consists of a subset of vertices $V^r \subseteq V$ and edges $E^r \subseteq E$. The adjacency matrix of the overall graph G is represented as $A \in \mathbf{R}^{n \times n}$ and can be defined as follows, where the vertices of G are labeled as v_1, \dots, v_n and the entries are binary (0, 1).

$$e_{i,j} = v_i v_j \in E \iff A[i, j] = 1 \quad (3)$$

Similarly, the adjacency matrix of regional subgraph $M^r \subseteq M$ denoted as $A^r \subseteq A$, is selectively defined for each state in MAASTO as follows.

$$e_{r_i, r_j} = v_{r_i} v_{r_j} \in E^r \iff A^r[i, j] = 1 \quad (4)$$

This segregation of the graph into regional subgraphs reduces the complexity of the network in accordance with the node degrees, denoted as d_i :

$$d_{r_i} = \sum_{j \in V^r} A_r[i, j] \subseteq \sum_{j \in V} A[i, j] \quad (5)$$

Therefore, our framework encompasses the exploration of graph connectivity strategies, which can be categorized into three distinct approaches: (i) one connected graph, (ii) subgraphs characterized by random connections, and (iii) subgraphs constructed by the deliberate selection of nodes from regional clusters within states in the MAASTO. Consequently, our prediction task is now defined as follows.

$$\begin{aligned} [X_{t-K}, \dots, X_t; E; G] &= \sigma \bigcup^r [X_{r_{t-K+1}}, \dots, X_{r_t}; E^r; M^r] \\ &\rightarrow \bigcup^r [\hat{X}_{r_{t+1}}, \dots, \hat{X}_{r_{t+T}}] \end{aligned} \quad (6)$$

where σ represents a non-linear activation function such as ReLU and tanh.

B. Regional Temporal Graph Convolutional Network

Inspired by Attention Temporal Graph Convolutional Network (A3TGCN) [27], we built the Graph Neural Network, which incorporates the geographical relations in nodes integrating spatial and temporal aspects with regional graph inputs.

Algorithm 1 Algorithm overview of whole procedure

Require: $G = (X, E), r \geq 0, T \geq 0, K \geq 0$

for $t = 1$ to T **do**

$G_t = (X_t, E_t);$

for $k = 1$ to K **do**

$H_{t-k} \leftarrow \text{Structural GCN}(G_{t-k})$

$M_{t-k}^r \leftarrow \text{RD}(G_{t-k})$

for r in states in MAASTO **do**

$m_{t-k}^r \leftarrow \text{Spatial GCN}(M_{t-k}^r)$

end for

$\gamma_{t-k} \leftarrow \bigoplus_r m_{t-k}^r$

end for

$H_{t+1} \leftarrow \sum_{k=1}^K \alpha_k \text{Temporal}(H_{t-k}, \gamma_{t-k})$

$X_{t+1} \leftarrow \text{Decode}(H_{t+1})$

end for

Our model comprises two main components: a Graph Convolution Network (GCN) as a spatial module and a recurrent unit as a temporal module. GCN in the spatial convolution module handles the node's attributes, and a specialized GCN residing in Regional Decomposition compresses the spatial dependencies between sites by considering the distances between each pair of truck parking sites. Given the sequence of input timestamps $t \in \{1, 2, \dots, K\}$, the temporal model predicts site occupancy rates o up to T future time steps.

For each time step t , in the node embedding at a graph level, we consider \hat{A} as the adjacency matrix, wherein $\hat{A} = A + I_N$ with I_N being the identity matrix. Additionally, \hat{D} represents a diagonal degree matrix, and its elements are defined as $\hat{D}_{ii} = \sum_{j=0} \hat{A}_{ij}$ and the weight matrix is denoted as W . It demands H_{t+1} of the hidden vectors. Following the equation proposed by Kipf and Welling [21], this progression can be expressed as:

$$H_{t+1} = \sigma(\hat{D}^{-\frac{1}{2}} \hat{A} \hat{D}^{-\frac{1}{2}} H_t W_t) \quad (7)$$

To leverage the potential benefits of regional relationships, we introduce the Regional Decomposition technique. This involves the creation of subgraphs M while decomposing the original graph of truck parking site locations G . During each training step, the Regional Decomposition process distributes each node attribute η by regional relationships. This process leads to deriving independent vectors $\{m, \dots, m_N\} \in \mathbf{R}^{N \times E}$ with the number of features E .

Input graphs are sequentially aligned at every 10-minute interval and passed to spatial modules to extract the node features. Each feature represents regional graph structural information and nodes feature-based information within the regional context. Our whole algorithm is shown in Algorithm 1. Each GCN is applied to the regional graphs to extract spatial features as hidden vectors m . Subsequently, these vectors are concatenated, and the linear layer computes the hidden vector γ , which can be used in the temporal layers. These operations are performed iteratively for each time step.

Within the spatial module, two distinct categories of spatial models can be identified: the structural model and the model for node embeddings. The structural model serves as a means to comprehend the composition of graphs, while the spatial

model is employed to extract node attributes within temporal layers.

Formally, we arbitrarily collect the region of the nodes in G and enforce them to connect together as a graph M_r . On the subgraph networks, we can consider γ as a concatenated feature derived by the node embeddings spatial GCN denoted as

$$\gamma = \bigcup_{i=1}^r (m^i, e_{r_i}) \subseteq G \quad (8)$$

C. Temporal Module

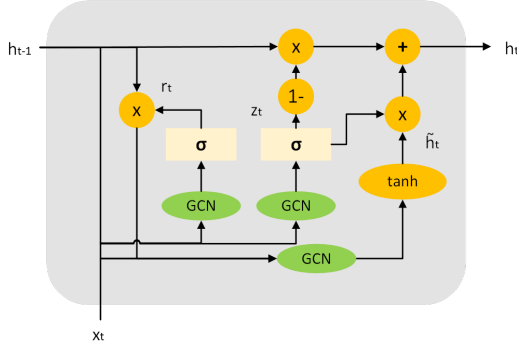

Figure 3. The architecture of GCN based GRU.

The temporal model is applied to acquire temporal dependencies with hidden vectors from the previous time step. To obtain the temporal dependencies of composed features, we constructed the GRU architecture using GCN, inspired by the baseline model [27]. This is the extension technique of Convolutional LSTM [28] to handle spatial dependencies into a temporal module. Figure 3 illustrates the architecture of GRU, which can accommodate the graph structure and composed features. Within this framework, activation function σ represents the sigmoid function, and parameters W correspond to the weights. The function $f(v_t, A_t)$ denotes the computation of graph convolutions at time step t , which is subsequently concatenated with input hidden vectors. Accordingly, the structural convolution function can be formally defined as follows:

$$f(v, A) = \sigma(W\eta_i + W \sum_k^{d_i} \eta_i^{(k)}) \quad (9)$$

Incorporating the structural formulas and temporal dependency function, our RegT-GCN formulation at the node level can be expressed as follows with the initial condition of $h_0 = \gamma_0$.

$$\begin{aligned} z_t &= \sigma(W_z f(v_t, A_t) \oplus h_{t-1}) \\ r_t &= \sigma(W_r f(v_t, A_t) \oplus h_{t-1}) \\ \tilde{h}_t &= \tanh(W f(v_t, A_t) \oplus (h_{t-1} \odot r_t)) \\ h_t &= (1 - z_t) \odot h_{t-1} + z_t \odot \tilde{h}_t \end{aligned} \quad (10)$$

where \oplus denotes the concatenation operation applied to the hidden vectors. This formulation enables the modeling of temporal dependencies and information propagation in the graph-based neural network.

D. Model Training

After iterating input time steps in the temporal module, they are all passed to the decoder, consisting of two linear layers and the ReLU activation function.

We also modified the attention vector α_t as an aggregation function with a simplified form to enhance the computational efficiency and in accordance with our experimental decision.

$$\alpha_t = \frac{\exp(\alpha_t)}{\sum_{s \in N(K) \setminus t} \exp(\alpha_s)} \quad (11)$$

Finally, the calculated hidden vectors are passed through the decoder to yield the predicted outputs for nodes at time step $t+1$, denoted X_{t+1} , and the hidden vector matrix is expressed as H_t .

$$\begin{aligned} X_{t+1} &= \text{ReLU}(H_t W^{(0)} + b^{(0)}) W^{(1)} + b^{(1)} \\ &= \text{ReLU}(\text{ReLU}(\alpha_t f(X_t, A_t) \oplus H_{t-1}) W^{(0)} \\ &\quad + b^{(0)}) W^{(1)} + b^{(1)} \end{aligned} \quad (12)$$

During the training process, the model is trained to minimize the discrepancy between the actual truck parking occupancy rates and predicted values across time steps. The model loss is then calculated using the target attribute, occupancy rates matrix O_t , employing the mean squared error criterion.

$$L = \frac{1}{n} \sum (O_t - \hat{O}_t)^2 \quad (13)$$

where n is the total number of parking sites and \hat{O}_t is the predicted occupancy rates matrix.

IV. EXPERIMENTS

This section explains data, data handling, other experiment settings, and the results. There are two perspectives of results, including truck parking usage prediction in different time horizons and the efficiency of graph connectivity regarding the model performance of Regional Decomposition. Discussion follows in the end.

A. Data Collection and Pre-processing

A collaborative effort among eight states in MAASTO led to the development of a real-time, multi-state Truck Parking Information Management System (TPIMS). Operational since 2019, the TPIMS data archival system (TPIMS-DAS) has archived over 100 million records of truck parking information (until October 2023).

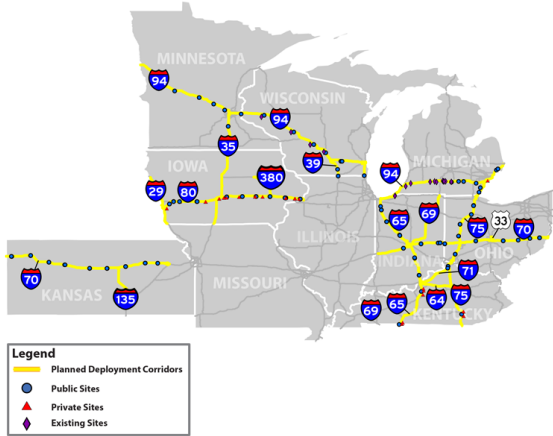

Figure 4. Spatial distribution of truck parking sites in eight states in MAASTO.

Figure 4 shows all truck parking sites in the MAASTO states and where we have collected parking data. Currently, TPIMS-DAS has archived data from 144 parking sites (public and private) of the eight participating MAASTO states. The number of current sites reporting data in each state is Iowa: 44, Illinois: 19, Kansas: 18, Kentucky: 13, Michigan: 14, Minnesota: 7, Ohio: 18, and Wisconsin: 11. About 160,000 parking records are archived in TPIMS-DAS daily; hence more than 1000 records per site on average. Due to maintenance periods in some sites and a lack of consequent data, we picked 105 sites for the graph construction and usage prediction.

Before applying our model, we handled the raw data in the appropriate format. We extracted dependent features from archived data following the formats in Table I. Week ID, day ID, and hour ID are dynamically changed, and other features are statically decided. These features were identity encoded and used as the input features of nodes. The occupancy rate is calculated using available data and capacity and the target feature of the model.

Edges are composed of two different sites, and with the characteristics of road networks, not all nodes are connected. To realize that, we selected the sites within 40 miles, which is approximately a 30-minute driving distance, and connected them for a single connected graph and regional subgraphs. The randomly connected graph used to train models connects all sites within the same group. Each edge has the actual driving distance as weights extracted from Bing Maps Locations API. One problem exists: data is collected in different frequencies. For this research, we used 10-minute frequency data, but some sites have higher data collection frequencies. Therefore, we interpolated the occupancy rate data, taking the average of two consecutive values to fill in the blank data. Other dynamic features were determined as the same number of previous values.

B. Evaluation Metrics

Usage prediction metrics compare predicted value and ground truth data statistics. They are computed using a root mean squared error (RMSE), mean absolute error (MAE),

Table I
FEATURE DESCRIPTIONS ON OUR DATASET.

Feature	Description
Week ID	Week ID labeled for each week from 1
Day ID	Day ID labeled for each day
Hour ID	Hour ID labeled for each hour (0-23)
Travel Time	Travel time from neighbor city to the site
Owner	1 if the public owner runs the site, and 0 for private
Amenity	The number of amenities (e.g., restrooms, handicap accessible, Wifi)
Capacity	The number of maximum availability of parking lots
Occupancy Rate	The percentage of used parking lots against capacity

and mean absolute percentage error (MAPE). We focused on the occupancy rates on every site, which is the parking usage divided by the full capacity. The distance between the predicted and ground truth value is interpreted as the prediction accuracy, and RMSE also considers the outliers by providing a large penalty.

$$\begin{aligned}
 \text{RMSE} &= \sqrt{\frac{1}{N} \sum_{n=1}^N \sum_{t=1}^T (x_{n_t} - \hat{x}_{n_t})^2} \\
 \text{MAE} &= \frac{1}{N} \sum_{n=1}^N \sum_{t=1}^T |x_{n_t} - \hat{x}_{n_t}| \\
 \text{MAPE} &= \frac{1}{N} \sum_{n=1}^N \sum_{t=1}^T \frac{|(x_{n_t} - \hat{x}_{n_t})|}{q_{95}(x_n)}
 \end{aligned} \tag{14}$$

N is the number of truck parking sites, and q_{95} is the 95th percentile of the approximate ground truth value as a "reference capacity" [23]. Due to the working time limitation and constraints of information distribution, over-usage of the maximum capacity is sometimes observed in some truck parking sites. Hence, we utilized the 95th percentile occupancy to represent each site's parking capacity.

C. Comparison Models

We compared our proposed framework, Regional Temporal GCN (RegT-GCN), with the following baseline methods: Stacked GRU, Stacked GCN [29], Temporal GCN (T-GCN) [27], Temporal Graph Convolution LSTM (LTGC) [30]. We also built the comparison methods for the ablation study: Convolution Stacked Temporal GCN (CST-GCN), Random Temporal GCN (RanT-GCN), and Regional Temporal GCN with LSTM (RegLT-GCN). They were all applied RMSProp and the learning rate is 10^{-3} with the decaying rate of 10^{-4} . Input channels are 8 for all models, and output channels are 512 for LSTM, T-GCN, and LTGC and 256 for the other models.

- **Stacked GRU** is a model deliberating temporal dependencies. Empirically, two layers of GRU perform better than one or three layers in this task setting.
- **Stacked GCN** is a model deliberating spatial dependencies. The model composes two layers of GCN [29].
- **T-GCN** is composed of GRU as a temporal module with attention based aggregation named Attention Temporal GCN (A3T-GCN) on its spatial module [27].

Table II
THE COMPARISON OF PREDICTION RESULTS USING BASELINE AND OUR MODELS ON THE TRUCK PARKING DATASET WITH DIFFERENT TIME HORIZONS (DISPLAYED IN MINUTES).

Models/Metrics	Time Horizons (10/30/120/360)											
	RMSE				MAE				MAPE			
Baselines												
Stacked GRU	0.116	0.134	0.165	0.177	0.090	0.105	0.128	0.138	12.48	14.97	17.84	17.54
Stacked GCN [29]	0.114	0.120	0.131	0.159	0.088	0.093	0.099	0.123	12.23	13.18	14.10	16.74
T-GCN [27]	0.101	0.115	0.138	0.164	0.076	0.089	0.107	0.127	11.08	12.78	15.28	17.25
LTGC [30]	0.105	0.098	0.130	0.158	0.082	0.072	0.082	0.122	11.25	10.05	13.65	16.60
Ours												
CST-GCN	0.150	0.179	0.183	0.199	0.117	0.140	0.142	0.156	16.56	19.84	19.65	21.04
RanT-GCN	0.089	0.095	0.119	0.151	0.064	0.068	0.088	0.115	9.12	9.57	12.39	15.93
RegT-GCN	0.086	0.094	0.120	0.150	0.062	0.067	0.088	0.114	8.76	9.36	12.43	15.68

- **LTGC** is based on Chebyshev Graph Convolutional Long Short Term Memory Cell [30] with 2 for Chebyshev filter size and the symmetric normalization.
- **CST-GCN** applies multiple convolution layers sequentially to input nodes and compares the performance of the vector concatenation. Each calculated hidden vector is inputted to the next convolution layers, a total of five layers, the same as five convolutions for regions in RanT-GCN and RegT-GCN.
- **RanT-GCN** is analogous to DropEdge [31], which applied random edge sampling on the graph to make several subgraphs. Most modules are the same as RegT-GCN but use random connected graphs as input subgraphs.
- **RegT-GCN** uses A3T-GCN for the spatial module and GRU for the temporal module. Input subgraphs are created with Regional Decomposition.

D. Truck Parking Usage Prediction

Table II demonstrates the performance comparison among different models. Firstly, Stacked GCN predicted better than Stacked GRU, which indicates the spatial model learns better representations of truck parking sites than the temporal model. Longitudinally, Stacked GRU lowered its performance than Stacked GCN since the temporal model highly depends on the predicted time horizons. Next, most spatio-temporal models resulted in better accuracy, especially in shorter time horizons compared to Stacked GRU and Stacked GCN. At longer time horizons, the result of Stacked GCN predicted better or closer accuracy to spatio-temporal models, while Stacked GRU and T-GCN performance degraded the prediction accuracy.

In the ablation study of the Regional Decomposition module, RanT-GCN and RegT-GCN surpassed the baseline models in most of the prediction time horizons. Within these two, decomposing a graph regionally achieved the best accuracy of all. CST-GCN predicted the lowest accuracy; hence, the stack of convolution layers doesn't prove the model's superiority over the models integrated with the decomposition technique.

Figure 5 (a) and (b) illustrate the comparison of the models trained on connected graphs, randomly decomposed graphs, and regionally decomposed graphs on one specific truck parking site. In the graph, 1.0 indicates that the parking lots are fully occupied. In the figure, T-GCN predicted higher occupancy rates in both observations. The prediction results of RegT-GCN and RanT-GCN are analogous to the ground truth results, which also adequately predicted the intense usages. Meanwhile, RanT-GCN predicted the values in tendencies of fewer fluctuations than RegT-GCN. There is no significant difference in observed patterns between the results of the original model and the model generalization.

Similarly, Figure 5 (c) and (d) show the prediction results of future truck parking usage for an adequately long time horizon (6 hours). In the figure, the accuracy of each model is lower than the outcomes of a time horizon of 30. Specifically, T-GCN with a connected graph has the lowest prediction capability in both results and has tendencies to predict lower occupancy rates. Both RanT-GCN and RegT-GCN captured the usage characteristics except for the intense usage, which proves that graph decomposition can also be effective in longer horizons such that the truck drivers can schedule their route before their working time. Moreover, RegT-GCN predicted closer occupancy rates to the ground truth.

E. Models Generality

To assess the generalizability of the models, we selected additional weeks for the test sequences and conducted inference experiments with the pre-trained models. Table III summarizes the results of RMSE, MAE, and MAPE to evaluate the model's predictive accuracy. In the table, every model generalizes its predictive abilities to other locations except for CST-GCN.

Further analysis reveals that the RanT-GCN and RegT-GCN consistently outperformed the baseline models across various time horizons, indicating their superior predictive capabilities. Remarkably, even when baseline models exhibit lower performance than the original prediction results, models with

Table III
THE GENERALITY COMPARISON OF PREDICTION RESULTS USING BASELINE AND OUR MODELS ON THE TRUCK PARKING DATASET WITH DIFFERENT TIME HORIZONS (DISPLAYED IN MINUTES).

Models/Metrics	Time Horizons (10/30/120/360)											
	RMSE				MAE				MAPE			
Baselines												
Stacked GRU	0.119	0.129	0.167	0.177	0.095	0.100	0.130	0.138	12.33	13.27	16.78	17.54
Stacked GCN [29]	0.114	0.127	0.129	0.164	0.088	0.096	0.098	0.128	12.23	12.71	12.83	16.34
T-GCN [27]	0.097	0.109	0.129	0.171	0.072	0.083	0.099	0.135	9.76	11.12	13.05	17.15
LTGC [30]	0.114	0.102	0.139	0.172	0.092	0.078	0.110	0.136	11.95	10.13	14.04	17.24
Ours												
CST-GCN	0.192	0.195	0.193	0.195	0.150	0.152	0.151	0.153	19.61	19.83	19.53	19.39
RanT-GCN	0.087	0.093	0.116	0.148	0.063	0.067	0.087	0.114	8.42	8.84	11.29	14.52
RegT-GCN	0.085	0.092	0.117	0.148	0.061	0.066	0.087	0.113	8.12	8.73	11.30	14.46

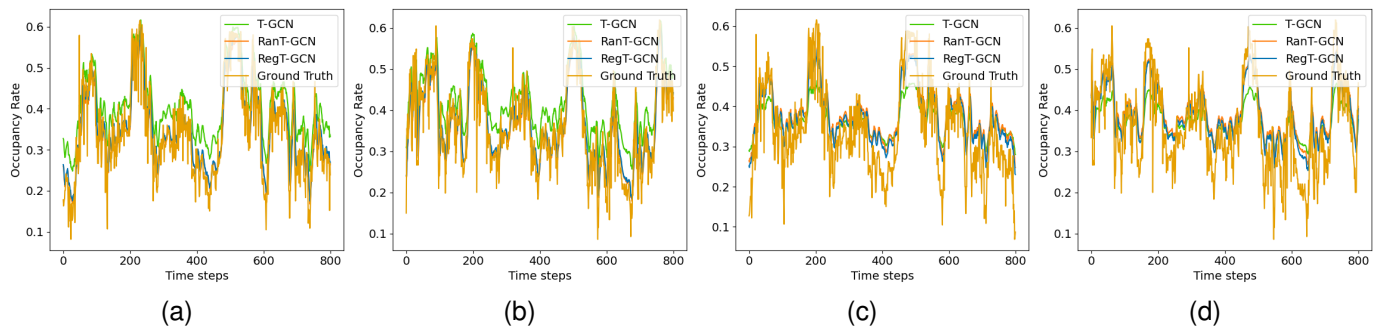

Figure 5. Results on Regional Decomposition for the time horizon of 30 (a and b) and 360 (c and d).

integrated decomposition techniques maintain their efficacy in providing accurate and generalizable inferences. These findings underscore the consistent and superior performance of the Regional Decomposition in predictive accuracy, regardless of the time horizon under consideration.

F. Discussion

The efficiency of our models in terms of their ability to achieve superior performance stems from a reduced number of overlaps among reference nodes. Specifically, in a connected graph with self-loops, each node is calculated $n * l$ times, where n expresses the number of nodes and l represents the number of neighboring nodes. However, these overlaps hinder the learning of the graph structure since a node requires more computation to refer to more nodes. In contrast, our model addresses this issue by creating subgraphs and reducing the overlap to $(v/r) * l$ for each spatial module, where r denotes the number of subgraphs. As a result, the model can now prioritize the crucial truck parking feature in the region through simple calculations.

From the experiment results, it is evident that the Regional Decomposition technique outperforms both the connected and randomly connected graph configurations. Also, when compared to CST-GCN, the RegT-GCN demonstrates a significant

performance advantage. This suggests that the concatenation of hidden vectors plays a crucial role in sharing subgraph features, highlighting the importance of employing graph neural networks in conjunction with pre-clustering graphs for superior performance. As a potential future research, we propose exploring the concept of decomposing by highway functions, which relates closer to truck drivers' behaviors.

According to the analysis of previous research [12], truck drivers tend to use consecutive parking spaces when one of them is fully occupied. Consequently, considering cooperative node interactions within regions yields better outcomes. Hence, the competitive performance of the Regional Decomposition approach in comparison to a single connected graph indicates that our framework can achieve strong performance simply by decomposing the input graph.

In our future research, we will investigate the limits of information preservation on our models by incorporating deeper layers and exploring the potential for extending prediction time horizons to their maximum allowable limits. Furthermore, we acknowledge that the relatively inferior results observed in longer time horizons may stem from limitations in computation power for handling larger training datasets. Therefore, we anticipate that utilizing larger training datasets will yield performance improvements for our models.

Lastly, it is necessary to design an end-to-end framework capable of automatically decomposing graphs and integrating spatio-temporal modules for inductive scenarios. This will enable us to apply the models to previously unseen graphs, such as those outside the scope of participating states in MAASTO while maintaining consistent and robust performance. These future directions hold the potential to further advance the capabilities and applicability of our proposed framework.

V. CONCLUSION

In this paper, we propose the Regional Temporal Graph Neural Network (RegT-GCN), a state-wide truck parking usage prediction framework, leveraging topological structures of truck parking site distributions. The RegT-GCN comprises a Regional Decomposition approach to learn the geographical characteristics efficiently and a spatio-temporal module to capture the temporal dependencies on graphs. Experiments using the field data show that the proposed models outperform other baseline models. Decomposed graphs into regional oriented subgraphs result in better prediction capability and consistency of inferences. The study also encompasses a demonstration of predicting usages through the empirical observation of non-informative loss, facilitated by the integration of the Gated Recurrent Unit module, which adeptly adapts to value fluctuations. Through extensive experiments focused on graph connectivity, this paper validates that incorporating regional relationships substantially enhances the comprehension of the structural dynamics within truck parking site location graphs.

REFERENCES

- [1] C. Boris and R. Brewster, "A comparative analysis of truck parking travel diary data," *Transportation Research Record*, vol. 2672, no. 9, pp. 242–248, 2018. [Online]. Available: <https://journals.sagepub.com/doi/10.1177/0361198118775869>
- [2] FHWA, "Jason's law truck parking survey results and comparative analysis." Available at https://ops.fhwa.dot.gov/freight/infrastructure/truck_parking/jasons_law/truckparkingsurvey/jasons_law.pdf, 2015, accessed: 2022-04-01.
- [3] S. B. Smith, W. Baron, K. Gay, and G. Ritter, "Intelligent transportation systems and truck parking," U.S. Department of Transportation Research and Special Programs Administration Volpe National Transportation Systems Center, Washington, DC, Tech. Rep. FMCSA-RT-05-001, Feb 2005.
- [4] T. J. Gates, P. T. Savolainen, T. K. Datta, R. G. Todd, and S. Boileau, "Evaluating the appropriate level of service for michigan rest areas and welcome centers considering safety and economic factors," Wayne State University, Detroit, MI, Tech. Rep. OR10-045, Apr 2012.
- [5] T. H. Maze, C. P. Albrecht, and O. Smadi, "Mn/dot truck parking study: Phase 2," Minnesota Department of Transportation, Tech. Rep. MN/RC 2010-34, Nov 2010.
- [6] MAASTO, "Maasto truck parking survey analysis," Mid America Association of State Transportation Officials, Tech. Rep., May 2018. [Online]. Available: <https://trucksparkehere.com/wp-content/uploads/2018/09/Phase-2-MAASTO-Truck-Parking-Survey-Report-OnlineVersion.pdf>
- [7] KSDOT, "Maasto regional truck parking fact sheet," Mid America Association of State Transportation Officials, Tech. Rep., Oct 2016, accessed: 2022-03-22. [Online]. Available: https://www.ksdot.gov/Assets/wwwksdotorg/bureaus/burRail/Rail/Documents/TPIMS_Summary.pdf
- [8] D. Moore, G. Ivy, B. Comer, M. DeMent, M. Junak, and C. Miller, "Creating a roadmap for successfully planning, implementing, and administering complex multi-jurisdictional transportation technology projects," *Transportation Research Record*, vol. 2673, no. 6, pp. 764–770, 2019.
- [9] B. A. Sadek, E. W. Martin, and S. A. Shaheen, "Forecasting truck parking using fourier transformations," *Journal of Transportation Engineering, Part A: Systems*, vol. 146, no. 8, p. 05020006, 2020.
- [10] H. Yang, C. Liu, Y. Zhuang, W. Sun, K. Murthy, Z. Pu, and Y. Wang, "Truck parking pattern aggregation and availability prediction by deep learning," *IEEE Transactions on Intelligent Transportation Systems*, vol. 23, no. 8, pp. 12 778–12 789, 2022.
- [11] Y. Cheng, S. Rau, A. Srivastava, S. Li, S. T. Parker, E. Perry, S. S. Ahn, and D. A. Noyce, *Data Archiving and Performance Measurement for a Multi-State Truck Parking Information Management System (TPIMS)*, pp. 251–260. [Online]. Available: <https://ascelibrary.org/doi/abs/10.1061/9780784484876.043>
- [12] R. Tamaru, Y. Cheng, S. Parker, E. Perry, B. Ran, and S. S. Ahn, *Web Portal Development and Site Usage Pattern Analysis for a Multi-State Truck Parking Information Management System (TPIMS)*, 2023, pp. 489–500. [Online]. Available: <https://ascelibrary.org/doi/abs/10.1061/9780784484876.043>
- [13] M. E. Bayraktar, F. Arif, H. Ozen, and G. Tuxen, "Smart parking-management system for commercial vehicle parking at public rest areas," *Journal of Transportation Engineering*, vol. 141, no. 5, p. 04014094, 2015.
- [14] K. Haque, S. Mishra, R. Paleti, M. M. Golias, A. A. Sarker, and K. Pujats, "Truck parking utilization analysis using gps data," *Journal of Transportation Engineering, Part A: Systems*, vol. 143, no. 9, p. 04017045, 2017.
- [15] F. Vital, P. Ioannou, and A. Gupta, "Survey on intelligent truck parking: Issues and approaches," *IEEE Intelligent Transportation Systems Magazine*, vol. 13, no. 4, pp. 31–44, 2021.
- [16] T. Rajabioun and P. A. Ioannou, "On-street and off-street parking availability prediction using multivariate spatiotemporal models," *IEEE Transactions on Intelligent Transportation Systems*, vol. 16, no. 5, pp. 2913–2924, 2015.
- [17] H. Tavafoghi, K. Poolla, and P. Varaiya, "A queuing approach to parking: Modeling, verification, and prediction," 2019. [Online]. Available: <https://arxiv.org/abs/1908.11479>
- [18] Z. Zhao and Y. Zhang, "A comparative study of parking occupancy prediction methods considering parking type and parking scale," *Journal of Advanced Transportation*, vol. 2020, 2020.
- [19] C. Zheng, B. Zong, W. Cheng, D. Song, J. Ni, W. Yu, H. Chen, and W. Wang, "Robust graph representation learning via neural sparsification," in *Proceedings of the 37th International Conference on Machine Learning*, ser. Proceedings of Machine Learning Research, H. D. III and A. Singh, Eds., vol. 119. PMLR, 13–18 Jul 2020, pp. 11 458–11 468. [Online]. Available: <https://proceedings.mlr.press/v119/zheng20d.html>
- [20] R. Low, Z. D. Tekler, and L. Cheah, "Predicting commercial vehicle parking duration using generative adversarial multiple imputation networks," *Transportation Research Record*, vol. 2674, no. 9, pp. 820–831, 2020.
- [21] T. N. Kipf and M. Welling, "Semi-supervised classification with graph convolutional networks," in *International Conference on Learning Representations*, 2017. [Online]. Available: <https://openreview.net/forum?id=SJU4ayYgl>
- [22] W. Jiang and J. Luo, "Graph neural network for traffic forecasting: A survey," *Expert Systems with Applications*, p. 117921, 2022.
- [23] S. Yang, W. Ma, X. Pi, and S. Qian, "A deep learning approach to real-time parking occupancy prediction in transportation networks incorporating multiple spatio-temporal data sources," *Transportation Research Part C: Emerging Technologies*, vol. 107, pp. 248–265, 2019. [Online]. Available: <https://www.sciencedirect.com/science/article/pii/S0968090X18313780>
- [24] W. Zhang, H. Liu, Y. Liu, J. Zhou, and H. Xiong, "Semi-supervised hierarchical recurrent graph neural network for city-wide parking availability prediction," *Proceedings of the AAAI Conference on Artificial Intelligence*, vol. 34, no. 01, pp. 1186–1193.
- [25] D. Luo, W. Cheng, W. Yu, B. Zong, J. Ni, H. Chen, and X. Zhang, "Learning to drop: Robust graph neural network via topological denoising," in *Proceedings of the 14th ACM International Conference on Web Search and Data Mining*, ser. WSDM '21. New York, NY, USA: Association for Computing Machinery, 2021, p. 779–787. [Online]. Available: <https://doi.org/10.1145/3437963.3441734>
- [26] NCHRP, "Dealing with truck parking demands," in *A Synthesis of Highway Practice*, 2003.
- [27] J. Bai, J. Zhu, Y. Song, L. Zhao, Z. Hou, R. Du, and H. Li, "A3t-gcn: Attention temporal graph convolutional network for traffic forecasting," *ISPRS International Journal of Geo-Information*, vol. 10, no. 7, p. 485, 2021.
- [28] X. Shi, Z. Chen, H. Wang, D.-Y. Yeung, W.-k. Wong, and W.-c. WOO, "Convolutional lstm network: A machine learning approach for precipitation nowcasting," in *Advances in Neural Information*

Processing Systems, C. Cortes, N. Lawrence, D. Lee, M. Sugiyama, and R. Garnett, Eds., vol. 28. Curran Associates, Inc., 2015. [Online]. Available: <https://arxiv.org/abs/1506.04214>

- [29] M. Defferrard, X. Bresson, and P. Vandergheynst, "Convolutional neural networks on graphs with fast localized spectral filtering," *Advances in neural information processing systems*, vol. 29, 2016.
- [30] Y. Seo, M. Defferrard, P. Vandergheynst, and X. Bresson, "Structured sequence modeling with graph convolutional recurrent networks," in *Neural Information Processing: 25th International Conference, ICONIP 2018, Siem Reap, Cambodia, December 13-16, 2018, Proceedings, Part I 25*. Springer, 2018, pp. 362–373.
- [31] Y. Rong, W. Huang, T. Xu, and J. Huang, "Dropedge: Towards deep graph convolutional networks on node classification," *arXiv preprint arXiv:1907.10903*, 2019.

VI. BIOGRAPHY SECTION



Rei Tamaru received his Bachelor of Arts degree in Information Science from International Christian University, Tokyo, Japan, in 2019. He received a Master of Philosophy in Transdisciplinary Sciences from Japan Advanced Institute of Science and Technology in 2021. He is currently a Ph.D. student in Civil and Environmental Engineering at the University of Wisconsin-Madison. His research directions are intelligent transportation systems, connected automated vehicles, and traffic simulations.

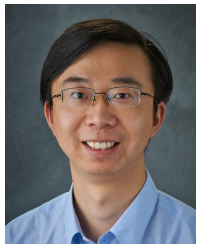

Yang Cheng received the B.S. and M.S. degrees in automation from Tsinghua University, Beijing, China, in 2004 and 2006, respectively, and the Ph.D. degree in civil engineering from the University of Wisconsin-Madison in 2011. He is currently a scientist at the Wisconsin Traffic Operations and Safety (TOPS) Laboratory of the University of Wisconsin-Madison (UW). His research areas include automated highway and driving systems, mobile traffic sensor modeling, large-scale transportation data management and analytics, and traffic operations and

control. .



Steven T. Parker is the Managing Director of the Wisconsin Traffic Operations and Safety (TOPS) Laboratory at the University of Wisconsin-Madison. In this capacity, he has led a range of research and development initiatives for the TOPS Lab across several core areas including transportation safety, work zone systems, traffic management systems, and connected and automated vehicle technologies. Dr. Parker has over 25 years of professional experience in applied research computing with the last two decades working on transportation systems

and technology issues in collaboration with the Wisconsin Department of Transportation (WisDOT) and other agency partners. Prior to joining the TOPS Lab, Dr. Parker received a Ph.D. in Computer Science from the University of Wisconsin-Madison. He is currently serving in his second term as the Chair of the Transportation Research Board (TRB) AED30 Information Systems and Technology Committee



Ernie Perry is the senior researcher and facilitator at the Mid America Freight Coalition (MAFC). He directs the multimodal freight policy, programming, and operation research and collaboration for the 10 states of the Mid America Association of State Transportation Officials. He is an expert in multimodal freight systems and planning, multimodal freight operations, economic development, and multistate collaboration. Perry has completed over 30 projects with the Coalition in a wide range of areas including truck parking, truck electrification, marine planning, aviation planning and economic impacts, freight data, over size and over dimension loads, multistate freight planning, and the value of multimodal freight movements.



Bin Ran is the Vilas Distinguished Achievement Professor and Director of ITS Program at the University of Wisconsin, Madison. He is an expert in dynamic transportation network models, traffic simulation and control, traffic information system, Internet of Mobility, Connected Automated Vehicle Highway (CAVH) System. He has led the development and deployment of various traffic information systems and the demonstration of CAVH systems. He is the author of two leading textbooks on dynamic traffic networks. He has co-authored more than 240 journal papers and more than 260 referenced papers at national and international conferences. He holds more than 20 patents of CAVH in the US and other countries. He is an associate editor of Journal of Intelligent Transportation Systems.

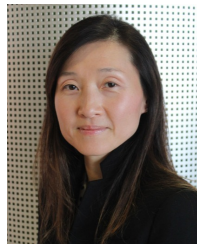

Soyoung (Sue) Ahn is a professor in civil and environmental engineering at the University of Wisconsin-Madison and an executive director of the Mid America Freight Coalition (MAFC). Her recent research involves (i) analysis and modeling of traffic flow mixed with connected autonomous vehicles (CAVs), (ii) development of CAV platoon control strategies, (iii) development of system control strategies using CAVs, and (iv) freight transportation planning. She is a Senior Editor for IEEE Transactions on ITS, and an Associate Editor for Transportation Research Part C and Transportation Research Record. She also serves as an editorial board editor for Transportation Research Part B. She is a chair of the Operations Section of Transportation Research Board and an elected member of the International Advisory Committee for the International Symposium on Traffic and Transportation Theory..