

# Q&A Prompts: Discovering Rich Visual Clues through Mining Question-Answer Prompts for VQA requiring Diverse World Knowledge

Haibo Wang, Weifeng Ge✉

School of Computer Science, Fudan University

22210240289@m.fudan.edu.cn, wfg@fudan.edu.cn

## Abstract

With the breakthrough of multi-modal large language models, answering complex visual questions that demand advanced reasoning abilities and world knowledge has become a much more important testbed for developing AI models than ever. However, equipping AI models with robust cross-modality reasoning ability remains challenging since the cognition scheme of humans has not been understood systematically. In this paper, we believe that if we can collect visual clues in the given image as much as possible, we will recognize the image more accurately, understand the question better, recall relevant knowledge more easily, and finally reason out the answer. We discover these rich visual clues by mining question-answer pairs in images and sending them into multi-modal large language models as prompts. We call the proposed method Q&A Prompts. Specifically, we first use the image-answer pairs and the corresponding questions in the training set as inputs and outputs to train a visual question generation model. Then, we use an image tagging model to identify various instances and send packaged image-tag pairs into the visual question generation model to generate relevant questions with the extracted image tags as answers. Finally, we encode these generated question-answer pairs as prompts with a visual-aware prompting module and send them into pre-trained multi-modal large language models to reason out the final answers. Experimental results show that, compared with state-of-the-art methods, our Q&A Prompts achieves substantial improvements on the challenging visual question answering datasets requiring reasoning over diverse world knowledge, such as OK-VQA and A-OKVQA.

## 1. Introduction

The Visual Question Answering (VQA) problem has long-standing been considered a Visual Turing Test [11] in the

✉ Corresponding Author. Codes will be released after review

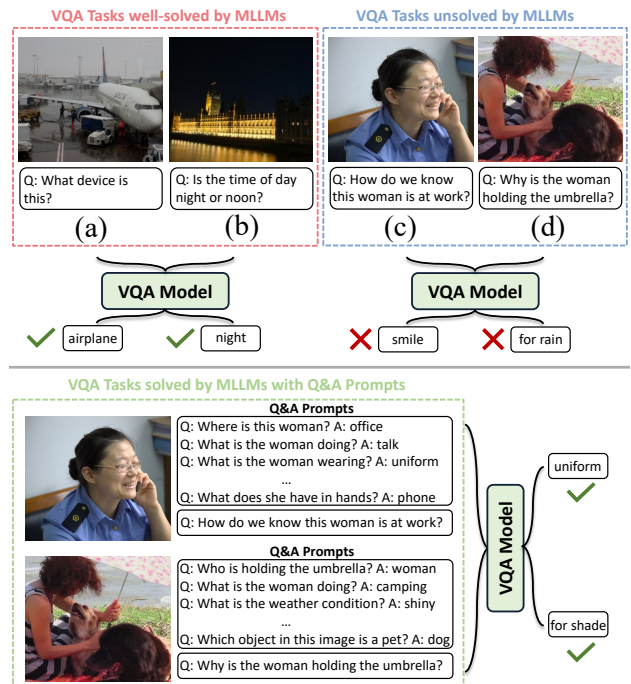

Figure 1. Illustration of VQA tasks that require simple perception abilities and "closed" knowledge ((a) and (b)) and those demanding chains of reasoning over diverse world knowledge ((c) and (d)). (e) indicates MLLMs with Q&A prompts can solve difficult VQA problems that require diverse world knowledge.

machine learning community. To solve this Turing test, artificial intelligence (AI) models are expected to be equipped with the human capabilities of visual recognition, language understanding, logical reasoning, world knowledge referring, etc. There are a variety of datasets focused on different problems in VQA, such as works in [3, 12] studied the perception and language understanding problem, works in [21] studied reasoning on procedurally generated images, and some other works studied structured factual knowledge [46, 47] or commonsense knowledge [50]. Recently, with the advent of multi-modal large language

models (MLLMs) [6, 24, 28, 49], significant progress has been achieved in perception-based VQA tasks [3, 12] and "closed" knowledge-based VQA tasks [46, 47]. Fig. 1 (a) and Fig. 1 (b) show such VQA tasks, which can be reliably solved by MLLMs.

However, for more complex VQA tasks [34, 40] as in Fig. 1 (c) and Fig. 1 (d), that feature the necessity of diverse world knowledge and complex chains of reasoning, state-of-the-art models [13, 18, 27] even MLLM methods [6, 24] fail to give the correct answers. Different from perception-based VQA in [3, 12] and "closed" knowledge-based VQA in KB-VQA [46] or FVQA [47], real-world visual question reasoning in OK-VQA [34] and A-OKVQA [40], requires not only diverse forms of world knowledge but also need complex reasoning logic. In Fig. 1 (d), where a woman sits on the ground with her pet dogs and holds an umbrella, the question is [Why is the woman holding the umbrella?]. Simply associating the keyword [umbrella] with the word [rain] due to their frequent co-occurrence in the pre-training corpus [7] will lead to the wrong answer. AI models need to consider all visual clues presented, including the people, the pets, the sunshine, and the grass, to associate the keyword [umbrella] in the question with the weather conditions and ongoing activities to arrive at the answer [for shade]. This evidence indicates that collecting as many visual clues as possible is necessary to achieve good results.

Based on the analysis above, we believe that collecting visual clues of various instances in images will help MLLM recognize the image more accurately, understand the question better, recall relevant knowledge more easily, and finally generate the reasoning results more intelligently. To investigate this hypothesis, we design a novel VQA framework called *Q&A Prompts*, which extracts numerous question-answer pairs associated with different perspectives in images as prompts for MLLMs to perform reasoning. For each Q&A prompt, we choose an instance in the given image as the answer and generate the related question to form a question-answer pair. We generate the question-answer prompts for almost every instance to get a bag of Q&A prompts. The reason we choose question-answer pairs as prompts comes from two folds: First, Q&A prompts can focus on diverse instances in images like objects, scenes, or actions, thereby offering multiple different perspectives to understand the given image and the target question; Second, the knowledge and reasoning insights hidden in these question-answer pairs can help to explicitly uncover more relevant world knowledge, which may be critical to bridging the logic gap between perception and reasoning when answering the target question.

In *Q&A Prompts*, there are three key stages, which are the visual question generation (VQG) model training stage, the question-answer prompts generation stage, and

the visual-language reasoning stage. In the VQG model training stage, we gather question-answer pairs in a VQA training set to train a VQG model that can map an answer together with the given image to a correlated question. Subsequently, in the question-answer prompts generation stage, we leverage a pre-trained image tagging model [19, 52] to recognize various objects, scenes, and actions in images with text tags. We employ these tags as answers and send them into the VQG model along with the corresponding images to generate questions. Finally, in the visual-language reasoning stage, we encode the generated question-answer pairs with a visual-aware prompting module and send them together with image and question features into a frozen language model to reason out the answer. Since previous VQA benchmark datasets [3, 12] have seen saturated performance, we conduct experiments on the more challenging OK-VQA [34] and A-OKVQA [40] datasets, which are newer and larger testbeds for MLLM to investigate their abilities in accomplishing reasoning tasks requiring diverse world knowledge. Experimental results show the generated *Q&A Prompts* improve the reasoning ability of MLLM, such as BLIP-2 [24] and InstructBLIP [6], substantially.

In summary, we make the following key contributions:

- We propose a novel VQA framework that effectively generates and leverages question-answer pairs as prompts to improve the reasoning ability of multi-modal large language models. It provides a new perspective for the community to design VQA solutions by explicitly collecting rich visual clues to bridge the logic gap between perception and reasoning when answering the target question.
- We design a novel question-answer prompts generation scheme with a VQG model and an image tagging model, which can generate Q&A prompts for all recognizable objects, scenes, and activities in images. Besides, we design a new visual-aware prompting module to encode these prompts efficiently for the subsequent reasoning process.
- We test the proposed method on the challenging OK-VQA [34] and A-OKVQA [40] benchmarks, which study reasoning over diverse forms of world knowledge, including fact-based knowledge, commonsense knowledge, physics knowledge, and visual knowledge. The proposed *Q&A Prompts* achieves an accuracy of **68.1%** and **64.3%** on A-OKVQA [40] and OK-VQA [34], outperforming previous methods by clear margins.

## 2. Related Work

**Multimodal Large Language Models.** Multimodal Large Language Models (MLLMs) [2, 6, 23, 24, 33, 49, 51, 54] have shown strong ability in image-language understanding, context comprehension, and logical reasoning. MLLMs typically achieve this by adapting frozen language models to frozen image encoders with trainable connection modules. For instance, Flamingo [2] incorporates visual

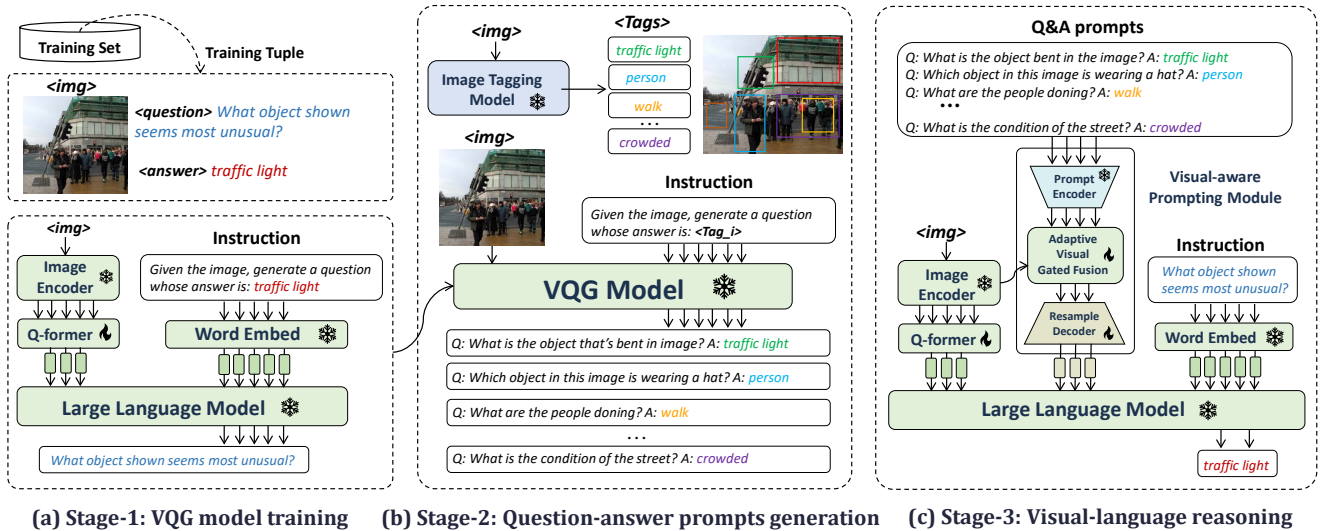

Figure 2. (a) Firstly, we train a VQG model that can ask informative questions given the image and specified answer. (b) Then, we exploit the image tagging model to extract image tags as the answers to generated questions and obtain diverse question-answer prompts. (c) At last, we feed the image, question, and question-answer prompts into the VQA model to perform visual-language reasoning in (c).

features into a language model with multiple cross-attention blocks to perform visual language reasoning. LLaVA [28], instead, directly projects visual features into the space of text embeddings using a linear layer. BLIP-2 and Instruct-BLIP [6, 24] introduce a more complex Q-Former to bridge the gap between the embedding spaces of different modalities. These cross-modality models align images and language based on large-scale image-text pairs [5, 9, 25] and conduct reasoning with language models. In this paper, we mine more visual clues from images to generate numerous question-answer pairs and send them into a multimodal large language model as prompts. These prompts provide rich visual information and uncover relevant world knowledge, which is beneficial to reasoning out correct answers.

**Visual Question Answering Requiring Reasoning over Diverse World Knowledge.** Different from classical VQA tasks [3, 12, 46, 47], VQA tasks requiring reasoning over world knowledge involve inferring intents, goals, the physics of the world, and the social dynamics of individuals from image inputs. More recently, the A-OKVQA [40] and OK-VQA [34], which our work focuses on, present large-scale challenging VQA datasets that encompass questions requiring reasoning based on diverse world knowledge, including visual knowledge, commonsense knowledge, and factoid knowledge. Previous works like Img2LLM [14], Prophet [41], and PromptCap [17] exploit the rich hidden knowledge and strong reasoning abilities of large language models (e.g., GPT3 [4]) to solve such problems. These methods convert images into natural languages and construct various prompt templates for large language models with in-context learning [4] to generate answers. Another

group of works, such as KAT [13], REVIVE [27], and REVEAL [18], directly encode questions and relevant knowledge retrieved from external knowledge bases [4, 43, 45] to train end-to-end models. Unlike these methods, we design a visual-question prompts generation scheme to mine the information in images and unambiguous words to reduce confusion when answering the target questions. With Q&A prompts, different types of world knowledge, such as visual knowledge, fact-based knowledge, human behavior knowledge, and physics knowledge, are incorporated into the reasoning process to help infer the correct answers.

### 3. Method

We apply the proposed method *Q&A Prompts* on the challenging A-OKVQA [40] and OKVQA [34], since they are the most recent benchmarks that contain reasoning tasks covering a wide range of world knowledge. Our *Q&A Prompts* is a conceptually simple three-stage framework, and Fig. 2 gives an overview of the proposed method.

Our pipeline contains three stages: a VQG model training stage, a question-answer prompts generation stage, and a visual-language reasoning stage. Specifically, in the VQG model training stage shown in Fig. 2 (a), we train a vanilla MLLM with a broad range of image-answer pairs as input and the corresponding question as the target output to learn a mapping from answers to questions (detailed in Sec. 3.1). In the prompts generation stage (shown in Fig. 2 (b)), we exploit an image tagging model [19, 52] to obtain relevant tags including attributes, objects, actions, and scenes in images. These tags serve as answers and will be fed into the VQG model trained in the first stage to generate diverse questions

containing rich visual clues and world knowledge (detailed in Sec. 3.2). In the final reasoning stage shown in Fig. 2 (c), we utilize our proposed visual-aware prompting module to encode these question-answer pairs into prompts, which will be fed into the MLLM such as BLIP-2 [24] or Instruct-BLIP [6] together with the image and the target question, to make a prediction of the answer (detailed in Sec. 3.3). The whole pipeline is flexible and effective in mining informative visual clues to correctly answer the given questions.

### 3.1. Stage-1: Train the VQG Model

*Q&A Prompts* requires a strong VQG model to produce meaningful questions beneficial for reasoning. Given an image  $\mathcal{V}$  and answer  $\mathcal{A}$ , the VQG model is responsible for posing an informative question  $\mathcal{Q}$  which can be properly answered by  $\mathcal{A}$ . In order to explore as many visual clues in the generated questions as possible for further reasoning, and avoid generating general questions containing limited clues (e.g., "What is in this picture?"), we utilize the datasets of A-OKVQA [40] or OK-VQA [34] as the training set  $D$  for our VQG model, since the questions in their annotations are diverse and specific, covering broader areas of knowledge such as commonsense knowledge, visual knowledge, and factoid knowledge. To create the VQG model that approximates  $P(\mathcal{Q}|\mathcal{V}, \mathcal{A})$ , we treat the problem of learning such a model as a text-generation problem and wish to train the MLLM (e.g., InstructBLIP [6]) as our VQG model with  $D$  due to its strong image-language reasoning ability.

Specifically, as shown in Fig. 2 (a), the VQG model comprises a frozen image encoder, a trainable alignment module, and a frozen LLM. We extract image embeddings  $\mathbf{E}_v \in \mathbb{R}^{n \times d_v}$  of  $\mathcal{V}$  with the image encoder ( $n$  is the patch number,  $d_v$  is the embedding dimension), and then feed  $\mathbf{E}_v$  into the alignment module (a Qformer [24] here) to obtain fixed-length visual features  $\mathbf{F}_v \in \mathbb{R}^{k \times d_q}$ , which will be sent into the LLM together with the instruction. We write the instruction as the template containing the answer  $\mathcal{A}$ , such as "Given the image, generate a question whose answer is:  $\langle \mathcal{A} \rangle$ ". The VQG model is trained using the cross-entropy loss function with parameters  $\theta$ :

$$\mathcal{L}_{\mathcal{V}Q\mathcal{G}} = - \sum_{t=1}^{L_q} \log P_{\theta}(Q_t | Q_{<t}, \mathcal{V}, \mathcal{A}) \quad (1)$$

where  $Q_t$  is predicted autoregressively at position  $t$ , and  $L_q$  is the sequence length of the ground truth question  $Q$ .

We emphasize the necessity of training the VQG model to obtain the questions, instead of prompting a frozen MLLM without training. We give examples in Fig. 3 (a). Similar to the style of the questions in A-OKVQA (green), the VQG model can propose more specific questions (blue) with rich visual clues, instead of general questions with limited information by prompting MLLM without training (orange). Besides, in Fig. 3 (b), we use sentence-bert [39] to

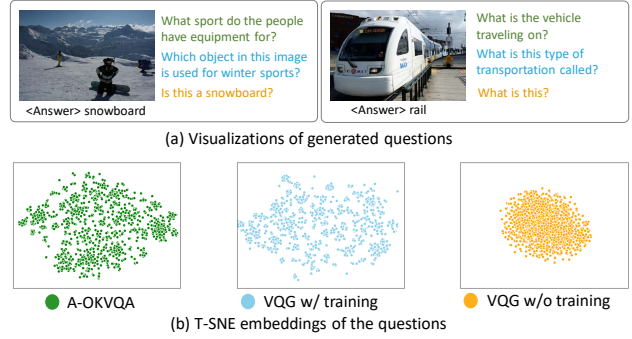

Figure 3. Visualizations and T-SNE embedding distributions of the questions in A-OKVQA (green), and the questions generated by our VQG model after training (blue) or before training (orange).

obtain the dense embedding vectors of each question and show the distributions of T-SNE [44] embedding of them. The questions generated by our VQG model are more diverse like questions in A-OKVQA, while the questions generated by MLLM without training are limited with low differentiation, and our experiments will verify this.

### 3.2. Stage-2: Generate Question-Answer Prompts

Once the VQG model has been obtained, the generation of question-answer pairs can proceed. In this stage, we will explicitly generate a wide range of question-answer pairs to help the model have a deeper and broader understanding of the image before further reasoning. In order to generate diverse questions covering various perspectives of the image, we should ensure the answers fed into the VQG model are sufficient in varied forms. Therefore, we adopt a strong image tagging model [19, 52] to produce rich tags as answers. Different from object detectors that can only recognize limited object labels, image tagging models aim to identify various open-vocabulary elements in images, including attributes, objects, actions, scenes, etc, which can provide an appropriate source of the answers we need.

We utilize the RAM [52] model as our image tagging model due to its superior recognition ability. As shown in Fig. 2 (b), we feed the image  $\mathcal{V}$  into the tagging model and obtain various tags for each image. To make the tags of each image more distinguishable, we remove the most frequent ones containing general information, such as 'person', 'food', 'man', etc., resulting in an average of 14 tags per image. We denote this set of tags as  $\mathcal{O} = \{o_i\}_{i=1}^M$ , where  $M$  is the number of tags associated with an image.

Using these tags as answers, we input them into the trained VQG model along with the image, as shown in Fig. 2 (b), to obtain corresponding questions that answer these tags. To ensure that the generated questions (denoted as  $\mathcal{T} = \{t_i\}_{i=1}^M$ ) contribute effectively to answering the target question, we rank the generated questions  $\mathcal{T} = \{t_i\}_{i=1}^M$

based on their similarity with the target question  $Q$ , and adopt the questions with the Top-P similarities as the final obtained question prompts  $\mathcal{U}$ :

$$\mathcal{U} = \{u_p\}_{p=1}^P = \arg \text{Top-P} \langle T(t_i), T(Q) \rangle \quad (2)$$

where  $T(\cdot)$  represents the sentence embedding model [39], which encodes natural language into embedding vectors for similarity computation. The  $\langle \cdot, \cdot \rangle$  operator is the inner product, computing the cosine similarity between two sentences. We then concatenate each  $u_i$  in  $\mathcal{U}$  and its corresponding  $o_i$  in  $\mathcal{O}$  using the template "Question:  $\langle u_i \rangle$  Answer:  $\langle o_i \rangle$ ", resulting in the final question-answer pairs as prompts  $\mathcal{S}$ .

### 3.3. Stage-3: Reasoning with Q&A Prompts

After obtaining these question-answer pairs involving rich visual clues and world knowledge, we use the proposed visual-aware prompting module, as shown in Fig. 4, to encode these question-answer pairs into a set of prompt embeddings  $\mathbf{F}_p \in \mathbb{R}^{k \times d_q}$  for our VQA model. We still utilize the same MLLM (e.g., InstructBLIP [6]) as our VQA model for the final reasoning. As in Fig. 2 (c), the encoded prompt embeddings  $\mathbf{F}_p$  will be fed into the frozen LLM in MLLM, together with the instruction embeddings and visual features  $\mathbf{F}_v$  to predict the answer  $\mathcal{A}$ :

$$\mathcal{A} = \text{LLM}([\mathbf{F}_v; \mathbf{F}_p; \text{Embed}(\text{Ins})]) \quad (3)$$

Here, Embed is the word embedding layer in LLM, the operator  $[\cdot]$  means concatenation, and Ins is the instruction including the target question  $Q$ , represented as "Question:  $\langle Q \rangle$ ? Answer: ". We then will introduce how the visual-aware prompting module bootstrapped the reasoning ability of the VQA model within our Q&A Prompts.

**Prompt Encoder.** The prompt encoder is responsible for obtaining the semantics representations of the prompts  $\mathcal{S}$ . Specifically, we choose standard encoder-based language models as our prompt encoder due to their strong ability in language understanding. To preserve the well-trained representations, we keep the parameters of the prompt encoder frozen. We feed the prompts  $\mathcal{S}$  into the prompt encoder and get the encoded representations  $\mathbf{F}_s \in \mathbb{R}^{L_s \times d_q}$ , where  $L_s$  is the sequence length of question-answer prompts and  $d_q$  is the hidden size of the prompt encoder.

**Visual Gated Fusion.** Since the output  $\mathbf{F}_s$  from the prompt encoder is an unimodal language representation, to fully utilize the explicit information in images, the visual gated fusion adaptively incorporates image information into this representation with the visual embeddings  $\mathbf{E}_v \in \mathbb{R}^{n \times d_v}$ . Specifically, shown in Fig. 4, we use a single-head attention mechanism, similar to MM-COT [53], to correlate the language representation with the visual embeddings. We define the query, key and value as  $\mathbf{Q} = \mathbf{F}_s \in \mathbb{R}^{L_s \times d_q}$ ,

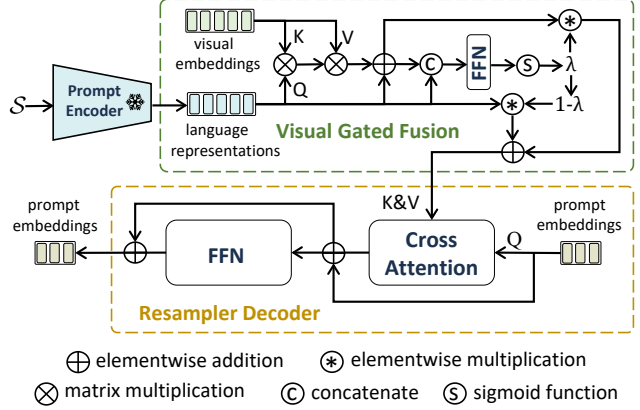

Figure 4. Overview of our visual-aware prompting module, with visual embeddings  $\mathbf{E}_v$  and Q&A prompts  $\mathcal{S}$  as inputs, consisting of the prompt encoder, visual gated fusion, and resampler decoder.

$\mathbf{K} = \mathbf{V} = \text{MLP}(\mathbf{E}_v) \in \mathbb{R}^{n \times d_q}$ , where MLP here is projecting  $d_v$  to  $d_q$ . The attention output  $\mathbf{F}_v^{attn}$  is defined as:

$$\mathbf{F}_v^{attn} = \mathbf{Q} + \text{Softmax}\left(\frac{\mathbf{Q}\mathbf{K}^T}{\sqrt{d_q}}\right)\mathbf{V}, \quad \mathbf{F}_v^{attn} \in \mathbb{R}^{L_s \times d_q} \quad (4)$$

Next, we apply the gated fusion mechanism to merge  $\mathbf{F}_s$  and  $\mathbf{F}_v^{attn}$ . The fused representation  $\mathbf{F}_m \in \mathbb{R}^{L_s \times d_q}$  is obtained using the following equations:

$$\begin{aligned} \lambda &= \text{Sigmoid}(\mathbf{F}_s \mathbf{W}_s + \mathbf{F}_v^{attn} \mathbf{W}_v) \\ \mathbf{F}_m &= (1 - \lambda)\mathbf{F}_s + \lambda\mathbf{F}_v^{attn} \end{aligned} \quad (5)$$

in which  $\mathbf{W}_s$  and  $\mathbf{W}_v$  are learnable parameters. The gated fusion allows the model to adaptively blend the information from the language representation and visual embeddings, resulting in the multimodal representations  $\mathbf{F}_m$ .

**Resampler Decoder.** Although  $\mathbf{F}_m \in \mathbb{R}^{L_s \times d_q}$  in Eq. (5) is the multimodal representations of  $\mathcal{S}$ , we cannot directly concatenate it with the visual features  $\mathbf{F}_v$  and instruction embeddings as in Eq. (3) due to the long sequence length of  $L_s$ , which can result in extra memory and computational burden, as well as the distraction to target question  $Q$ . In light of this, we employ a lightweight resampler decoder inspired by Perceiver [20], to map  $\mathbf{F}_m \in \mathbb{R}^{L_s \times d_q}$  into smaller-sized prompt embeddings  $\mathbf{F}_p \in \mathbb{R}^{k \times d_q}$  with fixed length  $k$ , where  $k \ll L_s$  (e.g.,  $k = 32$  and  $L_s \geq 100$ ).

Concretely, we additionally introduce the learnable embeddings  $\mathbf{F}_p \in \mathbb{R}^{k \times d_q}$  to interact with  $\mathbf{F}_m$ . As shown in Fig. 4, a cross-attention layer is applied by taking  $\mathbf{F}_p$  as query, and  $\mathbf{F}_m$  as key and value, followed with a feed-forward network, to generate prompt embeddings loaded with the multimodal representations from  $\mathbf{F}_m$ :

$$\begin{aligned} \mathbf{F}_p &= \text{Cross-Attention}(\mathbf{F}_p, \mathbf{F}_m) + \mathbf{F}_p \\ \mathbf{F}_p &= \text{FFN}(\mathbf{F}_p) + \mathbf{F}_p, \quad \mathbf{F}_p = \text{MLP}(\mathbf{F}_p) \end{aligned} \quad (6)$$

where MLP projects  $d_q$  to  $d_{lm}$  (the hidden size of LLM).

At last, the final output of  $\mathbf{F}_p \in \mathbb{R}^{k \times d_q}$  will be fed into the LLM together with the question instruction embeddings and visual features as in Eq. (3), to make predictions of answers. The model is trained using the cross-entropy loss function with trainable parameters  $\theta$ :

$$\mathcal{L}_{VQA} = - \sum_{t=1}^{L_a} \log P_{\theta}(\mathcal{A}_t | \mathcal{A}_{<t}, \mathcal{V}, \mathcal{Q}, \mathcal{S}) \quad (7)$$

where  $\mathcal{A}_t$  is predicted autoregressively at position  $t$ , and  $L_a$  is the sequence length of the ground truth answer text  $\mathcal{A}$ .

## 4. Experiments

### 4.1. Dataset

We evaluate our *Q&A Prompts* on the challenging A-OKVQA [40] and OK-VQA [34] since they are currently the largest VQA datasets requiring complex reasoning over diverse world knowledge. Specifically, the A-OKVQA dataset consists of 24,903 samples, with 17.1k samples for training, 1.1k for validation, and 6.7k for testing. The questions in this dataset require reasoning over various types of world knowledge, such as commonsense knowledge, factoid knowledge, and visual knowledge. The OK-VQA dataset includes 14k questions covering a variety of knowledge categories, with 9k samples for training, and 5k for validation. Each sample in these two datasets includes an image, a question, and 10 ground-truth answers. We use the soft accuracy [3] as the standard evaluation metric.

### 4.2. Implementation Details

We use the InstructBLIP [6] as our default MLLM, to both generate question-answer prompts and perform answer predictions. Besides, RAM [52] is utilized as the image tagging model due to its strong recognition ability. To configure the visual-aware prompting module, we use the text encoder in CLIP [38] as our prompt encoder, and a value of 32 of the  $k$  for the number of prompt embeddings  $\mathbf{F}_p \in \mathbb{R}^{k \times d_q}$ , the same as the number of visual tokens  $\mathbf{F}_v \in \mathbb{R}^{k \times d_q}$ . We train the models using AdamW [30] as the optimizer with a learning rate of  $2e^{-5}$  and the strategy of mixed precision training. It is important to note that the parameters of the image encoder, the large language model, and the prompt encoder are kept frozen to maintain their pre-trained representations.

### 4.3. Main Results

**Comparison with SoTAs.** The results in Tab. 1 demonstrate the superiority of our proposed *Q&A Prompts*. We have a significant improvement over existing SoTAs, achieving an accuracy of 69.4% on the validation set and 68.1% on the test set in A-OKVQA, and an accuracy of 64.3% in OK-VQA. We also observe that *Q&A Prompts*

achieves a greater improvement on A-OKVQA (+5.4% and +6.0%) compared to OK-VQA (+2.2%). This can be explained that: different from questions in OK-VQA that heavily rely on external knowledge, the questions in A-OKVQA emphasize visually-grounded reasoning with a comprehensive understanding of the image with diverse visual clues, rather than external knowledge retrieval. This aligns with *Q&A Prompts*'s philosophy, that is, instead of relying on accessing any external knowledge base such as Wikipedia [45], ConceptNet [43], or GPT3 [4], our focus is on enhancing reasoning capabilities by discovering rich visual clues hidden in the image and model.

**Different baselines.** To further validate the effectiveness of our method, we conduct experiments to compare various models, as shown in Tab. 2. These models differ mainly in their large language models, and InstructBLIP models have undergone instruction tuning based on the pre-trained BLIP-2 models. The results show that using a stronger baseline model leads to better performance, and our *Q&A Prompts* method consistently improves performance on the validation set of A-OKVQA by approximately 4.2% to 5.7%, demonstrating the effectiveness and generalizability of *Q&A Prompts* across different vision-language models.

**Qualitative results.** In Figure 5, we present qualitative results to gain a clearer insight into our *Q&A Prompts*. These cases demonstrate scenarios where correct answers are only possible with our question-answer prompts. For instance, the important clues provided by our Q&A Prompts of the [mirror], [constructor], [cloudy] and [bible], lead to the successful reasoning of correct answers [bathroom], [visibility], [raining], and [getting married] respectively. This showcases the valuable contribution of the question-answer prompts in certain types of tasks, which can explicitly mine rich visual clues and diverse world knowledge hidden in the image to help the model reason out the correct answers.

### 4.4. Ablation Study

We investigate the role of question-answer prompts and the visual-aware prompting module based on the InstructBLIP-Vicuna-7B and the A-OKVQA dataset.

**Different training sets for generated questions.** We investigate how the VQG model will influence the performance by directly prompting the MLLM without training, or using different training sets to train our VQG model, including the A-OKVQA, OK-VQA, and a mixture of them. We report the Rouge-L score for the generated questions. Results in Tab. 3 show that performance declines severely when using Q&A prompts generated by MLLMs without training. Besides, the best performance is only achieved when the corresponding dataset is utilized as the training set, and a mismatch or mixture of datasets could lead to a slightly weaker performance. This could be attributed to the

Method	Image Representation	Knowledge Source	OK-VQA (%)	A-OKVQA (%)	
				Val	Test
ViLBERT [31]	Feature	Pretrain	-	30.6	25.9
GPV-2 [22]	Feature	Pretrain	-	48.6	40.7
Unified-IO [32]	Feature	Pretrain	54.0	-	45.2
Flamingo (80B) [2]	Feature	Pretrain	57.8	-	-
BLIP-2 (7B)[24]	Feature	Pretrain	59.3	60.0	58.7
ConceptBERT [10]	Feature	NumberBatch + ConceptNet	33.7	-	-
KRISP [35]	Feature	Wikipedia + ConceptNet	38.9	33.7	22.1
UnifER [15]	Feature	ConceptNet	42.1	-	-
REVEAL [18]	Feature	WIT + Wikidata	59.1	-	52.2
RA-VQA-v2 [26]	Feature	Google Search	62.1	-	-
PICa [48]	Caption + Tags	Frozen GPT-3 (175B)	48.0	-	-
KAT [13]	Caption + Feature	Wikidata + GPT3 (175B)	53.1	-	-
Img2LLM [14]	Caption	Frozen GPT-3 (175B)	-	42.9	40.7
REVIVE [27]	Caption + Feature	Wikidata + GPT3 (175B)	56.6	-	-
PromptCap [17]	Caption	Frozen GPT-3 (175B)	60.4	56.3	59.6
Prophet [41]	Caption + Tags	Frozen GPT-3 (175B)	61.1	58.2	61.1
InstructBLIP (7B) [6]	Feature	Pretrain	62.1	64.0	62.1
+ Q&A Prompts	Feature	Pretrain	<b>64.3 (+2.2)</b>	<b>69.4 (+5.4)</b>	<b>68.1 (+6.0)</b>

Table 1. Results of A-OKVQA [40] and OK-VQA [34] comparing to standard baselines show that our method achieves state-of-the-art performance, outperforming previous methods by a large margin. The **best** results are highlighted.





			
<b>Question:</b> Which room in the house is this man in?	<b>Question:</b> Why are the men's vests orange?	<b>Question:</b> What problem will the people on the ferry face?	<b>Question:</b> Why are the two holding hands in front of the people?
<b>Image Tags:</b> mirror, sink, reflection, tile wall, tie, bathroom accessory, stare, faucet, cabinet	<b>Image Tags:</b> constructor, train, safety vest, train track, passenger, railroad, railway station, platform	<b>Image Tags:</b> cloudy, travel, ferry, barge, sail, waterway, boat, vessel, float, water, city	<b>Image Tags:</b> bible, veil, hand, couple, groom, ceremony, wedding, father, bride, newlywed, church
<b>Q&amp;A Prompts:</b> Q: What is the man looking at? A: mirror Q: What is the man washing his hands at? A: sink ... Q: Where are the bathroom accessory placed? A: cabinet	<b>Q&amp;A Prompts:</b> Q: What job does the man in the orange vest have? A: constructor Q: What is the yellow and black vehicle on the picture? A: train ... Q: What is the area where the train is located? A: platform	<b>Q&amp;A Prompts:</b> Q: What type of weather is it? A: cloudy Q: What is the purpose of the orange and white boat? A: travel ... Q: Where are these boats in? A: city	<b>Q&amp;A Prompts:</b> Q: What is the man in black suit holding? A: bible Q: What is the woman wearing on her head? A: veil ... Q: What kind of building is this? A: church
<b>Predictive Answer:</b> InstructBLIP: bedroom BLIP-2: bedroom Ours: bathroom <b>Ground Truth:</b> bathroom	<b>Predictive Answer:</b> InstructBLIP: fashion BLIP-2: working Ours: visibility <b>Ground Truth:</b> visibility	<b>Predictive Answer:</b> InstructBLIP: sickness BLIP-2: fall into water Ours: raining <b>Ground Truth:</b> raining	<b>Predictive Answer:</b> InstructBLIP: praying BLIP-2: praying Ours: getting married <b>Ground Truth:</b> getting married

Figure 5. Representative cases with our Q&A Prompts. We denote the question, tags, Q&A prompts, predictive answers, and ground truth respectively. Our Q&A Prompts can discover rich visual clues in the image and reason out the correct answer.

Models	Accuracy (%)
BLIP-2 (FLAN-T5-XL)	57.6
+ <i>Q&amp;A Prompts</i>	61.8 (+4.2)
InstructBLIP (FLAN-T5-XL)	58.5
+ <i>Q&amp;A Prompts</i>	64.2 (+5.7)
InstructBLIP (Vicuna-7B)	64.0
+ <i>Q&amp;A Prompts</i>	69.4 (+5.4)

Table 2. Comparison of performance with different BLIP models in the validation set of A-OKVQA.

w/ Q&A	Training Set	Rouge-L	A-OKVQA (%)	OK-VQA (%)
✗	-	-	64.0	62.1
✓	-	-	61.9	61.0
✓	A-OKVQA	90.8	<b>69.4</b>	62.9
✓	OK-VQA	92.4	67.1	<b>64.3</b>
✓	Mixture	89.4	68.7	63.9

Table 3. Ablation studies on training sets for VQG model training.

Fusion strategy	Accuracy (%)	Text Encoder	Accuracy (%)
Prepend	64.0	CLIP	<b>69.4</b>
+ Caption	64.2	DeBERTa	69.1
+ Q&A	66.6	RoBERTa	68.9
VPM + Q&A	<b>69.4</b>	BERT	68.6

Table 4. Ablation studies on strategies of fusing question-answer pairs.

Table 5. Ablation studies on using different language models as the prompt encoder.

#Num. of Q&A	Accuracy (%)
4	68.9
8	<b>69.4</b>
16	69.2

Table 6. Ablation studies on using different numbers of question-answer pairs as the Q&A prompts.

Variants.	Accuracy (%)
VPM	<b>69.4</b>
w/o Fusion	68.6
w/o Decoder	68.1

Table 7. Ablation studies on the effect of different components in our visual-aware prompting module.

domain gap in the question types of these datasets.

**Strategies of fusing question-answer pairs.** We explore a simple approach where we directly prepend the question-answer pairs as a natural language to the instruction without our visual-aware prompting module (VPM). For comparison, we also replace the question-answer pairs with image captions generated by BLIP-2 [24]. The results in Tab. 4 show that the incorporation of question-answer prompts is more effective than pure captions, and both directly prepending the question-answer pairs and using the VPM can improve performance. Notably, the models with VPM perform much better, which we attributed to its ability to combat some noise in the generated question-answer pairs and avoid interference with the target question.

**Different choices for the prompt encoder.** We experimented with various pre-trained language models (text encoder in CLIP [38], BERT [8], DeBERTa [16], RoBERTa [29]) as the prompt encoder for question-answer prompts  $\mathcal{S}$ . The results, shown in Tab. 5, indicate that language models pre-trained by contrastive learning [38] with image-text

pairs perform better than those pre-trained with text-only corpus by masked language modeling [8]. This result is consistent with previous findings [36, 42], which suggest that models initialized with CLIP [38] are more suitable for vision-language tasks due to their shared understanding of the visual and textual content.

**The number of the question-answer prompts.** We also study to figure out the effect of using different numbers of question-answer pairs to construct the Q&A Prompts. The results are displayed in Tab. 6. We denote the desired number as  $P$ . It can be observed that when  $P$  is set to 8, the model achieves optimal performance. We can deduce that when  $P$  is too large, it may introduce noisy pairs, while a too small  $P$  can result in an ignorance of many essential and informative question-answer pairs.

**Components in visual-aware prompting module.** We validate the key components of our visual-aware prompting module in Tab. 7. We first study the effectiveness of removing the visual gated fusion (w/o fusion), which induces severe performance decline. Such performance drop is expected, since the unimodal language representations tend to involve ambiguity and bias. The additional incorporation of visual embeddings effectively allows for multi-modal interaction beneficial for vision-language reasoning. We also evaluate the importance of the resampler decoder (w/o decoder), where we directly feed the long sequence  $\mathbf{F}_m \in \mathbb{R}^{L_s \times d_q}$  into the large language model in Eq. (3) and also caused a performance drop. The sequence length of target question  $L_q$  is  $\times 10$  times smaller than the sequence length  $L_s$  of prompts  $\mathcal{S}$  ( $L_q \leq 10$ ,  $L_s \geq 100$  here), resulting in a distraction to the understanding of the target question. This highlights the importance of resampling  $\mathbf{F}_m \in \mathbb{R}^{L_s \times d_q}$  into a shorter  $\mathbf{F}_p \in \mathbb{R}^{k \times d_q}$  ( $k = 32$  here).

## 5. Conclusions and Limitations

This paper has formally studied the problem of discovering rich visual clues with question-answer prompts in VQA tasks requiring reasoning over diverse world knowledge. We introduce a novel framework, *Q&A Prompts*, which effectively generates a set of question-answer prompts and encodes them with a visual-aware prompting module, significantly boosting the reasoning ability of current vision-language models. We conducted a series of experiments on the A-OKVQA and OK-VQA benchmarks and achieved significant results compared with previous methods. Extensive ablations and comprehensive analyses have demonstrated the effectiveness and superiority of our method.

**Limitations.** While our method shows promising results, it is essential to acknowledge the potential presence of biases in the data as observed in previous VQA studies [1, 7], as well as the lack of the ability for counting and OCR. We plan to mitigate these biases and weaknesses to enhance the reasoning ability of current models further.



## References

- [1] Aishwarya Agrawal, Dhruv Batra, Devi Parikh, and Anirudha Kembhavi. Don't just assume; look and answer: Overcoming priors for visual question answering. In *CVPR*, 2018. [8](#)
- [2] Jean-Baptiste Alayrac, Jeff Donahue, Pauline Luc, Antoine Miech, Iain Barr, Yana Hasson, Karel Lenc, Arthur Mensch, Katherine Millican, Malcolm Reynolds, et al. Flamingo: a visual language model for few-shot learning. In *NeurIPS*, 2022. [2](#), [7](#)
- [3] Stanislaw Antol, Aishwarya Agrawal, Jiasen Lu, Margaret Mitchell, Dhruv Batra, C Lawrence Zitnick, and Devi Parikh. Vqa: visual question answering. In *ICCV*, 2015. [1](#), [2](#), [3](#), [6](#)
- [4] Tom Brown, Benjamin Mann, Nick Ryder, Melanie Subbiah, Jared D Kaplan, Prafulla Dhariwal, Arvind Neelakantan, Pranav Shyam, Girish Sastry, Amanda Askell, et al. Language models are few-shot learners. In *NeurIPS*, 2020. [3](#), [6](#)
- [5] Soravit Changpinyo, Piyush Sharma, Nan Ding, and Radu Soricut. Conceptual 12m: Pushing web-scale image-text pre-training to recognize long-tail visual concepts. In *CVPR*, 2021. [3](#)
- [6] Wenliang Dai, Junnan Li, Dongxu Li, Anthony Meng Huat Tiong, Junqi Zhao, Weisheng Wang, Boyang Li, Pascale Fung, and Steven Hoi. Instructblip: Towards general-purpose vision-language models with instruction tuning. *arXiv preprint arXiv:2305.06500*, 2023. [2](#), [3](#), [4](#), [5](#), [6](#), [7](#)
- [7] Corentin Dancette, Remi Cadene, Damien Teney, and Matthieu Cord. Beyond question-based biases: Assessing multimodal shortcut learning in visual question answering. In *ICCV*, 2021. [2](#), [8](#)
- [8] Jacob Devlin, Ming-Wei Chang, Kenton Lee, and Kristina Toutanova. Bert: Pre-training of deep bidirectional transformers for language understanding. In *NAACL*, 2019. [8](#)
- [9] Leo Gao, Stella Biderman, Sid Black, Laurence Golding, Travis Hoppe, Charles Foster, Jason Phang, Horace He, Anish Thite, Noa Nabeshima, et al. The pile: An 800gb dataset of diverse text for language modeling. *arXiv preprint arXiv:2101.00027*, 2020. [3](#)
- [10] François Gardères, Maryam Ziaeefard, Baptiste Abeloos, and Freddy Lecue. ConceptBert: Concept-aware representation for visual question answering. In *EMNLP*, 2020. [7](#)
- [11] Donald Geman, Stuart Geman, Neil Hallonquist, and Laurent Younes. Visual Turing test for computer vision systems. *Proceedings of the National Academy of Sciences*, 112(12): 3618–3623, 2015. [1](#)
- [12] Yash Goyal, Tejas Khot, Douglas Summers-Stay, Dhruv Batra, and Devi Parikh. Making the v in vqa matter: Elevating the role of image understanding in visual question answering. In *CVPR*, 2017. [1](#), [2](#), [3](#)
- [13] Liangke Gui, Borui Wang, Qiuyuan Huang, Alex Hauptmann, Yonatan Bisk, and Jianfeng Gao. Kat: A knowledge augmented transformer for vision-and-language. In *NAACL*, 2022. [2](#), [3](#), [7](#)
- [14] Jiaxian Guo, Junnan Li, Dongxu Li, Anthony Meng Huat Tiong, Boyang Li, Dacheng Tao, and Steven CH Hoi. From images to textual prompts: Zero-shot vqa with frozen large language models. In *CVPR*, 2023. [3](#), [7](#)
- [15] Yangyang Guo, Liqiang Nie, Yongkang Wong, Yibing Liu, Zhiyong Cheng, and Mohan Kankanhalli. A unified end-to-end retriever-reader framework for knowledge-based vqa. In *ACM MM*, 2022. [7](#)
- [16] Pengcheng He, Xiaodong Liu, Jianfeng Gao, and Weizhu Chen. Deberta: Decoding-enhanced bert with disentangled attention. *arXiv preprint arXiv:2006.03654*, 2020. [8](#)
- [17] Yushi Hu, Hang Hua, Zhengyuan Yang, Weijia Shi, Noah A Smith, and Jiebo Luo. Promptcap: Prompt-guided task-aware image captioning. *arXiv preprint arXiv:2211.09699*, 2022. [3](#), [7](#)
- [18] Ziniu Hu, Ahmet Iscen, Chen Sun, Zirui Wang, Kai-Wei Chang, Yizhou Sun, Cordelia Schmid, David A Ross, and Alireza Fathi. Reveal: Retrieval-augmented visual-language pre-training with multi-source multimodal knowledge memory. In *CVPR*, 2023. [2](#), [3](#), [7](#)
- [19] Xinyu Huang, Youcai Zhang, Jinyu Ma, Weiwei Tian, Rui Feng, Yuejie Zhang, Yaqian Li, Yandong Guo, and Lei Zhang. Tag2text: Guiding vision-language model via image tagging. *arXiv preprint arXiv:2303.05657*, 2023. [2](#), [3](#), [4](#)
- [20] Andrew Jaegle, Sebastian Borgeaud, Jean-Baptiste Alayrac, Carl Doersch, Catalin Ionescu, David Ding, Skanda Koppula, Daniel Zoran, Andrew Brock, Evan Shelhamer, et al. Perceiver io: A general architecture for structured inputs & outputs. In *ICLR*, 2022. [5](#)
- [21] Justin Johnson, Bharath Hariharan, Laurens Van Der Maaten, Li Fei-Fei, C Lawrence Zitnick, and Ross Girshick. Clevr: A diagnostic dataset for compositional language and elementary visual reasoning. In *Proceedings of the IEEE conference on computer vision and pattern recognition*, pages 2901–2910, 2017. [1](#)
- [22] Amita Kamath, Christopher Clark, Tanmay Gupta, Eric Kolve, Derek Hoiem, and Aniruddha Kembhavi. Webly supervised concept expansion for general purpose vision models. In *ECCV*, 2022. [7](#)
- [23] Bo Li, Yuanhan Zhang, Liangyu Chen, Jinghao Wang, Jingkang Yang, and Ziwei Liu. Otter: A multi-modal model with in-context instruction tuning. *arXiv preprint arXiv:2305.03726*, 2023. [2](#)
- [24] Junnan Li, Dongxu Li, Silvio Savarese, and Steven Hoi. Blip-2: Bootstrapping language-image pre-training with frozen image encoders and large language models. In *ICML*, 2023. [2](#), [3](#), [4](#), [7](#), [8](#)
- [25] Tsung-Yi Lin, Michael Maire, Serge Belongie, James Hays, Pietro Perona, Deva Ramanan, Piotr Dollár, and C Lawrence Zitnick. Microsoft coco: common objects in context. In *ECCV*, 2014. [3](#)
- [26] Weizhe Lin, Jinghong Chen, Jingbiao Mei, Alexandru Coca, and Bill Byrne. Fine-grained late-interaction multi-modal retrieval for retrieval augmented visual question answering. In *NeurIPS*, 2023. [7](#)
- [27] Yuanze Lin, Yujia Xie, Dongdong Chen, Yichong Xu, Chengguang Zhu, and Lu Yuan. Revive: Regional visual representation matters in knowledge-based visual question answering. In *NeurIPS*, 2022. [2](#), [3](#), [7](#)

- [28] Haotian Liu, Chunyuan Li, Qingyang Wu, and Yong Jae Lee. Visual instruction tuning. In *NeurIPS*, 2023. 2, 3
- [29] Yinhan Liu, Myle Ott, Naman Goyal, Jingfei Du, Mandar Joshi, Danqi Chen, Omer Levy, Mike Lewis, Luke Zettlemoyer, and Veselin Stoyanov. Roberta: A robustly optimized bert pretraining approach. *arXiv preprint arXiv:1907.11692*, 2019. 8
- [30] Ilya Loshchilov and Frank Hutter. Decoupled weight decay regularization. In *ICLR*, 2019. 6
- [31] Jiasen Lu, Dhruv Batra, Devi Parikh, and Stefan Lee. Vilbert: Pretraining task-agnostic visiolinguistic representations for vision-and-language tasks. In *NeurIPS*, 2019. 7
- [32] Jiasen Lu, Christopher Clark, Rowan Zellers, Roozbeh Mottaghi, and Aniruddha Kembhavi. Unified-io: A unified model for vision, language, and multi-modal tasks. *arXiv preprint arXiv:2206.08916*, 2022. 7
- [33] Gen Luo, Yiyi Zhou, Tianhe Ren, Shengxin Chen, Xiaoshuai Sun, and Rongrong Ji. Cheap and quick: Efficient vision-language instruction tuning for large language models. *arXiv preprint arXiv:2305.15023*, 2023. 2
- [34] Kenneth Marino, Mohammad Rastegari, Ali Farhadi, and Roozbeh Mottaghi. Ok-vqa: A visual question answering benchmark requiring external knowledge. In *CVPR*, 2019. 2, 3, 4, 6, 7, 1
- [35] Kenneth Marino, Xinlei Chen, Devi Parikh, Abhinav Gupta, and Marcus Rohrbach. Krisp: Integrating implicit and symbolic knowledge for open-domain knowledge-based vqa. In *CVPR*, 2021. 7
- [36] Jack Merullo, Louis Castricato, Carsten Eickhoff, and Ellie Pavlick. Linearly mapping from image to text space. In *ICLR*, 2023. 8
- [37] Jae Sung Park, Chandra Bhagavatula, Roozbeh Mottaghi, Ali Farhadi, and Yejin Choi. Visualcomet: Reasoning about the dynamic context of a still image. In *ECCV*, 2020. 1
- [38] Alec Radford, Jong Wook Kim, Chris Hallacy, Aditya Ramesh, Gabriel Goh, Sandhini Agarwal, Girish Sastry, Amanda Askell, Pamela Mishkin, Jack Clark, et al. Learning transferable visual models from natural language supervision. In *ICML*, 2021. 6, 8
- [39] Nils Reimers and Iryna Gurevych. Sentence-bert: Sentence embeddings using siamese bert-networks. In *EMNLP*, 2019. 4, 5
- [40] Dustin Schwenk, Apoorv Khandelwal, Christopher Clark, Kenneth Marino, and Roozbeh Mottaghi. A-okvqa: A benchmark for visual question answering using world knowledge. In *ECCV*, 2022. 2, 3, 4, 6, 7, 1
- [41] Zhenwei Shao, Zhou Yu, Meng Wang, and Jun Yu. Prompting large language models with answer heuristics for knowledge-based visual question answering. In *CVPR*, 2023. 3, 7
- [42] Sheng Shen, Liunian Harold Li, Hao Tan, Mohit Bansal, Anna Rohrbach, Kai-Wei Chang, Zhewei Yao, and Kurt Keutzer. How much can clip benefit vision-and-language tasks? In *ICLR*, 2022. 8
- [43] Robyn Speer, Joshua Chin, and Catherine Havasi. Conceptnet 5.5: An open multilingual graph of general knowledge. In *AAAI*, 2017. 3, 6
- [44] Laurens Van der Maaten and Geoffrey Hinton. Visualizing data using t-sne. *Journal of machine learning research*, 9(11), 2008. 4
- [45] Denny Vrandečić and Markus Krötzsch. Wikidata: a free collaborative knowledgebase. *Communications of the ACM*, 57(10):78–85, 2014. 3, 6
- [46] Peng Wang, Qi Wu, Chunhua Shen, Anton van den Hengel, and Anthony Dick. Explicit knowledge-based reasoning for visual question answering. *arXiv preprint arXiv:1511.02570*, 2015. 1, 2, 3
- [47] Peng Wang, Qi Wu, Chunhua Shen, Anthony Dick, and Anton Van Den Hengel. Fvqa: Fact-based visual question answering. *IEEE transactions on pattern analysis and machine intelligence*, 40(10):2413–2427, 2017. 1, 2, 3
- [48] Zhengyuan Yang, Zhe Gan, Jianfeng Wang, Xiaowei Hu, Yumao Lu, Zicheng Liu, and Lijuan Wang. An empirical study of gpt-3 for few-shot knowledge-based vqa. In *AAAI*, 2022. 7
- [49] Qinghao Ye, Haiyang Xu, Guohai Xu, Jiabo Ye, Ming Yan, Yiyang Zhou, Junyang Wang, Anwen Hu, Pengcheng Shi, Yaya Shi, et al. mplug-owl: Modularization empowers large language models with multimodality. *arXiv preprint arXiv:2304.14178*, 2023. 2
- [50] Rowan Zellers, Yonatan Bisk, Ali Farhadi, and Yejin Choi. From recognition to cognition: Visual commonsense reasoning. In *CVPR*, 2019. 1
- [51] Renrui Zhang, Jiaming Han, Aojun Zhou, Xiangfei Hu, Shilin Yan, Pan Lu, Hongsheng Li, Peng Gao, and Yu Qiao. Llama-adapter: Efficient fine-tuning of language models with zero-init attention. *arXiv preprint arXiv:2303.16199*, 2023. 2
- [52] Youcai Zhang, Xinyu Huang, Jinyu Ma, Zhaoyang Li, Zhaochuan Luo, Yanchun Xie, Yuzhuo Qin, Tong Luo, Yaqian Li, Shilong Liu, et al. Recognize anything: A strong image tagging model. *arXiv preprint arXiv:2306.03514*, 2023. 2, 3, 4, 6, 1
- [53] Zhuosheng Zhang, Aston Zhang, Mu Li, Hai Zhao, George Karypis, and Alex Smola. Multimodal chain-of-thought reasoning in language models. *arXiv preprint arXiv:2302.00923*, 2023. 5
- [54] Deyao Zhu, Jun Chen, Xiaoqian Shen, Xiang Li, and Mohamed Elhoseiny. MiniGPT-4: Enhancing vision-language understanding with advanced large language models. *arXiv preprint arXiv:2304.10592*, 2023. 2

# Q&A Prompts: Discovering Rich Visual Clues through Mining Question-Answer Prompts for VQA requiring Diverse World Knowledge

## Supplementary Material

### A. Overview of Supplementary Material

Our supplementary materials consist of additional analysis and experimental results of the proposed method including:

- A detailed look into the tags and our generated questions (detailed in Appendix B).
- More experimental results and analysis about our method (detailed in Appendix C).
- More visualization (detailed in Appendix D).

### B. Tags & Questions

#### B.1. Generated Tags

In this paper, we utilize the RAM [52] model to recognize the tags as the answers we need for the VQA model, since RAM can accurately identify 6400+ common tags in total. Specifically, we generated an overall 359,584 tags for 23,692 images in A-OKVQA, with 3,038 unique tags. Notably, this statistics is computed after a filter from those most frequent but general tags including: ['man', 'person', 'stand', 'sit', 'woman', 'white', 'catch', 'table', 'floor', 'food', 'road', 'ride', 'park', 'walk', 'building', 'play', 'green', 'water', 'red', 'black', 'yellow', 'blue']. We also present a word cloud of the generated tags for images of A-OKVQA in Fig. 6 to intuitively understand the tags.

#### B.2. Generated Questions

We randomly sample 250 questions from the questions generated by our VQA model for the A-OKVQA dataset and annotate what kind of world knowledge was required to answer the questions. The choices are the same with A-OKVQA [40] including:

(1) **Commonsense Knowledge** [37, 50]: knowledge about the world that humans learn from their everyday experiences, including inferring the likely intents, social interactions, procedure understanding, and future prediction. For example, suits are often worn to formal events, and certain foods are associated with specific meals.

(2) **Visual Knowledge** [3, 12]: knowledge of concepts represented visually or the spatial relationships in an image. For example, the recognition of specific objects, animals, and actions in the image.

(3) **Knowledge Bases** [34, 46, 47]: knowledge obtained from textbooks, Wikipedia, and other textual sources. This includes factoid and empirical knowledge such as knowing the names of rare categories or the date of an event.

(4) **Physical Knowledge** [21, 40]: knowledge about the physics of the world and processes that occur in it. An ex-

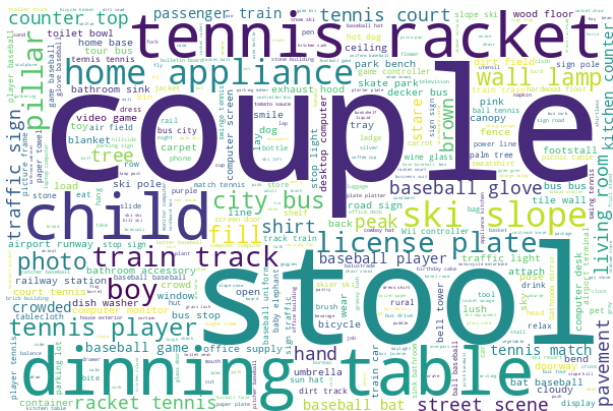

Figure 6. Word cloud of the tags generated for A-OKVQA.

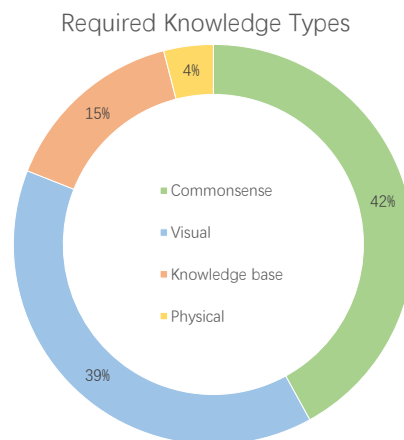

Figure 7. Knowledge type distribution for a random subset of the generated questions for A-OKVQA.

ample of such knowledge is that shaded areas are cooler than unshaded areas in direct sunlight.

The distribution is shown Fig. 7. Most of the generated questions focus on commonsense and visual knowledge, as well as the A-OKVQA. We also present examples of question-answer pairs with different knowledge types generated by our method in Fig. 8. It should be noted that sometimes there is no clear distinction between these four categories and a question may belong to either category.

### C. More Experiments

In Sec. 4 and Tab. 4, we have made ablation studies to investigate the role of our generated Q&A pairs compared with

### Visual Knowledge



Q: Where is the dog sitting?  
A: floor



Q: What is in the middle of the plate?  
A: meat

### Commonsen Knowledge



Q: Why are people carrying the bags?  
A: load



Q: What is the glass covered area used for?  
A: showcase

### Knowledge base



Q: What event is this most likely?  
A: christmas

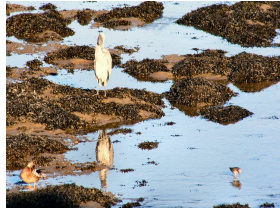

Q: What species of bird is this?  
A: heron

### Physical Knowledge



Q: How do the people feel here?  
A: cold

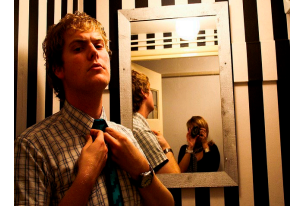

Q: How is the woman's face visible?  
A: reflection

Figure 8. Examples of Q&A prompts with different knowledge types generated by *Q&A Prompt*.

pure captions, and the effectiveness of our VPM compared with directly pretending captions or Q&A pairs as the natural language into the question instruction. Here, we make additional ablation studies to figure out the relationships between the generated tags and questions. As shown in Tab. 8, when we directly prepend the tags or Q&A pairs into the instruction, both the performances improve compared with the vanilla model (+0.7% for tags, +2.6% for Q&A prompts). Notably, when encoding the tags or Q&A pairs into prompt embeddings with the VPM, a larger improvement is observed for Q&A pairs (+5.4%) while a smaller improvement for tags (+0.3%).

We attribute this performance difference to the involved information and sequence length of the generated tags and Q&A pairs. For one thing, the Q&A pairs contain more visual clues and world knowledge compared to simple tags. This is intuitively understandable because the question itself can contain a large amount of information that is helpful for the target question (e.g., compared with a simple tag [‘sea’], the Q&A pairs [‘Q: What body of water is the kite flying above? A: sea’] conveys more information about the surroundings of the environment). This is why our Q&A pairs work better than simple tags or captions whenever directly prepending or using VPM. For another, despite the Q&A pairs including more information, it has a longer sequence length than the tags. Therefore, it’s essential to compress the much longer Q&A pairs into short representations

Fusion strategy	Accuracy (%)
Vanilla	64.0
Prepend	
+ Tags	64.7
+ Q&A	66.6
VPM	
+ Tags	64.3
+ Q&A	<b>69.4</b>

Table 8. Additional ablation studies on fusing strategy.

with our VPM to avoid interference with the target question when feeding it into the MLLM. Instead, the sequence length of tags is much shorter, additional compression will destroy the existing semantic information in tags, and a direct prepending into the instruction is enough. That’s why VPM works well for the long Q&A pairs while less effective for the short tags.

### D. More Visualizations

Finally, we show more visualization cases in Fig. 9 and Fig. 10 to illustrate how the *Q&A Prompts* works. The results show that the generated question-answer pairs are helpful for MLLM to generate correct answers.



**Question:**  
What would this fence help to contain?

**Image Tags:**  
lush, racket, swinge, catch, tennis racket, play, person, tennis, court, tennis match

**Q&A Prompts:**  
Q: What type of grass is in this park? A: lush  
Q: Which object in this image is used for playing tennis? A: racket  
...  
Q: What type of game is being played? A: tennis match

**Predictive Answer:**  
InstructBLIP: animals  
Ours: balls  
**Ground Truth:**  
balls



**Question:**  
What are the people doing on the grass?

**Image Tags:**  
park, gathering, grass, eat, relax, picnic, sit, food, blanket, collect, picnic table

**Q&A Prompts:**  
Q: Where are the people sitting? A: park  
Q: What is the group doing? A: gathering  
...  
Q: What is the thing in the center? A: picnic table

**Predictive Answer:**  
InstructBLIP: talking  
Ours: eating  
**Ground Truth:**  
eating



**Question:**  
Why is the kid wearing a helmet?

**Image Tags:**  
helmet, child, wear, back, boy, horseback, horse, rider, jockey, equestrian, ride

**Q&A Prompts:**  
Q: Which object in this image is worn by the person? A: helmet  
Q: Who is the person who is riding the horse? A: child  
...  
Q: What is the boy doing? A: ride

**Predictive Answer:**  
InstructBLIP: dress  
Ours: protection  
**Ground Truth:**  
protection



**Question:**  
What is required to be on the ground to do this sport?

**Image Tags:**  
snow, ski, ski pole, skier, hill, ski equipment, slope, stand, pose, group photo, mountain

**Q&A Prompts:**  
Q: What is covering the ground? A: snow  
Q: What sport are they enjoying? A: ski  
...  
Q: What kind of terrain are these people skiing on? A: mountain

**Predictive Answer:**  
InstructBLIP: skateboards  
Ours: snow  
**Ground Truth:**  
snow



**Question:**  
Which person is telling us their occupation?

**Image Tags:**  
joker, dress, sleepwear, stand cart, stilt, cable car, trolley

**Q&A Prompts:**  
Q: What is the name of the character in the photo? A: joker  
Q: What type of clothing is the man wearing? A: dress  
...  
Q: What kind of transportation is this? A: trolley

**Predictive Answer:**  
InstructBLIP: old  
Ours: clown  
**Ground Truth:**  
clown



**Question:**  
What is the woman wearing pink helping the boy do?

**Image Tags:**  
food, baby carriage, boy, eat, sit, bite, sweatshirt, table, child, baby, pink, bottle

**Q&A Prompts:**  
Q: What is the woman trying to feed the child? A: food  
Q: What is the boy sitting in? A: baby carriage  
...  
Q: Which object in this image can be used for feeding? A: bottle

**Predictive Answer:**  
InstructBLIP: sit  
Ours: eat  
**Ground Truth:**  
eat



**Question:**  
What is the light source in the room?

**Image Tags:**  
illuminate, laptop, light, lamp, dark, room, computer, bedroom, blanket, sit

**Q&A Prompts:**  
Q: How did the person get the light on their screen? A: illuminate  
Q: What is the device in front of the person called? A: laptop  
...  
Q: How is the person in the room? A: sit

**Predictive Answer:**  
InstructBLIP: lamp  
Ours: laptop  
**Ground Truth:**  
laptop



**Question:**  
What kind of room is this?

**Image Tags:**  
hotel, lamp, nightstand, hotel room, suite, furniture, bed, pillow, chair, table, couch

**Q&A Prompts:**  
Q: What kind of room is this? A: hotel  
Q: What is the large light in the middle of the room? A: lamp  
...  
Q: What is the chair next to the bed called? A: couch

**Predictive Answer:**  
InstructBLIP: bedroom  
Ours: hotel room  
**Ground Truth:**  
hotel room

Figure 9. We denote the question, tags, Q&A prompts, predictive answers, and ground truth respectively. Our Q&A Prompts can discover rich visual clues in the image and reason out the correct answer.



**Question:**  
What has caused the leaves to fall from the trees?

**Image Tags:**  
park, autumn, sit, city park, park bench, grass, woman, leaves, field

**Q&A Prompts:**  
Q: Where is the person sitting?  
A: park  
Q: What's the season in picture? A: autumn  
...  
Q: Where is the woman most likely to find peace?  
A: field

**Predictive Answer:**  
InstructBLIP: wind  
Ours: weather  
**Ground Truth:**  
weather



**Question:**  
How will the people on the mountain get off it?

**Image Tags:**  
mountain, ski, hillside, hill, ski slope, skier, snowy, slope, pine, crowd, sky, snow

**Q&A Prompts:**  
Q: What kind of terrain is the group of people skiing on?  
A: mountain  
Q: What sport is this?  
A: ski  
...  
Q: What is the ground made of?  
A: snow

**Predictive Answer:**  
InstructBLIP: walking  
Ours: skiing  
**Ground Truth:**  
skiing



**Question:**  
What type of climate is it?

**Image Tags:**  
sea, shoreline, beach, coast, cattle, herd, dirt track, animal, walk, sand

**Q&A Prompts:**  
Q: What type of water is the animals standing in? A: sea  
Q: What is the area called that animals are walking?  
A: shoreline  
...  
Q: What is the ground made of? A: sand

**Predictive Answer:**  
InstructBLIP: wetlands  
Ours: tropical  
**Ground Truth:**  
tropical



**Question:**  
Why is the man on the left wearing the goggles?

**Image Tags:**  
goggles, snowshoe, pose, ski equipment, stand, ski pole, snow, skier, snowy

**Q&A Prompts:**  
Q: What protects their eyes?  
A: goggles  
Q: What kind of shoes are the men wearing?  
A: snowshoe  
...  
Q: What is the weather like?  
A: snowy

**Predictive Answer:**  
InstructBLIP: fashion  
Ours: eye protection  
**Ground Truth:**  
eye protection



**Question:**  
The weather must have a moderate amount of what?

**Image Tags:**  
sea, sand, daylight, sky, beach, coast, water, shoreline, fly, stand, crowded, kite

**Q&A Prompts:**  
Q: What body of water is the kite flying above?  
A: sea  
Q: What is on the beach?  
A: sand  
...  
Q: What is the object in the sky? A: kite

**Predictive Answer:**  
InstructBLIP: sky  
Ours: wind  
**Ground Truth:**  
wind



**Question:**  
What is the white object the man in black shirt is holding?

**Image Tags:**  
plate, food, tray, sandwich, condiment, fry, sauce, tomato sauce, catch, chip

**Q&A Prompts:**  
Q: Which object in this image is used for eating food? A: plate  
Q: What is the man in the center taking a picture of?  
A: food  
...  
Q: What is the name of the snack in the picture? A: chip

**Predictive Answer:**  
InstructBLIP: sandwich  
Ours: plate  
**Ground Truth:**  
plate



**Question:**  
What has caused the elephants to turn brown?

**Image Tags:**  
mud, elephant, water, river, baby elephant, river bank, stand, puddle, bank, hillside

**Q&A Prompts:**  
Q: What is the river made of?  
A: mud  
Q: What is the name of the animal in the picture?  
A: elephant  
...  
Q: What area is the elephant herd in? A: hillside

**Predictive Answer:**  
InstructBLIP: crayon  
Ours: dirt  
**Ground Truth:**  
dirt



**Question:**  
Why are the bananas piled up on the shelf?

**Image Tags:**  
fruit stand, showcase, bin, banana, pineapple, fruit, sign, display, market, sale

**Q&A Prompts:**  
Q: Where would you find these bananas? A: fruit stand  
Q: Why are the bananas presented here?  
A: showcase  
...  
Q: What is the sign telling you?  
A: sale

**Predictive Answer:**  
InstructBLIP: eating  
Ours: for sale  
**Ground Truth:**  
for sale

Figure 10. We denote the question, tags, Q&A prompts, predictive answers, and ground truth respectively. Our Q&A Prompts can discover rich visual clues in the image and reason out the correct answer.