

# Mobile ALOHA: Learning Bimanual Mobile Manipulation with Low-Cost Whole-Body Teleoperation

Zipeng Fu<sup>\*1</sup>, Tony Z. Zhao<sup>\*1</sup>, Chelsea Finn<sup>1</sup>

<sup>\*</sup>project co-leads, <sup>1</sup>Stanford University

<https://mobile-aloha.github.io>

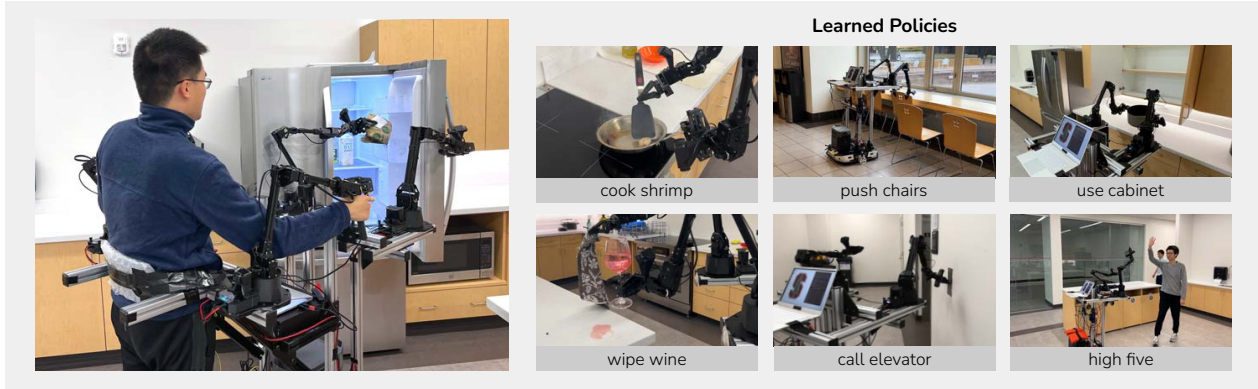

**Figure 1: Mobile ALOHA** 🤖. We introduce a low-cost mobile manipulation system that is bimanual and supports whole-body teleoperation. The system costs \$32k including onboard power and compute. *Left:* A user teleoperates to obtain food from the fridge. *Right:* Mobile ALOHA can perform complex long-horizon tasks with imitation learning.

## Abstract

Imitation learning from human demonstrations has shown impressive performance in robotics. However, most results focus on table-top manipulation, lacking the mobility and dexterity necessary for generally useful tasks. In this work, we develop a system for imitating mobile manipulation tasks that are bimanual and require whole-body control. We first present *Mobile ALOHA*, a low-cost and whole-body teleoperation system for data collection. It augments the *ALOHA* system [104] with a mobile base, and a whole-body teleoperation interface. Using data collected with *Mobile ALOHA*, we then perform supervised behavior cloning and find that co-training with existing *static ALOHA* datasets boosts performance on mobile manipulation tasks. With 50 demonstrations for each task, co-training can increase success rates by up to 90%, allowing *Mobile ALOHA* to autonomously complete complex mobile manipulation tasks such as sauteing and serving a piece of shrimp, opening a two-door wall cabinet to store heavy cooking pots, calling and entering an elevator, and lightly rinsing a used pan using a kitchen faucet.

## 1. Introduction

Imitation learning from human-provided demonstrations is a promising tool for developing generalist

robots, as it allows people to teach arbitrary skills to robots. Indeed, direct behavior cloning can enable robots to learn a variety of primitive robot skills ranging from lane-following in mobile robots [67], to simple pick-and-place manipulation skills [12, 20] to more delicate manipulation skills like spreading pizza sauce or slotting in a battery [18, 104]. However, many tasks in realistic, everyday environments require whole-body coordination of both mobility and dexterous manipulation, rather than just individual mobility or manipulation behaviors. For example, consider the relatively basic task of putting away a heavy pot into a cabinet in Figure 1. The robot needs to first navigate to the cabinet, necessitating the mobility of the robot base. To open the cabinet, the robot needs to back up while simultaneously maintaining a firm grasp of the two door handles, motivating whole-body control. Subsequently, both arms need to grasp the pot handles and together move the pot into the cabinet, emphasizing the importance of bimanual coordination. Along a similar vein, cooking, cleaning, housekeeping, and even simply navigating an office using an elevator all require mobile manipulation and are often made easier with the added flexibility of two arms. In this paper, we study the feasibility of extending imitation learning to tasks that require whole-body control of bimanual mobile

robots.

Two main factors hinder the wide adoption of imitation learning for bimanual mobile manipulation. (1) We lack accessible, plug-and-play hardware for whole-body teleoperation. Bimanual mobile manipulators can be costly if purchased off-the-shelf. Robots like the PR2 and the TIAGo can cost more than \$200k USD, making them unaffordable for typical research labs. Additional hardware and calibration are also necessary to enable teleoperation on these platforms. For example, the PR1 uses two haptic devices for bimanual teleoperation and foot pedals to control the base [93]. Prior work [5] uses a motion capture system to retarget human motion to a TIAGo robot, which only controls a single arm and needs careful calibration. Gaming controllers and keyboards are also used for teleoperating the Hello Robot Stretch [2] and the Fetch robot [1], but do not support bimanual or whole-body teleoperation. (2) Prior robot learning works have not demonstrated high-performance bimanual mobile manipulation for complex tasks. While many recent works demonstrate that highly expressive policy classes such as diffusion models and transformers can perform well on fine-grained, multi-modal manipulation tasks, it is largely unclear whether the same recipe will hold for mobile manipulation: with additional degrees of freedom added, the interaction between the arms and base actions can be complex, and a small deviation in base pose can lead to large drifts in the arm’s end-effector pose. Overall, prior works have not delivered a practical and convincing solution for bimanual mobile manipulation, both from a hardware and a learning standpoint.

We seek to tackle the challenges of applying imitation learning to bimanual mobile manipulation in this paper. On the hardware front, we present *Mobile ALOHA*, a low-cost and whole-body teleoperation system for collecting bimanual mobile manipulation data. *Mobile ALOHA* extends the capabilities of the original *ALOHA*, the low-cost and dexterous bimanual puppeteering setup [104], by mounting it on a wheeled base. The user is then physically tethered to the system and backdrives the wheels to enable base movement. This allows for independent movement of the base while the user has both hands controlling *ALOHA*. We record the base velocity data and the arm puppeteering data at the same time, forming a whole-body teleoperation system.

On the imitation learning front, we observe that simply concatenating the base and arm actions then training via direct imitation learning can yield strong performance. Specifically, we concatenate the 14-

DoF joint positions of *ALOHA* with the linear and angular velocity of the mobile base, forming a 16-dimensional action vector. This formulation allows *Mobile ALOHA* to benefit directly from previous deep imitation learning algorithms, requiring almost no change in implementation. To further improve the imitation learning performance, we are inspired by the recent success of pre-training and co-training on diverse robot datasets, while noticing that there are few to none accessible bimanual mobile manipulation datasets. We thus turn to leveraging data from *static* bimanual datasets, which are more abundant and easier to collect, specifically the *static ALOHA* datasets from [81, 104] through the RT-X release [20]. It contains 825 episodes with tasks disjoint from the *Mobile ALOHA* tasks, and has different mounting positions of the two arms. Despite the differences in tasks and morphology, we observe positive transfer in nearly all mobile manipulation tasks, attaining equivalent or better performance and data efficiency than policies trained using only *Mobile ALOHA* data. This observation is also consistent across different class of state-of-the-art imitation learning methods, including ACT [104] and Diffusion Policy [18].

The main contribution of this paper is a system for learning complex mobile bimanual manipulation tasks. Core to this system is both (1) *Mobile ALOHA*, a low-cost whole-body teleoperation system, and (2) the finding that a simple co-training recipe enables data-efficient learning of complex mobile manipulation tasks. Our teleoperation system is capable of multiple hours of consecutive usage, such as cooking a 3-course meal, cleaning a public bathroom, and doing laundry. Our imitation learning result also holds across a wide range of complex tasks such as opening a two-door wall cabinet to store heavy cooking pots, calling an elevator, pushing in chairs, and cleaning up spilled wine. With co-training, we are able to achieve over 80% success on these tasks with only 50 human demonstrations per task, with an average of 34% absolute improvement compared to no co-training.

## 2. Related Work

**Mobile Manipulation.** Many current mobile manipulation systems utilize model-based control, which involves integrating human expertise and insights into the system’s design and architecture [9, 17, 33, 52, 93]. A notable example of model-based control in mobile manipulation is the DARPA Robotics Challenge [56]. Nonetheless, these systems can be challenging to develop and maintain, often

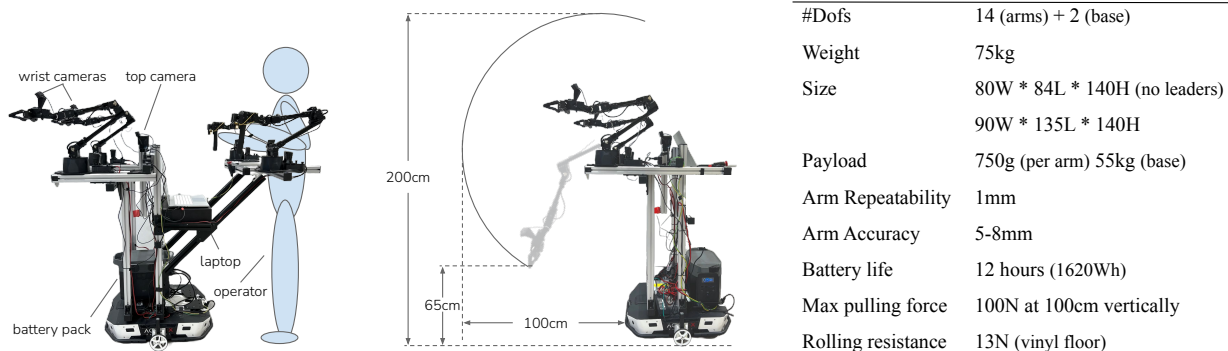

**Figure 2: Hardware Details.** *Left:* Mobile ALOHA has two wrist cameras and one top camera, with onboard power and compute. *Middle:* The teleoperation setup can be removed and only two ViperX 300 [3] are used during autonomous execution. Both arms can reach a min/max height of 65cm/200cm, and extends 100cm from the base. *Right:* Technical specifications of Mobile ALOHA.

requiring substantial team efforts, and even minor errors in perception modeling can result in significant control failures [6, 51]. Recently, learning-based approaches have been applied to mobile manipulation, alleviating much of the heavy engineering. In order to tackle the exploration problem in high-dimensional state and action spaces of mobile manipulation tasks, prior works use predefined skill primitives [86, 91, 92], reinforcement learning with decomposed action spaces [38, 48, 58, 94, 101], or whole-body control objectives [36, 42, 99]. Unlike these prior works that use action primitives, state estimators, depth images or object bounding boxes, imitation learning allows mobile manipulators to learn end-to-end by directly mapping raw RGB observations to whole-body actions, showing promising results through large-scale training using real-world data [4, 12, 78] in indoor environments [39, 78]. Prior works use expert demonstrations collected by using a VR interface [76], kinesthetic teaching [100], trained RL policies [43], a smartphone interface [90], motion capture systems [5], or from humans [8]. Prior works also develop humanoid teleoperation by using human motion capture suits [19, 22, 23, 26], exoskeleton [32, 45, 72, 75], VR headsets for visual feedbacks [15, 53, 65, 87], and haptic feedback devices [14, 66]. Purushottam et al. develop an exoskeleton suit attached to a force plate for whole-body teleoperation of a wheeled humanoid. However, there is no low-cost solution to collecting whole-body expert demonstrations for bimanual mobile manipulation. We present *Mobile ALOHA* for this problem. It is suitable for hour-long teleoperation, and does not require a FPV goggle for streaming back videos from the robot’s egocentric camera or haptic devices.

**Imitation Learning for Robotics.** Imitation learning enables robots to learn from expert demonstrations [67]. Behavioral cloning (BC) is a simple version, mapping observations to actions. Enhancements to BC include incorporating history with various architectures [12, 47, 59, 77], new training objectives [10, 18, 35, 63, 104], regularization [71], motor primitives [7, 44, 55, 62, 64, 97], and data preprocessing [81]. Prior works also focus on multi-task or few-shot imitation learning, [25, 27, 30, 34, 46, 50, 88, 102], language-conditioned imitation learning [12, 47, 82, 83], imitation from play data [21, 57, 74, 89], using human videos [16, 24, 29, 60, 69, 80, 84, 96], and using task-specific structures [49, 83, 103]. Scaling up these algorithms has led to systems adept at generalizing to new objects, instructions, or scenes [12, 13, 28, 47, 54]. Recently, co-training on diverse real-world datasets collected from different but similar types of robots have shown promising results on single-arm manipulation [11, 20, 31, 61, 98], and on navigation [79]. In this work, we use a co-training pipeline for bimanual mobile manipulation by leveraging the existing static bimanual manipulation datasets, and show that our co-training pipeline improves the performance and data efficiency of mobile manipulation policies across all tasks and several imitation learning methods. To our knowledge, we are the first to find that co-training with static manipulation datasets improves the performance and data efficiency of mobile manipulation policies.

### 3. Mobile ALOHA Hardware

We develop *Mobile ALOHA*, a low-cost mobile manipulator that can perform a broad range of household tasks. *Mobile ALOHA* inherits the benefits of the original *ALOHA* system [104], i.e. the low-cost, dex-



terous, and repairable bimanual teleoperation setup, while extending its capabilities beyond table-top manipulation. Specifically, we incorporate four key design considerations:

1. **Mobile:** The system can move at a speed comparable to human walking, around 1.42m/s.
2. **Stable:** It is stable when manipulating heavy household objects, such as pots and cabinets.
3. **Whole-body teleoperation:** All degrees of freedom can be teleoperated simultaneously, including both arms and the mobile base.
4. **Untethered:** Onboard power and compute.

We choose AgileX Tracer AGV ("Tracer") as the mobile base following *considerations 1 and 2*. Tracer is a low-profile, differential drive mobile base designed for warehouse logistics. It can move up to 1.6m/s similar to average human walking speed. With a maximum payload of 100kg and 17mm height, we can add a balancing weight low to the ground to achieve the desired tip-over stability. We found Tracer to possess sufficient traversability in accessible buildings: it can traverse obstacles as tall as 10mm and slopes as steep as 8 degrees with load, with a minimum ground clearance of 30mm. In practice, we found it capable of more challenging terrains such as traversing the gap between the floor and the elevator. Tracer costs \$7,000 in the United States, more than 5x cheaper than AGVs from e.g. Clearpath with similar speed and payload.

We then seek to design a whole-body teleoperation system on top of the Tracer mobile base and ALOHA arms, i.e. a teleoperation system that allows simultaneous control of both the base and the two arms (*consideration 3*). This design choice is particularly important in household settings as it expands the available workspace of the robot. Consider the task of opening a two-door cabinet. Even for humans, we naturally step back while opening the doors to avoid collision and awkward joint configurations. Our teleoperation system shall not constrain such coordinated human motion, nor introduce unnecessary artifacts in the collected dataset. However, designing a whole-body teleoperation system can be challenging, as both hands are already occupied by the ALOHA leader arms. We found the design of tethering the operator's waist to the mobile base to be the most simple and direct solution, as shown in Figure 2 (left). The human can backdrive the wheels which have very low friction when torqued off. We measure the rolling resistance to be around 13N on vinyl floor, acceptable to most humans. Connecting the operator to the mobile manipulator directly also enables coarse haptic feedback when the robot col-

lides with objects. To improve the ergonomics, the height of the tethering point and the positions of the leader arms can all be independently adjusted up to 30cm. During autonomous execution, the tethering structure can also be detached by loosening 4 screws, together with the two leader arms. This reduces the footprint and weight of the mobile manipulator as shown in Figure 2 (middle). To improve the ergonomics and expand workspace, we also mount the four ALOHA arms all facing forward, different from the original ALOHA which has arms facing inward.

To make our mobile manipulator untethered (*consideration 4*), we place a 1.26kWh battery that weights 14kg at the base. It also serves as a balancing weight to avoid tipping over. All compute during data collection and inference is conducted on a consumer-grade laptop with Nvidia 3070 Ti GPU (8GB VRAM) and Intel i7-12800H. It accepts streaming from three Logitech C922x RGB webcams, at 480x640 resolution and 50Hz. Two cameras are mounted to the wrist of the follower robots, and the third facing forward. The laptop also accepts proprioception streaming from all 4 arms through USB serial ports, and from the Tracer mobile base through CAN bus. We record the linear and angular velocities of the mobile base to be used as actions of the learned policy. We also record the joint positions of all 4 robot arms to be used as policy observations and actions. We refer readers to the original ALOHA paper [104] for more details about the arms.

With design considerations above, we build *Mobile ALOHA* with a \$32k budget, comparable to a single industrial cobot such as the Franka Emika Panda. As illustrated in Figure 2 (middle), the mobile manipulator can reach between 65cm and 200cm vertically relative to the ground, can extend 100cm beyond its base, can lift objects that weight 1.5kg, and can exert pulling force of 100N at a height of 1.5m. Some example tasks that *Mobile ALOHA* is capable of includes:

- **Housekeeping:** Water plants, use a vacuum, load and unload a dishwasher, obtain drinks from the fridge, open doors, use washing machine, fling and spread a quilt, stuff a pillow, zip and hang a jacket, fold trousers, turn on/off a lamp, and self-charge.
- **Cooking:** Crack eggs, mince garlic, unpackage vegetables, pour liquid, sear and flip chicken thigh, blanch vegetables, stir fry, and serve food in a dish.
- **Human-robot interactions:** Greet and shake "hands" with a human, open and hand a beer to human, help human shave and make bed.

We include more technical specifications of *Mo-*

mobile ALOHA in Figure 2 (right). Beyond the off-the-shelf robots, we open-source all of the software and hardware parts with a detailed tutorial covering 3D printing, assembly, and software installation. The tutorial is on the [project website](#).

#### 4. Co-training with Static ALOHA Data

The typical approach for using imitation learning to solve real-world robotics tasks relies on using the datasets that are collected on a specific robot hardware platform for a targeted task. This straightforward approach, however, suffers from lengthy data collection processes where human operators collect demonstration data from scratch for every task on the a specific robot hardware platform. The policies trained on these specialized datasets are often not robust to the perceptual perturbations (e.g. distractors and lighting changes) due to the limited visual diversity in these datasets [95]. Recently, co-training on diverse real-world datasets collected from different but similar types of robots have shown promising results on single-arm manipulation [11, 20, 31, 61], and on navigation [79].

In this work, we use a co-training pipeline that leverages the existing *static ALOHA* datasets to improve the performance of imitation learning for mobile manipulation, specifically for the bimanual arm actions. The *static ALOHA* datasets [81, 104] have 825 demonstrations in total for tasks including Ziploc sealing, picking up a fork, candy wrapping, tearing a paper towel, opening a plastic portion cup with a lid, playing with a ping pong, tape dispensing, using a coffee machine, pencil hand-overs, fastening a velcro cable, slotting a battery, and handling over a screw driver. Notice that the *static ALOHA* data is all collected on a black table-top with the two arms fixed to face towards each other. This setup is different from *Mobile ALOHA* where the background changes with the moving base and the two arms are placed in parallel facing the front. We do not use any special data processing techniques on either the RGB observations or the bimanual actions of the *static ALOHA* data for our co-training.

Denote the aggregated *static ALOHA* data as  $D_{\text{static}}$ , and the *Mobile ALOHA* dataset for a task  $m$  as  $D_{\text{mobile}}^m$ . The bimanual actions are formulated as target joint positions  $a_{\text{arms}} \in \mathbb{R}^{14}$  which includes two continuous gripper actions, and the base actions are formulated as target base linear and angular velocities  $a_{\text{base}} \in \mathbb{R}^2$ . The training objective for a mobile

manipulation policy  $\pi^m$  for a task  $m$  is

$$\mathbb{E}_{(o^i, a_{\text{arms}}^i, a_{\text{base}}^i) \sim D_{\text{mobile}}^m} [L(a_{\text{arms}}^i, a_{\text{base}}^i, \pi^m(o^i))] + \mathbb{E}_{(o^i, a_{\text{arms}}^i) \sim D_{\text{static}}} [L(a_{\text{arms}}^i, [0, 0], \pi^m(o^i))],$$

where  $o^i$  is the observation consisting of two wrist camera RGB observations, one egocentric top camera RGB observation mounted between the arms, and joint positions of the arms, and  $L$  is the imitation loss function. We sample with equal probability from the *static ALOHA* data  $D_{\text{static}}$  and the *Mobile ALOHA* data  $D_{\text{mobile}}^m$ . We set the batch size to be 16. Since *static ALOHA* datapoints have no mobile base actions, we zero-pad the action labels so actions from both datasets have the same dimension. We also ignore the front camera in the *static ALOHA* data so that both datasets have 3 cameras. We normalize every action based on the statistics of the *Mobile ALOHA* dataset  $D_{\text{mobile}}^m$  alone. In our experiments, we combine this co-training recipe with multiple base imitation learning approaches, including ACT [104], Diffusion Policy [18], and VINN [63].

#### 5. Tasks

We select 7 tasks that cover a wide range of capabilities, objects, and interactions that may appear in realistic applications. We illustrate them in Figure 3. For **Wipe Wine**, the robot needs to clean up spilled wine on the table. This task requires both mobility and bimanual dexterity. Specifically, the robot needs to first navigate to the faucet and pick up the towel, then navigate back to the table. With one arm lifting the wine glass, the other arm needs to wipe the table as well as the bottom of the glass with the towel. This task is not possible with *static ALOHA*, and would take more time for a single-armed mobile robot to accomplish.

For **Cook Shrimp**, the robot sautes one piece of raw shrimp on both sides before serving it in a bowl. Mobility and bimanual dexterity are also necessary for this task: the robot needs to move from the stove to the kitchen island as well as flipping the shrimp with spatula while the other arm tilting the pan. This task requires more precision than wiping wine due to the complex dynamics of flipping a half-cooked shrimp. Since the shrimp may slightly stick to the pan, it is difficult for the robot to reach under the shrimp with the spatula and precisely flip it over.

For **Rinse Pan**, the robot picks up a dirty pan and rinse it under the faucet before placing it on the drying rack. In addition to the challenges in the previous two tasks, turning on the faucet poses a hard perception challenge. The knob is made from shiny





**Wipe Wine:** The robot base is initialized within a square of 1.5m x 1.5m with yaw up to 30°. It first navigates to the sink and picks up the towel hanging on the faucet (#1). It then turns around and approaches the kitchen island, picks up the wine glass (randomized in 30cm x 30cm), wipes the spilled wine (#2), and puts down the wine glass on the table (#3). Each demo has 1300 steps or 26 seconds.



**Cook Shrimp:** The robot is randomized up to 5cm and all objects up to 2cm. The right gripper first pours oil into the hot pan (#1) followed by raw shrimp (#2). With left gripper lifting the pan at an angle, the right gripper grasps the spatula and flips the shrimp (#3). The robot then turns around and pours the shrimp into an empty bowl (#4) before placing the pan on the table. Each demo has 3750 steps or 75 seconds.



**Wash Pan:** The pan randomized up to 10cm with yaw up to 45°. The left gripper grasps the pan (#1) before turning around to the faucet. The right gripper opens then closes the faucet with left gripper holding the pan to receive the water (#2). The left gripper then swirls the water inside the pan, pours it out, before placing the pan on the rack (#3). Each demo has 1100 steps or 22 seconds.



**Use Cabinet:** The robot is randomized up to 10cm and pots up to 5cm. A total of 3 pots are used. The robot first approaches the cabinet and grasp both handles, then backs up pulling both doors open (#1). Next, both arms grasp the handles of the pot, move forward, and place it inside the cabinet (#2). The robot then backs up and closes both cabinet doors (#4). Each demo has 1500 steps or 30 seconds.



**Take Elevator:** The robot starts 15m from the elevator and is randomized across the 10m wide lobby. The robot goes around a column to reach the elevator button (#1). The right gripper presses the button (#2) and the robot enters the elevator (#3). Each demo has 2250 steps or 45 seconds.

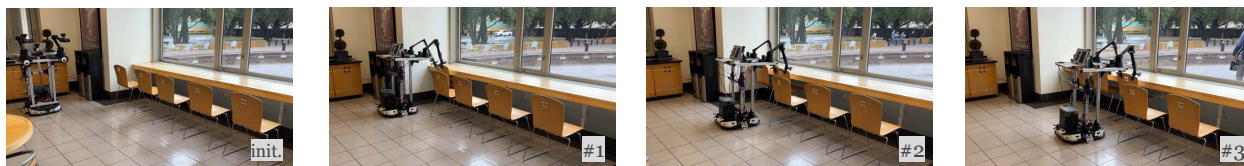

**Push Chairs:** The robot's initial position is randomized up to 10cm. Demonstration dataset contains pushing in the first 3 chairs, and the robot is tested with all 5 chairs. Each demo has 2000 steps or 40 seconds.

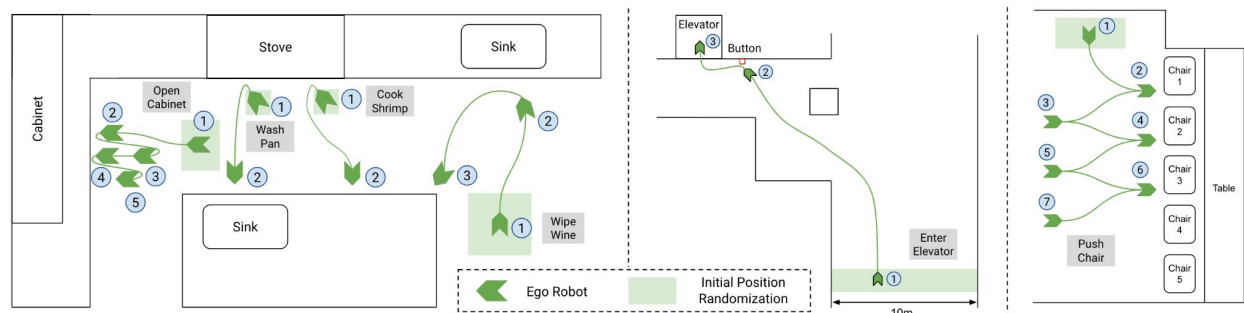

**Figure 3: Task Definitions.** We illustrate 6 real-world tasks that *Mobile ALOHA* can perform autonomously. The 7th task *High Five* is illustrated in the Appendix A.1 due to space constraint. For each task, we describe randomization and sub-task definitions. We also include an illustration of the base movement for each task (not drawn to scale).

	Wipe Wine (50 demos)				Cook Shrimp (20 demos)							
	Grasp Towel	Lift Glass and Wipe	Place Glass	Whole Task	Add Oil	Add Shrimp	Flip Shrimp	Plate Shrimp	Whole Task			
Co-train	100	95	100	<b>95</b>	100	100	60	67	<b>40</b>			
No Co-train	95	58	90	50	100	100	40	50	20			
	Rinse Pan (50 demos)				Use Cabinet (50 demos)							
	Grasp Pan	Turn On Faucet	Place Pan	Whole Task	Open Cabinets	Grasp Pot	Place Pot	Close Cabinet	Whole Task			
Co-train	100	80	100	<b>80</b>	95	100	95	95	<b>85</b>			
No Co-train	100	0	100	0	95	95	100	95	<b>85</b>			
	Call Elevator (50 demos)				Push Chairs (50 demos)				High Five (20 demos)			
	Navi.	Press Button	Enter Elevator	Whole Task	1-3rd Chair	4th (OOD)	5th (OOD)	Whole Task	Unseen Attire	Unseen Human	Navi.	Whole Task
Co-train	100	100	95	<b>95</b>	100	85	89	<b>80</b>	90	80	100	<b>85</b>
No Co-train	100	5	0	0	100	70	0	0	90	80	100	<b>85</b>

**Table 1: Co-training improves ACT performance.** Across 7 challenging mobile manipulation tasks, co-training with *static ALOHA* dataset consistently improve the success rate (%) of ACT. It is particularly important for sub-tasks like *Press Button* in *Call Elevator* and *Turn on Faucet* in *Rinse Pan*, where precise manipulation is the bottleneck.

stainless steel and is small in size: roughly 4cm in length and 0.7cm in diameter. Due to the stochasticity introduced by the base motion, the arm needs to actively compensate for the errors by “visually-servoing” to the shiny knob. A centimeter-level error could result in task failure.

For *Use Cabinet*, the robot picks up a heavy pot and places it inside a two-door cabinet. While seemingly a task that require no base movement, the robot actually needs to move back and forth four times to accomplish this task. For example when opening the cabinet door, both arms need to grasp the handle while the base is moving backward. This is necessary to avoid collision with the door and have both arms within their workspace. Maneuvers like this also stress the importance of whole-body teleoperation and control: if the arms and base control are separate, the robot will not be able to open both doors quickly and fluidly. Notably, the heaviest pot in our experiments weighs 1.4kg, exceeding the single arm’s payload limit of 750g while within the combined payload of two arms.

For *Call Elevator*, the robot needs to enter the elevator by pressing the button. We emphasize long navigation, large randomization, and precise whole-body control in this task. The robot starts around 15m from the elevator and is randomized across the 10m wide lobby. To press the elevator button, the robot needs to go around a column and stop precisely next to the button. Pressing the button, measured 2cm×2cm in size, requires precision as pressing the

peripheral or pressing too lightly will not activate the elevator. The robot also needs to turn sharply and precisely to enter the elevator door: there is only 30cm in clearance between the robot’s widest part and the door.

For *Push Chairs*, the robot needs to push in 5 chairs in front of a long desk. This task emphasizes the strength of the mobile manipulator: it needs to overcome the friction between the 5kg chair and the ground with coordinated arms and base movement. To make this task more challenging, we only collect data for the first 3 chairs, and stress test the robot to extrapolate to the 4th and 5th chair.

For *High Five*, we include illustrations in the Appendix A.1. The robot needs to go around the kitchen island, and whenever a human approach it from the front, stop moving and high five with the human. After the high five, the robot should continue moving only when the human moves out of its path. We collect data wearing different clothes and evaluate the trained policy on unseen persons and unseen attires. While this task does not require a lot of precision, it highlights *Mobile ALOHA*’s potential for studying human-robot interactions.

We want to highlight that for all tasks mentioned above, open-loop replaying a demonstration with objects restored to the same configurations will achieve zero whole-task success. Successfully completing the task requires the learned policy to react close-loop and correct for those errors. We believe the source of errors during the open-loop replaying is

		Wipe Wine (50 demos)				Push Chairs (50 demos)			
		Grasp Towel	Lift Glass and Wipe	Place Glass	Whole Task	1st Chair	2nd Chair	3rd Chair	Whole Task
VINN + Chunking	Co-train	85	18	100	15	100	70	86	<b>60</b>
	No Co-train	50	40	100	<b>20</b>	90	72	62	40
Diffusion Policy	Co-train	90	72	100	<b>65</b>	100	100	100	<b>100</b>
	No Co-train	75	47	100	35	100	80	100	80
ACT	Co-train	100	95	100	<b>95</b>	100	100	100	<b>100</b>
	No Co-train	95	58	90	50	100	100	100	<b>100</b>

**Table 2: Mobile ALOHA is compatible with recent imitation learning methods.** VINN with chunking, Diffusion Policy, and ACT all achieves good performance on *Mobile ALOHA*, and benefit from co-training with *static ALOHA*.

the mobile base’s velocity control. As an example, we observe >10cm error on average when replaying the base actions for a 180 degree turn with 1m radius. We include more details about this experiment in Appendix A.4.

## 6. Experiments

We aim to answer two central questions in our experiments. (1) Can *Mobile ALOHA* acquire complex mobile manipulation skills with co-training and a small amount of mobile manipulation data? (2) Can *Mobile ALOHA* work with different types of imitation learning methods, including ACT [104], Diffusion Policy [18], and retrieval-based VINN [63]? We conduct extensive experiments in the real-world to examine these questions.

As a preliminary, all methods we will examine employ “action chunking” [104], where a policy predicts a sequence of future actions instead of one action at each timestep. It is already part of the method for ACT and Diffusion policy, and simple to be added for VINN. We found action chunking to be crucial for manipulation, improving the coherence of generated trajectory and reducing the latency from per-step policy inference. Action chunking also provides a unique advantage for *Mobile ALOHA*: handling the delay of different parts of the hardware more flexibly. We observe a delay between target and actual velocities of our mobile base, while the delay for position-controlled arms is much smaller. To account for a delay of  $d$  steps of the mobile base, our robot executes the first  $k - d$  arm actions and last  $k - d$  base actions of an action chunk of length  $k$ .

### 6.1. Co-training Improves Performance

We start with ACT [104], the method introduced with ALOHA, and train it on all 7 tasks with and without co-training. We then evaluate each policy in the real-world, with randomization of robot

and objects configurations as described in Figure 3. To calculate the success rate for a sub-task, we divide  $\#Success$  by  $\#Attempts$ . For example in the case of *Lift Glass and Wipe* sub-task, the  $\#Attempts$  equals the number of success from the previous sub-task *Grasp Towel*, as the robot could fail and stop at any sub-task. This also means the final success rate equals the product of all sub-task success rates. We report all success rates in Table 1. Each success rate is computed from 20 trials of evaluation, except *Cook Shrimp* which has 5.

With the help of co-training, the robot obtains 95% success for *Wipe Wine*, 95% success for *Call Elevator*, 85% success for *Use Cabinet*, 85% success for *High Five*, 80% success for *Rinse Pan*, and 80% success for *Push Chairs*. Each of these tasks only requires 50 in-domain demonstrations, or 20 in the case of *High Five*. The only task that falls below 80% success is *Cook Shrimp* (40%), which is a 75-second long-horizon task for which we only collected 20 demonstrations. We found the policy to struggle with flipping the shrimp with the spatula and pouring the shrimp inside the white bowl, which has low contrast with the white table. We hypothesize that the lower success is likely due to the limited demonstration data. Co-training improves the whole-task success rate in 5 out of the 7 tasks, with a boost of 45%, 20%, 80%, 95% and 80% respectively. For the remaining two tasks, the success rate is comparable between co-training and no co-training. We find co-training to be more helpful for sub-tasks where precise manipulation is the bottleneck, for example *Press Button*, *Flip Shrimp*, and *Turn On Faucet*. In all of these cases, compounding errors appear to be the main source of failure, either from the stochasticity of robot base velocity control or from rich contacts such as grasping of the spatula and making contact with the pan during *Flip Shrimp*. We hypothesize that the “motion prior” of grasping



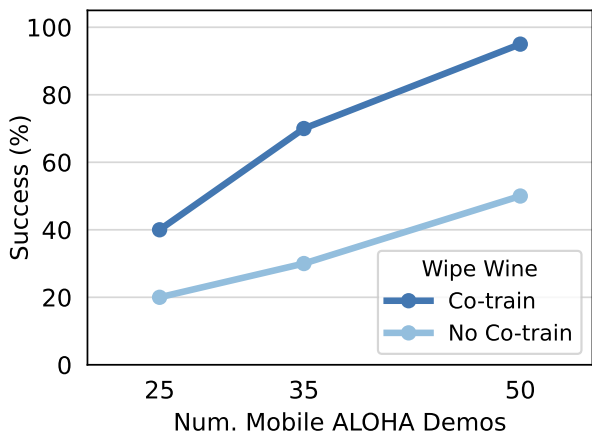

**Figure 4: Data efficiency.** Co-training with *static ALOHA* data leads to better data efficiency and consistent improvements over training with *Mobile ALOHA* data only. Figure style credits to [70].

and approaching objects in the *static ALOHA* dataset still benefits *Mobile ALOHA*, especially given the invariances introduced by the wrist camera [41]. We also find the co-trained policy to generalize better in the case of *Push Chairs* and *Wipe Wine*. For *Push Chairs*, both co-training and no co-training achieve perfect success for the first 3 chairs, which are seen in the demonstrations. However, co-training performs much better when extrapolating to the 4th and 5th chair, by 15% and 89% respectively. For *Wipe Wine*, we observe that the co-trained policy performs better at the boundary of the wine glass randomization region. We thus hypothesize that co-training can also help prevent overfitting, given the low-data regime of 20-50 demonstrations and the expressive transformer-based policy used.

## 6.2. Compatibility with ACT, Diffusion Policy, and VINN

We train two recent imitation learning methods, Diffusion Policy [18] and VINN [63], with *Mobile ALOHA* in addition to ACT. Diffusion policy trains a neural network to gradually refine the action prediction. We use the DDIM scheduler [85] to improve inference speed, and apply data augmentation to image observations to prevent overfitting. The co-training data pipeline is the same as ACT, and we include more training details in the Appendix A.3. VINN trains a visual representation model, BYOL [37] and uses it to retrieve actions from the demonstration dataset with nearest neighbors. We augment VINN retrieval with proprioception features and tune the relative weight to balance visual and proprioception feature importance. We also retrieve an action chunk instead of a single action and find significant performance improvement similar to Zhao et al.. For

Static ALOHA proportion (%)	30	50	70
	(default)		
Success (%)	95	95	90

**Table 3: Co-training is robust to different data mixtures.** Result uses ACT training on the *Wipe Wine* task.

	Co-train	Pre-train	No Co-train No Pre-train
Success (%)	95	40	50

**Table 4: Co-train vs. Pre-train.** Co-train outperforms pre-train on the *Wipe Wine* task. For pre-train, we first train ACT on the *static ALOHA* data and then fine-tune it with the *Mobile ALOHA* data.

co-training, we simply co-train the BYOL encoder with the combined mobile and static data.

In Table 2, we report co-training and no cotraining success rates on 2 real-world tasks: *Wipe Wine* and *Push Chairs*. Overall, Diffusion Policy performs similarly to ACT on *Push Chairs*, both obtaining 100% with co-training. For *Wipe Wine*, we observe worse performance with diffusion at 65% success. The Diffusion Policy is less precise when approaching the kitchen island and grasping the wine glass. We hypothesize that 50 demonstrations is not enough for diffusion given it’s expressiveness: previous works that utilize Diffusion Policy tend to train on upwards of 250 demonstrations. For VINN + Chunking, the policy performs worse than ACT or Diffusion across the board, while still reaching reasonable success rates with 60% on *Push Chairs* and 15% on *Wipe Wine*. The main failure modes are imprecise grasping on *Lift Glass and Wipe* as well as jerky motion when switching between chunks. We find that increasing the weight on proprioception when retrieving can improve the smoothness while at a cost of paying less attention to visual inputs. We find co-training to improve Diffusion Policy’s performance, by 30% and 20% for on *Wipe Wine* and *Push Chairs* respectively. This is expected as co-training helps address overfitting. Unlike ACT and Diffusion Policy, we observe mixed results for VINN, where co-training hurts *Wipe Wine* by 5% while improves *Push Chairs* by 20%. Only the representations of VINN are co-trained, while the action prediction mechanism of VINN does not have a way to leverage the out-of-domain *static ALOHA* data, perhaps explaining these mixed results.

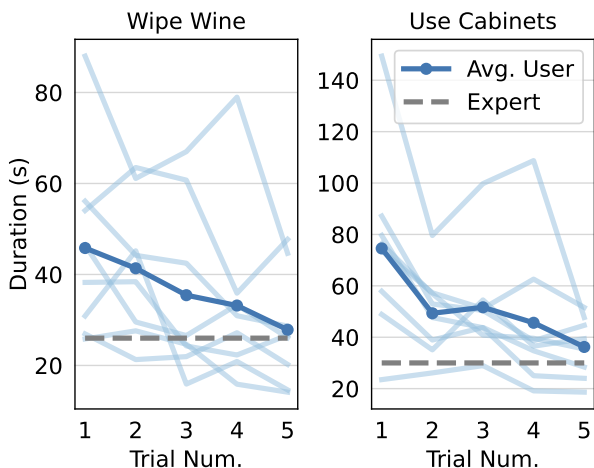

**Figure 5: Teleoperator learning curves.** New users can quickly approach expert speed on an unseen tasks teleoperating *Mobile ALOHA*.

## 7. Ablation Studies

**Data Efficiency.** In Figure 4, we ablate the number of mobile manipulation demonstrations for both co-training and no co-training, using ACT on the *Wipe Wine* task. We consider 25, 35, and 50 *Mobile ALOHA* demonstrations and evaluate for 20 trials each. We observe that co-training leads to better data efficiency and consistent improvements over training using only *Mobile ALOHA* data. With co-training, the policy trained with 35 in-domain demonstrations can outperform the no co-training policy trained with 50 in-domain demonstrations, by 20% (70% vs. 50%).

**Co-training Is Robust To Different Data Mixtures.** We sample with equal probability from the *static ALOHA* datasets and the *Mobile ALOHA* task dataset to form a training mini-batch in our co-training experiments so far, giving a co-training data sampling rate of roughly 50%. In Table 3, we study how different sampling strategies affect performance on the *Wipe Wine* task. We train ACT with 30% and 70% co-training data sampling rates in addition to 50%, then evaluate 20 trials each. We see similar performance across the board, with 95%, 95% and 90% success respectively. This experiment suggests that co-training performance is not sensitive to different data mixtures, reducing the manual tuning necessary when incorporating co-training on a new task.

**Co-training Outperforms Pre-training.** In Table 4, we compare co-training and pre-training on the *static ALOHA* data. For pre-training, we first train ACT on the *static ALOHA* data for 10K steps and then continue training with in-domain task data. We experiment with the *Wipe Wine* task and observe

that pre-training provides no improvements over training solely on *Wipe Wine* data. We hypothesize that the network forgets its experience on the *static ALOHA* data during the fine-tuning phase.

## 8. User Studies

We conduct a user study to evaluate the effectiveness of *Mobile ALOHA* teleoperation. Specifically, we measure how fast participants are able to learn to teleoperate an unseen task. We recruit 8 participants among computer science graduate students, with 5 females and 3 males aged 21-26. Four participants has no prior teleoperation experience, and the remaining 4 have varying levels of expertise. None of the them have used *Mobile ALOHA* before. We start by allowing each participant to freely interact with objects in the scene for 3 minutes. We held out all objects that will be used for the unseen tasks during this process. Next, we give each participants two tasks: *Wipe Wine* and *Use Cabinet*. An expert operator will first demonstrate the task, followed by 5 consecutive trials from the participants. We record the completion time for each trial, and plot them in Figure 5. We notice a steep decline in completion time: on average, the time it took to perform the task went from 46s to 28s for *Wipe Wine* (down 39%), and from 75s to 36s for *Use Cabinet* (down 52%). The average participant can also to approach speed of expert demonstrations after 5 trials, demonstrating the ease of use and learning of *Mobile ALOHA* teleoperation.

## 9. Conclusion, Limitations and Future Directions

In summary, our paper tackles both the hardware and the software aspects of bimanual mobile manipulation. Augmenting the *ALOHA* system with a mobile base and whole-body teleoperation allows us to collect high-quality demonstrations on complex mobile manipulation tasks. Then through imitation learning co-trained with *static ALOHA* data, *Mobile ALOHA* can learn to perform these tasks with only 20 to 50 demonstrations. We are also able to keep the system accessible, with under \$32k budget including onboard power and compute, and open-sourcing on both software and hardware.

Despite *Mobile ALOHA*'s simplicity and performance, there are still limitations that we hope to address in future works. On the hardware front, we will seek to reduce the occupied area of *Mobile ALOHA*. The current footprint of 90cm x 135cm could be too narrow for certain paths. In addition, the fixed height of the two follower arms makes lower cabinets, ovens and dish washers challenging to reach. We are plan-

ning to add more degrees of freedom to the arms' elevation to address this issue. On the software front, we limit our policy learning results to single task imitation learning. The robot can not yet improve itself autonomously or explore to acquire new knowledge. In addition, the *Mobile ALOHA* demonstrations are collected by two expert operators. We leave it to future work for tackling imitation learning from highly suboptimal, heterogeneous datasets.

## Acknowledgments

We thank the Stanford Robotics Center and Steve Cousins for providing facility support for our experiments. We also thank members of Stanford IRIS Lab: Lucy X. Shi and Tian Gao, and members of Stanford REAL Lab: Cheng Chi, Zhenjia Xu, Yihuai Gao, Huy Ha, Zeyi Liu, Xiaomeng Xu, Chuer Pan and Shuran Song, for providing extensive helps for our experiments. We appreciate much photographing by Qingqing Zhao, and feedbacks from and helpful discussions with Karl Pertsch, Boyuan Chen, Ziwen Zhuang, Quan Vuong and Fei Xia. This project is supported by the Boston Dynamics AI Institute and ONR grant N00014-21-1-2685. Zipeng Fu is supported by Stanford Graduate Fellowship.

## References

- [1] Fetch robot. <https://docs.fetchrobotics.com/teleop.html>. 2
- [2] Hello robot stretch. [https://github.com/hello-robot/stretch\\_fisheye\\_web\\_interface](https://github.com/hello-robot/stretch_fisheye_web_interface). 2
- [3] Viperx 300 6dof. <https://www.trossenrobotics.com/viperx-300-robot-arm.aspx>. 3
- [4] Michael Ahn, Anthony Brohan, Noah Brown, Yevgen Chebotar, Omar Cortes, Byron David, Chelsea Finn, Chuyuan Fu, Keerthana Gopalakrishnan, Karol Hausman, Alex Herzog, Daniel Ho, Jasmine Hsu, Julian Ibarz, Brian Ichter, Alex Irpan, Eric Jang, Rosario Jau-regui Ruano, Kyle Jeffrey, Sally Jesmonth, Nikhil Joshi, Ryan Julian, Dmitry Kalashnikov, Yuheng Kuang, Kuang-Huei Lee, Sergey Levine, Yao Lu, Linda Luu, Carolina Parada, Peter Pastor, Jornell Quiambao, Kanishka Rao, Jarek Rettinghouse, Diego Reyes, Pierre Sermanet, Nicolas Sievers, Clayton Tan, Alexander Toshev, Vincent Vanhoucke, Fei Xia, Ted Xiao, Peng Xu, Sichun Xu, Mengyuan Yan, and Andy Zeng. Do as i can and not as i say: Grounding language in robotic affordances. In *arXiv preprint arXiv:2204.01691*, 2022. 3
- [5] Miguel Arduengo, Ana Arduengo, Adrià Colomé, Joan Lobo-Prat, and Carme Torras. Human to robot whole-body motion transfer. In *2020 IEEE-RAS 20th International Conference on Humanoid Robots (Humanoids)*, 2021. 2, 3
- [6] Christopher G Atkeson, PW Babu Ben-zun, Nandan Banerjee, Dmitry Berenson, Christopher P Bove, Xiongyi Cui, Mathew De-Donato, Ruixiang Du, Siyuan Feng, Perry Franklin, et al. What happened at the darpa robotics challenge finals. *The DARPA robotics challenge finals: Humanoid robots to the rescue*. 3
- [7] Shikhar Bahl, Abhinav Gupta, and Deepak Pathak. Hierarchical neural dynamic policies. *RSS*, 2021. 3
- [8] Shikhar Bahl, Abhinav Gupta, and Deepak Pathak. Human-to-robot imitation in the wild. *arXiv preprint arXiv:2207.09450*, 2022. 3
- [9] Max Bajracharya, James Borders, Dan Helmick, Thomas Kollar, Michael Laskey, John Leichty, Jeremy Ma, Umashankar Nagarajan, Akiyoshi Ochiai, Josh Petersen, et al. A mobile manipulation system for one-shot teaching of complex tasks in homes. In *2020 IEEE International Conference on Robotics and Automation (ICRA)*, 2020. 2
- [10] H Bharadhwaj, J Vakil, M Sharma, A Gupta, S Tulsiani, and V Kumar. Roboagent: Towards sample efficient robot manipulation with semantic augmentations and action chunking, 2023. 3
- [11] Konstantinos Bousmalis, Giulia Vezzani, Dushyant Rao, Coline Devin, Alex X. Lee, Maria Bauza, Todor Davchev, Yuxiang Zhou, Agrim Gupta, Akhil Raju, Antoine Laurens, Claudio Fantacci, Valentin Dalibard, Martina Zambelli, Murilo Martins, Rugile Pevcevičiute, Michiel Blokzijl, Misha Denil, Nathan Batchelor, Thomas Lampe, Emilio Parisotto, Konrad Żołna, Scott Reed, Sergio Gómez Colmenarejo, Jon Scholz, Abbas Abdolmaleki, Oliver Groth, Jean-Baptiste Regli, Oleg Sushkov, Tom Rothörl, José Enrique Chen, Yusuf Aytar, Dave Barker, Joy Ortiz, Martin Riedmiller, Jost Tobias Springenberg, Raia Hadsell, Francesco Nori, and Nicolas Heess. Robocat: A self-improving foundation agent for robotic manipulation. *arXiv preprint arXiv:2306.11706*, 2023. 3, 5
- [12] Anthony Brohan, Noah Brown, Justice Carbajal, Yevgen Chebotar, Joseph Dabis, Chelsea Finn, Keerthana Gopalakrishnan, Karol Hausman, Alex Herzog, Jasmine Hsu, Julian Ibarz, Brian Ichter, Alex Irpan, Tomas Jackson, Sally Jesmonth, Nikhil Joshi, Ryan Julian, Dmitry Kalashnikov, Yuheng Kuang, Isabel Leal,



- Kuang-Huei Lee, Sergey Levine, Yao Lu, Utsav Malla, Deeksha Manjunath, Igor Mordatch, Ofir Nachum, Carolina Parada, Jodilyn Peralta, Emily Perez, Karl Pertsch, Jornell Quiambao, Kanishka Rao, Michael Ryoo, Grecia Salazar, Pannag Sanketi, Kevin Sayed, Jaspiar Singh, Sumedh Sontakke, Austin Stone, Clayton Tan, Huong Tran, Vincent Vanhoucke, Steve Vega, Quan Vuong, Fei Xia, Ted Xiao, Peng Xu, Sichun Xu, Tianhe Yu, and Brianna Zitkovich. Rt-1: Robotics transformer for real-world control at scale. In *arXiv preprint arXiv:2212.06817*, 2022. 1, 3
- [13] Anthony Brohan, Noah Brown, Justice Carbajal, Yevgen Chebotar, Xi Chen, Krzysztof Choromanski, Tianli Ding, Danny Driess, Avinava Dubey, Chelsea Finn, Pete Florence, Chuyuan Fu, Montse Gonzalez Arenas, Keerthana Gopalakrishnan, Kehang Han, Karol Hausman, Alex Herzog, Jasmine Hsu, Brian Ichter, Alex Irpan, Nikhil Joshi, Ryan Julian, Dmitry Kalashnikov, Yuheng Kuang, Isabel Leal, Lisa Lee, Tsang-Wei Edward Lee, Sergey Levine, Yao Lu, Henryk Michalewski, Igor Mordatch, Karl Pertsch, Kanishka Rao, Krista Reymann, Michael Ryoo, Grecia Salazar, Pannag Sanketi, Pierre Sermanet, Jaspiar Singh, Anikait Singh, Radu Soricute, Huong Tran, Vincent Vanhoucke, Quan Vuong, Ayzaan Wahid, Stefan Welker, Paul Wohlhart, Jialin Wu, Fei Xia, Ted Xiao, Peng Xu, Sichun Xu, Tianhe Yu, and Brianna Zitkovich. Rt-2: Vision-language-action models transfer web knowledge to robotic control. In *arXiv preprint arXiv:2307.15818*, 2023. 3
- [14] Anais Brygo, Ioannis Sarakoglou, Nadia Garcia-Hernandez, and Nikolaos Tsagarakis. Humanoid robot teleoperation with vibrotactile based balancing feedback. In *Haptics: Neuroscience, Devices, Modeling, and Applications: 9th International Conference, EuroHaptics 2014, Versailles, France, June 24-26, 2014, Proceedings, Part II 9*, 2014. 3
- [15] Jean Chagas Vaz, Dylan Wallace, and Paul Y Oh. Humanoid loco-manipulation of pushed carts utilizing virtual reality teleoperation. In *ASME International Mechanical Engineering Congress and Exposition*, 2021. 3
- [16] Annie S Chen, Suraj Nair, and Chelsea Finn. Learning generalizable robotic reward functions from "in-the-wild" human videos. *arXiv preprint arXiv:2103.16817*, 2021. 3
- [17] Joel Chestnutt, Manfred Lau, German Cheung, James Kuffner, Jessica Hodgins, and Takeo Kanade. Footstep planning for the honda asimo humanoid. In *ICRA*, 2005. 2
- [18] Cheng Chi, Siyuan Feng, Yilun Du, Zhenjia Xu, Eric Cousineau, Benjamin Burchfiel, and Shuran Song. Diffusion policy: Visuomotor policy learning via action diffusion. In *Proceedings of Robotics: Science and Systems (RSS)*, 2023. 1, 2, 3, 5, 8, 9
- [19] R Cisneros, M Benallegue, K Kaneko, H Kam-inaga, G Caron, A Tanguy, R Singh, L Sun, A Dallard, C Fournier, et al. Team janus humanoid avatar: A cybernetic avatar to embody human telepresence. In *Toward Robot Avatars: Perspectives on the ANA Avatar XPRIZE Competition, RSS Workshop*, 2022. 3
- [20] Open X-Embodiment Collaboration, Abhishek Padalkar, Acorn Pooley, Ajinkya Jain, Alex Bewley, Alex Herzog, Alex Irpan, Alexander Khazatsky, Anant Rai, Anikait Singh, Anthony Brohan, Antonin Raffin, Ayzaan Wahid, Ben Burgess-Limerick, Beomjoon Kim, Bernhard Schölkopf, Brian Ichter, Cewu Lu, Charles Xu, Chelsea Finn, Chenfeng Xu, Cheng Chi, Chenguang Huang, Christine Chan, Chuer Pan, Chuyuan Fu, Coline Devin, Danny Driess, Deepak Pathak, Dhruv Shah, Dieter Büchler, Dmitry Kalashnikov, Dorsa Sadigh, Edward Johns, Federico Ceola, Fei Xia, Freek Stulp, Gaoyue Zhou, Gaurav S. Sukhatme, Gautam Salhotra, Ge Yan, Giulio Schiavi, Hao Su, Hao-Shu Fang, Haochen Shi, Heni Ben Amor, Henrik I Christensen, Hiroki Furuta, Homer Walke, Hongjie Fang, Igor Mordatch, Ilija Radosavovic, Isabel Leal, Jacky Liang, Jaehyung Kim, Jan Schneider, Jasmine Hsu, Jeannette Bohg, Jeffrey Bingham, Jiajun Wu, Jialin Wu, Jianlan Luo, Jiayuan Gu, Jie Tan, Jihoon Oh, Jitendra Malik, Jonathan Tompson, Jonathan Yang, Joseph J. Lim, João Silvério, Junhyek Han, Kanishka Rao, Karl Pertsch, Karol Hausman, Keegan Go, Keerthana Gopalakrishnan, Ken Goldberg, Kendra Byrne, Kenneth Oslund, Kento Kawaharazuka, Kevin Zhang, Keyvan Majd, Krishan Rana, Krishnan Srinivasan, Lawrence Yunliang Chen, Lerrel Pinto, Liam Tan, Lionel Ott, Lisa Lee, Masayoshi Tomizuka, Maximilian Du, Michael Ahn, Mingtong Zhang, Mingyu Ding, Mohan Kumar Srirama, Mohit Sharma, Moo Jin Kim, Naoaki Kanazawa, Nicklas Hansen, Nicolas Heess, Nikhil J Joshi, Niko Suenderhauf, Norman Di Palo, Nur Muhammad Mahi Shafiqullah, Oier Mees, Oliver Kroemer, Pannag R

- Sanketi, Paul Wohlhart, Peng Xu, Pierre Sermanet, Priya Sundareshan, Quan Vuong, Rafael Rafailov, Ran Tian, Ria Doshi, Roberto Martín-Martín, Russell Mendonca, Rutav Shah, Ryan Hoque, Ryan Julian, Samuel Bustamante, Sean Kirmani, Sergey Levine, Sherry Moore, Shikhar Bahl, Shivin Dass, Shuran Song, Sichun Xu, Siddhant Haldar, Simeon Adenola, Simon Guist, Soroush Nasiriany, Stefan Schaal, Stefan Welker, Stephen Tian, Sudeep Dasari, Suneel Belkhale, Takayuki Osa, Tatsuya Harada, Tatsuya Matsushima, Ted Xiao, Tianhe Yu, Tianli Ding, Todor Davchev, Tony Z. Zhao, Travis Armstrong, Trevor Darrell, Vidhi Jain, Vincent Vanhoucke, Wei Zhan, Wenxuan Zhou, Wolfram Burgard, Xi Chen, Xiaolong Wang, Xinghao Zhu, Xuanlin Li, Yao Lu, Yevgen Chebotar, Yifan Zhou, Yifeng Zhu, Ying Xu, Yixuan Wang, Yonatan Bisk, Yoonyoung Cho, Youngwoon Lee, Yuchen Cui, Yuehua Wu, Yujin Tang, Yuke Zhu, Yunzhu Li, Yusuke Iwasawa, Yutaka Matsuo, Zhuo Xu, and Zichen Jeff Cui. Open X-Embodiment: Robotic learning datasets and RT-X models. <https://arxiv.org/abs/2310.08864>, 2023. 1, 2, 3, 5
- [21] Zichen Jeff Cui, Yibin Wang, Nur Muhammad Mahi Shafiqullah, and Lerrel Pinto. From play to policy: Conditional behavior generation from uncurated robot data. *arXiv preprint arXiv:2210.10047*, 2022. 3
- [22] Stefano Dafarra, Kouros Darvish, Riccardo Grieco, Gianluca Milani, Ugo Pattacini, Lorenzo Rapetti, Giulio Romualdi, Mattia Salvi, Alessandro Scalzo, Ines Sorrentino, et al. icub3 avatar system. *arXiv preprint arXiv:2203.06972*, 2022. 3
- [23] Kouros Darvish, Yeshasvi Tirupachuri, Giulio Romualdi, Lorenzo Rapetti, Diego Ferigo, Francisco Javier Andrade Chavez, and Daniele Pucci. Whole-body geometric retargeting for humanoid robots. In *2019 IEEE-RAS 19th International Conference on Humanoid Robots (Humanoids)*, 2019. 3
- [24] Neha Das, Sarah Bechtle, Todor Davchev, Dinesh Jayaraman, Akshara Rai, and Franziska Meier. Model-based inverse reinforcement learning from visual demonstrations. In *Conference on Robot Learning*, pages 1930–1942. PMLR, 2021. 3
- [25] Sudeep Dasari and Abhinav Kumar Gupta. Transformers for one-shot visual imitation. In *Conference on Robot Learning*, 2020. 3
- [26] Anca D Dragan, Kenton CT Lee, and Siddhartha S Srinivasa. Legibility and predictability of robot motion. In *2013 8th ACM/IEEE International Conference on Human-Robot Interaction (HRI)*, 2013. 3
- [27] Yan Duan, Marcin Andrychowicz, Bradley C. Stadie, Jonathan Ho, Jonas Schneider, Ilya Sutskever, P. Abbeel, and Wojciech Zaremba. One-shot imitation learning. *ArXiv*, abs/1703.07326, 2017. 3
- [28] Frederik Ebert, Yanlai Yang, Karl Schmeckpeper, Bernadette Bucher, Georgios Georgakis, Kostas Daniilidis, Chelsea Finn, and Sergey Levine. Bridge data: Boosting generalization of robotic skills with cross-domain datasets. *ArXiv*, abs/2109.13396, 2021. 3
- [29] Ashley D Edwards and Charles L Isbell. Perceptual values from observation. *arXiv preprint arXiv:1905.07861*, 2019. 3
- [30] Peter Englert and Marc Toussaint. Learning manipulation skills from a single demonstration. *The International Journal of Robotics Research*, 37(1):137–154, 2018. 3
- [31] Hao-Shu Fang, Hongjie Fang, Zhenyu Tang, Jirong Liu, Chenxi Wang, Junbo Wang, Haoyi Zhu, and Cewu Lu. Rh20t: A comprehensive robotic dataset for learning diverse skills in one-shot. In *Towards Generalist Robots: Learning Paradigms for Scalable Skill Acquisition@CoRL2023*, 2023. 3, 5
- [32] Hongjie Fang, Hao-Shu Fang, Yiming Wang, Jieji Ren, Jingjing Chen, Ruo Zhang, Weiming Wang, and Cewu Lu. Low-cost exoskeletons for learning whole-arm manipulation in the wild. *arXiv preprint arXiv:2309.14975*, 2023. 3
- [33] Siyuan Feng, Eric Whitman, X Xinjilefu, and Christopher G Atkeson. Optimization based full body control for the atlas robot. In *International Conference on Humanoid Robots*, 2014. 2
- [34] Chelsea Finn, Tianhe Yu, Tianhao Zhang, Pieter Abbeel, and Sergey Levine. One-shot visual imitation learning via meta-learning. In *Conference on robot learning*, 2017. 3
- [35] Peter R. Florence, Corey Lynch, Andy Zeng, Oscar Ramirez, Ayzaan Wahid, Laura Downs, Adrian S. Wong, Johnny Lee, Igor Mordatch, and Jonathan Tompson. Implicit behavioral cloning. *ArXiv*, abs/2109.00137, 2021. 3
- [36] Zipeng Fu, Xuxin Cheng, and Deepak Pathak. Deep whole-body control: learning a unified policy for manipulation and locomotion. In *Conference on Robot Learning*, 2022. 3
- [37] Jean-Bastien Grill, Florian Strub, Florent Altché, Corentin Tallec, Pierre Richemond,

- Elena Buchatskaya, Carl Doersch, Bernardo Avila Pires, Zhaohan Guo, Mohammad Gheshlaghi Azar, et al. Bootstrap your own latent: a new approach to self-supervised learning. *Advances in neural information processing systems*, 33:21271–21284, 2020. 9
- [38] Jiayuan Gu, Devendra Singh Chaplot, Hao Su, and Jitendra Malik. Multi-skill mobile manipulation for object rearrangement. *ICLR*, 2023. 3
- [39] Abhinav Gupta, Adithyavairavan Murali, Dhiraaj Prakashchand Gandhi, and Lerrel Pinto. Robot learning in homes: Improving generalization and reducing dataset bias. *Advances in neural information processing systems*, 2018. 3
- [40] Kaiming He, X. Zhang, Shaoqing Ren, and Jian Sun. Deep residual learning for image recognition. *2016 IEEE Conference on Computer Vision and Pattern Recognition (CVPR)*, pages 770–778, 2015. 19
- [41] Kyle Hsu, Moo Jin Kim, Rafael Rafailov, Jiajun Wu, and Chelsea Finn. Vision-based manipulators need to also see from their hands. *ArXiv*, abs/2203.12677, 2022. URL <https://api.semanticscholar.org/CorpusID:247628166>. 9
- [42] Jiaheng Hu, Peter Stone, and Roberto Martín-Martín. Causal policy gradient for whole-body mobile manipulation. *arXiv preprint arXiv:2305.04866*, 2023. 3
- [43] Xiaoyu Huang, Dhruv Batra, Akshara Rai, and Andrew Szot. Skill transformer: A monolithic policy for mobile manipulation. In *Proceedings of the IEEE/CVF International Conference on Computer Vision*, 2023. 3
- [44] Auke Jan Ijspeert, Jun Nakanishi, Heiko Hoffmann, Peter Pastor, and Stefan Schaal. Dynamical movement primitives: learning attractor models for motor behaviors. *Neural computation*, 2013. 3
- [45] Yasuhiro Ishiguro, Tasuku Makabe, Yuya Nagamatsu, Yuta Kojio, Kunio Kojima, Fumihito Sugai, Yohei Kakiuchi, Kei Okada, and Masayuki Inaba. Bilateral humanoid teleoperation system using whole-body exoskeleton cockpit tablis. *IEEE Robotics and Automation Letters*, 2020. 3
- [46] Stephen James, Michael Bloesch, and Andrew J. Davison. Task-embedded control networks for few-shot imitation learning. *ArXiv*, abs/1810.03237, 2018. 3
- [47] Eric Jang, Alex Irpan, Mohi Khansari, Daniel Kappler, Frederik Ebert, Corey Lynch, Sergey Levine, and Chelsea Finn. Bc-z: Zero-shot task generalization with robotic imitation learning. In *Conference on Robot Learning*, 2022. 3
- [48] Snehal Jauhri, Jan Peters, and Georgia Chalvatzaki. Robot learning of mobile manipulation with reachability behavior priors. *IEEE Robotics and Automation Letters*, 2022. 3
- [49] Edward Johns. Coarse-to-fine imitation learning: Robot manipulation from a single demonstration. *2021 IEEE International Conference on Robotics and Automation (ICRA)*, pages 4613–4619, 2021. 3
- [50] Edward Johns. Coarse-to-fine imitation learning: Robot manipulation from a single demonstration. In *2021 IEEE international conference on robotics and automation (ICRA)*, pages 4613–4619. IEEE, 2021. 3
- [51] Matthew Johnson, Brandon Shrewsbury, Sylvain Bertrand, Tingfan Wu, Daniel Duran, Marshall Floyd, Peter Abeles, Douglas Stephen, Nathan Mertins, Alex Lesman, et al. Team ihmc’s lessons learned from the darpa robotics challenge trials. *Journal of Field Robotics*, 2015. 3
- [52] Oussama Khatib, K Yokoi, K Chang, D Ruspini, R Holmberg, A Casal, and A Baader. Force strategies for cooperative tasks in multiple mobile manipulation systems. In *Robotics Research: The Seventh International Symposium*, 1996. 2
- [53] Doik Kim, Bum-Jae You, and Sang-Rok Oh. Whole body motion control framework for arbitrarily and simultaneously assigned upper-body tasks and walking motion. *Modeling, Simulation and Optimization of Bipedal Walking*, 2013. 3
- [54] Heecheol Kim, Yoshiyuki Ohmura, and Yasuo Kuniyoshi. Robot peels banana with goal-conditioned dual-action deep imitation learning. *ArXiv*, abs/2203.09749, 2022. 3
- [55] Jens Kober and Jan Peters. Learning motor primitives for robotics. In *2009 IEEE International Conference on Robotics and Automation*, 2009. 3
- [56] Eric Krotkov, Douglas Hackett, Larry Jackel, Michael Perschbacher, James Pippine, Jesse Strauss, Gill Pratt, and Christopher Orłowski. The darpa robotics challenge finals: Results and perspectives. *The DARPA Robotics Challenge Finals: Humanoid Robots To The Rescue*, 2018. 2
- [57] Corey Lynch, Mohi Khansari, Ted Xiao, Vikash Kumar, Jonathan Tompson, Sergey Levine, and Pierre Sermanet. Learning latent



- plans from play. In *Conference on robot learning*, pages 1113–1132. PMLR, 2020. 3
- [58] Yuntao Ma, Farbod Farshidian, Takahiro Miki, Joonho Lee, and Marco Hutter. Combining learning-based locomotion policy with model-based manipulation for legged mobile manipulators. *IEEE Robotics and Automation Letters*, 2022. 3
- [59] Ajay Mandlekar, Danfei Xu, J. Wong, Soroush Nasiriany, Chen Wang, Rohun Kulkarni, Li Fei-Fei, Silvio Savarese, Yuke Zhu, and Roberto Mart’ın-Mart’ın. What matters in learning from offline human demonstrations for robot manipulation. In *Conference on Robot Learning*, 2021. 3
- [60] Suraj Nair, Aravind Rajeswaran, Vikash Kumar, Chelsea Finn, and Abhinav Gupta. R3m: A universal visual representation for robot manipulation. *arXiv preprint arXiv:2203.12601*, 2022. 3
- [61] Octo Model Team, Dibya Ghosh, Homer Walke, Karl Pertsch, Kevin Black, Oier Mees, Sudeep Dasari, Joey Hejna, Charles Xu, Jianlan Luo, Tobias Kreiman, You Liang Tan, Dorsa Sadigh, Chelsea Finn, and Sergey Levine. Octo: An open-source generalist robot policy. <https://octo-models.github.io>, 2023. 3, 5
- [62] Alexandros Paraschos, Christian Daniel, Jan Peters, and Gerhard Neumann. Using probabilistic movement primitives in robotics. *Autonomous Robots*, 42:529–551, 2018. 3
- [63] Jyothish Pari, Nur Muhammad Shafiullah, Sridhar Pandian Arunachalam, and Lerrel Pinto. The surprising effectiveness of representation learning for visual imitation. *arXiv preprint arXiv:2112.01511*, 2021. 3, 5, 8, 9
- [64] Peter Pastor, Heiko Hoffmann, Tamim Asfour, and Stefan Schaal. Learning and generalization of motor skills by learning from demonstration. *2009 IEEE International Conference on Robotics and Automation*, pages 763–768, 2009. 3
- [65] Luigi Penco, Nicola Scianca, Valerio Modugno, Leonardo Lanari, Giuseppe Oriolo, and Serena Ivaldi. A multimode teleoperation framework for humanoid loco-manipulation: An application for the icub robot. *IEEE Robotics & Automation Magazine*, 2019. 3
- [66] Luka Peternel and Jan Babič. Learning of compliant human–robot interaction using full-body haptic interface. *Advanced Robotics*, 2013. 3
- [67] Dean A. Pomerleau. Alvin: An autonomous land vehicle in a neural network. In *NIPS*, 1988. 1, 3
- [68] Amartya Purushottam, Yeongtae Jung, Christopher Xu, and Joao Ramos. Dynamic mobile manipulation via whole-body bilateral teleoperation of a wheeled humanoid. *arXiv preprint arXiv:2307.01350*, 2023. 3
- [69] Ilija Radosavovic, Tete Xiao, Stephen James, Pieter Abbeel, Jitendra Malik, and Trevor Darrell. Real-world robot learning with masked visual pre-training. *CoRL*, 2022. 3
- [70] Ilija Radosavovic, Baifeng Shi, Letian Fu, Ken Goldberg, Trevor Darrell, and Jitendra Malik. Robot learning with sensorimotor pre-training. *arXiv preprint arXiv:2306.10007*, 2023. 9
- [71] Rouhollah Rahmatizadeh, Pooya Abolghasemi, Ladislau Bölöni, and Sergey Levine. Vision-based multi-task manipulation for inexpensive robots using end-to-end learning from demonstration. *2018 IEEE International Conference on Robotics and Automation (ICRA)*, pages 3758–3765, 2017. 3
- [72] Joao Ramos and Sangbae Kim. Humanoid dynamic synchronization through whole-body bilateral feedback teleoperation. *IEEE Transactions on Robotics*, 2018. 3
- [73] Olaf Ronneberger, Philipp Fischer, and Thomas Brox. U-net: Convolutional networks for biomedical image segmentation. *ArXiv*, abs/1505.04597, 2015. URL <https://api.semanticscholar.org/CorpusID:3719281>. 19
- [74] Erick Rosete-Beas, Oier Mees, Gabriel Kalweit, Joschka Boedecker, and Wolfram Burgard. Latent plans for task-agnostic offline reinforcement learning. In *Conference on Robot Learning*, pages 1838–1849. PMLR, 2023. 3
- [75] Max Schwarz, Christian Lenz, Andre Rochow, Michael Schreiber, and Sven Behnke. Nimbro avatar: Interactive immersive telepresence with force-feedback telemanipulation. In *2021 IEEE/RSJ International Conference on Intelligent Robots and Systems (IROS)*, pages 5312–5319, 2021. 3
- [76] Mingyo Seo, Steve Han, Kyutae Sim, Seung Hyeon Bang, Carlos Gonzalez, Luis Sentis, and Yuke Zhu. Deep imitation learning for humanoid loco-manipulation through human teleoperation. *Humanoids*, 2023. 3
- [77] Nur Muhammad (Mahi) Shafiullah, Zichen Jeff Cui, Ariuntuya Altanzaya, and Lerrel Pinto. Behavior transformers: Cloning k modes with one stone. *ArXiv*, abs/2206.11251, 2022. 3

- [78] Nur Muhammad Mahi Shafiullah, Anant Rai, Haritheja Etukuru, Yiqian Liu, Ishan Misra, Soumith Chintala, and Lerrel Pinto. On bringing robots home. *arXiv preprint arXiv:2311.16098*, 2023. 3
- [79] Dhruv Shah, Ajay Sridhar, Arjun Bhorkar, Noriaki Hirose, and Sergey Levine. Gnm: A general navigation model to drive any robot. In *2023 IEEE International Conference on Robotics and Automation (ICRA)*, pages 7226–7233. IEEE, 2023. 3, 5
- [80] Lin Shao, Toki Migimatsu, Qiang Zhang, Karen Yang, and Jeannette Bohg. Concept2robot: Learning manipulation concepts from instructions and human demonstrations. *The International Journal of Robotics Research*, 40(12-14):1419–1434, 2021. 3
- [81] Lucy Xiaoyang Shi, Archit Sharma, Tony Z Zhao, and Chelsea Finn. Waypoint-based imitation learning for robotic manipulation. *CoRL*, 2023. 2, 3, 5
- [82] Mohit Shridhar, Lucas Manuelli, and Dieter Fox. Cliport: What and where pathways for robotic manipulation. *ArXiv*, abs/2109.12098, 2021. 3
- [83] Mohit Shridhar, Lucas Manuelli, and Dieter Fox. Perceiver-actor: A multi-task transformer for robotic manipulation. *ArXiv*, abs/2209.05451, 2022. 3
- [84] Laura Smith, Nikita Dhawan, Marvin Zhang, Pieter Abbeel, and Sergey Levine. Avid: Learning multi-stage tasks via pixel-level translation of human videos. *arXiv preprint arXiv:1912.04443*, 2019. 3
- [85] Jiaming Song, Chenlin Meng, and Stefano Ermon. Denoising diffusion implicit models. *arXiv preprint arXiv:2010.02502*, 2020. 9, 19
- [86] Charles Sun, Jędrzej Orbik, Coline Manon Devin, Brian H Yang, Abhishek Gupta, Glen Berseth, and Sergey Levine. Fully autonomous real-world reinforcement learning with applications to mobile manipulation. In *Conference on Robot Learning*, 2021. 3
- [87] Susumu Tachi, Yasuyuki Inoue, and Fumihiro Kato. Telesar vi: Telexistence surrogate anthropomorphic robot vi. *International Journal of Humanoid Robotics*. 3
- [88] Eugene Valassakis, Georgios Papagiannis, Norman Di Palo, and Edward Johns. Demonstrate once, imitate immediately (dome): Learning visual servoing for one-shot imitation learning. In *2022 IEEE/RSJ International Conference on Intelligent Robots and Systems (IROS)*, 2022. 3
- [89] Chen Wang, Linxi Fan, Jiankai Sun, Ruohan Zhang, Li Fei-Fei, Danfei Xu, Yuke Zhu, and Anima Anandkumar. Mimicplay: Long-horizon imitation learning by watching human play. *arXiv preprint arXiv:2302.12422*, 2023. 3
- [90] Josiah Wong, Albert Tung, Andrey Kurenkov, Ajay Mandlekar, Li Fei-Fei, Silvio Savarese, and Roberto Martín-Martín. Error-aware imitation learning from teleoperation data for mobile manipulation. In *Conference on Robot Learning*, 2022. 3
- [91] Bohan Wu, Roberto Martín-Martín, and Li Fei-Fei. M-ember: Tackling long-horizon mobile manipulation via factorized domain transfer. *ICRA*, 2023. 3
- [92] Jimmy Wu, Rika Antonova, Adam Kan, Marion Lepert, Andy Zeng, Shuran Song, Jeannette Bohg, Szymon Rusinkiewicz, and Thomas Funkhouser. Tidybot: Personalized robot assistance with large language models. *IROS*, 2023. 3
- [93] Keenan A Wyrobek, Eric H Berger, HF Machiel Van der Loos, and J Kenneth Salisbury. Towards a personal robotics development platform: Rationale and design of an intrinsically safe personal robot. In *2008 IEEE International Conference on Robotics and Automation*, 2008. 2
- [94] Fei Xia, Chengshu Li, Roberto Martín-Martín, Or Litany, Alexander Toshev, and Silvio Savarese. Relmogen: Integrating motion generation in reinforcement learning for mobile manipulation. In *2021 IEEE International Conference on Robotics and Automation (ICRA)*, 2021. 3
- [95] Annie Xie, Lisa Lee, Ted Xiao, and Chelsea Finn. Decomposing the generalization gap in imitation learning for visual robotic manipulation. *arXiv preprint arXiv:2307.03659*, 2023. 5
- [96] Haoyu Xiong, Quanzhou Li, Yun-Chun Chen, Homanga Bharadhwaj, Samarth Sinha, and Animesh Garg. Learning by watching: Physical imitation of manipulation skills from human videos. In *2021 IEEE/RSJ International Conference on Intelligent Robots and Systems (IROS)*, pages 7827–7834. IEEE, 2021. 3
- [97] Jingyun Yang, Junwu Zhang, Connor Settle, Akshara Rai, Rika Antonova, and Jeannette Bohg. Learning periodic tasks from human demonstrations. In *2022 International Confer-*

- ence on Robotics and Automation (ICRA)*, pages 8658–8665. IEEE, 2022. [3](#)
- [98] Jonathan Heewon Yang, Dorsa Sadigh, and Chelsea Finn. Polybot: Training one policy across robots while embracing variability. In *Conference on Robot Learning*, pages 2955–2974. PMLR, 2023. [3](#)
- [99] Ruihan Yang, Yejin Kim, Aniruddha Kembhavi, Xiaolong Wang, and Kiana Ehsani. Harmonic mobile manipulation. *arXiv preprint arXiv:2312.06639*, 2023. [3](#)
- [100] Taozheng Yang, Ya Jing, Hongtao Wu, Jiafeng Xu, Kuankuan Sima, Guangzeng Chen, Qie Sima, and Tao Kong. Moma-force: Visual-force imitation for real-world mobile manipulation. *arXiv preprint arXiv:2308.03624*, 2023. [3](#)
- [101] Naoki Yokoyama, Alexander William Clegg, Eric Undersander, Sehoon Ha, Dhruv Batra, and Akshara Rai. Adaptive skill coordination for robotic mobile manipulation. *arXiv preprint arXiv:2304.00410*, 2023. [3](#)
- [102] Tianhe Yu, Chelsea Finn, Annie Xie, Sudeep Dasari, Tianhao Zhang, Pieter Abbeel, and Sergey Levine. One-shot imitation from observing humans via domain-adaptive meta-learning. *arXiv preprint arXiv:1802.01557*, 2018. [3](#)
- [103] Andy Zeng, Peter R. Florence, Jonathan Tompson, Stefan Welker, Jonathan Chien, Maria Attarian, Travis Armstrong, Ivan Krasin, Dan Duong, Vikas Sindhwani, and Johnny Lee. Transporter networks: Rearranging the visual world for robotic manipulation. In *Conference on Robot Learning*, 2020. [3](#)
- [104] Tony Z Zhao, Vikash Kumar, Sergey Levine, and Chelsea Finn. Learning fine-grained bimanual manipulation with low-cost hardware. *RSS*, 2023. [1](#), [2](#), [3](#), [4](#), [5](#), [8](#), [9](#)



## A. Appendix

### A.1. High Five



**High Five:** The robot base is initialized next to the kitchen island. The robot keeps moving around the kitchen island until a human is in front of it, then high five with the human. Each demo has 2000 steps or 40 seconds, and typically contains 3-4 high fives.

**Figure 6: Task Definition of High Five.**

We include the illustration for the *High Five* task in Figure 6. The robot needs to go around the kitchen island, and whenever a human approach it from the front, stop moving and high five with the human. After the high five, the robot should continue moving only when the human moves out of its path. We collect data wearing different clothes and evaluate the trained policy on unseen persons and unseen attires. While this task does not require a lot of precision, it highlights *Mobile ALOHA*'s potential for studying human-robot interactions.

### A.2. Example Image Observations

Figure 7 showcases example images of *Wipe Wine* captured during data collection. The images, arranged sequentially in time from top to bottom, are sourced from three different camera angles from left to right columns: the top egocentric camera, the left wrist camera, and the right wrist camera. The top camera is stationary with respect to the robot frame. In contrast, the wrist cameras are attached to the arms, providing close-up views of the gripper in action. All cameras are set with a fixed focal length and feature auto-exposure to adapt to varying light conditions. These cameras stream at a resolution of  $480 \times 640$  and a frame rate of 30 frames per second.



**Figure 7: Example Image Observations of Wipe Wine.** We show the observations from the top camera, left wrist camera and right wrist camera from left to right columns. These images are arranged sequentially in time from top to bottom.

### A.3. Experiment Details and Hyperparameters of ACT, Diffusion Policy and VINN

We carefully tune the baselines and include the hyperparameters for the baselines and co-training in Table 5, 6, 7, 8, 9.

sample prob. from <i>Mobile ALOHA</i> data	0.5
sample prob. from <i>ALOHA</i> data	0.5

**Table 5: Hyperparameters of co-training.**

learning rate	2e-5
batch size	16
# encoder layers	4
# decoder layers	7
feedforward dimension	3200
hidden dimension	512
# heads	8
chunk size	45
beta	10
dropout	0.1
backbone	pretrained ResNet18[40]

**Table 6: Hyperparameters of ACT.**

learning rate	1e-4
batch size	32
chunk size	64
scheduler	DDIM[85]
train and test diffusion steps	50, 10
ema power	0.75
backbone	pretrained ResNet18[40]
noise predictor	UNet[73]
image augmentation	RandomCrop(ratio=0.95) & ColorJitter(brightness=0.3, contrast=0.4, saturation=0.5) & RandomRotation(degrees=[-5.0, 5.0])

**Table 7: Hyperparameters of Diffusion Policy.**

learning rate	3e-4
batch size	128
epochs	100
momentum	0.9
weight decay	1.5e-6

**Table 8: Hyperparameters of BYOL, the feature extractor of VINN.**

k (nearest neighbour)	selected with lowest validation loss
chunk size	100
state weight	5
camera feature weight	1:1:1 (for front, left and right wrist)

**Table 9: Hyperparameters of VINN + Chunking.**

#### A.4. Open-Loop Replaying Errors

Figure 8 shows the spread of end-effector error at the end of replaying a 300 steps (6s) demonstration. The demonstration contains a 180 degree turn with radius of roughly 1m. At the end of the trajectory, the right arm would reach out to a piece of paper on the table and tap it gently. The tapping position are then marked on the paper. The red cross denotes the original tapping position, and the red dots are 20 replays of the same trajectory. We observe significant error when replaying the base velocity profile, which is expected due to the stochasticity of the ground contact and low-level controller. Specifically, all replay points are biased to the left side by roughly 10cm, and spread along a line of roughly 20cm. We found our policy to be capable of correcting such errors without explicit localization such as SLAM.

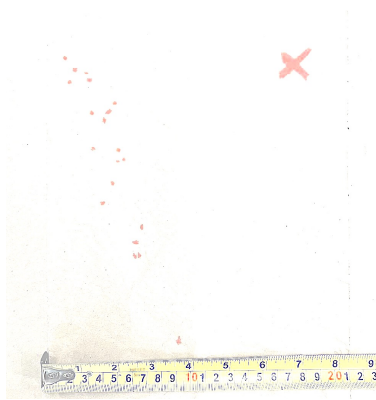

**Figure 8: *Open-loop Replay Errors.*** We mark the right arm end-effector position on a piece of paper for the original episode (red cross), and 20 replays of the same episode (red dots).