

MINIMAL SKEW SEMISTANDARD TABLEAUX AND THE HILLMAN–GRASSL CORRESPONDENCE

ALEJANDRO H. MORALES, GRETA PANOVA, AND GAYEE PARK

ABSTRACT. Standard tableaux of skew shape are fundamental objects in enumerative and algebraic combinatorics and no product formula for the number is known. In 2014, Naruse gave a formula (NHLF) as a positive sum over excited diagrams of products of hook-lengths. Subsequently, Morales, Pak, and Panova gave a q -analogue of this formula in terms of skew semistandard tableaux (SSYT). They also showed, partly algebraically, that the Hillman–Grassl map, restricted to skew semistandard tableaux, is behind their q -analogue. We study the problem of circumventing the algebraic part and proving the bijection completely combinatorially, which we do for border strips. For a skew shape, we define minimal semistandard Young tableaux, that are in correspondence with excited diagrams via a new description of the Hillman–Grassl bijection and have an analogue of excited moves. Lastly, we relate the minimal skew SSYT with the terms of the Okounkov–Olshanski formula (OOF) for counting standard tableaux of skew shape. Our construction immediately implies that the summands in the NHLF are less than the summands in the OOF and we characterize the shapes where both formulas have the same number of summands.

1. INTRODUCTION

Standard and semistandard tableaux are fundamental objects in enumerative and algebraic combinatorics. Standard Young Tableaux (SYT) are fillings of the Young diagram of λ with numbers $1, 2, \dots, n$ increasing in the rows and columns. The number of SYTs of shape λ is f^λ , and can also be interpreted as counting linear extension of a certain poset associated to λ . Counting linear extensions of posets is in general computationally hard; however, the number f^λ is given by the famous *hook-length formula* of Frame–Robinson–Thrall [2] 1954.

Theorem 1.1 (Frame–Robinson–Thrall [2]). *For λ a partition of n we have*

$$(1.1) \quad f^\lambda = \frac{n!}{\prod_{(i,j) \in [\lambda]} h(i,j)},$$

where $[\lambda]$ is the Young diagram of λ and $h(i,j) = \lambda_i - i + \lambda'_j - j + 1$ is the hook-length of the square (i,j) : the number of cells directly to the right and directly below (i,j) including (i,j) .

The number of standard tableaux of skew shape $f^{\lambda/\mu}$ gives the dimension of irreducible representations of affine Hecke algebras [25]. Unlike for straight shapes, there is no product formula for $f^{\lambda/\mu}$. There are determinantal formulas for $f^{\lambda/\mu}$ like the *Jacobi–Trudi identity*. There is also a classical positive formula for $f^{\lambda/\mu}$ involving the *Littlewood–Richardson coefficients* $c_{\mu,\nu}^\lambda$. These formulas, however, are generally not practical for asymptotic estimates.

Central to this paper are two other positive formulas for $f^{\lambda/\mu}$ coming from equivariant Schubert calculus or more explicitly from evaluations of *factorial Schur functions*: the Okounkov–Olshanski formula [22] from 1998 and the Naruse hook-length formula [20] from 2014. We start with the latter since it resembles (1.1).

Date: November 16, 2023.

A. H. Morales was partially supported by NSF grant DMS-1855536 and DMS-2154019, G. Park was partially supported by NSF grant DMS-1855536, and G. Panova was partially supported by the NSF grant DMS-1939717.

Theorem 1.2 (Naruse [20], [16]). *For a skew shape λ/μ of size n we have*

$$(NHLF) \quad f^{\lambda/\mu} = \frac{n!}{\prod_{u \in [\lambda]} h(u)} \sum_{D \in \mathcal{E}(\lambda/\mu)} \prod_{u \in D} h(u) = n! \sum_{D \in \mathcal{E}(\lambda/\mu)} \prod_{u \in [\lambda] \setminus D} \frac{1}{h(u)},$$

where $\mathcal{E}(\lambda/\mu)$ is the set of excited diagrams of λ/μ .

The excited diagrams of shape λ/μ , denoted by $\mathcal{E}(\lambda/\mu)$, are certain subsets of size $|\mu|$ of the Young diagram of λ obtained from the Young diagram of $[\mu]$ by recursively doing local moves. Excited diagrams are in correspondence with certain semisandard Young tableaux (SSYT) of shape μ that are *flagged*, i.e. with certain bounds on the entries in each row. The NHLF has been actively studied since 2015 by Morales–Pak–Panova [16, 15, 17, 18], Konvalinka [11, 12], Naruse–Okada [21] and has applications and extensions in [1, 8, 24].

The other positive formula by Okounkov–Olshanski is also a sum over certain SSYT of shape μ with entries at most $\ell(\lambda)$ called *Okounkov–Olshanski tableaux* $\mathcal{OOT}(\lambda/\mu)$.

Theorem 1.3 (Okounkov–Olshanski [22]). *For a skew shape λ/μ of size n we have*

$$(OOF) \quad f^{\lambda/\mu} = \frac{n!}{\prod_{u \in [\lambda]} h(u)} \sum_{T \in \mathcal{OOT}(\lambda/\mu)} \prod_{(i,j) \in [\mu]} (\lambda_{d+1-T(i,j)} + i - j),$$

where $d = \ell(\lambda)$ and $\mathcal{OOT}(\lambda/\mu)$ is the set of SSYT T of shape μ with entries $\leq d$ such that $j - i < \lambda_{d+1-T(i,j)}$ for all $(i, j) \in [\mu]$.

In [19], Morales–Zhu did a similar study of (OOF) as Morales–Pak–Panova did for (NHLF). In particular, they gave in [19, Cor. 5.7] a reformulation of (OOF) in terms of the following flagged tableaux: SSYT of shape λ/μ with entries in row i are at most i whose set we denote by $\mathcal{SF}(\lambda/\mu)$. These flagged tableaux correspond to *reverse excited diagrams*, certain subsets of size $|\lambda/\mu|$ of the Young diagram *shifted shape* λ^* similar to excited diagrams.

Corollary 1.4 (Flagged tableaux formulation of (OOF)). *For a skew shape λ/μ of size n we have*

$$(1.2) \quad f^{\lambda/\mu} = \frac{n!}{\prod_{u \in [\lambda]} h(u)} \sum_{T \in \mathcal{SF}(\lambda/\mu)} \prod_{(j,t) \in M(T)} (\lambda_t - t + i(j, t) - j + 1),$$

where $M(T)$ is a certain set of labels on the horizontal edges of T between the cells $(i(j, t), j)$ and $((i(j, t) + 1, j))$ so that column j of T has all the numbers from 1 to λ'_j from top to bottom.

1.1. Minimal skew tableaux and new reformulation of (NHLF). A natural question which is the start of our investigation is to find a reformulation of (NHLF) in terms of certain SSYT of skew shape λ/μ . We define the set $\text{SSYT}_{\min}(\lambda/\mu)$ of *minimal skew SSYT* obtained from the SSYT T_0 of shape λ/μ with entries $\{0, 1, \dots, \lambda'_i - \mu'_i - 1\}$ by recursively applying certain local moves. Our first result is a bijection Φ between excited diagrams and tableaux $\text{SSYT}_{\min}(\lambda/\mu)$ that commutes with the respective local moves (Lemma 3.9).

Theorem 3.6. *For a skew shape λ/μ the map $\Phi : \mathcal{E}(\lambda/\mu) \rightarrow \text{SSYT}_{\min}(\lambda/\mu)$ is a bijection that commutes with the respective local moves, that is $\Phi \circ \beta = \delta \circ \Phi$.*

As a corollary we obtain a new reformulation of (NHLF). Let $(\theta_1, \dots, \theta_k)$ be the *Lascoux–Pragacz* decomposition of the shape λ/μ into border strips (see Section 2.3).

Corollary 4.1 (minimal tableaux reformulation of (NHLF)). *For a skew shape λ/μ of size n we have*

$$(4.1) \quad f^{\lambda/\mu} = \frac{n!}{\prod_{u \in [\lambda]} h(u)} \sum_{T \in \text{SSYT}_{\min}(\lambda/\mu)} \prod_{(i,j) \in [\mu]} h(i + \alpha, j + \alpha),$$

where α is the number strips θ_k such that $\bar{T}(\theta_k(j)) > \mu'_j - i$ and $\bar{T} = T - T_0$.

We give an explicit non-recursive description of the tableaux in $\text{SSYT}_{\min}(\lambda/\mu)$ in terms of the Lascoux–Pragacz [14] decomposition of λ/μ into border strips (see Theorem 3.10) that immediately shows they are a subset of the skew flagged tableaux $\mathcal{SF}(\lambda/\mu)$ from (2.2). As an application, we obtain that the Naruse formula has fewer terms than the Okounkov–Olshanski formula and characterize the skew shapes where equality is attained. We denote the number of terms of each formula by $\text{ED}(\lambda)$ and $\text{OOT}(\lambda/\mu)$, respectively.

Theorem 5.5. *For a connected skew shape λ/μ with $d = \ell(\lambda)$ and $r = \max\{i \mid \mu_1 = \mu_i\}$ we have that $\text{ED}(\lambda/\mu) \leq \text{OOT}(\lambda/\mu)$ with equality if and only if $\lambda_d \geq \mu_r + d - r$.*

1.2. Relation with the Hillman–Grassl correspondence. The hook-length formula (1.1) has a q -analogue by Littlewood that is a special case of Stanley’s hook-content formula for the generating series of SSYT of shape λ .

Theorem 1.5 (Littlewood). *For a partition λ we have*

$$(1.3) \quad s_\lambda(1, q, q^2, \dots) = q^{b(\lambda)} \cdot \prod_{u \in \lambda} \frac{1}{1 - q^{h(u)}}.$$

Hillman and Grassl give a bijective proof of this via a correspondence $HG(\cdot)$ between reverse plane partitions of shape λ and arrays of nonnegative integers of shape λ . The correspondence $HG(\cdot)$ is related to the famous RSK correspondence (see [16]) and has recent connections to *quiver representations* [4].

In [16], Morales–Pak–Panova gave a q -analogues of (NHLF) for the generating functions of SSYT of skew shape λ/μ .

Theorem 1.6 ([16]). *For a skew shape λ/μ we have*

$$(1.4) \quad s_{\lambda/\mu}(1, q, q^2, \dots) = \sum_{D \in \mathcal{E}(\lambda/\mu)} \prod_{(i,j) \in [\lambda] \setminus D} \frac{q^{\lambda'_j - i}}{1 - q^{h(i,j)}}.$$

This identity corresponds to restricting the Hillman–Grassl bijection to SSYT of shape λ/μ [16]. The resulting arrays have support on the complement of excited diagrams and with certain forced nonzero entries on *broken diagonals*. In [16] two of the authors with Pak proved equation (1.4) algebraically, and showed that the inverse Hillman–Grassl map is an injection to SSYT of shape λ/μ . This implied that the restricted Hillman–Grassl map is a bijection between skew SSYT and excited arrays.

The proof of this connection with the Hillman–Grassl map is partially deduced from the algebraic identity and remains mysterious.

Our second main result is to show that the bijection between minimal tableaux and excited diagrams coincides with the Hillman–Grassl map.

Theorem 6.1. *The map Φ^{-1} is equivalent to the Hillman–Grassl map HG on the minimal SSYT of shape λ/μ . That is, for T in $\text{SSYT}_{\min}(\lambda/\mu)$ we have*

$$HG(T) = A_D \text{ if and only if } \Phi^{-1}(T) = D,$$

where the array A_D in $\mathcal{A}^*(\lambda/\mu)$ corresponds to D in $\mathcal{E}(\lambda/\mu)$; i.e. $HG^{-1}(A_D) = \Phi(D)$.

We obtain a bijective proof of the following identity, between the *leading terms* of each summand on the right-hand-side of (1.4).

Corollary 6.7. *For a skew shape λ/μ we have*

$$(6.3) \quad \sum_{T \in \text{SSYT}_{\min}(\lambda/\mu)} q^{|T|} = \sum_{D \in \mathcal{E}(\lambda/\mu)} q^{\sum_{(i,j) \in D} (\lambda'_j - i)}.$$

formulation	NHLF	OOF
shape μ	flagged tableaux of shape μ [13, 16] excited diagrams [20]	Okounkov–Olshanski tableaux [19]
skew shape λ/μ	minimal skew SSYT	flagged tableaux of shape λ/μ [19] reverse excited diagrams [19]

TABLE 1. The different formulations of the Naruse hook-length formula (NHLF) and the Okounkov–Olshanski formula (OOF).

Special cases of this identity give q -binomial coefficients and q -Catalan numbers (see Section 6.2).

We further investigate the Hillman–Grassl bijection restricted to SSYT of shape λ and λ/μ . We give a fully combinatorial proof of (1.3) for border strips (see Theorem 7.1). For straight shapes λ , we show the following remarkable additivity property of the Hillman–Grassl correspondence. Let $T_{\min}(\lambda)$ be the SSYT of shape λ with entries $i - 1$ in row i .

Theorem 8.1. *Let T be in $\text{RPP}(\lambda)$ and let $T_{\min} = T_{\min}(\lambda)$ be the minimum SSYT of shape λ*

$$HG(T) + HG(T_{\min}) = HG(T + T_{\min}).$$

The additivity fails for the case of skew shapes when T_{\min} is replaced by minimal skew SSYT.

OUTLINE

The paper is divided as follows. In Section 2, we give background and definitions. In Section 3, we introduce minimal SSYT of shape λ/μ and show the bijection Φ between the minimal SSYT and the excited diagram of shape λ/μ . We also give a non-recursive definition of the minimal SSYT and the description of the inverse of Φ . In Section 4, we give the reformulation of the Naruse hook formula in terms of minimal SSYT and in Section 5 we give the comparison between the minimal SSYT and Okounkov–Olshanski tableaux.

In Section 6, we show the relation between the bijection Φ and the Hillman–Grassl bijection and (Theorem 6.1) and give consequence of this result. We give a bijective proof of (1.4) for the case of border-strips in Section 7. In Section 8, we prove the additivity property of Hillman–Grassl on straight shapes and give counter-examples of such additivity for skew shapes. Finally we end with the final remarks in Section 9 which includes a comparison between (NHLF) and (OOF) with the classical formula (9.1) for $f^{\lambda/\mu}$ involving Littlewood–Richardson coefficients.

2. BACKGROUND

2.1. Young diagrams and tableaux. Let $\lambda = (\lambda_1, \dots, \lambda_\ell)$ denote an integer partition of lengths $\ell = \ell(\lambda)$ and size $|\lambda| = \sum_{i=1}^{\ell} \lambda_i$. We denote by $[\lambda] := \{(i, j) \mid 1 \leq j \leq \lambda_i, 1 \leq i \leq \ell\}$ the *Young diagram* of λ . For $(i, j) \in [\lambda]$, we denote by $h(i, j) = \lambda_i + \lambda'_j - i - j + 1$ the *hook length* of (i, j) in $[\lambda]$, and $c(i, j) = j - i$ the *content* of (i, j) . A *skew shape* is denoted by λ/μ and its size is $|\lambda/\mu| = |\lambda| - |\mu|$. We assume that λ/μ is connected. Given a skew shape λ/μ of length d , we denote λ^*/μ^* the *shifted skew shape* $(\lambda_1 + d - 1, \lambda_2 + d - 2, \dots, \lambda_d)/(\mu_1 + d - 1, \mu_2 + 2 - 2, \dots, \mu_d)$. We denote the staircase partition by $\delta_n = (n - 1, n - 2, \dots, 1)$.

A *reverse plane partition* of shape λ/μ is an array π of shape λ/μ filled with nonnegative integers that is weakly increasing in rows and columns. We denote the set of such plane partitions by $\text{RPP}(\lambda/\mu)$ and the size of a plane partition π is the sum of its entries and is denoted by $|\pi|$. A *semistandard Young tableaux* of shape λ/μ is a reverse plane partition of shape λ/μ that is strictly increasing in columns. We denote the set of such tableaux by $\text{SSYT}(\lambda/\mu)$. Similarly, $\text{SSYT}(\lambda/\mu, m)$ denotes the set of SSYT of shape λ/μ and entries $\leq m$. A *standard tableaux* of shape λ/μ of size n is an array T of shape λ/μ with the numbers $1, \dots, n$, each number appearing once, that is increasing in rows and columns. We denote the number of such tableaux by $f^{\lambda/\mu}$.

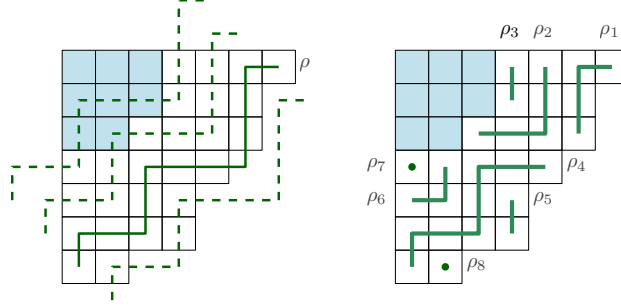

FIGURE 1. A decomposition of shape λ/μ into the border strips (ρ_1, \dots, ρ_8) using the cutting strip ρ .

Note that for straight shapes λ , the generating functions of $\text{RPP}(\lambda)$ and $\text{SSYT}(\lambda)$ are proportional given by the direct bijection $T(i, j) \rightarrow T(i, j) - j$:

$$(2.1) \quad \sum_{T \in \text{SSYT}(\lambda)} q^{|T|} = q^{b(\lambda)} \sum_{T \in \text{RPP}(\lambda)} q^{|T|},$$

where $b(\lambda) = \sum_i (i-1)\lambda_i$.

2.2. Schur functions. Given a skew partition λ/μ and variables $\mathbf{x} = (x_1, x_2, \dots)$, let

$$s_{\lambda/\mu}(\mathbf{x}) = \sum_{T \in \text{SSYT}(\lambda/\mu)} \mathbf{x}^T,$$

where $\mathbf{x}^T = x_1^{\#\text{1s in } T} x_2^{\#\text{2s in } T} \dots$. The generating function for $\text{SSYT}(\lambda/\mu)$ by size (volume) is obtained by evaluating $s_{\lambda/\mu}$ at $x_i = q^{i-1}$.

2.3. Lascoux–Pragacz and Kreiman decomposition of λ/μ . A *border-strip* is a connected skew shape with no 2×2 box. The starting point and ending point of a strip are its southwest and northeast endpoints. Given λ , the *outer border strip* is the strip containing all the boxes inside $[\lambda]$ sharing a vertex with the boundary of λ , i.e. $\lambda/(\lambda_2 - 1, \lambda_3 - 1, \dots)$.

We introduce two different decompositions of a Young diagram of shape λ/μ , the *Lascoux–Pragacz decomposition* and the *Kreiman decomposition*. See Figure 2 for an example. We follow the definitions and notations in [9].

For a skew shape λ/μ , let $\text{cont}(\lambda/\mu) = \{c(u) \mid u \in \lambda/\mu\}$ be the set of contents of the cells of $[\lambda/\mu]$. A *cutting strip* of λ/μ is a border-strip ρ such that $\text{cont}(\rho) = \text{cont}(\lambda/\mu)$. We can decompose λ/μ into border strips (ρ_1, \dots, ρ_k) by sliding the cutting strip ρ along the diagonal and taking an intersection with $[\lambda/\mu]$. Denote by q_i the content of the top right-most element in each border strip ρ_i . Note that different border strips have different values of q_i . We index ρ_i such that $q_1 > q_2 > \dots > q_k$. See Figure 1. The *diagonal distance* of each ρ_i is the number of diagonal slides from the cutting strip ρ .

Definition 2.1 ([14]). A *Lascoux–Pragacz decomposition* of λ/μ is a tuple of non-intersecting lattice paths $(\theta_1, \dots, \theta_k)$, where the cutting strip $\rho = \theta_1$ is the outer borderstrip of λ/μ (wrapping around λ).

Definition 2.2 (height of θ_i). Given a skew shape λ/μ , let $(\theta_1, \dots, \theta_k)$ be its Lascoux–Pragacz decomposition. Denote by $f(\theta_r)$ the row number of the final element of θ_r (top right-most element). We define the θ_r -height of row i , denoted as $ht_{\theta_r}(i)$ to be $i - f(\theta_r)$.

Example 2.3. For the skew shape $7665442/331$ in Figure 2, the height of the element $(7, 2)$ in θ_1 is 6 whereas the height of $(4, 1)$ in θ_4 is 1.

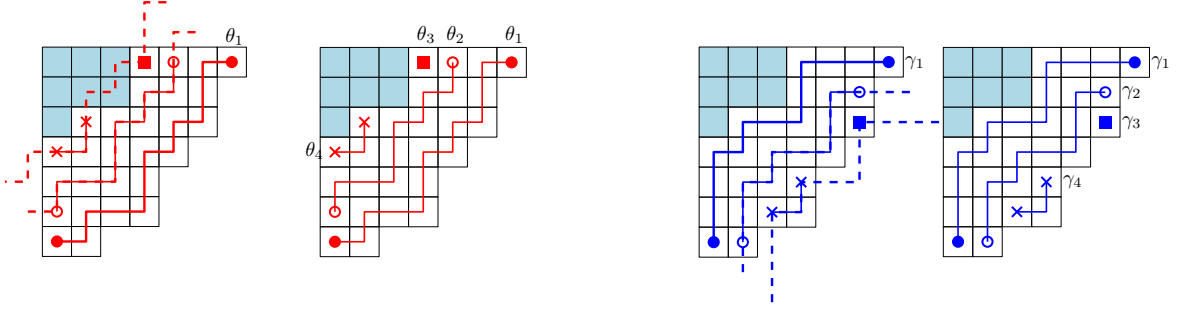

FIGURE 2. On the left we have the diagonal slidings using the outer (θ_1) border strip of λ/μ as the cutting strip and the Lascoux–Pragacz (red) decomposition of λ/μ and on the right we have the inner (γ_1) border-strip of λ/μ as the cutting edge and the Kreiman decomposition (blue) of λ/μ .

Definition 2.4 ([13]). A Kreiman decomposition of λ/μ is a tuple of non-intersecting lattice paths $(\gamma_1, \dots, \gamma_k)$, where the cutting strip $\rho = \gamma_1$ is the inner border strip of λ/μ (wrapping around μ).

Next, we give some results about the relationship between these two decompositions of λ/μ . To see how this works, let (r_1, \dots, r_m) be the lengths of the diagonals within λ/μ , enumerated from the upper right corner to the lower left. For example, in Figure 2 we have $(1, 1, 2, 3, 2, 2, 2, 3, 3, 3, 2, 2, 1)$. Now observe that cutting with an outer or inner border strip is removing a square from the lower or top of each diagonal, respectively, the remaining skew shape has diagonal lengths $(\max\{r_1 - 1, 0\}, \max\{r_2 - 1, 0\}, \dots, \max\{r_m - 1, 0\})$. When there is an $r_i = 0$ it signals the beginning of a new strip, these are numbered from top to bottom, or in the sequence r setting from left to right.

Proposition 2.5. Given a skew shape λ/μ and $(\theta_1, \dots, \theta_k)$ and $(\gamma_1, \dots, \gamma_k)$ be its Lascoux–Pragacz and Kreiman decompositions, respectively. Then for all $i = 1, \dots, k$, the strips γ_i and θ_i have the same diagonal distance with respect to γ_1 and θ_1 , respectively.

Proof. We use the interpretation via diagonal lengths above to explain this phenomenon, as it makes it apparent. We proceed by induction on the distance ϵ from the original cutting strips. Let (r_1, \dots, r_m) be the diagonal lengths of λ/μ as above. When $\epsilon = 0$ we have γ_1 and θ_1 respectively. The new diagonal lengths are $r(1) := (\max\{r_1 - 1, 0\}, \max\{r_2 - 1, 0\}, \dots, \max\{r_m - 1, 0\})$. The strips at diagonal distance $\epsilon = 1$ consist of the intervals between zeros in $r(1)$ and are numbered accordingly. In general, the strips at distance ϵ result from the intervals between zeros in $r(\epsilon) := (\max\{r_1 - \epsilon, 0\}, \max\{r_2 - \epsilon, 0\}, \dots, \max\{r_m - \epsilon, 0\})$ and are numbered consecutively from left to right. this procedure is independent of whether it follows the inner or outer border strip. Thus, the strips in γ and θ at the same distance ϵ will have the same indices.

For example, in Figure 2 we have $r(0) = (1, 1, 2, 3, 2, 2, 2, 3, 3, 3, 2, 2, 1)$ giving both θ_1 and γ_1 , shifting one up/down we have $r(1) = (0, 0, 1, 2, 1, 1, 1, 2, 2, 2, 1, 1, 0)$ which results in one new strips (between the zeros) – γ_2 and θ_2 at distance 1 from the originals. At distance 2 we have $r(2) = (0, 0, 0, 1, 0, 0, 0, 1, 1, 1, 0, 0, 0)$ resulting in two strips – θ_3, θ_4 and γ_3, γ_4 corresponding to the intervals between zero (1) and (1, 1, 1).

□

We denote by ϵ_i the diagonal distance for both the border strips γ_i and θ_i in the Kreiman and Lascoux–Pragacz decomposition of λ/μ .

Let $\mathcal{NI}(\lambda/\mu)$ be the set of k -tuples of non-intersecting lattice paths contained in $[\lambda]$ where the i th path has endpoints (a_i, b_i) and (c_i, d_i) .

We have the following correspondence between the Kreiman decomposition and the Lascoux–Pragacz decomposition of shape λ/μ .

Proposition 2.6 ([16, Lemma 3.8]). *Given a shape λ/μ , let $(\theta_1, \dots, \theta_k)$ and $(\gamma_1, \dots, \gamma_k)$ be its Lascoux–Pragacz and Kreiman decompositions, respectively. For each $i \in 1, \dots, k$, the endpoints of γ_i and θ_i have the same contents and therefore the two strips have the same length.*

This correspondence between the border strips of the Lascoux–Pragacz and the Kreiman decomposition described in Proposition 2.5 and 2.6 gives the following property.

Corollary 2.7. *For each $i = 1, \dots, k$, γ_i and θ_i have the same length, number of columns, number of rows.*

Proof. The fact that γ_i and θ_i have the same length follows immediately from Proposition 2.6 since the endpoints of γ_i and θ_i are on the same diagonal.

We show the other two equalities in the statement inductively. The statement is true for γ_1 and θ_1 because they have the same endpoints and the number of horizontal and vertical steps are determined by the endpoints. We follow the construction of θ_i and γ_i from the proof of Proposition 2.6 in [15, Lemma 3.8]. From the proof we know that for each $i = 2, \dots, k$, the shape $\lambda/\mu \setminus (\cup_{j=1}^{i-1} \gamma_j)$ is equal to the shape $\lambda/\mu \setminus (\cup_{j=1}^{i-1} \theta_j)$. Denote the shape $\eta^{(i)}/\mu$. Then the border-strips θ_i and γ_i starts and ends at the same points of $\eta^{(i)}/\mu$ and the number of columns and rows of the two border-strips are equivalent. \square

We will also need the following other technical relation between the two decompositions.

Lemma 2.8. *Given a skew shape λ/μ and let $(\gamma_1, \dots, \gamma_k)$ and $(\theta_1, \dots, \theta_k)$ be its Kreiman and Lascoux–Pragacz decomposition. For each $i \in \{1, \dots, k\}$, let $\gamma_i : (f_i, g_i) \rightarrow (c_i, d_i)$ and $\theta_i : (s_i, t_i) \rightarrow (u_i, v_i)$. Then $g_i - t_i = \epsilon_i$, i.e. the column difference of the starting point of γ_i and θ_i is ϵ_i .*

Proof. By construction the endpoints of θ_i are on the outer strip γ_1 and the endpoints of γ_i are on the outer strip θ_1 . Since by Proposition 2.6 the endpoints of θ_i and γ_i are on the same diagonals, then the distance between $g_i - t_i$ between them is the same and equal to ϵ_i . \square

2.4. Combinatorial objects of the Naruse hook length formula. We go over some of the combinatorial objects that index the terms of (NHLF) (see Figure 4a). We fix a shape λ/μ .

Excited diagrams. Excited diagrams were defined by Naruse and Ikeda [7] in the context of equivariant Schubert calculus and also independently by Kreiman [13] and Knutson–Miller–Yong [10]. To introduce we need to define the notion of the following local move.

Definition 2.9 (excited move β). *Given a subset D of $[\lambda]$, a cell (i, j) of D is active if the cells $(i + 1, j)$, $(i, j + 1)$, $(i + 1, j + 1)$ are not in D but are in $[\lambda]$. Given an active cell (i, j) of D , let $\beta_{(i,j)} : D \rightarrow D'$ be the map that replaces cell (i, j) in D by $(i + 1, j + 1)$. We call such $\beta_{(i,j)}$ an excited move (see Figure 3a).*

Then, we define excited diagrams of λ/μ iteratively.

Definition 2.10. *An excited diagram of λ/μ to be any set of $|\mu|$ cells obtained by starting with the cells of $[\mu] \subseteq [\lambda]$ and applying any number of excited moves. We let $\mathcal{E}(\lambda/\mu)$ be the set of excited diagrams of λ/μ .*

Given an active cell (i, j) in D , we denote by $\mu(i, j)$ the column of the original cell in μ where (i, j) came from.

There is the following determinantal formula for the number of excited diagrams. Given a skew shape λ/μ , consider the diagonal that passes through the box (i, μ_i) and let ϑ_i be the row where the diagonal intersects the boundary of $[\lambda]$.

Theorem 2.11 ([16, §3]). *In the notation above, we have*

$$\text{ED}(\lambda/\mu) = \det \left[\begin{pmatrix} \vartheta_i + \mu_i - i + j - 1 \\ \vartheta_i - 1 \end{pmatrix} \right]_{i,j=1}^{\ell(\mu)}.$$

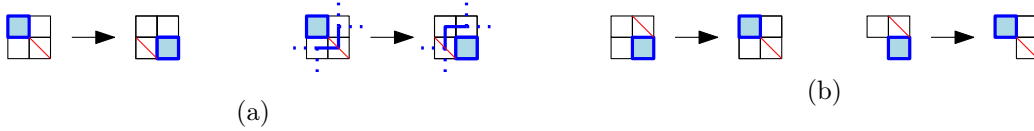

FIGURE 3. Illustration of (a) an excited move on excited diagrams and the corresponding ladder move on non-intersecting lattice paths, and (b) a reverse excited move. The broken diagonals are denoted in red.

Next, we go over three objects in correspondence with excited diagrams. See Figure 6.

Flagged tableaux of shape μ . Excited diagrams are in correspondence with certain SSYT of shape μ . Let $\mathcal{F}(\lambda/\mu)$ be the set of SSYT of shape μ with entries in row i at most ϑ_i . Such SSYT are called *flagged tableaux*. Given an excited diagram D in $\mathcal{E}(\lambda/\mu)$, let $\varphi(D) := T$ be the SSYT of shape μ where $T(x, y) = j_y$ where (i_x, j_y) is the cell of D corresponding to (x, y) in $[\mu]$.

Proposition 2.12 ([16, §3]). *For a skew shape λ/μ , the map φ is a bijection between $\mathcal{E}(\lambda/\mu)$ and $\mathcal{F}(\lambda/\mu)$.*

Non-intersecting lattice paths. Kreiman showed in [13, §5, §6] that the support of such paths are the complements of excited diagrams. See Figure 6 for an example. Then excited moves on diagrams correspond to *ladder moves* on the non-intersecting lattice paths (see Figure 6).

Proposition 2.13 ([13]). *The k -tuples of paths in $\mathcal{NIP}(\lambda/\mu)$ are uniquely determined by their supports in $[\lambda]$ and moreover these supports are exactly the complements of excited diagrams of λ/μ .*

If an excited diagram D corresponds to the tuple $(\gamma'_1, \dots, \gamma'_k)$, we denote by $\gamma_i(D) = \gamma'_i$, the path obtained from γ_i after applying the corresponding ladder moves to the excited moves where $[\mu]$ is obtained from D .

Broken diagonals of excited diagrams. To each excited diagram $D \in \mathcal{E}(\lambda/\mu)$ we associate certain cells of $[\lambda/\mu] \setminus D$. See Figure 6 for an example.

Definition 2.14 ([16, Def. 7.3]). *Given an excited diagram D in $\mathcal{E}(\lambda/\mu)$, we define the broken diagonals of D to be the following set of $[\lambda/\mu] \setminus D$:*

- for the initial diagram $[\lambda/\mu]$, let $\text{Br}(D) = \bigcup_{i=1}^{\ell(\lambda)-1} \mathbf{d}_i(\mu)$, where \mathbf{d}_k is the diagonal of cells in $[\lambda/\mu]$ with content $\mu_i - i$.
- if $D' = \beta_{(i,j)}(D)$, then $(i+1, j+1)$ is in some $\mathbf{d}_t(D)$. Define $\text{Br}(D') = \bigcup_{k=1}^{\ell(\lambda)-1} \mathbf{d}_k(D')$ where $\mathbf{d}_k(D') = \mathbf{d}_k(D)$ if $k \neq t$ and $\mathbf{d}_t(D') = \{(i+1, j)\} \cup \mathbf{d}_t(D) \setminus \{(i+1, j+1)\}$.

Let $\text{Br}(\lambda/\mu) = \{\text{Br}(D) \mid D \in \mathcal{E}(\lambda/\mu)\}$ be the set of broken diagonals of the excited diagrams of λ/μ .

For a lattice path $\gamma \subseteq [\lambda]$ let $u(\gamma)$ be the cells corresponding to up-steps of γ , including right-up corners (i.e. outside corners) but excluding up-right corners (i.e. inner corners). The following result gives a non-recursive characterization of broken diagonals.

Proposition 2.15. *Let D be an excited diagram D in $\mathcal{E}(\lambda/\mu)$ corresponding to the tuple $(\gamma'_1, \dots, \gamma'_k)$ in $\mathcal{NIP}(\lambda/\mu)$ then the broken diagonals are placed on both the vertical steps or a right-up corners (i.e. outside corners) of the paths γ'_i :*

$$\text{Br}(D) = \{u(\gamma_i) \mid i = 1, \dots, k\}.$$

Proof. The size of the up-steps $\{u(\gamma_i) \mid i = 1, \dots, k\}$ remains constant for all the tuples of paths in $\mathcal{NIP}(\lambda/\mu)$. The result holds for the initial excited diagram $D = [\mu]$ and an excited move changes an up-step to an up-step in an adjacent column. \square

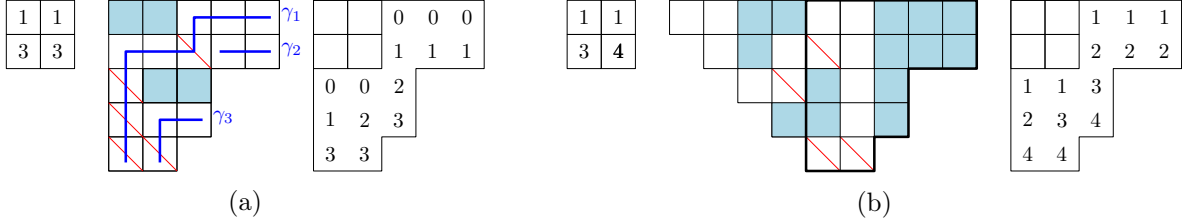

FIGURE 4. Example of corresponding objects of a (a) term of (NHLF): flagged tableau, excited diagram (with broken diagonals and non-intersecting paths), and minimal SSYT shape λ/μ ; and of a (b) term of the (OOF): Okounkov–Olshanski tableau, reverse excited diagram, and flagged tableau shape λ/μ .

2.5. Combinatorial objects of the Okounkov–Olshanski formula. We go over some of the combinatorial objects that index the terms of (OOF) (see Figure 4b). We fix a shape λ/μ .

Okounkov–Olshanski tableaux. For a skew shape λ/μ of length d , an *Okounkov–Olshanski tableau* is a SSYT T of shape μ with entries in $[d]$ where $d := \ell(\lambda)$ and with $c(u) < \lambda_{d+1-T(u)}$ for all $u \in [\mu]$. Let $\mathcal{OOT}(\lambda/\mu)$ be the set of such tableaux and let $|\mathcal{OOT}(\lambda/\mu)|$ be the size of $\mathcal{OOT}(\lambda/\mu)$.

Skew flagged tableaux. Let $\mathcal{SF}(\lambda/\mu)$ be the set of SSYT of shape λ/μ such that the entries in row i are at most i . The authors in [19] gave an explicit bijection between tableaux in $\mathcal{OOT}(\lambda/\mu)$ and skew tableaux in $\mathcal{SF}(\lambda/\mu)$.

Given $T \in \mathcal{SF}(\lambda/\mu)$, $M(T)$ is the set of cells (j, t) with $1 \leq j \leq \ell(\lambda')$ and $1 \leq t \leq \lambda'_j$ such that there is no i with $T(i, j) = t$. Given $(j, t) \in M$, let $i(j, t)$ be the unique integer i with $\mu'_i \leq i \leq \lambda'_j$ so that $T(i', j) < t$ for $i' \leq i$ and $T(i', j) > t$ for $i' > i$. i.e. view $M(T)$ as the set of labels on the horizontal edges of T between the cells $(i(j, t), j)$ and $((i(j, t) + 1, j)$ so that column j of T has all the numbers from 1 to λ'_j from top to bottom.

Reverse excited diagrams. The following variation of excited diagrams was introduced in [19].

Definition 2.16 (reverse excited move β). *Given a subset D of $[\lambda^*]$, a cell (i, j) with $i \neq j$ of D is reverse active if the cells $(i - 1, j), (i, j - 1), (i - 1, j - 1)$ are not in D but are in $[\lambda^*]$. Similarly, a cell (i, i) of D is reverse active if the cells $(i, j - 1), (i - 1, j - 1)$ are not in D but are in $[\lambda^*]$. Given a reverse active cell (i, j) of D , let $\beta_{(i,j)}^* : D \rightarrow D'$ be the map that replaces cell (i, j) in D by $(i - 1, j - 1)$. We call such $\beta_{(i,j)}^*$ a reverse excited move (see Figure 3b).*

Then, we define reverse excited diagrams of λ/μ iteratively.

Definition 2.17. *A reverse excited diagram of λ/μ to be any set of $|\lambda/\mu|$ cells obtained by starting with the cells of $[\lambda^*/\mu^*] \subseteq [\lambda^*]$ and applying any number of reverse excited moves. We let $\mathcal{RE}(\lambda/\mu)$ be the set of reverse excited diagrams of λ/μ .*

The flagged tableaux in $\mathcal{SF}(\lambda/\mu)$ are in direct correspondence with reverse excited diagrams in $\mathcal{RE}(\lambda/\mu)$. Given a reverse excited diagram D in $\mathcal{RE}(\lambda/\mu)$, let $\varphi^*(D) := T$ be the SSYT of shape λ/μ where $T(x, y) = j_y$ where (i_x, y_x) is the cell of D corresponding to (x, y) in $[\lambda^*/\mu^*]$.

Proposition 2.18 ([19, Lem. 4.22]). *For a skew shape λ/μ , the map φ^* is a bijection between $\mathcal{RE}(\lambda/\mu)$ and $\mathcal{SF}(\lambda/\mu)$.*

The direct correspondence between tableaux in $\mathcal{OOT}(\lambda/\mu)$ and in $\mathcal{SF}(\lambda/\mu)$ is as follows. Given T in $\mathcal{OOT}(\lambda/\mu)$, let $\vartheta^*(T) := U$ be the SSYT of shape λ/μ whose entries in the i th column are the entries k in $\{1, \dots, \lambda'_i\}$ such that $d + 1 - k$ is not an entry in the i th column of T .

Proposition 2.19 ([19, Cor. 4.16]). *For a skew shape λ/μ , the map ϑ^* is a bijection between $\mathcal{OOT}(\lambda/\mu)$ and $\mathcal{SF}(\lambda/\mu)$.*

There is also the following determinantal formula for the number of Okounkov–Olshanski tableaux.

Theorem 2.20 ([19, Thm. 1.2]). *In the notation above, we have*

$$\mathcal{OOT}(\lambda/\mu) = \det \left[\begin{pmatrix} \lambda_i - \mu_j + j - 1 \\ i - 1 \end{pmatrix} \right]_{i,j=1}^{\ell(\lambda)}.$$

Broken diagonals of reverse excited diagrams. To each reverse excited diagram $D \in \mathcal{RE}(\lambda/\mu)$ we associate certain cells of $[\mu^*] \setminus D$. See Figure 11b for an example.

Definition 2.21 ([19, Def. 4.24]). *Given a reverse excited diagram D in $\mathcal{RE}(\lambda/\mu)$, we define the broken diagonals of D to be the following set of $[\lambda^*] \setminus D$:*

- *for the initial diagram $[\lambda^*/\mu^*]$, let $\text{Br}^*(D) = \bigcup_{i=1}^{\ell(\mu')} \mathbf{d}_i^*(\mu)$, where \mathbf{d}_k^* is the diagonal of cells in $[\mu^*]$ with content $i - \mu'_i + \ell(\lambda) - 1$.*
- *if $D' = \beta_{(i,j)}^*(D)$, then $(i-1, j)$ is in some $\mathbf{d}_t^*(D)$. Define $\text{Br}^*(D') = \bigcup_{k=1}^{\ell(\mu')} \mathbf{d}_k^*(D')$ where $\mathbf{d}_k^*(D') = \mathbf{d}_k^*(D)$ if $k \neq t$ and $\mathbf{d}_k^*(D') = \{(i, j)\} \cup \mathbf{d}_k^*(D) \setminus \{(i-1, j)\}$.*

The reformulation of (OOF) in terms of reverse excited diagrams is simple to state [19, Cor. 5.6].

Corollary 2.22 (Reverse excited diagram formulation of (OOF)). *For a skew shape λ/μ of size n and length $d = \ell(\lambda)$ we have that*

$$(2.2) \quad f^{\lambda/\mu} = \frac{n!}{\prod_{u \in [\lambda]} h(u)} \sum_{D \in \mathcal{RE}(\lambda/\mu)} \prod_{(i,j) \in \text{Br}^*(D)} (\lambda_i + d - j).$$

2.6. The Hillman–Grassl correspondence.

Definition and properties. Fix a skew shape λ/μ . We denote by HG the Hillman–Grassl bijection between reverse plane partitions in $\text{RPP}(\lambda)$ ranked by size and integer arrays of shape λ ranked by hook weight. That is, if $HG : \pi \mapsto A$ then

$$(2.3) \quad |\pi| = \sum_{u \in \lambda} h(u) \cdot A_u.$$

We follow the conventions and definition of HG in [28, §7.22], that we include for completeness.

Definition 2.23 (Hillman–Grassl map). *Given $\pi \in \text{RPP}(\lambda)$, the map is obtained via a sequence of pairs $(\pi_0, A_0) := (\pi, \mathbf{0}), (\pi_1, A_1) \dots, (\pi_k, A_k) := (\mathbf{0}, HG(\pi))$ where each π_i is a reverse plane partition and A_i is an array of nonnegative integers of shape λ .*

The HG step $(\pi_i, A_i) \rightarrow (\pi_{i+1}, A_{i+1})$ is defined as follows. The plane partition π_{i+1} is obtained from π_i by decreasing by one the following entries along a lattice path on $[\lambda]$ defined as

- (i) *start at the most South-West nonzero cell of π_i ,*
- (ii) *iterate the following step when the path visits cell (a, b) , if $(\pi_i)_{a,b} = (\pi_i)_{a-1,b}$ then the path moves North, otherwise the path moves East,*
- (iii) *terminate when this is no longer possible.*

Let $u_i = (r, c)$ where c is the column where the path starts and r is the row where it ends. Note that $|\pi_i| - |\pi_{i-1}| = h(u_i)$. We obtain the array A_{i+1} from A_i by adding one to cell u_i . We continue until π_k has only zero entries. We let $A_k = HG(\pi)$.

Note that by the construction of HG , (2.3) holds. Hillman–Grassl showed that this map is a bijection. Because of this and (2.1), we obtain (1.3) as a corollary.

Theorem 2.24 (Hillman–Grassl [6]). *The map HG is a bijection between $\text{RPP}(\lambda)$ and integer arrays of shape λ satisfying (2.3).*

The Hillman–Grassl correspondence has the following property that allows to encode different traces of the plane partition. For an integer k with $1 - \ell(\lambda) \leq k \leq \lambda_1 - 1$, a k -diagonal of π is the sequence of entries (π_{ij}) with content $i - j = k$. The k -trace of π is the sum $\text{tr}_k(\pi) = \sum_{i-j=k} \pi_{ij}$.

For an integer k with $1 - \ell(\lambda) \leq k \leq \lambda_1 - 1$, let \square_k^λ be the largest $i \times (i + k)$ rectangle that fits inside $[\lambda]$ starting at $(1, 1)$. For $k = 0$, we have that \square_0^λ is the *Durfee square* of λ . If A is an array of shape λ , let A_k be the subarray of A with support in \square_k^λ , and $|A_k|$ denotes the sum of the entries of this subarray.

Proposition 2.25 ([3, Thm. 3.2]). *Let π be a reverse plane partition of shape λ , and $A = HG(\pi)$. Then for k with $1 - \ell(\lambda) \leq k \leq \lambda_1 - 1$, we have that $\text{tr}_k(\pi) = |A_k|$.*

Denote by $ac_t(A_k) = \max\{\sum_{(i,j) \in p_1 \cup \dots \cup p_t} A_{i,j}\}$, where p_1, \dots, p_t are collections of northeast (NE) non-intersecting paths in A_k . Similarly, let $dc_t(A_k)$ denote the maximal number of nonzero entries along a collection of strict southeast (SE) non-intersecting paths in A_k . The statistic $ac_t(A)$ ($dc_t(A)$) can be viewed as counting the maximum combined length of t *ascending (descending) chains* in A . We need the following known connection between the Hillman–Grassl bijection and the RSK bijection that can be viewed as an analogue of *Greene’s theorem* (see [28, Thm. A1.1.1]).

Theorem 2.26 ((i) by Hillman–Grassl [6], (ii) by Gansner [3]). *Let π be in $\text{RPP}(\lambda)$, $A = HG(\pi)$, and let k be an integer $1 - \ell(\lambda) \leq k \leq \lambda_1 - 1$. Denote by $\nu = \nu^{(k)}$ the partition whose parts are the entries on the k -diagonal of π . Then for all $t \geq 1$ we have:*

- (i) $ac_t(A_k) = \nu_1 + \nu_2 + \dots + \nu_t$,
- (ii) $dc_t(A_k) = \nu'_1 + \nu'_2 + \dots + \nu'_t$.

Corollary 2.27 ([16, Cor. 5.8]). *Let π be in $\text{RPP}(\lambda)$, $A = HG(\pi)$, and let k be an integer $1 - \ell(\lambda) \leq k \leq \lambda_1 - 1$. Denote by $\nu^{(k)}$ the partition obtained from the k -diagonal of π . Then the shape of the tableaux of $\text{RSK}(A_k^\uparrow)$ and of $\text{RSK}(A_k^{\uparrow*})$ is $\nu^{(k)}$.*

Extending HG to skew SSYT. We extend HG to $\text{SSYT}(\lambda/\mu)$ by viewing each skew SSYT as a plane partition of shape λ with zero entries in $[\mu]$.

For any excited diagram $D \in \mathcal{E}(\lambda/\mu)$, denote by A_D the 0-1 array of shape λ with support on the broken diagonals $\text{Br}(D)$ of D and let $\mathcal{A}^*(\lambda/\mu) = \{A_D \mid D \in \mathcal{E}(\lambda/\mu)\}$. Let \mathcal{A}_D^* be the set of arrays A of nonnegative integers of shape λ with support contained in $[\lambda] \setminus D$ and nonzero entries $A_{i,j} > 0$ if $(A_D)_{i,j} = 1$.

Theorem 2.28 ([16, Thm. 7.7]). *The (restricted) Hillman–Grassl map HG is a bijection*

$$HG : \text{SSYT}(\lambda/\mu) \rightarrow \bigcup_{D \in \mathcal{E}(\lambda/\mu)} \mathcal{A}_D^*.$$

This property combined with (2.1) yields (1.4) as a corollary (see [16, Sec. 7.1]).

3. MINIMAL SEMISTANDARD TABLEAUX OF SHAPE λ/μ

In Section 3.1 we introduce a set of tableaux called *minimal SSYT* of shape λ/μ . In Section 3.2 we show it is in correspondence with excited diagrams.

3.1. Characterization of minimal SSYT by local moves. We now give the definition of minimal SSYT of shape λ/μ and show they are in correspondence to the set of excited diagrams of shape λ/μ . We do this by studying the Lascoux–Pragacz decomposition of the SSYT and the Kreiman decomposition of its corresponding excited diagram.

Let λ/μ be a skew partition and $(\theta_1, \dots, \theta_k)$ be its Lascoux–Pragacz decomposition. Given a strip θ_k and column j , let $\theta_k(j)$ the j th column segment of θ_k . Let (i, j) be the top-most cell and (i', j) be the bottom-most cell of $\theta_k(j)$ (which may agree if the column has size one).

Recall that $T_0 \in \text{SSYT}(\lambda/\mu)$ is the *minimum SSYT of shape λ/μ* , the tableau whose i -th column is $\{0, 1, \dots, \lambda'_i - \mu'_i - 1\}$. A *minimal SSYT* is obtained from T_0 by applying a sequence of *excited moves* δ , defined below. This move increases by 1 the entries in a column segment of a strip θ_k in a tableau when the result is still semistandard and the top value of the segment is at most its distance from the top part of θ_k .

Definition 3.1 (excited move δ). *The top most cell (i, j) of a column segment $\theta_k(j)$ of a SSYT T of shape λ/μ is called active if*

- (i) $T(i, j) < ht_{\theta_k}(i)$,
- (ii) $T(i, j) < T(i, j + 1)$ and $T(i', j) < T(i' + 1, j) - 1$, where (i', j) is the cell at the bottom of $\theta_k(j)$

Given an active column $\theta_k(j)$ of T , the excited move δ adds one to each entry in the column segment $\theta_k(j)$. We denote by $T' := \delta_{(k;j)}(T)$ be the tableau obtained from T by the move δ . Condition (ii) guarantees that T' is still a SSYT. See Figure 5a for an example.

Definition 3.2 (minimal skew SSYT). *A minimal SSYT of shape λ/μ is any tableau obtained by starting with T_0 and applying any number of excited moves δ . We let $\text{SSYT}_{\min}(\lambda/\mu)$ be the set of minimal SSYT of shape λ/μ . See Figure 7 for an example.*

3.2. Bijection between excited diagrams and minimal SSYT. In this section, we show the correspondence between $\mathcal{E}(\lambda/\mu)$ and $\text{SSYT}_{\min}(\lambda/\mu)$ that commutes with their respective excited moves β and δ . First, we define the map Φ between $\mathcal{E}(\lambda/\mu)$ and $\text{SSYT}(\lambda/\mu)$ and show it is a bijection. We then show the correspondence between the excited moves in $\mathcal{E}(\lambda/\mu)$ and the excited moves in $\text{SSYT}_{\min}(\lambda/\mu)$.

The map Φ is defined below. Intuitively, it builds a tableau of shape λ/μ from an excited diagram by filling the entries in the strip θ_i by counting the number of broken diagonals column by column of $\gamma_i(D)$.

Definition 3.3. *Given $D \in \mathcal{E}(\lambda/\mu)$ with Kreiman decomposition $(\gamma_1(D), \dots, \gamma_k(D))$ and broken diagonals $\text{Br}(D)$, let $T := \Phi(D)$ be the following tableau of shape λ/μ :*

For each $\gamma_i(D)$ and θ_i , start with the left-most column of each path. For each j th column of $\gamma_i(D)$ and θ_i , we do the following procedure:

- (1) Let b_j be the number of broken diagonals on the j th column of $\gamma_i(D)$.
- (2) Denote the bottom-most element of the j th column of θ_i as (s_j, t_j) . Let

$$T(s_j, t_j) = \begin{cases} b_j & \text{if } j = 1, \\ T(s_j, t_j - 1) + b_j & \text{if } j > 1. \end{cases}$$

- (3) Fill the rest of the j th column of θ_i so that consecutive entries differ by 1.

Example 3.4. *Let $D \in \mathcal{E}(\lambda/\mu)$ be the excited diagram shown in Figure 5 (b). We apply the correspondence to obtain $T = \Phi(D)$. The first column of $\gamma_1(D)$ has 3 broken diagonals, so $T(5, 1) = 3$. the second column of $\gamma_1(D)$ has no broken diagonals, so $T(5, 2) = 3$, then the rest of the column of θ_1 is filled with consecutive entries differing by 1 to maintain column strictness. We continue the algorithm to obtain the final tableau T of skew shape λ/μ .*

Remark 3.5. *See Section 6 for a description of Φ in terms of the Hillman–Grassl correspondence.*

The main result of this section is the fact that Φ is a bijection between $\mathcal{E}(\lambda/\mu)$ and $\text{SSYT}_{\min}(\lambda/\mu)$.

Theorem 3.6. *For a skew shape λ/μ the map $\Phi : \mathcal{E}(\lambda/\mu) \rightarrow \text{SSYT}_{\min}(\lambda/\mu)$ is a bijection that commutes with the respective local moves, that is $\Phi \circ \beta = \delta \circ \Phi$.*

The proof requires the following lemmas and notation. For the Lascoux–Pragacz decomposition of λ/μ and the Kreiman paths $(\gamma_1, \dots, \gamma_k)$ of an excited diagram D , we denote by $\text{col}(\theta_i, n)$ and

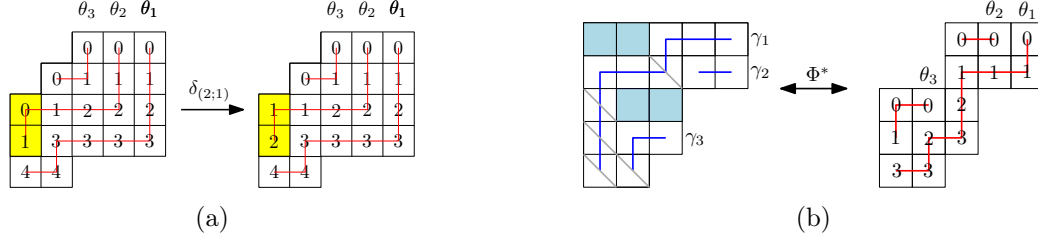
 FIGURE 5. (a) Excited move δ on SSYT_{\min} (b) Excited diagram to SSYT_{\min}

$\text{col}(\gamma_i, n)$ the column on λ/μ where the n th column of θ_i and γ_i is, respectively. Note that λ/μ will be assumed.

Lemma 3.7. *We have that $\Phi([\mu]) = T_0$.*

Proof. Let $T = \Phi(\mu)$. It suffices to show that $T(i, j) = i - \mu'_j - 1$. We show this by iterating on the number k of paths in the Kreiman and Lascoux–Pragacz decomposition. Consider the first paths γ_1 and θ_1 of the shape λ/μ . By Proposition 2.15, the broken diagonals in the excited diagram $[\mu]$ are on the vertical steps and right up corners of γ_i . Note that the Kreiman path γ_1 of the shape λ/μ traces around $[\mu]$.

The bottom-most value in the j th column of $T(\theta_1)$ is $\lambda'_j - \mu'_j - 1$. Indeed, by the description of Φ in Definition 3.3, the number b_j of broken diagonals on the j th column of γ_1 is $b_1 = \lambda'_1 - \mu'_1 - 1$ and $b_j = \mu'_{j-1} - \mu'_j$, for $j > 1$. The values on the bottom-most elements determine the rest of $T(\theta_1)$, since the values of the j th column of θ_1 differ by 1. Note that for (i, j) in θ_1 , we have that $T(i, j) = i - \mu'_j - 1$.

Next, consider the shape $\nu := (\lambda/\mu) \setminus \theta_1$. Note that ν is equivalent to $(\lambda/\mu) \setminus \gamma_1$ and sliding up the rest of the Kreiman paths diagonally (see [15, Lemma 3.8]). Then similarly, the bottom-most value in the i th column of $T(\theta_2)$ is $\nu'_i - \mu'_i - 1$, which determine the rest of $T(\theta_2)$. Continuing this pattern, we obtain that $T(i, j) = i - \mu'_j - 1$ as desired. \square

Lemma 3.8. *The map Φ is a well-defined injective map from $\mathcal{E}(\lambda/\mu)$ to $\text{SSYT}(\lambda/\mu)$.*

Proof. First, we show that for any $D \in \mathcal{E}(\lambda/\mu)$, the tableau $\Phi(D)$ of shape λ/μ is semistandard. We use induction on the number of excited moves.

The base case follows by Lemma 3.7 and the fact that T_0 is semistandard. Next, assume that $T := \Phi(D)$ is semistandard, and $D' = \beta_u(D)$ for some active cell $u = (x, y)$. We show that $T' := \Phi(D')$ is semistandard.

Let $(\gamma_1, \dots, \gamma_k)$ be the Kreiman decomposition of D , and γ_i be the path involved in the corresponding ladder move to β_u . By Definition 3.3, T' is semistandard within the path θ_i and some of its entries were increased. If $i = 1$, then we are done since θ_1 is the outer rim of λ , its entries increased and satisfy the SSYT inequalities with respect to its neighbors. If $i > 1$, we show that T' is semistandard between adjacent paths θ_i and θ_j for $i > j$, for $i < j$ this follows analogously as for $i = 1$. By construction of the Kreiman paths and Lascoux–Pragacz paths, since $i > j$ then γ_i is to the right and below of γ_j and θ_i is to the left and above of θ_j . Since θ_j is adjacent to θ_i , then $\epsilon_i - \epsilon_j = 1$, and by Proposition 2.5, γ_j is also adjacent to γ_i .

Suppose β_u acted on the n th column of γ_i , that is, $\beta_u(D)$ increased by 1 the size of broken diagonals on the n th column of γ_i . By the construction of Φ , this corresponds to the n th column segment of θ_i increasing by 1. Let (a, b) be the bottom most cell in the n th column segment of θ_i and $(a+1, b)$ be the cell below in the m th column of θ_j . We need to show that $T'(a+1, b) > T'(a, b)$.

In order to do this, we need to track the cell $(a+1, b)$ in the excited diagram. We know that if (a, b) is in the n th column of θ_i , then $(a+1, b)$ is in the m th column of θ_j where $m \geq n$ since θ_i is

to the left and above of θ_j . By the construction of Φ , the m th column of θ_j corresponds to the m th column of γ_j .

We show that the m th column of γ_j is directly to the left of the n th column of γ_i . Let g_i and t_i be the starting column of γ_i and θ_i respectively. Then $\text{col}(\gamma_i, n) = g_i + n - 1$ and $\text{col}(\theta_i, n) = t_i + n - 1$. By Lemma 2.8 we have that $g_i - t_i = \epsilon_i$, and so $\text{col}(\theta_i, n) = \text{col}(\gamma_i, n) - \epsilon_i$. Similarly $\text{col}(\theta_j, m) = \text{col}(\gamma_j, m) - \epsilon_j$. Note that the m th column of θ_j is on the same column of λ/μ as the n th column of θ_i , i.e. $\text{col}(\theta_i, n) = \text{col}(\theta_j, m)$. Then $\text{col}(\gamma_i, n) - \text{col}(\gamma_j, m) = \epsilon_i - \epsilon_j = 1$. This shows that the m th column of γ_j is directly to the left of n th column of γ_i with respect to λ/μ .

We now need to analyze the previous excited moves on the m th column of γ_j . Let u be the active cell of the excited move $\beta_u(D)$. Given a sequence of excited move $\beta^{(1)}, \dots, \beta^{(\ell)}$ such that $\beta^{(\ell)} \circ \dots \circ \beta^{(1)}([\mu]) = D$, let $\beta^{(r)} = \beta_{(x-1, y-1)}$ be the excited move that moved $(x-1, y-1)$ to $u = (x, y)$. Such an index r exists, since $u = (x, y)$ in D is not in $[\mu]$, i.e. $u \neq \mu(u)$. Let $D'' := \beta^{(r-1)} \circ \dots \circ \beta^{(1)}([\mu])$ and $T'' = \Phi(D'')$. Note that by the choice of r , the values of cells (a, b) and $(a+1, b)$ remain the same from $\Phi(\beta^{(r)}(D''))$ to T . So it is enough to consider the values of these cells in T'' , T , and T' , respectively. By the induction hypothesis, T'' and T are semistandard, so

$$T''(a+1, b) > T''(a, b), \quad T(a+1, b) > T(a, b).$$

Since the excited move β_x on D'' increased by 1 the number of the broken diagonals on the m th column of γ_j and did not change the number of the broken diagonals on the n th column of γ_j . Thus by definition of Φ , we have that

$$T(a+1, b) = T''(a+1, b) + 1, \quad T(a, b) = T''(a, b).$$

This implies that $T(a+1, b) > T(a, b) + 1$. Similarly, the same analysis on the excited move β_u on D implies that

$$T'(a, b) = T(a, b) + 1, \quad T'(a+1, b) = T(a+1, b).$$

Therefore we have $T'(a+1, b) > T'(a, b)$, as desired. This shows that Φ is well-defined.

Next, we show that Φ is injective. Note that for $D \neq D'$ in $\mathcal{E}(\lambda/\mu)$, their corresponding Kreiman paths $(\gamma_1, \dots, \gamma_k)$ and $(\gamma'_1, \dots, \gamma'_k)$ in $\mathcal{NIP}(\lambda/\mu)$ differ. Thus there is an index i where $\gamma_i \neq \gamma'_i$. Since the endpoints of these paths are the same there exists a column where these paths have a different number of broken diagonals. Thus the tableaux $\Phi(D)$ and $\Phi(D')$ are different too. \square

Lemma 3.9 (Commutation β and δ). *Given an excited diagram D in $\mathcal{E}(\lambda/\mu)$ and an active cell $u = (a, b)$ of D we have that*

$$\Phi(\beta_u(D)) = \delta_{f(u)}(\Phi(D)),$$

where $f(a, b) = (i; \mu(a, b))$, i is the index of the Kreiman path $\gamma_i(D)$ modified by $\beta(a, b)$, and $\mu(a, b)$ is the column of the original cell in μ where (a, b) came from.

Proof. The excited move $\beta_{(a,b)}$ corresponds to a ladder move on $\gamma_i(D) \rightarrow \gamma_i(D')$, for some i and a broken diagonal shift from $(a+1, b+1)$ to $(a+1, b)$. Let g_i and t_i be the starting columns of $\gamma_i(D)$ and θ_i respectively. Suppose $(a+1, b)$ is in the j th column of the path $\gamma_i(D)$. Then the excited move $\beta_{(a,b)}$ shifts a broken diagonal to the j th column of $\gamma_i(D')$, where $j = b - g_i + 1$. The j th column of $\gamma_i(D)$ corresponds to the j th column of θ_i , which in turn corresponds to column $t_i + j - 1$ of shape λ/μ . By Proposition 2.8 we know that $g_i - t_i = \epsilon_i$. Thus we have that

$$\text{col}_{\lambda/\mu}(\theta_i, j) = t_i + j - 1 = (g_i - \epsilon_i) + (b - g_i + 1) - 1 = b - \epsilon_i.$$

Next, number of times the cell (a, b) has been excited is $b - \mu(a, b)$. This quantity is also equal to the number of paths $\gamma_j(D)$ that cross the diagonal of (a, b) NW from it and thus this number is also ϵ_i . Therefore we have that $\text{col}_{\lambda/\mu}(\theta_i, j) = \mu(a, b)$. This shows that $\Phi(\beta_u(D))$ has increments of 1 on θ_i at column $\mu(a, b)$ compared to $\Phi(D)$. This is equivalent to what the move $\delta_{(i; \mu(a, b))}$ does on $\Phi(D)$. Thus $\Phi(\beta_u(D)) = \delta_{(i; \mu(a, b))}(\Phi(D))$, as desired. \square

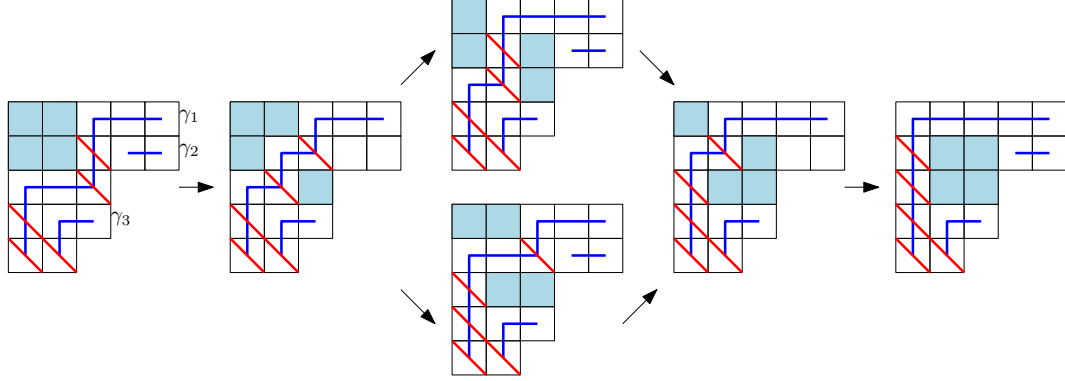

FIGURE 6. The excited diagrams of shape $55332/22$, their corresponding non-intersecting paths (in blue) and broken diagonals (in red).

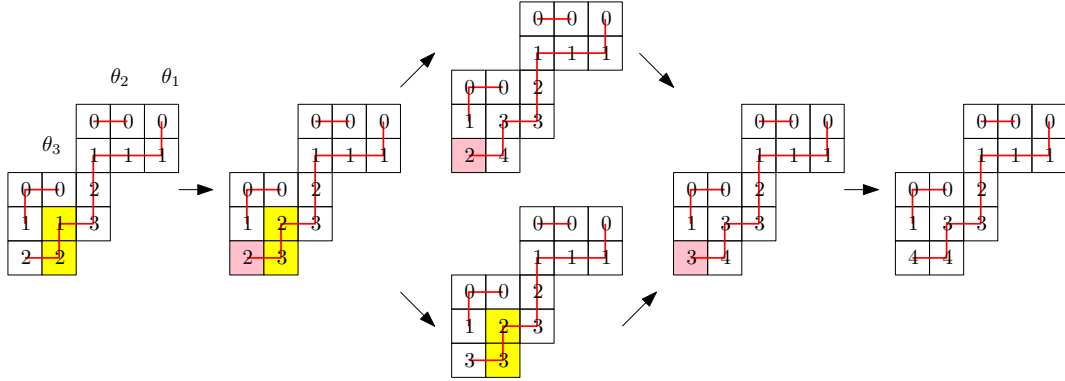

FIGURE 7. The corresponding minimal SSYT of shape $55332/22$.

We are now ready to give the proof of Theorem 3.6.

Proof of Theorem 3.6. By Lemma 3.9, Φ intertwines the excited moves β and δ , as desired.

Next, by Lemma 3.8, Φ is injective. Note that $\Phi([\mu]) = T_0$. Given any excited diagram D in $\mathcal{E}(\lambda/\mu)$, there exists a sequence β_1, \dots, β_m of excited moves such that $D = \beta_m \circ \dots \circ \beta_1([\mu])$. Iterating Lemma 3.9 gives that

$$\Phi(D) = \delta_m \circ \dots \circ \delta_1(T_0).$$

Thus $\Phi(D)$ is in $\text{SSYT}_{\min}(\lambda/\mu)$ and so $\Phi(\mathcal{E}(\lambda/\mu)) \subseteq \text{SSYT}_{\min}(\lambda/\mu)$. It remains to show that $\Phi(D)$ is surjective. Given T in $\text{SSYT}_{\min}(\lambda/\mu)$, there exists a sequence of $\delta_1, \dots, \delta_k$ of excited moves such that $\delta_k \circ \dots \circ \delta_1(T_0) = T$. Again, iterating Lemma 3.9 we have that for $D' = \beta_k \circ \dots \circ \beta_1([\mu])$. From this one obtains $\Phi(D') = T$, as desired. \square

3.3. Non-recursive Characterization of $\text{SSYT}_{\min}(\lambda/\mu)$. In this section, we give a different non-recursive characterization of the set $\text{SSYT}_{\min}(\lambda/\mu)$ in terms of the height function from Definition 2.2. This new characterization will be related to the flagged tableaux $\mathcal{SF}(\lambda/\mu)$ of the Okounkov–Olshanski formula in Section 5. Intuitively, the characterization states that a SSYT T of shape λ/μ is minimal if the values along a strip θ_r and row i are bounded by the distance from the top in θ_k , and entries in a column of θ_r differ by 1.

Theorem 3.10. *Given a shape λ/μ , a SSYT T of shape λ/μ is in $\text{SSYT}_{\min}(\lambda/\mu)$ if and only if*

- (i) For each (i_r, j_r) in θ_r , $T(i_r, j_r) \leq ht_{\theta_r}(i_r)$
- (ii) For any (i_r, j_r) and $(i_r + 1, j_r)$ in θ_r , $T(i_r + 1, j_r) - T(i_r, j_r) = 1$.

In other words, $\text{SSYT}_{\min}(\lambda/\mu)$ consists of SSYT of shape λ/μ where the values along each path θ_r are bounded by the height ht_{θ_r} and the values along entries in the same columns of θ_r differ by one.

Example 3.11. For $\lambda/\mu = 4321/21$ the SSYT of this shape satisfying Conditions (i),(ii) of Theorem 3.10 are

		0	0
	0	1	
0	1		
1			

		0	0
	1	1	
0	2		
1			

		0	0
	0	1	
1	1		
2			

		0	0
	1	1	
1	2		
2			

		0	0
	1	1	
2	2		
3			

Proof of Theorem 3.10. Denote by $\text{SSYT}'_{\min}(\lambda/\mu)$ the set of SSYT of shape λ/μ satisfying conditions (i) (ii) in the statement above. We show that $\text{SSYT}_{\min}(\lambda/\mu) = \text{SSYT}'_{\min}(\lambda/\mu)$.

First, we use the definition of $\text{SSYT}_{\min}(\lambda/\mu)$ via excited moves δ to show that $\text{SSYT}_{\min}(\lambda/\mu) \subseteq \text{SSYT}'_{\min}(\lambda/\mu)$. Indeed, T_0 is in $\text{SSYT}'_{\min}(\lambda/\mu)$ since T_0 has consecutive values in its columns and $T_0(i, j) \leq ht_r(i)$. The latter follows from $T_0(i, j) = i - \mu'_j + 1$ and the fact that the row number $f(\theta_r)$ of the final element of θ_r in Definition 2.2 satisfies $f(\theta_r) \geq \mu'_j - 1$. Next, we show that the excited move δ (Definition 3.1) preserves Conditions (i),(ii) from the statement. For a column $\theta_k(j)$ of T to be active, $T(a, b) < ht_{\theta_k}(i)$ for all $(a, b) \in \theta_k(j)$. The excited move δ adds one to each entry in the column segment $\theta_k(j)$. Thus we also have $\delta(T)(a, b) \leq ht_{\theta_k}(i)$, preserving Condition (i). Also, the column differences $\delta(T)(i+1, j) - \delta(T)(i, j)$ in the column segment $\theta_k(j)$ remain 1, preserving Condition (ii).

For the other inclusion, $\text{SSYT}'_{\min}(\lambda/\mu) \subseteq \text{SSYT}_{\min}(\lambda/\mu)$, we need to show that given tableau $T \in \text{SSYT}'_{\min}(\lambda/\mu)$, there exists a sequence of excited moves $\delta^{(1)}, \dots, \delta^{(m)}$ such that $\delta^{(m)} \circ \dots \circ \delta^{(1)}(T_0) = T$.

Let T be a tableau in $\text{SSYT}'_{\min}(\lambda/\mu)$ and $(\theta_1, \dots, \theta_k)$ be the Lascoux–Pragacz decomposition of shape λ/μ . Consider the element-wise difference $\bar{T} := T - T_0$. We know that $T(i, j) \geq T_0(i, j)$ for all $(i, j) \in [\lambda/\mu]$, so $\bar{T}(i, j) \geq 0$ for all cells. Choose a strip θ_{k_1} with maximal diagonal distance ϵ_{k_1} such that \bar{T} has a non-zero element. In θ_{k_1} choose the left most column c_1 with a non-zero element. Subtract one from each entry of that column of θ_{k_1} . Repeat the algorithm until $\bar{T} = 0$ (see Figure 8). Then, we have a finite sequence of strips and columns: $(\theta_{k_1}, c_1), \dots, (\theta_{k_m}, c_m)$ such that $\delta_{(k_m; b_m)}^{-1} \circ \dots \circ \delta_{(k_1; b_1)}^{-1}(T) = T_0$. Thus $\delta^{(m)} \circ \dots \circ \delta^{(1)}(T_0) = T$, where $\delta^{(j)} := \delta_{(k_m-j+1; b_m-j+1)}$ for $j = 1, \dots, m$ and so $T \in \text{SSYT}_{\min}(\lambda/\mu)$ as desired. \square

3.4. The inverse of Φ : a bijection between $\text{SSYT}_{\min}(\lambda/\mu)$ and $\mathcal{E}(\lambda/\mu)$. In this section, we give an explicit description of the inverse of the bijection Φ that will help us give the reformulation of (NHLF) in Section 4.

Given any $T \in \text{SSYT}_{\min}(\lambda/\mu)$, let $\bar{T} = T - T_0$. Note that by Condition (ii) in Theorem 3.10, \bar{T} is constant on the column segments of each θ_k . We denote by $\bar{T}(\theta_k(j))$ the value of \bar{T} on the j th column segment of θ_k . The next lemma gives a description of the inverse of Φ

Lemma 3.12 (Inverse of Φ). *Let $D \in \mathcal{E}(\lambda/\mu)$ and $T \in \text{SSYT}_{\min}(\lambda/\mu)$ such that $T = \Phi(D)$. Then*

$$D = \{(i + \alpha, j + \alpha) \mid (i, j) \in [\mu]\},$$

where α is the number of strips θ_k such that $\bar{T}(\theta_k(j)) > \mu'_j - i$.

Proof. Given $T \in \text{SSYT}_{\min}(\lambda/\mu)$, in order to recover its corresponding excited diagram, it suffices to find how many times α has each cell (i, j) in $[\mu]$ been excited to obtain cell $(i + \alpha, j + \alpha)$ in the diagram.

Let $\bar{T} := T - T_0$. For (i, j) in $[\mu]$, $\bar{T}(\theta_t(j))$ indicates the number of times the j th column of θ_t has been excited by δ . In terms of Kreiman paths, by the proof of Lemma 3.9, $\bar{T}(\theta_t(j))$ is also the number of times the j th column of γ_t has been modified by the ladder move corresponding to β . Given $(a, b) \in D$, let (a_μ, b_μ) be the original position from $[\mu]$ the cell (a, b) came from. The

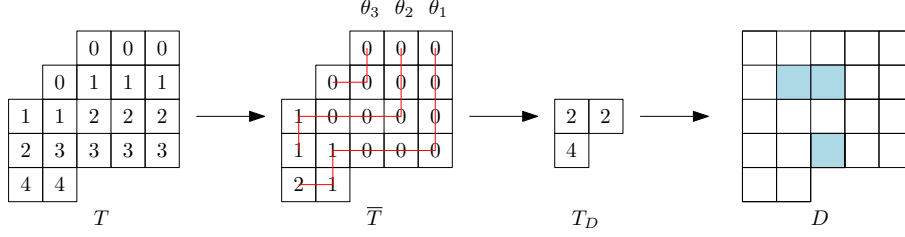
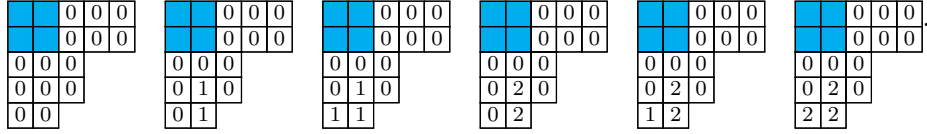

FIGURE 9. Example of bijection $(\Phi)^{-1}$ between a minimal SSYT and excited diagrams for the shape $\lambda/\mu = 55552/21$.

Example 4.2. For the shape $\lambda/\mu = 55332/22$, from each of its minimal tableaux in Figure 7 we find \bar{T} :



For each such \bar{T} and (i, j) in $[22]$, we calculate α . Putting everything together using (4.1) gives

$$\begin{aligned}
 f^{\lambda/\mu} &= \frac{14!}{9 \cdot 8^2 \cdot 7 \cdot 6 \cdot 5^2 \cdot 4^2 \cdot 3^2 \cdot 2^4} (h(1, 1)h(1, 2)h(2, 1)h(2, 2) + h(1, 1)h(1, 2)h(2, 1)h(2 + 1, 2 + 1) \\
 &\quad + h(1, 1)h(1 + 1, 2 + 1)h(2, 1)h(2 + 1, 2 + 1) + h(1, 1)h(1, 2)h(2 + 1, 1 + 1)h(2 + 1, 2 + 1) + \\
 &\quad + h(1, 1)h(1 + 1, 2 + 1)h(2 + 1, 1 + 1)h(2 + 1, 2 + 1) + h(1 + 1, 1 + 1)h(1 + 1, 2 + 1)h(2 + 1, 2 + 1)), \\
 &= 445445.
 \end{aligned}$$

4.2. Enumeration of $\text{SSYT}_{\min}(\lambda/\mu)$. Since minimal SSYT are in bijection with excited diagrams, we immediately obtain a determinant formula to count the former.

Corollary 4.3. For a skew shape λ/μ we have that

$$|\text{SSYT}_{\min}(\lambda/\mu)| = \det \left[\left(\begin{matrix} \vartheta_i + \mu_i - i + j - 1 \\ \vartheta_i - 1 \end{matrix} \right)_{i,j=1}^{\ell(\mu)} \right],$$

where ϑ_i is the row where the diagonal through the cell (i, μ_i) intersects the boundary of $[\lambda]$.

Proof. The result follows by combining Theorem 3.6 and Theorem 2.11. □

For certain shapes, the characterization of minimal SSYT of skew shape allows to directly enumerate them and recover nice known formulas.

The following formulas follow directly from the equivalence with excited diagrams, together with the fact that the complements of $\mathcal{E}(\lambda/\mu)$ are non-intersecting lattice paths. Here we give a direct interpretations from the SSYT point of view.

Let $C_n = \frac{1}{n+1} \binom{2n}{n}$ be the n th Catalan number.

Proposition 4.4 ([15, Cor. 8.1]). For the zigzag shape $\lambda/\mu = \delta_{n+2}/\delta_n$, we have that

$$|\text{SSYT}_{\min}(\delta_{n+2}/\delta_n)| = C_n.$$

Proof. The zigzag shape δ_{n+2}/δ_n has only one Lascoux–Pragacz path. By the characterization of minimal SSYT in Theorem 3.10, every $T \in \text{SSYT}_{\min}(\delta_{n+2}/\delta_n)$ is determined by the elements of the inner corners. Also, note that the inner corner of the n th column is fixed as 0 because it is always on the first row of the shape. Reading the rest of the inner corners from right to left, we have a word $w_1 w_2 \dots w_{n-1}$ that determines $T \in \text{SSYT}_{\min}(\delta_{n+2}/\delta_n)$.

Each inner corner w_i is on row $i + 1$. Then by condition (i) from Theorem 3.10 we have $w_i \leq i$ and by condition (ii), the element below w_i is always $w_i + 1$. Thus, w_{i+1} is always to the left of such element, therefore $w_{i+1} \leq w_i + 1$. Words $w_1 w_2 \cdots w_{n-1}$ satisfying $w_i \leq i$ and $w_{i+1} \leq w_i + 1$ are one of the objects counted by the Catalan numbers [28, Exercise 6.19 u]. \square

Proposition 4.5 ([16, Ex. 3.2]). *Let m and n be nonnegative integers. For the reverse hook $\lambda/\mu = (m + 1)^{n+1}/m^n$ we have that*

$$|\text{SSYT}_{\min}(\lambda/\mu)| = \binom{n+m}{n}.$$

Proof. The reverse hook shape has only on Lascoux–Pragacz path. By the characterization of minimal SSYT in Theorem 3.10, in every $T \in \text{SSYT}_{\min}((m + 1)^{n+1}/m^n)$ the entries of column $m + 1$ are fixed to be $0, 1, \dots, n$. Reading the remaining elements on the $(n + 1)$ th row from left to right, gives the sequence a_1, a_2, \dots, a_m that determine T . By Condition (ii) in the characterization of minimal SSYT, we have $0 \leq a_1 \leq a_2 \leq \cdots \leq a_m \leq n$. The number of such sequences is given by $\binom{n+m}{n}$, as desired. \square

5. NEW RELATIONS BETWEEN THE NARUSE AND THE OKOUNKOV–OLSHANSKI FORMULA

In this section we use the explicit non-recursive description of the minimal tableaux in $\text{SSYT}_{\min}(\lambda/\mu)$ of Theorem 3.10 to relate the number $\text{ED}(\lambda/\mu)$ of terms of (NHLF) and the number $\text{OOT}(\lambda/\mu)$ of terms of (OOF).

5.1. Inequality between the number of terms.

Theorem 5.1. *For a skew shape λ/μ we have that $\text{ED}(\lambda/\mu) \leq \text{OOT}(\lambda/\mu)$.*

The result follows immediately from the following lemma that states that after adding one to each entry in a minimal skew SSYT of shape λ/μ , we obtain a flagged tableaux in $\mathcal{SF}(\lambda/\mu)$. Let $\mathbf{1}_{\lambda/\mu}$ denote the tableaux of shape λ/μ with all 1s.

Lemma 5.2. *For a skew shape λ/μ we have that*

$$\{T + \mathbf{1}_{\lambda/\mu} \mid T \in \text{SSYT}_{\min}(\lambda/\mu)\} \subseteq \mathcal{SF}(\lambda/\mu),$$

where $T + \mathbf{1}_{\lambda/\mu}$ denotes entrywise addition.

Proof. Let T be a tableau in $\text{SSYT}_{\min}(\lambda/\mu)$. By Condition (i) in Theorem 3.10, we have that for (i, j) in θ_r , $T(i, j) \leq ht_{\theta_r}(i)$. By Definition 2.2 we have that $ht_{\theta_r}(i) \leq i - 1$. Thus $T + \mathbf{1}_{\lambda/\mu}$ is a flagged tableau in $\mathcal{SF}(\lambda/\mu)$. \square

Example 5.3. *Adding $\mathbf{1}_{\lambda/\mu}$ to the minimal SSYT in Figure 4a yields a flagged tableau in $\mathcal{SF}(\lambda/\mu)$, which in fact is the one depicted in Figure 4b.*

Proof of From Theorem 5.1. By Theorem 3.6, we have $\text{ED}(\lambda/\mu) = |\text{SSYT}_{\min}(\lambda/\mu)|$. By Lemma 5.2, we have $|\text{SSYT}_{\min}(\lambda/\mu)| \leq |\mathcal{SF}(\lambda/\mu)|$, and the result follows since by Proposition 2.19, we have that $|\mathcal{SF}(\lambda/\mu)| = \text{OOT}(\lambda/\mu)$. \square

Remark 5.4. *As illustrated in Figure 4, if an excited diagram D and a reverse excited diagram S have equal (up to adding $\mathbf{1}_{\lambda/\mu}$) minimal SSYT and skew flagged tableau of shape λ/μ , their corresponding flagged tableau and Okounkov–Olshanski tableau of shape μ may differ.*

The next result characterizes the skew shapes where the Naruse hook-length formula and the Okounkov–Olshanski formula have the same number of terms.

Theorem 5.5. *For a connected skew shape λ/μ with $d = \ell(\lambda)$ and $r = \max\{i \mid \mu_1 = \mu_i\}$ we have that $\text{ED}(\lambda/\mu) \leq \text{OOT}(\lambda/\mu)$ with equality if and only if $\lambda_d \geq \mu_r + d - r$.*

Proof. The inequality $\text{ED}(\lambda/\mu) \leq \text{OOT}(\lambda/\mu)$ follows from Theorem 5.1. By Lemma 5.2 we have that equality occurs if and only if all the flagged tableaux in $\mathcal{SF}(\lambda/\mu)$ are minimal. First, define the “maximal” tableau $T \in \mathcal{SF}(\lambda/\mu)$ as $T(i, j) = i - 1$ for $(i, j) \in [\lambda/\mu]$, and let $\theta_1, \dots, \theta_k$ be the Lascoux–Pragacz decomposition of λ/μ .

Suppose that there is a border strip θ_k which does not reach the top row of $[\lambda/\mu]$. By the height condition in the definition of minimal tableaux (Condition (i) in Theorem 3.10), it follows that for an entry at (i, j) in θ_k we have $i - 1 = T(i, j) \leq ht_{\theta_k}(i) < i - 1$, a contradiction. Thus all border strips reach the top row of $[\lambda/\mu]$.

Next, suppose that there is a border strip θ_k , which has a column c of height at least 2 for some $c \leq \mu_1$, and let t be the topmost row in that column of θ_k . We then construct another tableaux T' from T by setting $T'(i, j) = T(i, j) - 1$ for pairs (i, j) such that $i \leq t$ and $j \leq c$, and set $T'(i, j) = T(i, j)$ otherwise. Note that since $j \leq c \leq \mu_1$ we have that $i \geq 2$ and thus $T'(i, j) = T(i, j) - 1 = i - 2$ is well defined. Note also that T' is still a SSYT in $\mathcal{SF}(\lambda/\mu)$. Finally, note that T' violates the condition on consecutive elements in a column of a border strip for the minimal tableaux since $T'(t + 1, c) = t > t - 1 = T'(t, c) + 1$ and $(t + 1, c), (t, c) \in \theta_k$. Thus $\text{SSYT}_{\min}(\lambda/\mu) \subsetneq \mathcal{SF}(\lambda/\mu)$ and we do not have equality between $\text{ED}(\lambda/\mu)$ and $\text{OOT}(\lambda/\mu)$.

Hence we see that the border strips θ_i are entirely horizontal in the first μ_1 columns of λ/μ and we have $d - r$ of them starting in the first μ_1 columns. Thus $\lambda_d \geq \mu_1$. Also, since these border strips reach the top row, they must all cross the diagonal starting at (r, μ_r) and thus this diagonal extends to the last row of the shape, so $\lambda_d \geq \mu_r + d - r$, which proves the forward direction. See Figure 10.

Now, if $\lambda_d \geq \mu_r + d - r$, then it is easy to see that all border strips θ_i reach the top row and they are horizontal in the first μ_1 columns. The tableaux in $\mathcal{SF}(\lambda/\mu)$ consisting of the columns past μ_1 are of straight shape, and since the entries in row i are bounded by $i - 1$, the strict increase in the full columns implies that such entries have to be exactly $i - 1$. For the first μ_1 columns, since all border strips are horizontal, there are no further restrictions coming from the minimal tableaux. Thus $\text{SSYT}_{\min}(\lambda/\mu) = \mathcal{SF}(\lambda/\mu)$, as desired. \square

Motivated by this result, we call the connected skew shapes λ/μ where we have equality $\text{ED}(\lambda/\mu) = \text{OOT}(\lambda/\mu)$ *slim skew shapes*, see [18, §11] and [17, §2.1]¹. Next, we show that for slim skew shapes λ/μ where there is equality $\mathcal{E}(\lambda/\mu) = \text{OOT}(\lambda/\mu)$, this number is given by a product.

Corollary 5.6. *For a connected skew shape λ/μ satisfying $\lambda_d \geq \mu_r + d - r$ where $d = \ell(\lambda)$ and $r = \max\{i \mid \mu_1 = \mu_i\}$, we have that*

$$\text{ED}(\lambda/\mu) = \text{OOT}(\lambda/\mu) = \prod_{u \in [\mu]} \frac{d + c(u)}{h(u)}.$$

Proof. By Theorem 5.5, for such skew shapes λ/μ we have the equality $\text{ED}(\lambda/\mu) = \text{OOT}(\lambda/\mu)$. By definition of r we have that $\mu_1 = \mu_r$, and thus $\lambda_d \geq \mu_1 + d - r \geq \mu_1$. By [19, Proposition 7.14], since $\mu_1 \leq \lambda_d$ then $\mathcal{OOT}(\lambda/\mu) = \text{SSYT}(\mu, d)$ and so $\text{OOT}(\lambda/\mu) = s_\mu(1^d)$, which is given by the *hook-content formula* (see [28, Cor. 7.21.4] and [19, Cor. 7.15]). \square

5.2. Comparing terms of hook formulas for skew shapes. A natural question to ask is whether for slim shapes λ/μ , the formulas (NHLF) and (OOF) not only have the same number of terms but they are also term-by-term equal. As the next example shows, the terms can be different.

¹The convention for slim shapes in the articles [18, §11] and [17, §2.1] matches our condition in the case of $r = 1$.

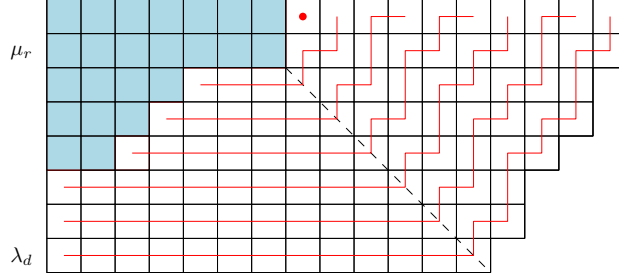

FIGURE 10. Illustration of skew shapes λ/μ and their Lascoux–Pragacz decomposition with $\lambda_d \geq \mu_r + d - r$ where $\text{ED}(\lambda/\mu) = \text{OOT}(\lambda/\mu)$.

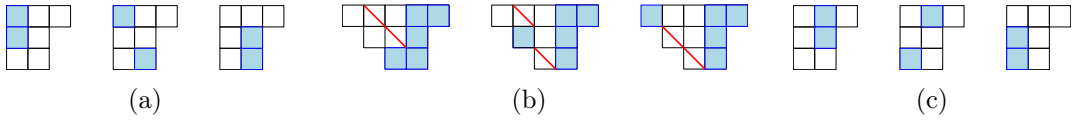

FIGURE 11. For the shape slim shape $\lambda/\mu = 322/11$, an illustration of its (a) Excited diagrams, (b) reverse excited diagrams, and (c) NE excited diagrams.

Example 5.7. *The shape $\lambda/\mu = 322/11$ is slim with three excited and three reverse excited diagrams, respectively. See Figure 11a, 11b. The formulas (NHLF) and (OOF), respectively give*

$$\begin{aligned} f^{\lambda/\mu} &= \frac{5!}{5 \cdot 4 \cdot 3 \cdot 2^2 \cdot 1} (5 \cdot 3 + 5 \cdot 1 + 2 \cdot 1), \\ &= \frac{5!}{5 \cdot 4 \cdot 3 \cdot 2^2 \cdot 1} (4 \cdot 2 + 4 \cdot 2 + 3 \cdot 2) = 11. \end{aligned}$$

However, there is a reformulation of (NHLF) from [17, §3.4] that is then term-by-term equal to (OOF) for slim shapes. To see this, we need the following variation of excited diagrams from [17, §3.4]. Given a slim skew shape λ/μ with $\mu = (\mu_1, \dots, \mu_\ell)$, we denote by $\widehat{\mu} = (0^{d-\ell}, \mu_\ell, \mu_{\ell-1}, \dots, \mu_1)$ the horizontal flip of μ . Since λ/μ is slim then the Young diagram $[\widehat{\mu}] \subset [\lambda/\mu]$. A *NE-excited diagram* is a subdiagram of $[\lambda]$ obtained from the diagram $[\widehat{\mu}]$ after a sequence of moves $D \mapsto D'$ where (i, j) is replaced by $(i - 1, j + 1)$ if (i, j) is in the diagram D and all of $(i - 1, j)$, $(i - 1, j + 1)$, $(i, j + 1)$ are in $[\lambda] \setminus D$. See Figure 11c for an example. The set of these diagrams is denoted by $\mathcal{E}^{\nearrow}(\lambda/\mu)$. From [17, §3.4], flipping horizontally the diagrams gives a bijection between $\mathcal{E}(\lambda/\mu)$ and $\mathcal{E}^{\nearrow}(\lambda/\mu)$. Moreover, as a consequence of the multivariate identity in [17, Thm. 3.12] there is a Naruse-type formula for $f^{\lambda/\mu}$ in terms of the diagrams in $\mathcal{E}^{\nearrow}(\lambda/\mu)$ that appears in [23, §9.1].

Corollary 5.8 ([17, §3.4], [23, §9.1]). *For a slim skew shape λ/μ of size n we have that*

$$(5.1) \quad f^{\lambda/\mu} = \frac{n!}{\prod_{u \in [\lambda]} h(u)} \sum_{D \in \mathcal{E}^{\nearrow}(\lambda/\mu)} \prod_{(i,j) \in D} h(i,j).$$

Next, we show that for slim shapes λ/μ , there is bijection between the reverse excited diagrams and the NE-excited diagrams of λ/μ that preserve the weights of (OOF) and (5.1), respectively.

Definition 5.9. *Given an excited diagram D in $\mathcal{E}^{\nearrow}(\lambda/\mu)$, let $T := \Psi(D)$ be the tableau μ where $T(x, y) = d + 1 - i_x$ where (i_x, j_y) is the cell in D corresponding to $(d + 1 - x, y)$ in $[\widehat{\mu}]$. That is i_x is the row where the cell $(d + 1 - x, y) \in [\widehat{\mu}]$ ended up in after the excited moves. See Figure 12 for an example.*

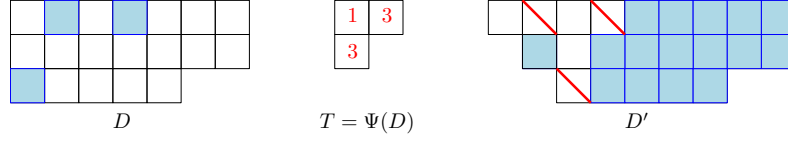

FIGURE 12. Example of the weight preserving bijection between an excited diagrams in $\mathcal{E}^\nearrow(\lambda/\mu)$ (left) and a reverse excited diagrams in $\mathcal{RE}\mathcal{D}(\lambda/\mu)$ (right) for a slim shape via tableaux in $\mathcal{OOT}(\lambda/\mu)$ (middle).

Proposition 5.10. *For a slim shape λ/μ , the map Ψ defined above is a weight preserving bijection between $\mathcal{E}^\nearrow(\lambda/\mu)$ and $\mathcal{OOT}(\lambda/\mu)$. That is, if $\Psi(D) = T$, then*

$$\prod_{(i,j) \in D} h(i,j) = \prod_{(i,j) \in [\mu]} (\lambda_{d+1-T(i,j)} + i - j).$$

Proof. We need to prove that Ψ is a well-defined map between $\mathcal{E}^\nearrow(\lambda/\mu)$ and $\mathcal{OOT}(\lambda/\mu)$. For D in $\mathcal{E}^\nearrow(\lambda/\mu)$, the tableau $T := \Psi(D)$ of shape μ is semistandard by a similar argument as the one in the proof of [16, Prop. 3.6] (induction on the number of excited moves). Also by construction, the entries in T are bounded by d and so $T \in \text{SSYT}(\mu, d)$. Since λ/μ is slim, by the argument in the proof of Corollary 5.6 we have that $\mathcal{OOT}(\lambda/\mu) = \text{SSYT}(\mu, d)$. Thus Ψ is well defined.

Next, we show that Ψ is bijective by building its inverse. Given T in $\mathcal{OOT}(\lambda/\mu)$, let $D := \Omega(T)$ be the set $\{(d+1-T(x,y), y-x+T(x,y)) \mid (x,y) \in [\mu]\}$. This map is well-defined by an argument similar to the one in the proof of [16, Prop. 3.6]. By construction, we have that $\Omega = \Psi^{-1}$, as desired.

Finally, we show that Ψ is weight preserving. If $\Psi(D) = T$ with $T(x,y) = d+1-i_x$ where (i_x, j_y) is the cell in D corresponding to the cell $(d+1-x, y)$ in $[\hat{\mu}]$, then $i_x = d+1-x-c$, and $j_y = y+c$ for some nonnegative integer c (how many times the cell $(d+1-x, y)$ was excited to obtain (i_x, j_y)). Since λ/μ is slim, we have that $\lambda'_{j_x} = d$. Thus the hooklength of cell (i_x, j_y) equals

$$h(i_x, j_y) = \lambda_{i_x} - i_x + \lambda'_{j_y} - j_y + 1 = \lambda_{d+1-T(x,y)} + x - y,$$

as desired. \square

Example 5.11. *Figure 12 illustrates an excited diagram D in $\mathcal{E}^\nearrow(\lambda/\mu)$ for the slim shape $\lambda/\mu = 775/21$, its corresponding tableau $T = \Psi(D)$ in $\mathcal{OOT}(\lambda/\mu)$, and the corresponding reverse excited diagram D' from T . The weight of the hook-lengths of D is $8 \cdot 6 \cdot 5$ which matches the weight of the broken diagonals of D' .*

Corollary 5.12. *For a slim skew shape λ/μ of size n we have that the variation of the NHLF in (5.1) is term-by-term equal to (OOF).*

Proof. This follows immediately by applying the bijection Ψ , which is weight preserving by Proposition 5.10, to rewrite (5.1) in terms of Okounkov–Olshanski tableaux to obtain (OOF). \square

6. HILLMAN-GRASSL BIJECTION ON MINIMAL SKEW TABLEAUX

In this section we show that the Hillman–Grassl bijection restricted to the minimal SSYT of shape λ/μ is equivalent to the inverse of bijection Φ from Section 3. Recall the definition of the array A_D for an excited diagram D in $\mathcal{E}(\lambda/\mu)$ and of the arrays $\mathcal{A}^*(\lambda/\mu)$ from Section 2.6.

6.1. Equivalence of Hillman–Grassl map and Φ^{-1} on minimal SSYT. We state the main result of this section.

Theorem 6.1. *The map Φ^{-1} is equivalent to the Hillman–Grassl map HG on the minimal SSYT of shape λ/μ . That is, for T in $\text{SSYT}_{\min}(\lambda/\mu)$ we have*

$$HG(T) = A_D \text{ if and only if } \Phi^{-1}(T) = D,$$

where the array A_D in $\mathcal{A}^*(\lambda/\mu)$ corresponds to D in $\mathcal{E}(\lambda/\mu)$; i.e. $HG^{-1}(A_D) = \Phi(D)$.

To prove this result we will need the following two lemmas that use the known connection between the Hillman–Grassl correspondence and the RSK bijection (see Theorem 2.26). Let $A(\gamma_i(D))$ be the a subarray of A_D of shape $\lambda \setminus \bigcup_{j=1}^{i-1} \gamma_j(D)$ with support on the broken diagonal of $\gamma_i(D)$.

Lemma 6.2. *For $D \in \mathcal{E}(\lambda/\mu)$ and k an integer $1 - \ell(\lambda) \leq k \leq \lambda_1 - 1$, let $T := HG^{-1}(A_D)$ and $\nu = \nu^{(k)}$ be the partition whose parts are the entries in the k -diagonal of T . Then $\nu_i = |A(\gamma_i(D))_k|$, that is ν_i is the number of broken diagonals in $\gamma_i(D) \cap \square_k^\lambda$.*

Proof. Since $A_D = HG(T)$, by Theorem 2.26 it suffices to show that $ac_t(A_k) = a_1 + a_2 + \cdots + a_t$, where $a_i = |A(\gamma_i(D))_k|$. We consider only $\gamma_i(D)$'s which intersect \square_k^λ and index them in order from the NW-most to the SE-most within \square_k^λ (we can order them, because every such path will intersect the diagonal $j - i = k$).

First, we note that $a_1 > a_2 > \cdots$: this is because a_i is equal to the height of $\gamma_i(D)$ minus 1, and the paths within \square_k^λ start along the lower horizontal border at points P_i and end on the right vertical border at points Q_i , so they end below each other.

Next, note that $ac_t(A_k) \geq a_1 + \cdots + a_t$, because the 1s in each $\gamma_i(D)$ form a NE path (i.e. increasing sequence).

To show the opposite inequality, we consider the broken diagonals in \square_k^λ , that is $\text{Br}(D) \cap \square_k^\lambda$. Let $\alpha_1 \sqcup \cdots \sqcup \alpha_t$ be a disjoint collection of maximal nonoverlapping NE paths, so $ac_t(A_k) = |\alpha_1| + \cdots + |\alpha_t|$. We can assume that these paths are nonintersecting also, as we can relabel their parts at intersections. The diagonal steps in each broken diagonal form a SE monotone path, i.e. no squares in the same row or column. Thus for every broken diagonal d_i , we must have $|d_i \cap \alpha_j| \leq 1$. Thus,

$$ac_t(A_k) \leq \sum_i \max\{|d_i \cap \square_k^\lambda|, t\}.$$

We now show that this upper bound is exactly the contribution from the $\gamma(D)$'s. We have that $d_i \cap \square_k^\lambda$ consists of the vertical steps of the $\gamma(D)$ paths which intersect that broken diagonal. As the γ paths are greedily selected from the inner shape outwards, the first paths will contain the first (NW-most) points from the corresponding d_i 's. Thus

$$|\{d_i \cap \square_k^\lambda\}| = \max\{j : \gamma_j(D) \cap d_i \cap \square_k^\lambda\},$$

and since we are looking at the maximum t many, we naturally limit ourselves to $j \leq t$. Thus we have

$$ac_t(A_k) \leq \sum_i \max\{|d_i \cap \square_k^\lambda|, t\} = |\gamma_1(D) \cap \square_k^\lambda| + \cdots + |\gamma_t(D) \cap \square_k^\lambda| = a_1 + \cdots + a_t,$$

and the proof is done. □

The next lemma confirms that counting broken diagonals in the rectangular subarray $(A_D)_k$ is another way of describing the bijection Φ .

Lemma 6.3. *For $D \in \mathcal{E}(\lambda/\mu)$ and k an integer $1 - \ell(\lambda) \leq k \leq \lambda_1 - 1$, let $T' := \Phi(D) \in \text{SSYT}_{\min}(\lambda/\mu)$ and $\nu = \nu^{(k)}$ be the partition whose parts are the entries in the k -diagonal of T' . Then $\nu_i = |A(\gamma_i(D))_k|$, that is ν_i is the number of broken diagonals in $\gamma_i(D) \cap \square_k^\lambda$.*

Proof. First, recall that T' is decomposed into Lascoux–Pragacz paths $\theta_1, \dots, \theta_m$, where θ_1 is the of λ/μ wrapping around λ . Then for the k -diagonal of T' with values ν_1, \dots, ν_t , the cell with the value ν_i is contained in $\theta_{i'}$ for some $i' \geq i$, where $\epsilon_{i'} = i - 1$ and the cell $(u_1, v_1) \in \theta_1$ with value ν_1 is always the most outer element of the k -diagonal. Note that the cell (u_1, v_1) is also the most outer corner of the corresponding \square_k^λ in A_D . Also, as stated in Definition 3.3, the j th column of $\gamma_{i'}(D)$ corresponds to the j th column of $\theta_{i'}$, starting from the left-most column. Denote t_i and s_i the starting column and row of $\theta_{i'}$ respectively. Let (u, v) be the cell with value ν_i , which is on the j th column of $\theta_{i'}$, i.e. column $t_i + j - 1$. Then by the construction of Φ in Definition 3.3 (1) and (2), we know that $\nu_i = T'(u, v)$ is the number of accumulated broken diagonals of $\gamma_i(D)$ until the j th column of this path and by Definition 3.3 (3) we need to subtract the number $s_i - u$ of north steps from the initial cell, thus

$$(6.1) \quad \nu_i = |A(\gamma_i(D))|_j - s_i + u,$$

where $|A(\gamma_i(D))|_j$ is the number of broken diagonals of $\gamma_i(D)$ until the j th column. For the Kreiman paths in A_D , denote by g_i and f_i the starting column and row of $\gamma_i(D)$, respectively. The j th column of $\gamma_{i'}(D)$ is then $g_i + j - 1$. By Lemma 2.8 we know that $g_i - t_i = \epsilon_{i'}$, the diagonal distance from θ_1 to θ_i (and similarly, also $f_i - s_i = \epsilon_{i'}$). So the j th column of $\gamma_i(D)$ is $t_i + j - 1 + \epsilon_i$. Recall that the cell with value ν_i of the k -diagonal is on column $t_i + j - 1$. Then the column $t_i + j - 1 + \epsilon_i$, the j th column of $\gamma_i(D)$, is the last column in \square_k^λ . Also the rectangle \square_k^λ does not include the broken diagonals of $\gamma_i(D)$ that lie below the position (u_1, v_1) , so we need to subtract $f_i - u_1$ many broken diagonals from $|A(\gamma_i(D))|$ to obtain $|A(\gamma_i(D))_k|$. That is, we have that

$$(6.2) \quad |A(\gamma_i(D))_k| = |A(\gamma_i(D))|_j - f_i - u_1.$$

Note that the diagonal distance between the cell with the value ν_i and ν_1 is ϵ_i . Then $u_1 - u = \epsilon_i$. Then by Lemma 2.8, $f_i - u_1 = s_i + \epsilon_i - (u - \epsilon_i) = s_i - u$. Combining this with (6.1) and (6.2) we obtain that $\nu_i = |A(\gamma_i(D))_k|$, as desired. \square

We are now ready to prove the main result of this section.

Proof of Theorem 6.1. For an excited diagram $D \in \mathcal{E}(\lambda/\mu)$, let $T := HG^{-1}(A_D)$ and $T' = \Phi(D)$. By Lemma 6.2 and Lemma 6.3, the tableaux T and T' agree on each k -diagonal for $1 - \ell(\lambda) \leq k \leq \lambda_1 - 1$. Thus $T = T'$ as desired. \square

Example 6.4. Figure 13a shows an excited diagram D for the shape $\lambda/\mu = 55552/21$ with its broken diagonals and Kreiman paths $\gamma_1, \gamma_2, \gamma_3$ and the tableau $T = HG^{-1}(A_D) = \Phi(D)$. The parts of the partition $\nu = \nu^{(1)} = 321$ obtained from the 1-diagonal of T can be read from the number of broken diagonals in $\gamma_i(D)$ inside the rectangle \square_1^λ for $i = 1, 2, 3$, respectively.

Remark 6.5. Lemma 6.2 does not hold for general excited arrays with nonnegative entries other than 0/1. This is because the longest ascending chain might involve entries from distinct γ_i . See Example 6.6.

Example 6.6. Figure 13b shows an excited array A'_D for the same excited diagram as Example 6.4 and the tableau $T' = HG^{-1}(A'_D)$. The first part 5 of the partition $\nu = \nu^{(1)} = 521$ obtained from the 1-diagonal of T' corresponds to an ascending chain involving entries from two paths γ_1 and γ_2 .

6.2. Leading terms of the SSYT q -analogue of Naruse's formula. In this section we give an expression for the leading terms of (1.4).

Corollary 6.7. For a skew shape λ/μ we have

$$(6.3) \quad \sum_{T \in \text{SSYT}_{\min}(\lambda/\mu)} q^{|T|} = \sum_{D \in \mathcal{E}(\lambda/\mu)} q^{\sum_{(i,j) \in D} (\lambda'_j - i)}.$$

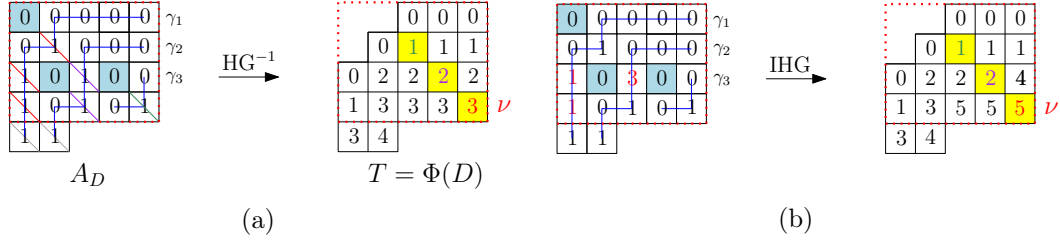

FIGURE 13. (a) Illustration of the relation between Greene’s theorem and the map Φ . The parts of ν encode the number of broken diagonals in each $\gamma_i(D)$ inside the rectangle \square_k^λ . (b) Counterexample of why this relation does not hold if the entries of the array are other than 0/1.

Proof. From Theorem 6.1 and the fact that the Hillman–Grassl bijection is weight preserving (2.3) we have that

$$\sum_{T \in \text{SSYT}_{\min}(\lambda/\mu)} q^{|T|} = \sum_{D \in \mathcal{E}(\lambda/\mu)} q^{\sum_{u \in A_D} h(u)}.$$

By [16, Prop. 7.16] we have that $\sum_{u \in A_D} h(u) = \sum_{(i,j) \in \lambda \setminus D} (\lambda'_j - i)$ and the result follows. \square

This result motivates calling the polynomial in (6.3) a q -analogue of the number of excited diagrams of shape λ/μ and denoting it by $\mathcal{E}_q(\lambda/\mu)$. Next, we give some examples of this polynomial. It would be of interest to study $\mathcal{E}_q(\lambda/\mu)$ further.

Example 6.8. For the shape $\lambda/\mu = 55332/22$ whose excited diagrams and minimal tableaux are illustrated in Figures 7,6 we have that

$$\mathcal{E}_q(\lambda/\mu) = q^{14}(q^2 + q^3 + q^4 + q^5 + q^6).$$

Example 6.9. Let m and n be nonnegative integers. For the reverse hook $\lambda/\mu = (m+1)^{n+1}/m^n$, the number of excited diagrams is given by $\binom{n+m}{n}$ (Proposition 4.5) and these diagrams are in bijection with lattice paths γ from $(m+1, 1)$ to $(1, n+1)$ inside the $(m+1) \times (n+1)$ rectangle (see [16, Ex. 3.2]). A direct consequence of [16, Ex. 3.2] and [29, Prop. 1.7.3] is the following

$$\mathcal{E}_q((m+1)^{n+1}/m^n) = q^{\binom{n+1}{2}} \sum_{\gamma: (m+1,1) \rightarrow (1,n+1)} q^{\text{area}(\gamma)} = q^{\binom{n+1}{2}} \begin{bmatrix} n+m \\ n \end{bmatrix}_q,$$

where $\text{area}(\gamma)$ is the number of cells in the rectangle $(m+1) \times (n+1)$ South East of γ , and $\begin{bmatrix} a \\ b \end{bmatrix}_q$ denotes the q -binomial coefficient.

Example 6.10. For the reverse hook $\lambda/\mu = \delta_{n+2}/\delta_n$, the number of excited diagrams is given by the Catalan number C_n (Proposition 4.4) and these diagrams are in bijection with Dyck paths (see [15, §8]). Let $\text{Dyck}(n)$ be the set of Dyck paths \mathfrak{p} of size n , a direct consequence of [15, Cor. 1.7] is the following

$$\mathcal{E}_q(\delta_{n+2}/\delta_n) = \sum_{\mathfrak{p} \in \text{Dyck}(n)} q^{\sum_{(a,b) \in \mathfrak{p}} b} = q^n \sum_{\mathfrak{p} \in \text{Dyck}(n)} q^{2 \cdot \text{area}(\mathfrak{p})} = q^n C_n(q^2),$$

where $\text{area}(\mathfrak{p})$ denotes the area of the Dyck path \mathfrak{p} and $C_n(q)$ denotes the q -Catalan number (see [5, Ch. 1]).

$$\begin{array}{|c|c|c|c|c|} \hline \bullet & 0 & 0 & 0 & 0 \\ \hline 0 & 0 & 0 & 0 & 0 \\ \hline 1 & 0 & 0 & 0 & 0 \\ \hline 1 & 0 & 0 & 0 & 0 \\ \hline 1 & 0 & & & \\ \hline \end{array}
 +
 \begin{array}{|c|c|c|c|} \hline \bullet & 0 & 0 & 0 \\ \hline 0 & 1 & 0 & 0 \\ \hline 0 & 1 & 0 & 0 \\ \hline 1 & & & \\ \hline \end{array}
 =
 \begin{array}{|c|c|c|c|c|} \hline \bullet & 0 & 0 & 0 & 0 \\ \hline 0 & 1 & 0 & 0 & 0 \\ \hline 1 & 0 & 1 & 0 & 0 \\ \hline 1 & 0 & 1 & 0 & 0 \\ \hline 1 & 1 & & & \\ \hline \end{array}$$

$HG(T_{\theta_1}) \qquad \qquad \qquad HG(T_{\theta_2}) \qquad \qquad \qquad HG(T_{\theta_1 \cup \theta_2})$

FIGURE 14. Convention for adding arrays $A_{\gamma_1(D)}$ and $A_{\gamma_2(D)}$.

6.3. Additivity consequences. In this section as a consequence of Theorem 6.1, we derive some linearity properties of the Hillman–Grassl correspondence on minimal SSYT.

Given T in $\text{SSYT}(\lambda/\mu)$, let T_{θ_i} be the tableau of shape $\lambda \setminus \bigcup_{j=1}^{i-1} \theta_j$ with entries of T in θ_i . We define the sum $A_{\gamma_i(D)} + A_{\gamma_{i+1}(D)}$ as an array of the same shape as $A_{\gamma_i(D)}$ with supports on the broken diagonals of $\gamma_i(D)$ and $\gamma_{i+1}(D)$. In other words the array value of $(u, v) \in A_{\gamma_i} + A_{\gamma_{i+1}}$ is $A_{\gamma_i}(u, v) + A_{\gamma_{i+1}}(u - t, v - t)$ where $t = \epsilon_{i+1} - \epsilon_i$.

Corollary 6.11. *Let $D \in \mathcal{E}(\lambda/\mu)$ and $T = \Phi(D) \in \text{SSYT}_{\min}(\lambda/\mu)$. Then for $i = 1, \dots, k$, we have that*

$$\sum_{i=1}^k HG(T_{\theta_i}) = HG(T).$$

Proof. As mentioned above, we have that $\sum_{i=1}^k A_{\gamma_i(D)} = A_D$ and that the tableau T decomposes as a disjoint union of $\bigcup_i T_{\theta_i}$ of tableaux T_{θ_i} in each border strip. By Theorem 6.1 we have that $HG(T) = A_D$. By construction we have that $T = \bigcup_i T_{\theta_i}$. Since by Definition 3.3, the bijection Φ builds T_{θ_i} just from information in $\gamma_i(D)$ then $\Phi(A_{\gamma_i(D)}) = T_{\theta_i}$. By Theorem 6.1 applied to the border strip θ_i we then have that $HG(T_{\theta_i}) = A_{\gamma_i(D)}$ and the result follows. \square

Example 6.12. *Consider the skew shape $\lambda/\mu = 55552/21$ with Lascoux–Pragacz decomposition $\theta_1, \theta_2, \theta_3$ and the excited diagram D in $\mathcal{E}(\lambda/\mu)$ with Kreiman decomposition $\gamma_1, \gamma_2, \gamma_3$ at the bottom of Figure 15. For $T = \Phi(D)$ we have that $HG(T_{\theta_1}) + HG(T_{\theta_2}) + HG(T_{\theta_3}) = HG(T)$ as illustrated in the figure.*

We can also view Corollary 6.11 as a statement about a rearrangement of the lattice paths involved in the inverse Hillman–Grassl map for each broken diagonal in $A_{\gamma_i(D)}$ and each broken diagonal in A_D . To state this result, we introduce some notation. For each broken diagonal support $b \in A_{\gamma_i(D)}$ ($b \in A_D$ respectively), denote the collection of cells in the lattice path built for its inverse Hillman–Grassl step by $L(b; \theta_i)$ ($L(b)$ respectively).

Corollary 6.13. *Let $D \in \mathcal{E}(\lambda/\mu)$ be an excited diagram with Kreiman decomposition $(\gamma_1, \dots, \gamma_k)$, then as multisets we have that*

$$(6.4) \quad \bigcup_{i=1}^k \left(\bigcup_{b \in \text{Br}(\gamma_i)} L(b; \theta_i) \right) = \bigcup_{b \in \text{Br}(D)} L(b).$$

Proof. By Theorem 6.1 we have that $HG^{-1}(A_D) = T$ and as explained in the proof of Corollary 6.11, from Theorem 6.1 and Definition 3.3 we also have that $HG^{-1}(A_{\gamma_i(D)}) = T_{\theta_i}$. Then for each $(r, s) \in \theta_i$, the entry $T(r, s)$ is the multiplicity of (r, s) in the multiset in the RHS of (6.4) and this entry $T(r, s) = T_{\theta_i}(r, s)$ is also the multiplicity of (r, s) in the multiset $\bigcup_{b \in \text{Br}(\gamma_i)} L(b; \theta_i)$ in the LHS of (6.4). The equality of this multisets follows. \square

Example 6.14. *See Figure 19 for an example of the equality of multisets in (6.4). For instance, the entries in the paths in the first column highlighted in red equal the entries in the second and third column highlighted in blue.*

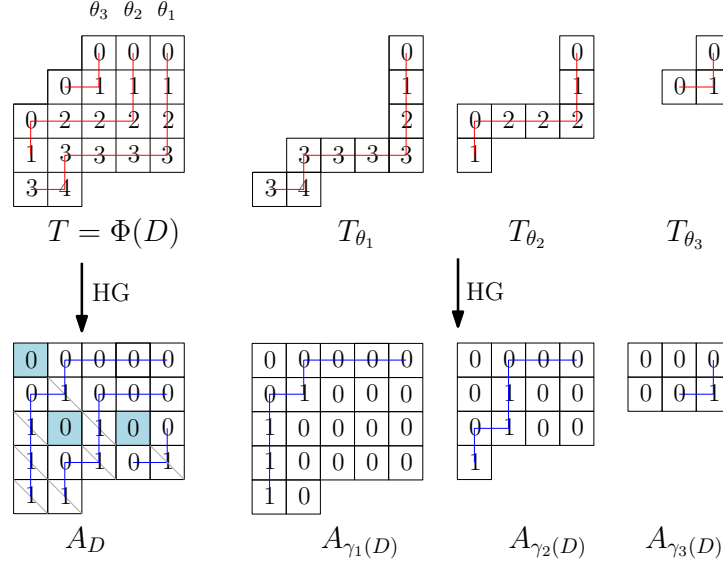
 FIGURE 15. The Hillman-Grassl map of T , and each of T_{θ_1} , T_{θ_2} , and T_{θ_3} separately

7. BIJECTIVE PROOF OF THEOREM 2.28 FOR SSYT OF BORDER STRIPS

In the previous section we showed that Φ^{-1} corresponds to the Hillman-Grassl map restricted to minimal SSYT of shape λ/μ , giving a bijective proof of a special case of Theorem 2.28. In this section we prove bijectively another case of this theorem for SSYT whose shapes are border strips.

Theorem 7.1. *Let λ/μ be a border strip and T be a SSYT of shape λ/μ . Then $HG(T) \in \mathcal{A}_D^*$ for some excited diagram D in $\mathcal{E}(\lambda/\mu)$.*

The first step is to show that the support of the resulting array $A = HG(T)$ is in \mathcal{A}_D for some excited diagram D in $\mathcal{E}(\lambda/\mu)$ corresponding to some lattice path γ from $(\lambda'_1, 1)$ to $(1, \lambda_1)$.

Lemma 7.2. *Let λ/μ be a border strip and T be a SSYT of shape λ/μ . Then $HG(T) \in \mathcal{A}_D^*$ for some excited diagram D in $\mathcal{E}(\lambda/\mu)$, and in particular the nonzero entries of the array are contained in a SW to NE lattice path.*

Proof. Since the shape of T is a border strip, for an integer k with $1 - \ell(\lambda) \leq k \leq \lambda_1 - 1$, by Theorem 2.26 (ii) we have that $dc_1(A_k) = 1$. Then the nonzero entries in each rectangle A_k form a NE lattice path for each k . Naturally, if two rectangles A_k corresponding to different k 's overlap, then paths in each should also coincide at the intersection of the two rectangles, and so for each k we get portions of one large NE lattice path. \square

We define a piece-wise linear map C from border strip SSYT of shape λ/μ to lattice paths in $[\lambda]$ with nonnegative integer entries as follows. Let T be a border strip SSYT of shape λ/μ , such that $T = T' \cup T_1 \cup T_2$, where $T_2 = [a_1, \dots, a_k]^\top$ is the last column of T , indexed j , and $T_1 = [b_k]$ is attached to T_2 horizontally on the left. Let $r = \max\{i \mid a_k - b_k > a_{i-1}\}$ where we assume $a_0 = 0$. Set $p_i := a_i - a_{i-1}$ for $i = 1, \dots, r-1$, where $a_0 = 0$ and set $p_r := a_k - b_k - a_{r-1}$.

Let $R := T' \cup [b_r, \dots, b_k]^\top$, i.e the border strip SSYT comprised of T' and the column attached on its right, where $b_i := a_i - (a_k - b_k)$ for $i = r, \dots, k$.

Then define $C(T) := C(R) \cup [p_1, \dots, p_r]^\top$ recursively as a path in $[\lambda]$ ending at $(1, j)$, where $C(R)$ is a path in $[\lambda]$ ending at $(r, j-1)$ and the entries at (i, j) for $i \geq r$ of $C(T)$ are equal to p_i . See Figure 16 for an example of $C(T)$.

Proposition 7.3. *Let λ/μ be a border strip and T be a SSYT of shape λ/μ . Then $HG(T)$ has support in a SW to NE lattice path, such that all up steps are strictly positive entries and the entries*

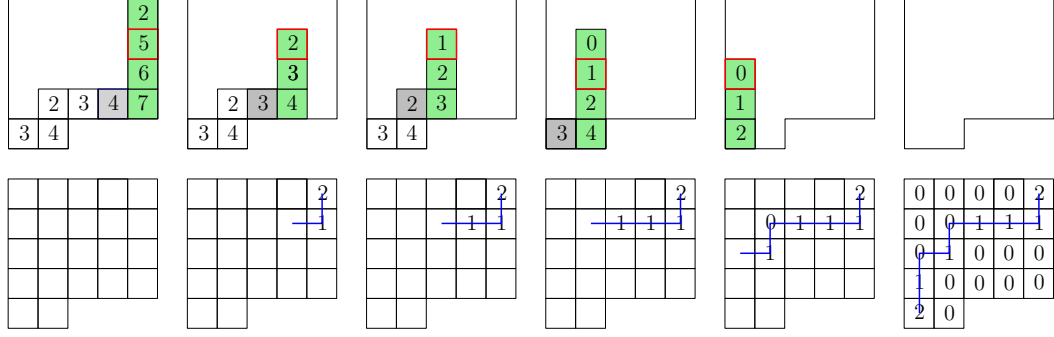

FIGURE 16. Illustration of the map $C(T)$ from border strip SSYT to lattice paths in $[\lambda/\mu]$ with nonnegative integer entries that coincides with $HG(T)$. The cells of T' are filled in green, the cell of T_1 is filled in gray, and the cell a_r has a red border.

are piece-wise linear functions of the entries of T . Moreover, $HG(T) = C(T)$ for $C(\cdot)$ as defined above.

Proof. By Lemma 7.2 the nonzero entries of $HG(T) = A$ form a SW to NE lattice path, so we need to show the shape and entries match $C(T)$. Let T be a border strip SSYT as above. Let also entry a_k be in the t -th diagonal of the shape. By Theorem 2.26 we have that $|A_t| = a_k$ and $|A_{t-1}| = b_k$ and $|A_{t+i}| = a_{k-i}$. Moreover, since each diagonal of T is a partition of one part, say $\nu = (\nu_1)$ at diagonal p , then $|A_p| = ac_1(A_p) = \nu_1$. Thus, since HG is a bijection, to show that $HG(T) = C(T)$, which both have supports on lattice paths, it is enough to show that the sum of entries in A_p and $C(T)_p$ coincide for all diagonals p . This is now straightforward to check by the explicit form of $C(T)$ and induction on the number of columns.

Finally, we note that in the last column of $C(T)$, the up steps of the lattice path have entries $p_i > 0$ because $a_i > a_{i-1}$. Also, R is a border strip SSYT since $b_i - b_{i-1} = a_i - a_{i-1} > 0$ with nonzero entries up to row $r + 1$, and by induction $C(R)$ is a lattice path ending in (r, j) with nonzero entries on the up steps.

Thus the sum of entries in the last column of A_t is equal to $a_k - b$. Similarly, the sum of entries in A_{t+i} is a_{k-i} . Since the support of A is a SW to NE lattice path, let the support in the last column extend to row r and then the path turns horizontally, i.e. going west. Let the entries along the path be $p_1, \dots, p_r, q_1, \dots$ so that the entries in the last column are p_1, \dots, p_r with $p_r > 0$. Then for $i < r$ we have $p_1 + \dots + p_i = |A_{t+k-i}| = a_i$, so $p_i = a_i - a_{i-1} > 0$. Next, the path takes a turn at $i = r$, so we have $p_1 + \dots + p_r = |A_t| - |A_{t-1}| = a_k - b$ and $p_r = a_k - b - a_{r-1} > 0$ by the choice of r . The remaining path is $HG(T')$, where T' is a border strip SSYT which coincides with T until the last two columns. Note that by the choice of r we have that $b = |A_{t-1}| \geq a_k - a_r$ since the nonzero entries in $A_t \setminus A_r$ are in A_{t-1} . Thus we have that $b \geq a_k - a_r > a_{k-1} - p_r > \dots > a_r - p_r$ which is again a border strip SSYT and by induction we recover the other entries of A . \square

8. ADDITIVITY OF HILLMAN-GRASSL FOR STRAIGHT SHAPES

In this section we show the following result.

Theorem 8.1. *Let T be in $RPP(\lambda)$ and let $T_{\min} = T_{\min}(\lambda)$ be the minimum SSYT of shape λ*

$$HG(T) + HG(T_{\min}) = HG(T + T_{\min}).$$

Before we proceed with the proof of this fact we will show a useful property of the ascending chains.

Proposition 8.2. *Let A be a rectangular array on $[a] \times [b]$ with nonnegative entries and $ac_t(A)$ be the maximal weight in the disjoint union of t ascending chains in A . Then there exists a collection*

of disjoint connected border-strip paths of boxes ρ_1, \dots, ρ_t in A , such that ρ_i starts at $(1, i)$ and ends at $(a, b - i + 1)$, and

$$\sum_i \sum_{p \in \rho_i} A_p = ac_t(A),$$

i.e. the total weight of entries in this collection is maximal.

This is saying that the maximal ascending chains can be made to start and end at the sides of the rectangle.

Proof. First, we observe that if there are two disjoint ascending chains they can be made non-crossing (i.e. one is above the other). To see this, form monotone piecewise linear paths τ^1, τ^2 from the centers of the squares of these chains, with starting and ending points P_1, Q_1 and P_2, Q_2 , respectively. Suppose that these paths cross at points X_1, X_2, \dots, X_k . We can then assign the piecewise linear paths $\tau' := \tau^1(P_1 \rightarrow X_1)\tau^2(X_1 \rightarrow X_2)\tau^1(X_2 \rightarrow X_3)\dots$ and $\tau'' := \tau^2(P_2 \rightarrow X_1)\tau^1(X_1 \rightarrow X_2)\dots$. These paths cover the same set of squares, and are monotonous (i.e. ascending), but now do not cross over.

We can now assume that the paths do not cross. We now proceed with a greedy algorithm to relabel the paths to satisfy the condition in the statement. Let D be the union of squares giving a maximal $ac_t(A)$. Since the weights in A are nonnegative, adding boxes to the paths in D will only increase the total weight. Thus, we can assume that D extends to the borders of A . Let ρ_1 be the bottom-most squares of D . If it does not reach the lowest row in A , we can add/reassign those boxes to ρ_1 , so it contains $(1, 1)$. Suppose that $(1, 1), (1, 2), \dots, (1, i) \in \rho_1$ for some i . As the other paths are above ρ_1 , we can extend one, say ρ_2 to contain $(1, i + 1)$. We then assign boxes $(1, 2), \dots, (1, i)$ from ρ_1 to ρ_2 , keeping it ascending and preserving the weight, and add $(1, 1), (2, 1), (2, 2), \dots, (2, i)$ to ρ_1 . If $t > 2$, we can then assign boxes $(1, 3), (1, 4), \dots$ to ρ_3 , assign $(1, 2), (2, 2), (2, 3), \dots$ from ρ_1 to ρ_2 and add $(3, 1), (3, 2), \dots$ to ρ_1 . Similarly, we can perform the same procedure on the other side of A by relabeling paths and possibly assigning extra boxes to them. This procedure, greedily pulling the paths SE from the border of D , by possibly adding boxes, will make and keep the paths connected. \square

Proof of Theorem 8.1. Let $A = HG(T)$, $M = HG(T_{min})$. The statement will follow directly from the RSK connection with HG (Theorem 2.26) if we show that for every k and t we have

$$ac_t(A_k + M_k) = ac_t(A_k) + ac_t(M_k).$$

We have that M_k consists of 1 below the main diagonal, and 0s above. For simplicity, we will identify M_k as the collection of boxes with values 1, i.e. its support.

We now apply Proposition 8.2 to $A_k + M_k$ and A_k . Assume that the rectangles are $[a] \times [b]$ (so $b - a = k$) and that $a \leq b$, otherwise we can reflect the application of the Proposition, so that the paths' endpoints be $(i, 1)$ and $(a - i + 1, b)$. Let D be the collection of t ascending chains of maximal weight for A_k , according to Proposition 8.2 we can choose them to start at $(1, i)$ and end at $(a, b - i + 1)$ and be continuous border strips. Let D' be the corresponding collection of t ascending chains of maximal weight for $A_k + M_k$ with the same properties. If ρ'_i is a continuous monotonous path from $(1, i)$ to $(a, b - i + 1)$ then $|\rho'_i \cap M_k| = b - i$ (the grid distance between $(1, i)$ and the main diagonal). Thus $\rho'_i(A_k + M_k) = \rho'_i(A_k) + b - i$ and so

$$ac_t(A_k + M_k) = D'(A_k) + (b - 1) + \dots + (b - t),$$

where $D'(A_k)$ is the total weight of the boxes D' on A_k . Thus, the above weight is maximal iff the total weight $D'(A_k)$ is maximal. Since D' is a collection of t disjoint ascending chains, then

$$\max_{D'} D'(A_k) = ac_t(A_k).$$

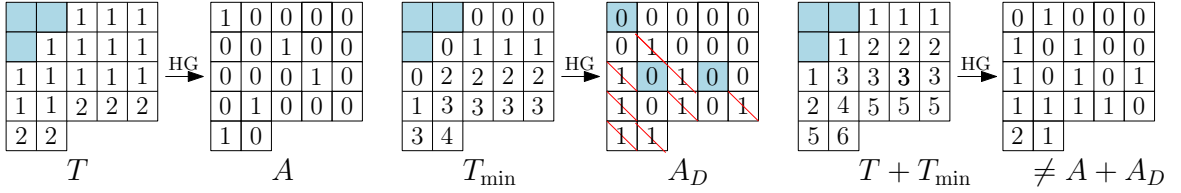

FIGURE 17. Counterexample for additivity of Hillman–Grassl for skew shapes.

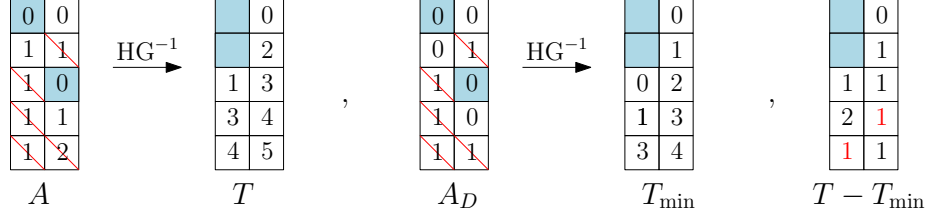

FIGURE 18. Counterexample for additivity of Hillman–Grassl for skew shapes.

Since $ac_t(M_k) = (b-1) + \dots + (b-t)$, we thus get that

$$ac_t(A_k + M_k) = ac_t(A_k) + ac_t(M_k)$$

for every t and k and the claim follows. \square

The following example shows that Theorem 8.1 does not hold for skew shapes.

Example 8.3. Let T be the skew SSYT of shape $\lambda/\mu = 55552/21$ in Figure 17 and $T_{\min} := \Phi(D)$ be the minimal SSYT corresponding to the excited diagram $D = \{(1,1), (3,2), (3,4)\}$. As illustrated in the figure, $HG(T) + HG(T_{\min}) \neq HG(T + T_{\min})$.

For straight shapes, given a SSYT T of shape λ and $T_{\min} = T_{\min}(\lambda)$, then $T - T_{\min}(\lambda)$ is a reverse plane partition. This does not hold for skew shapes as the next example shows.

Example 8.4. Let T be the skew RPP of shape $\lambda/\mu = 22222/11$ in Figure 18 that corresponds to the excited diagram $D = \{(1,1), (3,1)\}$. If $T_{\min} = \Phi(D)$ then $T - T_{\min}$ is not a reverse plane partition.

9. FINAL REMARKS

9.1. A bijective proof of Theorem 1.6. This article was in part motivated towards giving an entirely combinatorial proof of Theorem 1.6 from [16]. From Theorem 6.1 and Corollary 6.7, we understand combinatorially the leading terms of each summand on the right-hand-side of (1.4) in terms of the minimal SSYT of shape λ/μ . Also, in Section 7 we have a bijective proof for border strips λ/μ . It would be interesting to understand combinatorially other cases like shapes with Lascoux–Pragacz decomposition (θ_1, θ_2) or thick zig-zags δ_{n+k}/δ_n .

9.2. Comparison with the formula for skew tableaux involving Littlewood–Richardson coefficients. In Section 5 we compared the number of terms of the positive formulas (NHLF) and (OOF) for $f^{\lambda/\mu}$ and showed that $ED(\lambda/\mu) \leq OOT(\lambda/\mu)$. Another positive formula for $f^{\lambda/\mu}$ is given using the Littlewood–Richardson coefficients $c_{\mu,\nu}^{\lambda}$, namely

$$(9.1) \quad f^{\lambda/\mu} = \sum_{\nu \vdash |\lambda/\mu|} c_{\mu,\nu}^{\lambda} f^{\nu}.$$

The terms f^{ν} are readily computed by the classical hook-length formula (1.1). It is natural to compare this formula to (NHLF) and (OOF) and see which one is more “efficient”, in the sense of

number of summands. Since the $c_{\mu\nu}^\lambda$ do not have explicit product formulas we will regard them as multiplicities and thus the question is to compare

$$\text{ED}(\lambda/\mu), \text{OOT}(\lambda/\mu) \quad \text{vs} \quad \text{LR}(\lambda/\mu) := \sum_{\nu \vdash n} c_{\mu\nu}^\lambda.$$

From one of the rules to compute $c_{\mu\nu}^\lambda$ (see [28, Ch. 7, A1.3]), $\text{LR}(\lambda/\mu)$ counts the number of *Littlewood–Richardson tableaux*: which are SSYT T of skew shape λ/μ with positive entries whose *reverse reading word* (reading the entries of T row by row right-to-left and bottom-to-top) is a *lattice permutation*, i.e. in every initial factor of the word the number of i s is at least as many as the number of $(i+1)$ s, for each i . Denote the set of such tableaux by $\mathcal{LR}(\lambda/\mu)$. From this interpretation of $\text{LR}(\lambda/\mu) = |\mathcal{LR}(\lambda/\mu)|$ we obtain the following inequality.

Proposition 9.1. *For a skew shape λ/μ , we have that $\text{LR}(\lambda/\mu) \leq \text{OOT}(\lambda/\mu)$.*

Proof. We show that $\mathcal{LR}(\lambda/\mu) \subseteq \mathcal{SF}(\lambda/\mu)$ which implies the result since by Proposition 2.19, we have that $|\mathcal{SF}(\lambda/\mu)| = \text{OOT}(\lambda/\mu)$.

Given a tableau T in $\mathcal{LR}(\lambda/\mu)$, by the lattice condition of its reverse reading word w , the entries in the first row of T are all 1s. Iteratively, if the entries of T in row i are at most i , then the word w up until that point has entries at most i . Then the last entry of row $i+1$, which comes next in w is at most i by the lattice condition. Thus the entries of T in row $i+1$ are at most i and so $T \in \mathcal{SF}(\lambda/\mu)$, as desired. \square

Example 9.2. *A quick computation for $\lambda/\mu = 4321/21$ shows that $\text{ED}(\lambda/\mu) = 5$, $\text{LR}(\lambda/\mu) = 11$, and $\text{OOT}(\lambda/\mu) = 17$. On the other hand when $\lambda/\mu = 43/2$ we have $\text{ED}(\lambda/\mu) = \text{OOT}(\lambda/\mu) = 3$ and $\text{LR}(\lambda/\mu) = 2$. Also when $\lambda/\mu = 8642/21$ we have $\text{ED}(\lambda/\mu) = 8$ and $\text{LR}(\lambda/\mu) = \text{OOT}(\lambda/\mu) = 20$.*

From these examples, the question arises for which shapes λ/μ are:

$$\text{LR} \leq \text{ED} \leq \text{OOT}, \quad \text{or} \quad \text{ED} \leq \text{LR} \leq \text{OOT}?$$

In the first example above we see that the minimal SSYT tableaux are actually Littlewood–Richardson tableaux. This also raises the question of which shapes λ/μ give equalities $\text{ED}(\lambda/\mu) = \text{LR}(\lambda/\mu)$ and $\text{LR}(\lambda/\mu) = \text{OOT}(\lambda/\mu)$, respectively?

9.3. Multivariate identity from the Hillman–Grassl bijection. In [21, Thm. 1.2], Naurse–Okada gave a multivariate identity for skew RPP. Because the Hillman–Grassl bijection is behind the q -analogue (1.4), we can derive an analogous multivariate identity of skew SSYT. We need some notation. The variables are $\mathbf{z} = (z_i)_{i \in I}$, where $I \subset \mathbb{Z}$ is the set of contents of λ , that is the set of integers $\{1 - \ell(\lambda), \dots, \lambda_1 - 1\}$. For $\pi \in \text{RPP}(\lambda/\mu)$, we let

$$\mathbf{z}^\pi := \prod_{u \in [\lambda/\mu]} z_{c(u)}^{\pi(u)}, \quad \mathbf{z}[H_\lambda(u)] := \prod_{v \in H_\lambda(u)} z_{c(v)},$$

where $H_\lambda(u)$ are the cells of $[\lambda/\mu]$ in the hook of cell $u \in [\lambda/\mu]$. Combining Theorem 2.28 and Proposition 2.25 gives the following identity.

Theorem 9.3. *Let λ/μ be a skew shape. We have the following multivariate identity:*

$$\sum_{T \in \text{SSYT}(\lambda/\mu)} \mathbf{z}^T = \sum_{D \in \mathcal{E}(\lambda/\mu)} \frac{\prod_{u \in \text{Br}(D)} \mathbf{z}[H_\lambda(u)]}{\prod_{u \in D} (1 - \mathbf{z}[H_\lambda(u)])}.$$

We end with a multivariate analogue of Corollary 6.7 obtained by combining Theorem 6.1 and Proposition 2.25.

Corollary 9.4. *Let λ/μ be a skew shape. We have the following multivariate identity:*

$$\sum_{T \in \text{SSYT}_{\min}(\lambda/\mu)} \mathbf{z}^T = \sum_{D \in \mathcal{E}(\lambda/\mu)} \prod_{u \in \text{Br}(D)} \mathbf{z}[H_\lambda(u)].$$

Acknowledgements: We thank Igor Pak for having introduced the first two named authors with Naruse’s formula and for the ensuing collaboration studying this formula. We also thank Peter Cassels, Angèle Foley, Swee Hong Chan, Soichi Okada, and Daniel Zhu for helpful conversations. This work was facilitated by computer experiments using Sage [27], its algebraic combinatorics features developed by the Sage-Combinat community [26],

REFERENCES

- [1] Swee Hong Chan, Igor Pak, and Greta Panova. Sorting probability for large Young diagrams. *Discrete Anal.*, pages Paper No. 24, 57, 2021.
- [2] James S. Frame, Gilbert de B. Robinson, and Robert M. Thrall. The hook graphs of the symmetric group. *Can. J. Math.*, 6(0):316–324, 1954.
- [3] Emden R. Gansner. The Hillman-Grassl correspondence and the enumeration of reverse plane partitions. *J. Combin. Theory Ser. A*, 30(1):71–89, 1981.
- [4] Alexander Garver, Rebecca Patrias, and Hugh Thomas. Minuscule reverse plane partitions via quiver representations. *arXiv preprint arXiv:1812.08345*, 2018.
- [5] James Haglund. *The q,t -Catalan numbers and the space of diagonal harmonics*, volume 41 of *University Lecture Series*. American Mathematical Society, Providence, RI, 2008. With an appendix on the combinatorics of Macdonald polynomials.
- [6] Abraham P. Hillman and Richard M. Grassl. Reverse plane partitions and tableau hook numbers. *J. Combinatorial Theory Ser. A*, 21(2):216–221, 1976.
- [7] Takeshi Ikeda and Hiroshi Naruse. Excited Young diagrams and equivariant Schubert calculus. *Trans. Amer. Math. Soc.*, 361(10):5193–5221, 2009.
- [8] Pakawut Jiradilok and Thomas McConville. Roots of descent polynomials and an algebraic inequality on hook lengths. *arXiv preprint arXiv:1910.14631*, 2019.
- [9] Jang Soo Kim and Meesue Yoo. Generalized Schur function determinants using the Bazin identity. *SIAM Journal on Discrete Mathematics*, 35(3):1650–1672, 2021.
- [10] Allen Knutson, Ezra Miller, and Alex Yong. Gröbner geometry of vertex decompositions and of flagged tableaux. *J. Reine Angew. Math.*, 630:1–31, 2009.
- [11] Matjaž Konvalinka. A bijective proof of the hook-length formula for skew shapes. *European J. Combin.*, 88, 2020.
- [12] Matjaž Konvalinka. Hook, line and sinker: A bijective proof of the skew shifted hook-length formula. *European J. Combin.*, 86, 2020.
- [13] Victor Kreiman. Schubert classes in the equivariant k -theory and equivariant cohomology of the grassmannian, 2006.
- [14] Alain Lascoux and Piotr Pragacz. Ribbon Schur functions. *European J. Combin.*, 9(6):561–574, 1988.
- [15] Alejandro H. Morales, Igor Pak, and Greta Panova. Hook formulas for skew shapes II. Combinatorial proofs and enumerative applications. *SIAM J. Discrete Math.*, 31(3):1953–1989, 2017.
- [16] Alejandro H. Morales, Igor Pak, and Greta Panova. Hook formulas for skew shapes I. q -analogues and bijections. *J. Combin. Theory Ser. A*, 154:350–405, 2018.
- [17] Alejandro H. Morales, Igor Pak, and Greta Panova. Hook formulas for skew shapes III. Multivariate and product formulas. *Algebr. Comb.*, 2(5):815–861, 2019.
- [18] Alejandro H. Morales, Igor Pak, and Greta Panova. Hook formulas for skew shapes IV. Increasing tableaux and factorial Grothendieck polynomials. *Zap. Nauchn. Sem. S.-Peterburg. Otdel. Mat. Inst. Steklov. (POMI)*, 507(Teoriya Predstavlenii, Dinamicheski Sistemy, Kombinatornye Methody. XXXIII):59–98, 2021.
- [19] Alejandro H. Morales and Daniel Zhu. On the Okounkov-Olshanski formula for standard tableaux of skew shapes. *Sém. Lothar. Combin.*, 84B:Art. 93, 12, 2020.
- [20] Hiroshi Naruse. Schubert calculus and hook formula. <http://www.emis.de/journals/SLC/wpapers/s73vortrag/naruse.pdf>, 2014.
- [21] Hiroshi Naruse and Soichi Okada. Skew hook formula for d -complete posets via equivariant k -theory. *Algebraic Combinatorics*, 2(4):541–571, 2019.
- [22] Andrei Okounkov and Grigori Olshanski. Shifted Schur functions. *St. Petersburg Math. J.*, 9(2):239–300, 1998.
- [23] Igor Pak. Skew shape asymptotics, a case-based introduction. *Séminaire Lotharingien de Combinatoire*, 84(B84a), 2021.
- [24] GaYee Park. Naruse hook formula for linear extensions of mobile posets. *Electron. J. Combin.*, 29(3):Paper No. 3.57, 26, 2022.
- [25] Arun Ram. Skew shape representations are irreducible. In *Combinatorial and geometric representation theory (Seoul, 2001)*, volume 325 of *Contemp. Math.*, pages 161–189. Amer. Math. Soc., Providence, RI, 2003.

- [26] The Sage-Combinat community. Sage-Combinat: enhancing Sage as a toolbox for computer exploration in algebraic combinatorics.
- [27] The Sage Developers. *SageMath, the Sage Mathematics Software System (Version 10.1)*.
- [28] Richard P. Stanley. *Enumerative combinatorics. Vol. 2*, volume 62 of *Cambridge Studies in Advanced Mathematics*. Cambridge University Press, Cambridge, 1999.
- [29] Richard P. Stanley. *Enumerative combinatorics. Vol. 1*. Cambridge Studies in Advanced Mathematics. Cambridge University Press, Cambridge, 2 edition, 2012.

(A. H. Morales) LACIM, DÉPARTEMENT DE MATHÉMATIQUES, UNIVERSITÉ DU QUÉBEC À MONTRÉAL, CANADA

DEPARTMENT OF MATHEMATICS AND STATISTICS, UMASS AMHERST, AMHERST, U.S.A.

Email address: `morales_borrero.alejandro@uqam.ca`

URL: <https://ahmorales.combinatoria.co>

(G. Panova) DEPARTMENT OF MATHEMATICS, UNIVERSITY OF SOUTHERN CALIFORNIA, LOS ANGELES, U.S.A.

Email address: `gpanova@usc.edu`

URL: <https://sites.google.com/usc.edu/gpanova/home>

(G. Park) LACIM, UNIVERSITÉ DU QUÉBEC À MONTRÉAL, CANADA

Email address: `park.ga_yee@uqam.ca`

URL: <https://sites.google.com/view/gayeeepark/home>

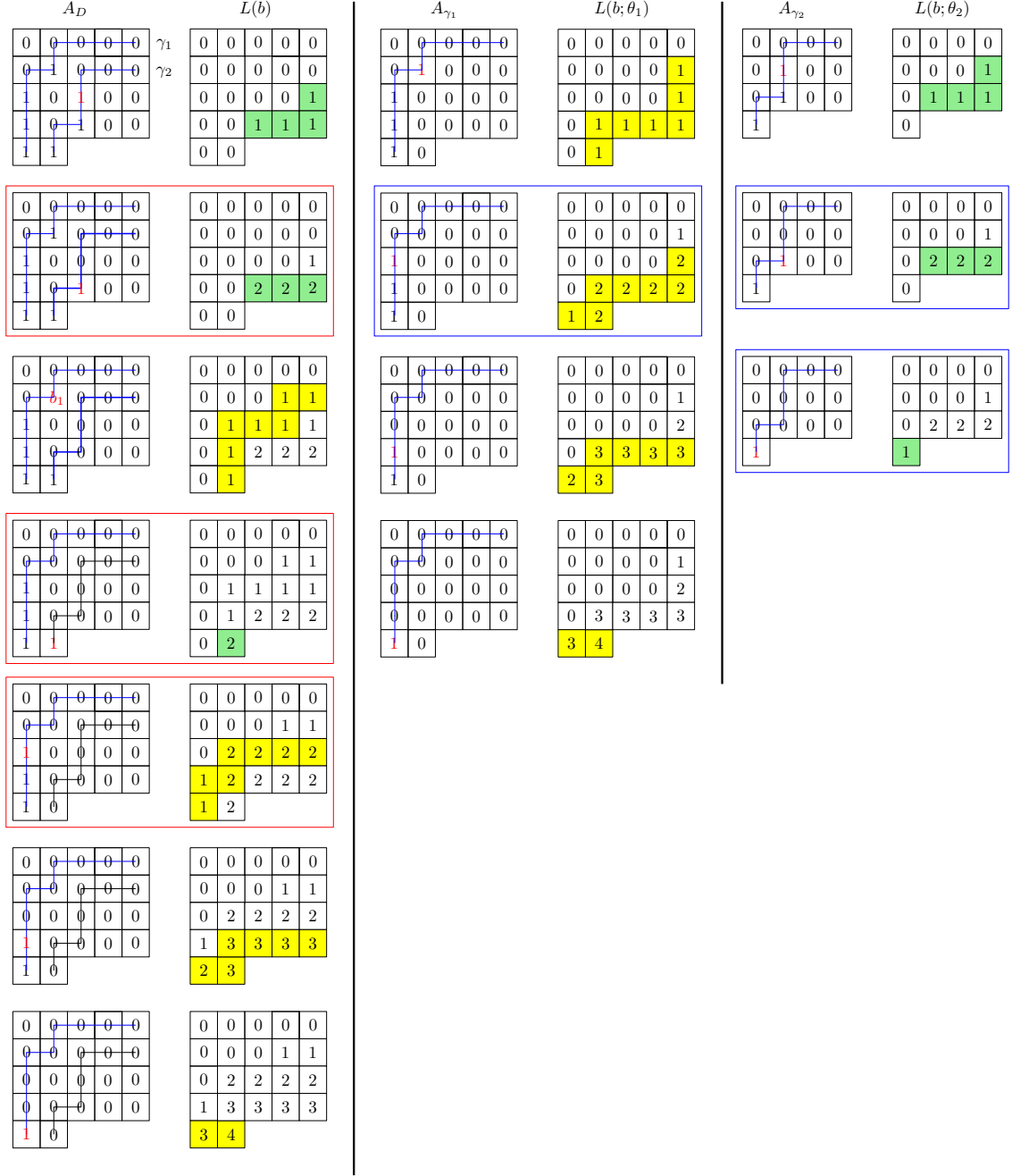

FIGURE 19. The first two columns show the inverse Hillman-Grassl paths $L(b)$ on A_D for a diagram D with Kreiman decomposition (γ_1, γ_2) . The next columns show the paths $L(b; \theta_1)$ on A_{γ_1} and the paths $L(b; \theta_2)$ on A_{γ_2} respectively. By Corollary 6.13, the multiset $\bigcup_{b \in \text{Br}(D)} L(b)$ equals the union of the multisets $\bigcup_{b \in \text{Br}(\gamma_i)} L(b; \theta_i)$ for $i = 1, 2$.