

Agree to Disagree: Measuring Hidden Dissents in FOMC Meetings*

Kwok Ping Tsang¹ and Zichao Yang²

¹Department of Economics, Virginia Tech

²Wenlan School of Business, ZUEL

March 7, 2024

Abstract

Based on a record of dissents on FOMC votes and transcripts of the meetings from 1976 to 2017, we develop a deep learning model based on self-attention mechanism to create a measure of disagreement for members in each meeting. While dissents are rare, we find that members often have reservations with the policy decision, and the level of disagreement is mostly driven by current or predicted macroeconomic data. Using our model to evaluate speeches made by members between meetings, we find that the informational content of speeches is low if we can only compare them to speeches made by the chair. Disagreement strongly correlates with data from the Summary of Economic Projections and a measure of monetary policy sub-optimality, suggesting that disagreement is driven by both members' different preferences and their different views about the future.

JEL Codes: E52, E58, C55.

Keywords: Natural language processing, disagreement, monetary policy, FOMC.

*Tsang: Department of Economics, Virginia Tech, Pamplin Hall, Blacksburg, VA 24061; E-mail: byront@vt.edu. Yang: Wenlan School of Business, Zhongnan University of Economics and Law, Wuhan, China; E-mail: yang_zichao@outlook.com. We would like to thank seminar participants at ZUEL and HUST. We also thank Dick Startz, Xiaojin Sun, Ming Yi, and Cloud Yip for helpful comments.

1 Introduction

Statements, minutes, speeches, and other texts released by the Federal Reserve have been thoroughly scrutinized by economists and practitioners, using techniques from simple word clouds to state-of-the-art machine learning tools. The transcripts of Federal Open Market Committee (FOMC) meetings, which are word-by-word records of who said what, are relatively less studied. While it is partly due to the 5-year lag of release, we think it is more because of the challenging task of analyzing the large amount of texts produced by over one hundred past members of the FOMC.

This paper begins with a method of evaluating each member’s position in a meeting, and the key is to use dissents (i.e., NO votes) to identify word choices and tones that suggest strong disagreement with the policy action. The total percentage of dissents from 1976 to 2017 is 6.37%. In [Figure 1](#), we show the annual counts of YES and NO votes cast in FOMC meetings, and we can see that the number of dissents change little over time.

While dissents do not occur often, they are enough for us to train a language model. Based on a member’s words in a meeting, our language model can accurately predict if that member voted to dissent the decision.

With the model, we can evaluate texts from members who did not vote NO and yet might have reservations regarding the direction of monetary policy. We will show that [Figure 1](#) gives a wrong impression of a consensus among most FOMC members most of the time, and that the level of disagreement varies with the economy more consistently than the voting outcome.

Let’s look at two examples that can illustrate our main idea. In the FOMC meeting on May 19, 1998, President Minehan of the Federal Reserve Bank of Boston raised concerns about inflation and proposed a less accommodative policy, and she said:

“Mr. Chairman, at our last meeting I expressed concern that, even in the absence of clear indications that inflation was rising, both the strength of the domestic economy and the frothiness in financial markets required some policy tightening to reduce the risk that even more tightening might be needed later...”

Other members, like Presidents Jordan, Poole and Broaddus shared Minehan’s concerns. Even though Broaddus was not invited to vote in that meeting, he commented that:

“Mr. Chairman, if it were my choice, I would still prefer to make a small move today for many of the reasons that Cathy Minehan and Bill Poole have adduced here...So, to paraphrase Governor Kelley, I would say that if we sit still, I hope we will at least sit uptight. [Laughter]”

Eventually the Committee seeks to maintain the federal funds rate unchanged at an average of around 5-1/2 percent, and President Minehan, despite her concerns, voted YES.

Another example comes from the FOMC meeting on April 24, 2012. Governor Raskin voted for the final decision (no action), but the governor also raised concerns:

“Thank you, Mr. Chairman. I, too, support alternative B, but not without a vague sense that the actions taken today, i.e., no action, could be eventually interpreted by markets as being contractionary, an interpretation that could eventually effectively make them contractionary...Analogously, if our statement today sends a signal that we are content with the current path of the economy, this could work like contractionary policy—the last thing we need right now in my view. I hope that is not the message the public takes from our meeting today.”

The two examples suggest that some FOMC members might have voiced their disagreement with the policy decisions, but their hidden dissents were not reflected in the voting records¹.

For each FOMC member in each meeting, we calculate a measure of disagreement based on our model. The measure is bounded between 0 and 1. If the measure is close to 0, it means the member is mostly on board with the policy action. If the measure is close to 1, it means the member is mostly against the policy action. For each meeting, we can also calculate the average level of disagreement.

To confirm that our measure of disagreement makes sense, we regress it on two sets of

¹To avoid confusion, we use the words “disagreement” and “dissent” differently. Dissents mean the NO votes recorded during FOMC meetings, and the level of disagreement (or hidden dissents) is constructed using the scores predicted by our deep learning model based on the FOMC transcripts.

explanatory variables, both at the individual and meeting levels. First, we have the current or projected targets under the dual mandate (inflation and unemployment rates) at or right before the meeting. Second, we have a list of characteristics of the FOMC members which includes age, gender, and education. Our disagreement measure is strongly correlated with the economy, and disagreement increases whenever inflation goes up or unemployment goes down. The correlation suggests that members have more reservations when there seems to be a need for “cooling down” the economy, and members are more in unison when the economy is in a downturn. Among the personal characteristics, we find that only education background has a consistent explanatory power.

Next, we use the deep learning model to evaluate speeches made by FOMC members, focusing on whether speeches contain information about the disagreement revealed in the following meeting. We find that the predictive power of speeches depends on the reference point. If we have access to what the chair said in the following meeting (which is possible after a 5-year time lag), speeches can predict the disagreement within meetings. But if we are only to compare members’ speeches with those made by the chair, the predictive power mostly disappears.

Finally, we provide some evidence that disagreement among members is driven by both their different policy preferences and their different economic projections. First, using data from the Summary of Economic Projections (SEP), we show that disagreement on the path of monetary policy and projections for the macroeconomic variables have roughly the same explanatory power. We also provide some evidence that disagreement on monetary policy contains information beyond the disagreement on the economy outlook, and that information is correlated with our measure. Second, the disagreement measure is strongly correlated with the optimal policy perturbation (OPP) proposed by [Barnichon and Mesters \(2023\)](#). Since OPP can be driven by different loss functions or different impulse responses, we again conclude that both forms of heterogeneity are important.

1.1 Related papers

Central bank communication is a rich and diverse research field and myriad important studies have been conducted to explore various aspects of central bank communication (Born et al., 2014; Hansen and McMahon, 2016; Tobback et al., 2017; Hansen et al., 2019; Husted et al., 2020; Lunsford, 2020; Leombroni et al., 2021; Malmendier et al., 2021). Among all the central banks, the Federal Reserve has received the most thorough examination due to its detailed and extensive communication records. Researchers use various materials, such as statements, minutes, speeches, news articles, press conferences, testimonies, or even facial expressions to study Federal Reserve communication (Handlan, 2020; Arismendi-Zambrano et al., 2021; Shapiro et al., 2022; Gorodnichenko et al., 2023; Alexopoulos et al., 2023; Curti and Kazinnik, 2023). In recent years, there has been a growing focus on less-explored FOMC meeting transcripts. The pioneering work that utilizes FOMC transcripts, to our best knowledge, can be attributed to Romer and Romer (2008), who manually examined transcripts from three FOMC meetings to demonstrate the link between forecast differences and monetary policy actions. However, till the end of 2017, all the FOMC transcripts contain over three million words, which makes it not a trivial task for humans to manually analyze all of them. Thanks to advancements in natural language processing (NLP) techniques, researchers can now employ more sophisticated methods to analyze a large volume of textual data (Jurafsky and Martin, 2023). Applying the LDA model on FOMC transcripts, Hansen et al. (2018) study how FOMC’s transparency policy affects FOMC members’ deliberations. Cieslak et al. (2021) and Shapiro and Wilson (2022) use Bag of Words model to analyze the text of FOMC transcripts and measure FOMC members’ sentiment. Shah et al. (2023) train a BERT-based model on FOMC speeches, meeting minutes, and press conference transcripts to gauge monetary policy stance.

In this study, we build a customized deep learning model that capitalizes on transfer learning and self-attention mechanism to re-examine these transcripts and uncover the nuanced shifts in the degree of disagreement expressed within the text. Furthermore, this

disagreement measure is used to build the level of disagreement within each FOMC meeting, and we investigate how it relates to the economic conditions, the personal characteristics of the members, the sentiment revealed in public speeches, and the factors behind the observed disagreement.

Our research mainly contributes to the strand of literature that delves into characterizing the policy preferences of the FOMC members using various sources of communication, such as speeches, minutes, and statements. For instance, [Kahn and Oksol \(2018\)](#) examine the Compilation and Summary of Individual Economic Projections to study how hawks and doves in FOMC differ in their views of appropriate monetary policy. [Apel et al. \(2022\)](#) utilize FOMC meeting minutes files to characterize the "hawkishness" of the participants and find that this indicator can effectively improve the forecasting ability of future monetary policy. [Bertsch et al. \(2022\)](#) apply a BERT-based model to Federal Reserve speeches and discusses how non-dual mandate related concerns helped shape monetary policy. Using the hawk-dove measure developed by [Istrefi \(2019\)](#), [Bordo and Istrefi \(2023\)](#) study how FOMC members' personal characteristics and experience can influence their policy preferences.

This paper contributes to this strand of literature by using the FOMC meeting transcripts, which provide a more detailed and candid record of the members' views and arguments. We differ from previous studies by constructing a measure of disagreement at the meeting level rather than at the individual level. Our approach avoids determinedly labeling members as hawk or dove, and allows their policy preferences to vary over time. Furthermore, we find that the level of disagreement inside a FOMC meeting is more related to the current economy status and much less to the personal characteristics of the members.

Speeches of FOMC members have been studied more extensively than transcripts. [Istrefi et al. \(2023\)](#) demonstrate that the length and tone of speeches on topics related to financial stability are usually correlate with a more accommodating monetary policy stance, and this effect is mainly driven by Federal Reserve Bank presidents. [Swanson \(2023\)](#) finds that speeches and Congressional testimony by the Fed chair have been more important than

FOMC announcements for financial markets. [Bertsch et al. \(2022\)](#) use these speeches to examine how Fed’s interpretation of the dual mandate might affect its policy decisions and financial markets. We differ from the literature in the way we interpret speeches: we first use the richer and more detailed transcripts to train a deep learning model, and then we use it to measure the informational content in speeches.

This paper is structured as follows. We lay out the different data sources and variables used in the rest of the paper in [section 2](#) . In [section 3](#), we build the customized deep learning model and generate the disagreement score. In [section 4](#) we discuss our empirical strategies and extract the economic meaning of the disagreement score. And [section 5](#) concludes.

2 Data

The data used in this study belong to four categories: personal characteristics of FOMC members, transcripts and voting outcomes, speeches, and macroeconomic variables.

2.1 Personal characteristics

Personal characteristics for each FOMC member come from multiple sources, including the [Federal Reserve History](#) website, members’ Wikipedia entries and related news articles. The list of variables we collect is shown in [Table 1](#).

When categorizing the hometown region of each FOMC member, we follow the practice established by the [Bureau of Labor Statistics](#) and divide the U.S. into four regions: Northeast (NE), Midwest (MW), South and West. We base the hometown classification on the location where a member was raised rather than their birthplace and we use “OTH” to represent hometowns outside of the U.S. Similarly, the school regions where members attained their highest degree are classified in the same fashion.

To measure the political ideology of FOMC members, we employ two different methods due to the different appointment procedures for governors and presidents. Members of the

Board of Governors are appointed by the President of the United States (POTUS) and confirmed by the U.S. Senate. However, the POTUS and Senate are not directly involved in picking presidents of the twelve regional Federal Reserve Banks. Based on the information on the [Board of Governors of the Federal Reserve](#) website, presidents are chosen by their own boards of directors and confirmed by the Board of Governors. Accordingly, we record the party of the then incumbent POTUS at the time of each governor's appointment. Next, for the presidents, we use the party that won the most recent presidential election in the state where the respective regional Federal Reserve Bank is located. For example, President Jeffrey M. Lacker assumed the role of president at the Federal Reserve Bank of Richmond in 2004, so we use the presidential election result in Virginia in 2004; President Dennis P. Lockhart was appointed as the president of the Federal Reserve Bank of Atlanta in 2007, we use the presidential election result in Georgia in 2008 rather than 2004. The state level presidential election data after 1976 is downloaded from [MIT Election Data and Science Lab](#), and earlier data is downloaded from the [Election Statistics](#) published by the U.S. House of Representatives.

We also collect the significant events experienced by FOMC members in their early ages. Following [Bordo and Istrefi \(2023\)](#), we collect information related to three major events: the Great Depression (1929-1939), World War II (1939-1945), and the Great Inflation (1965-1982). If a FOMC member experienced one of these events before turning 21, we count the corresponding variable as one.² Eventually, we collect the personal information of 97 members who cast votes in FOMC meetings from 1976 to 2017, a selective description of the personal characteristics information can be found in [Table 2](#).

²We choose to not include World War I (1914-1918) because only nine FOMC members experienced WWI in our sample, and this number is significantly smaller than that in other events. We also look at the active periods of these nine members and find that they only served on the FOMC from 1976 to 1986. In contrast, members who experienced the Great Depression can be found from 1976 to 2008, members who experienced the Great Inflation can be found from 1982 to 2017, and members who experienced WWII were on the FOMC throughout the entire data sample. Furthermore, given that some macroeconomic data used in our later study is only available after 1986, we choose to focus on the listed three events.

2.2 Transcripts and voting outcomes

How FOMC communicates its monetary policies changes over time, and [Todd \(2016\)](#) gives a detailed discussion on this topic. Before 1993, most FOMC members believed that their deliberations during FOMC meetings were recorded, but these tapes were solely used to compile the minutes of FOMC meetings. These tapes were expected to be reused in the next meeting, effectively erasing the records of the previous meeting. FOMC members did not notice that all the tapes were transformed into transcripts first so that staff could write up minutes based on these transcripts. During the April 20, 1976 meeting, Chair Burns advocated for replacing the Memorandum of Discussion (MOD) with a more detailed Record. However, Chair Burns remained uncertain whether it was the absolute end of MODs and told Fed staff to change the procedure with these transcripts. Consequently, rather than discarding the transcripts, they were retained in case staff might have to write MODs again for past meetings. From then on, the practice of retaining all FOMC meeting transcripts commenced, known to only a selected few. On October 5, 1993, during a FOMC conference call, Chair Greenspan unveiled the existence of these historical transcripts. Later, on February 1, 1995, FOMC officially started to release both past and future transcripts, with a five-year delay.

FOMC voting records and the corresponding meeting transcripts are accessible through the [Board of Governors of the Federal Reserve](#) website. We download the available transcripts spanning from March 29, 1976 to the end of 2017, remove all the content from Fed staff, and only keep the transcripts related to the members who cast votes at the end of meetings. These transcripts are then disassembled and re-clustered at the meeting-person level. For example, suppose ten FOMC members attended a FOMC meeting, combining the transcript with the members' voting records resulted in the creation of ten labeled observations. And, to reduce the data processing time, we also remove irrelevant sentences like “Thank you, Chair”, “Thank you, President”, “Good morning...” etc. To remove them, we follow the method in [Shapiro and Wilson \(2022\)](#) and use the Oxford Dictionary of Economics and the Oxford Dictionary of Finance and Banking to filter out sentences that do not contain any

economics-related terms.

At the end, we process data from 362 FOMC meetings and generate 3,950 observations.³ The distributions of meeting and observation counts per year are shown in [Figure 2](#).

The voting records we have extracted are cross-checked with the FOMC Dissents data maintained by [Thornton and Wheelock \(2014\)](#) to ensure accuracy. By pairing individual-level transcripts with their respective voting records, a set of 3,950 labeled data points was assembled for the training of our NLP model.

2.3 Speeches

Most recent governors' public speeches can be found on the [Board of Governors of the Federal Reserve](#) website, and recent presidents' public speeches can be found on the respective regional Federal Reserve Bank website. However, the time coverage varies across different regional Federal Reserve Banks, with many listing speeches from only the two most recent presidents. To access earlier public speeches, we turn to the [FRASER](#) database maintained by the Federal Reserve Bank of St. Louis.⁴

In total, we have collected 5,859 speeches from 1970 to 2022. After plotting out the number of speeches per year and the number of labeled transcript data points per year (see [Figure 3](#)), we notice that prior to 1987, fewer than 50 speeches are successfully retrieved per year. We also find out that the number of public speeches delivered by FOMC members is increasing over time, while the number of labeled transcript observations is relatively stable.

2.4 Macroeconomic variables

Macroeconomic data mainly comes from the [Tealbook](#) (formerly Greenbook) data set maintained by the Federal Reserve Bank of Philadelphia. Tealbook is prepared by the Board

³We include conference calls as long as they contain voting records. If not, we discard the corresponding transcripts.

⁴In theory, we can download all the public speeches from the FRASER data base. However, Federal Reserve Banks usually provide the HTML version of their presidents' latest speeches which have higher accuracy than the data from the FRASER data base which was converted from pdf files using OCR.

of Governors’ staff in preparation for each regularly scheduled FOMC meeting. Tealbook contains in-depth analysis of the U.S. and international economy. Additionally, staff at the Board of Governors also prepare projections for the U.S. economy using an assumption about monetary policy. We use the unemployment and core CPI data from the Tealbook to measure the dual mandate, and the core CPI data only became available after the FOMC meeting on February 12, 1986.

2.5 Transformation of meeting-level variables

Combining the macroeconomic variables with personal characteristics, we create a list of variables at the FOMC meeting level, and they are summarized in [Table 3](#).

The experience of a member is calculated based on start and end dates of the term.⁵ A member’s age at a certain FOMC meeting is calculated based on the birth date and the corresponding meeting date. To measure the diversity in a meeting, we employ the concept of Shannon entropy and calculate:

$$H = - \sum_{i=1}^n p_i \log_b p_i$$

where n is the number of elements in the system, p_i is the frequency of element i , and b is the base of the logarithm.

In the case of quantifying the diversity of hometowns among meeting participants, we count the numbers of members whose hometown locates in the northeast (NE) region, the midwest (MW) region, the south region, the west region, and outside of the U.S. (OTH). It is then fed into the aforementioned entropy function with a base of five to standardize the entropy value. Shannon entropy reaches its maximum value when all elements have equal probability, implying that greater diversity in hometown distribution corresponds to a higher

⁵For members like Governor Janet Yellen who served as the president of the Federal Reserve Bank of San Francisco first (2004-2010), then joined the Federal Reserve Board (2010-2018), we count her term started in 2004 as the president.

entropy value. Consequently, value 0 indicates minimal diversity of hometowns, while a value of 1 signifies the highest level of diversity on hometowns. The same approach is applied to calculate the school diversity.

For the macroeconomic variables, unemployment and inflation, we use corresponding five data points: *Variable_B2*, *Variable_B1*, *Variable_F0*, *Variable_F1* and *Variable_F2* from the Tealbook to calculate both trend and standard deviation for these two variables. The trend value is determined by the slope obtained from a first-degree polynomial regression applied to the five data points. And the standard deviation is also calculated based on these five data points, which measures the uncertainty faced by FOMC members.

3 Natural Language Processing

With the continued evolution of deep learning, a multitude of NLP tasks are seeing improving outcomes (Kamath et al., 2019; Lauriola et al., 2022). In this section, we present the architecture of our customized deep learning model, which is built on the self-attention module. We implement the model on FOMC transcripts and members’ speeches. For background information on the application of deep learning models in NLP, please refer to [Appendix B](#).

3.1 A customized deep learning model

We use the Sentence-BERT (SBERT) model developed by Reimers and Gurevych (2019) to do sentence embedding. Diverging from the conventional word embedding, SBERT adds a pooling operation to the output of the original BERT model to produce a sentence embedding, and it can significantly reduce computational overhead. Theoretically, the “sentence” fed into the SBERT model can be a real sentence, a paragraph, or even a full article. In this paper, we apply the SBERT at the sentence level for two reasons: (1) we want to strike a balance between manageable computational overhead and maximal information retention; (2) given transcripts are aggregated at the individual level, neighboring sentences within one person’s

transcript may arise from disparate conversations during the meeting, potentially lacking strong semantic cohesion. After obtaining the sentence embedding for the transcript via SBERT, we feed these embeddings into our customized deep learning model. ⁶

Drawing inspiration from the versatility of the self-attention mechanism, this study introduces a novel deep learning approach that merges the capabilities of the multi-head self-attention (MHSA) module with multi-layer perceptron (MLP) layers to forecast the voting scores of members in FOMC meetings. Historical analysis of FOMC meetings reveals a consistent pattern where chairs vote affirmatively. Leveraging this insight, our training methodology employs the chair’s transcript as a reference point, focusing on the difference between the transcripts of members and their chair to predict members’ voting outcomes. Initially, sentence embeddings from both the chair’s and the member’s transcripts are processed through separate dense layers to highlight crucial attributes. This is followed by the application of a normalization layer to enhance model efficiency and a dropout layer to counteract overfitting. The incorporation of MHSA modules further optimizes the feature extraction phase, while the addition of a residual layer aims to bolster model performance and counter potential degradation issues. The model ultimately predicts the voting outcomes, categorized as YES (0) or NO (1), by feeding the output differences derived from the chair’s and member’s MHSA modules into a classification layer. The architecture of the complete model is depicted in [Figure 4](#).

The next step is to conduct hyperparameter fine-tuning to identify the most effective configuration for our model. The selected hyperparameters for adjustment include: (1) the count of MHSA modules within the sections dedicated to the chair’s and member’s transcripts, (2) the number of attention heads within each MHSA module in both sections, (3) the dropout rate and (4) the initial learning rate. The fine-tuning process utilizes the

⁶For each transcript associated with an FOMC member in every meeting, SBERT produces an embedding tensor of shape (number of sentences, 768), where 768 represents the embedding dimension. To ensure consistency in tensor size across the dataset, we apply padding to each embedding tensor to achieve a standardized size of (256, 768). We deliberately selected the size of 256 for the standardized tensor to optimize information density inside the tensor, ensuring it is comprehensive yet not excessively sparse. These standardized embeddings are subsequently fed into our customized deep learning model.

optuna package, with the specific search domain for each hyperparameter described in Table 4. Additionally, to further enhance the model performance and expedite convergence, a learning rate scheduler is incorporated into the model training process. We employ a step-based decay strategy, reducing the initial learning rate after every ten training steps.⁷ Furthermore, to mitigate overfitting and reduce computation time, an early stopping mechanism is activated, using the loss value on the test set as the criterion for termination.

Finally, the model with the best performance is configured with the following hyperparameters: three MHSA modules for both chair and member section, each comprising eight heads; a dropout rate of 0.735; and an initial learning rate of $4e^{-5}$. This configuration achieves an 86.72% accuracy rate on the training set (80% of the total observations) and a 82.94% accuracy rate on the test set (20% of the total observations).

In this binary classification models (see Figure 4), a round function is employed right after the sigmoid function to convert the probability range $([0, 1])$ into a binary outcome (0 or 1). By removing the final round function in the aforementioned deep learning model, we get the probability of a member’s transcript being predicted as 1 (i.e., vote for no, different from the chair’s vote). Hence, the prediction score extracted from the sigmoid function can be interpreted as how close the member agrees with the chair, and we call it the *disagreement score* from now on. We denote s_{ij} as FOMC member j ’s disagreement score in meeting i . If s_{ij} is close to 0, it means that member j is unlikely to vote NO and leans to agree with the chair in FOMC meeting i . Conversely, if s_{ij} is close to 1, this member has a high chance to disagree and vote NO.

3.2 FOMC meeting transcripts

With the disagreement scores (s_{ij}) from our customized model, we can now study what characteristics contribute to FOMC members’ voting behaviors. Moreover, we are able to

⁷We have also experimented with other schedulers, such as using different step thresholds or incorporating restarts into the schedulers to mitigate potential issues with local minima. However, our findings indicate that the current configuration yields the best model performance.

describe the hidden dissents (i.e., disagreement) that cannot be fully captured by voting records ($v_{ij} = 0$ or 1).

Figure 5 shows the boxplot of the disagreement scores (s_{ij}) in each year. The red box in the plot represents the Q1 to Q3 quartile values of the data, the black line in the middle of the box represents the median (Q2), and the whiskers extend to 1.5 times the interquartile range (Q3-Q1). Meanwhile, we compare the boxplot with the percentage of total NO votes (depicted by the black dotted line), and they reveal a similar trend. For example, the high median score in 1980 aligns with a substantial portion of total NO votes cast in history. On the other hand, the median score is lower in recent year and fewer number of NO votes are recorded.

Furthermore, Figure 6 presents the word cloud for different groups based on disagreement scores and FOMC meeting policy actions. The first two figures represent the word cloud for members with disagreement scores below 0.5 and above 0.5. Subsequent rows refine these word clouds based on FOMC meeting policy actions (maintain, increase, or decrease the federal funds rate).

In the plots, both the gray shading and word sizes represent word frequency in meeting transcripts. One pattern is obvious: inflation has a high priority in every FOMC meeting. From the first row we can see that no matter the members have low (i.e., align with the meeting decision) or high disagreement scores (i.e., deviate from the meeting decision), inflation remains focus in both groups. While words like "economy" and "risk" show relatively high priority in the low-score group, the high-score group's emphasis stays on inflation. This pattern persists when groups are further refined based on policy actions. When FOMC opts not to reduce the policy rate, the low-score group prioritizes inflation, followed by economy, growth, and risk, etc. On the other hand, the high-score group mainly focuses on inflation alone, followed by economy, growth, unemployment, etc. However, a deviation from this pattern arises in the periods when FOMC seeks to decrease the rate. In those meetings, inflation drops to the third most frequent word for the low-score group. Meanwhile, inflation still has

the highest priority in the high-score group, but other words like growth and economy also become more important. The observation may suggest that the decision to reduce the rate usually is reached when FOMC has to pivot its priority from inflation to other goals, like economic growth or market stability. For a robustness check, we also show word clouds for different groups based on members’ voting records (see [Figure A.1](#)), and yield similar results.

3.3 FOMC members’ speeches

Next we apply the trained deep learning model to analyze the speeches of FOMC members. Following the procedure outlined in [subsection 3.2](#), our model assigns a disagreement score, s_{ij}^{speech} , to each speech, reflecting the extent of its divergence from the chair’s tone. A higher score of s_{ij}^{speech} implies a greater deviation from the chair and an increased probability of a dissenting vote (NO) at the end of the meeting. A critical aspect to consider is the selection of an appropriate reference point for the deep learning model. The efficacy of our model in gauging the degree of disagreement relies on identifying a reference point representing the chair’s stance. To encapsulate the disagreement demonstrated in members’ speeches, we employ two distinct reference points: (1) the chair’s transcript from the relevant FOMC meeting, denoted as $s_{ij}^{speech,in}$, and (2) the most recent public address by the chair preceding the FOMC meeting in question, represented as $s_{ij}^{speech,pre}$.

After obtaining the scores s_{ij}^{speech} , we calculate the average scores per year to represent the overall level of disagreement in each year for speeches and transcripts. They are then juxtaposed with overall dissents measured by the annual count of NO votes in [Figure 7](#).

First, we find that the disagreement level measured in speech data roughly tracks the level measured by transcript disagreement scores. When either value is high, which means there is a strong disagreement among FOMC members, we can usually observe a higher number of NO votes in that year.

Second, in contrast to the level of disagreement derived from speech disagreement scores, the values calculated from transcript disagreement scores exhibit a closer alignment with

the dissents measured in the voting records. This finding is not surprising given that we can assign scores to all FOMC meeting members’ transcripts. However, not every FOMC member delivered a speech, it inevitably leaves us with a relatively “sparse” speech data set. Meanwhile, certain disparities emerge between the disagreement trends and the eventual vote outcomes. For example, both measures show that the level of disagreement was not high in 1998, but six NO votes were recorded in that year. The reason is that five out the six NO votes were cast by President Jerry L. Jordan which become a statistic outlier and is overlooked by our current measure.

Furthermore, scores measured in speeches lean closer to 0.5 compared to those measured in transcripts, especially after 2000. We interpret it as showing that FOMC members tend to exhibit a more neutral tone in public speeches than in their remarks during FOMC meetings, probably trying to avoid creating confusion or uncertainty in the financial markets.

Finally, when using the chair’s recent public speech as the reference point, scores derived from members’ speeches consistently fall below those obtained from using the chair’s meeting transcripts as the reference point. This discrepancy underscores the increased difficulty in identifying divergences between the opinions of FOMC members and their chair through mere examination of their public speeches.

In [Figure A.2](#), we show the results in a more refined scope and report the results on the meeting basis. In this plot, every speech is linked to the subsequent FOMC meeting. We still see that the values of speech scores are higher than that of transcript scores, and this pattern has become even more obvious in recent year.

4 Results

Since the disagreement scores from transcripts and speeches are inferred at the member level, a natural point to start is to find out how individual scores are related to macroeconomic variables and personal characteristics. To test if the disagreement score is related to the dual

mandate (i.e., maximum employment and stable prices), we use the unemployment rate and core CPI as the target macroeconomic variables in this study.⁸ And personal characteristics are discussed in [subsection 2.1](#). Next, we aggregate the scores for the committee and look at disagreement at the meeting level. Finally, to check if disagreement can be used to explain why FOMC deviate from the optimal policy.

After obtaining the disagreement score s_{ij} for FOMC member j in meeting i , we measure the level of disagreement inside each FOMC meeting using the average of disagreement scores ($S_i = \sum_{j=1}^N s_{ij}$), which quantifies the hidden dissent intensity toward the chair. Similarly, for each meeting, we define the average value of final vote results (0 or 1) as V_i .

Utilizing the disagreement score s_{ij}^{speech} from FOMC members' speeches, we also construct the variable S_i^{speech} to measure the level of disagreement before each FOMC meeting. Here we link the speeches that delivered before meeting i but after meeting $i - 1$ to group i and calculate the S_i^{speech} using the same method as we do for calculating S_i . The summary statistics for these disagreement measures are reported in [Table 5](#).

4.1 The informational content in FOMC transcripts

To examine how members' disagreement scores are related to macroeconomic variables and personal characteristics, we run the following regressions:

$$y_{ij} = \beta_0 + \beta_1 X_i^{MacroVariables} + \beta_2 X_{ij}^{PersonalCharacters} + \varepsilon_{ij},$$

where $y_{ij} = s_{ij}, v_{ij}$. Considering the unbalanced nature of the panel data and the conditions where $s_{ij} \in (0, 1)$ and $v_{ij} \in \{0, 1\}$, we employ mixed-effects beta panel regression for s_{ij} and mixed-effects logistic panel regression for v_{ij} , respectively.⁹ Both regressions are clustered at

⁸As mentioned in [subsection 2.4](#), the core CPI data documented in the Tealbook (formerly Greenbook), is available starting from February 12, 1986. Consequently, the following regression analyses in this paper are exclusively based on data from this date onwards.

⁹For these and all the following regressions, using OLS yields similar results and does not change our conclusions.

the individual level and the findings are presented in [Table 6](#). Both certain macroeconomic variables and personal characteristics can explain the disagreement score. In particular, as inflation is trending up, members on average have more reservations about the FOMC decision. This observation echos the conclusion from ([Ball, 1992](#)) that high inflation may raise inflation uncertainty since when inflation is high, the Federal Reserve is facing a dilemma: curbing inflation or a potential recession. Consistent with [Bordo and Istrefi \(2023\)](#), where the member went to school matters. Regarding other personal characteristics, the findings remain inconclusive, leading us to consider these factors as control variables. For a comprehensive presentation of the results, please refer to [Appendix C](#). Furthermore, if we use votes of dissents instead, while results for education mostly remain, macroeconomic variables do not matter anymore.

Next, we run a similar regression at the meeting level, finding out how the average score of disagreement S_i for meeting i is related to the macroeconomic variables and the characteristics of the composition of the FOMC committee. We summarize the personal characteristics at the meeting level as follows:

- (i) Standard deviations of members' experience ($D_{experience}$), ages (D_{age}), endowment per student of the school where the member received her highest degree ($D_{SchoolWealth}$);
- (ii) Percentage of female members (P_{gender}), highest degrees in econ-related field (P_{major}), members who experience events (e.g., Great Depression, Great Inflation, WWII) (P_{event});
- (iii) Entropy of hometown regions ($E_{hometown}$) measures the diversity of hometown regions of FOMC members within a meeting, school regions (E_{school}) where members received their highest degree, the party of the president (E_{POTUS}) who appointed the governor;¹⁰

Taking into account that $S_{ij} \in (0, 1)$ and $V_{ij} \in [0, 1)$, we utilize beta regression for modeling S_{ij} and fractional logistic regression for V_{ij} , correspondingly. Results are reported in [Table 7](#).¹¹ In column (1), it is observed that the macroeconomic variables significantly

¹⁰For chairs from the regional Federal Banks, we use the nearest state level presidential election result to proxy the party.

¹¹Consistent with the individual-level results, the majority of these member characteristics are treated as control variables. A detailed report on these variables is available in [Appendix C](#).

account for the variance in the disagreement score S_i , as indicated by a pseudo R^2 of approximately 23%. Both lower unemployment and higher inflation are associated with increased disagreement. Meanwhile, column (2) shows that educational factors continue to play a vital role at the meeting level. Beyond the locations of educational institutions, a higher proportion of FOMC members holding economics-related degrees is correlated with a reduced level of disagreement. For dissents, columns (3) and (4) demonstrate that they exhibit an insignificant correlation with the macroeconomic variables. Our results are consistent with [Thornton and Wheelock \(2014\)](#) who observe that the number of dissents in general is not correlated with either inflation or the unemployment rate.

We also consider other variables that may be correlated with the level of disagreement, and the results are reported in [Appendix A](#).

There is evidence that yield curve predicts recessions or output growth (see, among many examples, [Ang et al. \(2006\)](#)). In particular, an inverted yield curve (i.e., when the long rate is lower than the short) is often viewed as an ominous sign of a future recession. Members of the FOMC may take the yield curve into account when forming their view on the economy and monetary policy. In [Table A.1](#), we include the yield curve either as the spread between 10-year and 2-year Treasury bonds or a dummy variable for an inverted yield curve (i.e., when the 2-year yield is higher than the 10-year one). Both variables show insignificant correlation with the level of disagreement. However, if we regress the level of disagreement only on the yield curve variable, the latter becomes significant. Our macroeconomic variables seem to contain all the relevant information in the yield curve.

Finally, we check if the level disagreement is driven by uncertainty, as measured by either the CBOE Volatility (VIX) index or the Economic Policy Uncertainty (EPU) index. We can see in [Table A.2](#) that they have no explanatory power. It is consistent with the finding that aggregate uncertainty is driven by monetary policy and less so the other way round ([Bekaert et al. \(2013\)](#)).

At the minimum, results in this section confirm that the disagreement scores are not mere

noises. Comparing to dissents in FOMC meetings, they are more correlated to the economy and some personal characteristics.

4.2 The informational content in speeches

While FOMC transcripts have a 5-year release lag, FOMC members make speeches regularly. Do what they say in speeches reveal their disagreement level in the following meeting?

As discussed in [subsection 3.3](#), we feed FOMC members' speeches into the deep learning model and generate two speech disagreement scores for each speech, $s_{ij}^{speech,in}$ and $s_{ij}^{speech,pre}$ depending on how to choose the reference point for chair. The first measure $s_{ij}^{speech,in}$ uses the chair's words in the following meeting as the reference point. Since transcripts are subject to a 5-year time lag and are not available in real time, the second measure $s_{ij}^{speech,pre}$ uses the chair's speeches before the meeting, which are available in real time, as the reference point instead. For either measure and for each meeting i , we can take the average of the disagreement scores for speeches that happened before meeting i but after the previous meeting $i - 1$ and get S_i^{speech} .

Not every FOMC member gives speeches regularly, so S_i^{speech} is probably a noisier measure than the level of disagreement from transcripts S_i . Nevertheless, as we can see in [Figure 7](#), the two variables are positively correlated.

To evaluate the predictive power of speeches, we add the speech scores to the regressions detailed in [subsection 4.1](#) and the results are presented in [Table 8](#). Columns (1) and (3) shows a positive correlation between $s_{ij}^{speech,in}$ and the disagreement score derived from transcripts. Knowing what the chair said in the following meeting, we will be able to detect disagreement in speeches made by FOMC members. When we change the measure to $s_{ij}^{speech,pre}$ in columns (2) and (4), the predictive power of speeches goes down significantly. Knowing only the speeches made by the chair in the same period, it is much harder to detect disagreement in speeches made by FOMC members.

Results at the meeting level are reported in [Table 9](#) and [Table 10](#) and they tell a similar

story. The measure $S_i^{speech,in}$ predicts the subsequent meeting’s level of disagreement S_i , and the predictive power evaporates when we change the measure to $S_i^{speech,pre}$. For dissents, neither of the measures for speeches has any predictive power. Since not all FOMC members give speeches regularly, we use S_i calculated only for members who gave speeches before the meeting as a robustness check, and results are similar (see [Table A.3](#)).

It is well-known that speeches made by FOMC members are carefully crafted and they often do not reveal much about the speech maker’s views on monetary policy. Our results have a more subtle suggestion. Speeches made by FOMC members would be informative only if we knew what the chair said in the following meeting. Without that reference point, information in the speeches becomes elusive. A possible explanation is that the FOMC chair and members coordinate in writing their speeches to avoid stark differences in views.

4.3 What do members disagree about?

What does our disagreement measure represent? What drives its movement over time? We have shown that disagreement is more strongly correlated with the economy than voting outcomes are, and we have also shown that speeches made by members do not fully reflect their disagreement with where monetary is going. Now we will try to identify the source of disagreement, using two different data sources.

First, we use the data from the Summary of Economic Projections (SEP) to gauge the divergence of members’ view on the direction of the economy. Starting from 2007 (2012 for the federal funds rate), we have access to the individual responses in the SEP that are released four times a year. The SEP contains FOMC members’ anonymous assessments on future monetary policy and projections for unemployment rate, GDP growth, PCE inflation, and core PCE inflation.

In our analysis, we categorize the Summary of Economic Projections (SEP) variables into two groups: projections of the federal funds rate, which represent what the member considers as the “appropriate monetary policy”, and projections for other economic indicators,

which indicate the members’ expectations for the economy outlook. To quantify the levels of disagreement embedded within these projections, we employ the method of calculating the absolute sum of deviations from the median projection for each category, a technique utilized by Foerster and Martinez (2023). Given the limited sample size and the high correlations among the projections, we consolidate the SEP policy disagreement measures across different horizons (current year, next year, the following year, and long term) into a single principal component (which captures 53.6% of the variations). For economy outlook-related disagreement measures (same horizons, except no long run values for the inflation measures), we use up to three principal components to encapsulate the corresponding SEP disagreement levels.

We then regress the disagreement measure derived from meeting transcripts against each category of SEP disagreements, and the results are shown in Table 11. First, disagreement on the path of the federal funds rate clearly predicts the disagreement measure identified in our transcripts, evidenced by an R^2 of around 20% (column (1)). Second, the disagreement concerning economic forecasts has about the same explanatory power: while the R^2 is lower in the longer sample that begins in 2007 in column (2), it is higher using the same sample as the federal funds rate in column (3).¹² These results imply that our disagreement measure is equally associated with the heterogeneity of members’ policy preferences rather than their views on the economic outlooks.

SEP policy disagreement is clearly influenced by disagreement on the economy outlook, and it is possible that policy disagreement matters only because of the other disagreement. Indeed, the first component of SEP policy disagreement (Policy_{PC1}) and the first component of SEP economy outlook disagreement (Economy_{PC1}) are highly correlated with a coefficient of 0.7253. We would like to know the relationship between our disagreement measure and one of the SEP disagreement, after the influence of the other SEP disagreement is removed.

To do this, we apply the Double Machine Learning (DML) method proposed by Chernozhukov et al. (2017). DML combines machine learning techniques with econometric models

¹²If the absolute sum of deviations from the mean projection is utilized to compute SEP disagreements, disagreement on the monetary policy path becomes more important. See Table A.4.

to control for confounding variables, and it aims at isolating the causal effect of a treatment variable (T) on the variable of interest (Y). DML operates in two stages: first, it leverages machine learning algorithms to predict Y and T separately based on confounder variables X , and the algorithm helps us to capture the complex relationships between Y or T and X . Next, the residuals from these predictions are regressed against each other to estimate the causal effect. In our setting, each SEP disagreement takes the role of T or X alternately, with our transcript disagreement measure (S_i) being Y .¹³ In the first stage, we adopt the Lasso model ($\alpha = 1$), followed by the implementation of linear regression in the second stage. To mitigate overfitting and reduce estimation bias, cross-fitting is employed in our model.

The second stage results are reported in columns (4) and (5) of [Table 11](#). The significant and positive coefficient for Residualized Policy_{PC1} implies that the disagreement on monetary policy significantly contributes to FOMC meeting disagreements, even after accounting for disagreement on the economy outlook. Disagreement on monetary policy contains something else that is related to our measure. One possibility is members having different loss functions, but it is also possible that members differ on variables not covered in the SEP. In contrast, Residualized Economy_{PC1} is not statistically significant, suggesting that disagreement on the economy outlook does not have a separate influence on our measure.

More evidence on this interpretation comes from the optimal policy perturbation (OPP) proposed by [Barnichon and Mesters \(2023\)](#).¹⁴ Based on a loss function, the median projections, and impulse responses of inflation and unemployment rates to monetary policy shocks, OPP measures the deviation of monetary policy from its optimal level. A positive OPP means that monetary policy is looser than the optimal, while a negative OPP means it is too tight. [Figure 8](#) shows the correlation between the level of disagreement inside FOMC meetings and OPP measures across three different monetary policy definitions: the federal

¹³SEP policy disagreement is characterized by four distinct measures, while SEP economic outlook disagreement encompasses fourteen measures. We treat the first principal component of one SEP disagreement as T , and utilize all measures from the other SEP disagreement as X .

¹⁴The OPP dataset spans from 1980 to 2022 and exhibits varying frequencies due to the limitation in data availability. We have matched the OPP data with the level of disagreement data derived from the FOMC meetings held immediately prior to the date of the OPP data.

funds rate, the shadow rate, and the slope of the yield curve through quantitative easing.¹⁵ Besides the Financial Crisis period, during which the nominal interest rate approached the zero lower bound, a significant deviation of the OPP measure from zero is associated with an elevated level of disagreement. The OPP also covers a much longer period, comparing to less than 10-year of SEP data.

To closely examine their relationship, in [Table 12](#) we show the regression results for these three different monetary policy definitions. We utilize the level of disagreement from the FOMC meeting immediately preceding the generation of the OPP measure as the independent variable. The results show that the absolute value of the OPP (federal funds rate) is strongly correlated with our disagreement measure. By separating the positive and negative values of the OPP, we can see that disagreement increases with deviation from optimum in either direction. Results for the other two OPP measures seem different, but that is mostly caused by the large negative value of the OPP during the Financial Crisis. Once those observations are dropped, we find the same relationship between disagreement and deviation from optimal policy.

Unlike the SEP data, the OPP does not allow us to distinguish between members' preferences and their projections. The OPP is derived from a reduced-form model and a loss function where the weights on inflation and unemployment gaps are equal, and we can at best conclude that both forms of heterogeneity contribute to disagreement. We can evaluate their relative importance only with more SEP data in the future.

5 Conclusion

In this paper, leveraging the transfer learning method, we propose a deep learning model that utilizes the self-attention mechanism to predict disagreement scores for FOMC meeting members based on their transcripts. Building on the disagreement scores, we construct a

¹⁵To improve the readability, the level of disagreement in [Figure 8](#) is smoothed with a rolling window size equals to twelve.

measure to gauge the level of disagreement and compare this measure with the measure generated from the actual voting records.

This paper has three main results. First, we find that the disagreement level is strongly correlated with macroeconomic variables and the education background of members. Other personal characteristics do not matter. Second, we find that speeches do not tell us much about disagreement in real time. They are informative only when we have access to the transcript of the next meeting. Third, we find that disagreement is likely contributed by heterogeneity in both members' preferences and their projections.

One notable limitation of this study is that, as we do not separate different disagreement directions (i.e., whether the policy action should be looser or tighter), the underlying reasons for some members' disagreement remain ambiguous. More data will resolve this issue, as more NO votes are needed to facilitate the deep learning model in capturing the subtle differences.

Another limitation comes from the change in monetary policy framework after 2008. The Federal Reserve no longer just focuses on the federal funds rate, and policy discussion touches on other tools like quantitative easing and forward guidance. FOMC members may disagree not only on the direction of monetary policy but also on the approach, but with fewer than two decades of data since 2008, it seems unlikely that we are able to deal with this issue with a deep learning model.

References

- M. Alexopoulos, X. Han, O. Kryvtsov, and X. Zhang. More than words: Fed chairs' communication during congressional testimonies. *Journal of Monetary Economics*, 2023.
- A. Ang, M. Piazzesi, and M. Wei. What does the yield curve tell us about gdp growth? *Journal of econometrics*, 131(1-2):359–403, 2006.
- M. Apel, M. Blix Grimaldi, and I. Hull. How much information do monetary policy committees disclose? evidence from the fomc's minutes and transcripts. *Journal of Money, Credit and Banking*, 54(5):1459–1490, 2022.
- J. Arismendi-Zambrano, E. Kypraios, and A. Paccagnini. Federal reserve chair communication sentiments' heterogeneity, personal characteristics, and their impact on uncertainty and target rate discovery. Technical report, Technical Report ICM-2021-01, Henley Business School, ICMA Centre, 2021.
- L. Ball. Why does high inflation raise inflation uncertainty? *Journal of Monetary Economics*, 29(3):371–388, 1992.
- R. Barnichon and G. Mesters. A sufficient statistics approach for macro policy. *American Economic Review*, 113(11):2809–2845, 2023.
- G. Bekaert, M. Hoerova, and M. L. Duca. Risk, uncertainty and monetary policy. *Journal of Monetary Economics*, 60(7):771–788, 2013.
- C. Bertsch, I. Hull, R. L. Lumsdaine, and X. Zhang. Central bank mandates and monetary policy stances: through the lens of federal reserve speeches. *Available at SSRN 4255978*, 2022.
- M. Bordo and K. Istrefi. Perceived fomc: The making of hawks, doves and swingers. *Journal of Monetary Economics*, 136:125–143, 2023.
- B. Born, M. Ehrmann, and M. Fratzscher. Central bank communication on financial stability. *The Economic Journal*, 124(577):701–734, 2014.
- V. Chernozhukov, D. Chetverikov, M. Demirer, E. Duflo, C. Hansen, and W. Newey. Double/debiased/neyman machine learning of treatment effects. *American Economic Review*, 107(5):261–265, 2017.
- A. Cieslak, S. Hansen, M. McMahon, and S. Xiao. Policymakers' uncertainty. *Available at SSRN 3936999*, 2021.

- F. Curti and S. Kazinnik. Let’s face it: Quantifying the impact of nonverbal communication in fomc press conferences. *Journal of Monetary Economics*, 2023.
- A. Foerster and Z. Martinez. The evolution of disagreement in the dot plot. *Evolution*, 2023: 21, 2023.
- Y. Gorodnichenko, T. Pham, and O. Talavera. The voice of monetary policy. *American Economic Review*, 113(2):548–584, 2023.
- A. Handlan. Text shocks and monetary surprises: Text analysis of fomc statements with machine learning. *Published Manuscript*, 2020.
- S. Hansen and M. McMahon. Shocking language: Understanding the macroeconomic effects of central bank communication. *Journal of International Economics*, 99:S114–S133, 2016.
- S. Hansen, M. McMahon, and A. Prat. Transparency and deliberation within the fomc: A computational linguistics approach. *The Quarterly Journal of Economics*, 133(2):801–870, 2018.
- S. Hansen, M. McMahon, and M. Tong. The long-run information effect of central bank communication. *Journal of Monetary Economics*, 108:185–202, 2019.
- L. Husted, J. Rogers, and B. Sun. Monetary policy uncertainty. *Journal of Monetary Economics*, 115:20–36, 2020.
- K. Istrefi. In fed watchers’ eyes: Hawks, doves and monetary policy. 2019.
- K. Istrefi, F. Odendahl, and G. Sestieri. Fed communication on financial stability concerns and monetary policy decisions: Revelations from speeches. *Journal of Banking & Finance*, 151:106820, 2023.
- D. Jurafsky and J. H. Martin. *Speech and language processing* (3rd ed. draft), 2023.
- G. A. Kahn and A. Oksol. Understanding hawks and doves. *Macro Bulletin*, (June 27, 2018): 1–4, 2018.
- U. Kamath, J. Liu, and J. Whitaker. *Deep learning for NLP and speech recognition*, volume 84. Springer, 2019.
- I. Lauriola, A. Lavelli, and F. Aioli. An introduction to deep learning in natural language processing: Models, techniques, and tools. *Neurocomputing*, 470:443–456, 2022.

- M. Leombroni, A. Vedolin, G. Venter, and P. Whelan. Central bank communication and the yield curve. *Journal of Financial Economics*, 141(3):860–880, 2021.
- K. G. Lunsford. Policy language and information effects in the early days of federal reserve forward guidance. *American Economic Review*, 110(9):2899–2934, 2020.
- U. Malmendier, S. Nagel, and Z. Yan. The making of hawks and doves. *Journal of Monetary Economics*, 117:19–42, 2021.
- N. Reimers and I. Gurevych. Sentence-bert: Sentence embeddings using siamese bert-networks. *arXiv preprint arXiv:1908.10084*, 2019.
- C. D. Romer and D. H. Romer. The fomc versus the staff: where can monetary policymakers add value? *American Economic Review*, 98(2):230–235, 2008.
- A. Shah, S. Paturi, and S. Chava. Trillion dollar words: A new financial dataset, task & market analysis. *arXiv preprint arXiv:2305.07972*, 2023.
- A. H. Shapiro and D. J. Wilson. Taking the fed at its word: A new approach to estimating central bank objectives using text analysis. *The Review of Economic Studies*, 89(5):2768–2805, 2022.
- A. H. Shapiro, M. Sudhof, and D. J. Wilson. Measuring news sentiment. *Journal of econometrics*, 228(2):221–243, 2022.
- E. T. Swanson. The importance of fed chair speeches as a monetary policy tool. In *AEA Papers and Proceedings*, volume 113, pages 394–400. American Economic Association, 2023.
- D. L. Thornton and D. C. Wheelock. Making sense of dissents: a history of fomc dissents. *Federal Reserve Bank of St. Louis Review*, 96(3):213–227, 2014.
- E. Tobback, S. Nardelli, and D. Martens. Between hawks and doves: measuring central bank communication. 2017.
- T. Todd. *A Corollary of Accountability: A History of FOMC Policy Communication*. Federal Reserve Bank of Kansas City, 2016.

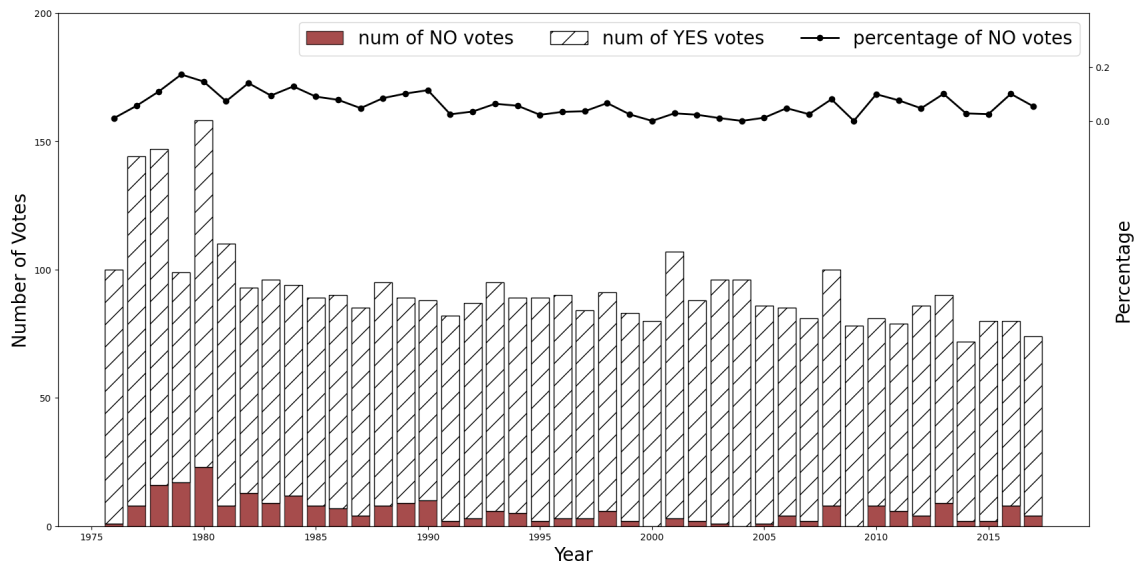

Figure 1: Number of YES and NO Votes in Each Year

Note: The bar chart shows the distribution of YES and NO votes cast by FOMC members in each year. The red bar represents the number of NO votes, and the transparent bar with stripes on top is the number of YES votes. The dotted line shows the percentage of NO vote in each year.

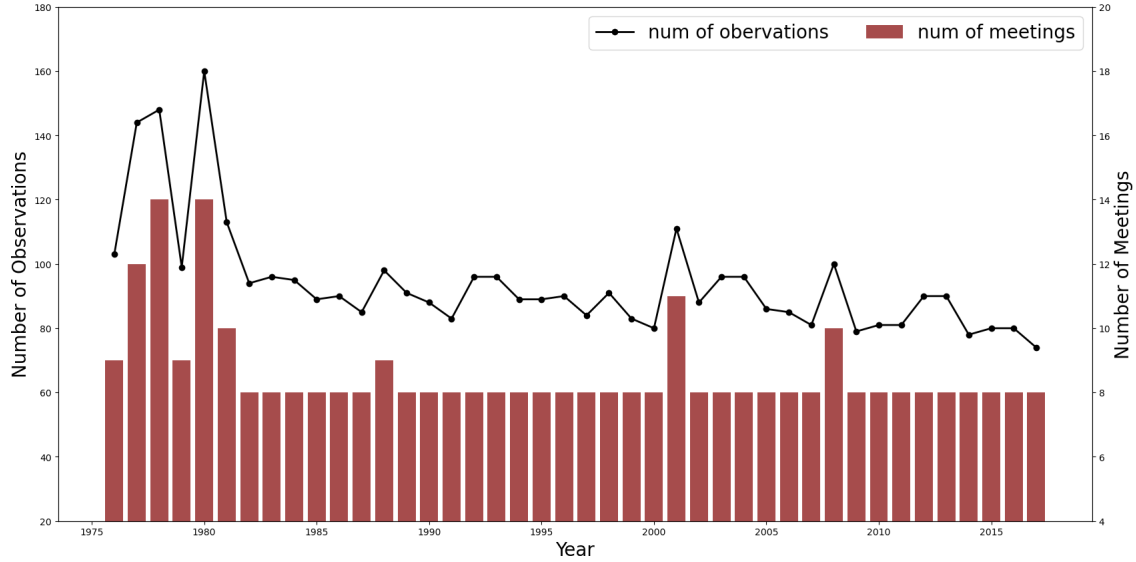

Figure 2: Numbers of Observations and Meetings in Each Year

Note: The bar chart shows the number of FOMC meetings in each year, and the black dotted line represents the number of FOMC members (i.e., number of observations) who cast votes in these meetings. The number of meetings is relatively stable in recent years but the number of observations has a small fluctuation given that attended members may change in each meeting.

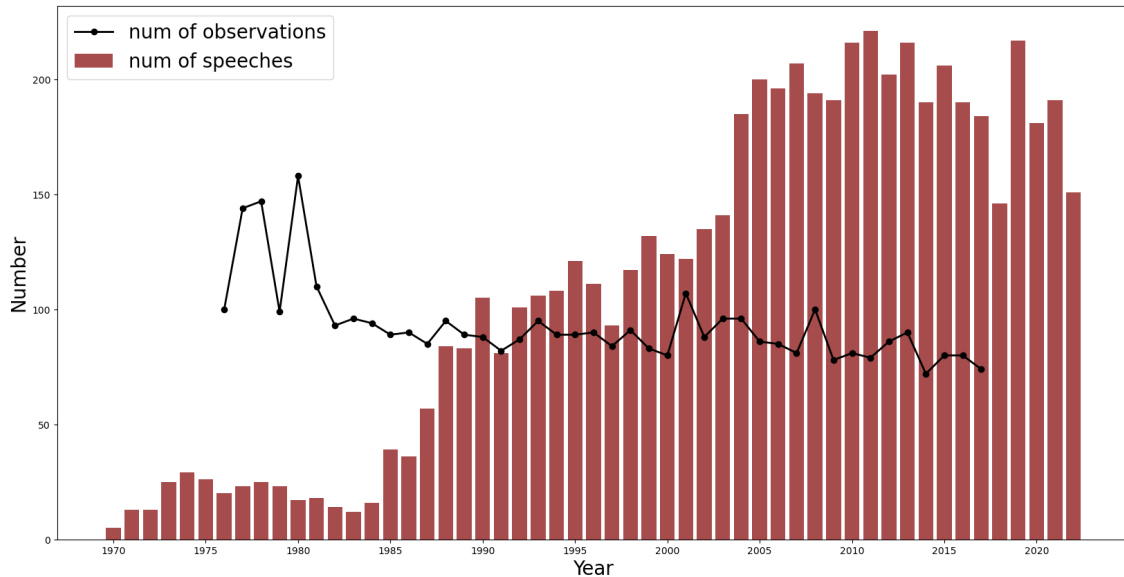

Figure 3: Numbers of Observations and Speeches in Each Year

Note: The bar chart shows the number of available public speeches delivered by FOMC members in each year, and the black dotted line represents the number of FOMC members (i.e., number of observations) who cast votes in these meetings. Most available speeches come from recent years, and before 1987, less than 50 speeches was successfully retrieved per year.

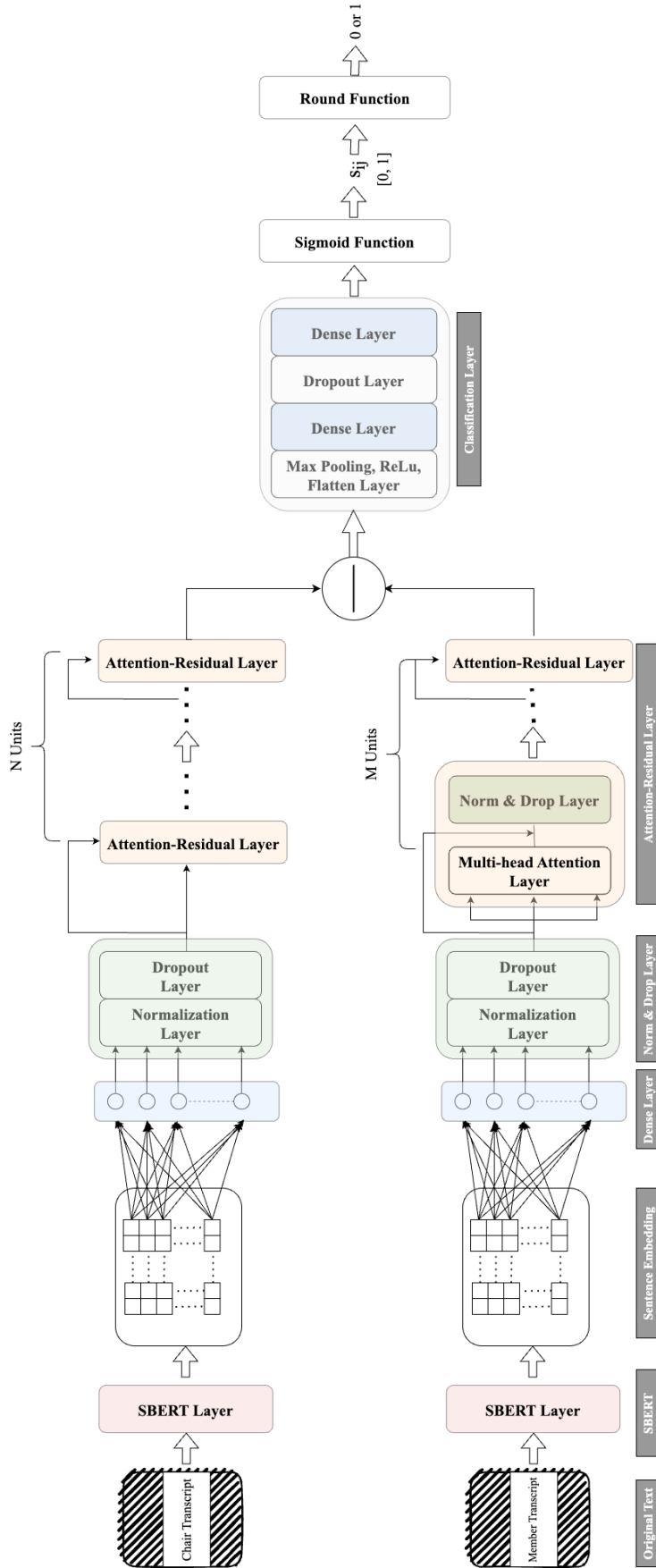

Figure 4: FOMC Deep Learning Model

Note: This figure describes the Deep Learning model used in this paper. The SBERT layer converts the original texts into sentence embedding, a high-dimensional array that can be operated on by the following modules. Then multiple Multi-head Self-attention modules along with dense layers, dropout layers are applied to extract the most related features. A more detailed discussion please refer to [subsection 3.1](#).

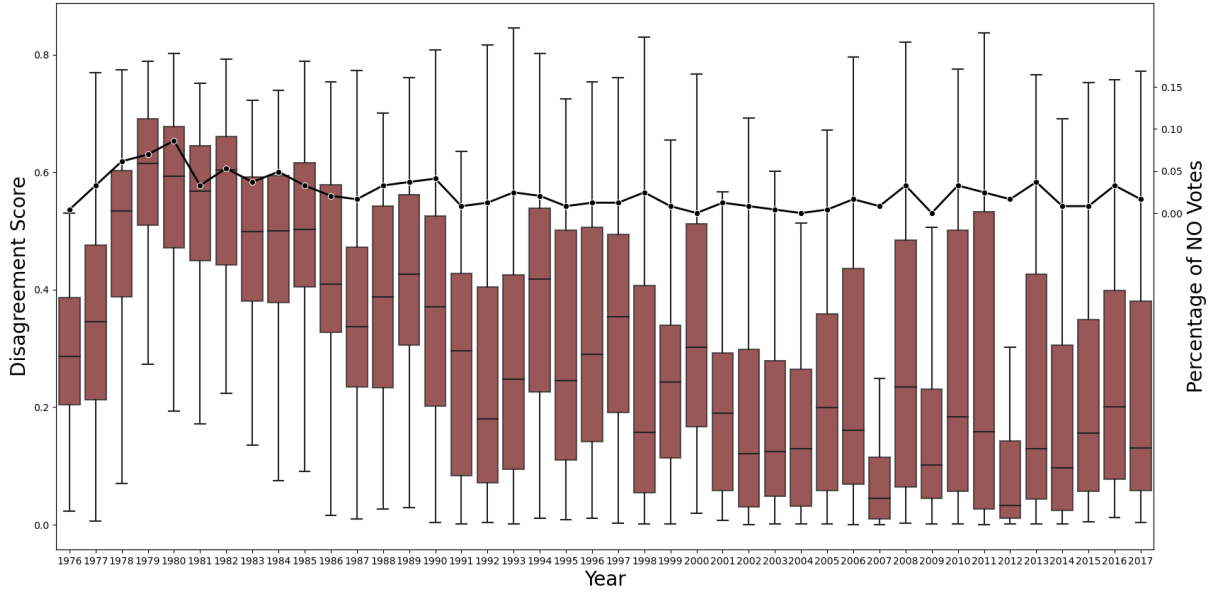

Figure 5: Disagreement Score Distribution

Note: This figure shows the boxplot of disagreement scores in each year. The red box in the plot represents the Q1 to Q3 quartile values of the data, the black line in the middle represents the median (Q2), and the whiskers extend to 1.5 times the interquartile range (Q3-Q1). The black dotted line represents the percentage of total NO votes in the sample are allocated in each year.

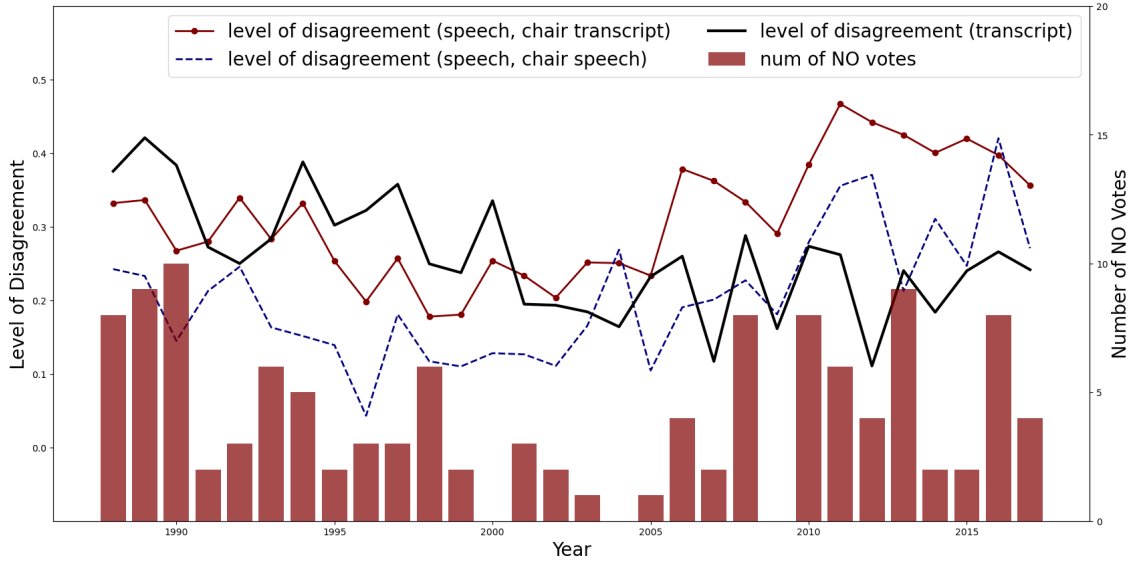

Figure 7: Level of Disagreement in Speeches and Transcripts, NO Votes

Note: The red dotted line and the blue dash line portray the level of disagreement within speeches using different reference points, quantified by the yearly average speech disagreement scores. Similarly, The black line represents the level of disagreement in transcripts and is measured using the same method. The bar chart shows the number of NO votes recorded in each year.

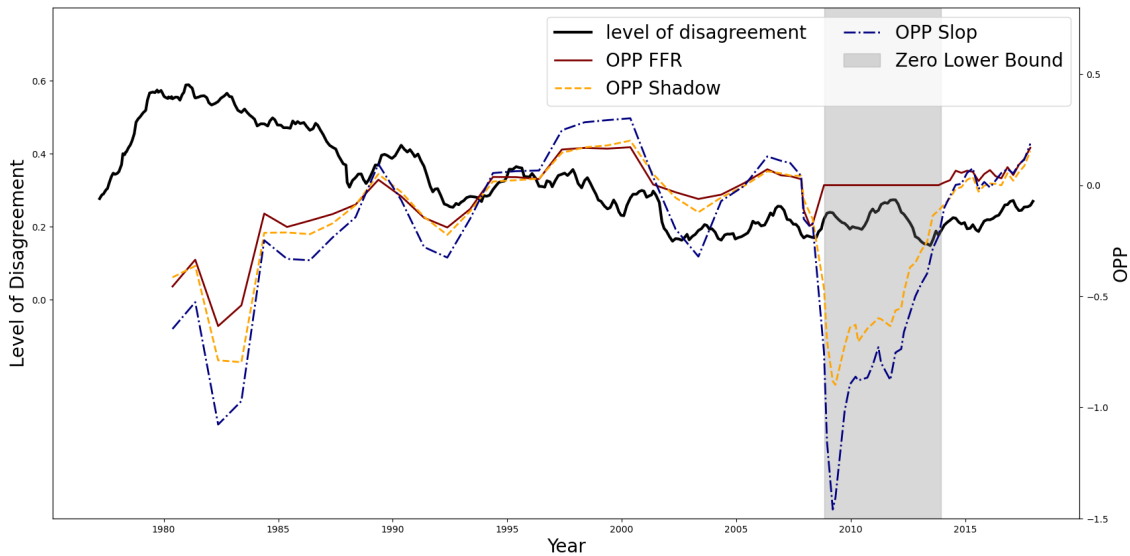

Figure 8: Level of Disagreement and Optimal Policy Perturbation

Note: This figure shows the trend of the level of disagreement and various Optimal Policy Perturbation (OPP) measures introduced by [Barnichon and Mesters \(2023\)](#). The gray shadow area refers to the Financial Crisis period when the nominal interest rate reached 0%.

Table 1: FOMC Member Personal Information

Collected Personal Info.	Description
Birth Date	birth date of the FOMC member
Gender	gender of the FOMC member
Hometown Region	region where the member's hometown belongs
Term Starts	year when the member became the governor/president
Term Ends	year when the member stepped down from current position
School Region	region of the school where the highest degree is received
School Wealth	endowment per student of the school where the highest degree is received
Degree Major	major of the highest degree received by the member
Great Depression	count 1 if the member experienced the Great Depression
Great Inflation	count 1 if the member experienced the Great Inflation
WWII	count 1 if the member experienced the World War II
Party	(1) party of the POTUS (governors) or (2) party who won the state-level U.S. presidential election (presidents)

Note: This table shows the descriptions of the information we collect for each FOMC member. Information is collected through various channels, like the Federal Reserve History website, personal Wikipedia pages and news articles.

Table 2: FOMC Member Selective Personal Characteristics Summary Statistics

Personal Char.	Count	Proportion (%)
<hr/>		
Hometown		
Northeast	32	32.99
Midwest	23	23.71
South	22	22.68
West	13	13.40
Other	7	7.22
<hr/>		
School		
Northeast	43	44.33
Midwest	26	26.80
South	18	18.56
West	10	10.31
<hr/>		
Experience		
WWII	52	53.61
Great Depression	41	42.26
Great Inflation	43	44.33
<hr/>		
Other Char.		
Female	14	14.43
Economics Major	69	71.13
Appt. Democrat	44	45.36

Note: This table shows the distribution of selective FOMC members' characteristics variables. The variable "Hometown Other" represents members who grow up outside the U.S. The variable "Appt. Democrat" counts the members who were appointed by a Democratic president or who came from a state that voted for a Democratic candidate in the U.S. presidential election.

Table 3: FOMC Meeting Information

Variable	Description
Macro-level Variables	
Unemployment Trend	trend of the unemployment data in Tealbook
Unemployment S.D.	standard deviation of the unemployment data in Tealbook
CPI Trend	trend of the core CPI data in Tealbook
CPI S.D.	standard deviation of the core CPI data in Tealbook
Meeting-level Variables	
Experience S.D.	standard deviation of members' experience
Age S.D.	standard deviation of members' ages
School Wealth S.D.	standard deviation of the wealth of the schools attended by members
Hometown DEI.	diversity of members' hometown regions
School DEI.	diversity of school regions where members earned their highest degrees
Major PCT.	percentage of members in a meeting whose highest degree is econ-related
Gender PCT.	percentage of females in a meeting
Great Depression PCT.	percentage of members who experienced the Great Depression
Great Inflation PCT.	percentage of members who experienced the Great Depression
World War II PCT.	percentage of members who experienced the WWII
Appt. Democrat PCT.	percentage of members who are appointed by a Democrat president
Incumbent Democrat	a dummy representing the incumbent president's party, 1 for Democrat

Note: Meeting-level data is calculated from FOMC member personal information. And macro-level economic data comes from the Tealbook (formerly Greenbook).

Table 4: Hyperparameter Value Search Space

Variable	Value Search Space
Number of MHSA Modules in Chair Section	[1, 12], step = 1
Number of MHSA Modules in Member Section	[1, 12], step = 1
Number of MHSA Heads in Chair Section	[4, 12], step = 4
Number of MHSA Heads in Member Section	[4, 12], step = 4
Dropout Rate	[0.4, 0.8], step = 0.005
Initial Learning Rate	[$1e^{-3}$, $1e^{-6}$]

Note: For learning rate, the value is sampled from the range in the log domain. Meanwhile, learning rate scheduler is enabled during the model training process.

Table 5: Summary Statistics for Disagreement Measures

Measure	Mean	S.D.	Min	Max	Count
Individual Level					
s_{ij}	0.3269	0.2286	0.0000	0.8457	3462
v_{ij}	0.0705	0.2560	0.0000	1.0000	3462
$s_{ij}^{speech,in}$	0.2957	0.2762	0.0000	0.8933	1185
$s_{ij}^{speech,pre}$	0.1887	0.2326	0.0000	0.8536	1060
Meeting Level					
S_i	0.3247	0.1515	0.0207	0.7071	362
V_i	0.0708	0.0998	0.0000	0.6667	362
$S_i^{speech,in}$	0.3840	0.1973	0.0002	0.8983	337
$S_i^{speech,pre}$	0.2070	0.1487	0.0021	0.6401	337

Note: This table shows the summary statistics of different disagreement measures used in this study. Variable x_{ij} represents disagreement scores directly derived from our deep learning model using transcripts or speeches. Variable X_i denotes the level of disagreement calculated based on x_{ij} . Please refer to [section 4](#) for a detailed discussion.

Table 6: Explaining Disagreement Scores and Dissents (Individual-level)

	s_{ij} (<i>Mixed Effects Beta</i>)		v_{ij} (<i>Mixed Effects Probit</i>)	
	(1)	(2)	(3)	(4)
<u>Macro Factors</u>				
T_{unemp}	-0.1958 (0.1285)	0.0305 (0.1294)	-0.0127 (0.1511)	0.0285 (0.1542)
D_{unemp}	-0.0200 (0.0453)	-0.0975* (0.0467)	0.1878 (0.1305)	0.1291 (0.1340)
T_{CPI}	1.0702*** (0.1378)	1.0382*** (0.1447)	0.1336 (0.1167)	0.1394 (0.1204)
D_{CPI}	0.5111*** (0.0798)	0.4483*** (0.1030)	0.1710 (0.1743)	0.2342 (0.2230)
<u>Member Char.</u>				
Econ Major		-0.0552 (0.1613)		-0.1172 (0.6641)
School Northeast		-0.3547 (0.2337)		-1.9336** (0.9199)
School South		-0.7555** (0.2374)		-3.9632*** (1.0654)
School West		0.0621 (0.3072)		-1.5127 (1.2335)
Control Var.	No	Yes	No	Yes
Log Likelihood	1561.9	1591.3	-410.0001	-390.9778
N	2,486	2,478	2,486	2,478

Note: This table considers variables that may correlate with the disagreement and dissents. Mixed effect regressions is clustered on FOMC member's level. Member characteristics are explained in [Table 2](#). The sample period starts from the FOMC meeting on the February meeting in 1986 (when the Tealbook core CPI first becomes available) and ends on the December meeting in 2017.

*** $p < 0.01$; ** $p < 0.05$; * $p < 0.1$

Table 7: Explaining Disagreement Scores and Dissents (Meeting-level)

	S_i (<i>Beta</i>)		V_i (<i>Fractional Logistic</i>)	
	(1)	(2)	(3)	(4)
<u>Macro Factors</u>				
T_{unemp}	-0.5609** (0.2233)	-0.5572** (0.2289)	-0.2183 (1.8834)	-0.0619 (2.0598)
D_{unemp}	0.0515 (0.0663)	-0.1106 (0.0857)	0.3873 (0.5551)	-0.1842 (0.8436)
T_{CPI}	1.1307*** (0.2349)	0.6809** (0.2656)	1.3268 (1.9416)	1.3119 (2.4166)
D_{CPI}	0.6696*** (0.0827)	0.1925 (0.1777)	0.5545 (0.6754)	0.8508 (1.7466)
<u>Member Char.</u>				
P_{major}		-1.3640*** (0.3613)		-1.3409 (3.3902)
E_{school}		1.2158*** (0.3448)		1.0184 (3.3491)
Control Var.	No	Yes	No	Yes
Pseudo R^2	0.2334	0.3912		
Log Likelihood	233.4308	265.0157	-13.9574	-14.0092
N	260	260	260	260

Note: This table examines factors that may correlate with the level of disagreement and dissents. The level of disagreement, S_i , is quantified as the average of disagreement scores, and the dissents, V_i , is measured as the percentage of NO votes within a meeting. T_x is the trend of variable x , D_x in the macro-variable section means the s.d. of variable x calculated from the past and forecast values in the Tealbooks. And in the characteristics section, D_x means the s.d. of the variable x in one meeting. E_{school} measure the education institution diversity. P_{major} denotes the percentage of FOMC members whose highest degree is in econ-related field. The sample period starts from the FOMC meeting on the February meeting in 1986 (when the Tealbook core CPI first becomes available) and ends on the December meeting in 2017. *** $p < 0.01$; ** $p < 0.05$; * $p < 0.1$

Table 8: Predicting Disagreement Scores with Speeches (Individual-level)

	s_{ij} (<i>Mixed Effects Beta</i>)		v_{ij} (<i>Mixed Effects Probit</i>)	
	(1)	(2)	(3)	(4)
$s_{ij}^{speech,in}$	0.4479*** (0.1165)		0.4483*** (0.1738)	
$s_{ij}^{speech,pre}$		0.2798* (0.1397)		0.2788* (0.1569)
<u>Macro Factors</u>				
T_{unemp}	0.1006 (0.1714)	0.1085 (0.1778)	0.0547 (0.1751)	0.0135 (0.1944)
D_{unemp}	-0.0851 (0.0658)	-0.0834 (0.0699)	0.3750* (0.1968)	0.2823 (0.2047)
$TCPI$	1.0484*** (0.2310)	1.1219*** (0.2389)	0.1146 (0.1862)	0.1252 (0.2019)
$DCPI$	0.6504*** (0.1884)	0.6490*** (0.1972)	0.9875*** (0.2886)	1.0089*** (0.3069)
<u>Member Char.</u>				
Econ Major	-0.0440 (0.1776)	-0.0305 (0.1866)	-0.2204 (0.6639)	-0.0487 (0.6843)
School Northeast	-0.3163 (0.2595)	-0.2821 (0.2726)	-2.3597** (0.9627)	-2.1627** (0.9132)
School South	-0.7591** (0.2498)	-0.7673** (0.2639)	-3.9076*** (1.1456)	-4.4298*** (1.3206)
School West	0.3376 (0.3593)	0.3780 (0.3763)	-0.4982 (1.3628)	0.0990 (1.2691)
Control Var.	Yes	Yes	Yes	Yes
Log Likelihood	823.3	745.3	-164.3621	-140.2468
N	1,185	1,060	1,185	1,060

Note: This table considers variables that may correlate with the disagreement and dissents. $s_{ij}^{speech,in}$ and $s_{ij}^{speech,pre}$ measure the disagreement in speeches using chair's meeting transcripts and public speeches as reference points, respectively. Mixed effect regressions is clustered on FOMC member's level. Member characteristics are explained in [Table 2](#). The sample period starts from the FOMC meeting on the February meeting in 1986 (when the Tealbook core CPI first becomes available) and ends on the December meeting in 2017. *** $p < 0.01$; ** $p < 0.05$; * $p < 0.1$

Table 9: Predicting Disagreement Scores with Speeches I (Meeting-level)

	S_i (<i>Beta</i>)		V_i (<i>Fractional Logistic</i>)	
	(1)	(2)	(3)	(4)
$S_i^{speech,in}$	0.6548** (0.2623)	0.4703* (0.2589)	1.4231 (2.4399)	1.2682 (2.5015)
<u>Macro Factors</u>				
T_{unemp}		-0.4951** (0.2292)		0.1177 (2.1083)
D_{unemp}		-0.0980 (0.0861)		-0.1427 (0.8476)
T_{CPI}		0.6727** (0.2674)		1.2540 (2.4724)
D_{CPI}		0.2105 (0.1789)		0.7973 (1.7548)
<u>Member Char.</u>				
P_{major}	-1.2293*** (0.2970)	-1.2719*** (0.3647)	-1.7756 (2.6790)	-1.2350 (3.4450)
E_{school}	0.8631** (0.3451)	0.9830*** (0.3613)	1.0864 (3.3207)	0.6390 (3.5623)
Control Var.	Yes	Yes	Yes	Yes
Pseudo R^2	0.3405	0.3877		
Log Likelihood	254.0173	263.7988	-13.8921	-13.9066
N	257	257	257	257

Note: This table examines the relationship between two level of disagreement measures constructed respectively from members' speech data and FOMC meeting transcripts. $S_i^{speech,in}$ measures the level of disagreement within speeches delivered right before a certain FOMC meeting, here we use the chair's FOMC meeting transcript as the anchor. For other variables, please refer to [Table 7](#) for their definitions. The sample period starts from the FOMC meeting on the February meeting in 1986 (when the Tealbook core CPI first becomes available) and ends on the December meeting in 2017. *** $p < 0.01$; ** $p < 0.05$; * $p < 0.1$

Table 10: Predicting Disagreement Scores with Speeches II (Meeting-level)

	S_i (<i>Beta</i>)		V_i (<i>Fractional Logistic</i>)	
	(1)	(2)	(3)	(4)
$S_i^{speech,pre}$	0.0647 (0.2660)	-0.0161 (0.2599)	-0.6051 (2.3644)	-0.6588 (2.4115)
<u>Macro Factors</u>				
T_{unemp}		-0.4774* (0.2510)		-0.1854 (2.3556)
D_{unemp}		-0.1426 (0.0978)		-0.2937 (0.9718)
T_{CPI}		0.7312** (0.2951)		1.2324 (2.6745)
D_{CPI}		0.2116 (0.1994)		0.7289 (1.9557)
<u>Member Char.</u>				
P_{major}	-1.5186*** (0.3453)	-1.5862*** (0.4272)	-1.7073 (3.0425)	-1.4454 (3.9400)
E_{school}	0.6615* (0.3979)	0.8289** (0.4209)	1.1371 (3.6898)	0.7986 (4.0569)
Control Var.	Yes	Yes	Yes	Yes
Pseudo R^2	0.3028	0.3621		
Log Likelihood	205.5993	215.9260	-11.3487	-11.3639
N	211	211	211	211

Note: This table examines the relationship between two level of disagreement measures constructed respectively from members' speech data and FOMC meeting transcripts. $S_i^{speech,pre}$ measures the level of disagreement within speeches delivered right before a certain FOMC meeting, here we use the chair's latest public speech before the FOMC meeting as the anchor. For other variables, please refer to [Table 7](#) for their definitions. The sample period starts from the FOMC meeting on the February meeting in 1986 (when the Tealbook core CPI first becomes available) and ends on the December meeting in 2017. *** $p < 0.01$; ** $p < 0.05$; * $p < 0.1$

Table 11: Level of Disagreement and Summary of Economic Projections

	S_i			Residualized S_i	
	FFR	Macroeconomic Projections		DML	
	(1)	(2)	(3)	(4)	(5)
Policy _{PC1}	0.1478** (0.0644)				
Economy _{PC1}		0.0610** (0.0263)	0.0875*** (0.0331)		
Economy _{PC2}		0.0232 (0.0671)	-0.0248 (0.0635)		
Economy _{PC3}		-0.0241 (0.0736)	-0.0667 (0.0682)		
Residualized Policy _{PC1}				0.0325** (0.0151)	
Residualized Economy _{PC1}					-0.0110 (0.0131)
Pseudo R^2	0.2092	0.1402	0.2796		
N	25	36	25	25	25

Note: This table investigates the correlation between the extent of disagreement observed in meeting transcripts and that within the Summary of Economic Projections. Disagreement levels for each projection category are calculated as the absolute sum of deviations from the median projection, the same method employed by Foerster and Martinez (2023). These levels are subsequently categorized into two distinct groups: disagreement pertaining to current monetary policy, specifically Federal Funds Rate (FFR) projections, and disagreement related to the current state of the economy, encompassing other projection types. Principal component analysis is then applied to each group. Due to the availability of SEP data, the sample for the macroeconomic variables, which includes long-term projections, begins with the January 2009 meeting, whereas for the federal funds rate, it starts with the January 2012 meeting. Both samples conclude with the December 2017 meeting. In column (3), the sample of macroeconomic variables is maintained within the same period range as that of the federal funds rate sample. Column (4) and (5) show the results from the Double Machine Learning model. *** $p < 0.01$; ** $p < 0.05$; * $p < 0.1$

Table 12: Level of Disagreement and Optimal Policy Perturbation (Barnichon and Mesters (2023))

	OPP _{fr} (Abs.)	OPP _{shadow} (Abs.)	OPP _{slop} (Abs.)
Full OPP Sample			
S_i	0.5347*** (0.1280)	-0.0042 (0.2482)	-0.0144 (0.3555)
V_i	0.1595 (0.2344)	0.4375 (0.4137)	0.4009 (0.5436)
Adjusted R^2	0.4006	-0.0077	-0.0205
N	71	71	71
	OPP _{fr}	OPP _{shadow}	OPP _{slop}
Positive OPP Sample			
S_i	0.2588** (0.0955)	0.3279*** (0.1130)	0.5655*** (0.1544)
V_i	-0.0919 (0.1337)	-0.0601 (0.1564)	-0.2618 (0.2213)
Adjusted R^2	0.1815	0.2627	0.3416
N	30	22	25
Negative OPP Sample			
S_i	-0.6188** (0.2282)	0.0399 (0.2780)	0.2068 (0.4029)
V_i	-0.3973 (0.2398)	-0.2914 (0.4887)	-0.3808 (0.6006)
Adjusted R^2	0.3713	-0.0348	-0.0383
N	19	49	46
Negative OPP Sample, Excludes Zero-Bound Period			
S_i	-0.6188** (0.2282)	-0.7562*** (0.2420)	-0.9808*** (0.3368)
V_i	-0.3973 (0.2398)	-0.4475 (0.4856)	-0.4756 (0.5745)
Adjusted R^2	0.3713	0.4407	0.4061
N	19	27	24

Note: This table examines the relationship between the level of disagreement inside the FOMC meeting and the deviation from the optimal policy after the meeting. The deviation is measured by Optimal Policy Perturbation (OPP), a measure proposed by Barnichon and Mesters (2023). OPP_{fr} (OPP_{shadow}) denotes the deviation from the optimal Fed funds rate (shadow rate), and OPP_{slop} represents the deviation from the optimal slope of the yield curve. “Abs.” means absolute value. For other variables, please refer to Table 7 for their definitions. The sample period begins in 1980, coinciding with the availability of OPP data, and ends in 2017, aligning with the accessibility of transcript data. *** $p < 0.01$; ** $p < 0.05$; * $p < 0.1$

Appendices

[Appendix A](#) shows all the results that serve as the robustness checks for the main results in our paper.

[Appendix B](#) gives a brief introduction to the applications of Deep Learning methods in the natural language processing (NLP) field.

[Appendix C](#) shows the complete results for [Table 6](#) to [Table 10](#).

A Results for Robustness Checks



(a) Vote For, Full Sample

(b) Vote Against, Full Sample



(c) Vote For, Rate Unchanged



(d) Vote Against, Rate Unchanged



(e) Vote For, Rate Increases



(f) Vote Against, Rate Increases



(g) Vote For, Rate Decreases



(h) Vote Against, Rate Decreases

Figure A.1: The Word Cloud for Different Vote Groups

Note: This figure shows the word cloud plots for different vote groups and FOMC meeting policy actions. In these word cloud plots, both the gray shades and the sizes of these words represent their frequency in meeting transcripts.

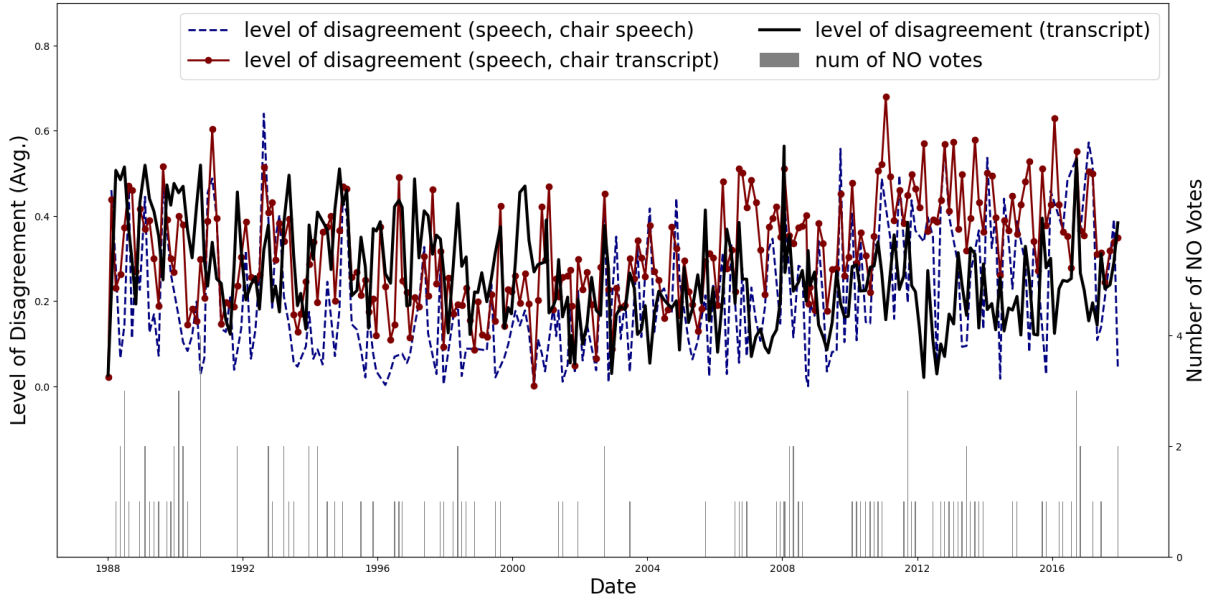

Figure A.2: Level of Disagreement in Speeches and Transcripts, Meeting Level

Note: The red dotted line and the blue dash line portray the level of disagreement within speeches using different reference points, by the average of speech disagreement scores in each meeting. Similarly, The black line represents the level of disagreement in transcripts and is measured using the same method. The bar chart shows the number of NO votes recorded in each meeting.

Table A.1: Level of Disagreement and Inverted Yield Curve Periods

	S_i		V_i	
	(1)	(2)	(3)	(4)
<u>Macro Factors</u>				
T_{unemp}	-0.5861** (0.2362)	-0.5537** (0.2297)	0.0498 (2.1163)	-0.0916 (2.0709)
D_{unemp}	-0.1724 (0.1426)	-0.1040 (0.0904)	0.0386 (1.3277)	-0.2178 (0.8777)
T_{CPI}	0.7001*** (0.2677)	0.6784** (0.2657)	1.2456 (2.4328)	1.3403 (2.4263)
D_{CPI}	0.2341 (0.1904)	0.1894 (0.1782)	0.7306 (1.8381)	0.8667 (1.7479)
$Diff_{Y2-Y10}$	-0.0403 (0.0755)		0.1601 (0.7349)	
$Dummy_{IYC}$		0.0259 (0.1176)		-0.1553 (1.1373)
<u>Member Char.</u>				
$D_{experience}$	0.0072 (0.0354)	0.0049 (0.0352)	0.0767 (0.3423)	0.0840 (0.3416)
D_{age}	0.0524** (0.0251)	0.0499** (0.0247)	0.0450 (0.2470)	0.0563 (0.2442)
$D_{SchoolWealth}$	0.0008 (0.2245)	0.0104 (0.2247)	-0.3096 (2.0938)	-0.3376 (2.0788)
P_{gender}	0.5070 (0.4640)	0.4154 (0.4354)	1.0342 (4.7125)	1.4940 (4.2529)
P_{major}	-1.3796*** (0.3636)	-1.3520*** (0.3653)	-1.2575 (3.4099)	-1.4049 (3.4208)
$E_{hometown}$	-0.3523 (0.3239)	-0.2911 (0.3174)	0.1586 (2.9305)	-0.1076 (2.9002)
E_{school}	1.2429*** (0.3496)	1.2059*** (0.3490)	0.9535 (3.3516)	1.0677 (3.3687)
E_{POTUS}	0.1928 (0.2089)	0.1455 (0.2020)	-0.8924 (1.9444)	-0.6907 (1.8384)
$Party_{Dem}$	0.1342 (0.1117)	0.1080 (0.1052)	0.3341 (1.1488)	0.4171 (1.1125)
$P_{depression}$	-0.0128 (0.4877)	-0.0427 (0.4839)	-0.0777 (4.8049)	-0.0106 (4.8066)
$P_{inflation}$	0.1841 (0.7049)	0.2389 (0.7288)	-0.4549 (6.9865)	-0.8761 (7.1981)
P_{WWII}	1.1796** (0.5084)	1.2242** (0.5221)	-0.9077 (4.8167)	-1.1547 (4.9006)
Pseudo R^2	0.3922	0.3911		
Log Likelihood	265.1570	265.0402	-14.0105	-14.0092
N	260	260	260	260

Note: This table examines the level of disagreement change during the inverted yield curve period. $Diff_{Y2-Y10}$ denotes the spread between 2-Year and 10-Year Treasury bonds. $Dummy_{IYC}$ indicates if the inverted yield curve is observed in current period. For other variables, please refer to [Table 7](#) for their definitions. *** $p < 0.01$; ** $p < 0.05$; * $p < 0.1$

Table A.2: Level of Disagreement and Uncertainty Indices

	S_i		V_i	
	(1)	(2)	(3)	(4)
<u>Macro Factors</u>				
T_{unemp}	-0.6690** (0.2845)	-0.5805** (0.2430)	-0.4402 (2.8365)	-0.0935 (2.1818)
D_{unemp}	-0.0824 (0.0923)	-0.1222 (0.0953)	-0.1307 (0.9603)	-0.2023 (0.9343)
T_{CPI}	0.6727** (0.3159)	0.6780** (0.2658)	1.5959 (2.9146)	1.3061 (2.4197)
D_{CPI}	0.3051 (0.2024)	0.1913 (0.1777)	1.3072 (2.0189)	0.8460 (1.7494)
VIX	0.0058 (0.0055)		0.0131 (0.0509)	
EPU		0.0004 (0.0013)		0.0005 (0.0114)
<u>Member Char.</u>				
$D_{experience}$	-0.0607 (0.0417)	0.0046 (0.0352)	0.0567 (0.4145)	0.0812 (0.3412)
D_{age}	-0.0052 (0.0318)	0.0506** (0.0246)	0.0029 (0.3258)	0.0546 (0.2439)
$D_{SchoolWealth}$	-0.1381 (0.2794)	0.0136 (0.2232)	-1.4445 (2.8225)	-0.3706 (2.0725)
P_{gender}	0.0856 (0.4701)	0.4153 (0.4352)	2.1962 (4.8395)	1.4651 (4.2513)
P_{major}	-1.5923*** (0.4386)	-1.3632*** (0.3612)	-0.2466 (4.1722)	-1.3391 (3.3869)
$E_{hometown}$	-0.9118** (0.3717)	-0.3182 (0.3135)	-0.1668 (3.4680)	-0.0363 (2.8429)
E_{school}	0.7331* (0.4072)	1.2117*** (0.3451)	-0.2154 (4.0921)	1.0102 (3.3504)
E_{POTUS}	0.2029 (0.2145)	0.1607 (0.1986)	-1.0679 (2.1147)	-0.7250 (1.8122)
$Party_{Dem}$	0.1038 (0.1161)	0.1139 (0.1046)	0.5217 (1.2948)	0.4071 (1.1123)
$P_{depression}$	-0.6997 (0.5525)	-0.0667 (0.4877)	-0.6071 (5.6401)	0.0102 (4.8165)
$P_{inflation}$	0.6239 (0.7541)	0.1960 (0.7046)	0.7130 (7.6669)	-0.6452 (6.9727)
P_{WWII}	1.8557*** (0.5774)	1.2166** (0.5138)	-0.0738 (5.6416)	-0.9956 (4.8081)
Pseudo R^2	0.3203	0.3911		
Log Likelihood	239.2219	265.0545	-11.2944	-14.0094
N	227	260	227	260

Note: This table examines the correlation between level of disagreement and uncertainty. VIX denotes the CBOE Volatility Index. EPU is the U.S. Economic Policy Uncertainty Index and we match this monthly data to the nearest FOMC meeting. For other variables, please refer to [Table 7](#) for their definitions.

*** $p < 0.01$; ** $p < 0.05$; * $p < 0.1$

Table A.3: Explanation Power of the Level of Disagreement in Speeches (Selected Members)

	S_i		V_i	
	(1)	(2)	(3)	(4)
$S_i^{speech,in}$	0.6739** (0.3068)	0.5800* (0.2971)	1.3003 (2.6502)	0.9431 (2.7126)
<u>Macro Factors</u>				
T_{unemp}		-0.2131 (0.2658)		-1.1196 (2.8219)
D_{unemp}		-0.0138 (0.1011)		0.1716 (0.9215)
T_{CPI}		1.1031*** (0.3059)		0.6144 (2.9318)
D_{CPI}		0.7036*** (0.2525)		1.6313 (2.9183)
<u>Member Char.</u>				
$D_{experience}$	0.0290 (0.0359)	0.0368 (0.0372)	-0.0108 (0.3280)	0.0659 (0.3637)
D_{age}	-0.0165 (0.0270)	-0.0217 (0.0266)	-0.0932 (0.2703)	-0.0818 (0.2807)
$D_{SchoolWealth}$	-0.4419** (0.1830)	-0.2942 (0.1858)	-1.9114 (1.8862)	-1.7527 (2.1097)
P_{gender}	0.5544 (0.3724)	0.4149 (0.3755)	4.2695 (3.9964)	3.5698 (4.2099)
P_{major}	-0.4999 (0.3302)	-0.1424 (0.3464)	-0.1916 (3.2448)	0.5462 (3.6516)
$E_{hometown}$	-1.0204*** (0.2997)	-0.9461*** (0.2991)	-1.6764 (2.9579)	-1.7622 (3.1478)
E_{school}	0.5846** (0.2829)	0.5802** (0.2768)	2.5125 (3.3496)	2.0724 (3.4485)
E_{POTUS}	-0.2512 (0.1647)	-0.0410 (0.1731)	-1.0115 (1.4779)	-0.4801 (1.7727)
$Party_{Dem}$	0.2988*** (0.1005)	0.3659*** (0.1119)	0.1914 (1.0651)	0.4888 (1.3395)
$P_{depression}$	-1.8651*** (0.5227)	-1.6540*** (0.5157)	-4.9775 (5.4707)	-5.9812 (5.9882)
$P_{inflation}$	-0.7865 (0.6079)	-0.4729 (0.6096)	-1.5270 (6.0594)	-1.9258 (6.5095)
P_{WWII}	1.3265*** (0.4021)	1.1160*** (0.4003)	1.8068 (3.8307)	1.4660 (3.9991)
Pseudo R^2	0.2937	0.3598		
Log Likelihood	177.8872	187.8635	-9.7112	-9.6325
N	190	190	190	190

Note: This table examines the relationship between two level of disagreement measures constructed respectively from members' speech data and FOMC meeting transcripts. Data used here only contains FOMC members who gave speeches before meetings. $S_i^{speech,in}$ measures the level of disagreement within speeches delivered right before a certain FOMC meeting, using chair's meeting transcripts as the reference point. For other variables, please refer to [Table 7](#) for their definitions. *** $p < 0.01$; ** $p < 0.05$; * $p < 0.1$

Table A.4: Level of Disagreement and FOMC Economic Projections

	FFR (1)	S_i Macro Variable Projections	
		(2)	(3)
Policy _{PC1}	0.2003*** (0.0663)		
Economy _{PC1}		0.0599** (0.0261)	0.0873*** (0.0330)
Economy _{PC2}		-0.0128 (0.0689)	-0.0203 (0.0660)
Economy _{PC3}		0.0320 (0.0754)	-0.0539 (0.0710)
Pseudo R^2	0.3099	0.1389	0.2724
N	25	36	25

Note: Similar to [Table 11](#). In this table, disagreement levels for each projection category are calculated using the absolute sum of deviations from the mean projection, instead of the median projection. *** $p < 0.01$; ** $p < 0.05$; * $p < 0.1$

B A Brief Introduction of Deep Learning in NLP

In earlier natural language processing (NLP) models, researchers often rely on manually crafted features to project text data into low-dimensional feature vectors. One representative example is the Bag of Words method. Researchers need to have sufficient domain knowledge to pick out the most relevant features, which can be time-consuming and difficult to generalize. And these NLP models typically neglect intricate interconnections between different words and sentences within an article.. [Gentzkow et al. \(2019\)](#) note that, the emergence of new machine learning models for NLP in computer science offers novel solutions for addressing certain economic challenges. In recent years, Deep Learning models have advanced rapidly and enabled us to surmount the constraints of previous-generation NLP models. Moreover, the introduction of Transfer Learning allows us to pre-train a complex model on extensive datasets, so we can achieve high prediction accuracy even if the target dataset is small.

The root of Deep Learning can be traced back to 1943 when Walter Pitts and Warren McCulloch created the first neural network model based on the neural networks of the human brain. Until recently, the commonly used Deep Learning models in text classification can be broadly categorized into two groups: Convolutional Neural Network (CNN) and Recurrent Neural Network (RNN) models.¹⁶ In text classification tasks, CNN models excel in detecting position-related patterns within text, while RNN models, particularly the Long Short-Term Memory (LSTM) model, exhibit robust performance in training with lengthy text. By introducing the Gated Recurrent Unit (GRU), LSTM can effectively address the vanishing gradients problem in long text classification tasks([Minaee et al., 2021](#)).

Nevertheless, both CNN and RNN models exhibit inherent limitations. RNN’s sequential processing impedes parallel computing, leading to prolonged model training durations compared to CNN models. Conversely, while CNN models is well suited for parallel computing, pooling operations within CNN models may inadvertently neglect important spatial relationships among text segments. To mitigate the above problems, a novel model called Transformer is introduced and is attracting increasing attention in the deep learning community.

In their seminal paper, [Vaswani et al. \(2017\)](#) introduced the Transformer model, with the Self-Attention module being its pivotal component. The basic idea behind the Self-attention module is illustrated in [Figure B.1](#) and can be distilled as follows: the original input is fed into three different dense layers to generate three different datasets Query, Key and, Value. The Query and Key sets are used to calculate which part of the original input should be paid more attention to, then these attention weights are applied to the Value set to extract the

¹⁶There are other equally important deep learning models like MLP, Autoencoder, GAN, etc. However, to our best knowledge, they are less solely used in text classification tasks.

salient features that deserve the most attention. The Self-attention module can be written as:

$$\text{Self-attention}(Q,K,V) = \text{softmax}\left(\frac{QK^T}{\sqrt{d}}\right)V$$

where d is the dimension of the vector used to represent one token.

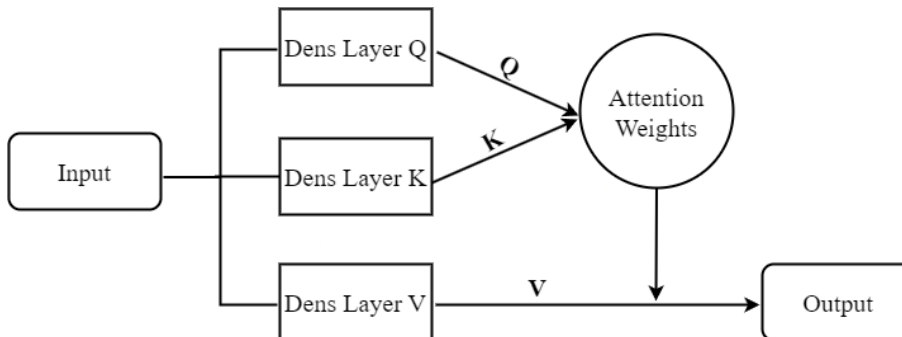

Figure B.1: Self-attention module

Note: This figure shows the basic idea behind the Self-attention module. In the Self-attention module, V , Q , and K are transformed from the same input and usually they have the same shape.

In contrast to CNN and RNN models, the Self-attention module can capture long-distance spatial relationships within text component without worrying about the vanishing gradient problem. Meanwhile, the Self-attention module can utilize parallel computing easily and harness the immense computational power of modern GPUs and TPUs. Furthermore, the Self-attention module is versatile and can be integrated seamlessly with other modules to build more complex deep learning models for specific tasks. All these advantages of the Self-attention module make it quickly become one of the well-received innovations in the deep learning research field.

Prior to the introduction of the Transformer model, earlier NLP models that utilized the Self-attention module still used RNNs for input representations (Cheng et al., 2016; Paulus et al., 2017). The Transformer model stands as the first model solely based on the Self-attention modules, forgoing the need for convolutional or recurrent layers. Since its inception, the Transformer model swiftly becomes the premier choice for NLP tasks, and myriad NLP models are built on the Transformer structure. Though the Transformer model was originally proposed to compete with other seq2seq models, it has been proven to be versatile and can be used in a wide range of modern deep learning applications. For example, the word embedding model employed in this paper is built on the encoder component of the Transformer model.

One of the most influential Transformer-based models is the Bidirectional Encoder Repe-

sentations from Transformers (BERT) model built by [Devlin et al. \(2018\)](#).¹⁷ BERT is a pre-trained large language model, and it is trained on Wikipedia and BooksCorpus, collectively encompassing approximately 3.3 billion words. Not surprised, BERT obtains state-of-the-art results on multiple mainstream NLP tasks.

BERT’s exceptional performance hinges on its bidirectional feature. Human languages are complex, and one word usually has multiple different meanings. Traditional NLP methods like Bag of Words, treats a word such as “run” identically across different contexts. For example, in the following Sentence 1 and Sentence 2, the word “runs” has different meanings, but the Bag of Words algorithm lacks the capacity to distinguish these meanings based solely on the isolated word. One remedy is adopting the n-gram model, which takes the n neighboring words into consideration. However, the vocabulary size in the n-gram method grows exponentially with the value of n, which can lead to high computational costs. Furthermore, this method still cannot capture the long-distance semantic relationships between words. Later on, deep learning methods, like seq2seq, are introduced into the NLP field, and these language models can capture the underlying context and treat the “run” differently. However, due to the autoregressive nature, many such models exclusively process text from left to right, so when the algorithm encounters examples like sentence 3 and sentence 4, the word “bank” will be treated as the same in both instances because the context these models can learn from is the same word “The”. The BERT model, however, operates bidirectionally, and can use the context after the “bank” word to distinguish word meanings in different scenarios. So the word “bank” can be treated differently in the BERT model as it should be.

Sentence 1: *This is a relatively small number, and it suggests that the snapback when the liquidation finally **runs** its course potentially will be only modest.* (FOMC Conference Call, April 18, 2001, Chair Greenspan)

Sentence 2: *You would probably have massive bank **runs**, and the whole system would shut down.* (FOMC Meeting, June 19-20, 2012, Vice Chair Dudley)

Sentence 3: *The **bank** money is coming in slowly, though not for the full amount, and the IMF money is going ahead.* (FOMC Meeting, December 20-21, 1982, Vice Chair Solomon)

Sentence 4: *The **bank** of the Hudson River in New York is a popular spot for fishing.*

Another advantage of using large language models like BERT is that we can benefit from transfer learning. Transfer learning is a machine learning technique that involves using a pre-trained model on a new problem. This technique allows us to leverage the knowledge and features learned by the pre-trained model and apply them to a different but related problem

¹⁷Another influential NLP model built on Transformer is Generative Pre-training Transformer (GPT), which is the backbone of Chat-GPT application.

that has less data or computational resources. Usually, there are two ways to use BERT: Feature-based approach and Fine-tuning approach. The Feature-based approach does not change the weights in the pre-trained BERT model, and it uses BERT to translate natural language sentences into vector representations, which serve as input for a subsequent deep learning model tailored to a specific NLP task. Fine-tuning approach changes part of the pre-trained BERT model weights to make it more suitable for a particular NLP task.

In this study, we take the first approach and use the BERT model directly for word embedding, and the vectorized text content will be the input for a customized deep learning model. Word embedding represent words as vectors of real numbers but still capture these words' meaning and semantic relationships. However, there is one caveat on applying word embedding on a long transcript document: most off-the-shelf pre-trained BERT models can only process up to 512 tokens at a time. This limitation stems from the quadratic complexity ($O(n^2)$) of the self-attention layer in BERT concerning sequence length (n). Imposing this token cap prevents excessive memory consumption and computational overheads. There are several strategies that are commonly used to circumvent the limitation: (1) selectively processing the most informative portions of the text to alleviate computational burdens. For example, [Chen et al. \(2022\)](#) choose to process the beginning and end of news articles to extract the most informative texts. (2) dividing the original text into segments and processing them individually, as pursued by [Wang et al. \(2019\)](#). (3) introducing modified transformer models to accommodate longer texts ([Rae et al., 2019](#); [Kitaev et al., 2020](#); [Ding et al., 2020](#)).

Selectively processing certain parts of a long text may work well for news articles that have a well-defined structure to rely on and can easily extract the most informative section. However, this method may not be suitable for meeting transcripts because we do not have a sound foundation to reason that a certain part of the transcript is more informative than the rest. Dividing the original text into chunks also creates another challenge: how to treat the different chunks? First potential solution is to label all the chunks based on the vote results. However, this approach is not ideal given that, during the meeting discussion and some member voted NO, it is hard to argue that these FOMC members disagree on every sentence. A highly likely scenario is that members agree on most of the meeting discussion but disagree on select portions. Simply labeling all the chunks based on the final vote result risks misclassification and reduced predictive accuracy. Second potential solution is to concatenate the vectors from different chunks. Given that each word is converted into a 1×768 vector. Yet, this approach can generate a huge matrix for each lengthy text and impose significant computational overhead. Another potential solution is to average vector values of these chunks and generate a 512×768 matrix as the word embedding of the whole transcript. The model, Sentence-BERT (SBERT), used in this paper is adopted from this

idea. However, benefiting from pre-training on large amounts of text, the specific model used in our paper is fine-tuned to be suitable for deriving a fixed sized embedding not on word level but sentence level.

Appendix References

- X. Chen, P. Cong, and S. Lv. A long-text classification method of chinese news based on bert and cnn. *IEEE Access*, 10:34046–34057, 2022.
- J. Cheng, L. Dong, and M. Lapata. Long short-term memory-networks for machine reading. *arXiv preprint arXiv:1601.06733*, 2016.
- J. Devlin, M.-W. Chang, K. Lee, and K. Toutanova. Bert: Pre-training of deep bidirectional transformers for language understanding. *arXiv preprint arXiv:1810.04805*, 2018.
- M. Ding, C. Zhou, H. Yang, and J. Tang. Coglitx: Applying bert to long texts. *Advances in Neural Information Processing Systems*, 33:12792–12804, 2020.
- M. Gentzkow, B. Kelly, and M. Taddy. Text as data. *Journal of Economic Literature*, 57(3): 535–74, 2019.
- N. Kitaev, L. Kaiser, and A. Levskaya. Reformer: The efficient transformer. *arXiv preprint arXiv:2001.04451*, 2020.
- S. Minaee, N. Kalchbrenner, E. Cambria, N. Nikzad, M. Chenaghlu, and J. Gao. Deep learning-based text classification: a comprehensive review. *ACM computing surveys (CSUR)*, 54(3):1–40, 2021.
- R. Paulus, C. Xiong, and R. Socher. A deep reinforced model for abstractive summarization. *arXiv preprint arXiv:1705.04304*, 2017.
- J. W. Rae, A. Potapenko, S. M. Jayakumar, and T. P. Lillicrap. Compressive transformers for long-range sequence modelling. *arXiv preprint arXiv:1911.05507*, 2019.
- A. Vaswani, N. Shazeer, N. Parmar, J. Uszkoreit, L. Jones, A. N. Gomez, L. Kaiser, and I. Polosukhin. Attention is all you need. *Advances in neural information processing systems*, 30, 2017.
- Z. Wang, P. Ng, X. Ma, R. Nallapati, and B. Xiang. Multi-passage bert: A globally normalized bert model for open-domain question answering. *arXiv preprint arXiv:1908.08167*, 2019.

C Results for Personal Characteristics

Table C.1: Explaining Disagreement Scores and Dissents (Individual-level)

	s_{ij} (Mixed Effects Beta)			v_{ij} (Mixed Effects Probit)		
	(1)	(2)	(3)	(4)	(5)	(6)
$s_{ij}^{speech,in}$		0.4479*** (0.1165)			0.4483*** (0.1738)	
$s_{ij}^{speech,pre}$			0.2798* (0.1397)			0.2788* (0.1569)
Member Char.						
T_{unemp}	0.0305 (0.1294)	0.1006 (0.1714)	0.1085 (0.1778)	0.0285 (0.1542)	0.0547 (0.1751)	0.0135 (0.1944)
D_{unemp}	-0.0975* (0.0467)	-0.0851 (0.0658)	-0.0834 (0.0699)	0.1291 (0.1340)	0.3750* (0.1968)	0.2823 (0.2047)
$TCPI$	1.0382*** (0.1447)	1.0484*** (0.2310)	1.1219*** (0.2389)	0.1394 (0.1204)	0.1146 (0.1862)	0.1252 (0.2019)
$DCPI$	0.4483*** (0.1030)	0.6504*** (0.1884)	0.6490*** (0.1972)	0.2342 (0.2230)	0.9875*** (0.2886)	1.0089*** (0.3069)
Macro Factors						
Experience	0.0037 (0.0118)	0.0079 (0.0150)	0.0103 (0.0158)	0.4367* (0.2341)	0.7934*** (0.2887)	0.7579*** (0.2904)
Age	-0.0199 (0.0115)	-0.0170 (0.0135)	-0.0142 (0.0142)	-0.5017 (0.3985)	-0.7596* (0.4447)	-0.5724 (0.4472)
School Wealth	-0.1406 (0.0948)	-0.1414 (0.1002)	-0.1527 (0.1054)	-0.2280 (0.4127)	-0.0579 (0.4041)	-0.2009 (0.3988)
Female	0.0281 (0.1916)	0.1271 (0.2080)	0.1013 (0.2190)	0.0629 (0.8198)	1.0723 (0.7850)	1.2488* (0.7531)
Econ Major	-0.0552 (0.1613)	-0.0440 (0.1776)	-0.0305 (0.1866)	-0.1172 (0.6641)	-0.2204 (0.6639)	-0.0487 (0.6843)
Hometown NE	-0.2703 (0.2139)	-0.2561 (0.2433)	-0.2698 (0.2568)	-1.3036 (0.8635)	-1.4243* (0.8427)	-1.5015* (0.7814)
Hometown OTH	0.2537 (0.3449)	0.1077 (0.3834)	0.1501 (0.4046)	0.7059 (1.4025)	-1.3094 (1.9008)	-1.6412 (2.1056)
Hometown South	0.0923 (0.2351)	0.0850 (0.2602)	0.0762 (0.2749)	0.8486 (0.8955)	1.0407 (0.9870)	0.8776 (0.9286)
Hometown West	0.2563 (0.3039)	0.0395 (0.3555)	0.0349 (0.3736)	2.5621** (1.1903)	-0.1352 (1.5065)	-0.5844 (1.4874)
School NE	-0.3547 (0.2337)	-0.3163 (0.2595)	-0.2821 (0.2726)	-1.9336** (0.9199)	-2.3597** (0.9627)	-2.1627** (0.9132)
School South	-0.7555** (0.2374)	-0.7591** (0.2498)	-0.7673** (0.2639)	-3.9632*** (1.0654)	-3.9076*** (1.1456)	-4.4298*** (1.3206)
School West	0.0621 (0.3072)	0.3376 (0.3593)	0.3780 (0.3763)	-1.5127 (1.2335)	-0.4982 (1.3628)	0.0990 (1.2691)
Appt. Dem.	-0.0386 (0.1486)	0.0315 (0.1677)	0.0139 (0.1759)	-0.7303 (0.5985)	-0.8047 (0.6076)	-0.8459 (0.5727)
Incumbent Dem.	0.2902*** (0.0505)	0.3237*** (0.0763)	0.3572*** (0.0814)	0.2881 (0.2913)	0.1375 (0.4772)	0.3901 (0.5137)
Great Depression	0.6822** (0.2429)	0.3002 (0.2991)	0.3223 (0.3166)	1.1627 (1.0267)	-1.1265 (1.0941)	-0.8800 (1.0727)
Great Inflation	0.1082 (0.3253)	-0.3548 (0.3873)	-0.3210 (0.4104)	0.0531 (1.4239)	-2.1509 (1.9725)	-2.1462 (2.3354)
WWII	0.0206 (0.2644)	-0.1696 (0.3215)	-0.1838 (0.3378)	-1.1607 (1.1852)	-2.2520 (1.8376)	-2.7549 (2.1545)
Log Likelihood	1591.3	823.3	745.3	-390.9778	-164.3621	-140.2468
N	2,478	1,185	1,060	2,478	1,185	1,060

Note: This table considers variables that may correlate with the disagreement and dissents. Mixed effect regressions is clustered on FOMC member's level. The variable "Incumbent Dem." equals one if the sitting POTUS during a meeting is a Democrat. The variable "Incumbent Dem." is explained in Table 2. *** $p < 0.01$; ** $p < 0.05$; * $p < 0.1$

Table C.2: Explaining Disagreement Scores and Dissents (Meeting-level)

	S_i (<i>Beta</i>)		V_i (<i>Fractional Logistic</i>)	
	(1)	(2)	(3)	(4)
<u>Macro Factors</u>				
T_{unemp}	-0.5609** (0.2233)	-0.5572** (0.2289)	-0.2183 (1.8834)	-0.0619 (2.0598)
D_{unemp}	0.0515 (0.0663)	-0.1106 (0.0857)	0.3873 (0.5551)	-0.1842 (0.8436)
T_{CPI}	1.1307*** (0.2349)	0.6809** (0.2656)	1.3268 (1.9416)	1.3119 (2.4166)
D_{CPI}	0.6696*** (0.0827)	0.1925 (0.1777)	0.5545 (0.6754)	0.8508 (1.7466)
<u>Member Char.</u>				
$D_{experience}$		0.0048 (0.0352)		0.0815 (0.3413)
D_{age}		0.0502** (0.0246)		0.0542 (0.2439)
$D_{SchoolWealth}$		0.0156 (0.2230)		-0.3649 (2.0706)
P_{gender}		0.4165 (0.4353)		1.4712 (4.2519)
P_{major}		-1.3640*** (0.3613)		-1.3409 (3.3902)
$E_{hometown}$		-0.3048 (0.3100)		-0.0210 (2.8282)
E_{school}		1.2158*** (0.3448)		1.0184 (3.3491)
E_{POTUS}		0.1548 (0.1979)		-0.7320 (1.8068)
$Party_{Dem}$		0.1111 (0.1043)		0.4018 (1.1066)
$P_{depression}$		-0.0486 (0.4835)		0.0343 (4.7923)
$P_{inflation}$		0.1958 (0.7046)		-0.6311 (6.9615)
P_{WWII}		1.1967** (0.5084)		-1.0130 (4.7917)
Pseudo R^2	0.2334	0.3912		
Log Likelihood	233.4308	265.0157	-13.9574	-14.0092
N	260	260	260	260

Note: This table examines factors that may correlate with the level of disagreement and dissents. The level of disagreement, S_i , is quantified as the average of disagreement scores, and the dissents, V_i , is measured as the percentage of NO votes within a meeting. T_x is the trend of variable x , D_x in the macro-variable section means the s.d. of variable x calculated from the past and forecast values in Tealbooks. And in the characteristics section, D_x means the s.d. of the variable x in one meeting. E_x measure the entropy of variable x . P_{gender} represents the percentage of females in the FOMC meeting, P_{major} denotes the percentage of FOMC members whose highest degree is in econ-related field, and $Party_{Dem}$ denotes the party of the sitting president is Democrat. Robust standard errors are reported in all results. *** $p < 0.01$; ** $p < 0.05$; * $p < 0.1$

Table C.3: Predicting the Level of Disagreement Using Speeches (Meeting-level)

	S_i (<i>Beta</i>)		V_i (<i>Fractional Logistic</i>)	
	(1)	(2)	(3)	(4)
$S_i^{speech,in}$	0.6548** (0.2623)	0.4703* (0.2589)	1.4231 (2.4399)	1.2682 (2.5015)
<u>Macro Factors</u>				
T_{unemp}		-0.4951** (0.2292)		0.1177 (2.1083)
D_{unemp}		-0.0980 (0.0861)		-0.1427 (0.8476)
T_{CPI}		0.6727** (0.2674)		1.2540 (2.4724)
D_{CPI}		0.2105 (0.1789)		0.7973 (1.7548)
<u>Member Char.</u>				
$D_{experience}$	-0.0462 (0.0343)	-0.0086 (0.0356)	-0.0162 (0.3189)	0.0583 (0.3463)
D_{age}	0.0346 (0.0266)	0.0308 (0.0264)	0.0516 (0.2571)	0.0414 (0.2609)
$D_{SchoolWealth}$	-0.3022 (0.2192)	-0.0962 (0.2359)	-0.5599 (1.9618)	-0.3618 (2.1914)
P_{gender}	0.4235 (0.4069)	0.3866 (0.4319)	1.4221 (3.9770)	1.4045 (4.2994)
P_{major}	-1.2293*** (0.2970)	-1.2719*** (0.3647)	-1.7756 (2.6790)	-1.2350 (3.4450)
$E_{hometown}$	-0.1553 (0.3195)	-0.4631 (0.3260)	0.1619 (2.8252)	-0.0376 (2.9703)
E_{school}	0.8631** (0.3451)	0.9830*** (0.3613)	1.0864 (3.3207)	0.6390 (3.5623)
E_{POTUS}	0.1287 (0.1976)	0.1085 (0.1971)	-0.9105 (1.7451)	-0.7781 (1.8285)
$P_{PartyDem}$	0.1209 (0.0891)	0.1064 (0.1036)	0.0790 (0.8858)	0.3732 (1.1016)
$P_{depression}$	-0.3668 (0.4874)	-0.1486 (0.4796)	-0.3690 (4.7795)	-0.2174 (4.8237)
$P_{inflation}$	0.1004 (0.6895)	0.3972 (0.7068)	-0.7291 (6.7575)	-0.4606 (7.0507)
P_{WWII}	1.5191*** (0.5030)	1.4646*** (0.5173)	0.0497 (4.8621)	-0.5206 (4.9558)
Pseudo R^2	0.3405	0.3877		
Log Likelihood	254.0173	263.7988	-13.8921	-13.9066
N	257	257	257	257

Note: This table examines the relationship between two level of disagreement measures constructed respectively from members' speech data and FOMC meeting transcripts. $S_i^{speech,in}$ measures the level of disagreement within speeches delivered right before a certain FOMC meeting, here we use the chair's FOMC meeting transcript as the anchor. For other variables, please refer to [Table 7](#) for their definitions. *** $p < 0.01$; ** $p < 0.05$; * $p < 0.1$

Table C.4: Predicting the Level of Disagreement Using Speeches (Meeting-level)

	S_i (<i>Beta</i>)		V_i (<i>Fractional Logistic</i>)	
	(1)	(2)	(3)	(4)
$S_i^{speech,pre}$	0.0647 (0.2660)	-0.0161 (0.2599)	-0.6051 (2.3644)	-0.6588 (2.4115)
<u>Macro Factors</u>				
T_{unemp}		-0.4774* (0.2510)		-0.1854 (2.3556)
D_{unemp}		-0.1426 (0.0978)		-0.2937 (0.9718)
T_{CPI}		0.7312** (0.2951)		1.2324 (2.6745)
D_{CPI}		0.2116 (0.1994)		0.7289 (1.9557)
<u>Member Char.</u>				
$D_{experience}$	-0.0769* (0.0405)	-0.0245 (0.0418)	-0.0611 (0.3557)	0.0521 (0.3989)
D_{age}	-0.0038 (0.0336)	-0.0032 (0.0331)	0.0576 (0.3252)	0.0507 (0.3319)
$D_{SchoolWealth}$	-0.5104** (0.2445)	-0.2968 (0.2627)	-1.2556 (2.0934)	-1.0665 (2.3531)
P_{gender}	0.5381 (0.4769)	0.5309 (0.4934)	2.5899 (4.5522)	2.5149 (4.8251)
P_{major}	-1.5186*** (0.3453)	-1.5862*** (0.4272)	-1.7073 (3.0425)	-1.4454 (3.9400)
$E_{hometown}$	-0.5192 (0.3851)	-0.8459** (0.3813)	0.5061 (3.2999)	0.0312 (3.4384)
E_{school}	0.6615* (0.3979)	0.8289** (0.4209)	1.1371 (3.6898)	0.7986 (4.0569)
E_{POTUS}	0.0615 (0.2157)	0.0321 (0.2123)	-0.9995 (1.8816)	-0.9249 (1.9678)
$P_{PartyDem}$	0.1565 (0.0990)	0.1723 (0.1217)	0.0679 (0.9264)	0.4480 (1.3167)
$P_{depression}$	-0.7206 (0.5982)	-0.4745 (0.5936)	-0.3715 (5.6879)	-0.3123 (5.8779)
$P_{inflation}$	0.0540 (0.7844)	0.2881 (0.8004)	0.0428 (7.2386)	0.0661 (7.8497)
P_{WWII}	1.6212*** (0.5962)	1.5024** (0.6062)	0.3393 (5.4090)	-0.2966 (5.7008)
Pseudo R^2	0.3028	0.3621		
Log Likelihood	205.5993	215.9260	-11.3487	-11.3639
N	211	211	211	211

Note: This table examines the relationship between two level of disagreement measures constructed respectively from members' speech data and FOMC meeting transcripts. $S_i^{speech,pre}$ measures the level of disagreement within speeches delivered right before a certain FOMC meeting, here we use the chair's latest public speech before the FOMC meeting as the anchor. For other variables, please refer to [Table 7](#) for their definitions. *** $p < 0.01$; ** $p < 0.05$; * $p < 0.1$