

Bengali Fake Reviews: A Benchmark Dataset and Detection System

G M Shahriar^{*1}, Md. Tanvir Rouf Shawon¹, Faisal Muhammad Shah, Mohammad Shafiul Alam and Md. Shahriar Mahbub

Ahsanullah University of Science and Technology, Dhaka, Bangladesh

ARTICLE INFO

Keywords:

Bengali Fake Reviews Detection
Ensemble Learning
Transformers
Deep Learning
Augmentation
Transliteration

ABSTRACT

The proliferation of fake reviews on various online platforms has created a major concern for both consumers and businesses. Such reviews can deceive customers and cause damage to the reputation of products or services, making it crucial to identify them. Although the detection of fake reviews has been extensively studied in English language, detecting fake reviews in non-English languages such as Bengali is still a relatively unexplored research area. The novelty of the study unfolds on three fronts: i) a new publicly available dataset called Bengali Fake Review Detection (BFRD) dataset is introduced, ii) a unique pipeline has been proposed that translates English words to their corresponding Bengali meaning and also back transliterates Romanized Bengali to Bengali, iii) a weighted ensemble model that combines four pre-trained transformers model is proposed. The developed dataset consists of 7710 non-fake and 1339 fake food-related reviews collected from social media posts. Rigorous experiments have been conducted to compare multiple deep learning and pre-trained transformer language models and our proposed model to identify the best-performing model. According to the experimental results, the proposed ensemble model attained a weighted F1-score of 0.9843 on a dataset of 13,390 reviews, comprising 1,339 actual fake reviews, 5,356 augmented fake reviews, and 6,695 reviews randomly selected from the 7,710 non-fake instances.

1. Introduction

Online reviews are written comments or assessments posted on websites, social media, or other digital platforms by individuals to convey their views about a product, service, or experience (Duan, Gu and Whinston, 2008; Luca, 2015). Consumers depend extensively on reviews when making purchasing decisions, arranging vacation, picking restaurants, and selecting service providers (Ha, Bae and Son, 2015). Online reviews can also have a significant impact on businesses (Luca, 2016; Nisen). Positive reviews can boost a company's reputation, increase their visibility, and lead to increased sales. Negative reviews, on the other hand, can damage a company's reputation and result in lost business. For these reasons, many companies actively monitor and respond to reviews in an effort to manage their online reputation. However, with the rise of online reviews, there has also been an increase in fake reviews.

Reviews that do not come from actual consumers and are written with the intention of influencing how a product or service is perceived online are generally known as fake/spam reviews (Jindal and Liu, 2007). Fake reviews can be created by employees or associates of a business to artificially boost the ratings or reputation of their services or products, by rival businesses or dissatisfied clients to damage the reputation of a company's products or services, or by people who have never used the goods or services but have been paid to write favorable reviews (Mukherjee, Liu and Glance, 2012). Consumers might be misled by fraudulent reviews, which lowers the credibility of all online reviews which is why fake review detection is important. While some nations have passed legislation to control online reviews and prevent the spread of false reviews, many platforms have implemented procedures to identify and eliminate fake reviews in an effort to solve this issue (Luca and Zervas, 2016; Mukherjee, Venkataraman, Liu and Glance, 2013a).

Fake review detection is a complex task due to several reasons including the sophisticated techniques used by those who create fake reviews, the large volume of reviews posted on popular platforms, the diverse types of reviews, and the challenge of distinguishing genuine reviews that may sound similar to one another (Salminen, Kandpal, Kamel, Jung and Jansen, 2022). There are also linguistic challenges (Rao, Verma and Bhatia, 2021) such as language dependence, slang and colloquial language, grammatical errors, and the need for accurate sentiment and contextual

^{*}Corresponding author

✉ sshibli745@gmail.com (G.M. Shahriar); shawontanvir.cse@aust.edu (Md.T.R. Shawon); faisal.cse@aust.edu (F.M. Shah); shafiul.cse@aust.edu (M.S. Alam); shahriar.cse@aust.edu (Md.S. Mahbub)

¹These authors contributed equally to this work.

analysis. Machine learning is a reliable approach to identify fake reviews as it can examine various factors including the length of the review, its sentiment, and the structure of sentences, patterns and keywords. Over time, many research studies have been conducted on detecting fake reviews. These include traditional machine learning methods (Banerjee, Chua and Kim, 2015; Jindal and Liu, 2008; Mukherjee, Venkataraman, Liu, Gance et al., 2013b; Ott, Choi, Cardie and Hancock, 2011), deep learning techniques (Li, Ren, Qin and Liu, 2015; Wang, Liu and Zhao, 2018b; Zhao, Xu, Liu, Guo and Yun, 2018), hybrid and transformer models (Dhamani, Azunre, Gleason, Corcoran, Honke, Kramer and Morgan, 2019; Gupta, Gandhi and Chakravarthi, 2021; Shahariar, Biswas, Omar, Shah and Binte Hassan, 2019; Zhang, Du, Yoshida and Wang, 2018)

Bengali is spoken by approximately 272.7 million individuals and ranks seventh on the list of most spoken languages globally (Wikipedia), but it is still viewed as a language with limited resources. More than forty five million people use Bengali for textual communication every day on social media platforms like Facebook and YouTube (Sharif and Hoque, 2022). There might be various reasons why individuals utilize social media (i.e. Facebook) posts or groups to write both authentic and false reviews in Bengali. One explanation is that Facebook is a prominent site with a huge user base in Bangladesh, thus it gives a quick and accessible option to exchange reviews with others. Also, people may feel more at ease writing and sharing evaluations in Bengali, which may not be supported by other review services.

However, the development of fake review detection methods in languages other than English, such as Bengali, is still limited due to the challenges posed by the language's low resource status. There is a shortage of data sets and linguistic resources for Bengali, making it difficult to create effective language processing tools and models. Furthermore, the lack of standardization in the language and variation in language use across different dialects make the development of such tools more complicated.

In this study, we introduce the Bengali Fake Review Detection (BFRD) dataset that focuses on food-related reviews in Bengali language. To create this dataset, we collected food-related reviews written in Bengali from social media groups and posts and carefully annotated them as fake or non-fake using expert annotators with some predefined criteria. To the best of our knowledge, we are presenting the first publicly accessible dataset for identifying fake reviews in Bengali comprising 7710 non-fake and 1339 fake reviews. To convert non-Bengali words (English, Romanized Bengali) to Bengali in a review, we have created a unique text conversion pipeline consisting of translation and back transliteration. In addition to creating the dataset, we explored several deep learning and pre-trained transformer models including CNN (LeCun, Bottou, Bengio and Haffner, 1998), BiLSTM (Graves and Schmidhuber, 2005), CNN-BiLSTM (Rhanoui, Mikram, Yousfi and Barzali, 2019), CNN-BiLSTM with attention mechanism (Lu, Li, Wang and Qin, 2021) as well as five available pre-trained BERT (Devlin, Chang, Lee and Toutanova, 2019), ELECTRA (Clark, Luong, Le and Manning, 2020) and ALBERT (Lan, Chen, Goodman, Gimpel, Sharma and Soricut, 2019) variant language models. After conducting extensive experimentation, we propose a weighted ensemble model that combines four pre-trained transformers i.e. *BanglaBERT Base* (Sarker, 2020), *BanglaBERT* (Bhattacharjee, Hasan, Ahmad, Mubasshir, Islam, Iqbal, Rahman and Shahriyar, 2022a), *BanglaBERT Large* (Bhattacharjee et al., 2022a), and *BanglaBERT Generator* (Bhattacharjee et al., 2022a) to detect fake reviews. To overcome the problem of class imbalance, we utilized text augmentation techniques to increase the number of fake reviews. Specifically, we employed two available augmentation libraries: *nlpaug* (Ma, 2019) and *bnaug*². Using the proposed weighted ensemble model, we achieved a 0.9843 weighted F1-score on 13390 reviews, of which 6695 were fake (1339 were actual fake and the rest were augmented using *nlpaug*) and 6695 were non-fake (randomly selected from 7710 instances). Similarly, using the same ensemble model, we achieved a 0.9558 weighted F1-score when the fake reviews were augmented using *bnaug*. In summary, we have made the following contributions in this paper:

- We have developed a Bengali Fake Review Detection (BFRD)³ dataset that contains 9,049 food-related reviews among which 1339 are fake and 7710 are non-fake. The reviews are collected from social media and annotated with the help of expert annotators.
- We have developed a unique text conversion pipeline that translate English words to in a text to their corresponding Bengali meaning and back transliterates Romanized Bengali to Bengali.
- We have utilized text augmentation techniques such as token replacement (using random masking, GloVe, Word2Vec), back translation, paraphrasing to handle class imbalance problem by increasing the fake review instances.

²<https://github.com/sagorbrur/bnaug>

³<https://github.com/shahariar-shibli/Bengali-Fake-Reviews-A-Benchmark-Dataset-and-Detection-System>

- We have proposed a weighted ensemble model consisting of four pre-trained Bengali language models: *BanglaBERT Base* (Sarker, 2020), *BanglaBERT* (Bhattacharjee et al., 2022a), *BanglaBERT Large* (Bhattacharjee et al., 2022a), and *BanglaBERT Generator* (Bhattacharjee et al., 2022a) that outperforms average ensemble approach and other deep learning and transformer models.
- We have conducted extensive experimentation and presented both quantitative and qualitative analysis of the results. Moreover, we have employed the Local Interpretable Model-Agnostic Explanations (LIME) (Ribeiro, Singh and Guestrin, 2016) text explainer framework to provide explanations for the model's predictions. We have also analyzed misclassification categories and compared the proposed ensemble model with other existing ensemble techniques.

The rest of the paper is structured as follows: in section 2, some of the related previous works are discussed. Section 3 defines the problem, while section 4 provides an overview of the process of creating the corpus. The proposed methodology is outlined in section 5, followed by an explanation and analysis of the experimental results in section 6. Lastly, in sections 7 and 8, limitations and a concluding remark are provided respectively.

2. Related Works

In this section, we discuss some works related to our research. During our exploration, we found no previous work on Bengali fake review detection. There are a number of works on detecting fake reviews in English and some other languages, which we have studied and classified into three main categories: traditional machine learning approaches, deep learning approaches, and hybrid along with transformer approaches. We discuss each of these categories below.

2.1. Traditional Approaches

Fake review detection using traditional machine learning involves a range of methods such as Support Vector Machines (SVM), Logistic Regression (LR), Naïve Bayes (NB), Random Forests (RF), and Decision Trees (DT).

Jindal and Liu (2008) classified fake reviews into three categories: non-reviews, brand-only reviews, and untruthful reviews. They trained a Logistic Regression classifier using duplicate or near-duplicate reviews as fake reviews, and the remaining reviews as truthful reviews. Ott et al. (2011) created the first gold-standard deceptive opinion spam dataset, gathering data through crowd-sourcing on Amazon Mechanical Turk. They discovered that although part-of-speech n-gram features provided reasonable accuracy in detecting fake reviews, the SVM classifier performed slightly better when psycho-linguistic features are incorporated.

Mukherjee et al. (2013b) conducted a set of classification experiments utilizing SVM and NB algorithms with n-gram features. They examined both fake and non-fake reviews from Yelp.com and their findings indicated that the accuracy of fake review detection on Yelp's real-life data was only 67.8%. Banerjee et al. (2015) employed RF, SVM and NB on the 15 Asia Hotel Reviews dataset, taking into account features such as writing style, word structure, level of details and cognition indicators. Etaiwi and Naymat (2017) used the same set of classifiers on the Chicago Hotel Review dataset along with Decision Tree classifier and they also considered n-gram features in all experiments.

Shan, Zhou and Zhang (2021) utilized lexicon-based features (SentiWordNet) with RF, NB, SVM, and multi-layer perceptrons (MLP). The RF algorithm achieved the highest accuracy of 92.9%. Mohawesh, Tran, Ollington and Xu (2021) analyzed concept drift using SVM, LR, and pruning neural networks (PNN) on four different datasets: Yelp Chi, Yelp NYC, Yelp ZIP, and Yelp Consumer Electronic. There are also several works based on Decision Tree (Sedighi, Ebrahimpour-Komleh and Bagheri, 2017), AdaBoost, JRip (Khurshid, Zhu, Yohannese and Iqbal, 2017) and Support Vector Network (Hernández-Castañeda, Calvo, Gelbukh and Flores, 2017).

Many researchers have found that using an ensemble approach with traditional machine learning models can be effective in detecting fake reviews. For instance, Yao, Zheng and Jiang (2021) utilized a combination of RF, XGBoost, CatBoost, Light Gradient-Boosting Machine (LightGBM), and Gradient-Boosting Decision Tree (GBDT) on the Yelp Chi dataset. They took into account both review and reviewer centric features and calculated F1-scores for hotel and restaurant domains separately using stacking and majority voting. Khurshid, Zhu, Xu, Ahmad and Ahmad (2019) and Mani, Kumari, Jain and Kumar (2018) also used ensemble models on the Yelp Chi and AMT dataset respectively, considering features such as TF-IDF and uni-gram, bi-grams.

Hammad and El-Halees (2013) extended the methods used in previous papers to detect spam in Arabic opinion reviews. The dataset was created by crawling Arabic reviews from tripadvisor.com, booking.com, and agoda.ae and 26 features including review content, reviewer features, and hotel information features were used. Naïve Bayes was found to perform better than SVM with an F1-score of 99.59% achieved using random oversampling.

2.2. Deep Learning Approaches

In contrast to conventional machine learning, deep learning techniques are capable of identifying significant features and comprehending the semantic context of textual data. Several studies have utilized Recurrent Neural Network (RNN), Convolutional Neural Network (CNN), hybrid approaches and Transformers to detect fake reviews.

CNN based approaches: Li et al. (2015) applied Convolutional Neural Networks (CNN) to identify spam opinions by learning document representations. The model used word vectors as input for both training and testing, and had a two-layer architecture consisting of a sentence layer for sentence composition and a document layer for transforming the sentence vector into a document vector. The study demonstrated the effectiveness of CNNs across different domains.

Zhao et al. (2018) presented Convolutional Neural Networks for text analysis that preserves word order. They utilized Word2Vec and a pooling method that preserves word order rather than the typical max pooling to generate word vectors. The model then concatenated the obtained features from the pooling layer as an output layer. Results showed that the proposed method had a higher accuracy of 70.02% compared to state-of-the-art methods.

Wang et al. (2018b) applied a CNN with attention mechanism to detect if a review is deceptive due to behavior, language, or both. They employed a multi-layer perceptron to extract behavioral features, and a CNN to extract linguistic features. With the attention method, the model dynamically weighed linguistic and behavioral features. The study demonstrated that the proposed approach outperformed the current state-of-the-art methods, achieving an accuracy of 88.8% for Hotel domain and 91% for Restaurant domain.

RNN based approaches: Ren and Zhang (2016) employed a gated recurrent neural network model with attention mechanism to generate document representation for detecting fake reviews. Although they achieved improved results in the hotel and restaurant domains compared to the doctor domain, there was a high percentage of unidentified vocabulary. To overcome this issue, they used a logistic regression method with neural features and concatenated them with the discrete feature before the softmax layer. The results showed an accuracy of 81.3% for Hotel, 87% for Restaurant domain and 76.3% for Doctor domain. However, the model suffers from time complexity.

Wang, Day, Chen and Liou (2018a) developed a spam detection model using long short-term memory (LSTM) network that focuses on dictionary-based features. The model comprises three layers: input, LSTM hidden, and output layer. The output neuron's value determines whether the review is deceptive (1) or genuine (0). The study found that the LSTM model outperformed SVM with an 89.4% accuracy in detecting deceptive reviews. However, the model solely focused on text and disregarded other important features such as metadata and behavioral features that could enhance performance.

Liu, Jing and Li (2020) presented a bidirectional LSTM model by combining features such as parts of speech, first-person pronoun features, and document representation with word embedding (Glove). The model outperformed state-of-the-art methods in mixed domains with an 83.9% accuracy and achieved high accuracy in individual domains with 83.9%, 85.8%, and 83.8% on hotel, restaurant, and doctor domains respectively. The study revealed that first-person pronoun features are important in detecting deceptive reviews.

Zeng, Lin, Chen, Chen, Lan and Liu (2019) showed that fake reviews often start or end with similar sentences, and the first and last sentences typically express stronger emotions than the middle sentence. The proposed ensemble model used four separate bidirectional LSTM models to encode the beginning, middle, and end of the reviews. The representations obtained from the four models were then concatenated and passed through self-attention and attention mechanisms to produce a final representation. The model achieved superior performance compared to SWNN and SAGA in one domain (hotel, doctor, and restaurant) with accuracy scores of 85.7%, 84.7% and 85.5% respectively. In the mixed domain, the model achieved an accuracy score of 83.4%. However, the model struggled to perform well in cross-domain scenarios, achieving an accuracy score of only 71.6% on the restaurant domain and 60.5% on the doctor domain.

Hybrid and Transformer approaches: Zhang et al. (2018) proposed DRI-RCNN which combines recurrent neural networks and convolutional neural networks. The model has four layers, including a convolutional layer to create a vector representation for each word, and a recurrent layer to learn context vectors for fake and real reviews. The experiments showed that this model achieved the highest accuracy of 82.9% on AMT datasets.

Dhamani et al. (2019) proposed a model that combined an ensemble method with long short-term memory and character-level convolutional neural network to detect spam emails, spam reviews, and political statements across three different datasets. The proposed model utilized a simpler feature extraction method, such as n-grams. Interestingly, the model demonstrated the ability to transfer knowledge from labelled data in one domain to another domain.

Shahariar et al. (2019) applied deep learning techniques for detecting spam reviews using both labeled and unlabeled data. Their methods included Multi-Layer Perceptron (MLP), Convolutional Neural Network (CNN), and

Long Short-Term Memory (LSTM). They also implemented an active learning algorithm that gradually labeled all unlabeled data by measuring the probability difference with a threshold value for accurate classification. The experimental results showed that the Convolutional Neural Network achieved the highest accuracy of 91.58% on the Ott dataset and 95.56% on the Yelp dataset, while the Long Short-Term Memory achieved the highest accuracy of 94.56% on the Ott dataset and 96.75% on the Yelp dataset. The models used Word2Vec for feature representation.

Gupta et al. (2021) employed several pre-trained models such as BERT, RoBERTa, ALBERT, and DistilBERT to classify real and fake reviews. RoBERTa acquired the best results but the classification results need more improvements. Mir, Khan and Chishti (2023) employed BERT to obtain word embeddings from review texts. The word embeddings were then fed into various classifiers including SVM, Random Forests, Naive Bayes, and others. The outcomes revealed that SVM outperformed other classifiers by achieving an accuracy of 87.81%. Although pre-trained transformer models have been widely used for SMS spam detection (Guo, Mustafaoglu and Koundal, 2023; Liu, Lu and Nayak, 2021; Rojas-Galeano, 2021; Sahmoud, Mikki et al., 2022), there are limited studies that have applied such models for detecting fake reviews.

3. Problem Definition

Informal definition. The problem is best framed as a supervised binary classification task where a review text written in Bengali language will be categorized into one of the two classes — *fake*, *non-fake*.

Formal definition. The objective of this study is to create a system that can identify fake Bengali review texts. The system will be capable of categorizing a given review text x_i , from a collection of n Bengali review texts $X = \{x_1, x_2, \dots, x_n\}$, into one of two pre-determined review categories: $C = \{c_1, c_2\}$. The purpose is to assign a review class C_i to the text, where c_1 and c_2 correspond to genuine and fraudulent reviews respectively.

4. Corpus Creation

As per our exploration, there are no publicly available datasets on fake review detection task in Bengali language. Therefore, we have developed a Bengali fake review detection dataset (we refer to as ‘BFRD’ dataset) in this work. Figure 1 illustrates the dataset development pipeline. Firstly, we select suitable social media sources to obtain available food reviews. Next, we manually collect data and preprocess it to simplify the data annotation process. Before proceeding with data annotation, we conduct a data conversion task where we perform back transliteration to convert Romanized Bengali to Bengali, and we perform translation to include the meaning of English words in Bengali text as well as to convert digits. Finally, we enlist the help of four annotators to perform data annotation and construct the BFRD dataset. We will delve into the details of each component of the pipeline in the following subsections.

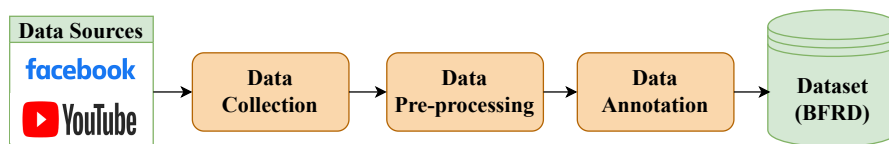

Figure 1: Dataset development pipeline

4.1. Data Collection

We manually gathered a total of **12,000** fake and non-fake review texts in Bengali across various social media platforms such as Facebook and YouTube. We manually collected potential texts from 15 public Bengali Facebook groups and two YouTube channels to create our dataset. Table 1 provides a comprehensive breakdown of the statistics for the sources⁴ from both Facebook and YouTube platforms. For our dataset, we limited our consideration to posts and comments from January 2019 to January 2023. Based on social media statistics⁵, a significant proportion of social media users in Bangladesh, 89.65% and 7.59%, utilize Facebook and YouTube respectively.

The majority of the data instances in this study were gathered from Facebook since it is the primary platform used by Bengali social media users. Despite the abundance of food reviews available on Facebook, we found a relatively

⁴<https://pastebin.ubuntu.com/p/8gQMnCrVw/>

⁵<https://gs.statcounter.com/social-media-stats/all/bangladesh>

Table 1

Statistics of some data collection sources (Facebook group/YouTube Channels). YT represents YouTube

Facebook group/ YouTube Channel	Popularity (No. of group members/ Subscribers)	Reaction per post/ video (Avg)	Engagement (Frequency of Posting)
FoodBank	2.1M	150	150/day
Food Bloggers BD	942.3K	25	15/day
Food N Foodies	244.4K	20	50/day
Sylhet Foodies	193.3K	15	10/day
Food Court	161.5K	15	25/week
COMILLA FOODIES	152.5K	70	40/week
Foodlovers of Narayanganj	132.4K	35	50/day
FoodBank Mirpur	130.7K	25	30/day
Food Bloggers Shonirakhra	111.2K	30	15/day
Food Bank -Faridpur	84.3K	30	50/week
Cox's Bazar Hotel & Food Review	67.0K	15	20/week
FoodBank Dhaka	56.2K	10	12/week
Feni Foodies	56.0K	30	10/week
Food Bank Brahmanbaria	49.3K	45	50/week
Efood Offer, Help & Review	39.8K	10	10/week
Bangladeshi Food Reviewer (YT)	1.28M	4K	20/month
Rafsan TheChotoBhai (YT)	1.46M	50K	5/month

small amount of data available on YouTube. Our observations indicate that many individuals who view Bengali food vloggers on YouTube typically comment on the vlogger's appearance, presentation style, or personality, rather than the food itself. Furthermore, most people leave their reviews in English in the comments section. Recent statistics reveal that a mere 0.55% of Twitter users in Bangladesh use the platform for social communication, and they predominantly communicate in English. As a result of the limited availability of Bengali texts related to food reviews on Twitter, we did not include Twitter data in our current work. To ensure the authenticity of the reviews collected, we followed specific criteria during the process of collecting both fake and non-fake reviews:

- We gathered data by selecting posts that had received at least 200 reactions (likes, comments, and shares).
- We took into account the comments and replies associated with the review posts.
- We also collected posts that advertised appealing offers and included digital menu cards.
- During data collection, we annotated review posts as fake if they were mentioned as paid in the comments, and we also marked review comments as fake if they received replies stating that the comment was fake.
- We identified certain individuals who spammed the same reviews in multiple groups and labeled their posts or comments as fake during data collection.

4.2. Data Pre-processing

To minimize the annotation workload and enhance consistency, we employed several preprocessing filters on the collected texts. After applying these filters, we were able to eliminate 961 texts, leaving **11,039** texts that were subsequently passed on to the human annotators for manual annotation. The steps followed in processing the texts are as follows:

1. Repeated punctuations were removed.
2. Texts with a length of fewer than three words were discarded as they do not contain any valuable information.
3. Duplicate texts were removed.

Table 2

Information regarding the experience, expertise, and other pertinent details of the annotators

Information	First Annotator	Second Annotator	Third Annotator	Fourth Annotator
Role	Lecturer	Lecturer	Research Assistant	Lecturer
Research field	NLP	NLP	NLP	NLP
Experience	2 years	1 year	1 year	3 years
Read food reviews	Yes	Yes	Yes	Yes
Written food reviews	No	No	Yes	Yes

4.3. Data Annotation

In this section, we describe the annotation process of the Bengali fake review detection dataset (BFRD). Data annotation is challenging because of the subjective nature of the task. Based on some pre-defined criteria, annotators have to rely on their own interpretation and judgment to label the data that may lead to inconsistencies and biases in the annotations. Ensuring high quality, finding skilled annotators, and managing time effectively are other challenges that need to be overcome. To address these challenges, we identified annotators with domain knowledge. We established clear guidelines to ensure consistency and accuracy in the annotations. To maintain quality control, we implemented measures to assess the quality of the annotations.

(a) Annotator Recruitment: Initially, we invited 10 individuals to help us with the annotation process. We then assessed the trustworthiness score (Price, Gifford-Moore, Fleming, Musker, Roichman, Sylvain, Thain, Dixon and Sorensen, 2020) of each participant by asking them to label 100 reviews. From the dataset, we randomly selected 80 reviews that were manually annotated by two authors and created 20 control samples. We interspersed one control sample after every four reviews that the participants labeled. The control samples were easy to label and were not previously known by the participants. After the annotation task, we analyzed how many control samples were correctly labeled by each participant. We set the threshold trustworthiness score for this task to be at least 90%. Based on the evaluation, only four participants achieved a trustworthiness score above 90%.

(b) Annotator Identity: We enlisted four individuals (with trustworthiness score above 90%) to perform the task of manual annotation: a graduate student and three academic specialists. All of them are native Bengali speakers and possess a background in NLP research projects that involve data labeling, with experience ranging from 1 to 3 years. They all are active on social media and have a habit of reading food reviews before visiting a restaurant and writing their own reviews after trying a particular food item. The information regarding their experience, expertise, and other pertinent details is presented in Table 2.

(c) Annotation Guidelines: Providing detailed annotation guidelines is essential for ensuring the quality of annotation and gaining a deeper understanding of the dataset, as individual interpretations and perceptions can differ significantly. During the annotation process, we request the annotators to follow the steps illustrated in Figure 2. To identify a review as fake, we present six specific criteria. These criteria include the presence of extreme positive or negative emotions in the text, the inclusion of personal stories, details, or poetic descriptions, an excessive focus on humor rather than qualitative details, the use of unnecessary ratings such as 100 or 200 out of 10, texts that appear professionally written or exhibit poor grammar quality, and, lastly, the intelligence and judgment of the annotator. Prior to the annotation task, we provide the annotators with a few examples for each criterion and explain why a particular example should be categorized as a specific class. In Table 3, we provide few instances of fake reviews from the dataset along with the corresponding criteria they satisfy. Some more instances can be found in Appendix A.

During the manual annotation process, we exclude instances that have already been labeled as fake during the data collection phase. Each review text is individually annotated by three annotators. If a review fulfills any of the six criteria, the annotator classifies it as fake. On the other hand, if a review does not fit into any of the six criteria, the annotator marks it as genuine or flags it for further examination. We evaluate each text based on three labels. If all three labels match, we consider the associated label as final. However, if all three labels contain the flag, we discard the text. In cases where there is disagreement among the annotators, an expert annotator resolves the issue through discussion, determining whether to keep or remove the text. The final label for such texts is decided during the discussion. Within our dataset, we identified 3,433 texts where both flag marks and disagreements among annotators were present. Out of this subset, 1,443 texts were successfully resolved through discussions by an additional expert

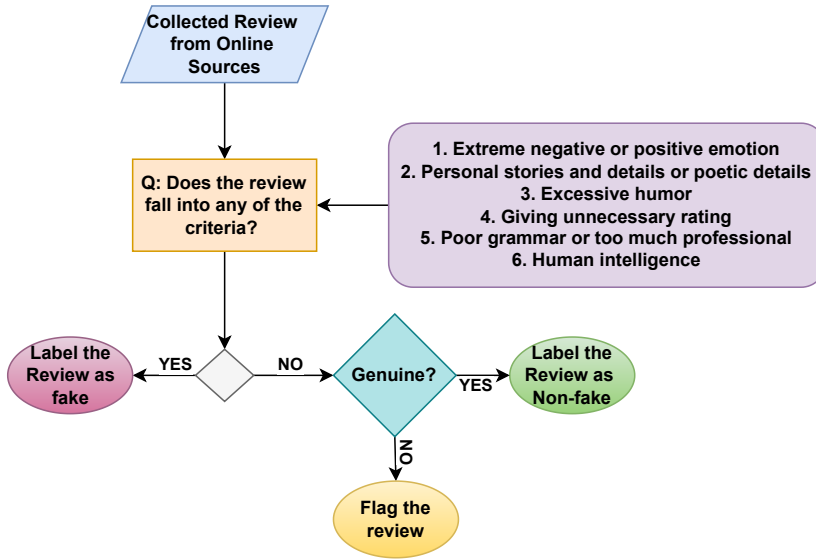

Figure 2: Data annotation procedure along with pre-defined guidelines

Table 3

Few annotated fake review instances with corresponding annotation criteria

Fake reviews	Criteria
অফার দেখে গেলাম। প্রথমে পিцца দেখেই সাইজ আর চিজের উপরে ক্রাশ খেয়ে গেলাম, যাকে বলে একেবারে লাভ এট ফাস্ট সাইট। তারপর আল্লাহর নাম নিয়ে খেলা শুরু। তারপর পিছার দুনিয়ায় আমি এক পথিক। যাই হোক খাইয়া ব্যাপক মজা পাইছি তাই আবেগাপ্ত হয়ে গেছিলাম আরকি। অফারের আর মাত্র ৪ দিন বাকি। এরকম পানিত দামে শরবত খেতে চাইলে অপেক্ষা না করে চলে যেতে পারেন ভাইলোক্স। (I went to after seeing the offer. The first time I saw the pizza, I fell in love with the size and cheese, which is called love at first sight. Then the game started with the name of Allah. Then I was a traveler in the world of pizza. Anyway, I had a lot of fun eating it, so I got emotional. Only 4 days left for the offer. If you want to drink juice at the price of water, you can go without waiting brothers.)	2, 3
Place: Castle সালামের পাশে রেটিং :১০/১০ Behavior :10/10 Price:1500-1485=15 tk বৃষ্টির সময় খাইতে গেলাম। সাথে কেউ ছিলো না। খাবারটা যথেষ্ট গরম ছিলো। পিয়াজের পরিমানটা ভালোই ছিলো। সময় পেলে আবার যাবো আপনারাও যাবেন। কথা হচ্ছে আমি 10 out of 10 দিতে পেরে অনেক ধন্য। (Place: Next to Castle Salam Rating: 10/10 Behavior: 10/10 Price: 1500-1485=15 Tk. I went to eat during rain. There was no one with me. The food was hot enough. The amount of onion was good. I will go again if I have time. You can also go. I am very blessed to be able to give 10 out of 10.)	1, 4

annotator. The remaining 1,990 texts were subsequently discarded. As a result, our final “BFRD” dataset consists of **9,049** processed and annotated texts. Among these, **1,339** texts were labeled as *fake*, while the remaining **7,710** instances were labeled as *non-fake*. For reference, Table 4 provides a few samples along with the reasoning behind their exclusion due to disagreements and confusion in assigning a class label (flag).

(d) Annotation Quality: In order to measure the quality of the annotations, we assessed the level of agreement among the annotators using Fleiss’ kappa score (Fleiss, 1971). This statistical measure is specifically designed to determine agreement among multiple annotators, extending Cohen’s kappa (Cohen, 1960) which is typically used for two annotators. Fleiss’ kappa compares the actual agreement observed among the annotators to the expected agreement based on chance allocation. The resulting score ranges from 0 to 1, where a score of 0 suggests no agreement beyond chance, and a score of 1 indicates perfect agreement. Intermediate values indicate different levels of agreement, varying based on the specific score obtained. Fleiss’ kappa score can be calculated as follows:

Table 4

Some excluded review instances along with labels and the reason behind exclusion

Reviews	Label	Remarks
Buy one get one offer. এডগুলো আইটেম আমার শেষ করতে কষ্ট হয়েছিল। স্টেকটা আর মাসরুমটা আমার খুব ভালো লেগেছে। যারা কম বাজেটে বেশী খেতে চান মাইনলি তাদের জন্য। মমো, সালাদ, ভেজিটেবল, চিকেন স্টেক, মশরুম ফ্রাইড রাইস কিছুই বাকি ছিলনা। (সাথে দুইটা sweet & sour soup ও ছিল Appetizer হিসেবে) আর কি চাই বলেন? রুফটপ রেস্টুরেন্ট ছোটখাটোর মধ্যে সুন্দর একটা জায়গা। @only 500/= ট্রাই করতে পারেন। Taste: 9/10	fake, Non-fake	promotion of offers but seems an honest review
সবাই Surprise gift পাচ্ছে দেখতে দেখতে আমিও আজ পেয়ে গেলাম। এখনও বিশ্বাস হচ্ছে না। Chillux Always আমার fvr Restaurant তাই ফুড রিভিউ আলাদা করে দেবার কিছু নেই। Thank you so much The Chillux for giving me a surprise gift.	flag	Does not fall into the criteria of being a review

Table 5Fleiss' kappa score on *fake* and *non-fake* class

Class	Kappa score	Average
Fake	0.83	0.81
Non-fake	0.79	

Table 6

Class wise statistics of BFRD dataset

Statistics	Fake	Non-fake
Total words	1,55,789	9,27,902
Total unique words	17,739	51,200
Max Review length	693	1,614
Avg number of words	116.35	120.35
Avg number of unique words	84.99	88.42

$$\kappa = \frac{P - P_e}{1 - P_e} \quad (1)$$

In Eq. 1, κ denotes the Fleiss' kappa score, where P represents the observed proportion of agreement among the annotators, and P_e represents the expected proportion of agreement due to chance. To compute the value of P , we add up the number of annotations for each category across all annotators and divide it by the product of the total number of instances and the total number of annotators. On the other hand, to calculate P_e , we sum up the squared proportion of annotations for each category and divide it by the square of the total number of instances. In Table 5, we provide the kappa score for each class. The *fake* class demonstrates the highest agreement with a score of 0.83. The average kappa score of 0.81 reflects an almost perfect level of agreement among the annotators.

4.4. Dataset Statistics

From a total of 9,049 annotated reviews in the BFRD dataset, 1339 reviews are fake while 7,710 are non-fake. We provide some statistics regarding each class in Table 6. The maximum review length for fake reviews is 693, whereas the maximum review length for non-fake reviews is 1614, indicating that fake reviews tend to be shorter. Nonetheless, despite their length, the average number of unique words in fake reviews, around 85, is very close to the average number of unique words in non-fake reviews. This suggests that fake reviews use captivating or inventive word choices to catch the reader's attention. Figure 3 depicts the relationship between review length and the number of reviews for each class, indicating that the majority of reviews have a length between 60 and 120 words for both fake and non-fake classes. Table 7 presents the statistics of our data split along with our augmentation approach. The augmentation was only performed on the fake review class, with four augmentations progressively applied to each review. This means that we

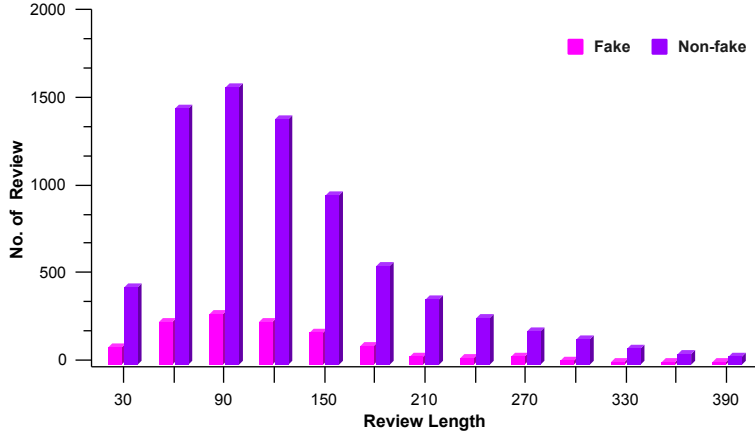

Figure 3: Class wise ratio of number of reviews with respect to the review length

Table 7

Summary of data split (Train, Validation and Test) of BFRD dataset. *Aug* indicates the number of augmentations for a single fake review

Class	Fake					Non-fake				
	0	1	2	3	4	0	1	2	3	4
Train	1071	2142	3213	4285	5356	1071	2142	3214	4285	5356
Validation	134	268	401	535	670	134	268	402	535	669
Test	134	268	402	536	669	134	268	402	536	670
Total	1339	2678	4016	5356	6695	1339	2678	4018	5356	6695

first created one augmentation for each review and performed experimentation before creating two, then three, and so on. We ensured that the dataset remained balanced at each augmentation level by taking an equal number of instances from both the fake and non-fake classes. The ‘No. of Augmentation’ column indicates the level of augmentation, where a value of 3 in this column means we created three augmentations for each fake review, resulting in a total of 5,356 fake reviews (including the original 1,339). To maintain balance in the dataset during training, we randomly selected 5,356 non-fake reviews (from the total of 7,710). The dataset was then split into three sets for training, validation, and testing, with 80%, 10%, and 10% of the data, respectively. We shuffled the data instances and split them into the three sets randomly.

5. Methodology

Figure 4 illustrates the schematic diagram of our proposed approach for Bengali fake review detection task. Our proposed approach consists of four key steps: conversion, augmentation, pre-processing, and detection. In the first step, we convert English words in the text to their corresponding Bengali meanings, and also transliterate Romanized Bengali words to Bengali. The second step involves text augmentation, which helps to create more fake instances. After that, we pre-process the texts to prepare them for detection. Finally, we apply a range of deep learning techniques, as well as pre-trained transformers and ensemble methods, to detect fake reviews. We discuss each of these steps in the proposed methodology below.

While collecting and initially processing the data, we made two noteworthy observations. First, a considerable number of reviews contained Bengali words written using English letters, commonly referred to as Romanized Bengali. In fact, some reviews even consisted of one or two complete sentences entirely in Romanized Bengali. Second, we found that many reviews included English words and digits. These observations highlight the linguistic diversity present within the reviews and emphasize the need for appropriate handling of both Bengali and English elements during further analysis. If we exclude these texts that contain Romanized Bengali or English words, we risk losing

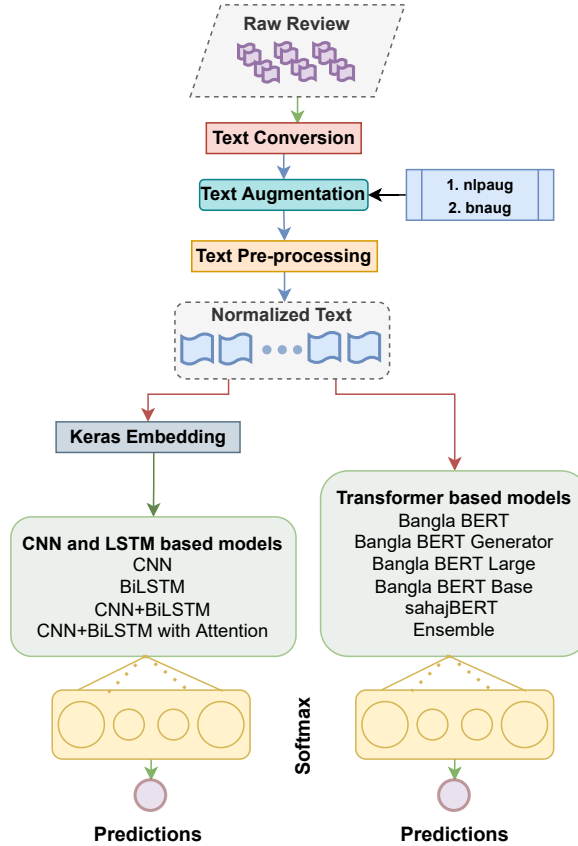

Figure 4: Schematic diagram of Bengali fake review detection system

a considerable amount of data given the scarcity of data available to us. Furthermore, our proposed detection model is designed to work best with Bengali words. Therefore, we developed an algorithm for text conversion purpose that can back-transliterate the Romanized Bengali words into Bengali words and at the same time translate the English words into their Bengali equivalent meanings in a text. We also convert English digits to their Bengali counterparts. We present our text conversion procedure that involves transliteration and translation in Algorithm 1.

The algorithm starts by taking raw review sentences as input. For each sentence, it performs some initial processing, such as allocating spaces before and after punctuation marks, replacing newlines and emojis with spaces. Next, the individual words are extracted from the sentence. Since the reviews are written by humans, we observed instances where English and Bengali words in a sentence were concatenated. This occurred due to typing errors, such as missing appropriate spaces between words. For instance, we came across a sentence like “খাবার পরিবেশন আরওবতেতরে হতে পারতো” [Food service could have been muchbetter] where the word “আরওবতেতরে” [muchbetter] was concatenated due to a missing space. The algorithm identifies and separates such concatenated English-Bengali words using regular expressions. The algorithm then proceeds to process each word individually. If a word is not an end-of-sentence punctuation mark (.), we check whether it is an English word by utilizing the dictionary from the Enchant library⁶. If the algorithm detects an English word or digits, it simply translates them into their corresponding Bengali words or digits using the Googletrans library⁷. Otherwise, there are two possibilities: the word is either Bengali or Romanized Bengali. If the word is Bengali, the algorithm directly concatenates it back into the sentence. If it is Romanized Bengali, the algorithm employs a Bengali phonetic parser library⁸ to back-transliterate the word into Bengali. When

⁶<https://abiword.github.io/enchant/>

⁷<https://py-googletrans.readthedocs.io/en/latest/>

⁸<https://github.com/porimol/bnbphoneticparser>

Algorithm 1 Algorithm of the proposed text conversion pipeline

```

1: function CONVERSION(word, method, src, des)
2:   temp = ""
3:   if method is 'gt' then                                     ▷ gt = google translate
4:     | temp = Translate word with google translate (src - des)
5:   else
6:     | temp = Transliterate word with bnbphonetic parser (src - des)
7:   return temp
8:
9: function TEXT_CONVERSION(Raw Sentences)
10:  for each sentence do
11:    | converted_sent = ""
12:    | Allocate space before and after punctuations
13:    | Replace newline and emojis with a space
14:    | Split words from sentence
15:    | Split mixed English-Bengali words using regex
16:    for each word do
17:      | if word is not "|" then                                     ▷ End of Sentence
18:        | if word is in English dictionary then
19:          | if word is not a digit then
20:            | | converted_sent += Conversion(word, en, bn, 'gt')
21:          | else
22:            | | converted_sent += Conversion(word, bn, bn, 'gt')
23:          | else
24:            | if word is a digit then
25:              | | converted_sent += Conversion(word, bn, bn, 'gt')
26:            | else
27:              | if word is not Bengali then
28:                | | if word is English then
29:                  | | | converted_sent += Conversion(word, en, bn, 'gt')
30:                | | else                                     ▷ Romanized Bengali
31:                  | | | converted_sent += Conversion(word, bn, bn, 'bnb')
32:                | | else
33:                  | | | converted_sent += word
34:              | else
35:                | | converted_sent += word
36:            return converted_sent

```

the algorithm encounters an end-of-sentence punctuation mark, it reconstructs the original sentence by concatenating all the processed and initial words. The algorithm uses a function called *CONVERSION* to perform these translation and back-transliteration processes. The argument '*word*' is the raw token, '*method*' is the name of the specific library, and '*src*' and '*des*' are the source and destination languages to convert. We present some of the converted text instances through the algorithm in Table 8. A popular LLM model, Llama 2 (70B)⁹, was also explored to convert the text given in Table 8, but it was unable to convert the majority of the texts in a meaningful way. Table 22 displays the converted texts with Llama 2. Appendix B provides an explanation for the performance of the LLM model on our data. The reviews posted on social media platforms are code-mixed. Dealing with such content is difficult for any model, particularly those developed predominantly in English. Our proposed pipeline is created using a variety of open-source tools that are publicly available online. Fine-tuning and widespread use of LLMs for large-scale data conversion can be costly. LLMs can be a great future alternative to our proposed pipeline if some post-processing of the texts can be done on the outputs of the models.

⁹<https://www.llama2.ai/>

Table 8

Few example instances before and after applying the text conversion pipeline

Original Text	Converted Text
Best pizza offer for Mirpur peoples Buy 1 Get 1 free 1.Mashroom lovers pizza.2.Meat lovers pizza. Choto bhayer jsc xam sesh kore gelm n e offer ta khey ashlam onk tasty chilo n tader bebohar o valo chilo.. mane ak kothay paisa osul Taste:9/10 Price: 330tk Location: The Hub Restaurant (60 feet) — at The Hub Restaurant	সেরা পিচ্ছা অফার জন্য মিরপুর লোকেরা কেনা ১ পাওয়া ১ বিনামূল্যে ১ মাশরুম প্রেমীরা পিচ্ছা ২ মাংস প্রেমীরা পিচ্ছা ছোট ভাইয়ার জেসসি জ্যাম শেষ কোরে গেলম এন ই অফার টা খেয়ে আসলাম ওঙ্ক সুস্বাদু ছিলো এন তাদের বেবোহার ও ভালো ছিলো ম্যান একে কোথায় পাইসা ওসুল স্বাদ ৯ ১০ দাম ৩৩০ লোকেশন দ্য হাব রেষ্টোরা ৬০ ফিট এট দ্য হাব রেষ্টোরা
Cafe Famous Wari প্রায় বেশ কয়েকদিন আগে গিয়েছিলাম...। এদের বার্গার গুলা ভালো লাগে আমার। কোন জায়গার সাথে তুলনা করব না তবে ভালো লাগে আমার সবসময় চিকেন বার্গার ট্রাই করা হইসে সব খানে ফেমাসে গেলেও এইটাই ট্রাই করা হয় এবার যাস্ট একটু চেঞ্জ করলাম বিফ টা নিয়ে বিফ বেকন-৩৫০ টাকা ডিঙ্ক-৪০ টাকা করে ফ্রেশ ফ্রাইস-১০০ টাকা লোকেশন: ওয়ারী (yellow এর উপরের তলায়) আইটেম: Beef n bacon দাম: ৩৫০ টাকা	ক্যাফে বিখ্যাত ওয়ারী প্রায় বেশ কয়েকদিন আগে গিয়েছিলাম। এদের বার্গার গুলা ভালো লাগে আমার। কোন জায়গার সাথে তুলনা করব না তবে ভালো লাগে আমার সবসময় চিকেন বার্গার ট্রাই করা হইসে সব খানে ফেমাসে গেলেও এইটাই ট্রাই করা হয় এবার যাস্ট একটু চেঞ্জ করলাম বিফ টা নিয়ে বিফ বেকন ৩৫০ টাকা ডিঙ্ক ৪০ টাকা করে ফ্রেশ ফ্রাইস ১০০ টাকা লোকেশন ওয়ারী হলুদ এর উপরের তলায় আইটেম গরুর মাংস এন বেকন দাম ৩৫০ টাকা
Berger Xpress এ বন্ধুদের সাথে বার্গার খেতে গেছিলাম। পরে নিজের বার্গার নিজেই পাইলাম না	বার্গার এক্সপ্রেস এ বন্ধুদের সাথে বার্গার খেতে গেছিলাম পরে নিজের বার্গার নিজেই পাইলাম না

5.1. Text Augmentation

Since we have a limited number of fake reviews (only 1339) in our dataset, we decided to only augment the fake reviews in order to improve the quality of fake reviews. To achieve this, we utilized two available python libraries for text augmentation: *nlpaug* (Ma, 2019) and *bnaug*¹⁰. The augmentation pipeline is shown in Figure 5, where we pass a single fake review to either *nlpaug* or *bnaug* library. We create augmented instances progressively for experimentation purposes, starting with one augmentation for each review, then two, and so on. Specifically, we created a maximum of

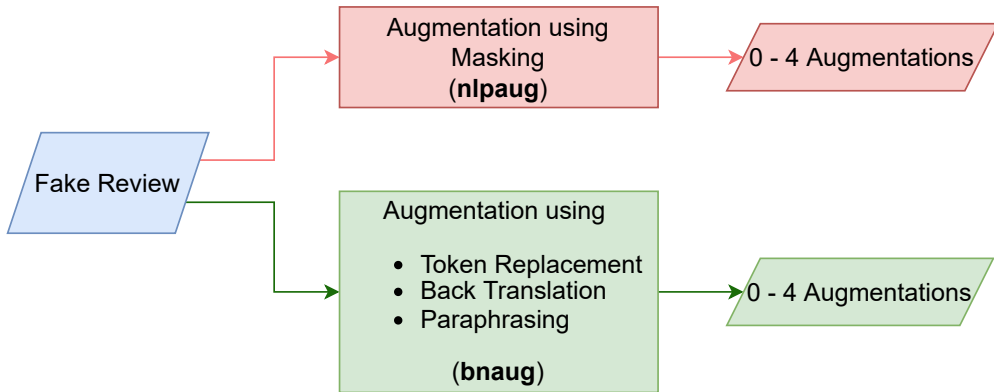
Figure 5: Augmentation pipeline using *nlpaug* and *bnaug*

four augmentations using the *nlpaug* library, which applies random 15% masking on the input sequence and employs various BERT variant models pre-trained for Bengali language. We used four different models, including *BanglaBERT Base* (Sarker, 2020), *BanglaBERT* (Bhattacharjee et al., 2022a), *BanglaBERT Generator* (Bhattacharjee et al., 2022a), and *sahajBERT*¹¹, to leverage the linguistic generalization capability of the language-specific models. We conducted several experiments with varied numbers of random masking and discovered that the percentage of random masking had little effect on the model outcomes. It should be emphasized that the replacement of any word in the *nlpaug* augmentation approach takes into account the embedding of the replaced word. In this augmentation process, the new word is chosen ensuring that it has a similar embedding to the previous one. So the replaced embedding has little effect

¹⁰<https://github.com/sagorbrur/bnaug>

¹¹<https://huggingface.co/neuropark/sahajBERT>

Table 9

Performance comparison of five individual experiments using varying percentages of random masking during augmentation for the *Bangla BERT* model utilizing *nlpaug* technique

Percentage of Augmentation	Fake			Non-Fake			WF1	ROC-AUC	MCC
	P	R	F1	P	R	F1			
8	0.964	0.958	0.961	0.958	0.964	0.961	0.961	0.961	0.922
10	0.960	0.961	0.960	0.961	0.960	0.960	0.960	0.960	0.921
12	0.971	0.937	0.954	0.939	0.971	0.955	0.954	0.954	0.909
15	0.976	0.985	0.981	0.985	0.976	0.980	0.981	0.981	0.961
18	0.974	0.954	0.964	0.955	0.975	0.964	0.964	0.964	0.928

Table 10

Some augmented fake reviews generated using *nlpaug* and *bnaug*

Type	Review
Converted Review	জীবন আমার ধন্য হলো বিফ আচারী খিচুরি খেয়ে সত্যি অসাধারণ টেস্ট ১০ ১০ দাম ১৫০ টাকা চিকেন ১৩০ টাকা কোলাহল রেস্টুরেন্ট ঢাকা কর্মাস এর বিপরীতে মিরপুর ২ ঢাকা। (My life is blessed after eating beef achari khichuri. Really awesome. Test 10/10 price 150 taka chicken 130 taka noisy restaurant. Opposite Dhaka Commerce Mirpur 2 Dhaka.)
nlpaug (1)	জীবন আমার ধন্য হাট বিফ নেই আর খেয়ে সত্যি এক টেস্ট ১০ ১০ মিনিট ১৫০ টাকা চিকেন ১৩০ টাকা কোলাহল রেস্টুরেন্ট ঢাকা আমার পরিবারের বিপরীতে চ্যানেল টু ঢাকা ১
nlpaug (2)	জীবন আমার ধন্য হলো বিফ আচারী কেক খেয়ে সত্যি কি খাবার ১০ ১০ দাম ১৫০ টা চিকেন ১৩০ টাকা নরমাল রেস্টুরেন্ট মানিকগঞ্জ ৩৫ ভাতের বিপরীতে মানিকগঞ্জ ২ ঢাকা ১
nlpaug (3)	চাকরী আমার ধন্য হলো ভাত আর খিচুরি খেয়ে আর অসাধারণ কাজ করলাম ১০ দাম ১৫০ টাকা মার্কেটিং টু জন কোলাহল রেস্টুরেন্ট ঢাকা কর্মাস এর বিপরীতে মিরপুর কর্পোরেট ঢাকা।
nlpaug (4)	জীবন আনন্দে ধন্য হলো বিফ রেস্টুরেন্টে একটু খেয়ে যেতে হয় টেস্ট লাগ ১০ ডলার ১৫০ টাকা চিকেন ৬০০ টাকা কোলাহল বিষ্টিম ঢাকা কর্মাস আমার বিপরীতে মিরপুর ২ ঢাকা।
bnaug (word2vec)	জীবনকে আপনার ধন্য হলো বিফ আচারী খিচুরি খেয়ে সত্যি অসাধারণ ওয়ানডে ১০ ১০ দাম ১৫০ পয়সা চিকেন ১৬০ পয়সা কোলাহল রেস্টুরেন্ট ঢাকা কর্মাস -এর বিপরীতে মিরপুর ২ ঢাকা।
bnaug (glove)	জীবন আমি ধন্য হলো বিফ আচারী খিচুরি খেয়ে সত্যি অসাধারণ ওডিআই ১০ ১০ দাম ১৫০ ব্যায়ে চিকেন ১৪০ ব্যায়ে কোলাহল রেস্টুরেন্ট রাজশাহী ইন্ডাস্ট্রি এর বিপরীতে মিরপুর ২ রাজশাহী।
bnaug (back translation)	জীবন আমার ধন্য হলো বিফ তরকারি খেয়ে সত্যি অসাধারণ। ঢাকা কর্মাস এর বিপরীতে মিরপুর ২।
bnaug (paraphrasing)	আমার জীবন সুখী গরুর মাংসের খিচুরি খেয়ে, সত্যিকারের অসাধারণ পরীক্ষা হচ্ছে ১০ ১০ টাকা মুরগী ১৩০ টাকা, কোলাহল রেস্টুরেন্ট ঢাকা কর্মাস এর বিপরীতে মিরপুর ২ ঢাকা।

on the model's output. As shown in Table 9, the results for the Bangla BERT model's weighted f1 score range from 0.954 to 0.981 for varied percentages of random replacement, with a variance of approximately 0.027%.

Table 10 shows examples of augmentations generated by the four models for a single review instance, indicating that *nlpaug* randomly masks tokens and replaces them using the corresponding pre-trained model's contextual information. To explore other augmentation techniques, we also utilized the *bnaug* library for random mask-based generation using pre-trained Bengali GloVe¹² and Word2Vec¹³ embeddings, as well as for back translation and paraphrasing. For back translation, we employed pre-trained Bengali T5 neural machine translation model (Bhattacharjee, Hasan, Ahmad and

¹²<https://huggingface.co/sagorsarker/bangla-glove-vectors>

¹³https://huggingface.co/sagorsarker/bangla_word2vec

Shahriyar, 2022b) that translates Bengali text to English and back to Bengali. For paraphrase generation, we used pre-trained Bengali T5 paraphrase model (Akil, Sultana, Bhattacharjee and Shahriyar, 2022). As per the example instances shown in Table 10, we can observe that the Bengali word টেস্ট [taste] has been replaced by *sahajBERT* (nlpaug), word2vec (bnaug), glove (bnaug), and paraphrase (bnaug) with the Bengali words কাজ, ওয়ানডে, ওডিআই, পরীক্ষা [work, one day, ODI, test] respectively. The variations in meaning of the word “taste” could be due to a number of factors such as the context in which the word appears, the specific pre-trained models used for augmentation, and the quality and quantity of the training data used to train these models. Moreover, the word embeddings (GloVe, Word2Vec) are based on the distributional hypothesis that words that occur in similar contexts have similar meanings. This means that the context of the word “taste” is ambiguous or not well represented in the training data, which is why the resulting embeddings might not be able to accurately capture the actual meaning.

5.2. Pre-processing

Text Pre-processing: To clean all the Bengali texts, we employed a Python module for text normalization as outlined in (Hasan, Bhattacharjee, Samin, Hasan, Basak, Rahman and Shahriyar, 2020). The process of text cleaning involved a number of steps, including managing multiple white spaces, handling URLs, replacing emojis, fixing double or single quotes, and replacing Unicode characters.

Feature Extraction: To obtain the embedding features, we utilized the default *Keras embedding layer* which required creating a vocabulary of size 25000 to map each word in a text to its corresponding index in the vocabulary. To convert variable length sequences into fixed length vectors of size 512, we employed the *Keras pad_sequences* method which removed extra values from long sequences and padded short ones with zeros. The embedding dimension was set to 300, and as a result, the embedding layer converted a text of length 512 into a matrix of size 512×300 .

5.3. Detection Methods

To detect fake reviews in Bengali, we have utilized three different methods: CNN and LSTM-based, transformer-based and ensemble-based. In the CNN and LSTM-based approach, we have employed four models: CNN (LeCun et al., 1998), BiLSTM (Graves and Schmidhuber, 2005), CNN-BiLSTM (Rhanoui et al., 2019), and CNN-BiLSTM with attention mechanism (Lu et al., 2021). In the transformer-based approach, we fine-tuned three ELECTRA (Clark et al., 2020) variants, two BERT (Devlin et al., 2019) variants, and one ALBERT (Lan et al., 2019) variant pre-trained Bengali language models. For the ensemble-based approach, we proposed a method of combining the results of multiple pre-trained transformer models for better accuracy. We discuss all the approaches below in detail.

5.3.1. CNN and LSTM based models

We present the architecture details of all the CNN and LSTM-based models in Table 11.

(a) **CNN:** Convolutional Neural Network (LeCun et al., 1998) is a deep learning architecture that applies filters over word embeddings or character sequences to capture local patterns and features such as n-grams or word combinations. They are particularly useful for tasks where local context plays a crucial role, such fake review detection. The convolutional layers slide filters across the input, extracting local information. They can capture local patterns regardless of their position in the text, making them suitable for tasks with significant local dependencies. The extracted features are then passed through fully connected layers for classification. CNNs leverage shared weights to learn hierarchical representations of the text data.

(b) **BiLSTM:** Bidirectional Long Short-Term Memory (Graves and Schmidhuber, 2005) is an extension of the LSTM architecture, which is capable of modeling long-term dependencies in sequential data which is valuable for text classification tasks where the meaning of a word can depend on the surrounding words. It processes the input in both forward and backward directions simultaneously. BiLSTMs utilize memory cells and gates to capture and update information across different time steps. By processing the input sequence in both directions, the network can learn from past and future contexts, enhancing the model’s ability to understand the text.

(c) **CNN-BiLSTM:** CNN-BiLSTM (Rhanoui et al., 2019) combines the strengths of both CNN and BiLSTM architectures for text classification tasks. It leverages the local feature extraction capabilities of CNNs and the contextual understanding of BiLSTMs. The model typically starts with a CNN layer to extract local features, followed by a BiLSTM layer to capture sequential dependencies. The output of the BiLSTM is then passed through fully connected layers for classification. By combining both, the model can learn both local and global representations of the text, leading to enhanced representation learning and improved classification accuracy.

(d) **CNN-BiLSTM with Attention mechanism:** CNN-BiLSTM with attention mechanism (Lu et al., 2021) extends

Table 11
Architecture details of the deep learning models

Architecture	CNN	BiLSTM	CNN BiLSTM	CNN-BiLSTM with Attention
Input length			512	
Embedding Dimension			300	
Filters (Layer-1)	200	-	200	512
Kernel Size	3	-	3	4
Filters (Layer-2)	100	-	200	256
Kernel Size	3	-	3	3
Filters (Layer-3)	-	-	-	128
Kernel Size	-	-	-	2
Pooling Type	max	-	max	max
BiLSTM Cell (Layer-1)	-	128	128	200
dropout	-	0.5	0.5	-
BiLSTM Cell (Layer-2)	-	128	128	-
Attention Vector	-	-	-	yes
Total Parameter	10,288,202	7,799,998	8,049,198	8,777,751
Activation			ReLU	
Activation (Output layer)			softmax	
Loss			categorical_crossentropy	
Optimizer			Adam	

the CNN-BiLSTM model by incorporating an attention mechanism. Attention allows the model to focus on relevant parts of the input sequence. The model first applies a CNN layer to extract local features and then uses a BiLSTM layer to capture sequential dependencies. The attention mechanism assigns weights to different parts of the input sequence which enables the model to dynamically attend to different parts of the text, focusing on the most relevant words or phrases contributing to the classification decision. Moreover, the combination of CNN and BiLSTM layers provides a comprehensive representation learning framework that leverages both local and global dependencies, leading to improved performance in text classification.

5.3.2. Transformer based Models

Table 12 contains the architecture configurations of the pre-trained transformer models.

(a) **BERT based Transformer Models:** The Bidirectional Encoder Representations from Transformers (BERT) (Devlin et al., 2019) is constructed upon a deep learning framework where the connections between input and output elements are established, and the weights are adaptively determined based on their relationship. What sets BERT apart is its ability to perform bidirectional training, allowing the language model to grasp the context of a word by considering its surrounding words rather than solely focusing on the preceding or succeeding word. *BanglaBERT Base*¹⁴ follows the same architecture as the original BERT model.

(b) **ELECTRA based Transformer Models:** Efficiently Learning an Encoder that Classifies Token Replacements Accurately (ELECTRA) (Clark et al., 2020) utilizes a pre-training task that revolves around identifying replaced tokens within the input sequence. This involves training a discriminator model to recognize the tokens that have been replaced in a corrupted sequence, while a generator model is simultaneously trained to predict the original tokens for the masked out ones. This setup resembles a generative adversarial network training system but without the adversarial aspect, as the generator is not trained to deceive the discriminator. *BanglaBERT* (Bhattacharjee et al., 2022a) serves as the ELECTRA discriminator model, while *BanglaBERT Generator* (Bhattacharjee et al., 2022a) is an ELECTRA generator model that has been pre-trained using the masked language modeling (MLM) objective on substantial amounts of Bengali texts. *BanglaBERT Large* (Bhattacharjee et al., 2022a) provides improved performance compared to the base model due to its larger training dataset. It captures more linguistic variations, improves generalization, and enhances the accuracy of text classification in Bengali.

(c) **ALBERT based Transformer Models:** ALBERT (A Lite BERT) (Lan et al., 2019) has shown that superior

¹⁴<https://github.com/sagorbrur/bangla-bert>

Table 12

Architecture details of the pre-trained transformer models

Architecture	Used Model	L	H	P
	BanglaBERT	12	12	110M
ELECTRA	BanglaBERT Generator	12	4	34M
	BanglaBERT Large	24	16	335M
BERT	BanglaBERT Base	12	12	110M
ALBERT	sahajBERT	24	16	18M

language models do not necessarily require larger models. It achieves this by utilizing the same encoder segment architecture as the original Transformer but with three crucial modifications: factorized embedding parameters, cross-layer parameter sharing, and employing Sentence-order prediction (SOP) instead of Next Sentence Prediction (NSP). In the context of Bengali language, *sahajBERT*¹⁵ is a collaborative pre-trained ALBERT model that utilizes masked language modeling (MLM) and Sentence Order Prediction (SOP) objectives.

5.4. Proposed Ensemble Model

Several studies (Gutierrez-Espinoza, Abri, Namin, Jones and Sears, 2020; Javed, Majeed, Mujtaba and Beg, 2021) have employed ensemble methods to identify fake reviews and explored the usefulness of these techniques in classification tasks. In classification, combining the power of several models in an ensemble highlights the strengths of each model. If one model fails to accurately predict a testing sample, the other models work collectively to compensate for the shortcomings of that model. In our study, we have considered five pre-trained models that were fine-tuned on the

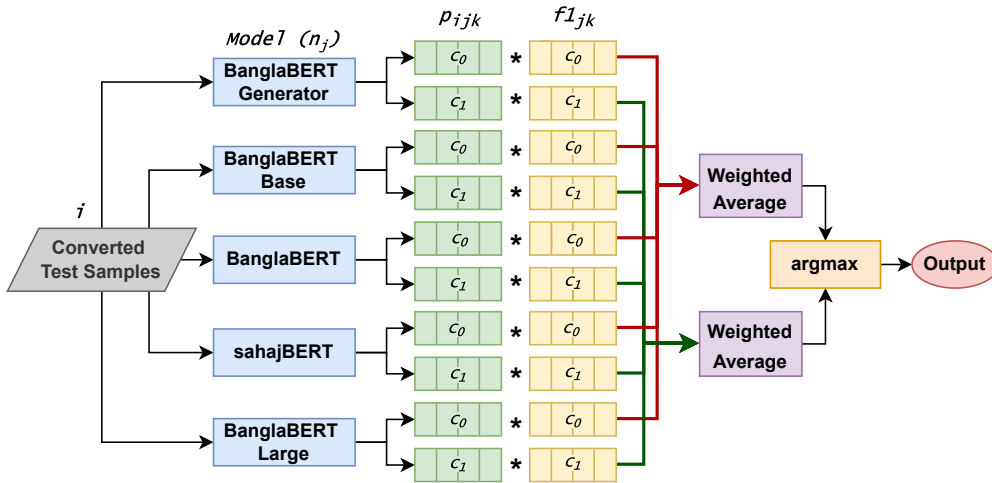

Figure 6: Architecture of the proposed weighted ensemble model for two classes. $C_{k=0}$ denotes the *fake* class and $C_{k=1}$ denotes the *Non-fake* class

Bengali corpus for the ensemble i.e. *BanglaBERT* (Bhattacharjee et al., 2022a), *BanglaBERT Generator* (Bhattacharjee et al., 2022a), *BanglaBERT Large* (Bhattacharjee et al., 2022a), *BanglaBERT Base* (Sarker, 2020), and *sahajBERT*¹⁶. By working together, they form an efficient ensemble of transformer models. We have utilized two ensemble methods: average and weighted ensemble. The average ensemble technique (Gundapu and Mamidi, 2021; Shifath, Khan, Islam et al., 2021) considers the average of softmax probabilities of all the models and selects the predicted class with the highest score, making the individual predictions relatively less important. On the other hand, the weighted ensemble technique considers the prior predictions of the individual models. Our approach for the weighted ensemble technique differs slightly from the one presented in (Sharif and Hoque, 2022). We compared our technique with theirs in Section 6.7. In our method, we use the prior f1-scores of each class, and multiply them by the class probabilities (softmax),

¹⁵<https://huggingface.co/neuropark/sahajBERT>

¹⁶<https://huggingface.co/neuropark/sahajBERT>

which serves as an additional weight for the softmax probabilities. Figure 6 shows a schematic diagram of our proposed ensemble technique for two classes. To give more importance to the prediction of each individual class, we use the individual f1 scores for each class, assuming that the corresponding class is a positive one.

Suppose we have m testing samples and n models in our ensemble approach. Each of the test samples is classified in c classes. The model n_j generates a probability (softmax) for class c_k for each m_j sample which is denoted by p_{ijk} . The prior f1-scores of the c classes of n models evaluated on the testing set are $f_{111}, f_{112}, \dots, f_{11c}, f_{121}, f_{122}, \dots, f_{12c}, \dots, f_{1n1}, f_{1n2}, \dots, f_{1nc}$ (assuming each class as positive). Taking into account all the values shown earlier, Eq. 2 generates the final result by the proposed ensemble technique for multiple classes.

$$O = \operatorname{argmax} \left(\forall_{i \in (1, m)} \left(\frac{\sum_{j=1}^n p_{ij0} * f_{1j0}}{\sum_{j=1}^n f_{1j0}}, \frac{\sum_{j=1}^n p_{ij1} * f_{1j1}}{\sum_{j=1}^n f_{1j1}}, \dots, \frac{\sum_{j=1}^n p_{ijk} * f_{1jk}}{\sum_{j=1}^n f_{1jk}} \right) \right) \quad (2)$$

Here, O stands for the output vector that contains the prediction of our suggested ensemble technique for m individual samples.

The process of utilizing the weighted ensemble technique to make predictions is outlined in Appendix C. At first, we multiply the probabilities (softmax) of each class by their corresponding f1 scores and then add them together. We then normalize the individual scores for each class by dividing the sum of the prior f1 scores of the models for that class. Finally, we identify the highest estimated scores across all classes and determine the final prediction.

6. Experiments and Result Analysis

In this section, we present the details of our experiments including the hyper-parameter settings for the detection models. We provide a comprehensive analysis of the results obtained from both independent models and ensemble techniques, including both quantitative and qualitative aspects. Furthermore, we investigate misclassified reviews and categorize the types of errors encountered. Finally, we compare our approach with an existing weighted ensemble technique. Details of the evaluation metrics used in our study can be found in Appendix D.

6.1. Experimental Setup

For experimentation purpose, we utilized CNN, BiLSTM, CNN-BiLSTM, and CNN-BiLSTM with an attention mechanism as deep learning models, along with *BanglaBERT* (BB), *BanglaBERT Generator* (BBG), *BanglaBERT Base* (BBB), *sahajBERT* (SB), and *BanglaBERT Large* (BBL) transformer models. We proposed a weighted ensemble approach which involves combining different combinations of transformer models. We conducted three experiments for both the individual models and ensemble techniques: one with no augmentation, one with augmented fake reviews by *nlpaug*, and one with augmented fake reviews by *bnauug*. We referred to the experiment without any augmentation as **Approach-1**, while we used the labels **Approach-2** and **Approach-3** to describe the experiments that utilized the *nlpaug* and *bnauug* augmentation techniques respectively.

6.2. Hyper-parameter Settings

We used Jupyter Notebook as an integrated development environment (IDE) for most of our experiments. Our experiments were carried out using the Asus Dual GeForce RTX 3060 V2 12GB GDDR6 GPU, which was equipped with built-in 16GB RAM and 1TB of storage space. For some of our experiments, we also employed Google Collaboratory with a 13GB back-end GPU and 12GB of local GDDR5 RAM. The Python version we used was 3.6.13 along with numpy (1.19.2) and pandas (1.1.5). Deep learning models were implemented using Tensorflow 2.12.0 and Keras 2.12.0. Scikit-learn 1.2.2 was used to evaluate performance metrics. For the transformer models, we used version 4.28.1 of transformers and implemented them using the PyTorch library. In our experiments, we ensured that each of the train, validation, and test sets were completely distinct. We present the data split in Table 7. After properly validating the models on the validation set and training on the training data, we evaluated them using samples from the test sets. The hyper-parameters such as batch size, learning rate, and number of epochs utilized in the experiments are listed in Appendix E through a table. We obtained the optimal hyper-parameters by experimenting within a wide hyper-parameter space. It is worth noting that due to memory constraints, the input sequence length for all models, except *sahajBERT* and *BanglaBERT Large* was limited to 512. However, the input sequence length was 256 for these two models.

Table 13

Performance comparison of five individual trials with a random sampling of non-fake reviews for *Bangla BERT* model without any augmentation (Approach - 1)

Trial No.	Fake			Non-Fake			WF1	ROC-AUC	MCC
	P	R	F1	P	R	F1			
1	0.886	0.694	0.778	0.748	0.910	0.822	0.800	0.802	0.619
2	0.841	0.709	0.769	0.748	0.866	0.803	0.786	0.787	0.582
3	0.811	0.799	0.805	0.801	0.813	0.807	0.806	0.806	0.612
4	0.838	0.694	0.759	0.739	0.866	0.797	0.778	0.780	0.568
5	0.867	0.679	0.762	0.736	0.896	0.808	0.785	0.787	0.589

6.3. Results

To start our analysis, we first present the experimental results of the deep learning and transformer models. The results of Approach-1 for the individual models are shown in Tables 14 and a comparative analysis of Approach-2, and Approach-3 for four augmented samples along with the original fake data through a bar chart can be seen in Fig. 7. The detailed result of Approach-2 and Approach-3 is shown in Appendix F through Tables 24 and 25. For ensemble techniques, four augmented fake data per review along with the actual one are considered for Approach-2 and Approach-3, and their results are shown in Tables 16 and 17. On the other hand, Table 15 shows the results of all combinations of Approach-1. Appendix F provides the results using 0 to 3 augmented fake data per review in Tables 26 and 27 for Approach-2 and Approach-3 respectively. The two ensemble approaches (average and weighted) comprise of six combinations (5 for four individual and 1 for five individual transformer models) out of all possible combinations of the five distinct transformer models. Gradual performance improvement can be observed for individual models on both Approach-2 and Approach-3 as shown in Figure 9. These charts demonstrate the importance of augmentation in our imbalanced dataset.

6.4. Quantitative Analysis

This section aims to empirically justify the performance of the models and is divided into two parts. The first part discusses the deep learning models and transformers, while the second part covers the ensemble techniques.

6.4.1. Deep Learning and Transformer Models

This section is divided into three parts taking into account the use of data augmentation. Firstly, we present the results without any data augmentation. Then, we discuss the results obtained with the addition of two data augmentation techniques aiming to improve the performance of the models.

• **Approach-1:** An equal number (1339) of data from each label are utilized when there is no augmentation. Due to the unequal distribution of data between fake and non-fake classes, only 1339 of the 7710 non-fake data are randomly taken into account while preserving a 1:1 ratio with the fake data. Table 13 illustrates five individual trials that randomly selected 1339 samples from the 7710 non-fake data along with 1339 fake samples for the Bangla BERT model. Random sampling of non-fake data yields identical results in all the cases, varying only by 0.026% in terms of weighted f1 score with a mean of **0.791** and a standard deviation of **0.01157** which is quite acceptable.

In this experiment, deep learning techniques like CNN, BiLSTM, and their combinations performed remarkably well. The performance of the models on the small quantity of data is almost identical for CNN, BiLSTM, and CNN BiLSTM with attention layer, each with a weighted-f1 (WF1) of 0.757, 0.769, and 0.761 which can be seen at Table 14. The model's ability to predict the fake review with a very little number of training data is further supported by the ROC-AUC and MCC scores. With a low WF1 of 0.694 and MCC of 0.388, the hybrid CNN-BiLSTM model is marginally under performing in the absence of augmentation. Transformers play a better role in this case. Among all the models, *BanglaBERT* (BB) has produced the best results, with a promising WF1 and MCC of 0.809 and 0.621 respectively. *BanglaBERT Generator* (BBG) and *BanglaBERT Base* (BBB) exhibit comparable performances, with WF1 scores of 0.809 and 0.806 respectively. *BanglaBERT Large* (BBL), which is trained with approximately half as many tokens than other models, achieves excellent results with WF1 of 0.787 and MCC of 0.577. As can be observed in Table 14 where the recall value of the fake class is lower than the precision value and the converse for the non-fake class, it should be noted that BBL is slightly biased to the fake class as it predicts the non-fake classes as fake in

Table 14

Performance comparison among individual models without any augmentation (Approach - 1)

Model	Fake			Non-Fake			WF1	ROC-AUC	MCC
	P	R	F1	P	R	F1			
CNN	0.759	0.754	0.757	0.756	0.761	0.758	0.757	0.823	0.515
BiLSTM	0.765	0.776	0.770	0.773	0.761	0.767	0.769	0.833	0.537
CNN BiLSTM	0.694	0.694	0.694	0.694	0.694	0.694	0.694	0.794	0.388
CNN BiLSTM with Attention	0.769	0.746	0.758	0.754	0.776	0.765	0.761	0.819	0.523
Bangla BERT (BB)	0.832	0.776	0.803	0.790	0.843	0.816	0.809	0.810	0.621
Bangla BERT Generator (BBG)	0.806	0.813	0.809	0.811	0.805	0.808	0.809	0.809	0.617
Bangla BERT Base (BBB)	0.811	0.799	0.805	0.801	0.813	0.807	0.806	0.806	0.612
sahaj BERT (SB)	0.755	0.597	0.667	0.667	0.806	0.730	0.698	0.701	0.412
Bangla BERT Large (BBL)	0.813	0.746	0.778	0.766	0.828	0.796	0.787	0.787	0.577

more situations than it predicts the fake classes as non-fake. With an MCC score of just 0.412, *sahajBERT* (SB) is the transformer that performs the worst.

• **Approach-2 & Approach-3:** The weighted-F1 scores of distinct individual models are shown in Fig.7 for approaches 2 and 3 in terms of four augmented samples along with the original fake review. The chart clearly shows that models using the *bnaug* augmentation strategy performed lower than those using *nlpaug*. The overall performance of approach-3 has decreased by 2% to 4% compared to models of approach-2. Despite the short sequence length, only SB and BBL perform well; their respective WF1 values are 4.4% and 3.1% higher than those of previous studies using *nlpaug*. In approach-2, the CNN and BiLSTM hybrid models outperform the standalone models. The model developed with CNN-BiLSTM and an attention layer achieved the best WF1 (0.978) for four separate augmentations. In the presence of augmentation, transformers produce results that are similar to those of DL techniques. BanglaBERT (BB) performs best in terms of WF1 score (0.981) for four distinct augmentations. In approach-3, the hybrid model with CNN and BiLSTM outperformed the separate models somewhat. Similar to other experiments using *nlpaug*, BB and BBG here yield the best results. BBG and BB achieved the highest WF1 of 0.947 and 0.943. The detailed results of all the individual models for approach-2 and 3 can be seen in Appendix F,

6.4.2. Ensemble Approaches

The ensemble technique is utilized to overcome the limitations of individual models, and in this paper, we employ two ensemble approaches: average and weighted. To address data augmentation, this section is also divided into three segments. Each instance is categorized into two separate groups using the two ensemble techniques mentioned earlier. In the weighted approach, the f1 scores of each class for each model are considered to maintain the significance of each class separately, as described in section 5.4. The two ensemble approaches (average and weighted) comprise of six combinations (5 for four individual and 1 for five individual transformer models) out of all possible combinations of the five distinct transformer models. We refer the combinations

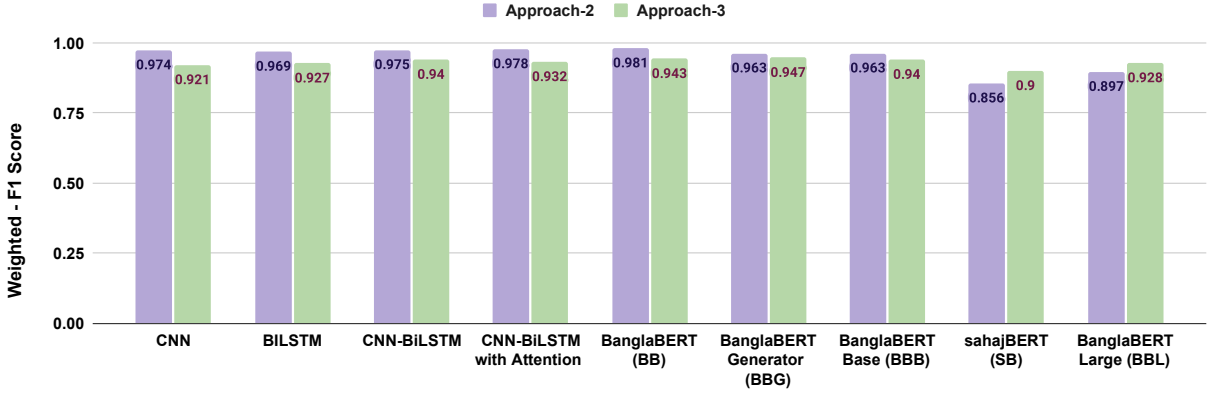

Figure 7: Comparison of weighted-F1 scores of different models for four augmented samples along with the original fake data using *nlpaug* (Approach-2) and *bnauug* (Approach-3) augmentation techniques

Table 15

Performance comparison between two ensemble approaches (average and weighted) without any augmentation (Approach - 1)

Methods		Fake			Non-Fake			WF1	ACC	ROC-AUC	MCC
		P	R	F1	P	R	F1				
AVERAGE	EN1	0.86	0.81	0.84	0.82	0.87	0.84	0.8394	0.84	0.84	0.68
	EN2	0.84	0.80	0.82	0.81	0.84	0.82	0.8208	0.82	0.82	0.64
	EN3	0.83	0.81	0.82	0.82	0.84	0.83	0.8246	0.82	0.82	0.65
	EN4	0.85	0.81	0.83	0.82	0.86	0.84	0.8357	0.84	0.84	0.67
	EN5	0.84	0.81	0.82	0.81	0.85	0.83	0.8283	0.83	0.83	0.66
	EN6	0.85	0.81	0.83	0.82	0.86	0.84	0.8357	0.84	0.84	0.67
WEIGHTED	EN1	0.82	0.77	0.79	0.78	0.83	0.80	0.7983	0.80	0.80	0.60
	EN2	0.83	0.80	0.81	0.81	0.84	0.82	0.8171	0.82	0.82	0.63
	EN3	0.83	0.81	0.82	0.82	0.83	0.82	0.8209	0.82	0.82	0.64
	EN4	0.85	0.81	0.83	0.82	0.86	0.84	0.8357	0.84	0.84	0.67
	EN5	0.84	0.81	0.82	0.81	0.84	0.83	0.8246	0.82	0.82	0.65
	EN6	0.85	0.82	0.83	0.83	0.85	0.84	0.8358	0.84	0.84	0.67

as: (a) **EN1**: BBG+BB+BBL+BBB, (b) **EN2**: BB+BBL+BBB+SB, (c) **EN3**: BBG+BB+BBL+SB, (d) **EN4**: BBG+BB+BBB+SB, (e) **EN5**: BBG+BBL+BBB+SB and (f) **EN6**: BBG+BB+SB+BBL+BBB.

• **Approach-1:** In case of ensemble approaches (average and weighted), all the underlying ensemble models performed better than the individual model which can be seen in Table 14. The lowest WF1 for the ensemble is 0.8208 which is achieved by EN2 in both techniques. The best performance is shown by the combination of EN1 in the average case which is 0.8394 but dropped by almost 4% in the weighted case. The result of EN6 which is the combination of all the transformers shows the highest performance in the weighted case without augmentation.

• **Approach-2:** With the increase of the augmented samples in each of the combinations, Table 16 clearly shows the constant escalation of the performance. Since only combinations of four and five models have been considered, there is a little difference between the average and weighted ensemble models. Therefore, if one model can not accurately predict some scenarios, another model can correct the incorrect predictions and offer a strong performance when combined. Since *BanglaBERT* is the best performing individual model, as seen in Table 24, its dominance is clearly visible. EN5, a combination without BB, does not produce the same outcomes as other combinations with BB, which are roughly 1% less effective in each case of augmentation. On the other hand, *sahajBERT* (SB) is the lowest-performing individual model which also affects the result here. We can see that EN1 which is an ensemble of transformers without SB is the

Table 16

Performance comparison between two ensemble approaches (average and weighted) on four augmentations per actual fake review generated using *nlpaug* (Approach - 2)

Methods		Fake			Non-Fake			WF1	ACC	ROC-AUC	MCC
		P	R	F1	P	R	F1				
AVERAGE	EN1	0.98	0.99	0.98	0.98	0.98	0.98	0.9808	0.98	0.98	0.97
	EN2	0.98	0.98	0.98	0.98	0.98	0.98	0.9805	0.98	0.98	0.96
	EN3	0.98	0.97	0.97	0.97	0.98	0.97	0.9731	0.97	0.97	0.95
	EN4	0.97	0.99	0.98	0.99	0.97	0.98	0.9768	0.98	0.98	0.95
	EN5	0.97	0.97	0.97	0.97	0.97	0.97	0.9686	0.97	0.97	0.94
	EN6	0.97	0.98	0.98	0.98	0.97	0.98	0.9768	0.98	0.98	0.95
WEIGHTED	EN1	0.97	0.99	0.98	0.99	0.97	0.98	0.9843	0.98	0.98	0.96
	EN2	0.98	0.98	0.98	0.98	0.98	0.98	0.9805	0.98	0.98	0.96
	EN3	0.98	0.99	0.98	0.98	0.98	0.98	0.9813	0.98	0.98	0.96
	EN4	0.97	0.99	0.98	0.99	0.97	0.98	0.9798	0.98	0.98	0.96
	EN5	0.97	0.98	0.98	0.98	0.97	0.98	0.9775	0.98	0.98	0.96
	EN6	0.97	0.99	0.98	0.99	0.97	0.98	0.9805	0.98	0.98	0.96

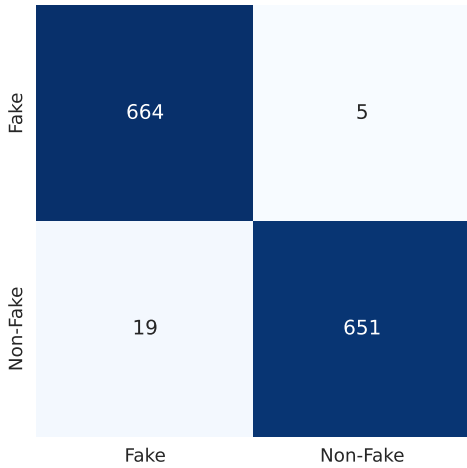

(a) Approach - 2 (EN1)

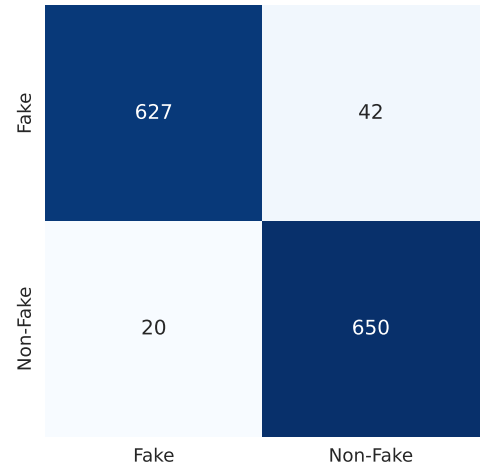

(b) Approach - 3 (EN1)

Figure 8: Confusion matrix of the proposed weighted ensemble model for approach - 2 and approach - 3

highest-performing model in both the average and weighted cases. Figure 8a shows that EN1 ensemble model classifies 19 non-fake classes as fake due to high similarities between fake and non-fake instances.

• **Approach-3:** Due to the variance in generating augmented samples, ensemble approaches exhibit almost 3% lower performance when augmented samples by *bnauug* are used instead of *nlpaug*. The highest performing model is again EN1 for both the average and weighted ensemble having the same WF1 score of 0.9558 illustrated in Table 17. Figure 8b shows EN1 ensemble model classifies 42 fake classes as non-fake due to high similarities between the fake and non-fake instances. That is why the recall is lower than the precision considering the fake class as positive. The maximum MCC score of 0.91 obtained by these two cases supports the claim.

Table 17

Performance comparison between two ensemble approaches (average and weighted) on four augmentations per actual fake review generated using *bnaug* (Approach - 3)

	Methods	Fake			Non-Fake			WF1	ACC	ROC-AUC	MCC
		P	R	F1	P	R	F1				
AVERAGE	EN1	0.97	0.94	0.95	0.94	0.97	0.95	0.9558	0.95	0.95	0.91
	EN2	0.97	0.93	0.95	0.93	0.97	0.95	0.9491	0.95	0.95	0.90
	EN3	0.97	0.93	0.95	0.93	0.97	0.95	0.9483	0.95	0.95	0.90
	EN4	0.96	0.95	0.96	0.95	0.97	0.96	0.9528	0.96	0.96	0.91
	EN5	0.97	0.93	0.95	0.93	0.97	0.95	0.9491	0.95	0.95	0.90
	EN6	0.96	0.95	0.96	0.95	0.97	0.96	0.9528	0.96	0.96	0.91
WEIGHTED	EN1	0.97	0.94	0.95	0.94	0.97	0.95	0.9558	0.95	0.95	0.91
	EN2	0.97	0.93	0.95	0.93	0.97	0.95	0.9483	0.95	0.95	0.90
	EN3	0.97	0.93	0.95	0.93	0.97	0.95	0.9498	0.95	0.95	0.90
	EN4	0.96	0.94	0.95	0.94	0.97	0.95	0.9543	0.95	0.95	0.91
	EN5	0.98	0.92	0.95	0.93	0.98	0.95	0.9528	0.95	0.95	0.91
	EN6	0.97	0.93	0.95	0.94	0.97	0.95	0.9528	0.95	0.95	0.91

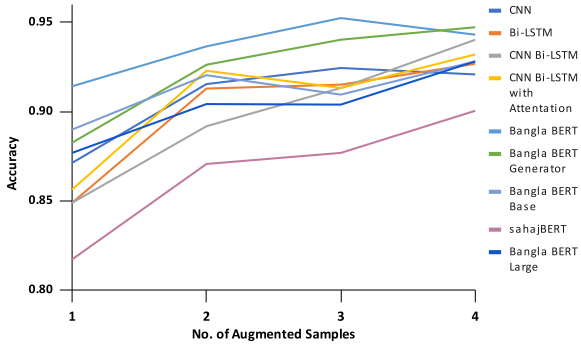

(a) Approach - 2 (nlpaug)

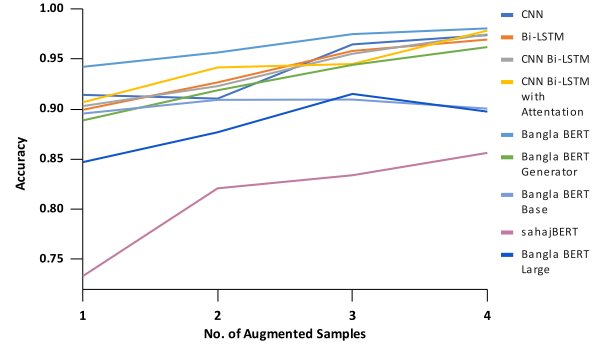

(b) Approach - 3 (bnaug)

Figure 9: Performance visualization of different models with increasing number of augmented fake review instances

6.4.3. Summary of Quantitative Analysis

Summarizing the findings, we observe that among the stand-alone deep learning models, CNN BiLSTM with attention layer has the highest WF1 score for approach-2 and CNN BiLSTM has the highest WF1 score for approach-3. Again *Bangla BERT* and *Bangla BERT Generator* are the best-performing transformer model for approach-2 and approach-3 respectively in terms of WF1 score. The proposed weighted ensemble model produced a 0.9843 weighted F1-score on 13390 reviews, of which 6695 were fake (1339 were genuine fakes, while the remaining 5356 were augmented using *nlpaug* and 6695 were non-fake (randomly chosen from 7710 cases). The same ensemble model was also used to generate a 0.9558 weighted F1-score when *bnaug* was used to augment fake reviews.

6.5. Qualitative Analysis

In this section, the quality of the models is evaluated in light of generalization performance on actual test samples. For this purpose, we used our proposed model which is the combination of all the transformers except *sahajBERT* (EN1) with both augmentation techniques. In addition to the initial samples for the fake class, four augmentation samples are used to train the models that are being examined here. Table 16 and 17 both demonstrate that EN1 is the best-performing model. Table 18 contains two samples from the test dataset; Two more samples^{17,18} can be found in

¹⁷<https://www.facebook.com/groups/foodbankbd/posts/6375361032571128/>

¹⁸<https://www.facebook.com/groups/foodbankbd/posts/6382876588486239/>

Table 18

Generalization performance on some unseen test reviews by the proposed weighted ensemble model. (0 stands for *fake* and 1 stands for *non-fake*)

Review	True Label	Approach -2	Approach -3
টাকা দিয়ে এই বিরিয়ানি কে খায় ভাই আর এটাকে বিরিয়ানি বলে? কার কাছে কেমন লাগে এই বোবার বিরিয়ানি? (Who eats this biryani with money and calls it biryani? Who likes this Boba's biryani?)	1	1	0
আপনি কি ডেসার্ট পাগল পেস্টি কেক দেখলে নিজেকে থামাতে পারেন না আর থামাতে হবে না। সাদা হল খাবার ভর্তি টেবিল এর বুফে তে পাচ্ছেন আনলিমিটেড পেস্টি কেক তাও আবার ৪ ধরনের। আছে বিভিন্ন ফ্লেভারের মুস ডোনাট এবং আরো অনেক অনেক আইটেম। এইসব ডেসার্ট আইটেমের পাশাপাশি বুফে তে রয়েছে আরো অনেক আইটেম যেমন ফ্রাইড রাইস ফ্রাইড চিকেন ৩ ধরনের কাবাব বাটার এবং গারলিক ব্রেড ৩ ধরনের সুপ এবং আরো অনেক আইটেম। ৯ ১০ স্টুডেন্ট অফারে ৭৫০ টাকার বুফেতে পাচ্ছেন ১০% ছাড়। শুধু মাত্র লাচ এর জন্য (Are you crazy about desserts? Can't stop yourself when you see a pastry cake? You don't have to stop anymore. You can get unlimited pastry cakes in the buffet of the White hall with a full table, there are also 4 types of mousse donuts of different flavors and many more items. In addition to these dessert items, the buffet has many other items such as fried rice, fried chicken, 3 types of kebabs, butter and garlic bread, 3 types of soup and many more items. 9/10 student offer 750 taka buffet get 10% discount. Just for lunch)	0	1	0

Appendix G which come from recent posts on social media. The first one from Table 18 is a negative review which is asking questions and is somewhat deceptive for the model trained with *bnauug* (approach-3), Approach-2 correctly determined it to be non-fake, but approach-3 could not. The reverse situation occurs in the second example, where approach-2 fails to accurately identify it as fake since it did not contain the commonly used word in fraudulent reviews. We have provided some reasons for the behavior of the models, but they are based on assumptions and may not fully explain why the models behave in a certain way with respect to a particular testing sample. To better understand the behavior of the models, we have turned to explainable AI techniques. Specifically, we utilized the Local Interpretable Model Agnostic Explanation (LIME) (Ribeiro et al., 2016) approach in our analysis. Table 19 displays some samples with important features highlighted by LIME based on the predictions of the BanglaBERT models. We provide side by side comparison as BanglaBERT was trained using both *nlpaug* and *bnauug* augmentation techniques. The table utilizes different shades of orange and blue to indicate the words responsible for predicting a review as non-fake or fake respectively. The words with the most dominant impact are colored in deep blue or deep orange while the less dominant words are colored in lighter shades of the same colors. The samples in the table are accurately classified. Some more examples of misclassified data are can be found in Appendix G.

The first two samples show that both models are concentrating on nearly identical terms, which explains why they predicted the example as non-fake and fake separately. The two most prevalent terms in the first sample for both models are *গরমে* and *লাচ্ছর* which are the primary factors for predicting the sample as not fake while the word *রেটিং* does the opposite. The prediction to classify as fake in the second example is caused by the terms *অফার*, *মিস* which are frequently used in fake reviews.

6.6. Misclassification Analysis

We gathered all the reviews that were incorrectly classified by our ensemble approach. We then conducted a manual analysis of these instances to identify the reasons for misclassifications. Through this analysis, we were able to identify five distinct categories of errors which are discussed in detail below:

(a) Inability to handle negation: The possible reason behind misclassification could be the inability of the proposed model to comprehend negation. For example, the review instance *স্বাদ আগের মতো রয়েছে বলবো নাহ। আগের থেকে মনে হলো আরো ভালো লেগেছে। [I will not say that the taste is the same as before. I think I like it more than before.]* might have been misclassified because the model was unable to comprehend that the taste of the food had improved, as it failed to

Table 19

Feature importance explanation generated by LIME based on the best performing individual model (*BanglaBERT*). Here, the true level of the data is given on top of each review

Reviews	LIME Outputs	Predictions
non-fake		
এই গরমে কলিজা ঠাণ্ডা করার জন্য এরকম এক গ্লাস লাচ্ছি যথেষ্ট। না খেলে আসলে বুঝানো যাবেনা এই লাচ্ছির টেস্ট কেমন। দাম মাত্র ৩০ টাকা। রেটিং ৯.৫/১০ (A glass of lassi is enough to cool down the heart in this heat. If you don't drink it, you can't really understand how the test of this lassi is. The price is only 30 taka. Rating 9.5/10)	Approach-2 এই গরমে কলিজা ঠাণ্ডা করার জন্য এরকম এক গ্লাস লাচ্ছি যথেষ্ট। না খেলে আসলে বুঝানো যাবেনা এই লাচ্ছির টেস্ট কেমন। দাম মাত্র ৩০ টাকা। রেটিং ৯.৫/১০	non-fake
	Approach-3 এই গরমে কলিজা ঠাণ্ডা করার জন্য এরকম এক গ্লাস লাচ্ছি যথেষ্ট। না খেলে আসলে বুঝানো যাবেনা এই লাচ্ছির টেস্ট কেমন। দাম মাত্র ৩০ টাকা। রেটিং ৯.৫/১০	non-fake
fake		
১০০ টাকার মাটন বাসমতি কাচ্চি জাস্ট চেটে পুটে খেয়েছি জাস্ট চেটে পুটে খেলাম এই অফার লুফে না নিলে ব্যাপক মিস হতো ব্যাপক মিস। ধানমন্ডি ২৭ জেনেটিক প্লাজার অপজিটে (I have eaten the 100 taka mutton basmati kacchi to the fullest. if you don't take advantage of this offer, it would have been a big miss. Dhanmondi 27. Opposite Genetic Plaza)	Approach-2 ১০০ টাকার মাটন বাসমতি কাচ্চি জাস্ট চেটে পুটে খেয়েছি জাস্ট চেটে পুটে খেলাম এই অফার লুফে না নিলে ব্যাপক মিস হতো ব্যাপক মিস। ধানমন্ডি ২৭ জেনেটিক প্লাজার অপজিটে	fake
	Approach-3 ১০০ টাকার মাটন বাসমতি কাচ্চি জাস্ট চেটে পুটে খেয়েছি জাস্ট চেটে পুটে খেলাম এই অফার লুফে না নিলে ব্যাপক মিস হতো ব্যাপক মিস। ধানমন্ডি ২৭ জেনেটিক প্লাজার অপজিটে	fake

take into account the negation in the statement.

(b) Inability to deal with contexts: During the translation and transliteration process of reviews, semantic information can be lost leading to a change in the meaning of the sentence. For instance, in this example, না খাইলে আপনার লস গভীর সমুদ্র কল্পনা [*Your loss if you do not try deep sea fantasy*] a pizza named “deep sea fantasy” was mistranslated causing the meaning of the sentence to be altered. Some reviews involve irrelevant or extraneous information not focused on the food which is difficult to process for the model. For instance, the review রাজা রাজ্য দখল করবে এটাই সাভাবিক কিছু বিপত কিছু দিন ধরে রানী রাজ্য দখলের কাজ হাতে নিয়েছে। কি দিন আইলো বুঝি নাহ বার্গার রাণী মোহাম্মদপুর মিরপুরে এতো দিন রাজত্ব করে এখন মোহাম্মদপুরে। তাই ভাবলাম এবার একটু তার রাজ্য দেখিয়া আসি। প্রথমে খুজে পেতে একটু কষ্ট হলেও পরে ঠিকমতো পেয়ে গেলাম। মোহাম্মদপুর কেন্দ্রীয় কলেজের পাশেই। ইন্টেরিয়র নিয়ে নিয়ে মাথা ব্যাথা একটু বেশি আমার। তাই আগে আসি ইন্টেরিয়রের কথায়। কম জায়গার মধ্যে অনেক ভালো ইন্টেরিয়র ছিলো আমার মতে। কালো মানিকের দেশে যাবো আর কালো মানিকের স্বাদ নিবো নাহ তা কি করে হয় নিয়েছিলাম একটি ব্লাক বার্গার ৯৫টাকা এবং একটি বেঞ্জাবয়েজ বার্গার ৭০টাকা। [*It is normal that the king will take over the kingdom, but for the past few days, the queen has taken up the task of taking over the kingdom. I don't understand what days have come. Burger Queen Mohammadpur has been reigning in Mirpur for so long now in Mohammadpur. So I thought let's see his kingdom. At first it was a little difficult to find, but later I got it right. Next to Mohammadpur Central College. My headache is a bit more with the interior. So let's talk about the interior first. A much better interior in less space in my opinion. How can I go to the land of black manik and not taste black manik? Took a black burger for 95 taka and a bengboyz burger for 70 taka.*] discusses the location, interior and reputation of a restaurant rather than the food.

(c) Repetition of words: We found some misclassified reviews where we noticed that some words are frequently repeated such as ফ্রী ফ্রী ফ্রী ফ্রী ফ্রী ফ্রী ফ্রী ফ্রী কাবাবওয়ালার ফুড আইটেম দুইটা কিনলে একটা ফ্রি এর পোস্ট দেখে খাওয়ার জন্য গিয়েছিলাম। কিছু অফার কালকে থেকে এই ডেটটা আমি খেয়াল করিনি। আমি তাদের রেগুলার কাস্টমার আমি শোনার পরে যে হতাশার ছাপ টা মুখে প্রকাশ পেয়েছে সেটা তারা বুঝেছে এবং আমাকে অফারটি দিয়েছে। অনেক অনেক ধন্যবাদ এর জন্য কাবাবওয়ালাকে। লোকেশন হাজীপারা এপেক্স শোরুম এর উল্টাপাশে। রামপুরা। কাবাবওয়ালার রামপুরা [*Free Free Free Free Free Free Free Free Kababwala's food items if you buy two, I saw the post of one free and went to eat. But I didn't notice this date from the offer tomorrow. After hearing that I am their regular customer, they understood the look of disappointment on my face and gave me the offer. Many many thanks to Kebabwala for this. Location Hajipara opposite Apex Showroom. Rampura. Kebabwala Rampura*]. It seems that the text is discussing some misclassified reviews where the word “free” is repeatedly used in order to draw attention to the reviewer’s positive experience of receiving a free food item from the restaurant. We

Table 20

Performance comparison by applying another existing ensemble approach on the BFRD dataset

Ensemble Model	Approach - 2	Approach - 3
(Sharif and Hoque, 2022)	0.982784	0.955820
Proposed	0.984279	0.955825

believe that the model becomes confused during prediction because both genuine and fake misclassified reviews are affected by the issue of frequently repeating words.

(d) Usage of common words: Sometimes those who fabricate reviews alter certain words and sentence structures of an authentic review to make it appear genuine. We conducted an analysis on the misclassified reviews and discovered that the top 100 most common words were present in both fake and non-fake reviews. Among the highly recurring words are অফার, ফ্রী, ভাল, মজার, ধন্যবাদ, সেরা, অনেক, টেস্ট, ভাবলাম, গেলাম.

(e) Fewer tokens: Some reviews might be wrongly classified as there is insufficient information due to a lack of tokens. For example, the review পিцца ওয়ে টেস্ট আর দাম এর জন্য স্বনামধন্য নাম। পিцца অফার খেলাম মাত্র ৩০০ টাকায়। বার্গার মাত্র ৯৯ টাকায়। [*Pizza way is famous for taste and price. Tried pizza offer only for 300 taka. Burger is only 99 taka.*] simply advertises the offers and does not provide sufficient information about the food. One more such example is সেরা মুহূর্ত লাভডগগার মিরপুর এর সঙ্গে। এই ভালোবাসার ওয়েজেস মাত্র ১২০ টাকা। [*Best Moments with Lovedogger Mirpur. Lovely wedges are only 120 taka.*]

6.7. Comparison with an Existing Ensemble Approach

As there was no previous work done in detecting fake reviews in the Bengali language, we were unable to directly compare our results with those of other studies. To address this limitation, we decided to compare our findings with those of a similar study conducted on a Bengali text dataset. (Sharif and Hoque, 2022) proposed a weighted ensemble approach on the Bengali aggressive text dataset (BAD) to detect aggressive texts in Bengali. The ensemble method they proposed uses weighted f1 scores as an additional weight for the softmax probabilities for both classes. They computed the individual f1 scores of each model and multiplied the scores as an additional weight to the softmax probability. We applied their proposed method on our BFRD dataset and compared the results using Approach-2 and Approach-3. The comparative results presented in Table 20 indicate that the outcomes from our proposed ensemble model on both approaches are very close. Though our proposed ensemble model marginally outperform the method presented in (Sharif and Hoque, 2022) in terms of weighted F1-scores, the difference is negligible. This implies that our proposed ensemble approach can be a viable solution for other text classification tasks in the Bengali language.

7. Limitations and Future Work

Identifying fake reviews is challenging because of the scarcity of fake reviews on different online platforms. It is obvious that our dataset is quite imbalanced, thus we used augmentation techniques to compensate. Furthermore, we could only offer a limited amount of fake data due to the insufficient number of skilled annotators that worked on this project. So, compiling and curating additional fake reviews with experienced annotators could be a great future work. The dataset utilized in this study is limited to restaurant reviews because of the difficulties involved in the data collection and curation process. The study can be expanded to find fake reviews in other categories, such as those for electronics, hotels, movies, books, and more. We also encountered resource constraints, which resulted in fewer sequence lengths for several models, such as sahaBERT and BanglaBERT Large. That may account for the poor performance of these LLMs. In the future, these models can be reassessed using larger sequence lengths. Exploration of different large language models (LLMs) for converting the code-mixed reviews can be another prospect of this research. An experiment to divide up the dataset and detect several types of fake reviews could be an exciting extension of this work. It would be worth exploring the possibility of developing a detection system or model that could effectively address the various categories of misclassification that have been identified. However, with the use of the proposed model on the fake review dataset, online platforms may benefit from establishing a real-time detection system that can track and flag probable fraudulent reviews as they are submitted.

8. Conclusion

This study addresses the significant concern of the rise of fake reviews in Bengali language on various online platforms. Firstly, the Bengali Fake Review Detection (BFRD) dataset containing over 9,000 food-related reviews has been developed and made publicly accessible. The dataset was carefully annotated by expert annotators, making it a valuable resource for identifying fake reviews in Bengali. Secondly, a weighted ensemble model consisting of four pre-trained Bengali language models has been proposed, outperforming other deep learning and transformer models. Thirdly, a unique text conversion pipeline was created to translate non-Bengali words to Bengali and back transliterate Romanized Bengali to Bengali. Fourthly, text augmentation techniques were employed to handle class imbalance and increase the number of fake review instances. The proposed weighted ensemble model consisting of four different pre-trained BERT models produced a 0.9843 weighted F1-score on 13390 reviews, of which 6695 were fake (1339 were genuine fakes, while the remaining 6695 were augmented using nlpaug library and 6695 were non-fake (randomly chosen from 7710 cases). Finally, extensive experimentation was conducted, and both quantitative and qualitative analysis of the results were presented, including explanations for some of the model's predictions using the LIME text explainer framework. These contributions are crucial towards addressing the issue of fake reviews in Bengali language and can benefit consumers, businesses, and the online review industry as a whole.

Declarations

8.1. Credit authorship contribution statement

G. M. Shahariar: Conceptualization, Data collection, Methodology, Implementations, Drafting the manuscript.
Md Tanvir Rouf Shawon: Conceptualization, Data collection, Methodology, Implementations, Drafting the manuscript.
Faisal Muhammad Shah: Conceptualization, Data collection, Methodology, Manuscript review, Supervision.
Mohammad Shafiqul Alam: Data collection, Supervision. **Md. Shahriar Mahub:** Conceptualization, Methodology, Manuscript review, Supervision.

8.2. Ethical Approval and Consent to participate

Not applicable.

8.3. Consent for publication

Not applicable.

8.4. Human and Animal Ethics

Not applicable.

8.5. Competing interests

The authors declare that they have no competing interests.

8.6. Funding

This research work is funded by Ahsanullah University of Science and Technology, Dhaka (AUST) Internal Research Grant supported by The Committee For Advanced Studies And Research (CASR) [Project ID: ARP/2021/CSE/01/2]

References

- Akil, A., Sultana, N., Bhattacharjee, A., Shahriyar, R., 2022. Banglaparaphrase: A high-quality bangla paraphrase dataset. arXiv preprint arXiv:2210.05109 .
- Banerjee, S., Chua, A.Y., Kim, J.J., 2015. Using supervised learning to classify authentic and fake online reviews, in: Proceedings of the 9th international conference on ubiquitous information management and communication, pp. 1–7.
- Bhattacharjee, A., Hasan, T., Ahmad, W., Mubasshir, K.S., Islam, M.S., Iqbal, A., Rahman, M.S., Shahriyar, R., 2022a. BanglaBERT: Language model pretraining and benchmarks for low-resource language understanding evaluation in Bangla, in: Findings of the Association for Computational Linguistics: NAACL 2022, Association for Computational Linguistics, Seattle, United States. pp. 1318–1327. URL: <https://aclanthology.org/2022.findings-naacl.98>.
- Bhattacharjee, A., Hasan, T., Ahmad, W.U., Shahriyar, R., 2022b. Banglanlg: Benchmarks and resources for evaluating low-resource natural language generation in bangla. CoRR abs/2205.11081. URL: <https://arxiv.org/abs/2205.11081>, arXiv:2205.11081.

- Clark, K., Luong, M.T., Le, Q.V., Manning, C.D., 2020. Electra: Pre-training text encoders as discriminators rather than generators. arXiv preprint arXiv:2003.10555 .
- Cohen, J., 1960. A coefficient of agreement for nominal scales. Educational and psychological measurement 20, 37–46.
- Devlin, J., Chang, M.W., Lee, K., Toutanova, K., 2019. BERT: Pre-training of deep bidirectional transformers for language understanding, in: Proceedings of the 2019 Conference of the North American Chapter of the Association for Computational Linguistics: Human Language Technologies, Volume 1 (Long and Short Papers), Association for Computational Linguistics, Minneapolis, Minnesota. pp. 4171–4186. URL: <https://aclanthology.org/N19-1423>, doi:10.18653/v1/N19-1423.
- Dhamani, N., Azunre, P., Gleason, J.L., Corcoran, C., Honke, G., Kramer, S., Morgan, J., 2019. Using deep networks and transfer learning to address disinformation. arXiv preprint arXiv:1905.10412 .
- Duan, W., Gu, B., Whinston, A.B., 2008. Do online reviews matter?—an empirical investigation of panel data. Decision support systems 45, 1007–1016.
- Etaiwi, W., Naymat, G., 2017. The impact of applying different preprocessing steps on review spam detection. Procedia computer science 113, 273–279.
- Fleiss, J.L., 1971. Measuring nominal scale agreement among many raters. Psychological bulletin 76, 378.
- Graves, A., Schmidhuber, J., 2005. Framewise phoneme classification with bidirectional lstm and other neural network architectures. Neural networks 18, 602–610.
- Gundapu, S., Mamidi, R., 2021. Transformer based automatic covid-19 fake news detection system. arXiv preprint arXiv:2101.00180 .
- Guo, Y., Mustafaoglu, Z., Koundal, D., 2023. Spam detection using bidirectional transformers and machine learning classifier algorithms. Journal of Computational and Cognitive Engineering 2, 5–9.
- Gupta, P., Gandhi, S., Chakravarthi, B.R., 2021. Leveraging transfer learning techniques-bert, roberta, albert and distilbert for fake review detection, in: Forum for Information Retrieval Evaluation, pp. 75–82.
- Gutierrez-Espinoza, L., Abri, F., Namin, A.S., Jones, K.S., Sears, D.R., 2020. Ensemble learning for detecting fake reviews, in: 2020 IEEE 44th Annual Computers, Software, and Applications Conference (COMPSAC), IEEE. pp. 1320–1325.
- Ha, S.H., Bae, S., Son, L.K., 2015. Impact of online consumer reviews on product sales: Quantitative analysis of the source effect. Applied Mathematics and Information Sciences 9, 373–387.
- Hammad, A.A., El-Halees, A., 2013. An approach for detecting spam in arabic opinion reviews. The International Arab Journal of Information Technology 12.
- Hasan, T., Bhattacharjee, A., Samin, K., Hasan, M., Basak, M., Rahman, M.S., Shahriyar, R., 2020. Not low-resource anymore: Aligner ensembling, batch filtering, and new datasets for Bengali-English machine translation, in: Proceedings of the 2020 Conference on Empirical Methods in Natural Language Processing (EMNLP), Association for Computational Linguistics, Online. pp. 2612–2623. URL: <https://www.aclweb.org/anthology/2020.emnlp-main.207>, doi:10.18653/v1/2020.emnlp-main.207.
- Hernández-Castañeda, Á., Calvo, H., Gelbukh, A., Flores, J.J.G., 2017. Cross-domain deception detection using support vector networks. Soft Computing 21, 585–595.
- Javed, M.S., Majeed, H., Mujtaba, H., Beg, M.O., 2021. Fake reviews classification using deep learning ensemble of shallow convolutions. Journal of Computational Social Science , 1–20.
- Jindal, N., Liu, B., 2007. Review spam detection, in: Proceedings of the 16th international conference on World Wide Web, pp. 1189–1190.
- Jindal, N., Liu, B., 2008. Opinion spam and analysis, in: Proceedings of the 2008 international conference on web search and data mining, pp. 219–230.
- Khurshid, F., Zhu, Y., Xu, Z., Ahmad, M., Ahmad, M., 2019. Enactment of ensemble learning for review spam detection on selected features. International Journal of Computational Intelligence Systems 12, 387–394.
- Khurshid, F., Zhu, Y., Yohannese, C.W., Iqbal, M., 2017. Recital of supervised learning on review spam detection: An empirical analysis, in: 2017 12th International Conference on Intelligent Systems and Knowledge Engineering (ISKE), IEEE. pp. 1–6.
- Lan, Z., Chen, M., Goodman, S., Gimpel, K., Sharma, P., Soricut, R., 2019. Albert: A lite bert for self-supervised learning of language representations. arXiv preprint arXiv:1909.11942 .
- LeCun, Y., Bottou, L., Bengio, Y., Haffner, P., 1998. Gradient-based learning applied to document recognition. Proceedings of the IEEE 86, 2278–2324.
- Li, L., Ren, W., Qin, B., Liu, T., 2015. Learning document representation for deceptive opinion spam detection, in: Chinese Computational Linguistics and Natural Language Processing Based on Naturally Annotated Big Data: 14th China National Conference, CCL 2015 and Third International Symposium, NLP-NABD 2015, Guangzhou, China, November 13-14, 2015, Proceedings 14, Springer. pp. 393–404.
- Liu, W., Jing, W., Li, Y., 2020. Incorporating feature representation into bilstm for deceptive review detection. Computing 102, 701–715.
- Liu, X., Lu, H., Nayak, A., 2021. A spam transformer model for sms spam detection. IEEE Access 9, 80253–80263.
- Lu, W., Li, J., Wang, J., Qin, L., 2021. A cnn-bilstm-am method for stock price prediction. Neural Computing and Applications 33, 4741–4753.
- Luca, M., 2015. User-generated content and social media, in: Handbook of media Economics. Elsevier. volume 1, pp. 563–592.
- Luca, M., 2016. Reviews, reputation, and revenue: The case of yelp. com. Com (March 15, 2016). Harvard Business School NOM Unit Working Paper .
- Luca, M., Zervas, G., 2016. Fake it till you make it: Reputation, competition, and yelp review fraud. Management Science 62, 3412–3427.
- Ma, E., 2019. Nlp augmentation. URL: <https://github.com/makcedward/nlpaug>.
- Mani, S., Kumari, S., Jain, A., Kumar, P., 2018. Spam review detection using ensemble machine learning, in: Machine Learning and Data Mining in Pattern Recognition: 14th International Conference, MLDM 2018, New York, NY, USA, July 15-19, 2018, Proceedings, Part II 14, Springer. pp. 198–209.
- Mir, A.Q., Khan, F.Y., Chishti, M.A., 2023. Online fake review detection using supervised machine learning and bert model. arXiv preprint arXiv:2301.03225 .

- Mohawesh, R., Tran, S., Ollington, R., Xu, S., 2021. Analysis of concept drift in fake reviews detection. *Expert Systems with Applications* 169, 114318.
- Mukherjee, A., Liu, B., Glance, N., 2012. Spotting fake reviewer groups in consumer reviews, in: *Proceedings of the 21st international conference on World Wide Web*, pp. 191–200.
- Mukherjee, A., Venkataraman, V., Liu, B., Glance, N., 2013a. What yelp fake review filter might be doing?, in: *Proceedings of the international AAAI conference on web and social media*, pp. 409–418.
- Mukherjee, A., Venkataraman, V., Liu, B., Glance, N., et al., 2013b. Fake review detection: Classification and analysis of real and pseudo reviews. *UIC-CS-03-2013. Technical Report*.
- Nisen, M., . Fake Reviews Are Becoming An Even Bigger Problem For Businesses — businessinsider.com. <https://www.businessinsider.com/fake-reviews-are-becoming-a-huge-problem-for-businesses-2012-9>. [Accessed 06-May-2023].
- Ott, M., Choi, Y., Cardie, C., Hancock, J.T., 2011. Finding deceptive opinion spam by any stretch of the imagination, in: *Proceedings of the 49th Annual Meeting of the Association for Computational Linguistics: Human Language Technologies*, Association for Computational Linguistics, Portland, Oregon, USA. pp. 309–319. URL: <https://aclanthology.org/P11-1032>.
- Price, I., Gifford-Moore, J., Fleming, J., Musker, S., Roichman, M., Sylvain, G., Thain, N., Dixon, J., 2020. Six attributes of unhealthy conversation. *arXiv preprint arXiv:2010.07410*.
- Rao, S., Verma, A.K., Bhatia, T., 2021. A review on social spam detection: Challenges, open issues, and future directions. *Expert Systems with Applications* 186, 115742.
- Ren, Y., Zhang, Y., 2016. Deceptive opinion spam detection using neural network, in: *Proceedings of COLING 2016, the 26th International Conference on Computational Linguistics: Technical Papers*, pp. 140–150.
- Rhanoui, M., Mikram, M., Yousfi, S., Barzali, S., 2019. A cnn-bilstm model for document-level sentiment analysis. *Machine Learning and Knowledge Extraction* 1, 832–847.
- Ribeiro, M., Singh, S., Guestrin, C., 2016. “why should I trust you?”: Explaining the predictions of any classifier, in: *Proceedings of the 2016 Conference of the North American Chapter of the Association for Computational Linguistics: Demonstrations*, Association for Computational Linguistics, San Diego, California. pp. 97–101. URL: <https://aclanthology.org/N16-3020>, doi:10.18653/v1/N16-3020.
- Rojas-Galeano, S., 2021. Using bert encoding to tackle the mad-lib attack in sms spam detection. *arXiv preprint arXiv:2107.06400*.
- Sahmoud, T., Mikki, D., et al., 2022. Spam detection using bert. *arXiv preprint arXiv:2206.02443*.
- Salminen, J., Kandpal, C., Kamel, A.M., Jung, S.g., Jansen, B.J., 2022. Creating and detecting fake reviews of online products. *Journal of Retailing and Consumer Services* 64, 102771.
- Sarker, S., 2020. Banglabert: Bengali mask language model for bengali language understanding. URL: <https://github.com/sagorbrur/banglabert>.
- Sedighi, Z., Ebrahimpour-Komleh, H., Bagheri, A., 2017. Rloisd: Representation learning based opinion spam detection, in: *2017 3rd Iranian Conference on Intelligent Systems and Signal Processing (ICSPIS)*, IEEE. pp. 74–80.
- Shahariar, G.M., Biswas, S., Omar, F., Shah, F.M., Binte Hassan, S., 2019. Spam review detection using deep learning, in: *2019 IEEE 10th Annual Information Technology, Electronics and Mobile Communication Conference (IEMCON)*, pp. 0027–0033. doi:10.1109/IEMCON.2019.8936148.
- Shan, G., Zhou, L., Zhang, D., 2021. From conflicts and confusion to doubts: Examining review inconsistency for fake review detection. *Decision Support Systems* 144, 113513.
- Sharif, O., Hoque, M.M., 2022. Tackling cyber-aggression: Identification and fine-grained categorization of aggressive texts on social media using weighted ensemble of transformers. *Neurocomputing* 490, 462–481.
- Shifath, S., Khan, M.F., Islam, M., et al., 2021. A transformer based approach for fighting covid-19 fake news. *arXiv preprint arXiv:2101.12027*.
- Wang, C.C., Day, M.Y., Chen, C.C., Liou, J.W., 2018a. Detecting spamming reviews using long short-term memory recurrent neural network framework, in: *Proceedings of the 2nd International Conference on E-commerce, E-Business and E-Government*, pp. 16–20.
- Wang, X., Liu, K., Zhao, J., 2018b. Detecting deceptive review spam via attention-based neural networks, in: *Natural Language Processing and Chinese Computing: 6th CCF International Conference, NLPCC 2017, Dalian, China, November 8–12, 2017, Proceedings 6*, Springer. pp. 866–876.
- Wikipedia, . List of languages by total number of speakers - Wikipedia — en.wikipedia.org. https://en.wikipedia.org/wiki/List_of_languages_by_total_number_of_speakers. [Accessed 07-May-2023].
- Yao, J., Zheng, Y., Jiang, H., 2021. An ensemble model for fake online review detection based on data resampling, feature pruning, and parameter optimization. *IEEE Access* 9, 16914–16927.
- Zeng, Z.Y., Lin, J.J., Chen, M.S., Chen, M.H., Lan, Y.Q., Liu, J.L., 2019. A review structure based ensemble model for deceptive review spam. *Information* 10, 243.
- Zhang, W., Du, Y., Yoshida, T., Wang, Q., 2018. Dri-rnn: An approach to deceptive review identification using recurrent convolutional neural network. *Information Processing & Management* 54, 576–592.
- Zhao, S., Xu, Z., Liu, L., Guo, M., Yun, J., 2018. Towards accurate deceptive opinions detection based on word order-preserving cnn. *Mathematical Problems in Engineering* 2018.

A. Some more Instances of Fake Reviews

In this part, we present a few more instances of fake reviews for a better understanding. Table 21 shows two more fake samples. The first sample satisfies criteria 3 and 5, while the last sample satisfies criteria 5, which pertains to professional or poetic writing.

Table 21

Few more annotated fake review instances with corresponding annotation criteria

Fake reviews	Criteria
<p>বন্ধু তুমি একা হলে দিও আমায় ডাক, তোমার টাকায় সিন্ধু প্যাক খাবো আমি সারারাত। সরি রাতে কেন খাবো? বন্ধু যখন চ্যালেঞ্জ দেয় সিন্ধু প্যাক শেষ করার কিছু সে নিজেই শেষ করতে পারে না এবং আমার বিল তারই দেওয়া লাগে! Tour De Cyclist - Uttara এর সিন্ধু প্যাক বার্গার সম্পর্কে অনেক সুনাম শুনছি। তো ভাবলাম এই রান্ফস টাকে শেষ করেই আসি! বার্গার এ অনেক বেশি পরিমাণে প্যাটি থাকায় এর ভিতরের দিক জুঁসি করার জন্যে অনেক বেশি পরিমাণে চিজ এবং মেয়ো ইউজ করা হইছে। যার কারণে শুকনা লাগবে না বার্গার টা! পুরাটা শেষ করা খাদক না হলে সম্ভব না! আইটেম: সিন্ধু প্যাক বার্গার প্রাইস: ৬০০/= রেটিং: ৮.৫/১০। সাথে ড্রিংকস হিসেবে চকোলেট স্পোক নিয়েছিলাম। এটায় হুইপড ক্রিম অ্যাড করে ট্রাই করবেন অবশ্যই। অত্যন্ত জোস লাগে খেতে। আইটেম: চকোলেট স্পোক উইথ হুইপড ক্রিম প্রাইস: ১০০/= + ৬০/= (হুইপড ক্রিম এর জন্যে) রেটিং: ৯.৫/১০ লোকেশন: House # 05, Road # 15, Rabindra Sarani, Sector # 03, Uttara, Dhaka. চ্যালেঞ্জ এ আমি জিতছিলাম তাই বিল তো ফটোগ্রাফার দিছে।</p>	3, 5
<p>(Friend, if you are alone, just call me, I will have a six-pack on your tab all night. Sorry, why would you eat at night? When a friend challenges to finish the six-pack burger at Tour De Cyclist - Uttara, but can not finish it themselves, I end up footing the bill! I have heard a lot about the six-pack burger at Tour De Cyclist - Uttara! So, I thought I would come and conquer this beast! The burger is loaded with lots of cheese and mayo to make it juicier. You will not feel dry while eating it! Finishing it all is a must; there is no other way! Item: Six-pack burger Price: 600/= Rating: 8.5/10 I also ordered a chocolate spook as a drink. You must try it with whipped cream added. It's incredibly refreshing to have. Item: Chocolate spook with whipped cream Price: 100/= + 60/= (for whipped cream) Rating: 9.5/10 Location: House # 05, Road # 15, Rabinndra Sarani, Sector # 03, Uttara, Dhaka. Since I won the challenge, the bill was on me, as the photographer has captured.)</p>	3, 5
<p>ধানমন্ডি কাপিয়ে বুফের বস যখন ঢাকার রাজধানী মিরপুরে তখন না যেয়ে কি পারা যায়? বলছিলাম হেটার্সবিহীন সেই বুফে খ্যাত The Buffet stories এর কথা। তাদের দাম অনুযায়ী সার্ভিস প্রভাইডের ব্যাপার টা সবার থেকে আলাদা করে রেখেছে। আকর্ষণীয় ব্যাপার হচ্ছে এরা ৫৫০ টাকা (লাঃ) এবং ৬০০ টাকা (ডিনার) এ লাইভ কাবাব, সাসলিক, ক্রাবস, চিকেন কাবাব সার্বমিট করে। বলতে গেলে buffet stories ই প্রথম যারা মিরপুরবাসির ভালো বুফে খাওয়ার দুঃখ মোচন করেছে। তাদের যেসব খাবার আমার কাছে ভালো লাগার মত ছিল ১। বিফ রেজালা ২। চিকেন উইংস ৩। কর্ণ সুপ ৪। চিকেন টিক্কা কাবাব ৫। ফ্লেমিং চিকেন ৬। গার্লিক নান ৭। চওমিন ৮। চিকেন সাসলিক ৯। চকোলেট কেক ১০। পুডিং এগুলোকে আমি মাস্ট ট্রাই করার সাজেস্ট করব। ডেজার্ট আইটেম সে যেন পুরাই উমমমম। যারা চকোলেট প্রেমি তাদের জন্য পুরা ঈদ ঈদ মনে হবে। চকোলেট কেক এর সাথে প্রেম করেও আপনি ব্রেক আপ করতে পারবেন না কখন ও। যারা ভালো মানের কিছু বুফেতে খেতে চান তারা অবশ্যই buffet stories এ যেয়ে দেখতে পারেন প্রাইস- lunch item and Unlimited drinks @550 টাকা রেটিং-৮.৯৯/১০ বিহেভিয়ার-৯.৫/১০</p>	5
<p>(When you are in Dhaka's capital Mirpur and can not go to Dhanmondi for the famous Buffet stories, what can you do? I was talking about that extraordinary buffet place, The Buffet Stories. Their service stands out according to their price. The attraction is, they serve live kababs, saslik, crabs, and chicken kababs for 550Tk (lunch) and 600Tk (dinner). To say, Buffet Stories has been a solace for those who reside in Mirpur and love good buffets. Here are the foods I enjoyed the most: 1. Beef rezala 2. Chicken wings 3. Corn soup 4. Chicken 5. tikka kabab 6. Flaming chicken 7. Garlic naan 8. Chowmein 9. Chicken saslik 10. Chocolate cake Pudding. I suggest you must try these. The dessert items are simply divine, especially for chocolate lovers, it feels like Eid every time. You will not be able to resist breaking your diet with their chocolate cake. Those who want to eat at a good quality buffet should definitely go to Buffet Stories. Price: Lunch item and unlimited drinks @ 550Tk Rating: 8.99/10 Behavior: 9.5/10)</p>	5

B. Conversion with LLM – Llama 2 (70B)

Table 22 shows the same instances as in 8, but with the converted text using Llama 2 (70B). It's evident that Llama 2 (70B) is unable to generate meaningful conversion when the text is long. In the third case, it was able to promptly translate the sentence because there are only two English words mixed into Bengali, but it failed to perform in the second example because the number of English terms is spread over the text. Llama 2 attempted to convert the restaurant's name but failed, significantly affecting the sense of the statement instead of having 70 billion parameters. In addition, punctuation marks are almost non-existent. In the first scenario, the LLM experienced a hallucination in which various groups of words were repeatedly produced because it was unable to comprehend the transliterated Bengali words.

Table 22

Few example instances before and after applying the text conversion pipeline using Llama 2

Original Text	Converted Text (Llama 2)
Best pizza offer for Mirpur peoples Buy 1 Get 1 free 1.Mashroom lovers pizza.2.Meat lovers pizza. Choto bhaiyer jsc xam sesh kore gelm n e offer ta khey ashlam onk tasty chilo n tader bebohar o valo chilo.. mane ak kothay paisa osul Taste:9/10 Price: 330tk Location: The Hub Restaurant (60 feet) — at The Hub Restaurant	আপনি মিরপুর পরিবার লোকালে একটি পিড়া অফার পাবেন? আপনি এই অফারটি নিতে আমাতো আপনার আছিল থাকা আছিল আমাতো আপনার আছিল থাকা আমাতো আপনার আছিল থাকা আমাতো আপনার আছিল থাকা
Cafe Famous Wari প্রায় বেশ কয়েকদিন আগে গিয়েছিলাম...। এদের বার্গার গুলা ভালো লাগে আমার। কোন জায়গার সাথে তুলনা করব না তবে ভালো লাগে আমার সবসময় চিকেন বার্গার ট্রাই করা হইসে সব খানে ফেমাসে গেলেও এইটাই ট্রাই করা হয় এবার যাস্ট একটু চেঞ্জ করলাম বিফ টা নিয়ে বিফ বেকন-৩৫০ টাকা ড্রিংক্স-৪০ টাকা করে ফ্রেঞ্চ ফ্রাইস-১০০ টাকা লোকেশন: ওয়ারী (yellow এর উপরের তলায়) আইটেম: Beef n bacon দাম: ৩৫০ টাকা	আপনি এই অনুসার আশেপাশে একটি খাবার আইটেম অধিষ্ঠ করে ছাড়ি আমার সব খানে ফেমাসে গেলেও এইটাই ট্রাই করা হয় এবার যাস্ট একটু চেঞ্জ করলাম বিফ টা নিয়ে বিফ বেকন-৩৫০ টাকা ড্রিংক্স-৪০ টাকা করে ফ্রেঞ্চ ফ্রাইস-১০০ টাকা লোকেশন: ওয়ারী (yellow এর উপরের তলায়) আইটেম: Beef n bacon দাম: ৩৫০ টাকা
Berger Xpress এ বন্ধুদের সাথে বার্গার খেতে গেছিলাম। পরে নিজের বার্গার নিজেই পাইলাম না	বার্গার এক্সপ্রেস এ বন্ধুদের সাথে বার্গার খেতে গেছিলাম পরে নিজের বার্গার নিজেই পাইলাম না

C. Algorithm of the Proposed Ensemble Model

The process of utilizing the weighted ensemble technique is outlined in Algorithm 2. Firstly, we multiply each class's probability (softmax) by the two corresponding f1 scores, and then we sum them up. Next, we divide the total of the prior f1 scores of the models for each class to normalize the individual scores for each class. Lastly, we find the final forecast by identifying the highest predicted scores in all classes.

Algorithm 2 Algorithm for the proposed weighted ensemble model

```

1:  $m \leftarrow no\_of\_test\_samples$ 
2:  $n \leftarrow no\_of\_models$ 
3:  $c \leftarrow no\_of\_class$ 
4:  $p \leftarrow [m][n][c]$ 
5:  $f1 \leftarrow [n][c]$ 
6:  $sum = [m][c]$ 
7: for  $i \in (1, m)$  do
8:   for  $j \in (1, n)$  do
9:     for  $k \in (1, c)$  do
10:       $sum[i][k] += p[i][j][k] * f1[j][k]$ 
11:       $k += 1$ 
12:      $j += 1$ 
13:     $i += 1$ 
14:
15:  $n\_sum = [c]$ 
16: for  $j \in (1, n)$  do
17:   for  $k \in (1, c)$  do
18:     $n\_sum[k] += f1[j][k]$ 
19:     $k += 1$ 
20:    $j += 1$ 
21:  $pred = sum/n\_sum$ 
22:  $Output = argmax(pred)$ 

```

▷ softmax probabilities
 ▷ f1 scores of individual classes
 ▷ weighted sum of individual classes

D. Details of Evaluation Metrics

In our study, we used several metrics to evaluate the performance of our trained models. These metrics include Precision, Recall, F1-score, ROC-AUC score and MCC score. In this section, we provide a brief explanation of each metric. It is worth noting that all metrics are described using *fake* as the positive class.

Precision (P): Precision measures the proportion of true positives among all positive predictions. (How many predicted fake reviews are actually fake?)

$$P = \frac{tp}{tp + fp} \quad (3)$$

Recall (R): Recall measures the proportion of true positives among all actual positives. (How many fake reviews are correctly identified?)

$$R = \frac{tp}{tp + fn} \quad (4)$$

F1-score (F1): The F1-score calculates the harmonic mean of precision and recall while taking into account the significance of both the precision and recall values. The weighted F1 score is calculated by taking into account each of the fake and non-fake classes as positive separately and averaging out the results. It takes into account the quantity of samples from each class.

$$F1 = \frac{2*(P*R)}{(P + R)} \quad (5)$$

ROC-AUC score: The ROC-AUC score of a model is an indication of its ability to distinguish between positive and negative classes. A score less than 0.5 indicates poor performance of the classifier. On the other hand, if the classifier detects more True positives and True negatives than False negatives and False positives, its score is greater than 0.5. A good ROC-AUC score ranges between 0.7 and 0.8.

$$ROC-AUC = \frac{1 + TPR - FPR}{2} \quad (6)$$

The likelihood of a false alarm is known as FPR and true positive rate (TPR) basically denotes the recall score.

MCC score: The Matthews correlation coefficient (MCC) is a more robust statistical measure, and it only yields a high value when the prediction is accurate in all four scenarios (tp, tn, fp, fn). Even if one of the classes is heavily over-represented or under-represented, a value close to 1 indicates that both classes have been correctly predicted..

$$MCC = \frac{tn*tp - fn*fp}{\sqrt{(tp + fp)(tp + fn)(tn + fp)(tn + fn)}} \quad (7)$$

E. Hyperparameter Settings

The configuration of hyperparameters used in different models can be found in Table 23. It is worth noting that due to memory constraints, the input sequence length for all models, except *sahajBERT* and *BanglaBERT Large* was limited to 512. However, the input sequence length was 256 for these two models.

F. Performance of Models for Approach 2 and 3

This section shows the detailed findings of approaches 2 and 3 for both stand-alone and ensemble models. In Tables 26 and 27, the ensemble techniques provide the outcomes of employing 0 to 3 augmented fake data per review for Approach-2 and Approach-3, respectively.

F.1. Deep Learning and Transformer Models:

The detailed results of the standalone models for approach-2 and approach-3 are shown in Table 24 and 25 respectively. The results were previously presented in Fig. 7 only for weighted-F1 scores in terms of four augmented samples along with the fake one for both the approaches.

Table 23

Hyper-parameter settings used for deep learning and transformer models on all three approaches (Approach-1, 2, 3). Here, value 0 in 'No. of Aug' column denotes no augmentation

Model	No. of Aug	Epoch	Batch Size	Learning Rate
CNN	0-4	15	128	$5e^{-4}$
BiLSTM	0-4	15	256	$5e^{-4}$
CNN BiLSTM	0	20	128	$5e^{-4}$
	1	15		
	2	15		
	3	15		
	4	15		
CNN BiLSTM with Attention	0	20	256	$5e^{-4}$
	1	15		
	2	10		
	3	10		
	4	15		
Bangla BERT	0	15	4	$2e^{-7}$
	1	7		
	2	6		
	3	6		
	4	6		
Bangla BERT Genertor	0-4	10	8	$5e^{-5}$
Bangla BERT Base	0	10	8	$5e^{-5}$
	1	8		
	2	5		
	3	5		
	4	5		
sahaj BERT	0-4	20	4	$2e^{-7}$
Bangla BERT Large	0-4	20	4	$2e^{-7}$

• **Approach-2:** The outcomes obtained utilizing the *nlpaug* augmentation technique are shown in Table 24. The first two DL methods: CNN and BiLSTM, display striking WF1 values of 0.974 and 0.969, respectively with MCC scores of 0.948 and 0.939 for the case of 4 augmented samples of fake data. We also observe consistent improvement in performance for both models across all metrics. It is obvious that CNN under performed in the instances of two augmentations while maintaining continuity in the other scenarios. The CNN and BiLSTM hybrid models exhibit similar performance to the standalone models. The best WF1 and MCC scores (0.978 and 0.957) for four distinct augmentations were provided by the model built with CNN-BiLSTM with attention layer. It should be noted that the precision and recall values for both the fake and non-fake classes indicate that the predictions for the two classes are not always the same for this model. As a result, due to the model's bias against a specific class, it cannot be said that this hybrid model is the most effective one. The performance of transformers is not as good as it was in the no augmentation scenario. Transformers exhibit outcomes that are similar to those of DL approaches in the presence of augmentation. *BanglaBERT* (BB) in terms of WF1 score (0.981) for four different augmentations performs best. ROC-AUC (0.981) and MCC (0.961) scores also supports the claim. BBG and BBB demonstrate comparable results with a WF1 score of 0.963 which are encouraging. Furthermore, the capacity of the models to accurately classify fake reviews is demonstrated by the continuous improvement in performance with increased numbers of augmented samples for each real data. SB is the lowest performing model as always having an MCC of only 0.713 for four augmentation. It could be due to the short sequence length (256) and low number of parameters (18M). In terms of fake class, the result of BBL is intriguing because it has the maximum precision of 0.984. On the other hand, the recall score (0.808) is quite low indicating the model's bias towards the fake classes. This might be due to the short sequence length.

Table 24

Performance comparison among individual models on *nlpaug* generated augmentations (Approach - 2)

Model	Aug	Fake			Non-Fake			WF1	ROC-AUC	MCC
		P	R	F1	P	R	F1			
CNN	1	0.940	0.884	0.912	0.891	0.944	0.917	0.914	0.955	0.830
	2	0.872	0.963	0.915	0.958	0.858	0.906	0.910	0.971	0.825
	3	0.975	0.953	0.964	0.954	0.976	0.965	0.965	0.991	0.929
	4	0.962	0.987	0.974	0.986	0.961	0.974	0.974	0.997	0.948
BiLSTM	1	0.891	0.910	0.900	0.908	0.888	0.898	0.899	0.950	0.799
	2	0.939	0.913	0.926	0.915	0.940	0.928	0.927	0.963	0.854
	3	0.944	0.974	0.959	0.973	0.942	0.957	0.958	0.990	0.917
	4	0.974	0.964	0.969	0.965	0.975	0.970	0.969	0.995	0.939
CNN BiLSTM	1	0.912	0.892	0.902	0.894	0.914	0.904	0.903	0.949	0.806
	2	0.938	0.905	0.922	0.909	0.940	0.924	0.923	0.971	0.846
	3	0.955	0.955	0.955	0.955	0.955	0.955	0.955	0.985	0.910
	4	0.970	0.979	0.975	0.979	0.970	0.975	0.975	0.996	0.949
CNN BiLSTM with Attention	1	0.926	0.884	0.905	0.889	0.929	0.909	0.907	0.954	0.814
	2	0.961	0.920	0.940	0.924	0.963	0.943	0.942	0.978	0.884
	3	0.972	0.916	0.943	0.921	0.974	0.947	0.945	0.985	0.891
	4	0.968	0.990	0.979	0.989	0.967	0.978	0.978	0.998	0.957
Bangla BERT (BB)	1	0.951	0.933	0.942	0.934	0.951	0.943	0.942	0.942	0.884
	2	0.953	0.960	0.957	0.960	0.953	0.956	0.956	0.956	0.913
	3	0.972	0.978	0.975	0.977	0.972	0.975	0.975	0.975	0.950
	4	0.976	0.985	0.981	0.985	0.976	0.980	0.981	0.981	0.961
Bangla BERT Generator (BBG)	1	0.868	0.910	0.889	0.906	0.862	0.883	0.886	0.886	0.773
	2	0.906	0.933	0.919	0.931	0.903	0.917	0.918	0.918	0.836
	3	0.920	0.970	0.945	0.968	0.916	0.942	0.943	0.943	0.887
	4	0.944	0.984	0.963	0.983	0.942	0.962	0.963	0.963	0.926
Bangla BERT Base (BBB)	1	0.888	0.892	0.890	0.891	0.888	0.890	0.890	0.890	0.780
	2	0.911	0.940	0.925	0.938	0.908	0.923	0.924	0.924	0.849
	3	0.922	0.966	0.944	0.965	0.918	0.941	0.942	0.942	0.885
	4	0.954	0.973	0.964	0.973	0.954	0.963	0.963	0.963	0.927
sahaj BERT (SB)	1	0.726	0.750	0.738	0.741	0.716	0.729	0.733	0.733	0.467
	2	0.819	0.823	0.821	0.823	0.818	0.820	0.821	0.821	0.642
	3	0.825	0.847	0.836	0.843	0.821	0.832	0.834	0.834	0.668
	4	0.840	0.880	0.859	0.874	0.833	0.853	0.856	0.856	0.713
Bangla BERT Large (BBL)	1	0.939	0.743	0.829	0.787	0.951	0.861	0.845	0.847	0.710
	2	0.966	0.781	0.864	0.816	0.973	0.888	0.876	0.877	0.768
	3	0.957	0.869	0.911	0.880	0.961	0.919	0.915	0.915	0.834
	4	0.984	0.808	0.887	0.838	0.987	0.906	0.897	0.897	0.808

• **Approach-3:** Results from augmentation utilizing *bnauug* technique did not perform as well as those from *nlpaug* which can be seen in Table 25. Performances have decreased by 2%-4% from the previous models of approach-2. The WF1 values obtained by CNN and BiLSTM, 0.921 and 0.927, are extremely close. With a WF1 of 0.94 and MCC of 0.881, which are 2.6% and 3.6% higher than CNN and BiLSTM respectively, the hybrid model with CNN-BiLSTM somewhat outperformed the individual models. In case of four distinct augmented samples, the hybrid model with attention layer displays a ROC-AUC score of 0.979 which is almost similar to other DL models. The results make it very evident that most DL algorithms exhibit some bias toward a particular class, highlighting their inconsistency in regards to recognizing erroneous reviews. Similar to other experiments using *nlpaug*, BB and BBG here yield the best results. BBG and BB achieved the highest WF1 of 0.947 and 0.943 and MCC of 0.895 and 0.887. The ability of these models are supported by their ROC-AUC scores. The WF1 values of BBB, SB, and BBL are similarly satisfactory i.e. 0.94, 0.90, and 0.928 respectively. The result of BBB is almost identical to BB and BBG demonstrating the model's ability to identify fake reviews when the similarities between the augmented samples are low. SB and BBL demonstrate

Table 25

Performance comparison among individual models on *bnaug* generated augmentations (Approach - 3)

Model	Aug	Fake			Non-Fake			WF1	ROC -AUC	MCC
		P	R	F1	P	R	F1			
CNN	1	0.927	0.806	0.862	0.828	0.937	0.879	0.871	0.944	0.749
	2	0.977	0.851	0.910	0.868	0.980	0.921	0.915	0.951	0.838
	3	0.950	0.896	0.922	0.901	0.953	0.927	0.924	0.982	0.850
	4	0.888	0.963	0.924	0.959	0.879	0.917	0.921	0.981	0.845
BiLSTM	1	0.885	0.802	0.841	0.819	0.896	0.856	0.849	0.935	0.701
	2	0.930	0.893	0.911	0.897	0.933	0.915	0.913	0.973	0.827
	3	0.961	0.866	0.911	0.878	0.965	0.919	0.915	0.976	0.834
	4	0.957	0.894	0.924	0.900	0.960	0.929	0.927	0.970	0.855
CNN BiLSTM	1	0.905	0.780	0.838	0.807	0.918	0.859	0.848	0.934	0.705
	2	0.916	0.863	0.889	0.871	0.920	0.895	0.892	0.963	0.785
	3	0.911	0.916	0.913	0.916	0.910	0.913	0.913	0.975	0.827
	4	0.948	0.931	0.940	0.932	0.949	0.941	0.940	0.982	0.881
CNN BiLSTM with Attention	1	0.887	0.817	0.850	0.830	0.896	0.862	0.856	0.941	0.715
	2	0.950	0.893	0.921	0.899	0.953	0.925	0.923	0.975	0.847
	3	0.879	0.959	0.917	0.955	0.868	0.909	0.913	0.973	0.830
	4	0.953	0.909	0.930	0.913	0.955	0.934	0.932	0.979	0.865
Bangla BERT (BB)	1	0.917	0.910	0.914	0.911	0.918	0.914	0.914	0.914	0.828
	2	0.947	0.925	0.936	0.927	0.948	0.937	0.937	0.937	0.873
	3	0.962	0.942	0.952	0.943	0.963	0.953	0.952	0.952	0.905
	4	0.955	0.930	0.942	0.932	0.957	0.944	0.943	0.943	0.887
Bangla BERT Generator (BBG)	1	0.895	0.867	0.881	0.871	0.898	0.884	0.883	0.883	0.766
	2	0.941	0.910	0.925	0.913	0.943	0.927	0.926	0.926	0.853
	3	0.954	0.925	0.939	0.928	0.955	0.941	0.940	0.940	0.881
	4	0.955	0.938	0.947	0.940	0.957	0.948	0.947	0.947	0.895
Bangla BERT Base (BBB)	1	0.912	0.884	0.898	0.888	0.914	0.901	0.899	0.899	0.799
	2	0.932	0.923	0.928	0.924	0.933	0.928	0.928	0.928	0.856
	3	0.926	0.909	0.917	0.910	0.927	0.919	0.918	0.918	0.836
	4	0.951	0.928	0.939	0.930	0.952	0.941	0.940	0.940	0.880
sahaj BERT (SB)	1	0.829	0.799	0.814	0.806	0.836	0.821	0.817	0.817	0.635
	2	0.894	0.841	0.867	0.850	0.900	0.874	0.871	0.871	0.743
	3	0.898	0.851	0.874	0.858	0.903	0.880	0.877	0.877	0.755
	4	0.916	0.882	0.898	0.886	0.919	0.902	0.900	0.900	0.801
Bangla BERT Large (BBL)	1	0.932	0.813	0.869	0.834	0.940	0.884	0.876	0.877	0.760
	2	0.963	0.841	0.898	0.859	0.968	0.910	0.904	0.904	0.815
	3	0.978	0.826	0.896	0.850	0.981	0.911	0.903	0.904	0.818
	4	0.978	0.876	0.924	0.888	0.981	0.932	0.928	0.928	0.861

good performance despite having a short sequence length; their respective WF1 values are 4.4% and 3.1% higher than those of earlier experiments with *nlpaug*.

F.2. Ensemble Approaches:

Here, we present some more experimental findings for both ensemble technique approaches. The results were previously presented in Tables 16 for the approach using the *nlpaug* augmentation technique (Approach-2) and 17 for the *bnaug* augmentation technique (Approach-3) only for the case of four augmentation samples along with the original fake reviews. We display the additional results for 1 to 3 augmented samples in addition to the original fake review. The experimental findings for the case of 1-3 augmented samples using approach-2 are shown in Table 26 while the results for approach-3 are shown in Table 27.

Table 26

Performance comparison between the two ensemble approaches (average and weighted) on 1 to 3 augmented fake reviews generated using *nlpaug* (Approach - 2)

Methods	Aug	Fake			Non-Fake			WF1	ROC-AUC	MCC	
		P	R	F1	P	R	F1				
AVG-Ensemble Models	EN1	1	0.96	0.93	0.95	0.93	0.96	0.95	0.9477	0.95	0.90
		2	0.97	0.95	0.96	0.95	0.97	0.96	0.9614	0.96	0.92
		3	0.98	0.98	0.98	0.98	0.98	0.98	0.9785	0.98	0.96
	EN2	1	0.96	0.91	0.94	0.92	0.97	0.94	0.9403	0.94	0.88
		2	0.97	0.95	0.96	0.95	0.97	0.96	0.9614	0.96	0.92
		3	0.97	0.98	0.97	0.98	0.97	0.97	0.9748	0.97	0.95
	EN3	1	0.95	0.92	0.94	0.92	0.96	0.94	0.9365	0.94	0.87
		2	0.96	0.94	0.95	0.94	0.97	0.95	0.9502	0.95	0.90
		3	0.97	0.96	0.97	0.96	0.97	0.97	0.9664	0.97	0.93
	EN4	1	0.92	0.94	0.93	0.94	0.92	0.93	0.9272	0.93	0.85
		2	0.95	0.96	0.96	0.96	0.95	0.96	0.9565	0.96	0.91
		3	0.95	0.98	0.97	0.98	0.95	0.96	0.9655	0.97	0.93
	EN5	1	0.91	0.90	0.91	0.90	0.91	0.91	0.9086	0.91	0.82
		2	0.96	0.93	0.95	0.93	0.96	0.95	0.9465	0.95	0.89
		3	0.95	0.96	0.96	0.96	0.95	0.96	0.9571	0.96	0.91
	EN6	1	0.94	0.92	0.93	0.92	0.94	0.93	0.9328	0.93	0.87
		2	0.96	0.95	0.95	0.95	0.96	0.96	0.9552	0.96	0.91
		3	0.96	0.99	0.97	0.98	0.96	0.97	0.9729	0.97	0.95
Weighted-Ensemble Models	EN1	1	0.96	0.93	0.94	0.93	0.96	0.95	0.9459	0.95	0.89
		2	0.97	0.96	0.96	0.96	0.97	0.96	0.9614	0.96	0.92
		3	0.98	0.98	0.98	0.98	0.98	0.98	0.9795	0.98	0.96
	EN2	1	0.96	0.91	0.94	0.92	0.96	0.94	0.9384	0.94	0.88
		2	0.97	0.95	0.96	0.95	0.97	0.96	0.9627	0.96	0.93
		3	0.97	0.98	0.98	0.98	0.97	0.98	0.9757	0.98	0.95
	EN3	1	0.95	0.92	0.94	0.92	0.96	0.94	0.9365	0.94	0.87
		2	0.96	0.94	0.95	0.94	0.97	0.95	0.9527	0.95	0.91
		3	0.97	0.98	0.98	0.98	0.97	0.98	0.9785	0.98	0.96
	EN4	1	0.92	0.94	0.93	0.94	0.92	0.93	0.9272	0.93	0.85
		2	0.95	0.96	0.96	0.96	0.95	0.96	0.9565	0.96	0.91
		3	0.96	0.98	0.97	0.98	0.96	0.97	0.9673	0.97	0.93
	EN5	1	0.91	0.90	0.91	0.90	0.91	0.91	0.9086	0.91	0.82
		2	0.96	0.93	0.94	0.93	0.96	0.95	0.9453	0.95	0.89
		3	0.95	0.98	0.97	0.98	0.95	0.97	0.9664	0.97	0.93
	EN6	1	0.95	0.92	0.94	0.92	0.95	0.94	0.9366	0.94	0.87
		2	0.96	0.95	0.95	0.95	0.96	0.96	0.9552	0.96	0.91
		3	0.96	0.99	0.97	0.98	0.96	0.97	0.9729	0.97	0.95

G. Performance Analysis on Some Unseen Test Reviews

Here, some more samples are provided which are taken from recent social media posts and tested on our selected models. The first instance from Table 28 is a non-fake review, and both models accurately predicted it. However, in the fourth sample, the reviewer is somewhat overstating the case, but approach-2 was unable to identify this as the review is so nearly a non-fake review as well. We must admit that the reviewer deserves credit for this.

Some examples of misclassified data utilizing LIME can be found in Table 29. In the first sample, there is some discrepancy between the models since the words খাইলাম, খেলাম and লোকেশন are colored differently in each model, which has an impact on the prediction. The models using approach-3 are unable to accurately predict the samples, however, the model of approach-2 does. In the second sample, words like বাঙালিয়ানা, এইখানে, রকম, and ভালো are surprisingly deceiving the model in approach-3, dominating the prediction. In case of approach-3, the variances in

Table 27

Performance comparison between the two ensemble approaches (average and weighted) on 1 to 3 augmented fake reviews generated using *bnaug* (Approach - 3)

Methods	Aug	Fake			Non-Fake			WF1	ROC -AUC	MCC	
		P	R	F1	P	R	F1				
AVG-Ensemble Models	EN1	1	0.92	0.90	0.91	0.90	0.93	0.91	0.9123	0.91	0.82
		2	0.96	0.93	0.94	0.93	0.96	0.94	0.9415	0.94	0.88
		3	0.97	0.93	0.95	0.93	0.97	0.95	0.9515	0.95	0.90
	EN2	1	0.93	0.89	0.91	0.90	0.93	0.91	0.9123	0.91	0.83
		2	0.97	0.91	0.94	0.92	0.97	0.94	0.9427	0.94	0.89
		3	0.97	0.91	0.94	0.92	0.97	0.94	0.9430	0.94	0.89
	EN3	1	0.93	0.88	0.90	0.89	0.93	0.91	0.9048	0.90	0.81
		2	0.97	0.91	0.94	0.92	0.97	0.94	0.9390	0.94	0.88
		3	0.97	0.92	0.95	0.92	0.98	0.95	0.9477	0.95	0.90
	EN4	1	0.91	0.89	0.90	0.89	0.91	0.90	0.9030	0.90	0.81
		2	0.96	0.93	0.95	0.93	0.96	0.95	0.9465	0.95	0.89
		3	0.97	0.93	0.95	0.93	0.97	0.95	0.9487	0.95	0.90
	EN5	1	0.91	0.87	0.89	0.88	0.91	0.90	0.8936	0.89	0.79
		2	0.97	0.92	0.94	0.92	0.97	0.94	0.9427	0.94	0.89
		3	0.97	0.91	0.94	0.92	0.97	0.94	0.9412	0.94	0.88
	EN6	1	0.91	0.89	0.90	0.89	0.91	0.90	0.9030	0.90	0.81
		2	0.96	0.93	0.95	0.93	0.96	0.95	0.9465	0.95	0.89
		3	0.97	0.93	0.95	0.93	0.97	0.95	0.9487	0.95	0.90
Weighted-Ensemble Models	EN1	1	0.92	0.90	0.91	0.90	0.93	0.91	0.9123	0.91	0.82
		2	0.96	0.93	0.94	0.93	0.96	0.94	0.9415	0.94	0.88
		3	0.97	0.93	0.95	0.93	0.97	0.95	0.9515	0.95	0.90
	EN2	1	0.93	0.89	0.91	0.89	0.94	0.91	0.9123	0.91	0.83
		2	0.97	0.90	0.94	0.91	0.97	0.94	0.9377	0.94	0.88
		3	0.98	0.92	0.95	0.93	0.98	0.95	0.9524	0.95	0.91
	EN3	1	0.92	0.88	0.90	0.88	0.93	0.90	0.9011	0.90	0.80
		2	0.97	0.91	0.94	0.92	0.97	0.94	0.9390	0.94	0.88
		3	0.98	0.92	0.95	0.93	0.98	0.95	0.9496	0.95	0.90
	EN4	1	0.92	0.90	0.91	0.90	0.92	0.91	0.9086	0.91	0.82
		2	0.96	0.93	0.94	0.93	0.96	0.95	0.9453	0.95	0.89
		3	0.97	0.93	0.95	0.93	0.97	0.95	0.9496	0.95	0.90
	EN5	1	0.91	0.88	0.89	0.88	0.91	0.90	0.8955	0.90	0.79
		2	0.97	0.91	0.94	0.92	0.97	0.94	0.9427	0.94	0.89
		3	0.97	0.91	0.94	0.92	0.98	0.94	0.9430	0.94	0.89
	EN6	1	0.93	0.88	0.90	0.89	0.93	0.91	0.9067	0.91	0.81
		2	0.97	0.91	0.94	0.92	0.97	0.94	0.9415	0.94	0.88
		3	0.98	0.92	0.95	0.92	0.98	0.95	0.9568	0.95	0.90

data augmentation might be the cause. The result of approach-2 is always high as the augmentations are slightly biased as only 15% words are replaced whereas other words remain same for a fake sample.

Table 28

Generalization performance on some more unseen test reviews taken from recent social media posts by the proposed weighted ensemble model. (0 stands for *fake* and 1 stands for *non-fake*)

Review	True Label	Approach -2	Approach -3
<p>বোবা বিরিয়ানী এর সব থেকে স্পেশাল আইটেম হলো গরুর চাপ পোলাও যা আমার সব থেকে বেশি পছন্দ তাদের এই চাপ পোলাও টা অনেক বিখ্যাত খিলগাঁও এর মধ্যে আমি প্রায় সময় তাদের এই খানে খাই আরো অনেক আইটেম আছে যা অনেক মজা সত্যি কথা গরুর চাপ পোলাও ১৮০ টাকা এক পিস অনেক বড় সাইজ এর বিফ থাকে আমি এক সাথে ২ টা নিয়েছিলাম তাই অনেক মনে হয়তাছে মাংস গুলো অনেক সফট ছিলো আর পোলাও এর সাথে মাংস এর কম্বিনেশন টা অনেক জুসি লাগতাছিলো টেস্ট ৯/১০ লোকেশন খিলগাঁও তিলপাপাড়া ১৬ নাম্বার রোড এর মাথায়</p> <p>(The most special item of Boba Biryani is beef chap polao which I like the most. Their chap polao is very famous in Khilgaon. There is a very big size of beef, I took 2 at a time, so it seems that the meat was very soft and the combination of the fragrant rice with the chicken was very juicy. Test 9/10. Location Khilgaon Tilpapara at the point of road number 16)</p>	1	1	1
<p>শহরের ভয়াভহ শব্দ দূষণ থেকে বেরিয়ে প্রান খুলে একটু ফ্রেশ নিশ্বাস নিয়ে কিছু মুহূর্ত কাটলাম মিরপুরের ক্যাফেতে। আচ্ছা চলে যেতে হবে মিরপুরের এই রুফটপ প্লেসে। এক কথায় সৌন্দর্য্য আর শহরের ব্যস্ততা ছেড়ে পালানোর মত। পড়ন্ত বিকেলে আড্ডাবাজী করার জন্যই কয়েকজন বন্ধু মিলে গিয়েছিলাম এতো সুন্দর রুফভিউ দেখার জন্য। তার পরে ইফতারি টা করে আসলাম। তাদের ম্যানু টা দেখলাম, প্রাইস রিজনেবল ভাবেই করেছে। রাশ কম থাকে, সার্ভিস ভালো দেয়। ওপেন স্মোকিং প্লেস।</p> <p>(I spent a few moments in the cafe of Mirpur to get out of the terrible noise pollution of the city and take a breath of fresh air. Well, you have to go to this rooftop place in Mirpur. In a word, beauty and escape from the hustle and bustle of the city. I along with a few of my friends went together to see such a beautiful roof view for chatting in the afternoon. I came after doing my Iftar. I saw their menu, the price is reasonable. The rush is less, and the service is good. Open smoking place.)</p>	0	1	0

Table 29

Feature importance explanation of generated by LIME based on the best performing individual model (*BanglaBERT*). Here, the true level of the data is given on top of each review

Reviews	LIME Outputs	Predictions
<p>non-fake</p> <p>কি খাইলাম রে ভাই প্রতি কামড়ে শুধু মাংস আর চিজ দেশের সবচেয়ে হাইপড পিজ্জা ডাইনিং লাউঞ্জের মিটবল ডিপ ডিশ পিজ্জা খেলাম২২২ট ক্যাশব্যাক অফারে কোন কথা হবেনা জাস্ট না খাইলেই মিস পুরাই লোকেশনঃ ৮১ রেনকিন স্ট্রিট ওয়ারী স্বপ্নর অপজিটে</p> <p>(What have I eaten! Only meat and cheese per bite. Most hyped pizza in the country. I have eaten Dining Lounge Meatball Deep Dish Pizza 222 taka. Cashback offer. Don't talk. Just don't miss. Location: 81 Rankin Street, Opposite to Wari Swapna)</p>	<p>Approach-2</p> <p>কি খাইলাম রে ভাই প্রতি কামড়ে শুধু মাংস আর চিজ দেশের সবচেয়ে হাইপড পিজ্জা ডাইনিং লাউঞ্জের মিটবল ডিপ ডিশ পিজ্জা খেলাম২২২ট ক্যাশব্যাক অফারে কোন কথা হবেনা জাস্ট না খাইলেই মিস পুরাই লোকেশনঃ ৮১ রেনকিন স্ট্রিট ওয়ারী স্বপ্নর অপজিটে</p> <p>Approach-3</p> <p>কি খাইলাম রে ভাই প্রতি কামড়ে শুধু মাংস আর চিজ দেশের সবচেয়ে হাইপড পিজ্জা ডাইনিং লাউঞ্জের মিটবল ডিপ ডিশ পিজ্জা খেলাম২২২ট ক্যাশব্যাক অফারে কোন কথা হবেনা জাস্ট না খাইলেই মিস পুরাই লোকেশনঃ ৮১ রেনকিন স্ট্রিট ওয়ারী স্বপ্নর অপজিটে</p>	non-fake
<p>fake</p> <p>১৫০ টাকায় বুফে অফার বিশ্বের সবচেয়ে কম টাকায় সেরা বুফে বাঙালিয়ানা ভোজ বাঙালিয়ানা ভোজের অলমোস্ট সব ফুডই সেরা। এইখানে চলছে মাত্র ১৫০ টাকায় বুফে অফার। ১১ রকম ভর্তা অনলিমিটেড ভাত। ভোজ হবে পুরো পেট পুরে। সবগুলো ভর্তাই জোস। কাকড়ার টেস্ট ও খুব ভালো। তবে বেস্ট ছিল গরুর কালা ভুনাটা। হাসের মাংসটা সফট ছিল। ওভারঅল খুবি ভালো। আইটেম নাম দাম ১। ভাত ও ভর্তা ১৫০ট ২। গরুর কালা ভুনা ১৫০ট ৩। কাকড়ার দোপেয়াজো ১৫০ট ৪। হাস ভুনা ২০০ রেটিং ৯/১০ অবস্থান পশ্চিম পান্থপথ মসজিদের বিপরীত পাশে।</p> <p>(Buffet offer at 150 taka, the best buffet at the lowest price in the world. Buffet offer is running here for only 150 taka. 11 types of bharta and unlimited rice. The feast will be full. All fillings are great. Test of crab is also very good. But the best was the black roast beef. The meat of the duck was soft. Overall very good. Item Name Price 1. Rice and Bharta 150 tak 2. Beef black roast 150 taka 3. Crab fry 150 taka 4. Duck Curry 200. Rating 9/10. Location Opposite to west Panthpath Mosque.)</p>	<p>Approach-2</p> <p>১৫০ টাকায় বুফে অফার বিশ্বের সবচেয়ে কম টাকায় সেরা বুফে বাঙালিয়ানা ভোজ বাঙালিয়ানা ভোজের অলমোস্ট সব ফুডই সেরা। এইখানে চলছে মাত্র ১৫০ টাকায় বুফে অফার। ১১ রকম ভর্তা অনলিমিটেড ভাত। ভোজ হবে পুরো পেট পুরে। সবগুলো ভর্তাই জোস। কাকড়ার টেস্ট ও খুব ভালো। তবে বেস্ট ছিল গরুর কালা ভুনাটা। হাসের মাংসটা সফট ছিল। ওভারঅল খুবি ভালো। আইটেম নাম দাম ১। ভাত ও ভর্তা ১৫০ট ২। গরুর কালা ভুনা ১৫০ট ৩। কাকড়ার দোপেয়াজো ১৫০ট ৪। হাস ভুনা ২০০ রেটিং ৯/১০ অবস্থান পশ্চিম পান্থপথ মসজিদের বিপরীত পাশে।</p> <p>Approach-3</p> <p>১৫০ টাকায় বুফে অফার বিশ্বের সবচেয়ে কম টাকায় সেরা বুফে বাঙালিয়ানা ভোজ বাঙালিয়ানা ভোজের অলমোস্ট সব ফুডই সেরা। এইখানে চলছে মাত্র ১৫০ টাকায় বুফে অফার। ১১ রকম ভর্তা অনলিমিটেড ভাত। ভোজ হবে পুরো পেট পুরে। সবগুলো ভর্তাই জোস। কাকড়ার টেস্ট ও খুব ভালো। তবে বেস্ট ছিল গরুর কালা ভুনাটা। হাসের মাংসটা সফট ছিল। ওভারঅল খুবি ভালো। আইটেম নাম দাম ১। ভাত ও ভর্তা ১৫০ট ২। গরুর কালা ভুনা ১৫০ট ৩। কাকড়ার দোপেয়াজো ১৫০ট ৪। হাস ভুনা ২০০ রেটিং ৯/১০ অবস্থান পশ্চিম পান্থপথ মসজিদের বিপরীত পাশে।</p>	fake
		non-fake