AN OVERVIEW ON GENERATIVE AI AT SCALE WITH EDGE-CLOUD COMPUTING

Yun-Cheng Wang

University of Southern California
Los Angeles, USA
yunchenw@usc.edu

Jintang Xue

University of Southern California
Los Angeles, USA
jintangx@usc.edu

Chengwei Wei

University of Southern California
Los Angeles, USA
chengwei@usc.edu

C.-C. Jay Kuo

University of Southern California
Los Angeles, USA
cckuo@sipi.usc.edu

ABSTRACT

As a specific category of artificial intelligence (AI), generative artificial intelligence (GenAI) generates new content that resembles what is created by humans. The rapid development of GenAI systems has created a huge amount of new data on the Internet, posing new challenges to current computing and communication frameworks. Currently, GenAI services rely on the traditional cloud computing framework due to the need for large computation resources. However, such services will encounter high latency because of data transmission and a high volume of requests. On the other hand, edge-cloud computing can provide adequate computation power and low latency at the same time through the collaboration between edges and the cloud. Thus, it is attractive to build GenAI systems at scale by leveraging the edge-cloud computing paradigm. In this overview paper, we review recent developments in GenAI and edge-cloud computing, respectively. Then, we use two exemplary GenAI applications to discuss technical challenges in scaling up their solutions using edge-cloud collaborative systems. Finally, we list design considerations for training and deploying GenAI systems at scale and point out future research directions.

1 Introduction

Generative AI (GenAI) has emerged as a groundbreaking field to realize artificial general intelligence (AGI) by integrating machine learning and creative content generation. It is a specific category of AI that aims to autonomously generate new content that imitates the content created by humans in different modalities, including images [1, 2], audio [3, 4], text [5, 6], and even 3D objects [7, 8]. With the rapid development of GenAI, various applications, such as text-to-image generation [9], text-to-speech (TTS) synthesis [10], chatbots [11], and AI-rendered virtual reality (VR) [12], have been proposed and are widely used by consumers. However, since most GenAI models have huge model sizes and are computationally demanding, a powerful centralized computation infrastructure (i.e. cloud server) is required to process requests from users. As a result, users may experience high latency if traffic volumes are high. Such limitations hinder their applicability to high-volume applications that require low latency. Besides, the heavy computation in a cloud consumes a significant amount of energy. The overly-centralized computing framework is eco-unfriendly, unsustainable, and cost-inefficient.

In recent years, the proliferation of mobile devices and the exponential growth of data-intensive applications have spurred the development of edge-cloud computing solutions. Edge-cloud computing takes advantage of powerful computation resources in cloud servers and efficient data management and communication in edge servers. It has emerged as a promising solution for consumer-based AI applications and edge intelligence. For example, several large AI models are deployed with the edge-cloud computing system [13, 14]. Compared to traditional cloud computing, which focuses on computation in cloud servers, and multi-access edge computing (MEC), which focuses on computation in edge servers,

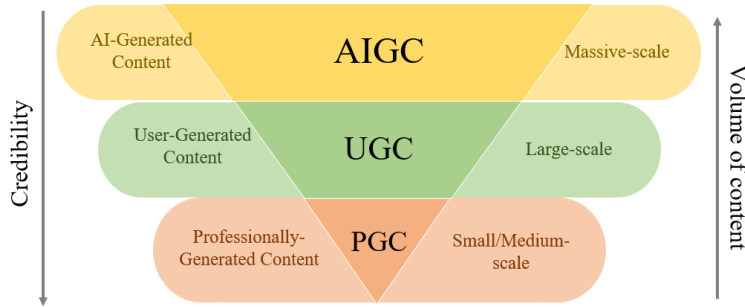

Figure 1: Different phases of content creation.

edge-cloud computing can exploit more computation resources and lower latency through the collaboration between clouds and edges.

GenAI poses unprecedented challenges to scalable computing systems and the need for edge-cloud computing because of three reasons. First, the transmission latency increases significantly in GenAI services due to the tremendous amount of data generated by AI, or so-called AI-generated content (AIGC). Fig. 1 shows the evolution of different phases in content creation. Compared to professionally-generated content (PGC) and user-generated content (UGC), GenAI created much more data on the Internet. As a result, transmission latency becomes a serious challenge in GenAI services. The second challenge is the deployment of computation systems. Currently, most GenAI services target consumer-centric applications. It makes more sense to place the computation system closer to users instead of relying on a centralized computation infrastructure to process all user requests. In addition, edge-cloud computing can preserve more privacy for users by storing their data only on local servers or user devices. Third, the required resources to run GenAI services are huge. For example, ChatGPT by OpenAI¹ is one of the most popular GenAI services recently. It’s a chatbot to answer users’ questions in human-like responses interactively. It processed more than 13 million requests per day in January 2023 [15]. Although the exact computing infrastructure used by the ChatGPT service is not publicly available, we can estimate the cost to run the service each day based on the model architecture of GPT-3 [5], the generative model to support the ChatGPT service. GPT-3 is a large language model (LLM) containing 175 billion parameters, which requires more than 350 GB of RAM and VRAM to run the model. To deploy such a large model, a distributed computing system with at least 2,048 CPUs and 2,048 GPUs in order to handle arbitrary user inputs and achieve reasonable latency. Relying solely on the computation power in the cloud will lead to high latency when the request volume is high. In addition, its daily electricity charge is estimated to be around \$600,000 using Nvidia A100 GPUs. Not to mention the training of GPT-3, which requires 10^8 times computation and more than 10^5 iterations. Thus, it’s unsustainable, and cost-inefficient to deploy such a service entirely on the cloud servers. Collaboration of edge and cloud computing resources will mitigate the burden of cloud servers. In this paper, we examine four aspects of deploying GenAI with edge-cloud computing: 1) computation and data offloading, 2) low latency, 3) personalization, and 4) privacy.

The flow of this paper is illustrated in Fig. 2. Our main contributions are summarized below:

- Provision of a comprehensive overview of recent developments in both GenAI models and edge-cloud computing;
- Identification of technical challenges in the deployment of large-scale GenAI models using today’s solution;
- Presentation of design considerations that target computational efficiency (i.e. lower power consumption), low latency, personalization, and privacy;
- Visualization of two large-scale GenAI applications as concrete examples to support our discussion;
- Future research directions on GenAI systems based on edge-cloud computing.

The rest of this paper is organized below. Comparison of this work and related previous overview papers is made in Sec. 2. Reviews on recent developments of GenAI and edge-cloud computing are conducted in Sec. 3. Two application scenarios are envisioned in Sec. 4. Technical challenges in deploying GenAI systems at scale with current distributed systems are examined in Sec. 5. Design considerations to address them with edge-cloud computing are elaborated in Sec. 6. Finally, future directions are pointed out in Sec. 7, and concluding remarks are given in Sec. 8.

¹<https://openai.com/blog/chatgpt>

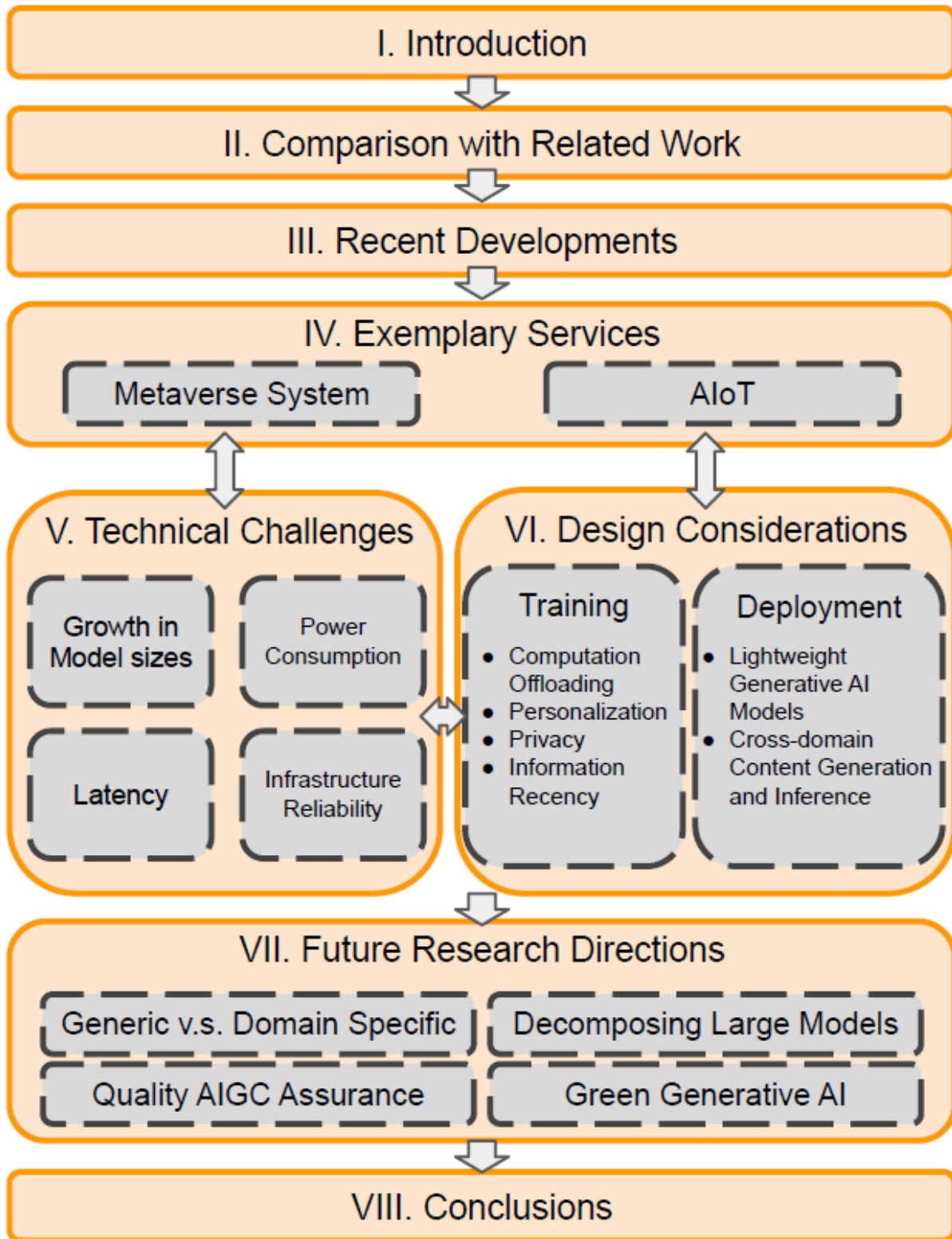

Figure 2: The organization of this paper.

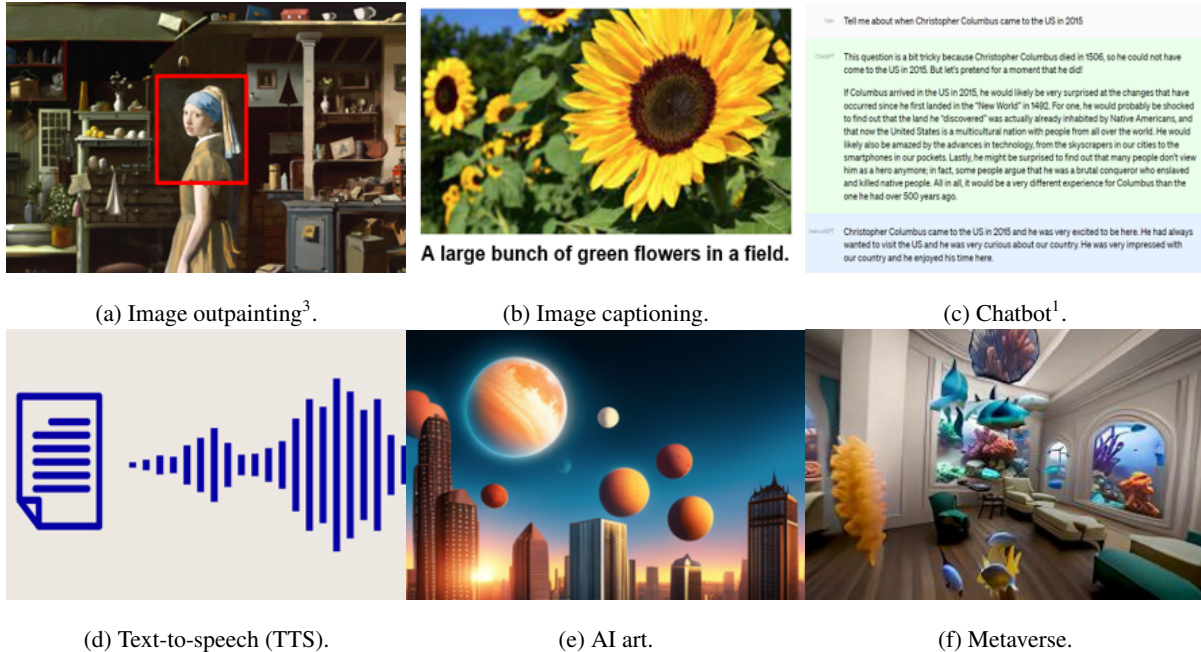

Figure 3: Six illustrative applications of GenAI models: a) image outpainting, b) image captioning, c) chatbot, d) text-to-speech, e) AI art, and f) metaverse.

2 COMPARISON WITH RELATED WORK

We summarize related overview papers and compare them with this work below.

2.1 GENERATIVE AI

After the release of ChatGPT at the end of 2022, interest in GenAI increase rapidly, and a few survey or overview papers on GenAI have been published [16, 15, 17]. Some focus on how GenAI models can be applied to different applications, such as audio diffusion [18], text-to-image generation [19], and multimodality [20] applications. Nevertheless, most of them are concerned with the algorithmic aspect of GenAI. Here, we study technical challenges related to the deployment of GenAI systems at scale and propose a practical cloud-edge computing solution.

2.2 EDGE INTELLIGENCE

There are plenty of survey and overview papers on AI in edge-cloud computing, or so-called “edge intelligence”. Most of them consider discriminative AI tasks, where the systems only need to make binary decisions, such as edge intelligence in surveillance cameras [21, 22], which is an important topic for security. Other emerging edge intelligence applications include unmanned autonomous vehicles (UAV) [23] and the Internet of Things (IoT) [24]. The latter has long been an important field since the arrival of 5G and wireless networks. A roadmap about the integration of edge-cloud computing and AI is given in [25].

GenAI has become a new application domain of AI technology in recent years. It poses emerging challenges, including a huge amount of machine-created content, large model sizes and power consumption, and low latency requirements in some real-time applications, such as GenAI for gaming. It is a critical problem since the amount of transmitted content is much more than discriminant AI tasks. To the best of our knowledge, [26] is the only work that addressed GenAI at the edge. However, it focused on the review of existing papers. In this work, we not only provide a comprehensive review of recent developments of GenAI and edge-cloud computing but also have an in-depth discussion on many related issues, including technical challenges, design considerations, exemplary applications, and future technology outlook of GenAI deployment at scale using the edge-cloud platform.

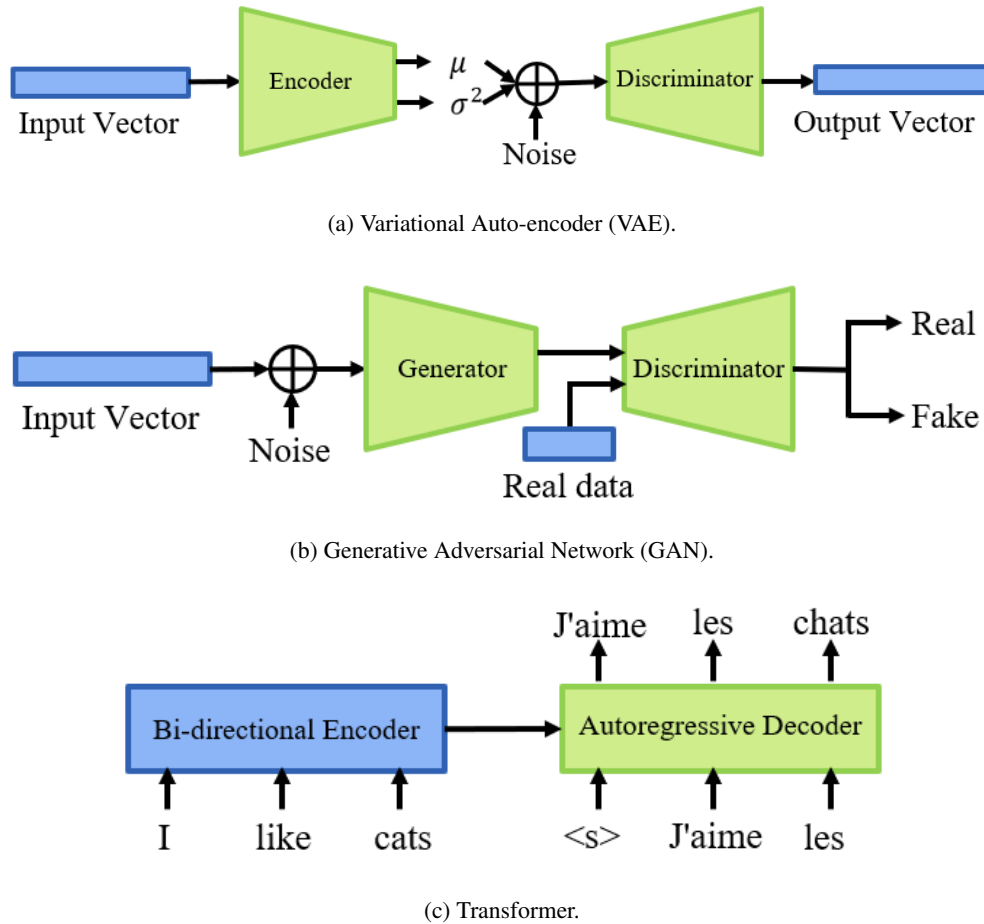

Figure 4: Architectures of three popular GenAI model categories: VAE, GAN, and Transformer.

3 RECENT DEVELOPMENTS IN GENERATIVE AI AND EDGE-CLOUD COMPUTING

3.1 GENERATIVE AI

With the explosion of ChatGPT, GenAI has become a hot topic. GenAI is an AI technology that can generate various multimedia content [27, 28, 20]. Fig. 3 shows some real-world applications of GenAI, including images, texts, audio, graphics, and even 3D objects. The historical development of generative AI can be roughly divided into three eras: 1) the Variational Autoencoder (VAE) and Generative Adversarial Network (GAN) era (2014-2017), 2) the Transformer era (2018-2019), and 3) the large model era (2020-present) [29]. Three popular architectures for GenAI models are shown in Fig. 4.

The Variational Autoencoder (VAE) was first proposed in [30]. It has several variations [31, 32, 33, 34] to improve the quality of the generated content [35, 36], adjust to different levels of supervision [37], and improve the inference efficiency [38]. VAEs are probabilistic generative models. Their encoder and decoder correspond to two neural networks. An encoder maps an input to a vector in a latent space, while the decoder maps a latent vector back to the input space to generate an output. In the training stage, the network parameters are optimized so that the output is as close as possible to the input. Adding noise to latent vectors makes the decoder produce multiple output samples that have the same distribution as input samples.

Similar to VAE, Generative Adversarial Networks (GANs) [1] need two networks in the training stage but keep only one in the inference stage [39, 40, 41, 42]. The two networks are a generator and a discriminator. Through a training process [43, 44], the generator generates better and better fake data that are getting closer to real data in the distribution to fool the discriminator. On the other hand, the discriminator is used to differentiate real and fake data as much as

possible. The generator and discriminator are trained by solving a min-max optimization problem:

$$\min_G \max_D V(G, D) = \mathbb{E}_{x \sim \text{real}} [\log D(x)] + \mathbb{E}_{G(z) \sim \text{fake}} [1 - \log D(G(z))]$$

where $G(\cdot)$ and $D(\cdot)$ denotes the generator and discriminator, respectively. Its capability improves along the training process. Gradually, they reach an equilibrium status where fake and real data are so close that they cannot be easily differentiated. Then, the training stage is completed.

Natural language generation (NLG) models aim to generate human-like textual responses. There are several common applications, such as neural machine translation [45, 46], question answering [47, 48], and document summarization [49, 50]. Such models are also called language models (LMs) [51]. In recent years, transformers [52] with self-attention mechanisms have made major breakthroughs in establishing powerful LMs [53, 54, 55, 56, 57]. Transformers have replaced the long short-term memory (LSTM) [58] as the preferred LM architecture, and set off a new wave of large language models (LLMs) [59, 60, 61, 62]. They often adopt an encoder-decoder architecture as shown in Fig. 4 (c). While the encoder adopts a bi-directional information propagation process to understand the input text, the decoder in most transformer architectures generates words one by one. Such a decoder is also called the autoregressive decoder. With the advent of transformers, generative models are getting larger and larger. Over the past two years, attempts have been made to combine a wide variety of models to create larger and more powerful models. They offer impressive performance in various fields [63]. Due to the large model sizes of GenAI models, they are deployed on the cloud nowadays. That is, models are trained at the training stage and run at the inference stage in cloud servers. Users send requests to the cloud server for content generation. Then, the generated content is sent back to users.

However, due to the long distance between users and the cloud, the above-mentioned framework is not scalable. It has higher generation latency, which hinders specific applications such as augmented reality (AR) / virtual reality (VR) / mixed reality (MR). Furthermore, with the rapid growth of GenAI services, the amount of AI-generated data on the Internet has increased significantly (see Fig. 1). Some GenAI web-based services, such as mid-journey² and DALL-E³, have a large number of users per day. Most GenAI services are not free since the required computation is costly due to high power consumption. Latency can be another major concern once the service becomes popular with growing user requests.

It is worthwhile to emphasize that user feedback is important for model fine-tuning. In other words, there are interactions between the cloud and the edges. Besides, collaboration among users is important for training a more robust and diverse system. Edge-cloud computing provides a natural solution to build GenAI systems at scale. Yet, to the best of our knowledge, there is no research addressing how a distributed system should be designed to accommodate the computation, transmission, and exchange of a huge amount of AIGC data. This motivates us to explore this topic and write this overview paper.

3.2 EDGE-CLOUD COMPUTING

There are three basic paradigms for implementing large-scale computing systems. They are: 1) cloud computing, 2) multi-access edge computing (MEC), or previously mobile-edge computing, and 3) edge-cloud computing, as shown in Fig. 5. Among the three, cloud computing carries out computationally demanding projects using a large number of online servers to serve many remote users. The cloud has much larger computing resources than a local site. Moving compute-intensive tasks to the cloud has been an efficient way of data processing. The concept of cloud computing was introduced in the early 60s [64, 65]. It has made rapid progress in the last several decades and become a mature business service model. Examples include: Amazon Web Services (AWS)⁴, Microsoft Azure⁵, Google Cloud Platform (GCP)⁶, IBM Cloud⁷, Salesforce⁸, etc.

As the computational power of mobile devices increases and wireless networks become accessible at almost any place, multi-access edge computing (MEC) provides computing, storage, and bandwidth closer to users. MEC tends to allocate more computing tasks to the edge than the cloud. Computation can be performed near data sources on edge devices. Edge computing has become more important nowadays, as pointed out in a few studies, e.g., [66, 67, 68, 69, 70]. The MEC framework primarily relies on edge devices, which have limited resources. In addition, the MEC framework

²<https://www.midjourney.com/>

³<https://openai.com/blog/dall-e-introducing-outpainting>

⁴<http://aws.amazon.com/ec2>

⁵<http://www.microsoft.com/azure>

⁶<https://cloud.google.com/>

⁷<https://www.ibm.com/cloud>

⁸<https://www.salesforce.com/>

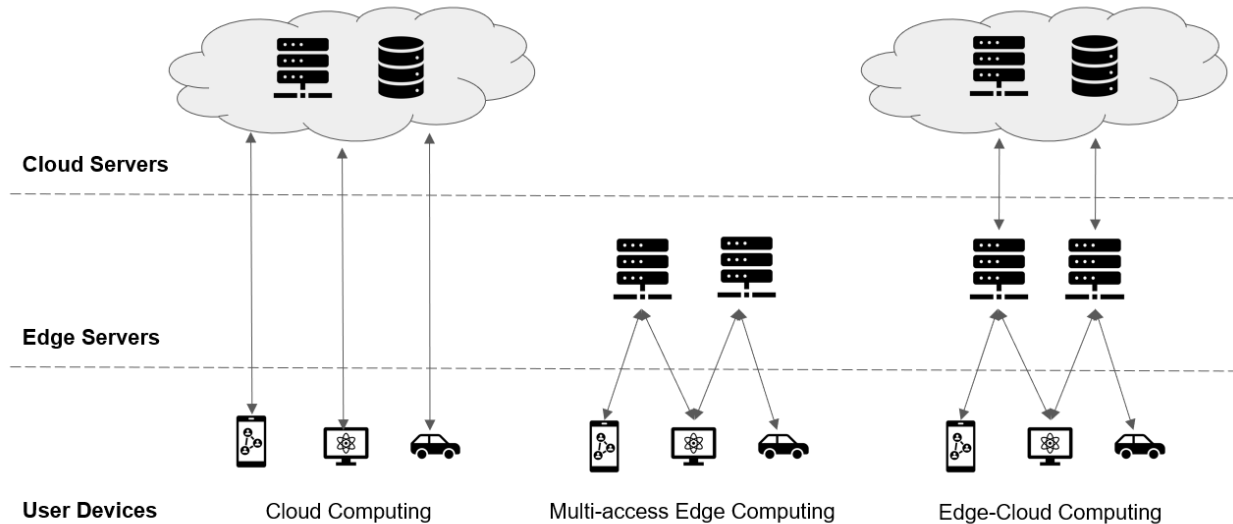

Figure 5: Three basic computing paradigms in support of large-scale computing systems.

Resources	Cloud Servers	Edge Servers	User Devices
Memory	>24TB	~500GB	<64GB
Dist Storage	>25PB	<1PB	<10TB
Latency (RTTs)	30 ~ 50 ms	<10ms	-
Power (per year)	>2,000TWh	~7,500KWh	~600KWh
Concurrent Connections	>500,000	~1,000	1

Table 1: Comparison of hardware and performance specifications of three computational resources, namely cloud servers, edge servers, and user devices.

greatly relies on caching to improve the latency. Thus, its performance is not good for computationally demanding tasks.

As the demand for real-time processing, low-latency communication, and efficient data management increases, the edge-cloud computing paradigm emerges as a new and attractive solution. By combining the power of cloud computing with the proximity and responsiveness of edge devices, edge-cloud computing aims to bridge the gap between latency and scalability. Since it has lower latency, it is suitable for real-time applications such as AR/VR/MR [71, 72], object tracking and detection [73, 74], etc. Since it can utilize computational resources at both the cloud and edges, it has more flexibility in load balancing to yield a more scalable solution. Moreover, user data and privacy can be better preserved by edge-cloud computing [75].

The hardware and performance specifications of three computational resources (namely, cloud servers, edge servers, and user devices) are compared in Table 1. As shown in the table, cloud servers have the highest resources in terms of computational memory and data storage capacity. At the same time, they have the highest power consumption and the largest number of concurrent connections. Their latency is also the highest since they are far from users. It is beneficial to shift some computation loads from cloud servers to edge servers and user devices to balance the computational load and reduce latency in various applications. The load-balancing idea is also called offloading. Computation offloading [76, 77] and data offloading [78, 79] are two key concepts in edge-cloud computing.

The AI tasks suitable for edge servers and cloud servers are shown in Fig. 6. Due to rich computation resources, cloud servers can store and run large models to process high-level tasks. In contrast, edge devices are mainly responsible for low-level pre-processing tasks. Due to the emergence of 5G/IoT, AIGC enters a new era. That is, it is no longer sufficient to conduct all computations and store all data in a centralized cloud server or data center. Similarly, AI computation with edge servers and user devices is also not practical in building a scalable system as AIGC data grows fast.

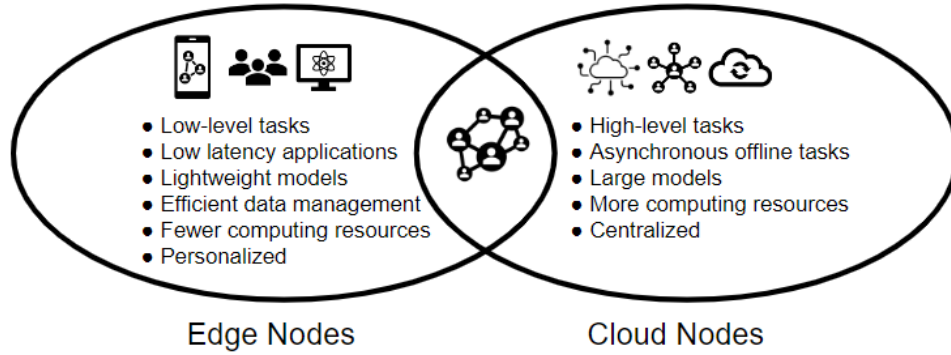

Figure 6: Roles and suitable applications for edge nodes and cloud nodes in edge-cloud computing.

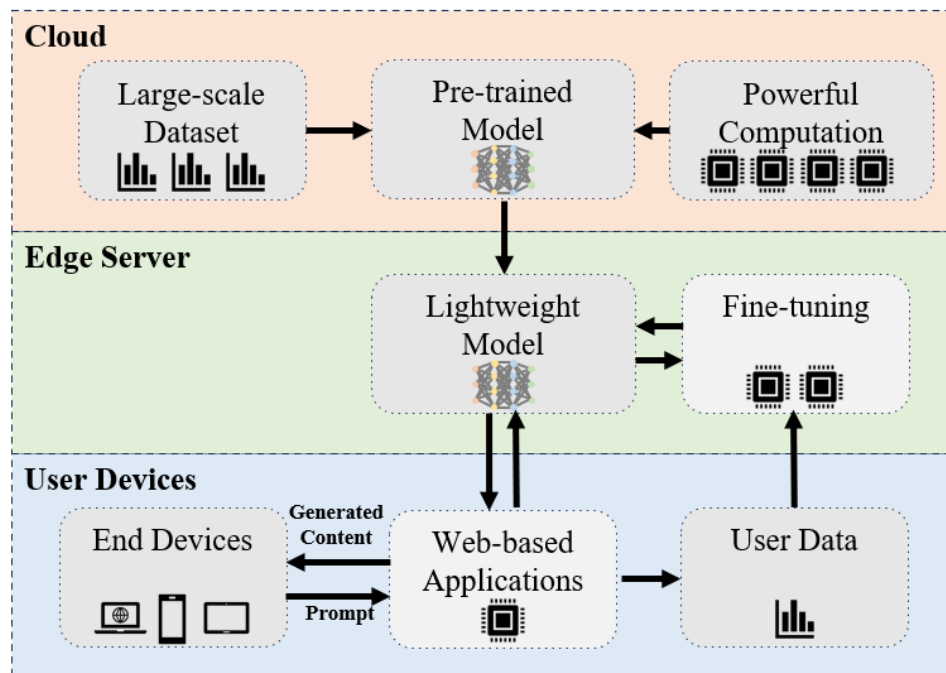

Figure 7: Implementation of GenAI systems with the edge-cloud computing paradigm.

Some large deep-learning AI models are difficult to deploy at the edges. Recently, a green learning methodology [80] has been proposed as an alternative to deep learning. Green learning AI models have much smaller model sizes, significantly lower computational complexity in terms of FLOPs (Floating Point Operations), faster inference time, and less power consumption demand. As a result, green-learning AI models open a new door for edge servers and even user devices in offloading cloud servers. Hybrid deep- and green-learning solutions match the edge-cloud computing paradigm well. That is, GenAI has a unique mission to process low-level data and aggregate high-level abstractions to generate creative content. GenAI can benefit the most from the collaboration of edge and cloud servers.

Recently, Meta announced a supercomputing cluster with very rich computational resources⁹. It can perform five exaflops (billion billion calculations per second) using a total of 16,000 Nvidia A100 GPUs to train state-of-the-art GenAI models. Servers are connected by an NVIDIA Quantum InfiniBand fabric network with a bandwidth of 16 Tb/s to ensure low latency in data synchronization. However, this computational scale is not affordable for most companies and academic institutions. Thus, how to design scalable GenAI systems using a reasonable computing cluster to perform

⁹<https://ai.facebook.com/blog/ai-rsc/>

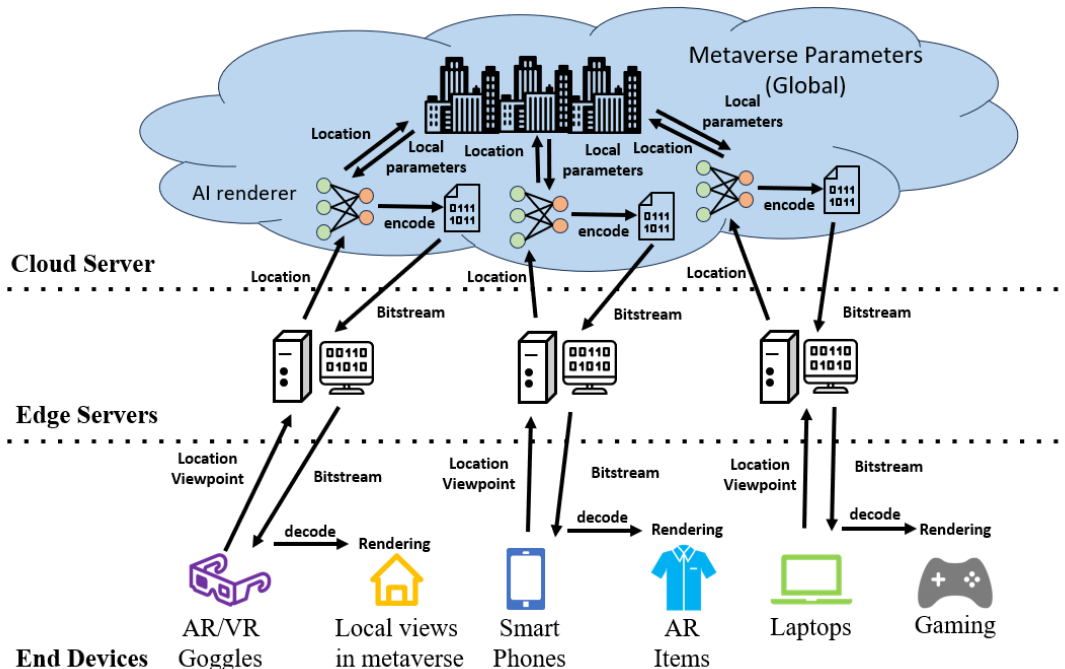

Figure 8: Illustration of the Metaverse system.

similar tasks is of great interest. We put hope in edge-cloud computing since it can leverage expandable computation resources that are under-utilized and closer to users.

The deployment of GenAI systems on the edge-cloud computing platform is shown in Fig. 7. Since the training of GenAI models is most computationally heavy, it is still conducted in cloud servers. The training is usually done offline and asynchronous. The deployment of trained GenAI models for the AIGC tasks can be placed as close to users as possible to lower latency. Edge servers can be used to fine-tune GenAI models, train personalized models, preserve user privacy, and serve as an interface between edges and cloud servers. It is ideal to have several edge servers to handle individual tasks separately. More details about the design considerations will be discussed in Sec. 6.

4 TWO EXEMPLARY SERVICES

In this section, we present two exemplary GenAI services that demand low latency and will have a large number of users when the technologies become mature, and the markets are ready. Scalability based edge-cloud computing is critical to their successful deployment.

4.1 METAVERSE SYSTEM

Metaverse is one of the most important applications in GenAI. With the development of GenAI, most of the generated scenes rely on machine learning models. However, rendering is usually time-consuming. In addition, the metaverse requires an extremely low latency in order to make the transition more smooth and avoid dizziness when looking into virtual reality (VR) goggles. Practically, the metaverse should also connect every user in virtual reality. As a result, a huge map will be required. Edge-cloud computing can be a latency-efficient solution for future metaverse applications. For example, as illustrated in Fig. 8, the entire map is stored in the centralized data center that can be shared among all users. Then, the location, angle, and other parameters can be collected by user devices and transmitted through a wireless network. The cloud computing clusters are also responsible for generating the scenes and rendering the results. The compressed scenes will be sent back to the users. At the user end, a lightweight decoder and renderer are deployed to display the scenes based on the corresponding viewpoints of the users. As a result, such a system design can reduce the latency significantly since the computation-heavy parts are taken care of using powerful computation infrastructure. In addition, the amount of data transmitted in the communication systems is minimized. The users will send the request to the GenAI models in the cloud, and the compressed scenes will be transmitted back to the users.

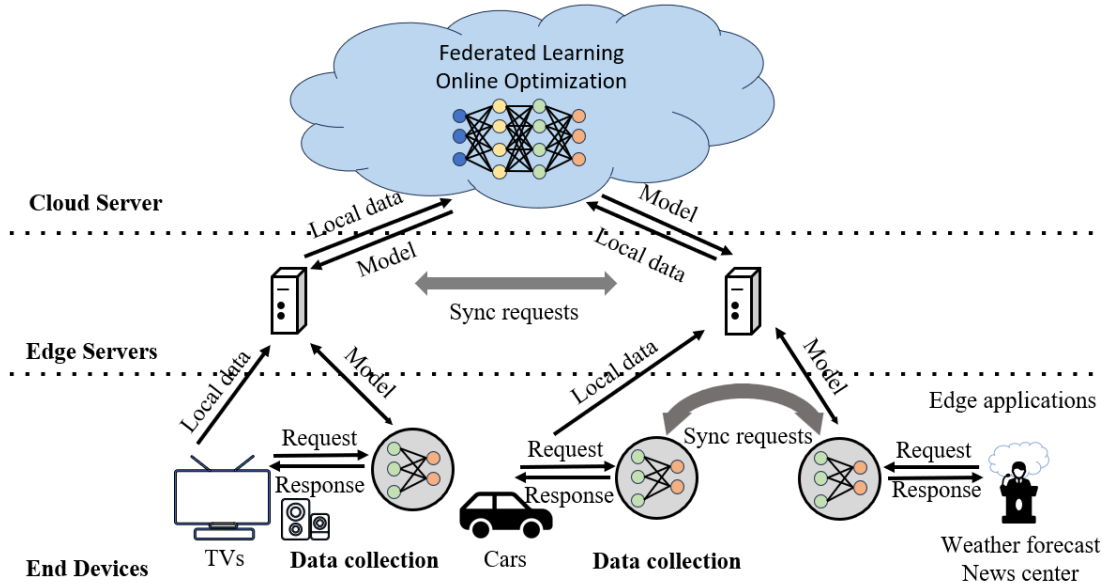

Figure 9: Illustration of the AIoT system.

Edge servers are a fundamental component in the metaverse system. They serve a similar role as in the content delivery network (CDN) to distribute content based on geographical locations and share the computation load in the cloud server. Users in the same locations will be connected to the same edge server. Once a user sends a request to the metaverse system to generate the local scene, it's transmitted through the edge servers and cached. Other users in the same location can access the cached scenes in the edge servers to further reduce the latency. Computation resources in the edge servers should also be leveraged. For example, they can be helpful in compressing and decompressing the scenes generated in the cloud server. As a result, not only the latency can be reduced, but also the quality of the generated scenes is improved.

4.2 ARTIFICIAL INTELLIGENCE OF THINGS

Artificial Intelligence of Things (AIoT) is an emerging application to combine artificial intelligence (AI) technologies in the Internet of Things (IoT) systems. Through the integration of AI and the ubiquitous wireless networking infrastructure, one can build AIoT systems, where the end devices have certain intelligence in data processing and analytics. GenAI can be further exploited to facilitate a broader range of applications. For example, a voiced assistant can interact with users in applications such as autonomous driving, smart cities, and smart home, where fluent human speech has to be automatically generated from information source, which is often in the form of text data.

To implement AIoT with edge-cloud computing, we need to take privacy, personalization, and data synchronization into account. Users may collect data to train more relevant personalized GenAI models. It is desired to train a simple GenAI model with acceptable performance on user devices. Then, model parameters of multiple users can be sent to cloud servers to be integrated into a more advanced GenAI model through federated learning [81, 82]. In addition, data can be constantly collected from the end devices to ensure the information in GenAI models is up-to-date. Online optimization [83, 84] supports training machine learning models with streams of data. User devices can be synchronized with the advanced GenAI model through firmware updates. As a result, the whole system can benefit from a larger pool of training data from users via federated learning while user data privacy can still be preserved.

The hierarchy in edge-cloud computing can be utilized for more efficient model deployment. For example, large, middle-size, and lightweight models can be placed in cloud servers, edge serves, and user devices, respectively. Different resolutions of the models can be achieved through knowledge distillation [85, 86] and model parameter pruning [87, 88]. The computation can be further reduced by grouping users with the same computation facility. Different edge and cloud servers can be specialized to process different applications efficiently. Personalization can be considered to optimize end devices according to user behavior. The personalization fine-tuning on the user devices are generally efficient due to the deployment of lightweight models.

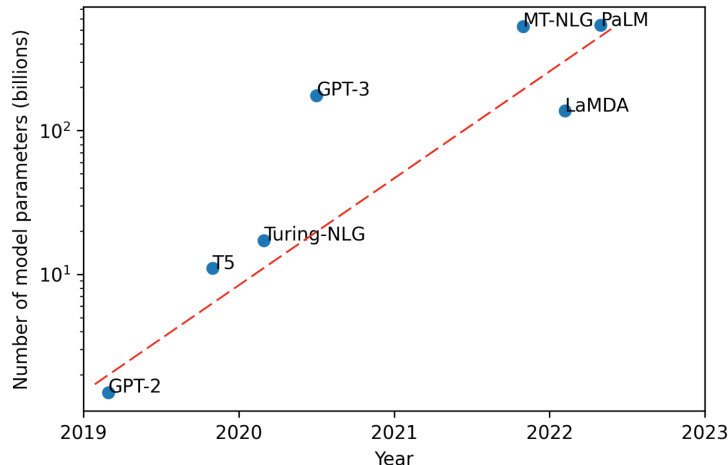

Figure 10: The development of generative LLMs and their model sizes as a function of time. The vertical axis is in log scale. Models in the figure include GPT-2 [89], T5 [90], Turing-NLG [91], GPT-3 [5], LaMDA [92], MT-NLG [91], and PaLM [93].

Model	Modality	Hardware	Power (watts)	Hours	Energy (kWh)	CO ₂ e (lbs)
WaveGAN [95]	Audio	P100 GPU x1	250	96	24	19.63
GANSynth [96]	Audio	V100 GPU x1	300	108	32.4	26.5
FloWaveNet [97]	Audio	V100 GPU x1	300	272	81.6	66.74
BigGAN [98]	Image	V100 GPU x1	300	3,072	921.3	753.54
Stable Diffusion [2]	Image	V100 GPU x1	300	2,184	655	535.72
GPT-2 [89]	Text	TPUv3 x 32	-	168	2.8×10^4	2.39×10^4
GPT-3 [5]	Text	V100 GPU x10,000	-	355	1.29×10^6	1.1×10^6
GLaM [99]	Text	TPUv4s	-	-	4.56×10^5	8×10^4

Table 2: Comparison of power consumption, carbon emission, and cloud computational cost in the training of large GenAI models in different modalities.

5 TECHNICAL CHALLENGES

There are technical challenges in the deployment of GenAI services. The major ones include: 1) growth in model sizes, 2) power consumption, 3) latency, and 4) infrastructure reliability. They are summarized below to demonstrate the need for good resource coordination between edges and the cloud with edge-cloud computing.

5.1 GROWTH IN MODEL SIZES

In order to achieve better performance in various applications, GenAI systems adopt larger models with more model parameters and computation over time. The growth rate of their model sizes is an exponential function of time [94] as shown in Fig. 10. Specifically, the model sizes of neural GenAI models double every 6 months as reported in [16]. This is called “Moore’s Law for GenAI”. In contrast, the computation power of CPUs and GPUs only doubles every two years in the semiconductor manufacturing industry. If the trend continues, the demand for computation will surpass its supply in the near future. Unless there is a major breakthrough in supply, its limitation will hinder the future growth of GenAI systems. Thus, how to train and run GenAI systems through collaboration between the cloud and edges efficiently has become an urgent issue for the entire community to tackle.

5.2 POWER CONSUMPTION

Power consumption is a major concern in cloud computing [100, 101]. The centralized computation infrastructure consumes a significant amount of electricity in running user requests as well as training large models. Fig. 2 compares power consumption, carbon emission, and cloud computational cost in training large GenAI models for different

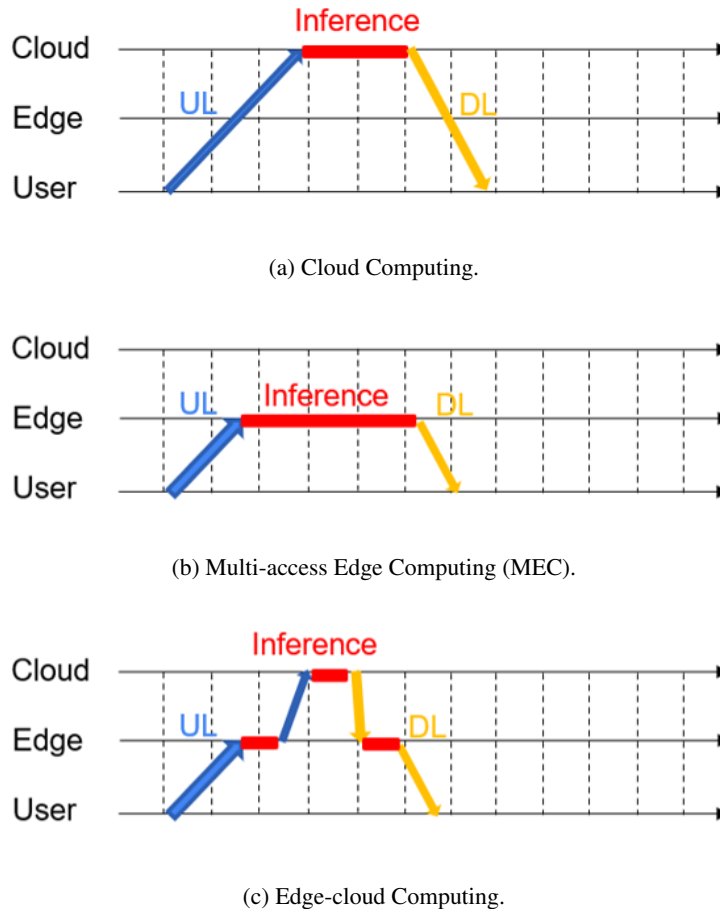

Figure 11: Illustration of latency in different computation frameworks.

modalities. The power consumption of GenAI services is even greater than simply training GenAI models since they need to process millions of requests per day from the users.

Power consumption and carbon emission are closely related to the number of floating point operations (FLOPs). More FLOPs imply higher carbon emissions and electricity bills. For example, the GPT-3 model, the backbone of ChatGPT, demands 10^{23} FLOPs in one training iteration and 10^{15} FLOPs in inference. Since the power efficiency of CPUs/GPUs in modern computation facilities is around 10^{10} FLOPs/sec-watt, it will demand 27.78 kWh (10^5 Joule) to process a single request. Apparently, GenAI services are not scalable. Furthermore, they are eco-unfriendly, unsustainable, and cost-inefficient. To achieve sustainability with large-scale GenAI services, alternative Green solutions under the edge-cloud computing paradigm are essential.

5.3 LATENCY

For real-time GenAI applications such as VR and gaming, it is of uttermost importance to reduce latency. The latency calculation in three different computing frameworks is illustrated in Fig. 11. It is the time between a request sent and its response received at the user end. It is determined by uplink transmission time, inference time, and downlink transmission time; namely,

$$latency = t_{UL} + t_{inference} + t_{DL},$$

where t_{UL} , $t_{inference}$, and t_{DL} denote uplink transmission time, inference time, and downlink transmission time, respectively. In the cloud computing framework, the latency comes from the long uplink transmission time t_{UL} and downlink transmission time t_{DL} . since the computation resources are placed far from the users. In MEC, the transmission delay is reduced since the processing units are placed closer to the users. However, the computation resources in edge servers are not as powerful as the ones in the cloud servers. Thus, the inference time, $t_{inference}$ will be much longer, especially

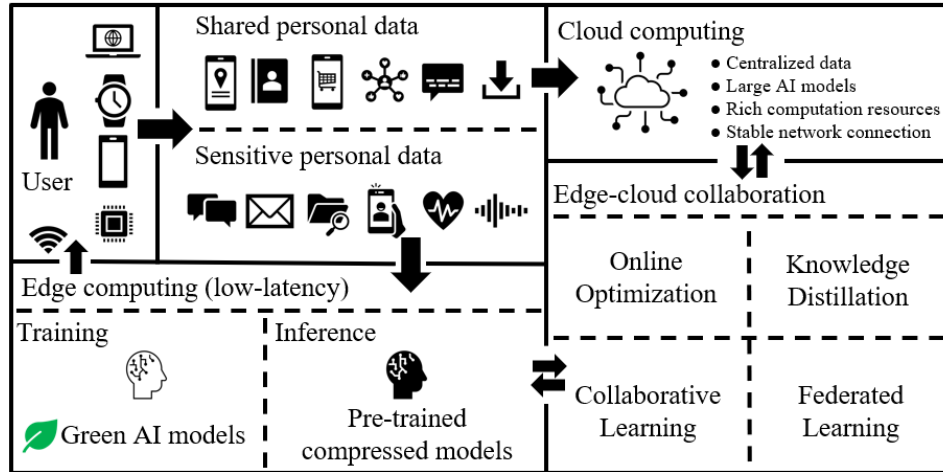

Figure 12: The roadmap of designing GenAI services at scale. Computation offloading, latency, privacy, and data offloading are the major considerations.

for computation-intensive applications, such as GenAI services. In edge-cloud computing, tasks are divided efficiently between the edge and cloud servers. Thus, the overall inference delay can be reduced by leveraging both computation resources in edge and cloud servers. In addition, the transmission delay is also reduced since the connection between edge servers and the cloud is much faster than from the user ends.

For GenAI applications, their inference time can be longer than that of other applications due to larger model sizes and more computations required by GenAI models. Furthermore, the output of GenAI services can be multimedia AIGC. Transmission of multimedia data such as video will demand a longer downlink transmission time t_{DL} than text data. We can reduce t_{DL} by allocating multimedia generation tasks to edge servers. Again, the development of green-learning-based GenAI models are in urgent need.

5.4 INFRASTRUCTURE RELIABILITY

Cloud servers need a large number of GPUs to handle user requests at scale. As mentioned before, Meta has just started a supercomputing center with 16,000 Nvidia A100 GPUs to support their GenAI services. It is unrealistic to set up such powerful but costly infrastructures in many sites globally. Furthermore, such a huge single-site infrastructure is vulnerable to physical and/or cyberspace attacks. Distributed computing with multiple lightweight cloud servers and much more edge servers will offer a more robust AI computational infrastructure in the future.

6 DESIGN CONSIDERATIONS

Design considerations for providing GenAI services at scale using edge-cloud computing are examined in this section. Training and deployment of GenAI services should be considered separately. For the training of GenAI models, a larger amount of computational resources and training data are needed. Key considerations include: 1) computation offloading, 2) personalization, 3) privacy, and 4) information recency. After models are trained, it is desired to deploy them on user devices for lower latency and power consumption. There are two main considerations: 1) lightweight inference models, and 2) multimedia content. For the former, lightweight models are essential because of limited resources on edge servers and user devices. For the latter, multimedia content will become the main media for humans to acquire information as evidenced by the popularity of videos on the Internet nowadays. Cross-domain content generation and interface at edges should be considered carefully. Fig. 12 summarizes the design considerations for providing GenAI services at scale.

6.1 TRAINING

Since the training of large-scale GenAI models is costly, we need to consider the following issues.

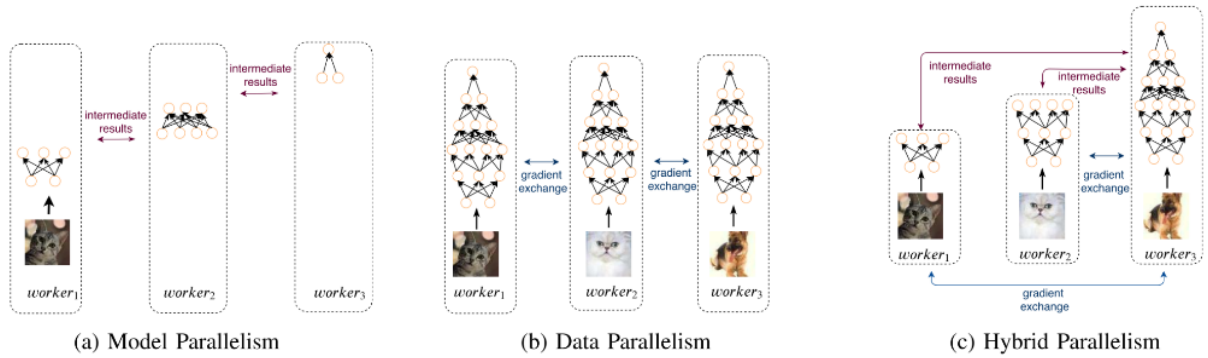

Figure 13: An existing work on computation and data offloading in DNN model training [102].

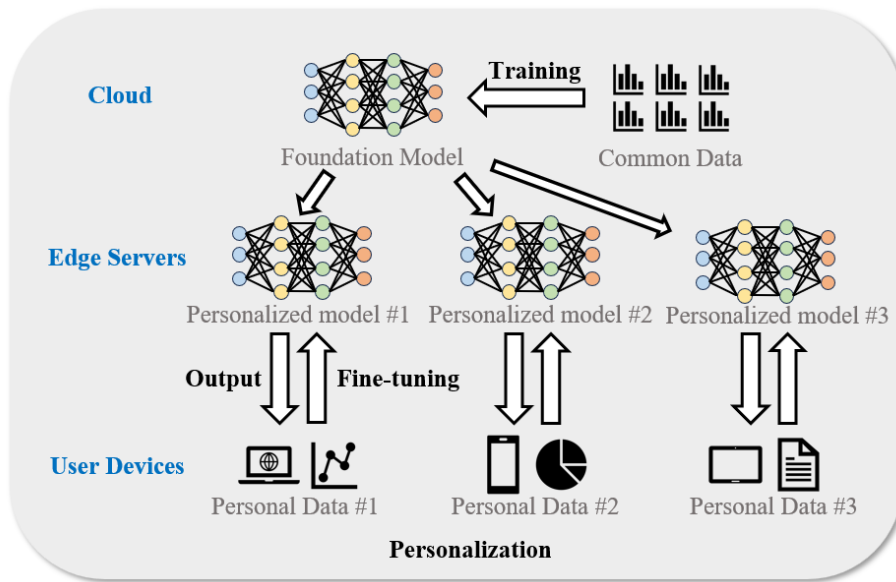

Figure 14: Personalization of GenAI services.

a) Computation offloading. This is an important concept in edge-cloud computing and collaboration. It means that we need to fully utilize computation resources in the cloud and edges. Traditional cloud computing puts all computational loads in the cloud. Users might experience long latency if the cloud resources cannot meet the requirements of sudden heavy service requests. Furthermore, the computational cost to train large GenAI models is extremely high. It may take days or weeks to train large models. Thus, computation offloading has to be considered when training GenAI systems under the edge-cloud computing paradigm.

Most GenAI services adopt deep neural networks (DNNs) as models. DNNs consist of multiple layers. To balance computation loads in training DNNs, we can decouple the training procedure. There is an existing work [102] on DNN training under mobile-edge-cloud computing that illustrates the concepts well, as shown in Fig. 13. In classic cloud computing, all data are transmitted to the cloud server, and the training takes place in the cloud only. In edge-cloud computing with computation offloading, different layers can be trained by different computational facilities (e.g. user devices, edge servers, and the cloud server). For example, as shown in Fig. 13 (a), deeper layers are farthest from users, and they can be trained in the cloud. Gradients are propagated to edge servers to train middle layers. Gradients are propagated again to user devices. Finally, shallow layers are closest to users, and their parameters can be trained on user devices. As a result, system optimization can be carried out through the collaboration of user devices, edge servers, and the cloud server. Only the gradient information has to be transmitted in such a design. Another idea is to decouple the training data as shown in Fig. 13 (b). Smaller DNNs can be trained in parallel by leveraging data parallelism. Then, multiple smaller models can be integrated through federated learning. Finally, a hybrid solution exploiting both model parallelism and data parallelism can be explored as well as shown in Fig. 13 (c). Under the GenAI context, such

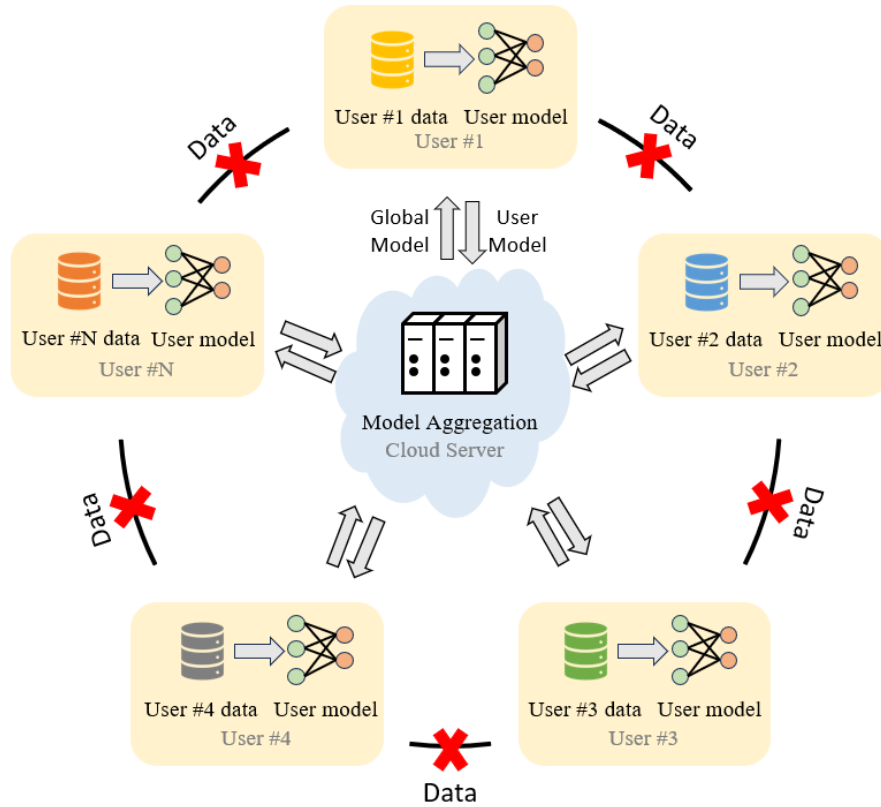

Figure 15: Privacy preservation through federated learning.

parallelism and collaboration between edges and the cloud are even more important. Computation and data offloading should be carefully designed in large-scale GenAI services.

b) Personalization. Edge-cloud computing can provide personalized GenAI models. While training a GenAI model requires a large amount of data, personalization can be achieved by fine-tuning the trained model with a small amount of user data. The collaboration between edges and the cloud for personalized services is depicted in Fig. 14. First, an advanced GenAI model, called the foundation model, should be trained in the cloud with common data. In this step, the trained foundation model can handle general requests. To achieve personalization, personal data, such as user logs and metadata, are collected from user devices and sent to edge servers. The foundation model is also placed in edge servers for personalization. Then, a fine-tuning technique can be developed to shift the model domain from a generic one to a user-specific one using personal data. Typically, fine-tuning requires much fewer computation resources, and it can be entirely conducted in edge servers.

c) Privacy. Privacy is a major concern in GenAI services to prevent personal information from being disclosed to other users and companies. It is particularly important in the context of GenAI services since generated content is difficult to control. One solution to privacy is the use of federated learning, as shown in Fig. 15. The core concept is to share the model parameters among users instead of sharing personal data. Users will have their own models stored in user devices or edge servers based on applications. The models are trained based on user data. Information exchange among users is through aggregating user models in the cloud. That is, all trained user models are transmitted from edges to the cloud, where small user models are combined to train an advanced large model. Finally, model parameters of the advanced model will be synchronized with user models for the next round of training. By sharing model parameters in federated learning, GenAI services can preserve user privacy while collecting relevant information from users.

d) Information Recency. Keeping the information updated is one of the main challenges to GenAI services. For example, chatbots need the most updated information to offer a better user experience. On the other hand, training GenAI models is time-consuming and inefficient. Incremental learning is needed. However, it is not easy to implement in neural network models. Online optimization with edge-cloud computing is an alternative way to keep the services updated. This is illustrated in Fig. 16. Usually, it contains two models - an online model and an offline model. The online model is stored in the cloud server for the most updated information by adopting online optimization. At the same time, a

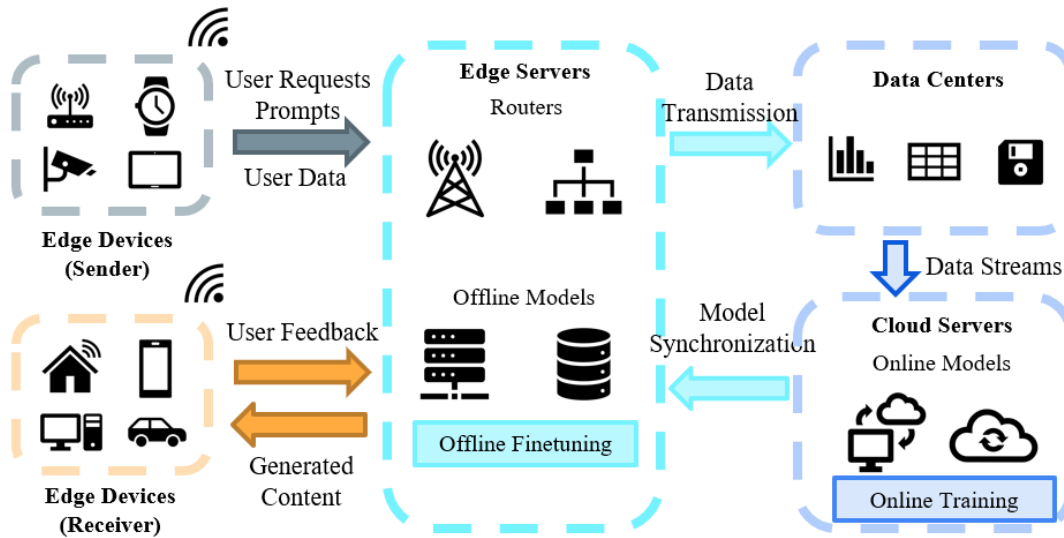

Figure 16: Online optimization in edge-cloud computing.

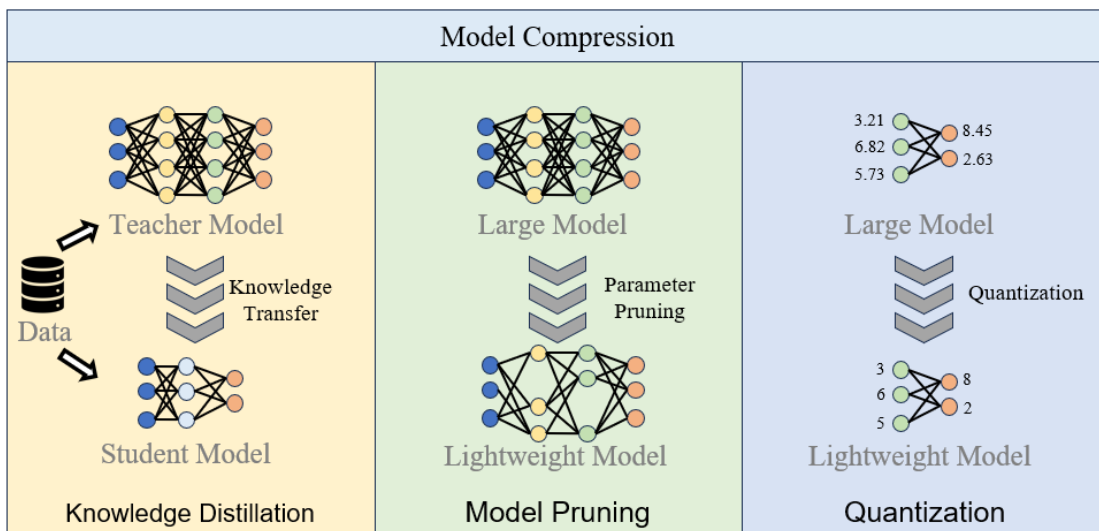

Figure 17: Existing technologies to obtain lightweight GenAI models.

smaller offline model is placed in the edge servers for low latency inference and cloud online model offloading. Online and offline models are synchronized periodically to ensure that edge intelligence is also up-to-date.

6.2 DEPLOYMENT

Two design considerations in deploying GenAI services are elaborated below.

a) *Lightweight GenAI Models.* Deploying GenAI models on edge servers and user devices can lower latency in user-centric applications. Large GenAI models cannot be deployed on user devices due to their large model sizes and high power consumption. Lightweight GenAI models, as summarized in Fig. 17 are more suitable. For example, knowledge distillation can fit into edge-cloud computing well. With knowledge distillation, the knowledge learned in a huge teacher model is transferred to a smaller student model. Thus, the teacher model can be trained and stored in the cloud server while the student model is distilled from the teacher model in the edge servers and, then, stored in user devices. Model pruning adopts a similar concept to train a smaller model from a large model, which takes place in edge

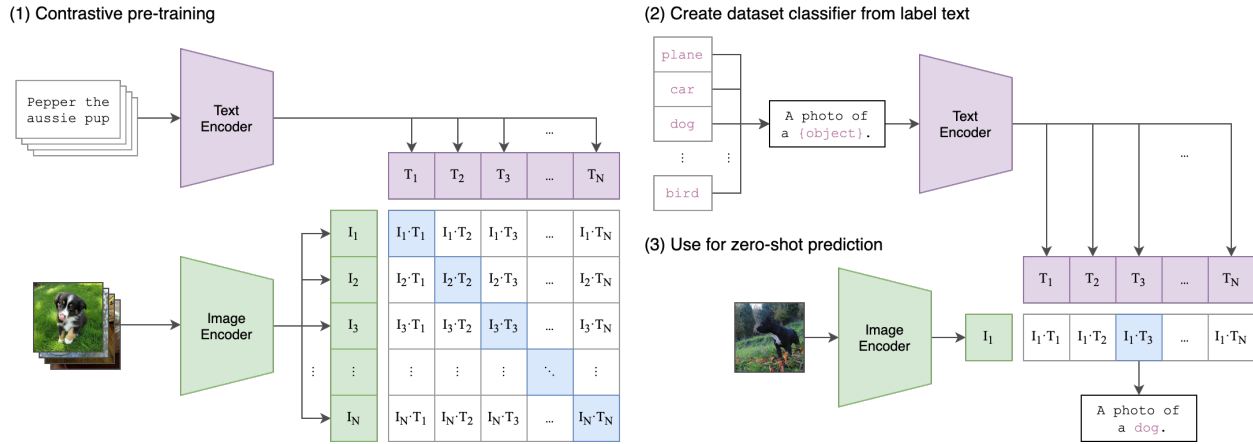

Figure 18: CLIP [104] is a text-to-image generation system that can handle two media modalities by learning a joint embedding space.

servers. Other techniques include quantization and model compression. They can reduce the model sizes effectively without the collaboration between the cloud and edges.

Recently, there are an increasing number of research focusing on developing lightweight GenAI models. LLaMA [6] reduces the number of model parameters in LLMs to as small as 7 billion using a self-instruct training technique, called Alpaca [103]. Lightweight GenAI models encourage the development of mobile- or web-based applications on user devices, such as WebLLM¹⁰. The small model sizes also alleviate the burden in caching-based communication networks. Inference latency is also largely reduced due to lower computation and transmission delay. Research in developing lightweight GenAI models demonstrates the urgency to reduce the ridiculously large models while still having comparable performance.

b) Cross-Domain Content Generation and Interface. Image captioning and text-to-image generation are two examples of cross-domain content generation and interface. To implement cross-domain content generation, we need a joint embedding space to connect two different modalities. For example, as shown in Fig. 18, CLIP [104] is a well-known multi-modality GenAI model. We elaborate on how it can be efficiently deployed under the edge-cloud computing paradigm. The multi-modality models usually consist of three modules: 1) the input module, 2) the generation model, and 3) the output module. The first and third modules are more relevant to users, and they do not require as many computational resources as the second module. Thus, we can place the input/output modules in edge servers or user devices to avoid transmitting generated content. The main generation module is deployed in the cloud server since it requires more computation resources.

7 FUTURE RESEARCH DIRECTIONS

7.1 GENERIC VERSUS DOMAIN-SPECIFIC GENERATIVE AI MODELS

As one of the most famous GenAI services nowadays, ChatGPT provides a generic GenAI model at the expense of large model size and a high running cost. It may be advantageous to trade breadth for depth of generated content to lower the service cost and enhance the quality of services. For instance, the accuracy of generated content is of the top priority in some application domains such as healthcare, financial advice, etc.

7.2 DECOMPOSITION OF LARGE LANGUAGE MODELS

ChatGPT is a large generative language model built upon large pre-trained transformers. It does not leverage the tool of knowledge graphs (KGs). It is appealing to decompose a large language model into smaller ones that have an interface with domain-specific KGs. This decomposition is expected to lower the complexity of GenAI system for cost reduction. The resulting AIGC services can be more transparent and scalable. Furthermore, personalization is easier to offer with the help of KGs [105]. That is, generic KGs are stored in the cloud, while personalized KGs are stored in local servers or user devices.

¹⁰<https://mlc.ai/web-llm/>

7.3 QUALITY AIGC ASSURANCE

We have different considerations against different AIGC modalities. Two examples are given below.

a) *Visual Content.* One may use common sense to evaluate the quality of generated visual content. For example, a picture with a person riding a horse is more natural than the opposite. Generated content that contradicts common sense tends to look strange to users. Sensitive content, copyright content, and trademarks should also be avoided in the generated content [106, 107, 108]. Automatic detection of strange and/or forbidden AIGC is still an open problem. Furthermore, deepfake images can be a security concern for some applications. A lightweight deep fake detection solution [109] has been developed to address this concern.

b) *Textual Content.* The quality of generated texts can be evaluated at three levels: grammatical correctness, readability, and factual correctness. Coherency and conciseness are criteria for readability. This is more difficult to evaluate than grammatical errors. Mis/disinformation is already common over the Internet. It will be even easier to generate a large amount of fake news for malicious purposes with the GenAI service.

7.4 GREEN GENERATIVE AI MODELS

To address the high carbon footprint yielded by huge deep learning networks, green learning [80] has been proposed as an alternative learning paradigm in recent years. A green learning model is characterized by its low carbon footprint, lightweight model, low computational complexity, and logical transparency. Green GenAI models have been explored in the last several years, e.g., NITES [110], TGHop [111], Pager [112], GENHOP [113]. These models are very attractive at the edges. They can also be implemented in cloud servers to reduce carbon footprints and save electricity bills. More efforts along this line are needed.

8 CONCLUSION

The deployment of GenAI services at scale poses a new challenge to the design of modern edge-cloud computational systems due to extremely large model sizes, heavy power consumption, and potential latency caused by a lack of computational and network resources. Two illustrative GenAI services were envisioned to show the importance of developing GenAI systems at scale on one hand and validate the challenging claims on the other hand in this work. Afterward, an in-depth discussion on various design considerations of GenAI services over current communication systems was given. It was concluded that a desired design has to balance computational resources between edges and cloud servers and take latency, data privacy, and personalization into account. Specifically, federated learning is expected to play an important role, where small GenAI models are trained at edges while large GenAI models are trained at the cloud by combining a large number of small models. Most inference tasks can be distributed at edges. Finally, we point out several future research directions, such as domain-specific GenAI models, decomposition of large language models, green GenAI models, and quality AIGC assurance.

References

- [1] Ian Goodfellow, Jean Pouget-Abadie, Mehdi Mirza, Bing Xu, David Warde-Farley, Sherjil Ozair, Aaron Courville, and Yoshua Bengio. Generative adversarial networks. *Communications of the ACM*, 63(11):139–144, 2020.
- [2] Robin Rombach, Andreas Blattmann, Dominik Lorenz, Patrick Esser, and Björn Ommer. High-resolution image synthesis with latent diffusion models. In *Proceedings of the IEEE/CVF Conference on Computer Vision and Pattern Recognition*, pages 10684–10695, 2022.
- [3] Yi Ren, Yangjun Ruan, Xu Tan, Tao Qin, Sheng Zhao, Zhou Zhao, and Tie-Yan Liu. Fastspeech: Fast, robust and controllable text to speech. *Advances in neural information processing systems*, 32, 2019.
- [4] Yi Ren, Chenxu Hu, Xu Tan, Tao Qin, Sheng Zhao, Zhou Zhao, and Tie-Yan Liu. Fastspeech 2: Fast and high-quality end-to-end text to speech. *arXiv preprint arXiv:2006.04558*, 2020.
- [5] Tom Brown, Benjamin Mann, Nick Ryder, Melanie Subbiah, Jared D Kaplan, Prafulla Dhariwal, Arvind Neelakantan, Pranav Shyam, Girish Sastry, Amanda Askell, et al. Language models are few-shot learners. *Advances in neural information processing systems*, 33:1877–1901, 2020.
- [6] Hugo Touvron, Thibaut Lavril, Gautier Izacard, Xavier Martinet, Marie-Anne Lachaux, Timothée Lacroix, Baptiste Rozière, Naman Goyal, Eric Hambro, Faisal Azhar, et al. Llama: Open and efficient foundation language models. *arXiv preprint arXiv:2302.13971*, 2023.

- [7] Daniel Martin, Ana Serrano, Alexander W Bergman, Gordon Wetzstein, and Belen Masia. Scangan360: A generative model of realistic scanpaths for 360 images. *IEEE Transactions on Visualization and Computer Graphics*, 28(5):2003–2013, 2022.
- [8] Alex Nichol, Heewoo Jun, Prafulla Dhariwal, Pamela Mishkin, and Mark Chen. Point-e: A system for generating 3d point clouds from complex prompts. *arXiv preprint arXiv:2212.08751*, 2022.
- [9] Aditya Ramesh, Prafulla Dhariwal, Alex Nichol, Casey Chu, and Mark Chen. Hierarchical text-conditional image generation with clip latents. *arXiv preprint arXiv:2204.06125*, 2022.
- [10] Xu Tan, Jiawei Chen, Haohe Liu, Jian Cong, Chen Zhang, Yanqing Liu, Xi Wang, Yichong Leng, Yuanhao Yi, Lei He, et al. Naturalspeech: End-to-end text to speech synthesis with human-level quality. *arXiv preprint arXiv:2205.04421*, 2022.
- [11] OpenAI. Gpt-4 technical report, 2023.
- [12] Jeremiah Ratican, James Hutson, and Andrew Wright. A proposed meta-reality immersive development pipeline: Generative ai models and extended reality (xr) content for the metaverse. *Journal of Intelligent Learning Systems and Applications*, 15, 2023.
- [13] Xuan Qi and Chen Liu. Enabling deep learning on iot edge: Approaches and evaluation. In *2018 IEEE/ACM Symposium on Edge Computing (SEC)*, pages 367–372. IEEE, 2018.
- [14] Zhujun Xiao, Zhengxu Xia, Haitao Zheng, Ben Y Zhao, and Junchen Jiang. Towards performance clarity of edge video analytics. In *2021 IEEE/ACM Symposium on Edge Computing (SEC)*, pages 148–164. IEEE, 2021.
- [15] Jiayang Wu, Wensheng Gan, Zefeng Chen, Shicheng Wan, and Hong Lin. Ai-generated content (aigc): A survey. *arXiv preprint arXiv:2304.06632*, 2023.
- [16] Yihan Cao, Siyu Li, Yixin Liu, Zhiling Yan, Yutong Dai, Philip S Yu, and Lichao Sun. A comprehensive survey of ai-generated content (aigc): A history of generative ai from gan to chatgpt. *arXiv preprint arXiv:2303.04226*, 2023.
- [17] Chaoning Zhang, Chenshuang Zhang, Sheng Zheng, Yu Qiao, Chenghao Li, Mengchun Zhang, Sumit Kumar Dam, Chu Myaet Thwal, Ye Lin Tun, Le Luang Huy, et al. A complete survey on generative ai (aigc): Is chatgpt from gpt-4 to gpt-5 all you need? *arXiv preprint arXiv:2303.11717*, 2023.
- [18] Chenshuang Zhang, Chaoning Zhang, Sheng Zheng, Mengchun Zhang, Maryam Qamar, Sung-Ho Bae, and In So Kweon. A survey on audio diffusion models: Text to speech synthesis and enhancement in generative ai. *arXiv preprint arXiv:2303.13336*, 2, 2023.
- [19] Chenshuang Zhang, Chaoning Zhang, Mengchun Zhang, and In So Kweon. Text-to-image diffusion model in generative ai: A survey. *arXiv preprint arXiv:2303.07909*, 2023.
- [20] Masahiro Suzuki and Yutaka Matsuo. A survey of multimodal deep generative models. *Advanced Robotics*, 36(5-6):261–278, 2022.
- [21] Jiangchao Yao, Shengyu Zhang, Yang Yao, Feng Wang, Jianxin Ma, Jianwei Zhang, Yunfei Chu, Luo Ji, Kunyang Jia, Tao Shen, et al. Edge-cloud polarization and collaboration: A comprehensive survey for ai. *IEEE Transactions on Knowledge and Data Engineering*, 2022.
- [22] Haochen Hua, Yutong Li, Tonghe Wang, Nanqing Dong, Wei Li, and Junwei Cao. Edge computing with artificial intelligence: A machine learning perspective. *ACM Computing Surveys*, 55(9):1–35, 2023.
- [23] Patrick McEnroe, Shen Wang, and Madhusanka Liyanage. A survey on the convergence of edge computing and ai for uavs: Opportunities and challenges. *IEEE Internet of Things Journal*, 2022.
- [24] Farshad Firouzi, Bahar Farahani, and Alexander Marinšek. The convergence and interplay of edge, fog, and cloud in the ai-driven internet of things (iot). *Information Systems*, 107:101840, 2022.
- [25] Aaron Yi Ding, Ella Peltonen, Tobias Meuser, Atakan Aral, Christian Becker, Schahram Dustdar, Thomas Hiessl, Dieter Kranzlmüller, Madhusanka Liyanage, Setareh Maghsudi, et al. Roadmap for edge ai: A dagstuhl perspective, 2022.
- [26] Minrui Xu, Hongyang Du, Dusit Niyato, Jiawen Kang, Zehui Xiong, Shiwen Mao, Zhu Han, Abbas Jamalipour, Dong In Kim, Victor Leung, et al. Unleashing the power of edge-cloud generative ai in mobile networks: A survey of aigc services. *arXiv preprint arXiv:2303.16129*, 2023.
- [27] Achraf Oussidi and Azeddine Elhassouny. Deep generative models: Survey. In *2018 International conference on intelligent systems and computer vision (ISCV)*, pages 1–8. IEEE, 2018.

- [28] GM Harshvardhan, Mahendra Kumar Gourisaria, Manjusha Pandey, and Siddharth Swarup Rautaray. A comprehensive survey and analysis of generative models in machine learning. *Computer Science Review*, 38:100285, 2020.
- [29] David Foster. *Generative deep learning: teaching machines to paint, write, compose, and play*. O'Reilly Media, 2019.
- [30] Diederik P Kingma and Max Welling. Auto-encoding variational bayes. *arXiv preprint arXiv:1312.6114*, 2013.
- [31] Ruoqi Wei, Cesar Garcia, Ahmed El-Sayed, Viyaleta Peterson, and Ausif Mahmood. Variations in variational autoencoders—a comparative evaluation. *Ieee Access*, 8:153651–153670, 2020.
- [32] Laurent Girin, Simon Leglaive, Xiaoyu Bie, Julien Diard, Thomas Hueber, and Xavier Alameda-Pineda. Dynamical variational autoencoders: A comprehensive review. *arXiv preprint arXiv:2008.12595*, 2020.
- [33] Junhai Zhai, Sufang Zhang, Junfen Chen, and Qiang He. Autoencoder and its various variants. In *2018 IEEE international conference on systems, man, and cybernetics (SMC)*, pages 415–419. IEEE, 2018.
- [34] Andrea Asperti, Davide Evangelista, and Elena Loli Piccolomini. A survey on variational autoencoders from a green ai perspective. *SN Computer Science*, 2(4):301, 2021.
- [35] Ilya Tolstikhin, Olivier Bousquet, Sylvain Gelly, and Bernhard Schoelkopf. Wasserstein auto-encoders. *arXiv preprint arXiv:1711.01558*, 2017.
- [36] Anders Boesen Lindbo Larsen, Søren Kaae Sønderby, Hugo Larochelle, and Ole Winther. Autoencoding beyond pixels using a learned similarity metric. In *International conference on machine learning*, pages 1558–1566. PMLR, 2016.
- [37] Rui Gao, Xingsong Hou, Jie Qin, Jiaxin Chen, Li Liu, Fan Zhu, Zhao Zhang, and Ling Shao. Zero-vae-gan: Generating unseen features for generalized and transductive zero-shot learning. *IEEE Transactions on Image Processing*, 29:3665–3680, 2020.
- [38] Kihyuk Sohn, Honglak Lee, and Xinchen Yan. Learning structured output representation using deep conditional generative models. *Advances in neural information processing systems*, 28, 2015.
- [39] Zhengwei Wang, Qi She, and Tomas E Ward. Generative adversarial networks in computer vision: A survey and taxonomy. *ACM Computing Surveys (CSUR)*, 54(2):1–38, 2021.
- [40] Zhaoqing Pan, Weijie Yu, Xiaokai Yi, Asifullah Khan, Feng Yuan, and Yuhui Zheng. Recent progress on generative adversarial networks (gans): A survey. *IEEE access*, 7:36322–36333, 2019.
- [41] Yongjun Hong, Uiwon Hwang, Jaeyoon Yoo, and Sungroh Yoon. How generative adversarial networks and their variants work: An overview. *ACM Computing Surveys (CSUR)*, 52(1):1–43, 2019.
- [42] Antonia Creswell, Tom White, Vincent Dumoulin, Kai Arulkumaran, Biswa Sengupta, and Anil A Bharath. Generative adversarial networks: An overview. *IEEE signal processing magazine*, 35(1):53–65, 2018.
- [43] Jie Gui, Zhenan Sun, Yonggang Wen, Dacheng Tao, and Jieping Ye. A review on generative adversarial networks: Algorithms, theory, and applications. *IEEE transactions on knowledge and data engineering*, 2021.
- [44] Abdul Jabbar, Xi Li, and Bourahla Omar. A survey on generative adversarial networks: Variants, applications, and training. *ACM Computing Surveys (CSUR)*, 54(8):1–49, 2021.
- [45] Kyunghyun Cho, Bart Van Merriënboer, Caglar Gulcehre, Dzmitry Bahdanau, Fethi Bougares, Holger Schwenk, and Yoshua Bengio. Learning phrase representations using rnn encoder-decoder for statistical machine translation. arxiv 2014. *arXiv preprint arXiv:1406.1078*, 2020.
- [46] Ilya Sutskever, Oriol Vinyals, and Quoc V. Le. Sequence to sequence learning with neural networks, 2014.
- [47] Kevin Clark, Minh-Thang Luong, Quoc V Le, and Christopher D Manning. Electra: Pre-training text encoders as discriminators rather than generators. *arXiv preprint arXiv:2003.10555*, 2020.
- [48] Zhilin Yang, Zihang Dai, Yiming Yang, Jaime Carbonell, Russ R Salakhutdinov, and Quoc V Le. Xlnet: Generalized autoregressive pretraining for language understanding. *Advances in neural information processing systems*, 32, 2019.
- [49] Bin Wang, Chen Zhang, Chengwei Wei, and Haizhou Li. A focused study on sequence length for dialogue summarization. *arXiv preprint arXiv:2209.11910*, 2022.
- [50] Preksha Nema, Mitesh Khapra, Anirban Laha, and Balaraman Ravindran. Diversity driven attention model for query-based abstractive summarization. *arXiv preprint arXiv:1704.08300*, 2017.
- [51] Chengwei Wei, Yun-Cheng Wang, Bin Wang, and C-C Jay Kuo. An overview on language models: Recent developments and outlook. *arXiv preprint arXiv:2303.05759*, 2023.

- [52] Ashish Vaswani, Noam Shazeer, Niki Parmar, Jakob Uszkoreit, Llion Jones, Aidan N Gomez, Łukasz Kaiser, and Illia Polosukhin. Attention is all you need. *Advances in neural information processing systems*, 30, 2017.
- [53] K. Han, Y. Wang, H. Chen, X. Chen, J. Guo, Z. Liu, Y. Tang, A. Xiao, C. Xu, Y. Xu, Z. Yang, Y. Zhang, and D. Tao. A survey on vision transformer. *IEEE Transactions on Pattern Analysis and Machine Intelligence*, 45(01):87–110, jan 2023.
- [54] Salman Khan, Muzammal Naseer, Munawar Hayat, Syed Waqas Zamir, Fahad Shahbaz Khan, and Mubarak Shah. Transformers in vision: A survey. *ACM computing surveys (CSUR)*, 54(10s):1–41, 2022.
- [55] Yi Tay, Mostafa Dehghani, Dara Bahri, and Donald Metzler. Efficient transformers: A survey. *ACM Computing Surveys*, 55(6):1–28, 2022.
- [56] Yang Liu, Yao Zhang, Yixin Wang, Feng Hou, Jin Yuan, Jiang Tian, Yang Zhang, Zhongchao Shi, Jianping Fan, and Zhiqiang He. A survey of visual transformers. *IEEE Transactions on Neural Networks and Learning Systems*, 2023.
- [57] Javier Selva, Anders S Johansen, Sergio Escalera, Kamal Nasrollahi, Thomas B Moeslund, and Albert Clapés. Video transformers: A survey. *IEEE Transactions on Pattern Analysis and Machine Intelligence*, 2023.
- [58] Sepp Hochreiter and Jürgen Schmidhuber. Long short-term memory. *Neural computation*, 9(8):1735–1780, 1997.
- [59] Tianyang Lin, Yuxin Wang, Xiangyang Liu, and Xipeng Qiu. A survey of transformers. *AI Open*, 2022.
- [60] Katikapalli Subramanyam Kalyan, Ajit Rajasekharan, and Sivanesan Sangeetha. Ammus: A survey of transformer-based pretrained models in natural language processing. *arXiv preprint arXiv:2108.05542*, 2021.
- [61] Hanqing Zhang, Haolin Song, Shaoyu Li, Ming Zhou, and Dawei Song. A survey of controllable text generation using transformer-based pre-trained language models. *arXiv preprint arXiv:2201.05337*, 2022.
- [62] Yifan Du, Zikang Liu, Junyi Li, and Wayne Xin Zhao. A survey of vision-language pre-trained models. *arXiv preprint arXiv:2202.10936*, 2022.
- [63] Roberto Gozalo-Brizuela and Eduardo C Garrido-Merchan. Chatgpt is not all you need. a state of the art review of large generative ai models. *arXiv preprint arXiv:2301.04655*, 2023.
- [64] Simson Garfinkel. *Architects of the information society: 35 years of the Laboratory for Computer Science at MIT*. MIT press, 1999.
- [65] Jayachander Surbiryala and Chunming Rong. Cloud computing: History and overview. In *2019 IEEE Cloud Summit*, pages 1–7. IEEE, 2019.
- [66] Sijing Duan, Dan Wang, Ju Ren, Feng Lyu, Ye Zhang, Huaqing Wu, and Xuemin Shen. Distributed artificial intelligence empowered by end-edge-cloud computing: A survey. *IEEE Communications Surveys & Tutorials*, 2022.
- [67] Yuyi Mao, Changsheng You, Jun Zhang, Kaibin Huang, and Khaled B Letaief. A survey on mobile edge computing: The communication perspective. *IEEE communications surveys & tutorials*, 19(4):2322–2358, 2017.
- [68] Weisong Shi and Schahram Dustdar. The promise of edge computing. *Computer*, 49(5):78–81, 2016.
- [69] Keyan Cao, Yefan Liu, Gongjie Meng, and Qimeng Sun. An overview on edge computing research. *IEEE access*, 8:85714–85728, 2020.
- [70] Ibrahim A Elgendy and Rahul Yadav. Survey on mobile edge-cloud computing: A taxonomy on computation offloading approaches. *Security and Privacy Preserving for IoT and 5G Networks: Techniques, Challenges, and New Directions*, pages 117–158, 2022.
- [71] Wuyang Zhang, Jiachen Chen, Yanyong Zhang, and Dipankar Raychaudhuri. Towards efficient edge cloud augmentation for virtual reality mmogs. In *Proceedings of the Second ACM/IEEE Symposium on Edge Computing*, pages 1–14, 2017.
- [72] Melike Erol-Kantarci and Sukhmani Sukhmani. Caching and computing at the edge for mobile augmented reality and virtual reality (ar/vr) in 5g. In *Ad Hoc Networks: 9th International Conference, AdHocNets 2017, Niagara Falls, ON, Canada, September 28–29, 2017, Proceedings*, pages 169–177. Springer, 2018.
- [73] Ju Ren, Yundi Guo, Deyu Zhang, Qingqing Liu, and Yaoyue Zhang. Distributed and efficient object detection in edge computing: Challenges and solutions. *IEEE Network*, 32(6):137–143, 2018.
- [74] Shreshth Tuli, Nipam Basumatary, and Rajkumar Buyya. Edgelens: Deep learning based object detection in integrated iot, fog and cloud computing environments. In *2019 4th International Conference on Information Systems and Computer Networks (ISCON)*, pages 496–502. IEEE, 2019.

- [75] Shalin Parikh, Dharmin Dave, Reema Patel, and Nishant Doshi. Security and privacy issues in cloud, fog and edge computing. *Procedia Computer Science*, 160:734–739, 2019.
- [76] Chuan Feng, Pengchao Han, Xu Zhang, Bowen Yang, Yejun Liu, and Lei Guo. Computation offloading in mobile edge computing networks: A survey. *Journal of Network and Computer Applications*, page 103366, 2022.
- [77] SM Asiful Huda and Sangman Moh. Survey on computation offloading in uav-enabled mobile edge computing. *Journal of Network and Computer Applications*, page 103341, 2022.
- [78] Ming Zhao, Jiahua Li, Fengxiao Tang, Sohaib Asif, and Yusen Zhu. Learning based massive data offloading in the iov: Routing based on pre-rlga. *IEEE Transactions on Network Science and Engineering*, 9(4):2330–2340, 2022.
- [79] Abhishek Hazra, Mainak Adhikari, Tarachand Amgoth, and Satish Narayana Srirama. Fog computing for energy-efficient data offloading of iot applications in industrial sensor networks. *IEEE Sensors Journal*, 22(9):8663–8671, 2022.
- [80] C-C Jay Kuo and Azad M Madni. Green learning: Introduction, examples and outlook. *Journal of Visual Communication and Image Representation*, page 103685, 2022.
- [81] Dinh C Nguyen, Ming Ding, Pubudu N Pathirana, Aruna Seneviratne, Jun Li, and H Vincent Poor. Federated learning for internet of things: A comprehensive survey. *IEEE Communications Surveys & Tutorials*, 23(3):1622–1658, 2021.
- [82] Latif U Khan, Walid Saad, Zhu Han, Ekram Hossain, and Choong Seon Hong. Federated learning for internet of things: Recent advances, taxonomy, and open challenges. *IEEE Communications Surveys & Tutorials*, 23(3):1759–1799, 2021.
- [83] Fangyuan Li, Jiahu Qin, and Wei Xing Zheng. Distributed q -learning-based online optimization algorithm for unit commitment and dispatch in smart grid. *IEEE transactions on cybernetics*, 50(9):4146–4156, 2019.
- [84] Hao Wu, Xinchun Lyu, and Hui Tian. Online optimization of wireless powered mobile-edge computing for heterogeneous industrial internet of things. *IEEE Internet of Things Journal*, 6(6):9880–9892, 2019.
- [85] Lin Wang and Kuk-Jin Yoon. Knowledge distillation and student-teacher learning for visual intelligence: A review and new outlooks. *IEEE Transactions on Pattern Analysis and Machine Intelligence*, 2021.
- [86] Jianping Gou, Baosheng Yu, Stephen J Maybank, and Dacheng Tao. Knowledge distillation: A survey. *International Journal of Computer Vision*, 129:1789–1819, 2021.
- [87] Lanlan Rui, Siqi Yang, Shiyong Chen, Yang Yang, and Zhipeng Gao. Smart network maintenance in an edge cloud computing environment: An adaptive model compression algorithm based on model pruning and model clustering. *IEEE Transactions on Network and Service Management*, 2022.
- [88] Yuang Jiang, Shiqiang Wang, Victor Valls, Bong Jun Ko, Wei-Han Lee, Kin K Leung, and Leandros Tassioulas. Model pruning enables efficient federated learning on edge devices. *IEEE Transactions on Neural Networks and Learning Systems*, 2022.
- [89] Alec Radford, Jeffrey Wu, Rewon Child, David Luan, Dario Amodei, Ilya Sutskever, et al. Language models are unsupervised multitask learners. *OpenAI blog*, 1(8):9, 2019.
- [90] Colin Raffel, Noam Shazeer, Adam Roberts, Katherine Lee, Sharan Narang, Michael Matena, Yanqi Zhou, Wei Li, and Peter J Liu. Exploring the limits of transfer learning with a unified text-to-text transformer. *The Journal of Machine Learning Research*, 21(1):5485–5551, 2020.
- [91] Shaden Smith, Mostofa Patwary, Brandon Norick, Patrick LeGresley, Samyam Rajbhandari, Jared Casper, Zhun Liu, Shrimai Prabhumoye, George Zerveas, Vijay Korthikanti, et al. Using deepspeed and megatron to train megatron-turing nlg 530b, a large-scale generative language model. *arXiv preprint arXiv:2201.11990*, 2022.
- [92] Romal Thoppilan, Daniel De Freitas, Jamie Hall, Noam Shazeer, Apoorv Kulshreshtha, Heng-Tze Cheng, Alicia Jin, Taylor Bos, Leslie Baker, Yu Du, et al. Lamda: Language models for dialog applications. *arXiv preprint arXiv:2201.08239*, 2022.
- [93] Aakanksha Chowdhery, Sharan Narang, Jacob Devlin, Maarten Bosma, Gaurav Mishra, Adam Roberts, Paul Barham, Hyung Won Chung, Charles Sutton, Sebastian Gehrmann, et al. Palm: Scaling language modeling with pathways. *arXiv preprint arXiv:2204.02311*, 2022.
- [94] Jared Kaplan, Sam McCandlish, Tom Henighan, Tom B Brown, Benjamin Chess, Rewon Child, Scott Gray, Alec Radford, Jeffrey Wu, and Dario Amodei. Scaling laws for neural language models. *arXiv preprint arXiv:2001.08361*, 2020.
- [95] Chris Donahue, Julian McAuley, and Miller Puckette. Adversarial audio synthesis. *arXiv preprint arXiv:1802.04208*, 2018.

- [96] Jesse Engel, Kumar Krishna Agrawal, Shuo Chen, Ishaan Gulrajani, Chris Donahue, and Adam Roberts. Gansynth: Adversarial neural audio synthesis. *arXiv preprint arXiv:1902.08710*, 2019.
- [97] Sungwon Kim, Sang-gil Lee, Jongyoon Song, Jaehyeon Kim, and Sungroh Yoon. Flowavenet: A generative flow for raw audio. *arXiv preprint arXiv:1811.02155*, 2018.
- [98] Andrew Brock, Jeff Donahue, and Karen Simonyan. Large scale gan training for high fidelity natural image synthesis. *arXiv preprint arXiv:1809.11096*, 2018.
- [99] David Patterson, Joseph Gonzalez, Quoc Le, Chen Liang, Lluís-Miquel Munguia, Daniel Rothchild, David So, Maud Texier, and Jeff Dean. Carbon emissions and large neural network training. *arXiv preprint arXiv:2104.10350*, 2021.
- [100] Haobo Xu, Ying Wang, Yujie Wang, Jiajun Li, Bosheng Liu, and Yinhe Han. Acg-engine: An inference accelerator for content generative neural networks. In *2019 IEEE/ACM International Conference on Computer-Aided Design (ICCAD)*, pages 1–7. IEEE, 2019.
- [101] Maxime Mirka, Maxime France-Pillois, Gilles Sassatelli, and Abdoulaye Gamatié. A generative ai for heterogeneous network-on-chip design space pruning. In *2022 Design, Automation & Test in Europe Conference & Exhibition (DATE)*, pages 1135–1138. IEEE, 2022.
- [102] Deyin Liu, Xu Chen, Zhi Zhou, and Qing Ling. Hiertrain: Fast hierarchical edge ai learning with hybrid parallelism in mobile-edge-cloud computing. *IEEE Open Journal of the Communications Society*, 1:634–645, 2020.
- [103] Rohan Taori, Ishaan Gulrajani, Tianyi Zhang, Yann Dubois, Xuechen Li, Carlos Guestrin, Percy Liang, and Tatsunori B Hashimoto. Alpaca: A strong, replicable instruction-following model. *Stanford Center for Research on Foundation Models*. <https://crfm.stanford.edu/2023/03/13/alpaca.html>, 3(6):7, 2023.
- [104] Alec Radford, Jong Wook Kim, Chris Hallacy, Aditya Ramesh, Gabriel Goh, Sandhini Agarwal, Girish Sastry, Amanda Askell, Pamela Mishkin, Jack Clark, et al. Learning transferable visual models from natural language supervision. In *International conference on machine learning*, pages 8748–8763. PMLR, 2021.
- [105] Tara Safavi, Caleb Belth, Lukas Faber, Davide Mottin, Emmanuel Müller, and Danaï Koutra. Personalized knowledge graph summarization: From the cloud to your pocket. In *2019 IEEE International Conference on Data Mining (ICDM)*, pages 528–537. IEEE, 2019.
- [106] Zicheng Zhang, Chunyi Li, Wei Sun, Xiaohong Liu, Xiongkuo Min, and Guangtao Zhai. A perceptual quality assessment exploration for aigc images. *arXiv preprint arXiv:2303.12618*, 2023.
- [107] Hongyang Du, Zonghang Li, Dusit Niyato, Jiawen Kang, Zehui Xiong, Huawei Huang, and Shiwen Mao. Generative ai-aided optimization for ai-generated content (aigc) services in edge networks. *arXiv preprint arXiv:2303.13052*, 2023.
- [108] Hongyang Du, Zonghang Li, Dusit Niyato, Jiawen Kang, Zehui Xiong, Dong In Kim, et al. Enabling ai-generated content (aigc) services in wireless edge networks. *arXiv preprint arXiv:2301.03220*, 2023.
- [109] Hong-Shuo Chen, Mozhddeh Rouhsedaghat, Hamza Ghani, Shuowen Hu, Suya You, and C-C Jay Kuo. Defakehop: A light-weight high-performance deepfake detector. In *2021 IEEE International Conference on Multimedia and Expo (ICME)*, pages 1–6. IEEE, 2021.
- [110] Xuejing Lei, Ganning Zhao, and C.-C. Jay Kuo. NITES: A non-parametric interpretable texture synthesis method. In *2020 Asia-Pacific Signal and Information Processing Association Annual Summit and Conference (APSIPA ASC)*, pages 1698–1706. IEEE, 2020.
- [111] Xuejing Lei, Ganning Zhao, Kaitai Zhang, and C-C Jay Kuo. Tghop: an explainable, efficient, and lightweight method for texture generation. *APSIPA Transactions on Signal and Information Processing*, 10, 2021.
- [112] Zohreh Azizi and C-C Jay Kuo. Pager: Progressive attribute-guided extendable robust image generation. *arXiv preprint arXiv:2206.00162*, 2022.
- [113] Xuejing Lei, Wei Wang, and C-C Jay Kuo. Genhop: An image generation method based on successive subspace learning. In *2022 IEEE International Symposium on Circuits and Systems (ISCAS)*, pages 3314–3318. IEEE, 2022.