

# Convolutional and Deep Learning based techniques for Time Series Ordinal Classification

Rafael Ayllón-Gavilán, David Guijo-Rubio\*, Pedro Antonio Gutiérrez, Anthony Bagnall, César Hervás-Martínez

**Abstract**—Time Series Classification (TSC) covers the supervised learning problem where input data is provided in the form of series of values observed through repeated measurements over time, and whose objective is to predict the category to which they belong. When the class values are ordinal, classifiers that take this into account can perform better than nominal classifiers. Time Series Ordinal Classification (TSOC) is the field covering this gap, yet unexplored in the literature. There are a wide range of time series problems showing an ordered label structure, and TSC techniques that ignore the order relationship discard useful information. Hence, this paper presents a first benchmarking of TSOC methodologies, exploiting the ordering of the target labels to boost the performance of current TSC state-of-the-art. Both convolutional- and deep learning-based methodologies (among the best performing alternatives for nominal TSC) are adapted for TSOC. For the experiments, a selection of 18 ordinal problems from two well-known archives has been made. In this way, this paper contributes to the establishment of the state-of-the-art in TSOC. The results obtained by ordinal versions are found to be significantly better than current nominal TSC techniques in terms of ordinal performance metrics, outlining the importance of considering the ordering of the labels when dealing with this kind of problems.

**Index Terms**—time series machine learning, time series analysis, time series classification, ordinal classification



## 1 INTRODUCTION

A time series is an ordered sequence of values. This type of data can be found in a wide variety of domains, such as medicine [1], financial analysis [2], or agriculture [3], among others. For instance, electrocardiogram signals [4] are ordered by time and spectrograms [5] are ordered by frequency. Time Series Classification (TSC) is one of the most popular machine learning tasks, with hundreds of different approaches presented in the literature [6], [7], [8], [9]. Moreover, other time series related domains are time series clustering [10] and forecasting [11], with an increasing interest in the last years.

TSC involves predicting a discrete output variable for a given time series. Depending on the number of variables observed at each time point, time series are univariate (only one channel or dimension) or multivariate (two or more channels) [12], [13], [14]. The publication of the University of California Riverside (UCR) TSC archive [15]<sup>1</sup> allowed the development of effective methods for TSC. This archive provides an heterogeneous problem set leading to a fair

comparison of novel proposals. Recently, a large set of 33 TSC methods has been developed and tested on this archive [16]. This study showed that the latest algorithms represent a significant advance in the state of the art for TSC.

While there has been significant progress in the algorithmic development for TSC almost no attention has been paid to Time Series Ordinal Classification (TSOC). We aim to address this ansence. Some problems in the UCR archive are ordinal in nature, i. e. labels associated with samples follow an ordinal relationship among them. Up to now, these problems have been tackled by nominal TSC methods, which hinder the learning process: nominal methods generally require more data or iterations to achieve the same performance than an ordinal classifier [17].

We can define ordinal classification (also known as ordinal regression) as a classification problem where the output labels exhibit a natural ordering. This characteristic can be found in many and varied domains: finances [18], human age prediction [19], climatological applications [20] or medical research [21]. All these previous works take advantage of information related to the ordering of the categorical labels to increase the performance of the models being applied. The most prominent type of models in the literature on ordinal classification are the so-called threshold-based models. In these methodologies the existence of a real-valued variable underlying the ordinal response is assumed. Hence, the training process focuses on modelling the real variable and learning the optimal thresholds determining which intervals corresponds to each ordinal label. The Cumulative Link Model (CLM) approach belongs to this family of threshold-based models, and works with cumulative probabilities of the input belonging to a certain class or inferior classes in the ordinal scale.

An example of ordinal classification can be seen in [21],

- \*: Corresponding author.
- R. Ayllón-Gavilán, P.A. Gutiérrez and C. Hervás-Martínez are with the Dept. of Computer Science and Numerical Analysis, University of Cordoba, Spain. E-mail: {i72aygar,pagutierrez,cheruas}@uco.es.
- D. Guijo-Rubio is with both the Dept. of Computer Science and Numerical Analysis, University of Cordoba, Spain and the School of Computing Sciences, University of East Anglia, United Kingdom. E-mail: dguijo@uco.es.
- A. Bagnall is with the School of Computing Sciences, University of East Anglia, United Kingdom. E-mail: ajb@uea.ac.uk.

Manuscript received April 19, 2005; revised August 26, 2015.

<sup>1</sup><https://timeseriesclassification.com/>

where a set of patients infected with the SaRS-COV 2 coronavirus is studied and grouped into three levels of illness severity: moderate, severe, and critical. These labels follow an ordinal relationship, in that a critical patient is sicker than a moderate or a severe patient. The main characteristic of an ordinal variable, following this example, is that it is worse to misclassify a critical patient as moderate, than it is to misclassify them as severe. The magnitude of the error should be higher in the first case. As stated in [22], two types of ordinal variables are distinguished: 1) grouped continuous variables, and 2) assessed ordered categorical variables. The former is based on the existence of an underlying continuous variable, in such a way that the labels are the result of the discretisation of this variable. In the latter case, it is a domain expert who is responsible for assigning labels to the patterns, establishing the ordering at his/her own judgment. As can be seen, first group of problems are more objective than those belonging to the second group, as no influence from human opinion is included.

In this paper, our focus is on TSOC problems, which involve classifying time series data based on ordinal categories. An example dataset used for experimental validation in this study is the *DistalPhalanxOutlineAgeGroup* dataset. It is specifically designed to assess the effectiveness of detecting hand and bone outlines and determine if they can aid in predicting bone age. The dataset focuses on distal phalanges of the middle finger, and the labels correspond to different age groups: 0-6 years old, 7-12 years old, and 13-19 years old. Figure 1 illustrates three patterns from each of the classes, showcasing the observable ordinality of the labels in certain parts of the time series.

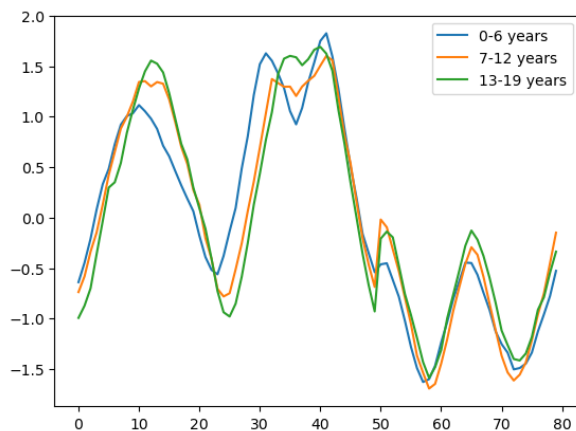

Figure 1: Example of time series extracted from the *DistalPhalanxOAG* dataset. The target ordinal scale represents different age ranges and the time series are the outlines of the middle finger.

Our contributions can be listed as follows: 1) the introduction of five novel TSOC techniques, focusing on the state-of-the-art approaches in TSC. 2) The identification of 18 ordinal time series problems from different data sources. 3) A benchmarking study of all these five techniques over the whole set of 18 ordinal datasets, comparing them against both similar nominal TSC approaches and standard Machine Learning (ML) approaches. The results demonstrate that TSOC techniques significantly enhance existing state-

of-the-art nominal TSC methods in ordinal problems. And finally, 4) contributing to the literature with the first baseline study for TSOC, which aims to encourage time series community for further enhancement in this novel field.

The remainder of this paper is organised as follows: related works are described in Section 2; Section 3 formalises preliminary definitions needed to present the different proposals; Section 4 defines the proposed TSOC methods; Section 5 specifies the experimental setup and the datasets considered; finally, in Section 6, we provide the conclusions and future research of our work.

## 2 RELATED WORKS

This Section revises the literature of the two main areas involved in this work: Time Series Classification (TSC) and Ordinal Classification.

### 2.1 Time Series Classification (TSC)

A range of TSC methodologies have been developed in recent years. The first taxonomy grouping these approaches by their typology was proposed in [6], and extended in [16]. In the following, we provide a summarised, yet updated, version of the main categories of this taxonomy:

*Distance-based* techniques: algorithms belonging to this group aim to estimate the class of a time series using the well-known  $k$ -Nearest Neighbours ( $k$ NN) combined with a distance measure. The most common distance measures are the Euclidean Distance (ED) and the Dynamic Time Warping (DTW) [23]. A more recent proposal was the Elastic Ensemble (EE), introduced in [24], in which the classification is performed according to a combination of several distance measures. More recent approaches, such as Proximity Forest [25], achieve a faster training time than previous techniques as well as a superior accuracy. A second version of this algorithm called Proximity Forest 2.0 (PF2) [26] has been recently developed. PF2 significantly outperforms previous distance-based techniques, introducing a novel distance metric called Amerced Dynamic Time Warping and implementing early stopping and pruning methods to speed up similarity computations.

*Interval-based* techniques: the aim of the interval-based approaches is to extract significant phase dependent features from the time series. Methods belonging to this group are generally based on the random forest algorithm. The first approach presented in this group was the Time Series Forest (TSF) [27], which is similar to the traditional Random Forest, but each decision tree is trained with different features extracted from intervals sampled from the time series. This approach has been lately improved in the Canonical Interval Forest (CIF) [28] approach, in which the feature extraction process is extended with the so-called catch22 algorithm [29], which computes 22 relevant time series features. In the same line, a Supervised TSF (STSF) algorithm was proposed in [30]. STSF reduces the input space to a set of subseries, which are selected through a top-down process employing feature ranking metrics. The results in terms of accuracy are comparable to state-of-the-art techniques, while being way less computationally

expensive. Finally, the HIVE-COTE2 (HC2) ensemble introduced Diverse representation CIF (DrCIF) [31], an improved version of the CIF proposal that employs the diverse representation strategy, which trains each classifier in the ensemble with different time series intervals and different feature subsets. Currently, DrCIF is the state-of-the-art interval-based approach.

*Shapelet-based techniques:* this family of models focuses on finding short phase independent patterns in the time series, called shapelets. Shapelet Transform (ST) [32] is the main algorithm in this group. ST transforms the time series dataset into a distance matrix in which cells represent distances between shapelets and the original time series. This distance information is used to make predictions on new input time series. In this line, we find the current state-of-the-art of shapelet-based techniques, which is the Random Dilated Shapelet Transform (RDST) [33]. This method uses randomly dilated shapelets to improve both in accuracy and training time over the other shapelet-based techniques.

*Dictionary-based techniques:* this type of models constructs a histogram with the frequency of occurrence of sub-series within a time series. The first method developed was the Bag of Symbolic-Fourier Approximation Symbols (BOSS) [34], which builds a symbolic representation called bag-of-words, used to compute distance measurements between different time series. This approach has been later extended in the Word ExtrAction for time SEries cLassification (WEASEL) [35] method, in which an ANalysis Of VAriance (ANOVA) test is used to build a more significant bag-of-words from each time series. In this line, the Temporal Dictionary Ensemble (TDE) method was presented in [36]. Similarly to BOSS and WEASEL, TDE replaces the bag-of-word extraction algorithm by a more efficient approach based on the introduction of decision trees thresholds to compute the word representation of the time series. Finally, the novel version of the WEASEL algorithm (WEASEL 2.0) [37] is the current state-of-the-art of dictionary-based classifiers, it combines time series dilation with random hyper-parameters search to build both an scalable and accurate technique.

*Convolutional-based techniques:* this family of methods tries to extract features from the input time series by applying a set of convolutional kernels. The RandOm Convolutional KErnel Transform (ROCKET) method [38] was the first approach in this group of algorithms. It consists in training a Ridge regressor with features extracted from the application of the kernels to the time series. In addition, two enhanced versions of this method have also been presented to the literature: MiniROCKET [39], which proposes a computationally lighter kernel extraction process while maintaining a high accuracy, and MultiROCKET [40], which extends the kernel extraction by applying it to the first order difference of the time series and performing more pooling operators. MultiROCKET is significantly better than MiniROCKET in accuracy, but it is computationally more expensive. A recently established method in the literature is the HYbrid Dictionary-Rocket Architecture (HYDRA) [41].

HYDRA is a combination of dictionary and convolutional techniques that achieves a highly competitive performance in comparison with existing approaches. HYDRA can be used in combination with any ROCKET-based methodology. In the current state-of-the-art, MultiROCKET combined with HYDRA (HYDRA+MultiROCKET) stands as the best TSC methodology when accounting for both accuracy and training time.

*Deep Learning-based (DL) models:* DL has also been exploited for TSC, matching or eventually increasing the performance of current state-of-the-art techniques. The best methodology belonging to this group is InceptionTime [42], an ensemble of 5 Inception Networks, which, as other proposals like ResNet [43], is based on residual networks. Other InceptionTime-based methodologies are found in the literature, such as InceptionFCN, which combines the Fully Connected Network (FCN) with the InceptionTime architecture [44]. The last proposal in this field has been made in [45], which employs hand-crafted filters in the convolutional layers of the network. This helps to reduce the training time and to focus on the extraction of specific features of the time series like increase, decrease or peaks, among others.

*Hybrid methods:* Hybrid techniques refer to those methods that combine many of the methodologies explained above. They focus on capturing more sources of possible discriminatory features in time series. The two versions of the Hierarchy of Transformation-based Ensembles (HIVE-COTE, or HC for simplicity) [46] are the most representative methods of this group. The first version combines five different approaches: the EE (distance-based), a Shapelet-based ensemble, the BOSS (dictionary-based), and the TSF and RIF-ACF (both interval-based). The second version, which is the state-of-the-art approach, not only regarding this group but also considering all TSC techniques, is the HC2 [31], an improved version of the HC recently developed. Specifically, HC2 combines four approaches from different domains: convolutional-based (Arsenal, an ensemble of ROCKET models), interval-based (DrCIF), dictionary-based (TDE) and shapelet-based (ST). Another model proposed following the same concept is the Time Series Combination of Heterogeneous and Integrated Embedding Forest (TS-CHIEF) [47], which achieves a competitive performance using tree-structured classifiers to do so efficiently.

This variety of algorithms has pushed the TSC field to new limits and conforms the current overview. However, the performance for ordinal problems included in the archives could be significantly improved using appropriate approaches. Following, we specifically focus on ordinal classifiers.

## 2.2 Ordinal classification

Over the last few years, several ordinal classification techniques based on nominal methodologies have been developed to exploit ordinality in the training process. In [48], a novel learning algorithm based on large margin rank boundaries was proposed for ordinal classification

tasks, and the result can be seen as an adaptation of the Support Vector Machine (SVM) algorithm to ordinal problems. Subsequently, methods such as Support Vector Ordinal Regression with Explicit Constraints (SVOREX) or SVOR with Implicit Constraints (SVORIM) [49] have been proposed. Both methods are ordinal SVMs but with different constraints definition criteria in the optimisation process. In the same way, an extended kernel discriminant learning [50] algorithm has been proposed to work as an ordinal classifier by using a ranking constraint. This method is known as Kernel Discriminant Learning for Ordinal Regression (KDLOR) and has been proposed as an alternative to the ordinal SVM methods mentioned above. The key difference between these approaches is that SVOR methods do not take advantage of the global information of the data (especially SVOREX as only considers adjacent classes when determining the thresholds) and also suffers from higher computational complexity.

Other approaches to ordinal classification, such as [51], rely on Gaussian Processes (GP) to develop an ordinal regressor: GP for Ordinal Regression (GPOR). The performance of this new method has been compared against SVORs techniques in several datasets, and the results showed a good generalisation capacity and competitive performance. Furthermore, inspired by this approach and previous SVOR methods, Srijith et al. in [52] have proposed a sparse GPOR using Leave-One-Out cross-validation to perform model selection (LOO-GPOR), a probabilistic least squares ordinal regressor (PLSOR) [53] and a semi-supervised ordinal regressor using GP [54].

Deep learning for ordinal classification problems is an area that has been less explored up to now, with some works such as [55] or [56], which studied the application of a new output layer based on Cumulative Link Models (CLMs) together with a Quadratic Weighted Kappa (QWK) loss function. This approach has been proposed for tackling ordinal image classification problems, for which excellent results are achieved in comparison to nominal approaches. A recent work [57] has taken this idea to approach the field of Aesthetic Quality Control (AQC), developing a DL architecture with CLM as the output layer and cross-entropy as the cost function. The results have demonstrated the capacity of the network to take advantage of the ordinal nature of AQC problems, improving performance over previous nominal approximations.

At this point, once both main fields tackled in this work have been introduced, Time Series Ordinal Classification (TSOC) can be defined. TSOC consists in the application of ordinal classifiers to ordinal time series problems, in such a way that the ordinal classifiers are able to consider and exploit the ordinal information present in the label space. TSOC is a recently established field only covered by a small set of conference papers [58], [59], [60]. The first two works have proposed an ordinal shapelet transformer in which the ordinal information of the data is exploited in two ways: 1) by introducing a novel shapelet quality measure in which ordinal information is taken into account, and 2) by using an ordinal classifier instead of a nominal one, specifically the Proportional Odds Model (POM) [61] and SVORIM [49] have been tested as final classifiers. Results have demonstrated that ordinal approaches significantly

outperform nominal TSC approaches. Later, in [60], the effect of using different  $L_p$  norms for the computation of the shapelet quality has been studied, concluding that the best  $p$ -norm value is  $p = 1.9$  for the proposed experiments. As can be seen, TSOC has room for significant improvement.

### 3 PRELIMINARY DEFINITIONS

In this section, a formal definition of the concepts related to TSOC is provided, including time series and ordinal classification. Moreover, we also define a family of probabilistic ordinal classifiers (Cumulative Link Models, CLMs), which will be used for the TSOC methods proposed in this paper.

#### 3.1 Time series and related supervised learning problems

In supervised learning time series problems, we are provided a training dataset including a set of labeled time series,  $D = \{(\mathbf{t}_1, y_1), (\mathbf{t}_2, y_2), \dots, (\mathbf{t}_N, y_N)\}$ , where  $N$  is the number of available time series,  $\mathbf{t}_i$  is the  $i$ -th time series,  $y_i$  is the label assigned to it, and  $i \in \{1, \dots, N\}$ . In general, the objective is to learn a mapping function (model) able to accurately predict the labels for the time series of the test set. Every time series is a set of  $C$  ordered sets (also known as channels or dimensions) of real values. Although the most common type of time series are univariate ( $C = 1$ ), there is an increasing interest in multivariate time series ( $C > 1$ ). A multivariate time series with  $C$  channels is defined as  $\mathbf{t}_i = (\mathbf{t}_i^1, \dots, \mathbf{t}_i^C)$ , where the  $c$ -th channel is denoted as  $\mathbf{t}_i^c = (t_{i,1}^c, t_{i,2}^c, \dots, t_{i,T}^c)$ ,  $c \in \{1, \dots, C\}$ , and  $T$  is the length of the time series. In this paper, we focus on time series with a constant spacing of observation times, in contrast to unevenly spaced time series, and we consider datasets where all the time series are equal-length.

Depending on the nature of the labels, the supervised time series problems can be categorised in Time Series Extrinsic Regression (TSER) [62], nominal Time Series Classification (TSC) [16] or Time Series Ordinal Classification (TSOC). TSER covers those problems where the label to be predicted is a real number, i.e.  $y_i \in \mathbb{R}$ . For TSC, the label of each time series takes values in a discrete set of categories,  $y_i \in \{C_1, C_2, \dots, C_q, \dots, C_Q\}$ , where  $q \in \{1, \dots, Q\}$ , and  $Q$  is the number of classes of the problem. Finally, TSOC problems are TSC problems (with more than two classes) which include an order constraint in the labels.

#### 3.2 Time series ordinal classification (TSOC)

The focus of this paper is TSOC, where the categories show a natural order, in such a way that a relation  $C_1 \prec C_2 \prec \dots \prec C_Q$  is present in label space. This relation is also present in TSER problems, where the  $\prec$  operator is directly  $<$  because we are working with real numbers instead of categories. However, the difference between TSOC and TSER is that the distance between categories is not known.

To provide a deeper understanding of this sort of problems, let us consider the example depicted in Figure 1. In this case, the classification problem involves determining the age ranges using the outlines of the middle finger. The ranges exhibit a natural relationship and can be categorised

into three levels: 0-6 years old, 7-12 years old, and 13-19 years old.

TSOC problems involve two important characteristics: 1) misclassification costs are different depending on the error (an error confusing the classes 0-6 years old and 13-19 years old should be more penalised than one confusing the classes 0-6 years old and 7-12 years old); and 2) including the order information during learning should boost convergence.

### 3.2.1 Cumulative Link Models

CLM belong to a broad family of models known as threshold-based models, which are built on two main ideas: 1) The existence of a real variable underlying the (discrete) output response, such that each class  $\mathcal{C}_q$  belongs to a certain interval in  $\mathbb{R}$ . This hidden variable will be denoted as  $y^*$  and is often referred to in the literature as *latent variable*. 2) The use of a function  $f$  that transforms a pattern of the input space  $\mathbf{x} \in \mathbf{X} \subset \mathbb{R}^D$  (where  $D$  is the input dimensionality) into the one-dimensional real space corresponding to the latent variable,  $f : \mathbf{x} \in \mathbf{X} \subset \mathbb{R}^D \rightarrow \mathbb{R}$ . The aim is to segment the real line into  $Q$  consecutive non-overlapping ordered intervals, so that each one is mapped to a certain label  $\mathcal{C}_q$ . The values defining those intervals are represented by the vector  $\boldsymbol{\theta} = (\theta_1, \dots, \theta_{Q-1})$ , where  $\boldsymbol{\theta} \in \mathbb{R}^{Q-1}$ , which is called the threshold vector and satisfies  $\theta_1 \leq \theta_2 \leq \dots \leq \theta_{Q-1}$ . Considering this setting, a given output class  $\mathcal{C}_q$  will be observed for a certain input  $\mathbf{x}_i$ , if  $f(\mathbf{x}_i) \in [\theta_{q-1}, \theta_q]$ . For the sake of simplicity,  $\theta_0$  and  $\theta_Q$  are set to  $-\infty$  and  $+\infty$  respectively, and are considered to be outside the vector  $\boldsymbol{\theta}$ .

In view of the foregoing, the special case of CLM consider the latent variable model:  $y^* = f(\mathbf{x}) + \epsilon$ , where  $\epsilon$  is the random error component with zero expectation, for which a certain distribution  $F_\epsilon$  is assumed. Moreover, it assumes a linear latent variable  $f(\mathbf{x}) = \mathbf{w}^T \mathbf{x}$ . On that account, it is satisfied that:

$$\begin{aligned} P(y \preceq \mathcal{C}_q | \mathbf{x}) &= P(y^* \leq \theta_q) \\ &= P(\mathbf{w}^T \mathbf{x} + \epsilon \leq \theta_q) \\ &= P(\epsilon \leq \theta_q - \mathbf{w}^T \mathbf{x}), \end{aligned} \quad (1)$$

taking  $g$  as the probability distribution function (p.d.f) of the assumed  $F_\epsilon$ , we get to:

$$g(\theta_q - \mathbf{w}^T \mathbf{x}) = P(y \preceq \mathcal{C}_q | \mathbf{x}). \quad (2)$$

Therefore, the learning objective of the CLM is to find the set of optimal thresholds  $\boldsymbol{\theta}^*$ , as well as the optimal parameters  $\mathbf{w}^*$  of the function  $f$ , in such a way that, given a pattern of the test set  $(\mathbf{x}_i, y_i)$ , the cumulative probabilities for each class  $\mathcal{C}_q$ , i.e.  $P(y_i \preceq \mathcal{C}_q | \mathbf{x}_i)$ , are as close as possible to the observed ones.

To this end, we need to define a loss function  $\ell$  that represents the disagreement between the target label assigned to an input  $\mathbf{x}_i$  and the output given by a prediction function  $\text{pred}(\mathbf{p}_i)$ , where  $\mathbf{p}_i = (p_{i_1}, p_{i_2}, \dots, p_{i_Q})$  is the vector of predicted probabilities, where  $p_{i_q} = P(y_i = \mathcal{C}_q | \mathbf{x}_i) = P(y_i \preceq \mathcal{C}_q | \mathbf{x}_i) - P(y_i \preceq \mathcal{C}_{q-1} | \mathbf{x}_i)$ . Hence, our objective is to find the function  $\text{pred}$  that minimises the expected risk:

$$\mathcal{L}(\text{pred}) = E(\ell(y_i, \text{pred}(\mathbf{p}_i))),$$

where  $\mathcal{L}$  is the risk function and  $E$  represent the expected value. There are different options for the expected risk

within the context of ordinal regression (e.g. the absolute difference in number of categories between the predicted and true labels). However, we cannot deal directly with this expected risk, mainly for two reasons: 1) the probability distribution that generates the patterns  $(\mathbf{x}_i, y_i)$  of a dataset  $D$  is usually unknown; 2) the function  $\ell$  is naturally discontinuous since its two arguments belong to the discrete space defined by the output  $y$ . This, as stated in [63], can lead to an NP-hard problem. Therefore, the common practice is to approximate  $\ell$  by the so called *surrogate risk*, which, considering the CLM setting, can be defined as:

$$\mathcal{A}(f) = E(\psi(\boldsymbol{\theta}, f(\mathbf{x}))),$$

where  $\psi : \mathbb{R}^{Q-1} \times \mathbb{R} \rightarrow \mathbb{R}$  is generally referred to as the *surrogate loss* function. The need to introduce this surrogate terms is the main motivation for the existence of the previously introduced latent variable. As the values of  $y^*$  are not a priori known, we work with the vector  $\boldsymbol{\theta}$ , so that, for a pair  $(\mathbf{x}_i, y_i)$ , where  $y_i$  takes a value  $\mathcal{C}_q$ , we want the output of  $f(\mathbf{x}_i)$  to be as close as possible to the  $\theta_q$  threshold. To ensure the ordering of  $\boldsymbol{\theta}$  introduced above, we essentially have two options, one is to generate its elements through an incremental function, as for example, the one used in the CLM activation layer (see Section 3.2.3). The other option is to design the cost function in such a way that it converges to a point where this ordering is assured, this is the case of the Logistic All-Threshold [63] method being used in our work.

### 3.2.2 Logistic All-Threshold (LogisticAT)

The LogisticAT method is a special case of CLM where the considered  $F_\epsilon$  distribution is the logistic function. This leads to an interesting property that characterises the so-called proportional odds models (POM). This property states that the ratio of the odds for two patterns inputs  $\mathbf{x}_1, \mathbf{x}_2$  is proportional [64]:

$$\frac{\text{odds}(y \preceq \mathcal{C}_q | \mathbf{x}_1)}{\text{odds}(y \preceq \mathcal{C}_q | \mathbf{x}_2)} = \exp(-\mathbf{w}^T (\mathbf{x}_2 - \mathbf{x}_1)).$$

The main distinguishing feature of LogisticAT with respect to the POM is its (*surrogate*) loss function, which is presented below:

$$\begin{aligned} \psi_{\text{AT}} &= \sum_{i=1}^N \left( \sum_{q=1}^{y_i-1} h(\theta_q - \mathbf{w}^T \mathbf{x}_i) + \sum_{q=y_i}^Q h(\mathbf{w}^T \mathbf{x}_i - \theta_q) \right) + \\ &\quad \frac{\lambda}{2} \mathbf{w}^T \mathbf{w}, \end{aligned} \quad (3)$$

where  $(\mathbf{x}_i, y_i)$  is a pattern of the training set,  $h : \mathbb{R} \rightarrow \mathbb{R}$ ,  $h(z) = \log(1 + \exp(z))$ ,  $\mathbf{w}$  is the parameter of the function  $f(\mathbf{x}) = \mathbf{w}^T \mathbf{x}$  presented above, and  $\lambda$  is the regularization term, which is adjusted by cross-validation in our experiments (see Section 5). Observe that in  $\psi_{\text{AT}}$ , by taking into account all the thresholds in  $\boldsymbol{\theta}$  for each input  $(\mathbf{x}_i, y_i)$ , we ensure that at the point of convergence the ordering of  $\boldsymbol{\theta}$  is satisfied.

This model is used for the ordinal convolutional-based techniques (O-ROCKET, O-Mini-Rocket and O-MultiROCKET) discussed in Section 4.1.

### 3.2.3 CLM Activation Layer

The previously described mathematical structure of the cumulative link models can be utilised as link function in deep learning architectures [55]. On this wise, the one dimensional output of a deep network is mapped to a set of predicted probabilities through a CLM, for which we considered (as in the case of the LogisticAT method) a logistic distribution for the error component  $\epsilon$ . In order to ensure the ordering of the vector  $\theta$ , the next definition is considered:  $\theta_q = \theta_1 + \sum_{i=1}^{q-1} \alpha_i^2$ , with  $q \in \{2, \dots, Q-1\}$ , then  $\theta_1$  and  $\alpha_2, \dots, \alpha_{Q-1}$  can be learnt without constraints.

In addition, a cost function that takes greater account of ordinality is considered [65]. This function, denoted as  $\psi_{\text{QWK}}$ , is based in the Quadratic Weighted Kappa (QWK) metric, and it is defined in terms of the predicted probabilities:

$$\psi_{\text{QWK}} = \frac{\sum_{i=1}^N \sum_{q=1}^Q \omega_{y_i, q} P(y = C_q | \mathbf{x}_i)}{\sum_{q=1}^Q \frac{N_q}{N} \sum_{j=1}^Q (\omega_{j, q} \sum_{i=1}^N P(y = C_j | \mathbf{x}_i))},$$

where  $\psi_{\text{QWK}} \in [0, 2]$ ,  $(\mathbf{x}_i, y_i)$  is the  $i$ -th sample of the data,  $N_q$  is the number of patterns labeled with the  $q$ -th class, and  $\omega_{j, q}$  are the elements of the penalization matrix, where  $\omega_{j, q} = \frac{(j-q)^2}{(Q-1)^2}$ .

This setting is implemented in the ordinal deep learning methodologies (O-ResNet and O-InceptionTime) discussed in Section 4.2.

## 4 PROPOSED TSOC METHODS

In this Section, we present the TSOC methodologies proposed according to the category they belong.

### 4.1 Convolutional-based techniques

This family of TSC algorithms was opened in [38] with the development of the ROCKET method for TSC. The main idea is to extract features from the input time series by applying a set of convolutional kernels. This convolution process involves a sliding dot product that depends on the properties of the kernel being applied, which are: the values of the kernels or weights ( $w$ ), the length ( $n$ ), which sets the kernel extension (or number of weights); dilation ( $d$ ), that spreads the kernel over the time series so that higher values of dilation help to more easily capture long-term patterns in the series [66]; padding ( $p$ ), which adds to the beginning and end of the series a vector filled with zeros to control where the middle weight of the first and last kernel to be applied falls; and bias ( $b$ ), a real value that is added to the kernel convolution result.

In addition to the original version of ROCKET, the authors presented two improved versions: MiniROCKET and MultiROCKET. All of them have the same architecture, shown in Figure 2, in which we can distinguish four sequentially applied phases: 1) a kernel convolution transform, 2) a set of pooling operations, 3) a standard scaler, and 4) a final classifier.

In this work, we propose the use of the LogisticAT method introduced in Section 3.2.1 as final classifier, with a built-in crossvalidation of the  $\lambda$  regularization parameter.

With respect to the standardization process and the final classifier, both remain unchanged. Conversely, the first two phases (kernel convolution and pooling operations), are different for each of the three alternatives. A comparison between the configuration of the three methods is presented in Table 1.

#### 4.1.1 O-ROCKET

ROCKET was a significant contribution to the state-of-the-art in TSC, as it was capable of achieving an excellent performance in a fraction of computational time. ROCKET applies to the input time series a large set of kernels generated with random properties: length  $n$  is randomly sampled from  $\{7, 9, 11\}$  with equal probability; weights  $w$  are sampled from a normal distribution,  $w_k \sim \mathcal{N}(0, 1)$ ; bias  $b$  is sampled from a uniform distribution,  $b \sim \mathcal{U}(-1, 1)$ ; dilation  $d = 2^x$ ,  $x \sim \mathcal{U}(0, A)$ ,  $A = \log_2 \frac{T-1}{n-1}$  where  $T$  denotes the time series length, and  $n$  the kernel length; and padding, which is denoted by  $p$  and is applied or not with the same probability in each kernel. In the case it is applied, its value is computed with  $p = (n-1) * d$ .

Once the kernel convolution is finished, two real-valued features are extracted from each kernel, one being the result of a Global Max Pooling (GMP), which consists in taking the highest value, and the second being the Proportion of Positives Values (PPV), being  $\text{PPV} = \frac{1}{n} \sum_{i=0}^{n-1} [z_i > 0]$ , where  $z_i$  is the output of a single kernel convolution. Hence, PPV is a real value ranging from zero to one that represent the percentage of kernel convolutions that are greater than zero. These extracted features are then fed as input to the LogisticAT classifier.

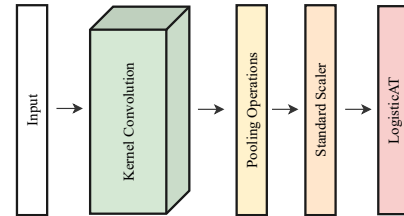

Figure 2: Generalised ordinal convolutional-based methods architecture. The final set of features obtained from the kernel convolution and pooling operations is standardised and then fed to a LogisticAT classifier, which produces the final output.

#### 4.1.2 O-MiniROCKET

MiniROCKET [39] is a later version of ROCKET which is up to 75 times faster than the original version, achieving similar performances. The main novelties with respect to ROCKET are:

- The kernel length  $n$  is set to a fixed value of 9.
- Kernel weights  $w$  are restricted to two possible values,  $-1$  and  $2$ .
- A fixed dilation  $d$  is computed according to the input length. The  $d$  value can be in  $\{2^0, \dots, 2^a\}$ , where  $a = \log_2(T-1)/(n-1)$ .
- Padding  $p$  is applied or not alternatively for each kernel/dilation combination. This way, half of the



kernels are computed with padding and the other half not. Whenever applied, its value is computed in the same way as in the O-ROCKET method.

- Only the PPV aggregated feature is computed for each kernel.

With these changes, MiniROCKET becomes mostly (sometimes fully) deterministic, achieving both better accuracy and lower training time than comparable methodologies, such as its predecessor, ROCKET, InceptionTime [42], dictionary-based methods like Temporal Dictionary Ensemble (TDE) [36] or tree-based techniques as the Canonical Interval Forest (CIF) [28].

#### 4.1.3 O-MultiROCKET

This is the last version of the ROCKET family. In this novel variant, known as MultiROCKET [40], two main adjustments are made to MiniROCKET: 1) the convolution is also done on the first order difference of the time series; and 2) three additional aggregated features are computed: the Mean Positives Values (MPV), Mean of Indices of Positives Values (MIPV) and the Longest Stretch of Positive Values (LSPV).

These modifications substantially increase the computational expense of the algorithm but in turn achieves a significant increase in terms of accuracy.

	O-ROCKET	O-MiniROCKET	O-MultiROCKET
Kernel length	{7, 9, 11}	{9}	{9}
Weights	$\mathcal{N}(0, 1)$	{-1, 2}	{-1, 2}
Dilation	$\mathcal{U}(-1, 1)$	$\{2^0, \dots, 2^a\}$	$\{2^0, \dots, 2^a\}$
Use of Padding	random	alternative	alternative
Pooling operations	[PPV, GMP]	[PPV]	[PPV, GMP, MPV, MIPV, LSPV]
Num. Features	20,000	10,000	50,000

Table 1: Differences between O-ROCKET, O-MiniROCKET and O-MultiROCKET methodologies.

## 4.2 Deep Learning techniques

We propose two types of deep learning architectures: the Ordinal ResNet (O-ResNet) methodology based on the residual network architecture [43], and the Ordinal InceptionTime (O-InceptionTime) methodology based on the InceptionTime architecture [42].

#### 4.2.1 O-ResNet

The original residual architecture was proposed in [67]. The main idea behind this sort of architectures is to add shortcut connections between non-adjacent layers, which facilitates the flow of the gradient through the network. This work was extended to the TSC paradigm in [43], in which the input time series is passed sequentially through a set of three residually connected convolutional blocks, which, for ease of understanding, are referred to as super-blocks (SBlocks). The reason for this notation is given by the fact that each super-block  $\text{SBlock}_k$  is composed of three simple convolutional blocks with  $k$  filters each. In Figure 3, we refer to this fact with the  $x3$  notation. In each  $\text{SBlock}_k$ , the convolution result is added to the original time series, and finally, a

Batch Normalization layer (BN) and a Rectified Linear Unit (ReLU) activation layer are applied. In our proposal, after the concatenated three SBlocks convolution, the final output of the network is obtained by applying a Global Average Pooling (GAP) layer followed by a CLM activation layer (see Figure 3). The complete O-ResNet convolution pipeline is given by:

$$\begin{aligned}
 h_{i_1} &= \text{SBlock}_{64}(\mathbf{x}_i), \\
 h_{i_2} &= \text{SBlock}_{128}(h_{i_1}), \\
 h_{i_3} &= \text{SBlock}_{128}(h_{i_2}), \\
 h_{i_4} &= \text{GAP}(h_{i_3}), \\
 \mathbf{p}_i &= \text{CLM}(h_{i_4}),
 \end{aligned} \tag{4}$$

where  $\mathbf{p}_i$  is the final output of the network, i. e. the set of predicted probabilities.

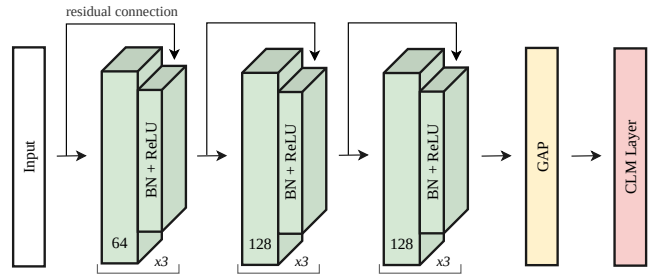

Figure 3: O-ResNet architecture. The notation  $x3$  means that we have 3 stacked convolutional blocks inside each residual block. The final activation layer is the CLM (see Section 3.2.1).

#### 4.2.2 O-InceptionTime

The O-InceptionTime architecture takes some of the main ideas of the ResNet architecture and the original InceptionTime methodology [42], which includes concatenated convolution blocks together with residual connections between them. This method itself is an ensemble of 5 O-Inception Networks (O-IN). An O-IN comprises two residual blocks, each consisting of three Inception Modules (IMs) that remain unchanged from the initial InceptionTime proposal (see Figure 4). O-IN applies a dimensionality reduction layer known as bottleneck, whose main goals are reducing the model complexity and avoiding overfitting. The convolution operation of a bottleneck layer consists in sliding  $m$  filters of length 1 with a stride equal to 1. Figure 5 presents the O-IN architecture.

Specifically, an O-IN is composed of two residual blocks, each with 3 IMs. A GAP layer is applied to the output of the second block. Finally, the resulting features are fed to a fully connected layer, and finally, to the CLM activation layer.

As mentioned above, O-InceptionTime consists of 5 O-INS initialised with random weights, where the final prediction is performed by a majority voting system. This ensemble is built with the purpose of reducing the variability inherent to the ResNet architectures [68].

## 5 EXPERIMENTAL SETTINGS AND RESULTS

This Section firstly introduces the naïve methods used for comparison together with the datasets considered in the ex-

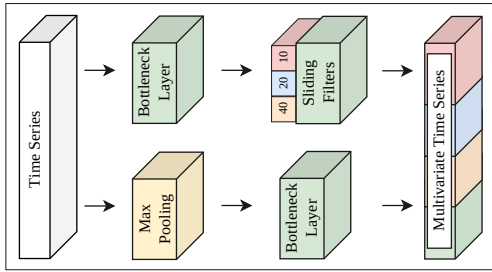

Figure 4: InceptionTime Module architecture. Two pipelines are applied in parallel to the input time series. On the first one, the bottleneck layer is applied, followed by 3 sliding filter operations with sizes 40, 20 and 10, respectively. On the second one, a Max Pooling is performed, followed by another bottleneck layer. The result is a multivariate 4-channels time series.

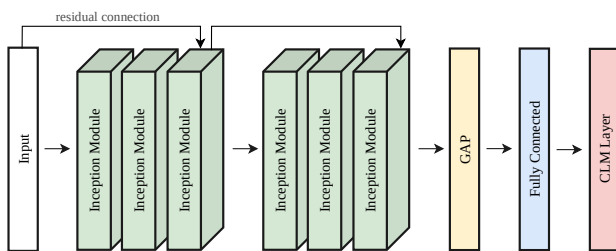

Figure 5: O-Inception Network architecture, two blocks of three IMs with residual connections are stacked, the resulting multivariate time series is passed to a GAP layer, followed by a fully connected and a CLM activation layer.

periments. Then, it analyses the developed ordinal methodologies and presents the ordinal performance metrics. The section finishes by benchmarking all the methods compared. Note that we provide open source `scikit-learn`-compatible implementations of all the methods benchmarked, a guide on how to reproduce experiments, and all the results obtained in an associated website<sup>2</sup>. All ordinal approaches will be available in the `aeon` toolkit<sup>3</sup>, which has also been used for benchmarking and analysing the results obtained.

## 5.1 Naïve methodologies

In order to to better understand how the proposed TSOC techniques perform, three baseline approaches have been run as a sanity check. The first two are a logistic regression [69] (LogReg) and a Extreme Gradient Boosting (XGBoost) [70] classifier. For these, time series are flattened into a vector concatenating all the channels. Thus, a multivariate time series with  $C$  channels and length  $T$  is transformed into a single vector of length  $C \times T$ . The third baseline method is the Time Series Forest (TSF) [27]. As explained above, these techniques are considered to enrich the experimentation, since they have been proven to be competitive in a wide range of problems.

<sup>2</sup><https://uco.es/ayrna/grupos/tsoc-dl-conv>

<sup>3</sup><https://github.com/aeon-toolkit/aeon/>

## 5.2 TSOC Datasets

Given that we are covering the TSOC paradigm, all of the datasets considered must ordinal in nature. To this end, we made a dataset selection from two time series repositories, the UCR TSC archive<sup>4</sup>, and the Monash TSER archive<sup>5</sup>. For the UCR TSC repository, we analysed the output variable of each problem to select those with an ordinal nature. We have identified seven univariate, and two multivariate datasets. Moreover, we have chosen two additional datasets from the TSER archive. Given that it is a regression repository, we have discretised the original continuous output variable, grouping it into five uniformly distributed bins. Even though there are more regression datasets, we could only select these two as it is difficult to achieve a reasonable class distribution for the rest (the output values are too close to obtain more than three representative classes). Furthermore, the datasets with unequal length time series and missing values are also discarded.

Other five TSOC problems built from historical price data from five of the most important companies in the stock market are considered: Apple (AAPL), Amazon (AMZN), Google (GOOG), META and Microsoft (MSFT). The data has been collected from Yahoo Finance<sup>6</sup> website, extracting weekly price data from each stock earliest available date to March 2023. The time series of each stock data are formed by its price returns over 53 weeks (around one year) before a varying date  $t$ . The output ordinal label corresponds to the price return in  $t$ . This value is discretised according to a set of predefined symmetrical thresholds  $(-\infty, -0.05, -0.02, 0.02, 0.05, \infty)$ . Finally, two more TSOC problems were built from data collected from the National Data Buoy Center (NDBC)<sup>7</sup>. Input multivariate time series are seven climatological variables collected from a reanalysis model, as detailed in [71]. Some of these variables are the air temperature, the pressure, or the relative humidity. Each time series comprises four values per day during four weeks, i.e. the length of the time series is 112. The output label indicates the energy fluctuation level during the data collection period, with 0 being the minimum and 3 the highest level. The second problem also comprises multivariate time series. Same seven climatological variables are considered for this problem. This time, the length of the time series is 28, as collects values during only one week (four values per day). The purpose is to estimate the wave height level during that period of time, from 0 (the lowest height) to 3 (the highest height). Note that the outputs of both datasets have been discretised in bins with identical widths.

## 5.3 Experimental settings

All methodologies detailed in Section 3 together with the naïve approaches have been applied to the datasets shown in Table 2. Each dataset has a default train/test partition. Given the stochastic nature of the methodologies and to avoid overfitting the training data of the default partition, every experiment is repeated 30 times. Specifically, the first

<sup>4</sup><https://timeseriesclassification.com>

<sup>5</sup><http://tseregression.org/>

<sup>6</sup><https://es.finance.yahoo.com/>

<sup>7</sup><https://www.ndbc.noaa.gov/>



	Dataset	#Train	#Test	$Q$	$T$	$C$
TSC	AtrialFibrillation	15	15	3	640	2
	DistalPhalanxOAG	400	139	3	80	1
	DistalPhalanxTW	400	139	6	80	1
	EthanolConcentration	261	263	4	1751	3
	EthanolLevel	504	500	4	1751	1
	MiddlePhalanxOAG	400	154	3	80	1
	MiddlePhalanxTW	399	154	6	80	1
	ProximalPhalanxOAG	400	205	3	80	1
	ProximalPhalanxTW	400	205	6	80	1
TSER	AppliancesEnergy	95	42	5	144	24
	Covid3Month	140	61	5	84	1
new TSOc	AAPL	1720	431	5	53	1
	AMZN	1035	259	5	53	1
	GOOG	732	183	5	53	1
	META	408	103	5	53	1
	MSFT	1501	376	5	53	1
	USASouthwestEnergyFlux	327	141	4	112	7
	USASouthwestSWH	1310	562	4	28	7

Table 2: Characteristics of the datasets used in this work. #Train stands for the number of training patterns, #Test that of the test set,  $Q$  the number of classes,  $T$  for the time series length, and  $C$  is the number of channels/dimensions.

experiment is carried out with the default partition. Subsequent experiments are performed with stratified resamples of the original datasets, keeping the same train/test proportion as the original. We have to crossvalidate only one hyperparameter in our experiments,  $\lambda$ , which is the regularisation term of the LogisticAT classifier used in the ordinal convolutional-based methodologies. The set of  $\lambda$  values to be tested are obtained according to  $10^{-3+\frac{6i}{9}}$ , where  $i \in \{0, 1, \dots, 9\}$ . A 5-fold stratified crossvalidation approach is used. The best  $\lambda$  value is selected by MAE, defined in Equation (6), as it best represents the performance of ordinal approaches.

As this work deals with ordinal classification, specific ordinal metrics should be considered. Concretely, MAE, 1-Off accuracy (1-OFF) and Quadratic Weighted Kappa (QWK) are considered. All these metrics aim to quantify how close the predictions are to the actual variable on the ordinal scale. In addition, the Correct Classification Rate (CCR), widely used in nominal problems, is also computed. We formalise these metrics below:

- CCR computes the percentage of correctly classified instances following the next equation:

$$\text{CCR} = \frac{1}{N} \cdot \sum_{i=1}^N \delta(\hat{y}_i - y_i), \quad (5)$$

where  $\delta$  express the zero-one loss function,  $\hat{y}_i$  and  $y_i$  are the predicted and the actual labels, respectively.

- MAE express the mean deviation of the obtained predictions from the target labels considering the

ordinal scale:

$$\text{MAE} = \frac{1}{N} \cdot \sum_{i=1}^N |\hat{y}_i - y_i|. \quad (6)$$

Higher values of MAE indicate poor performance since it means that our predictions are on average farther from the actual class.

- QWK is based on the kappa index [72]. This index establishes different weights to the levels of disagreement between the actual and the predicted classes. This feature makes it an appropriate metric for ordinal problems, as it penalises more severely predictions that are farther away from the true labels on the ordinal scale. QWK is formalised as follows:

$$\text{QWK} = 1 - \frac{\sum_{i,j} \omega_{i,j} O_{i,j}}{\sum_{i,j} \omega_{i,j} E_{i,j}}, \quad (7)$$

where  $\omega$  denotes the penalization matrix for which quadratic weights are considered,  $\omega_{i,j} = \frac{(i-j)^2}{(Q-1)^2}$ ,  $\omega_{i,j} \in [0, 1]$ ,  $O_{i,j}$  is the  $ij$ -th element of the confusion matrix, and  $E_{i,j} = \frac{O_{i\bullet} O_{\bullet j}}{N}$ , where  $O_{i\bullet}$  are the marginal frequencies of the confusion matrix for the target class  $\mathcal{C}_i$  and  $O_{\bullet j}$  are the marginal frequencies of the confusion matrix for predicted class  $\mathcal{C}_j$ .

- 1-OFF metric measures the proportion of samples classified in the target class or in any of the adjacent classes. It is defined as:

$$\text{OFF1} = \frac{S(\mathbf{M})}{S(\mathbf{O})} \quad (8)$$

where the  $S$  function returns the sum of the elements of a vector or matrix,  $\mathbf{O}$  is the confusion matrix, and  $\mathbf{M}$  is the result of multiplying  $\mathbf{O}$  by a matrix where all elements are zero, except the elements of the main diagonal and the adjacent diagonals, which are filled with ones.

Finally, the comparison of the different classifiers has been performed using the pairwise Wilcoxon signed-rank tests (see Table 3) for the comparison between nominal and ordinal techniques, and an adaptation of the critical difference diagram [73] for a global comparison between ordinal and baseline methodologies (see Figure 6). In this case, the cliques are built using the Holm correction [74] and a significance level of 0.05.

## 5.4 Results

The first assessment is to determine whether the ordinal algorithms outperform the nominal techniques. Specifically, we compare ordinal versus nominal versions for the InceptionTime, ResNet, ROCKET, MiniROCKET, and MultiROCKET classifiers. The results are presented in Table 3. In general, ordinal methods are significantly better than nominal techniques. The exception is ResNet, where there is no discernible difference, InceptionTime in terms of QWK, and MultiROCKET in terms of CCR.

The second experiment will determine which is the state-of-the-art approach in TSOc. Specifically, the five ordinal versions of the proposed approaches are benchmarked

	InceptionTime vs O-InceptionTime	ResNet vs O-ResNet	ROCKET vs O-ROCKET	MiniROCKET vs O-MiniROCKET	MultiROCKET vs O-MultiROCKET
MAE	< <b>0.01</b>	0.320	< <b>0.01</b>	< <b>0.01</b>	<b>0.033</b>
CCR	< <b>0.01</b>	0.085	<b>0.011</b>	<b>0.020</b>	0.557
QWK	0.276	0.948	< <b>0.01</b>	< <b>0.01</b>	< <b>0.01</b>
1-OFF	< <b>0.01</b>	0.231	< <b>0.01</b>	< <b>0.01</b>	< <b>0.01</b>

Table 3:  $p$ -values of the Wilcoxon pair tests for nominal versus ordinal versions of the methodologies proposed in this work.

along with baseline approaches: XGBoost, LogisticRegression and TSF. The results for the testing sets are graphically presented in Figure 6. We observe that O-MiniROCKET remains the best in three out of the four metrics, being only slightly outperformed by O-ROCKET in terms of 1-OFF. In general, it is noted that convolution-based methodologies have the best performance across all ordinal metrics. For MAE, the top clique is only composed of the four top-ranked ordinal approaches (note that the LogReg method is outside this clique). Focusing now on the performance of the deep learners, the O-InceptionTime remains the best method if we keep convolution-based techniques aside, except for the CCR metric. The reason behind this behaviour is that O-InceptionTime requires more training patterns to improve its performance. Note that TSF and LogReg achieve their best results for CCR. This is understandable as the goal of these approaches along with XGBoost is achieving the best results in the nominal performance metric (CCR). Moreover, since most of the top-performing approaches are in the same clique, and no significant differences are achieved among them, it can be said that there is still room for better algorithms to be adapted and developed for TSOC problems. Furthermore, another way of improvement could be extending the problems archive, to include a wider range of datasets.

With the goal of assessing the computational load of the approaches, Figure 7 compares the execution times with respect to the MAE. It can be observed that ROCKET-based methodologies have the best balance between time and performance, being the O-MiniROCKET the best.

Additionally, the performance of each algorithm is compared in terms of relative MAE. The relative MAE is calculated by scaling the MAE of each approach with the median MAE for each dataset. Figure 8 presents the relative MAE for each algorithm using boxplots. In this figure, values greater than 0.5 indicate that the approach performs worse than the average method, while values smaller than 0.5 indicate that the approach performs better than the average method. It can be observed that the ROCKET family exhibits a larger spread in the values, with most values being smaller than 0.5. On the other hand, O-ResNet, the two standard approaches (LogReg and XGBoost), and the TSF approaches have values around 0.5, indicating that they perform similarly to the average algorithm. Finally, in Figure 9, a global comparison in terms of MAE between the presented ordinal techniques is provided in the form of a full pairwise Multi-Comparison Matrix (MCM) [75]. As can be observed, the MiniROCKET method is positioned as the best performing technique, obtaining a significant  $p$ -value, lower than 0.05,

against the rest of methodologies, except for the ROCKET.

## 6 CONCLUSION

This paper presents the first approach of convolutional and deep learning based techniques to Time Series Ordinal Classification (TSOC), up-to-the-knowledge of the authors. This area remains largely unexplored in comparison against nominal Time Series Classification (TSC). In this work, one of the contributions is the first archive of TSOC problems, including a total of 18 datasets of various domains. We also contributes to the literature ordinal version of the two main categories in TSC: convolutional (ROCKET, MiniROCKET and MultiROCKET) and deep learning-based approaches (InceptionTime and ResNet). The ordinal versions of these techniques have resulted in significant performance improvements on the selected ordinal datasets against the nominal ones. Specifically, O-MiniROCKET is the best approach, achieving the best performance in terms of ordinal measures in an acceptable computational time. O-InceptionTime is the most promising deep learner, improving significantly the results achieved by the O-ResNet. All results, source code and guidance on reproducing experiments are available.

We recognise the potential for further advancements in TSOC algorithms. Incorporating remaining TSC techniques can offer additional opportunities to explore this area and can serve as a baseline for future developments in this field. Another way of improvement is extending the experiments to consider heterogeneous ensembles, such as HIVE-COTE2 [31], the state-of-the-art approach in TSC. It may be possible to adapt and apply this approach to TSOC with careful consideration. We also would like to extend our repository with new problems. We greatly appreciate any contributions to this archive.

## ACKNOWLEDGMENTS

This work has been partially subsidised by “Agencia Española de Investigación (España)” (grant ref.: PID2020-115454GB-C22/AEI/10.13039/501100011033) and by EP-SRC (grant ref.: EP/W030756/1). David Guijo-Rubio’s research has been subsidised by the University of Córdoba for the requalification of the Spanish university system of the Ministry of Universities, financed by the European Union - NextGenerationEU (grant ref.: UCOR01MS).

## REFERENCES

- [1] R. Khasha, M. M. Sepehri, and N. Taherkhani, “Detecting asthma control level using feature-based time series classification,” *Applied Soft Computing*, vol. 111, 2021.

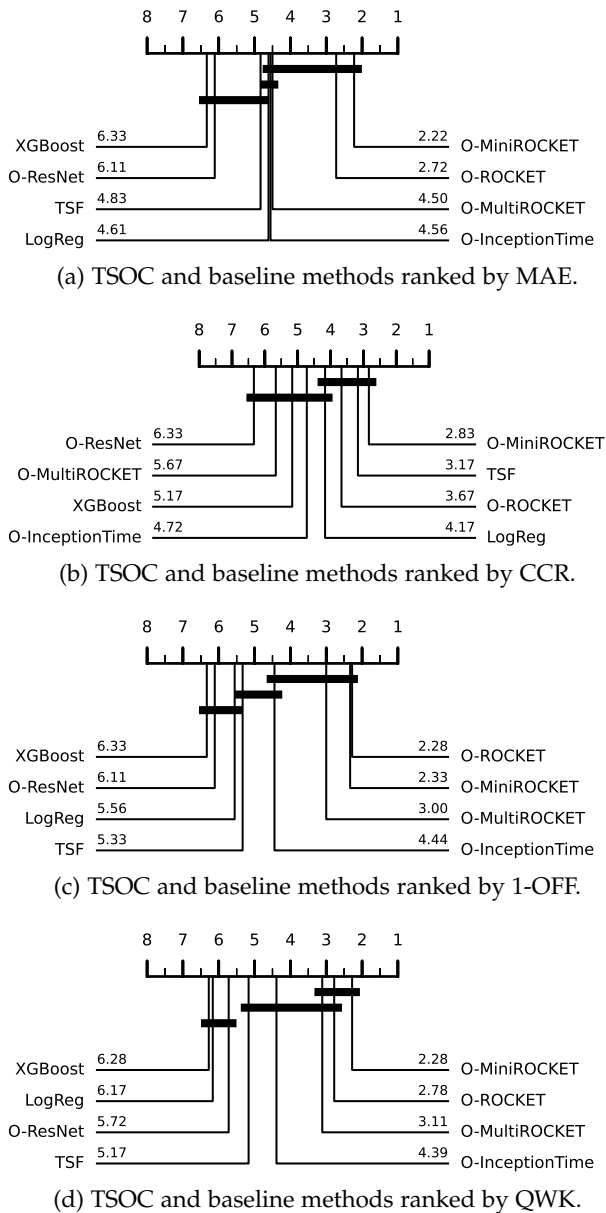

Figure 6: A comparison between the presented TSOC methodologies and baselines methods for the four metrics considered. A CDD is represented where cliques are built using the wilcoxon signed rank test with holm correction and a significance level of 0.05.

- [2] O. B. Sezer, M. U. Gudelek, and A. M. Ozbayoglu, "Financial time series forecasting with deep learning : A systematic literature review: 2005-2019," *Applied Soft Computing*, vol. 90, 2020.
- [3] D. P. Roy and L. Yan, "Robust landsat-based crop time series modelling," *Remote Sensing of Environment*, vol. 238, no. SI, 2020.
- [4] G. Moody, "Spontaneous termination of atrial fibrillation: A challenge from physionet and computers in cardiology," in *Computers in Cardiology 2004*, ser. Computing in Cardiology Series, vol. 31. IEEE, 2004, pp. 101–104.
- [5] J. Large, E. K. Kemsley, N. Wellner, I. Goodall, and A. Bagnall, "Detecting forged alcohol non-invasively through vibrational spectroscopy and machine learning," in *Advances in Knowledge Discovery and Data Mining: 22nd Pacific-Asia Conference, PAKDD 2018*. Springer, 2018, pp. 298–309.
- [6] A. Bagnall, J. Lines, A. Bostrom, J. Large, and E. Keogh, "The great time series classification bake off: a review and experimental evaluation of recent algorithmic advances," *Data Mining and Knowledge*

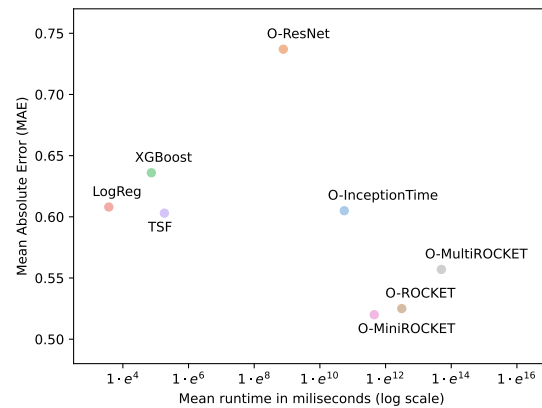

Figure 7: Run time in milliseconds (log scale average over all datasets) plotted against mean MAE obtained in the test sets.

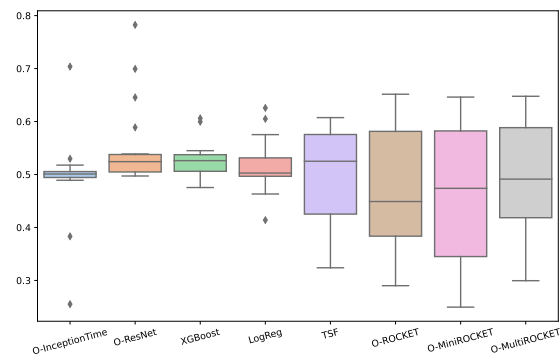

Figure 8: Relative MAE. Lower and greater values than 0.5 indicate that the method is better and worse, respectively, than the average method.

- [7] Z. Gong, H. Chen, B. Yuan, and X. Yao, "Multiobjective learning in the model space for time series classification," *IEEE transactions on cybernetics*, vol. 49, no. 3, pp. 918–932, 2018.
- [8] Q. Ma, Z. Chen, S. Tian, and W. W. Ng, "Difference-guided representation learning network for multivariate time-series classification," *IEEE Transactions on Cybernetics*, vol. 52, no. 6, pp. 4717–4727, 2020.
- [9] A. Jastrzebska, G. Nápoles, W. Homenda, and K. Vanhoof, "Fuzzy cognitive map-driven comprehensive time-series classification," *IEEE Transactions on Cybernetics*, 2021.
- [10] D. Guijo-Rubio, A. M. Durán-Rosal, P. A. Gutiérrez, A. Troncoso, and C. Hervás-Martínez, "Time-series clustering based on the characterization of segment typologies," *IEEE transactions on cybernetics*, vol. 51, no. 11, pp. 5409–5422, 2020.
- [11] Q. Liu, H. Peng, L. Long, J. Wang, Q. Yang, M. J. Pérez-Jiménez, and D. Orellana-Martín, "Nonlinear spiking neural systems with autapses for predicting chaotic time series," *IEEE Transactions on Cybernetics*, pp. 1–13, 2023.
- [12] A. Jastrzebska, "Time series classification through visual pattern recognition," *Journal of King Saud University - Computer and Information Sciences*, vol. 34, no. 2, pp. 134–142, 2022.
- [13] E. S. García-Treviño and J. A. Barria, "Structural generative descriptions for time series classification," *IEEE transactions on cybernetics*, vol. 44, no. 10, pp. 1978–1991, 2014.
- [14] N. Asadi, A. Mirzaei, and E. Haghshenas, "Creating discriminative models for time series classification and clustering by hmm ensembles," *IEEE transactions on cybernetics*, vol. 46, no. 12, pp. 2899–2910, 2015.
- [15] H. A. Dau, A. Bagnall, K. Kamgar, C.-C. M. Yeh, Y. Zhu,

Mean-mae	O-MiniROCKET -0.5203	O-ROCKET -0.5250	O-MultiROCKET -0.5574	O-InceptionTime -0.6054	O-ResNet -0.7369
O-MiniROCKET -0.5203	Mean-Difference r=c / r=c / r=c Wilcoxon p-value	0.0047 12 / 0 / 6 0.1674	<b>0.0372</b> 14 / 0 / 4 <b>0.0120</b>	<b>0.0851</b> 15 / 0 / 3 <b>0.0182</b>	<b>0.2167</b> 18 / 0 / 0 <b>≤ 1e-04</b>
O-ROCKET -0.5250	-0.0047 6 / 0 / 12 0.1540	-	<b>0.0324</b> 13 / 0 / 5 <b>0.0208</b>	<b>0.0804</b> 15 / 0 / 3 <b>0.0342</b>	<b>0.2119</b> 17 / 0 / 1 <b>≤ 1e-04</b>
O-MultiROCKET -0.5574	<b>-0.0372</b> 4 / 0 / 14 <b>0.0120</b>	<b>-0.0324</b> 5 / 0 / 13 <b>0.0208</b>	-	0.0479 8 / 0 / 10 0.6095	<b>0.1795</b> 12 / 0 / 6 <b>0.0385</b>
O-InceptionTime -0.6054	<b>-0.0851</b> 3 / 0 / 15 <b>0.0182</b>	<b>-0.0804</b> 3 / 0 / 15 <b>0.0342</b>	-0.0479 10 / 0 / 8 0.6095	-	<b>0.1316</b> 13 / 0 / 5 <b>0.0159</b>
O-ResNet -0.7369	<b>-0.2167</b> 0 / 0 / 18 <b>≤ 1e-04</b>	<b>-0.2119</b> 1 / 0 / 17 <b>≤ 1e-04</b>	<b>-0.1795</b> 6 / 0 / 12 <b>0.0385</b>	<b>-0.1316</b> 5 / 0 / 13 <b>0.0159</b>	If in bold, then p-value < 0.05

Figure 9: Multi-Comparison Matrix between ordinal methodologies in MAE. In each cell, three values are provided: 1) Average of differences in MAE. 2) Win/Ties/Losses counts. And 3) p-value of a Wilcoxon signed rank test.

- S. Gharghabi, C. A. Ratanamahatana, and E. Keogh, "The ucr time series archive," *IEEE-CAA Journal of Automatica SINICA*, vol. 6, no. 6, pp. 1293–1305, 2019.
- [16] M. Middlehurst, P. Schäfer, and A. Bagnall, "Bake off redux: a review and experimental evaluation of recent time series classification algorithms," *arXiv preprint arXiv:2304.13029*, 2023.
- [17] E. F. Harrington, "Online ranking/collaborative filtering using the perceptron algorithm," in *Proceedings of the Twentieth International Conference on Machine Learning (ICML2003)*, 2003.
- [18] F. Hernandez-Navarro, P. Campoy-Munoz, M. de la Paz-Marin, C. Hervas-Martinez, and X. Yao, "Addressing the eu sovereign ratings using an ordinal regression approach," *IEEE Transactions on Cybernetics*, vol. 43, no. 6, pp. 2228–2240, 2013.
- [19] C. Li, Q. Liu, W. Dong, X. Zhu, J. Liu, and H. Lu, "Human age estimation based on locality and ordinal information," *IEEE Transactions on Cybernetics*, vol. 45, no. 11, pp. 2522–2534, 2015.
- [20] D. Guijo-Rubio, P. A. Gutierrez, C. Casanova-Mateo, J. Sanz-Justo, S. Salcedo-Sanz, and C. Hervas-Martinez, "Prediction of low-visibility events due to fog using ordinal classification," *Atmospheric Research*, vol. 214, pp. 64–73, 2018.
- [21] K. Xu, M. Zhou, D. Yang, Y. Ling, K. Liu, T. Bai, Z. Cheng, and J. Li, "Application of ordinal logistic regression analysis to identify the determinants of illness severity of covid-19 in china," *Epidemiology and Infection*, vol. 148, 2020.
- [22] J. A. Anderson, "Regression and ordered categorical variables," *Journal of the Royal Statistical Society. Series B (Methodological)*, vol. 46, no. 1, pp. 1–30, 1984.
- [23] E. Keogh and C. A. Ratanamahatana, "Exact indexing of dynamic time warping," *Knowledge and information systems*, vol. 7, pp. 358–386, 2005.
- [24] A. Bagnall, "Time series classification with ensembles of elastic distance measures," *Data Mining and Knowledge Discovery*, vol. 29, 2014.
- [25] B. Lucas, A. Shifaz, C. Pelletier, L. O'Neill, N. Zaidi, B. Goethals, F. Petitjean, and G. I. Webb, "Proximity forest: an effective and scalable distance-based classifier for time series," *Data Mining and Knowledge Discovery*, vol. 33, no. 3, pp. 607–635, feb 2019.
- [26] M. Herrmann, C. W. Tan, M. Salehi, and G. I. Webb, "Proximity forest 2.0: A new effective and scalable similarity-based classifier for time series," 2023.
- [27] H. Deng, G. Runger, E. Tuv, and M. Vladimir, "A time series forest for classification and feature extraction," *Information Sciences*, vol. 239, pp. 142–153, 2013.
- [28] M. Middlehurst, J. Large, and A. Bagnall, "The canonical interval forest (cif) classifier for time series classification," in *2020 IEEE International Conference on Big Data*. IEEE, 2020, pp. 188–195.
- [29] C. H. Lubba, S. S. Sethi, P. Knaute, S. R. Schultz, B. D. Fulcher, and N. S. Jones, "catch22: Canonical time-series characteristics," *Data Mining and Knowledge Discovery*, vol. 33, no. 6, pp. 1821–1852, 2019.
- [30] N. Cabello, E. Naghizade, J. Qi, and L. Kulik, "Fast and accurate time series classification through supervised interval search," 11 2020, pp. 948–953.
- [31] M. Middlehurst, J. Large, M. Flynn, J. Lines, A. Bostrom, and A. Bagnall, "Hive-cote 2.0: a new meta ensemble for time series classification," *Machine Learning*, vol. 110, no. 11-12, pp. 3211–3243, 2021.
- [32] J. Hills, J. Lines, E. Baranauskas, J. Mapp, and A. Bagnall, "Classification of time series by shapelet transformation," *Data mining and knowledge discovery*, vol. 28, no. 4, pp. 851–881, 2014.
- [33] A. Guillaume, C. Vrain, and W. Elloumi, "Random dilated shapelet transform: A new approach for time series shapelets," in *Pattern Recognition and Artificial Intelligence*. Springer International Publishing, 2022, pp. 653–664.
- [34] P. Schäfer, "The boss is concerned with time series classification in the presence of noise," *Data Mining and Knowledge Discovery*, vol. 29, no. 6, pp. 1505–1530, 2015.
- [35] P. Schäfer and U. Leser, "Fast and accurate time series classification with weasel," in *Proceedings of the 2017 ACM on Conference on Information and Knowledge Management*, 2017, pp. 637–646.
- [36] M. Middlehurst, J. Large, G. Cawley, and A. Bagnall, "The temporal dictionary ensemble (tde) classifier for time series classification," in *Joint European Conference on Machine Learning and Knowledge Discovery in Databases*. Springer, 2020, pp. 660–676.
- [37] P. Schäfer and U. Leser, "Weasel 2.0 – a random dilated dictionary transform for fast, accurate and memory constrained time series classification," 2023.
- [38] A. Dempster, F. Petitjean, and G. I. Webb, "Rocket: exceptionally fast and accurate time series classification using random convolutional kernels," *Data Mining and Knowledge Discovery*, vol. 34, pp. 1454–1495, 2020.
- [39] A. Dempster, "A very fast (almost) deterministic transform for time series classification angus dempster, daniel f. schmidt, geofrey i. webb," *arXiv preprint arXiv:2012.08791*, 2020.
- [40] C. W. Tan, A. Dempster, C. Bergmeir, and G. I. Webb, "Multi-rocket: multiple pooling operators and transformations for fast and effective time series classification," *Data Mining and Knowledge Discovery*, pp. 1–24, 2022.
- [41] A. Dempster, D. F. Schmidt, and G. I. Webb, "Hydra: Competing convolutional kernels for fast and accurate time series classification," 2022.
- [42] H. I. Fawaz, B. Lucas, G. Forestier, C. Pelletier, D. F. Schmidt, J. Weber, G. I. Webb, L. Idoumghar, P.-A. Muller, and F. Petitjean, "InceptionTime: Finding AlexNet for time series classification," *Data Mining and Knowledge Discovery*, vol. 34, no. 6, pp. 1936–1962, 2020.
- [43] Z. Wang, W. Yan, and T. Oates, "Time series classification from scratch with deep neural networks: A strong baseline," in *2017 International joint conference on neural networks (IJCNN)*. IEEE, 2017, pp. 1578–1585.
- [44] N. M. Foumani, L. Miller, C. W. Tan, G. I. Webb, G. Forestier, and M. Salehi, "Deep learning for time series classification and extrinsic regression: A current survey," 2023.
- [45] A. Ismail-Fawaz, M. Devanne, J. Weber, and G. Forestier, "Deep learning for time series classification using new hand-crafted convolution filters," in *2022 IEEE International Conference on Big Data*, 2022, pp. 972–981.
- [46] J. Lines, S. Taylor, and A. Bagnall, "Time series classification with hive-cote: The hierarchical vote collective of transformation-based



- ensembles," *ACM Transactions on Knowledge Discovery from Data*, vol. 12, no. 5, 2018.
- [47] A. Shifaz, C. Pelletier, F. Petitjean, and G. Webb, "Ts-chief: a scalable and accurate forest algorithm for time series classification," *Data Mining and Knowledge Discovery*, vol. 34, no. 3, pp. 742–775, 2020.
- [48] R. Herbrich, T. Graepel, and K. Obermayer, "Support vector learning for ordinal regression," in *Ninth International Conference on Artificial Neural Networks (ICANN99)*, no. 470. IEE, 1999, pp. 97–102.
- [49] W. Chu and S. Keerthi, "Support vector ordinal regression," *Neural computation*, vol. 19, pp. 792–815, 2007.
- [50] D. Olsson, P. Georgiev, and P. M. Pardalos, "Kernel principal component analysis: Applications, implementation and comparison," in *Models, Algorithms, and Technologies for Network Analysis*, vol. 59, 2013, pp. 127–148.
- [51] W. Chu and Z. Ghahramani, "Gaussian processes for ordinal regression," *Journal of Machine Learning Research*, vol. 6, pp. 1019–1041, 2005.
- [52] P. K. Srijith, S. Shevade, and S. Sundararajan, "Validation based sparse gaussian processes for ordinal regression," in *Neural Information Processing, ICONIP 2012*, vol. 7664. IEEE, 2012, pp. 409–416.
- [53] P. Srijith, S. Shevade, and S. Sundararajan, "A probabilistic least squares approach to ordinal regression," in *AI 2012: Advances in Artificial Intelligence*. Springer, 2012, pp. 683–694.
- [54] P. K. Srijith, S. Shevade, and S. Sundararajan, "Semi-supervised gaussian process ordinal regression," in *Machine Learning and Knowledge Discovery in Databases*. Berlin, Heidelberg: Springer Berlin Heidelberg, 2013, pp. 144–159.
- [55] V. M. Vargas, P. A. Gutiérrez, and C. Hervás-Martínez, "Cumulative link models for deep ordinal classification," *Neurocomputing*, vol. 401, pp. 48–58, 2020.
- [56] V. M. Vargas, P. A. Gutiérrez, and C. Hervás-Martínez, "Deep ordinal classification based on the proportional odds model," in *From Bioinspired Systems and Biomedical Applications to Machine Learning*, vol. 11487, 2019, pp. 441–451.
- [57] R. Rosati, L. Romeo, V. M. Vargas, P. A. Gutiérrez, C. Hervás-Martínez, and E. Frontoni, "A novel deep ordinal classification approach for aesthetic quality control classification," *Neural Computing and Applications*, 2022.
- [58] D. Guijo-Rubio, P. A. Gutiérrez, A. Bagnall, and C. Hervás-Martínez, "Time series ordinal classification via shapelets," in *2020 International Joint Conference on Neural Networks (IJCNN)*. IEEE, 2020.
- [59] D. Guijo-Rubio, P. A. Gutiérrez, A. Bagnall, and C. Hervás-Martínez, "Ordinal versus nominal time series classification," in *International Workshop on Advanced Analytics and Learning on Temporal Data*. Springer, 2020, pp. 19–29.
- [60] D. Guijo-Rubio, V. M. Vargas, P. A. Gutiérrez, and C. Hervás-Martínez, "Studying the effect of different lp norms in the context of time series ordinal classification," in *Conference of the Spanish Association for Artificial Intelligence*. Springer, 2021, pp. 44–53.
- [61] P. McCullagh, "Regression models for ordinal data," *Journal of the Royal Statistical Society: Series B (Methodological)*, vol. 42, no. 2, pp. 109–127, 1980.
- [62] D. Guijo-Rubio, M. Middlehurst, G. Arcencio, D. F. Silva, and A. Bagnall, "Unsupervised feature based algorithms for time series extrinsic regression," *arXiv preprint arXiv:2305.01429*, 2023.
- [63] F. Pedregosa, F. Bach, and A. Gramfort, "On the consistency of ordinal regression methods," *The Journal of Machine Learning Research*, vol. 18, no. 1, pp. 1769–1803, 2017.
- [64] P. A. Gutiérrez, M. Perez-Ortiz, J. Sanchez-Monedero, F. Fernandez-Navarro, and C. Hervás-Martínez, "Ordinal regression methods: Survey and experimental study," *IEEE Transactions on Knowledge and Data Engineering*, vol. 28, no. 1, pp. 127–146, 2016.
- [65] J. de La Torre, D. Puig, and A. Valls, "Weighted kappa loss function for multi-class classification of ordinal data in deep learning," *Pattern Recognition Letters*, vol. 105, pp. 144–154, 2018.
- [66] S. Bai, J. Z. Kolter, and V. Koltun, "An empirical evaluation of generic convolutional and recurrent networks for sequence modeling," *arXiv preprint arXiv:1803.01271*, 2018.
- [67] K. He, X. Zhang, S. Ren, and J. Sun, "Deep residual learning for image recognition," in *Proceedings of the IEEE conference on computer vision and pattern recognition*, 2016, pp. 770–778.
- [68] H. I. Fawaz, G. Forestier, J. Weber, L. Idoumghar, and P.-A. Muller, "Deep neural network ensembles for time series classification," in *2019 International Joint Conference on Neural Networks (IJCNN)*. IEEE, 2019, pp. 1–6.
- [69] D. R. Cox, "The regression analysis of binary sequences," *Journal of the Royal Statistical Society: Series B (Methodological)*, vol. 20, no. 2, pp. 215–232, 1958.
- [70] T. Chen, T. He, M. Benesty, V. Khotilovich, Y. Tang, H. Cho, K. Chen *et al.*, "Xgboost: extreme gradient boosting," *R package version 0.4-2*, vol. 1, no. 4, pp. 1–4, 2015.
- [71] A. Gómez-Orellana, D. Guijo-Rubio, P. Gutiérrez, and C. Hervás-Martínez, "Simultaneous short-term significant wave height and energy flux prediction using zonal multi-task evolutionary artificial neural networks," *Renewable Energy*, vol. 184, pp. 975–989, 2022.
- [72] J. Cohen, "A coefficient of agreement for nominal scales," *Educational and psychological measurement*, vol. 20, no. 1, pp. 37–46, 1960.
- [73] J. Demšar, "Statistical comparisons of classifiers over multiple data sets," *Journal of Machine Learning Research*, vol. 7, pp. 1–30, 2006.
- [74] S. García and F. Herrera, "An extension on "statistical comparisons of classifiers over multiple data sets" for all pairwise comparisons," *Journal of Machine Learning Research*, vol. 9, pp. 2677–2694, 2008.
- [75] A. Ismail-Fawaz, A. Dempster, C. W. Tan, M. Herrmann, L. Miller, D. F. Schmidt, S. Berretti, J. Weber, M. Devanne, G. Forestier, and G. I. Webb, "An approach to multiple comparison benchmark evaluations that is stable under manipulation of the compare set," 2023.

**Rafael Ayllón-Gavilán** received the BSc degree in Computer Science in 2021 and the MSc degree in Artificial Intelligence in 2022. He is currently pursuing the PhD degree in Computer Science at the University of Córdoba. His current research concerns the time series classification domain, addressing the ordinal case together with its possible real-world applications.

**David Guijo-Rubio** received the PhD degree in Computer Science from the University of Córdoba (UCO), Spain, in 2021. He is working as a Postdoctoral Researcher at both UCO and University of East Anglia (UK). His current interests include ordinal classification, pattern recognition and different tasks applied to time series (classification -nominal and ordinal, clustering and regression).

**Pedro A. Gutiérrez** (M'07-SM'15) received the PhD degree in Computer Science and Artificial Intelligence from the University of Granada, Spain, in 2009. He is currently a Full Professor of Computer Science at University of Córdoba, Spain. His research interests are in the areas of supervised learning and ordinal classification. He serves on the Editorial board of the IEEE Transaction on Neural Networks and Learning Systems and on the organisation of several computational intelligence conferences.

**Anthony Bagnall** received the PhD degree in Computer Science from the University of East Anglia (UEA), UK in 2001. He is currently a Full Professor of Computer Science at UEA, where he leads the time series machine learning group. His primary research interest is in time series machine learning, with a historic focus on classification, but more recently looking at clustering and regression. He has a side interest in ensemble design.

**César Hervás-Martínez** (M'07-SM'14) received the PhD in Mathematics from the University of Seville, Spain, in 1986. He is currently a Full Professor of Computer Science at University of Córdoba, Spain, leading the AYRNA research group. His current research interests include neural networks, evolutionary computation, and the modelling of natural systems.

