

Enabling BIM-Driven Robotic Construction Workflows with Closed-Loop Digital Twins

Xi Wang^{1*}, Hongrui Yu^{2*}, Wes McGee³, Carol C. Menassa^{4†}, Vineet R. Kamat⁵

¹Assistant Professor, Department of Construction Science, Texas A&M University, 3337 TAMU, College Station, TX 77843, USA

²Ph.D. Candidate, Department of Civil and Environmental Engineering, University of Michigan, 2350 Hayward Street, Ann Arbor, MI 48109, USA

³Associate Professor, Taubman College of Architecture and Urban Planning, University of Michigan, 2000 Bonisteel Boulevard, Ann Arbor, MI 48109, USA

⁴Professor, Department of Civil and Environmental Engineering, University of Michigan, 2350 Hayward Street, Ann Arbor, MI 48109, USA

⁵Professor, Department of Civil and Environmental Engineering, University of Michigan, 2350 Hayward Street, Ann Arbor, MI 48109, USA

ABSTRACT

The introduction of assistive construction robots can significantly alleviate physical demands on construction workers. Leveraging a Building Information Model (BIM) offers a natural and promising approach to driving a robotic construction workflow. However, because of uncertainties inherent in construction sites, such as discrepancies between the as-designed and as-built components, robots cannot solely rely on a BIM to plan and perform field construction work. Human workers are adept at improvising alternative plans with their creativity and experience and thus can assist robots in overcoming uncertainties and performing construction work successfully. In such scenarios, it is critical to continuously update the BIM as work processes unfold so that it includes as-built information for the ensuing construction and maintenance tasks. This research introduces an interactive closed-loop digital twin framework that integrates a BIM into human-robot collaborative construction workflows. The robot's functions are primarily driven by the BIM, but it adaptively adjusts its plans based on actual site conditions, while the human co-worker oversees and supervises the process. When necessary, the human co-worker intervenes in the robot's plan by changing the task sequence or workspace geometry or requesting a new motion plan to help the robot overcome the encountered uncertainties. Experiments involving block pick-and-place tasks are carried out to verify system performance using an industrial robotic arm in a research laboratory setting that mimics a construction site. In addition, a drywall installation case study is conducted to validate the system. Integrating the flexibility of human workers and the autonomy and accuracy afforded by BIMs, the proposed framework offers significant promise of increasing the robustness of construction robots in the performance of field construction work.

* These two authors contributed equally to this work.

† Corresponding author (menassa@umich.edu).

KEYWORDS

Construction robotics, Building Information Model, Digital twin, Human-robot collaboration.

1 INTRODUCTION

Construction has been ill-famed for its dangerous and harsh working environments and excessive physical demands on workers, which often result in a lack of motivation for people, especially those of diverse abilities, to pursue their careers in the industry [1–4]. As a result, the construction industry is facing severe shortages of skilled labor [5,6]. According to the Associated General Contractors of America, 73% of contractors consider worker shortage as their biggest concern in 2022 [7].

Industrial robotic manipulators can exert high physical power and operate at high speeds, and thus have significant potential to reduce the physical burden on human workers [8]. Robots have already been adopted in several industry sectors such as manufacturing, nuclear, healthcare, and rescue to reduce human workers' workload and their exposure to potential hazards [9–13]. Construction automation powered by robotics has demonstrated the potential to reduce the physical demand on construction workers and improve the diversity and inclusion of the construction workforce, thus mitigating the labor shortage issues faced by the industry [14–16]. On the other hand, while robotics is still in its emerging phase in the field of construction automation, the use of Building Information Models (BIMs) has been widely adopted in the industry to support digital construction project workflows [17,18].

A BIM is “a digital representation of physical and functional characteristics of a facility” [19]. It contains a variety of geometric and attribute information, such as 3D models, schedules, construction methods, and materials, which are used to facilitate the construction processes [20]. Although BIMs play important roles in design, communication, and project management throughout the project life cycle [17,21], they generally lack the interoperability needed to support construction robot task planning [22,23]. Currently, robot installation sequences and poses are generated primarily by retrieving geometric data from BIMs encoded using Industry Foundation Classes (IFC) [20,23,24]. However, such proposed approaches are limited to specific construction tasks or types of components, such as bricklaying or wall panels. Moreover, working environments for field construction involve a lot of uncertainties (e.g., deviations in as-built components) that can cause robot failure when following a rigid program. While a BIM can provide information to the robot, the workflow needs the ability to improvise (i.e., dynamically adjust plans based on encountered situations) to flexibly perform the work during the field construction process [25].

Compared to robots, humans are more adept at creative and adaptive planning based on their experience [26,27]. They can adjust a task plan according to what they observe on the construction site to ensure the quality and continuity of the work. Thus, human expertise in improvisation is indispensable for field construction that involves considerable uncertainties and is necessary to support robotic construction [28]. In addition, human workers can supervise the robotic construction process to ensure collision-free safe manipulation in dynamic on-site working

environments. Therefore, by enabling Human-Robot Collaboration (HRC), the flexibility and robustness of BIM-driven robotic construction systems can be significantly improved.

This research proposes a closed-loop digital twin framework to enable BIM-driven Human-Robot Collaborative Construction (HRCC) workflows, as shown in Figure 1. The system is built upon an interactive and immersive process-level digital twin (I2PL-DT) system previously developed by the authors [29]. A BIM module is integrated to provide geometric and attribute data to both the human workers through the user interface and the Robot Operating System (ROS). After a robot generates work plans with information from the BIM, human co-workers supervise the robot's workflow (e.g., preview robot plans and monitor execution status) and make interventions (e.g., adjust installation target or request another trajectory plan) when necessary.

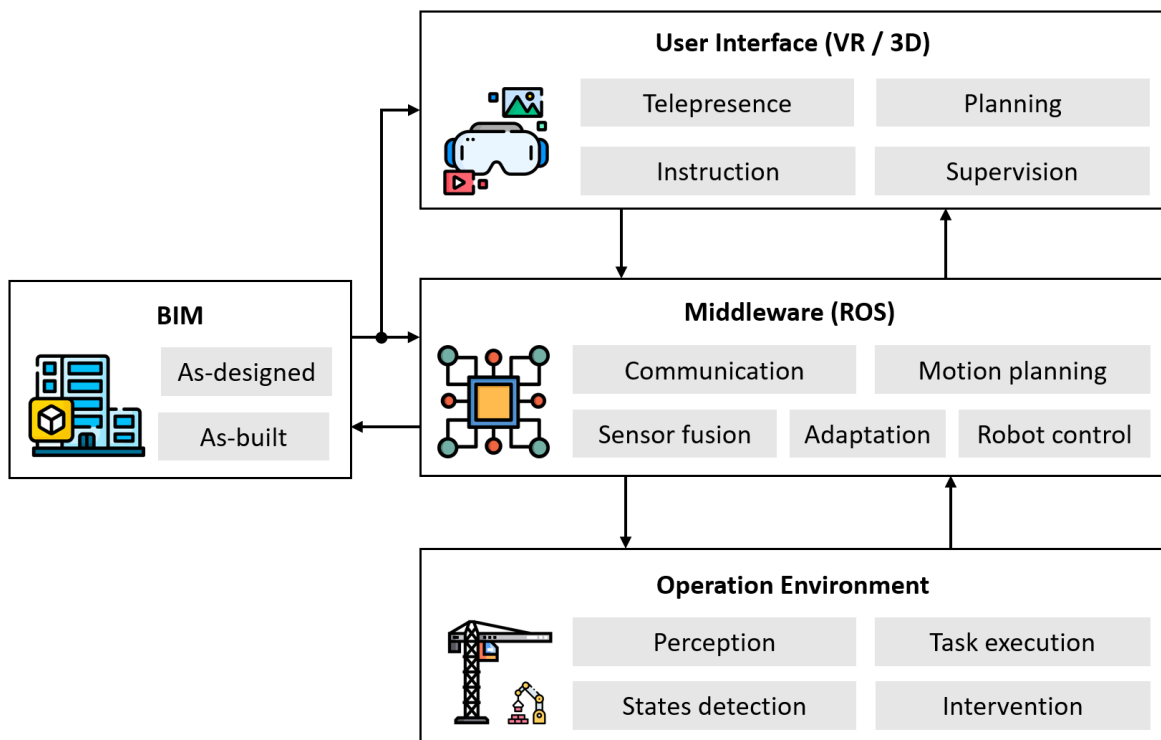

Figure 1 Closed-Loop Digital Twin Framework Overview

In addition, the as-built data collected by the robot during the construction process is sent to the BIM to reflect changes between the as-designed and the as-built workspace to be used for ensuing construction tasks, thereby closing the loop. The workflow supports seamless integration of various sources of information received from the BIM, human co-workers, and robot sensors. In parallel, the system processes the collected information into different forms that can be visualized and understood by humans, processed by robots for computing and control, and saved and presented in BIMs.

The technical workflow for BIM-driven robotic construction along with its technical challenges are discussed in four steps, including (1) formulation of the BIM repository that supports robotic

construction; (2) preparation of the construction site and the BIM for a construction task; (3) the construction process, including automatic digital twin generation, robotic construction, and resolution of as-built / as-designed deviations; and (4) updating of the BIM repository with as-built construction data collected by the robot.

Experiments involving block pick-and-place tasks are conducted to verify system performance. In addition, a drywall installation case study involving a deviated prefabricated wall frame is presented as a proof-of-concept implementation to explore the physical setup process and for system validation. Both the experiments and the case study are conducted with a large-scale physical Kuka industrial robotic arm. The proposed system not only extends the autonomy and accuracy of robotic construction but also offers the flexibility to overcome uncertainties in field construction work. The presented framework and workflow have the potential to be applied to a broad variety of construction tasks.

2 BACKGROUND

2.1 Human-Robot Collaboration

HRC aims to retain the robustness and adaptability of an automated system by combining robots' computational ability and durability with humans' creativity and flexibility [30,31]. HRC can be classified into two types, physical collaboration and contactless collaboration [32]. For physical HRC, the human co-worker intentionally makes physical contact with the robot or the object held by the robot to hand over or co-manipulate objects [33,34]. However, working alongside robots, especially construction robots that carry large and heavy components, poses high safety risks to humans. Therefore, contactless HRC has been used in many applications. It allows humans to guide robots with gestures [35], natural language [36,37], joysticks and haptic devices [38,39], Virtual Reality (VR) [40–42], and neural signals [43,44]. One main concern with contactless HRC, especially those from remote locations, is that humans' perception of the operational environment and the robot is limited. It is critical to provide humans with sufficient and accurate information in an effective way to enable efficient decision making. One of the popular approaches is to create a digital twin to provide real-time information about the robot and its operation environment to humans [45,46].

In prior work, the authors proposed an I2PL-DT system for human workers to remotely receive and visualize the updated state of a construction workspace [29]. The system consists of three modules, including an immersive Virtual Reality (VR) interface, middleware enabled by ROS, and Robot Operation Environment (ROE) (i.e., construction site, robot, and sensors). Human co-workers can visualize construction site and robot conditions in real-time and perform high-level task planning (e.g., indicating component installation sequence and positions). The high-level plan is then used to generate motion plans, which are processed into realistic animations in VR for the human co-worker to preview and evaluate. Upon approval, the robot executes the approved plan under human supervision. The work supports a collaboration paradigm where human workers perform high-level decision-making and supervision while robots undertake low-level motion planning and physical execution of the work.

Despite being a key component of the workflow proposed in this paper, the previously developed I2PL-DT system in and of itself has several limitations. First, the process of creating the digital twin for a construction task takes considerable effort. The immersive VR interface needs to be manually created by importing BIM data into VR, creating interactive game objects, and adding interactive functions (e.g., sending messages to ROS). Second, the human co-worker needs to specify the work plan for each component by indicating to the robot which component to pick up and the location to install it. Thus, substantial human effort is required for such step-by-step instructions. Lastly, since the human co-worker specifies the high-level task objectives by manipulating and placing virtual objects with controllers in VR, the accuracy is limited and the resulting work may not comply with typical construction work specifications and desired tolerances.

In order to overcome these critical and practical limitations, this paper integrates a BIM with the I2PL-DT system and proposes an automatic approach to creating digital twins. Figure 2 shows the elements of the updated and significantly expanded system presented in this paper and compares it to the previous I2PL-DT system. With the proposed approach, manual processes of creating the digital twin and placing each component step-by-step in VR can be avoided, which improves system autonomy and work accuracy as well as reduces human workers' workload. In the remainder of this section, the adoption of a BIM to support construction automation and robotics and the existing approaches to create digital twins for robotic applications are introduced and discussed.

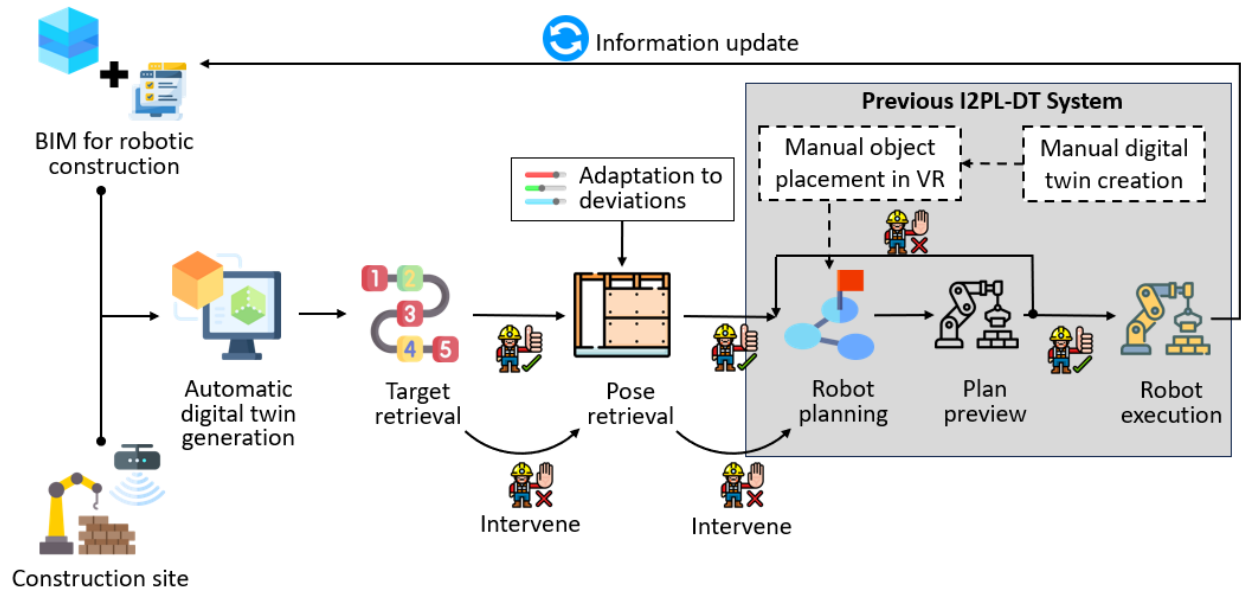

Figure 2 Elements of the Updated System

2.2 BIMs in Construction Automation and Robotics

BIMs have been widely adopted to promote automation throughout the life cycle of the Architecture, Engineering and Construction, and Facilities Management (AEC/FM) industry [47]. Recently, BIMs have been used to facilitate robotized construction in various ways. For example, BIMs can provide information to guide the off-site prefabrication process [48,49] and assist with object recognition for on-site assembly [50]. Layout information contained in the BIM is used to support robot indoor navigation tasks for building construction and maintenance [51–53]. Commercial mobile robots have been introduced to draw layouts on-site based on BIMs [54]. The geometric information contained in BIMs has also been used to facilitate 3D printing in construction [55,56].

BIMs can also provide information to support robot motion planning. For example, in robotic brick assembly tasks, BIMs can provide position and orientation data for a robot to pick up and place materials as well as task sequencing data to control the robotic workflow [24,57]. IFC models have been converted to work with robotic simulation platforms for robot navigation [23] and to simulate the robotic wall frame assembly process [58]. In these existing studies, robots fully rely on the BIM for task planning. The construction site needs to conform to the exact BIM specifications for the robot to successfully perform construction work. However, considerable uncertainties exist on construction sites. Deviated components, moving workers and equipment, and stacked materials on-site may interrupt the BIM-generated robot motions, causing robots to stall while performing construction work on-site. [59] used a combination of the BIM and sensing information to generate adaptive robot motions. Despite such advances, the robot's adaptability is limited to a narrow set of situations and construction tasks [59].

In summary, existing studies leveraging BIMs in robotics have three limitations. First, they lack generality to support various types of construction tasks. Second, they cannot handle uncertainties for field construction, which can go beyond the robot's adaptive capabilities and interrupt robot activities generated by the BIM. Thus, human intervention is necessary in addition to the BIM for the success of robotic field construction. Third, as-built data collected by the robot during the construction process is useful for the ensuing construction, operation, and maintenance phases of the project; however, a closed loop for a BIM to both provide and collect construction information is missing in existing studies. Therefore, a general framework that supports different types of construction tasks and allows human intervention is necessary.

2.3 Digital Twins Creation in Robotic Applications

Digital twins can be used for visualizing and incorporating information from different resources, and they also support real-time communication and interaction [60]. Therefore, they are a promising candidate to integrate BIMs with HRCC. Based on the demand for different application purposes, digital twins can be created with various approaches. One of the most popular methods in the AEC/FM industry is to use 3D point clouds. The environment is captured with laser scanners or depth cameras as 3D point clouds [61–63]. Such systems can comprehensively capture the environment in real-time, theoretically allowing for continuous updates of the digital twin to reflect

the evolving environment at any point in time. However, the transmission of large-size point cloud data is computationally expensive and is subject to delays. Furthermore, subsequent steps of processing and registering the point clouds, object detection, or 3D reconstruction are usually needed to achieve the required functions [64,65].

[66] developed the VITASCOPE language to integrate simulation models, hardware control, and real-time construction data for dynamic construction scenario visualization at the operation level. [67] and [68] created digital twins of a robot to program, control, and visualize robot motions. Joint state data are exchanged between the physical and virtual robots in real-time. In order to reduce the computation load while allowing real-time visualization of the construction environment, [29] created a digital twin using a combination of a BIM, 3D meshes of as-built structures, and point clouds. However, these approaches require manually importing models or enabling the functionality of the digital twin. As a result, it interrupts the automated workflow of HRCC initiation, which can potentially hinder the widespread application of digital twins in HRCC. Therefore, an approach to automatically generate digital twins that are equipped with pertinent functions (e.g., target object selection, communication between modules) is necessary to promote and extend the autonomy of the HRCC workflow.

2.4 Research Objectives

To address the abovementioned research gaps, a workflow with the following characteristics is needed to effectively support HRCC. First, instead of parsing specific information from BIM repositories to automate one type of construction work, a general framework that supports different types of tasks and components is needed. Second, the workflow should automatically interface with different construction tasks without additional programming or development effort that cannot be performed by construction workers without related expertise. Third, robots should have the ability to handle significant uncertainties on construction sites while allowing human intervention to resolve cases that extend beyond the robots' capabilities. Lastly, the workflow should record the construction-related data collected by the robot sensors during the HRCC process for future reference to enable loop closure. With these objectives, the following section presents a closed-loop generalizable framework integrating a BIM and HRCC, which supports automated collaborative workflows and can overcome uncertainties in field construction work.

3 TECHNICAL APPROACH

A BIM-driven HRCC workflow enabled by closed-loop digital twins is proposed in this study. The BIM provides data (e.g., component geometry, position, type) to both the robot and the human co-worker by sending messages to ROS and Unity (where the interface is developed). The robot then generates the work plan based on the BIM and adapts the plan according to the as-built circumstances detected by its sensors. For example, during drywall installation, the robot retrieves the name and target position of the next panel to install from the BIM; it then adjusts the installation position of the panel based on how the wall frame has actually been built as detected by its camera. Next, human co-workers supervise the robotic construction process (e.g., by evaluating and

approving the robot plan) and intervene to adjust the high-level task plan (e.g., by adjusting the target installation sequence and pose proposed by the robot) when necessary.

An overview of the BIM-driven HRCC workflow is shown in Figure 3. First, the BIM data accessible by both human co-workers and robots needs to be created, as presented in Section 3.1. Next, before construction starts, human workers need to prepare physically on the construction site (e.g., materials staging) and digitally in the BIM (e.g., task designation). These steps are followed by the construction process. Lastly, after certain construction tasks are finished, the BIM repository is updated with the latest as-built data. The framework and technological approach for integrating a BIM to drive HRCC is introduced in detail in Section 3.2. Lastly, Section 3.3 introduces how the system is deployed onto a physical industrial robot.

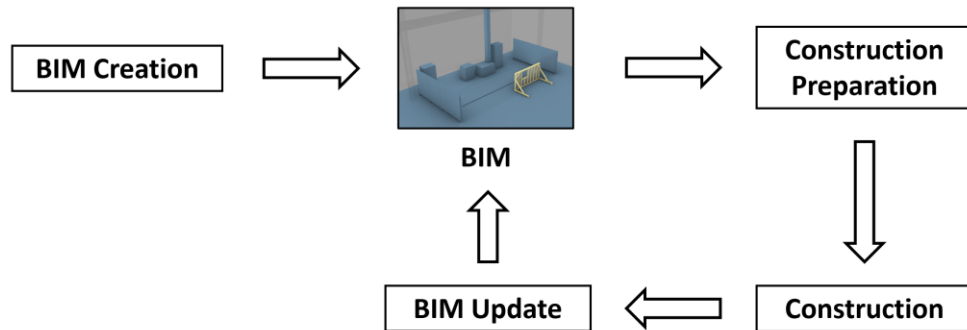

Figure 3 BIM-driven HRCC Workflow

3.1 BIMs for Robotic Construction

BIMs created for traditional construction methods are typically not compatible with robotic construction [69]. Some additional elements are necessary for a BIM to better support human-robot collaborative task planning:

- **Shop drawing-level geometry.** Shop drawings precede detailed work plans and contain information needed for fabrication, assembly, and erection [70]. For example, in a robotic drywall installation task, shop drawings for drywall panels are needed so the robot knows where each panel should be located. However, shop drawing-level details are not needed for every component in BIM and are dependent on the construction plan. For example, a component that is prefabricated off-site or erected on-site as a whole can be represented in the BIM as one single object.
- **Construction sequence:** Detailed construction sequence information contained in the BIM is crucial to automate the construction process. The construction sequence information should be provided in correspondence with the shop drawing-level geometry, such as the sequence showing which drywall panels to install first.
- **Component relationships.** Relationships between components can affect robot planning, especially when discrepancies exist and the robot needs to adapt its plan. Even though some object arrangements visually look the same, they might indicate different relationships (i.e.,

topologies) which require different construction plans. As a result, clearly defined component relationships in the BIM are necessary for the adaptive planning of the human-robot work team.

- **Component layers.** A unified predefined layer structure in the BIM not only helps organize components into different groups for user comprehension but also supports the development of interfaces that can quickly connect to different BIM projects and automate related processes in the project life cycle, such as construction. Therefore, a BIM layer structure is proposed to facilitate the automatic generation of interactive digital twins and the HRCC process, as shown in Table 1.

Table 1 BIM Layer Structure for Robotic Construction

Layer Name	Description
Target	Physical objects (e.g., timber) or virtual indicators (e.g., fastener locations) the robot needs to install or operate for the current construction task.
As-Built	Components that have already been built. If they are inside the workspace, they need to be considered for collision avoidance. They update with the construction progress or as the robot senses the environment.
Materials	Construction materials staged on-site. If they are inside the workspace, they need to be considered for collision avoidance and may be updated during the construction process.
As-Designed	The original design of the components. The information is used by human co-workers and robots to understand as-designed versus as-built deviations and develop plans accordingly.
Virtual Collision	The space that is not physically occupied but the robot needs to avoid during the movement (e.g., a safety laser curtain that marks the edge of the work zone). The robot considers it for collision detection during motion planning.

- **Robot operation support.** Adding information to support robot operation in the BIM can facilitate HRCC work. The information added depends on the task type and robot intelligence level. For example, robots can determine how to grip objects by visually detecting object geometry in some cases, but for some objects with irregular shapes, external guidance can increase the success rate of object gripping.

It should be noted that, although being manually created in this study, some of the abovementioned information has a high potential to be automatically generated by the computer or the robot. For example, [71] proposed an approach for automatically generating steel erection sequences and [72] used convolutional neural network and large-scale robot grasping experiments to generate robot

grasping plans. [73] used computational design to generate the cutting planes, gripping planes, and connections for off-site frame prefabrication. This research focuses on how to leverage such information for HRCC; manual addition is thus sufficient for this study.

3.2 BIM-Driven HRCC Framework

Five elements are included in the proposed framework for BIM-driven HRCC: 1) the BIM that provides and saves data about the construction project; 2) the Graphical User Interface (GUI) that supports both immersive VR and 3D options for human workers to interact with the robot; 3) ROS as the middleware for communication and the central unit for data processing, computing, and construction work process and physical robot control; 4) ROE, which is the construction site that includes robots, sensors, and materials; and 5) human workers who supervise the construction process and intervene when necessary. In this study, Rhino 7 is used as the BIM platform, and the GUI is developed in Unity with Oculus Rift S as the headset for the immersive VR option.

The information flow among system elements at different stages is shown in Figure 4. To prepare for construction, human co-workers need to physically set up the construction site and configure the BIM data (Section 3.2.1). When construction starts, information is taken from both the BIM and the construction site to generate the I2PL-DT (Section 3.2.2). During the construction process, human co-workers bi-directionally communicate with the robot through ROS, which also integrates information from the BIM and the construction site, to supervise and intervene in the construction process (Section 3.2.3). After information fusion and processing, ROS controls the real robot to conduct construction work.

Occasionally, human co-workers need to physically intervene (e.g., replace a component with one of a different shape) to resolve uncertainties on the construction site. When construction completes or reaches a certain checkpoint, the ROS environment that contains the related construction site information at the time sends the information to update the BIM repository and records data in the BIM for future reference (Section 3.2.4). It must be noted that even though this study chooses to update the BIM at certain time points, the framework also allows the BIM repository to be continuously updated as construction progresses. Next, the technical details of each stage are discussed.

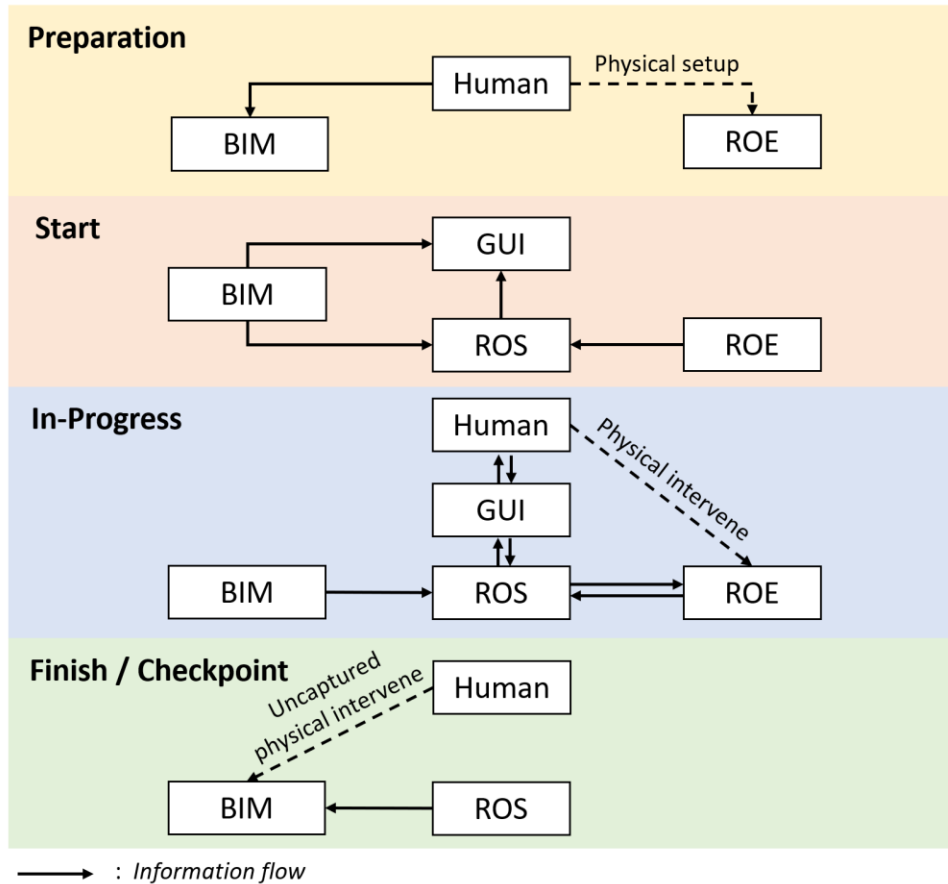

Figure 4 System Information Flow at Different Stages

3.2.1 Construction Preparation

Setup activities are needed both physically on the construction site and digitally in the BIM. In general, workers need to start the sensors that are in use (e.g., cameras, LiDARs) on the robot or construction site for the robot to perceive the environment. They also need to place the required construction materials in the robot workspace for the robot to reach and manipulate. Lastly, workers need to assign tasks to the robot in the BIM (e.g., by selecting some drywall panels on the frame and placing them onto the “Target” layer). They should also adjust components’ status in the BIM according to the task scope (e.g., by marking components that are outside the robot workspace as “unrelated”). Considering that a BIM interface is intuitive and generally familiar to construction personnel, it is typically easier for workers to indicate task scope in a BIM rather than directly indicate this to the robot in ROS.

3.2.2 Start of Construction

To begin the construction, the digital twins that integrate visualization, interaction, and computation functions need to be generated. There are two digital twins in the system. One is the interaction module in the GUI developed in Unity to support visualization, supervision, and intervention. The other is the computation module in ROS that controls the construction workflow

(e.g., installation sequence), adapts to as-built conditions, and generates task plans (e.g., collision-free motion plans). The automated generation process of the digital twin system is shown in Figure 5.

The highlight of this process is that instead of manually importing a BIM and creating functions in Unity for different construction projects, a Unity program template is developed. It contains template models with functions. When it receives information from other modules (e.g., a BIM), Unity can quickly generate interactive game objects using these template models. For example, when it receives an object on the “Target” layer from a BIM, it will instantiate a target-type template game object that is attached with functions for user selection and movement, load the mesh geometry received from the BIM onto the game object for visualization, and change the game object attributes such as name, layer, and material accordingly. As a result, the template Unity program can automatically generate interactive digital twin interfaces for different BIM projects.

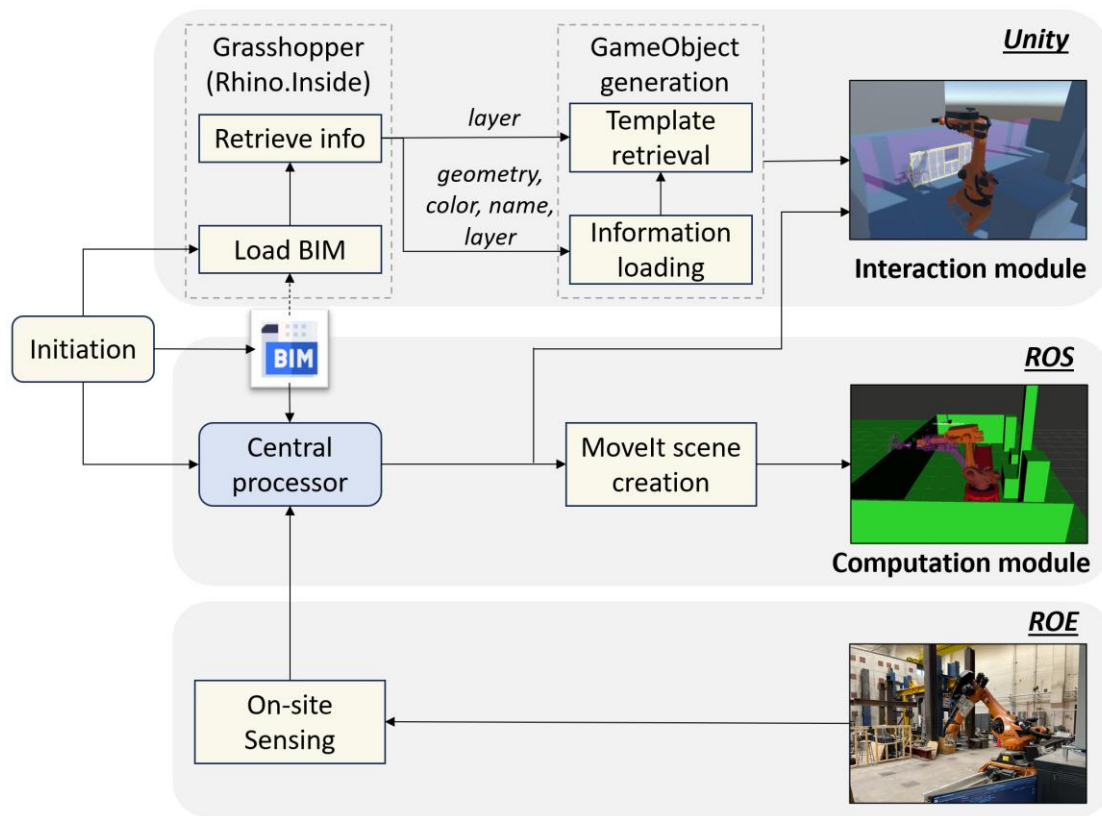

Figure 5 Automatic Digital Twins Generation Process

At the initial state, Unity contains 1) light and camera systems for human partners to visualize objects in the game interface; 2) event systems to capture user input and enable interaction (e.g., selection, moving); 3) virtual robot models generated from the Unified Robot Description Format (URDF) files and meshes from ROS. One virtual robot is synchronized with the actual robot for supervision. The other one is used to evaluate robot motion plans and only appears when the human

workers preview plans; 4) ROS connectors to exchange data with ROS through Rosbridge using the ROS# library [74]; 5) game objects to run Rhino and Grasshopper projects to retrieve geometry and attribute (e.g., layer, name, type) data from the BIM; 6) model templates that can automatically generate interactive game objects with the information received; 7) interface templates that appear at specific times to prompt and receive user input; and 8) a virtual billboard to show messages.

As the system is initiated, connections between ROS, Unity, ROE, and the BIM are established (Figure 5). Rhino and Grasshopper applications also start with the Unity program through Rhino.Inside [75]. Grasshopper then loads the BIM into Rhino, retrieves information (i.e., geometry, color, name, layer) of objects from the BIM, and sends it to Unity. As Unity receives the information, model templates can create game objects with the same names, colors, and geometry as what they received from the BIM. The generated game objects are automatically placed onto the corresponding layers in the GUI. Based on the object layer, scripts that contain different functions are embedded in the model templates and attached to the object, thereby creating different interaction patterns. Information from the BIM is also sent to ROS through Rosbridge. Task-related objects on the “As-Built”, “Materials”, and “Virtual Collisions” layers are loaded into MoveIt (a motion planning framework integrated into ROS [76]) for collision detection. Lastly, as-built components and materials are sent to Unity to reflect the most up-to-date construction environment to the human co-worker. With these steps accomplished, the digital twin systems are completely generated and construction can start.

3.2.3 Construction In-Progress

The process of construction is shown in Figure 6. Human operations and decisions are shown in orange, and blue elements show processes performed by the robot. The robot and its human co-workers interact through the GUI. The overall workflow is that the robot shows information and decisions intuitively in the GUI for its human co-workers to visualize. Then, the GUI detects the human co-workers’ decisions and operations through their input and sends the information to the robot. During the interaction process, corresponding interfaces are generated from the interface templates to prompt the human co-workers on the current process and get inputs. The templates contain corresponding functions (e.g., sending messages to the robot on certain ROS topic channels when the user clicks certain buttons) and are automatically connected to corresponding scene objects when being generated.

After generating the digital twins, the robot retrieves the next target in the construction sequence from the BIM, highlights the target object in the GUI, and asks the human co-worker to confirm the target. If not in agreement, the human co-worker can select another target. After a target is confirmed, the robot checks whether there are deviations in the workspace that affect the operation to achieve the target as originally designed (e.g., a deviated component occupying the target space will collide with the target if following the original design). If there is a deviation, the robot will propose suggestions to adapt. The specific approach for the human-robot work team to adapt to deviation is introduced in the Case Study (Section 5.3). Otherwise, it will go ahead with the original installation pose from the BIM. The human co-worker can choose to directly accept the robot’s suggestion (e.g., an adjusted pose to install the target). There might be situations where the

robot cannot properly adapt, so the system also allows the human co-worker to improvise an adaptive plan (e.g., move the target to indicate a desired installation pose in GUI or directly install the component by themselves).

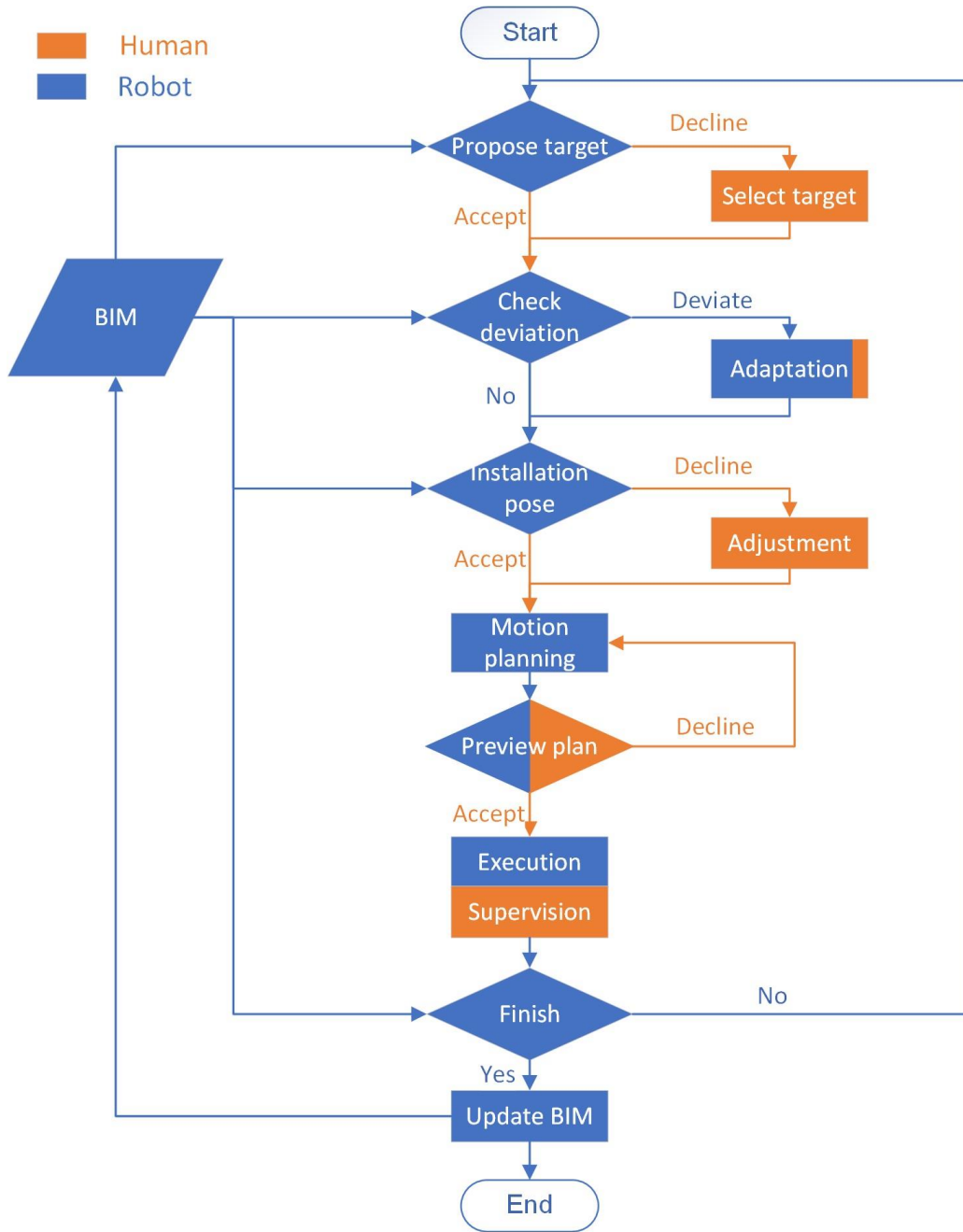

Figure 6 Collaborative Construction Process Flow Chart

Next, based on the confirmed plan, the robot generates a collision-free motion plan to achieve the target. When the human co-worker requests to preview the plan, a virtual robot will appear in the GUI and demonstrate the motion plan as an animation. Such previewing processes allow human co-workers to gain insights into the consequences of the robot operation and make better decisions

[77]. If the human co-worker is not satisfied with the motion plan, the robot will generate another plan with MoveIt and demonstrate it in the GUI until the human co-worker finds an acceptable plan. After a motion plan is accepted, the actual physical robot executes the approved plan.

Since a robot model in GUI is synchronized with the actual robot, the human co-worker can supervise the robot execution states through this synchronized robot. They can also understand the robot's cognitive status (e.g., calculating the motion plan) through the virtual billboard in the GUI. It should be noted that certain steps of processing and robot operation can be skipped, depending on the type of human intervention. The technical approaches for establishing connections within the digital twin system and achieving motion planning, plan preview, and execution and supervision functions are discussed in [29]. After a target is achieved, the system will check the next target in the sequence from the BIM and go through the process again. If no target is left in the queue, the assigned task is considered to be finished.

3.2.4 Construction Completion or Reaching a Checkpoint

When an assigned construction task finishes or reaches a certain checkpoint, three sources of data tracked by ROS can be sent to the BIM via Rosbridge using the COMPAS library [78]. The workspace sensing data as the robot scans the environment and the robotic construction data reflected by robot states are saved onto the “As-Built” layer. The temporary material data (i.e., on-site construction material type, number, and locations) are saved onto the “Materials” layer. It is inferred from the start state (e.g., materials originally prepared) and the construction process (e.g., how many materials are used). These three sources of data are saved in the BIM repository for future reference. In the ensuing steps, the repository will continue updating itself with incoming sensing data and completed construction work.

3.3 Physical System Deployment

The physical portion of the system is deployed on a large-scale Kuka industrial robotic arm in a research laboratory setting designed to mimic a construction site. The industrial robotic arm is selected because it has a relatively large payload to manipulate heavy construction components and higher flexibility to perform various construction tasks with different tools. The assumption is that the robot has a relatively static workspace (e.g., an area in a room) for each construction task. Other workers and equipment conduct construction activities and move outside the robot workspace. For safety reasons, if they get into the robot workspace during the robotic construction process, the robot will stop moving until safety is confirmed by its human co-worker.

The system involves several devices connected to a Local Area Network (LAN). Devices can communicate with each other through wired connections or wirelessly. The system framework for device communication and robot control is shown in Figure 7. The interfaces that the human co-worker directly uses, including the GUI in Unity and the BIM in Rhino, need to run on a computer with Windows OS. The sensors are connected to portable microcontrollers (e.g., Raspberry Pi). Both the Windows computer and microcontrollers can communicate with ROS wirelessly through a router on the LAN via ROS messages. ROS runs on a computer with Ubuntu OS that is connected

to the robot embedded PC through an Ethernet cable. The computing core in ROS sends the joint states to the Automation Device Specification (ADS) interface of the programmable logic controller (PLC) [67]. ADS is an interface layer of Twincat PLC that allows commands and data exchange between different software modules [79]. The joint states data is received by the PLC and is then sent to the Kuka Robot Sensor Interface (RSI) to control the robot [67].

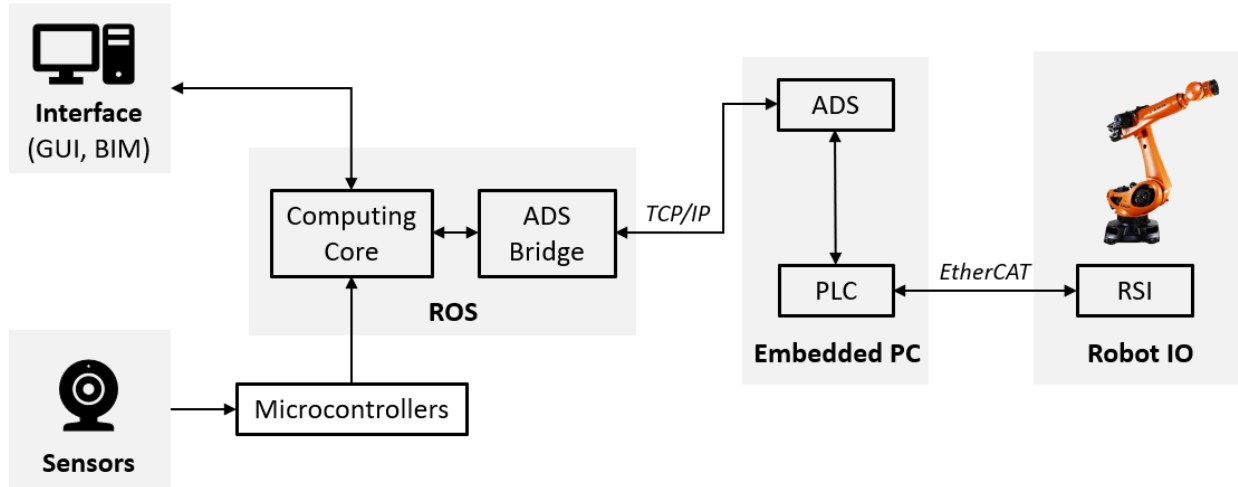

Figure 7 Physical Robot System Framework

4 SYSTEM VERIFICATION EXPERIMENTS AND RESULTS

Block pick-and-place experiments that involve a line of four blocks are conducted to verify the proposed workflow. The BIM repository of the system and the physical experiment setting are shown in Figure 8. Four wood blocks are stacked on the ground floor. A stud is used to represent a nearby object, possibly installed in earlier construction states. The blocks are expected to be placed in a line adjacent to the stud. The robot first scans the environment to localize the block stack and stud. Then, it needs to first pick up a wood block from the stack of blocks and place it alongside the stud placed on the ground. If the robot finds the stud takes up the space for the planned block placement target, it will suggest offsetting the block placement target to avoid collisions. If the stud does not occupy the space of the blocks, the robot will follow the original plan and will not automatically make adjustments, unless instructed by the human supervisor.

In order to increase system tolerance to errors and prevent damage to experiment materials and the robot, gaps of different sizes (10 mm, 5 mm, 3 mm, and 1 mm) are left between blocks. The gripper releases and drops the block 2 mm above the ground floor. For each gap size, 10 trials of picking and placing all four blocks were carried out. The wood stud was deliberately placed in collision with the planned target for 5 out of the 10 trials to test the robot's capability to resolve deviation. The robot is operating at 7% of its full speed.

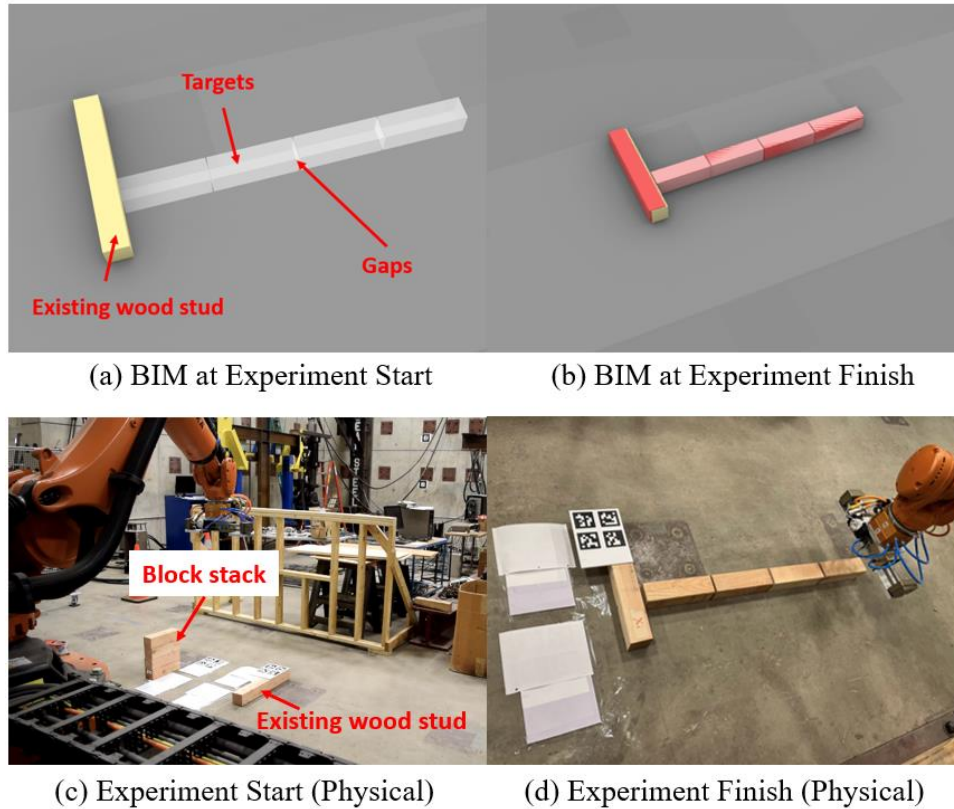

Figure 8 Experimental Settings

During the experiment, the human co-worker interacts with the robot through the 3D interface. The goal of this experiment is to verify the overall performance of the proposed system when the human workers completely rely on robot suggestions. Therefore, the human co-worker agrees with all robot suggestions and does not perform any adjustment or manual intervention during the construction process. However, when the co-worker feels the robot planned manipulation trajectory is not optimal (e.g., taking extra rotations), the co-worker would request the robot to generate a new motion plan for evaluation. The number of replanning requests from the human co-worker is recorded. The trial is counted as a failure if the robot does not place all four blocks successfully. The success rate and the number of replanning requests for different gap sizes are shown in Table 2. “Successful placements” means the number of blocks successfully placed by the robot without any collision. Once a block fails, the trial ends and the rest of the blocks in the four-block line are not placed. On average, a successful pick-and-placement trial of four blocks takes 217.31 seconds. 56.38 seconds are used for human co-worker’s decision-making, such as confirming the target and previewing the motion plan. The average time taken by robot computation and execution is 160.93 seconds.

Table 2 Block Pick-and-Place Experiment Results

Size of gap	Success rate (%)	Replan request / Successful placements	Reason for failure (occurrence)
10 mm	100	7 / 40	
5 mm	90	2 / 38	Hit ground (1)
3 mm	90	6 / 36	Collide with stud (1)
1 mm	60	5 / 26	Collide with stud (3) Hit ground (1)

5 SYSTEM VALIDATION AND CASE STUDY

In order to validate the proposed system and explore the setup needed to physically deploy the system, a drywall installation case study is conducted in a research laboratory, which is set up to mimic a construction site, as a proof-of-concept implementation. In this context, the wall frame itself is prefabricated without deviation but is purposefully installed at a deviated pose on-site. Four drywall panels in two different shapes need to be installed onto the wall frame. The remaining part of this section introduces the physical and software setup and describes the HRCC process to perform the drywall installation task in detail.

5.1 Physical Setup

The robot used for the case study is a 6 DOF Kuka KR120 industrial robotic arm that has a 120kg payload and a 2.7m reaching range. By mounting it onto Kuka KL4000 Linear Unit, its base can move 4.5m linearly, which adds one DOF to the robot and significantly increases the robot's physical reach. Therefore, the robot has the capability to manipulate a regular-sized drywall panel. The robot workspace is shown in Figure 9. A safety gate is used to mark the robot workspace and a laser curtain is installed on the safety gate to prevent other workers and equipment from entering the robot workspace.

Since the goal of the case study is to verify the capability of the system framework and functions, the experiment is conducted on a 1:4 scale. A wall frame 4 feet (1.2192 m) tall by 8 feet (2.2384 m) long with a window area is built with studs on the back side to ensure stability (Figure 10). To expand the workspace, part of the frame support is placed outside the gate, but it does not break the operation because it is lower than the bottom of the curtain. The robot needs to install three larger drywall panels of 2 feet (0.6096 m) by 4 feet (1.2192 m) and one smaller panel of 2 feet (0.6096 m) by 2 feet (0.6096 m) onto the frame. A cubic handle is attached to each panel for the robot to grip. A pneumatic gripper is designed and connected to the robot with a tool changer and a connection plate (Figure 11). The jaws of the gripper are made with slopes to clutch the cubic handle on the drywall panel. Stabilizers are installed to ensure that the drywall panel can fully contact the gripper to avoid torque and shaking during manipulation. Rubber pads are used to add friction between the gripper and the cubic handle to prevent slippage.

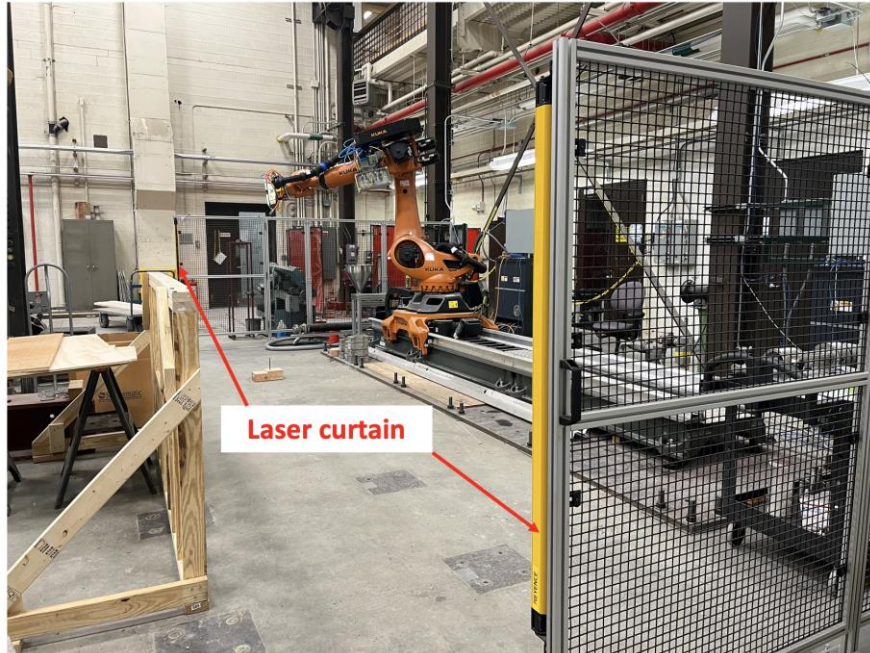

Figure 9 Robot Workspace

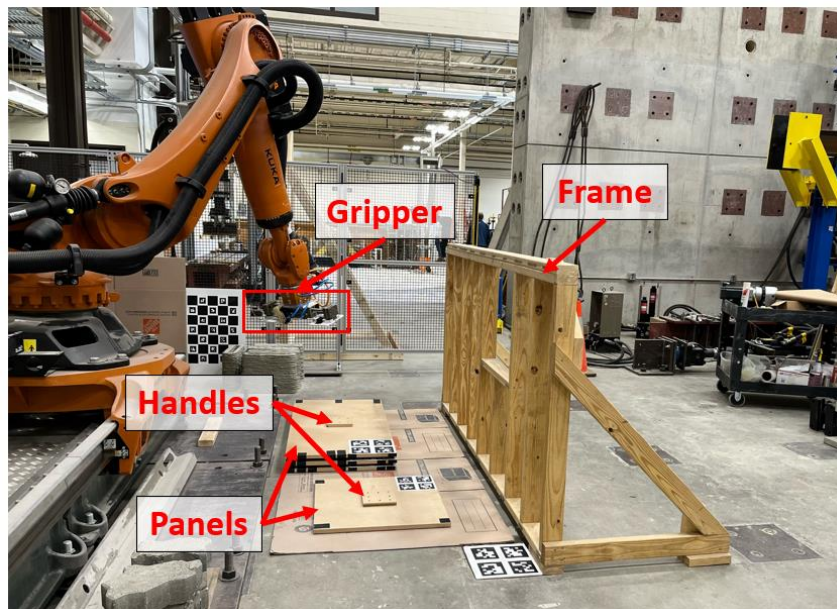

Figure 10 Wall Frame and Drywall Panels Used in Case Study

Given that only one robotic arm is deployed, for demonstration and experiment repeatability, Medium-Density Fiber (MDF) boards with higher durability are used as drywalls. Magnets are used to attach the panels to the wall frame after the robot releases the panels. For actual construction work, the panels could be fixed (typically with screws) onto the wall frame, potentially by a human worker or another robot. AprilTag fiducial markers are installed near the

wall frame and on the panels for the robot to localize the 6 DOF pose of the components [80]. An RGB camera is fixed onto the gripper. It is connected to ROS running on a Raspberry Pi microcontroller powered by a portable battery. Raspberry Pi can send the camera sensing data as ROS messages wirelessly to the ROS master running on the Linux machine.

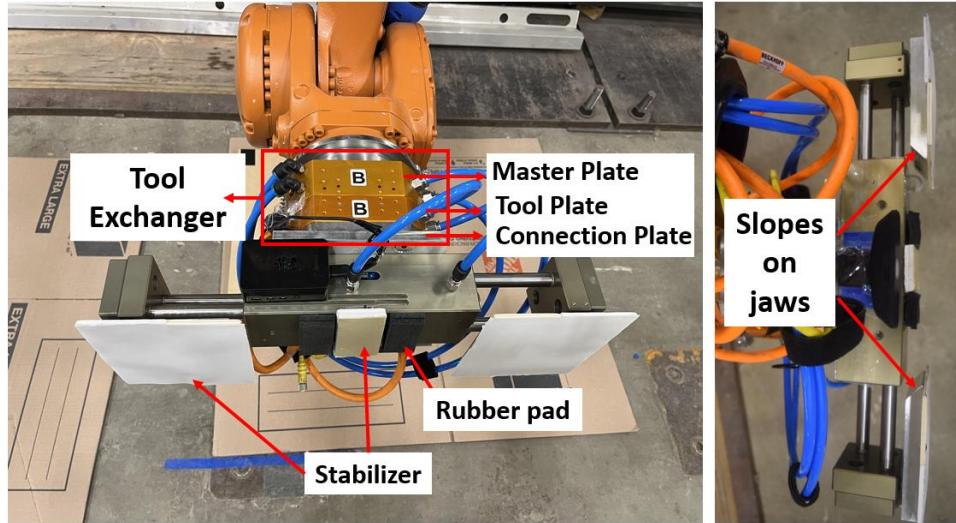

Figure 11 Gripper Design

5.2 Preparation of the BIM

Figure 12 shows a screenshot of the BIM used for the drywall installation task. The surrounding wall of the laboratory is set to be transparent grey to make it easier to visualize the robot workspace. Shop drawings for drywall installation are shown at the right bottom of the figure. The BIM indicates how the panels are designed to be installed. In this drywall installation task, these panels are specified as targets. The laser curtain is the plane that lasers come through which does not physically exist. However, interruption of the laser will cause the robot to stop for safety reasons, so the robot should not get into the curtain during operation. Thus, the laser curtain is considered a collision object during robot motion planning. The BIM components and their corresponding layers are shown in Table 3. Before construction, the frame has already been installed and materials are prepared but their poses are unknown and need to be detected by the robot.

Table 3 The BIM Components List

Components	Layers
Workspace surroundings (Blue)	As-Built
Frame (Design) (Yellow)	As-Designed
Target panels on frame (Design)	Target
Laboratory walls, beams, and columns	As-Built
Laser curtain (Virtual)	Virtual Collision

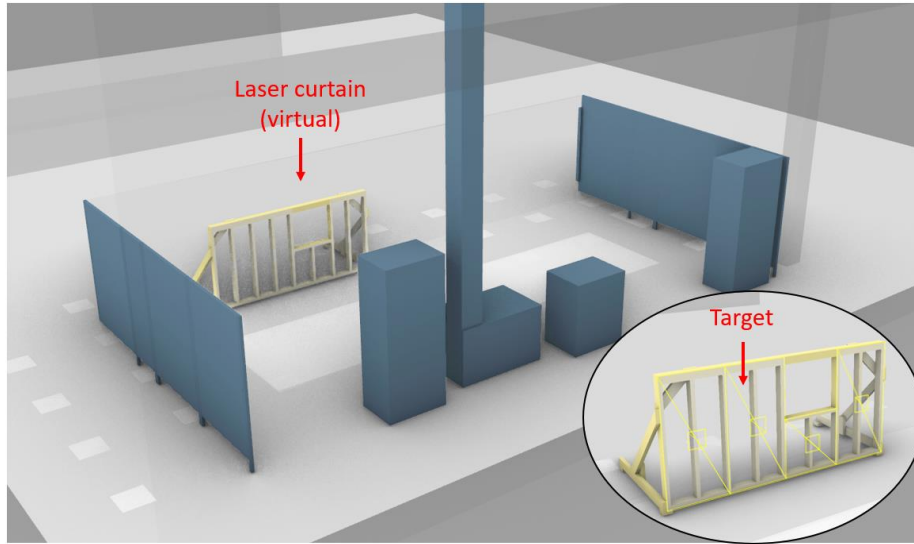

Figure 12 The BIM for Drywall Installation

The BIM contains the component attribute needed for robot processing and construction, such as its identifier, layer, its relationship with other components, whether it is related to the current task, construction sequence, and type (e.g., large or small) (Figure 13). For manipulable components, how the robot should grip the component is also indicated (e.g., at its center with orientation perpendicular to its largest surface), which is also used as the indicator of robot picking and installation pose. In this study, the program automatically calculates pose indicators using the centroid of the Rhino object. Otherwise, pose indicators can be automatically generated with computational design or human workers can indicate them by selecting points and directions in Rhino.

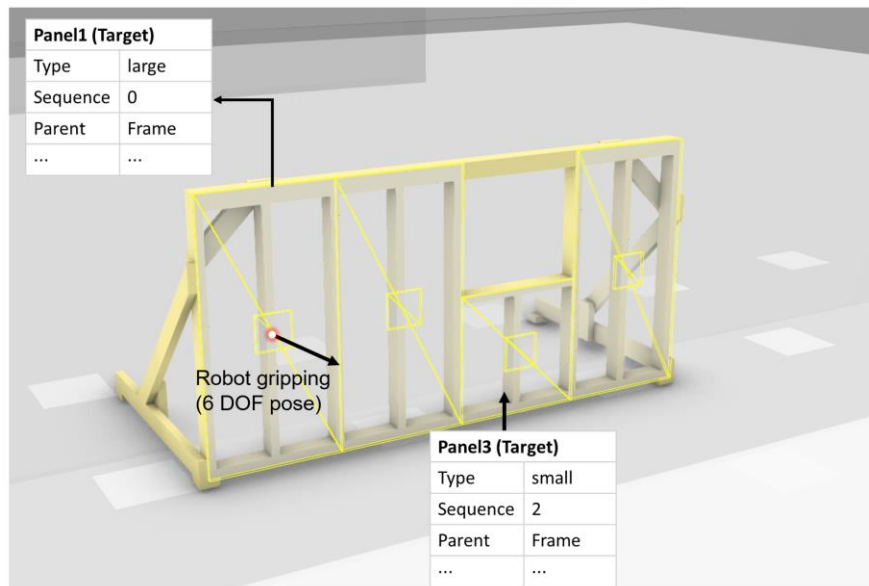

Figure 13 Attribute Information in the BIM to Drive Robotic Construction

5.3 Adaptation to Deviations

Two types of deviations are considered in this case study, which mainly focus on the pick-and-place type of tasks:

- **Parent deviation:** The parent of the target deviates. Since the target needs to be connected to its parent, the installation pose of the target should be adjusted accordingly. The robot first calculates the design-built deviation T_D^B of the parent using $T_D^B = T_D^{-1}T_B$, where T_D is the as-designed transformation of the parent the robot received from the BIM and T_B is the as-built transformation of the parent the robot detected with its camera. Next, the robot calculates the suggested installation transformation T_t to install a target t using $T_t = D_t T_D^B$, where D_t is the as-designed transformation of the target. Lastly, the installation transformation matrix T_t is converted into an installation pose P_t for robot planning and operation.
- **Nearby object deviation:** When some objects near the target are built with deviation, they might occupy the originally planned space of the target. While deciding the target installation pose, the robot checks whether the planned installation place collides with any as-built objects. If no collision is detected, the robot will go ahead with the original plan. Otherwise, the human co-worker can choose to take the robot's suggestion to offset the target installation pose to avoid collision. However, offsetting one component may affect the installation of subsequent targets, causing plan changes for several targets. Therefore, another operation is provided for the human co-worker to manually replace the target with one in a different shape (e.g., a smaller piece), skip the installation in the digital twin, and record the operation in the BIM. Human intervention can resolve more complex deviation cases and provide solutions that do not affect the subsequent targets.

5.4 Construction Process

To prepare for the construction work, the drywall panels are placed into two stacks in the robot workspace (Figure 10). There is a marker on each panel and the wall frame. Offsets from the markers to the objects' pose indicator points are recorded and input into the system. The marker is not only used for pose estimation but also provides configurable attribute information (e.g., corresponding object type and quantity).

As construction starts, the robot follows a predefined trajectory to scan the environment. After scanning, the robot replaces the as-designed wall frame with the as-built one in the MoveIt planning scene. In the meantime, material poses are inferred from the detected stack location, quantity, and type data attached to the marker. The materials are also added to the MoveIt planning scene as collision objects. When the robot plans motion with materials in hand, the collision object of the corresponding material is attached to the robot end-effector to ensure that the material held by the robot does not collide with the environment or the robot itself. The as-built wall frame and materials are also sent to Unity to be generated in GUI to support user visualization and decision making.

The robot first highlights the next drywall target in the construction sequence in the GUI and asks for the human co-worker's confirmation or adjustment (Figure 14a). After the human co-worker confirms the target, the robot uses the as-built and as-designed deviation of the wall frame to calculate a suggested drywall installation pose. Visualization of the suggested pose is then generated in GUI for the human co-worker's approval or adjustment (Figure 14b). Either in VR or in 3D mode, human co-workers can adjust the camera view to inspect the environment from the perspectives they prefer, while VR offers a more natural and intuitive sight of view control. A video demonstrating the adjustment process can be found at: <https://youtu.be/3f5JEeAYyXI>.

After the installation pose is approved, the robot generates the motion plan to first pick up a corresponding type of panel (i.e., large or small) from the detected panel stacks and then places it with the approved installation pose onto the wall frame. Upon request from the human co-worker, a virtual "planning" robot manifests in the GUI and demonstrates the robot motion plan and how the panel is manipulated during the installation process for evaluation (Figure 14c). If the motion plan is approved, the physical robot executes the plan, and the human co-worker can supervise the robot execution process with the synchronized robot and understand the robot status from the messages in the GUI (Figure 14d). After the robot releases the panel, the panel is attached to the wall frame with magnets, and the virtual panel in Unity is changed to the "As-built" layer.

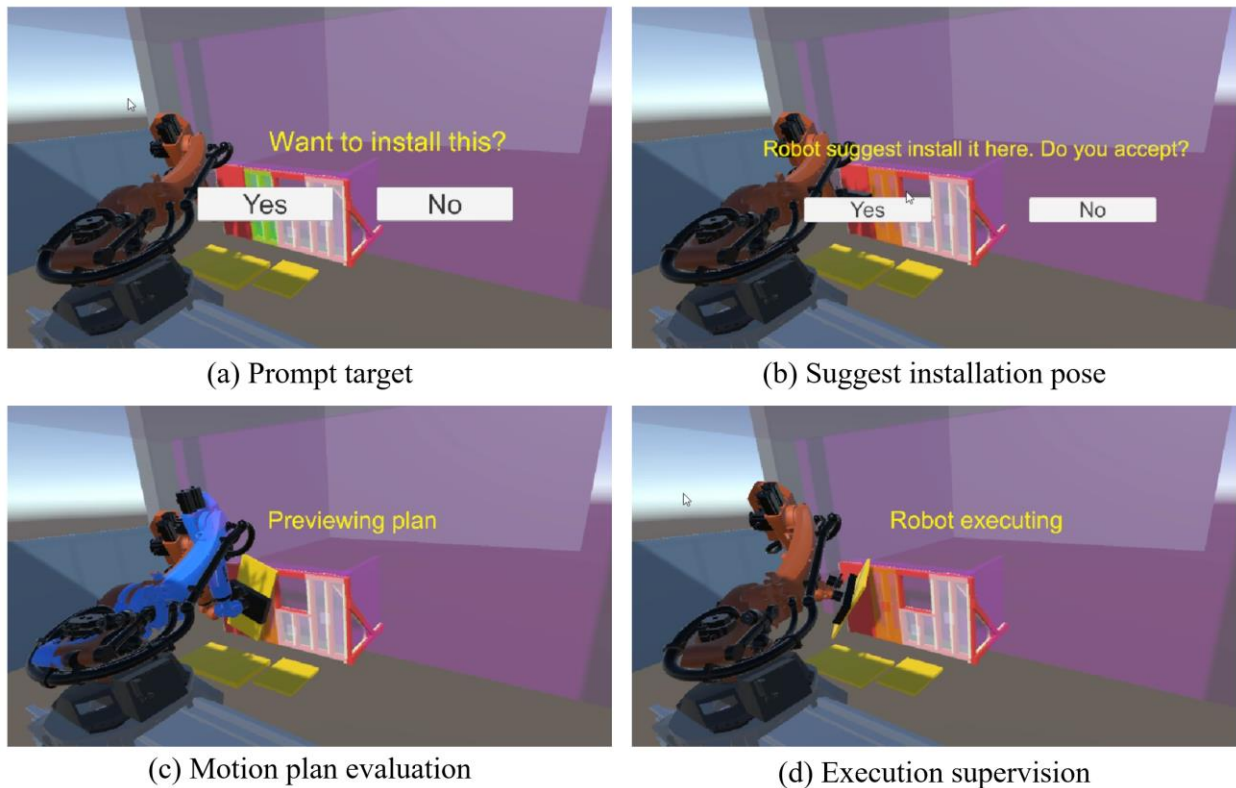

Figure 14 Screenshots of the HRCC Process

The actual installation pose is recorded by the robot and the robot prompts the next panel in the sequence for installation. The quantity of materials in the corresponding panel stack is reduced by

one, and the position for the robot to reach the next piece of panel in that stack is updated accordingly. These procedures are repeated until all four pieces of drywall panels are installed. The snapshots of the physical robot drywall installation process during the laboratory experiment are shown in Figure 15. A video demonstrating the process can be found at: <https://youtu.be/h1f0qDF189Q>. The robot is operating at 3% of its full speed.

After all the panels are installed, the as-built condition of the wall frame is sent from ROS to Rhino through Rosbridge using COMPAS as the workspace sensing data [78]. The recorded installation poses of all panels are also sent to be saved in the BIM as the robotic construction data. Both the workspace sensing data and the robotic construction data are saved onto the “As-Built” layer. Lastly, the up-to-date conditions of the panel stacks are sent to Rhino and saved onto the “Material” layer to reflect the quantity and location of the remaining panels on-site. The updated scene in the BIM is shown in Figure 16.

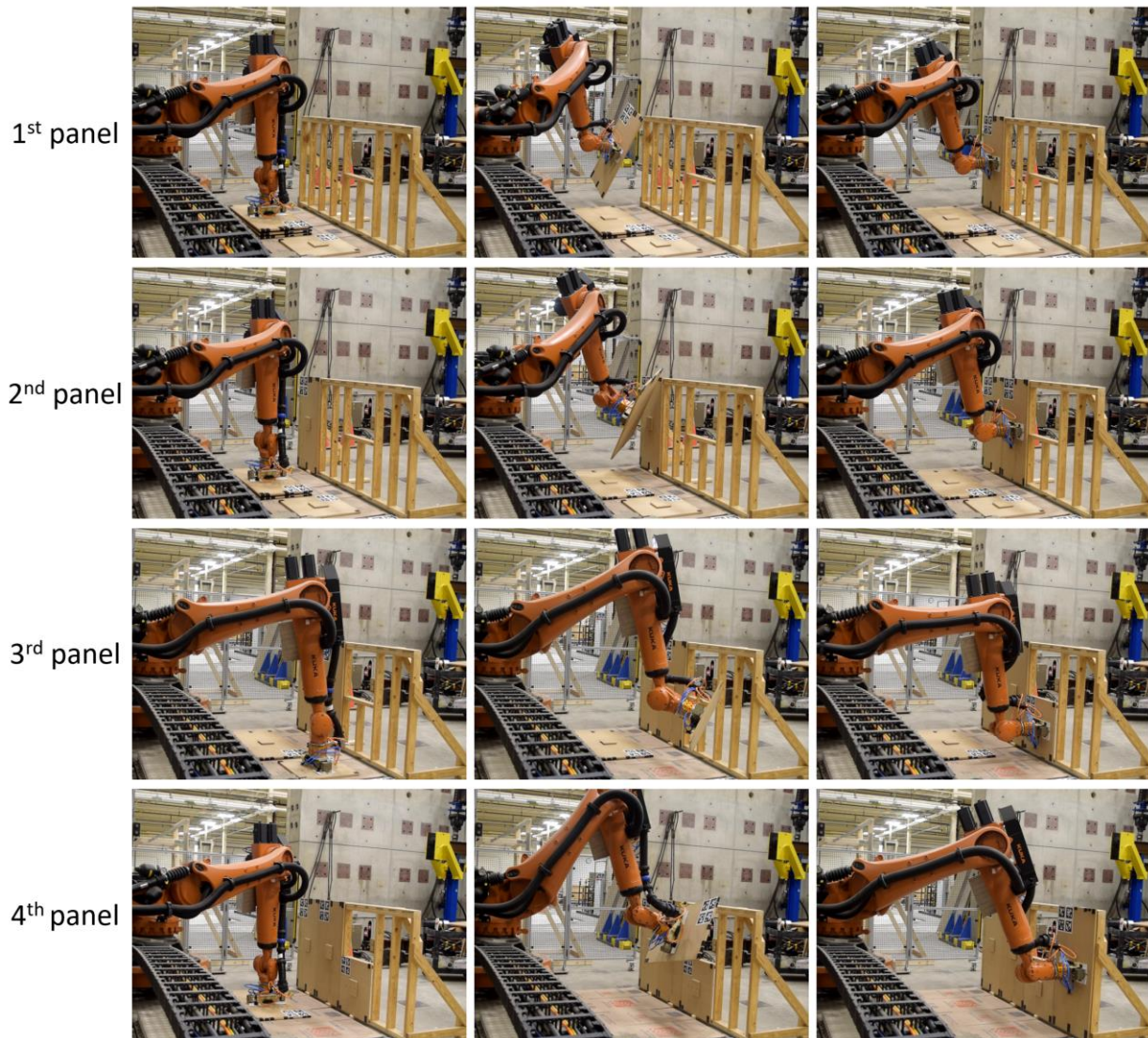

Figure 15 Snapshots of Physical Robot Drywall Installation Process

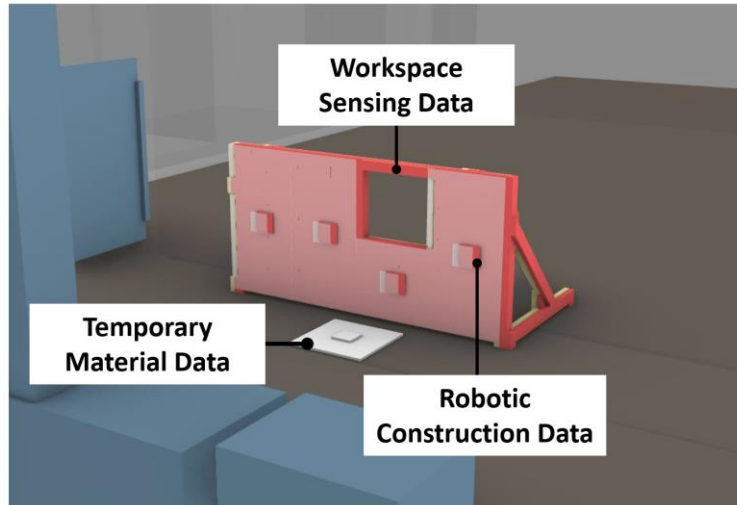

Figure 16 The Updated BIM

6 DISCUSSION

In order to successfully perform the construction work with the proposed system, the robot needs to adequately localize components in the construction environment, make decisions and suggestions to adapt to uncertainties, and accurately reach specific positions and manipulate components. Errors in any of these aspects will disrupt the workflow. In Section 4, a block pick-and-place experiment is conducted to verify the performance of the proposed workflow. It is observed that once the first block is placed, the rest of the blocks are placed without collision with each other. It indicates that the robot makes good decisions to make adaptations and find the appropriate pose to place the target, and it executes the plan with high precision. Most failure cases are caused by the first block colliding with the stud while being placed (Figure 17). There are also two cases of failure where the blocks were moved too close to the ground and the robot sensed excessive force on its end-effector. These failures are caused by errors in component localization.

In both the case study and experiment, AprilTag markers are used for component localization, which is a low-cost and easy-to-deploy solution that provides relatively high localization accuracy and is robust to various environmental conditions [81,82]. However, it still introduces certain localization errors, which can lead to collisions when the tolerance is very low. For example, in the drywall installation case study, the panel cannot be firmly held onto the frame if a minor gap between magnets exists. Since the marker is installed on one end of the frame, orientation errors in marker detection are amplified by the long distance and cause a larger position offset when installing the panel on the other end of the frame. This results in task failure in some cases during the implementation process. Fortunately, with the evolving object detection algorithms and hardware (e.g., LiDAR) [83,84], the accuracy of component localization is increasing to meet the needs of precise construction tasks.

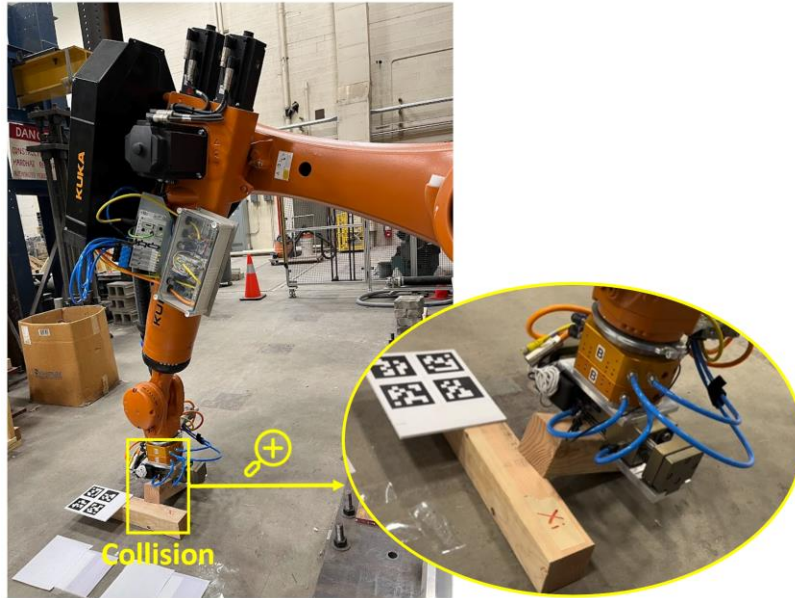

Figure 17 Collision with Stud during Block Placement

Considering the visual localization error, the success rate of the block pick-and-place experiment is found to be particularly high. Several reasons may lead to this result. First, all the blocks are stacked at one location, and thus the same offsets are maintained for all blocks. Therefore, collisions between blocks are avoided provided that the digital twin system successfully adapts to the nearby object deviation. Second, the gripper compensates for certain localization errors when closing the jaws to grab the block at its horizontal center. Third, only the localization error in a certain direction can cause task failure. For example, the block will only collide with the stud if the stud is in the way of the block target pose but the robot thinks the stud is still far away and does not make any adjustments to avoid the collision. Fourth, the robot drops the blocks onto the ground at a height of 2 mm, which increases the vertical tolerance of the task. Even if the robot drops the block from a slightly higher or lower position, the block placement is still considered successful.

During the physical experiment, several limitations are observed, and future research directions are identified. First, as discussed above, although the robot can localize objects with up to millimeter-level accuracy, it is not sufficient for some construction tasks that require high precision. It also takes time to set up and for the robot to scan fiducial markers on all related components in the workspace. A more direct and precise approach for the robot to perceive the environment and continually track components should be considered in the future.

Second, because of the laboratory condition, only one robotic arm is used, and the panels are grabbed by a 2-jaw gripper in the drywall installation case study. One more robotic arm can be included to fasten panels onto the wall frame, and a vacuum gripper can be used to grab panels so that cubic handles are not needed.

Third, information to support robotic construction, such as robot gripping pose and construction sequence, is manually created in the BIM. Future work should integrate computational design into

the system, which can automatically generate detailed digital fabrication information, construction sequence, and gripping plans for components [85].

Lastly, some motion plans generated by the robot are valid but not desirable, and replanning is preferred. Sometimes, the robot manipulates material extremely close to other objects on-site. While no collision occurs, these situations cause high mental stress on human co-workers when the workpiece is large. Future studies may consider applying force feedback control and reinforcement learning for more trustworthy and desirable component manipulation [86,87].

7 CONCLUSIONS

This study proposes a BIM-driven HRCC workflow that addresses technical solutions ranging from the preparation stage to the end of the construction work, enabled by a closed-loop digital twin framework. The proposed framework offers several significant improvements to the previous I2PL-DT as well as other independent contributions. First, it presents a BIM framework that supports HRCC. The BIM contains the attribute and geometric information human workers and robots need for construction, and the predefined layer structure provides a unified standard to interface different BIM projects with the interactive digital twin, thereby improving BIM interoperability. Second, an automatic approach for generating interactive digital twins for HRCC is proposed, which is enabled by a template-based Unity program and the predefined layer structure in the BIM. Third, this study introduces an approach for component placement deviation adaptation using a combination of as-designed data from the BIM and perceived as-built information. Lastly, the construction site as-built information is sent to the BIM to be recorded, forming a closed-loop system. By closing the loop, the BIM is updated with as-built data to support decision-making and automation in subsequent construction, operation, and maintenance of a facility.

Physical experiments are conducted to identify the effort needed to enable a physical construction robotic system, verify and validate system performance, and recognize limitations for future improvements. Overall, through the integration of the BIM, the proposed system not only improves construction work quality but also increases the robot's capability in lower-level task planning thereby reducing human workers' planning efforts.

ACKNOWLEDGMENTS

The authors would like to acknowledge the financial support for this research received from the U.S. National Science Foundation (NSF FW-HTF-P #2025805 and FW-HTF-R #2128623). Any opinions and findings in this paper are those of the authors and do not necessarily represent those of the NSF.

REFERENCES

- [1] E. Escamilla, M. Ostadalimakhmalbaf, B.F. Bigelow, Factors Impacting Hispanic High School Students and How to Best Reach Them for the Careers in the Construction Industry, *Int J Constr Educ Res.* 12 (2016) 82–98. <https://doi.org/10.1080/15578771.2015.1077296>.

- [2] S. Park, H. Yu, C.C. Menassa, V.R. Kamat, A Comprehensive Evaluation of Factors Influencing Acceptance of Robotic Assistants in Field Construction Work, *Journal of Management in Engineering*. 39 (2023). <https://doi.org/10.1061/JMENEA.MEENG-5227>.
- [3] R. Aulin, M. Jingmond, Issues confronting women participation in the construction industry, *Advances in Engineering and Technology-Contribution of Scientific Research in Development*. (2011) 312–318.
- [4] Z. Zhang, K.Y. Lin, J.H. Lin, 2SAFE: a health belief model-integrated framework for participatory ergonomics, *Theor Issues Ergon Sci*. 24 (2023) 281–298. <https://doi.org/10.1080/1463922X.2022.2083716>.
- [5] S. Kim, S. Chang, D. Castro-Lacouture, Dynamic Modeling for Analyzing Impacts of Skilled Labor Shortage on Construction Project Management, *Journal of Management in Engineering*. 36 (2019) 04019035. [https://doi.org/10.1061/\(ASCE\)ME.1943-5479.0000720](https://doi.org/10.1061/(ASCE)ME.1943-5479.0000720).
- [6] J. Cai, A. Du, X. Liang, S. Li, Prediction-Based Path Planning for Safe and Efficient Human–Robot Collaboration in Construction via Deep Reinforcement Learning, *Journal of Computing in Civil Engineering*. 37 (2023). [https://doi.org/10.1061/\(asce\)cp.1943-5487.0001056](https://doi.org/10.1061/(asce)cp.1943-5487.0001056).
- [7] AGC, 2022 Construction Outlook National Survey Results, 2022.
- [8] C. Brosque, J.T. Hawkins, T. Dong, J. Örn, M. Fischer, Comparison of on-site and off-site robot solutions to the traditional framing and drywall installation tasks, *Construction Robotics*. 7 (2023) 19–39. <https://doi.org/10.1007/s41693-023-00093-8>.
- [9] B. Fu, W. Smith, D.M. Rizzo, M. Castanier, M. Ghaffari, K. Barton, Robust Task Scheduling for Heterogeneous Robot Teams under Capability Uncertainty, *IEEE Transactions on Robotics*. 39 (2023) 1087–1105. <https://doi.org/10.1109/TRO.2022.3216068>.
- [10] G.I. Barbash, S.A. Glied, New Technology and Health Care Costs — The Case of Robot-Assisted Surgery, *New England Journal of Medicine*. 363 (2010) 701–704. https://doi.org/10.1056/NEJMP1006602/SUPPL_FILE/NEJMP1006602_DISCLOSURES.PDF.
- [11] K. Qian, A. Song, J. Bao, H. Zhang, Small Teleoperated Robot for Nuclear Radiation and Chemical Leak Detection:, <https://doi.org/10.5772/50720>. 9 (2012). <https://doi.org/10.5772/50720>.
- [12] A. Davids, Urban Search and Rescue Robots: From Tragedy to Technology, *IEEE Intell Syst*. 17 (2002) 81–83. <https://doi.org/10.1109/MIS.2002.999224>.

- [13] L. Pérez, E. Diez, R. Usamentiaga, D.F. García, Industrial robot control and operator training using virtual reality interfaces, *Comput Ind.* 109 (2019) 114–120. <https://doi.org/10.1016/j.compind.2019.05.001>.
- [14] J.M. Davila Delgado, L. Oyedele, A. Ajayi, L. Akanbi, O. Akinade, M. Bilal, H. Owolabi, Robotics and automated systems in construction: Understanding industry-specific challenges for adoption, *Journal of Building Engineering.* 26 (2019) 100868. <https://doi.org/10.1016/j.jobeb.2019.100868>.
- [15] C.-J. Liang, X. Wang, V.R. Kamat, C.C. Menassa, Human–Robot Collaboration in Construction: Classification and Research Trends, *J Constr Eng Manag.* 147 (2021) 03121006. [https://doi.org/10.1061/\(ASCE\)CO.1943-7862.0002154](https://doi.org/10.1061/(ASCE)CO.1943-7862.0002154).
- [16] P.B. Rodrigues, R. Singh, M. Oytun, P. Adami, P.J. Woods, B. Becerik-Gerber, L. Soibelman, Y. Copur-Gencturk, G.M. Lucas, A multidimensional taxonomy for human-robot interaction in construction, *Autom Constr.* 150 (2023). <https://doi.org/10.1016/j.autcon.2023.104845>.
- [17] J. Zhang, H. Luo, J. Xu, Towards fully BIM-enabled building automation and robotics: A perspective of lifecycle information flow, *Comput Ind.* 135 (2022) 103570. <https://doi.org/10.1016/J.COMPIND.2021.103570>.
- [18] R. Volk, J. Stengel, F. Schultmann, Building Information Modeling (BIM) for existing buildings — Literature review and future needs, *Autom Constr.* 38 (2014) 109–127. <https://doi.org/10.1016/J.AUTCON.2013.10.023>.
- [19] NIBS, National BIM Standard–United States® Version 3 | National BIM Standard - United States, (2015). <https://www.nationalbimstandard.org/nbims-us> (accessed March 21, 2022).
- [20] F.R. Correa, Robot-oriented design for production in the context of building information modeling, *ISARC 2016 - 33rd International Symposium on Automation and Robotics in Construction.* (2016) 853–861. <https://doi.org/10.22260/isarc2016/0103>.
- [21] A. Golabchi, M. Akula, V.R. Kamat, Leveraging BIM for Automated Fault Detection in Operational Buildings, in: *ISARC. Proceedings of the International Symposium on Automation and Robotics in Construction,* 2013. <https://doi.org/10.22260/ISARC2013/0020>.
- [22] F. Correa, Simulating wood-framing wall panel’s production with timed coloured petri nets, *Proceedings of the 36th International Symposium on Automation and Robotics in Construction, ISARC 2019.* (2019) 1026–1033.
- [23] S. Kim, M. Peavy, P.C. Huang, K. Kim, Development of BIM-integrated construction robot task planning and simulation system, *Autom Constr.* 127 (2021) 103720. <https://doi.org/10.1016/J.AUTCON.2021.103720>.

- [24] L. Ding, W. Jiang, Y. Zhou, C. Zhou, S. Liu, BIM-based task-level planning for robotic brick assembly through image-based 3D modeling, *Advanced Engineering Informatics*. 43 (2020) 100993. <https://doi.org/10.1016/J.AEI.2019.100993>.
- [25] K.M. Lundeen, V.R. Kamat, C.C. Menassa, W. McGee, Scene understanding for adaptive manipulation in robotized construction work, *Autom Constr.* 82 (2017) 16–30. <https://doi.org/10.1016/j.autcon.2017.06.022>.
- [26] S. Seong, C. Lee, J. Kim, Intelligent Multi-Fingered Dexterous Hand Using Virtual Reality (VR) and Robot Operating System (ROS), *Advances in Intelligent Systems and Computing*. 751 (2019) 35–41. <https://doi.org/10.1007/978-3-319-78452-6>.
- [27] S. Sharif, T.R. Gentry, L.M. Sweet, Human-robot collaboration for creative and integrated design and fabrication processes, in: *ISARC 2016 - 33rd International Symposium on Automation and Robotics in Construction, 2016*: pp. 596–604. <https://doi.org/10.22260/isarc2016/0072>.
- [28] S. Yoon, Y. Kim, M. Park, C.R. Ahn, Effects of Spatial Characteristics on the Human-Robot Communication Using Deictic Gesture in Construction, (2023). <https://doi.org/10.1061/JCEMD4>.
- [29] X. Wang, C.-J. Liang, C.C. Menassa, V.R. Kamat, Interactive and Immersive Process-Level Digital Twin for Collaborative Human–Robot Construction Work, *Journal of Computing in Civil Engineering*. 35 (2021) 04021023. [https://doi.org/10.1061/\(ASCE\)CP.1943-5487.0000988](https://doi.org/10.1061/(ASCE)CP.1943-5487.0000988).
- [30] P. Tsarouchi, A.S. Matthaiakis, S. Makris, G. Chryssolouris, On a human-robot collaboration in an assembly cell, <https://doi.org/10.1080/0951192X.2016.1187297>. 30 (2016) 580–589. <https://doi.org/10.1080/0951192X.2016.1187297>.
- [31] H. Yu, V.R. Kamat, C.C. Menassa, W. McGee, Y. Guo, H. Lee, Mutual physical state-aware object handover in full-contact collaborative human-robot construction work, *Autom Constr.* 150 (2023) 104829. <https://doi.org/10.1016/j.autcon.2023.104829>.
- [32] A. Hentout, M. Aouache, A. Maoudj, I. Akli, Human–robot interaction in industrial collaborative robotics: a literature review of the decade 2008–2017, *Advanced Robotics*. 33 (2019) 764–799. <https://doi.org/10.1080/01691864.2019.1636714/FORMAT/EPUB>.
- [33] S. Lee, J. Il Moon, Introduction of human-robot cooperation technology at construction sites, *31st International Symposium on Automation and Robotics in Construction and Mining, ISARC 2014 - Proceedings*. (2014) 978–983. <https://doi.org/10.22260/isarc2014/0134>.
- [34] P. Devadass, S. Stumm, S. Brell-Cokcan, Adaptive haptically informed assembly with mobile robots in unstructured environments, *Proceedings of the 36th International*

- Symposium on Automation and Robotics in Construction, ISARC 2019. (2019) 469–476. <https://doi.org/10.22260/isarc2019/0063>.
- [35] D. Kim, J. Kim, K. Lee, C. Park, J. Song, D. Kang, Excavator tele-operation system using a human arm, *Autom Constr.* 18 (2009) 173–182. <https://doi.org/10.1016/j.autcon.2008.07.002>.
- [36] S. Park, X. Wang, C.C. Menassa, V.R. Kamat, J.Y. Chai, Natural Language Instructions for Intuitive Human Interaction with Robotic Assistants in Field Construction Work, (2023). <http://arxiv.org/abs/2307.04195>.
- [37] L. She, Y. Cheng, J.Y. Chai, Y. Jia, S. Yang, N. Xi, Teaching Robots New Actions through Natural Language Instructions, IEEE RO-MAN 2014 - 23rd IEEE International Symposium on Robot and Human Interactive Communication: Human-Robot Co-Existence: Adaptive Interfaces and Systems for Daily Life, Therapy, Assistance and Socially Engaging Interactions. (2014) 868–873. <https://doi.org/10.1109/ROMAN.2014.6926362>.
- [38] P. Chotiprayanakul, D.K. Liu, G. Dissanayake, Human-robot-environment interaction interface for robotic grit-blasting of complex steel bridges, *Autom Constr.* 27 (2012) 11–23. <https://doi.org/10.1016/j.autcon.2012.04.014>.
- [39] Q. Zhu, T. Zhou, J. Du, Upper-body haptic system for snake robot teleoperation in pipelines, *Advanced Engineering Informatics.* 51 (2022). <https://doi.org/10.1016/j.aei.2022.101532>.
- [40] R. Li, Z. Zou, Enhancing construction robot learning for collaborative and long-horizon tasks using generative adversarial imitation learning, *Advanced Engineering Informatics.* 58 (2023) 102140. <https://doi.org/10.1016/j.aei.2023.102140>.
- [41] P. Adami, P.B. Rodrigues, P.J. Woods, B. Becerik-Gerber, L. Soibelman, Y. Copur-Gencturk, G. Lucas, Effectiveness of VR-based training on improving construction workers' knowledge, skills, and safety behavior in robotic teleoperation, *Advanced Engineering Informatics.* 50 (2021). <https://doi.org/10.1016/j.aei.2021.101431>.
- [42] L. Pérez, E. Diez, R. Usamentiaga, D.F. García, Industrial robot control and operator training using virtual reality interfaces, *Comput Ind.* 109 (2019) 114–120. <https://doi.org/10.1016/j.compind.2019.05.001>.
- [43] R. Zhang, S. Lee, M. Hwang, A. Hiranaka, C. Wang, W. Ai, J.J.R. Tan, S. Gupta, Y. Hao, G. Levine, R. Gao, A. Norcia, L. Fei-Fei, J. Wu, NOIR: Neural Signal Operated Intelligent Robots for Everyday Activities, (2023). <http://arxiv.org/abs/2311.01454>.
- [44] Y. Liu, M. Habibnezhad, H. Jebelli, Brain-computer interface for hands-free teleoperation of construction robots, *Autom Constr.* 123 (2021). <https://doi.org/10.1016/j.autcon.2020.103523>.

- [45] A.A. Malik, A. Brem, Digital twins for collaborative robots: A case study in human-robot interaction, *Robot Comput Integr Manuf.* 68 (2021) 102092. <https://doi.org/10.1016/j.rcim.2020.102092>.
- [46] X. Wang, C.-J. Liang, C. Menassa, V. Kamat, Real-Time Process-Level Digital Twin for Collaborative Human-Robot Construction Work, in: *Proceedings of the 37th International Symposium on Automation and Robotics in Construction (ISARC)*, International Association for Automation and Robotics in Construction (IAARC), 2020. <https://doi.org/10.22260/isarc2020/0212>.
- [47] M. Deng, C.C. Menassa, V.R. Kamat, From BIM to digital twins: A systematic review of the evolution of intelligent building representations in the AEC-FM industry, *Journal of Information Technology in Construction.* 26 (2021) 58–83. <https://doi.org/10.36680/J.ITCON.2021.005>.
- [48] F.H. Abanda, J.H.M. Tah, F.K.T. Cheung, BIM in off-site manufacturing for buildings, *Journal of Building Engineering.* 14 (2017) 89–102. <https://doi.org/10.1016/J.JOBE.2017.10.002>.
- [49] A. Zhu, P. Pauwels, B. De Vries, Smart component-oriented method of construction robot coordination for prefabricated housing, *Autom Constr.* 129 (2021) 103778. <https://doi.org/10.1016/J.AUTCON.2021.103778>.
- [50] M. Dawod, S. Hanna, BIM-assisted object recognition for the on-site autonomous robotic assembly of discrete structures, *Construction Robotics 2019* 3:1. 3 (2019) 69–81. <https://doi.org/10.1007/S41693-019-00021-9>.
- [51] C. Follini, V. Magnago, K. Freitag, M. Terzer, C. Marcher, M. Riedl, A. Giusti, D.T. Matt, BIM-Integrated Collaborative Robotics for Application in Building Construction and Maintenance, *Robotics 2021*, Vol. 10, Page 2. 10 (2020) 2. <https://doi.org/10.3390/ROBOTICS10010002>.
- [52] J. Park, Y.K. Cho, D. Martinez, A BIM and UWB integrated Mobile Robot Navigation System for Indoor Position Tracking Applications, *Journal of Construction Engineering and Project Management.* 6 (2016) 30–39. <https://doi.org/10.6106/JCEPM.2016.6.2.030>.
- [53] B.R.K. Mantha, M.K. Jung, B. García de Soto, C.C. Menassa, V.R. Kamat, Generalized task allocation and route planning for robots with multiple depots in indoor building environments, *Autom Constr.* 119 (2020). <https://doi.org/10.1016/j.autcon.2020.103359>.
- [54] Dusty Robotics, Build Better with BIM-Driven Layout, (2021). <https://www.dustyrobotics.com/> (accessed March 21, 2022).

- [55] O. Davtalab, A. Kazemian, B. Khoshnevis, Perspectives on a BIM-integrated software platform for robotic construction through Contour Crafting, *Autom Constr.* 89 (2018) 13–23. <https://doi.org/10.1016/j.autcon.2018.01.006>.
- [56] J. Teizer, A. Blickle, T. King, O. Leitzbach, D. Guenther, H. Mattern, M. König, J. Teizer, A. Blickle Ed, T. King, D. Guenther, O. Leitzbach, H. Mattern, M. König, BIM for 3D Printing in Construction, *Building Information Modeling: Technology Foundations and Industry Practice.* (2018) 421–446. https://doi.org/10.1007/978-3-319-92862-3_26.
- [57] A. McClymonds, S. Asadi, A. Wagner, R.M. Leicht, Information Exchange for Supporting BIM to Robotic Construction, in: *Construction Research Congress 2022*, American Society of Civil Engineers, Reston, VA, 2022: pp. 839–848. <https://doi.org/10.1061/9780784483961.088>.
- [58] O. Wong Chong, J. Zhang, R.M. Voyles, B.-C. Min, BIM-based simulation of construction robotics in the assembly process of wood frames, *Autom Constr.* 137 (2022) 104194. <https://doi.org/10.1016/J.AUTCON.2022.104194>.
- [59] K.M. Lundeen, V.R. Kamat, C.C. Menassa, W. McGee, Autonomous motion planning and task execution in geometrically adaptive robotized construction work, *Autom Constr.* 100 (2019) 24–45. <https://doi.org/10.1016/j.autcon.2018.12.020>.
- [60] F. Dembski, U. Wössner, M. Letzgus, M. Ruddat, C. Yamu, Urban digital twins for smart cities and citizens: The case study of herrenberg, germany, *Sustainability (Switzerland)*. 12 (2020) 1–17. <https://doi.org/10.3390/su12062307>.
- [61] Y. Fang, Y.K. Cho, J. Chen, A framework for real-time pro-active safety assistance for mobile crane lifting operations, *Autom Constr.* 72 (2016) 367–379. <https://doi.org/10.1016/j.autcon.2016.08.025>.
- [62] C. Feng, Y. Xiao, A. Willette, W. McGee, V.R. Kamat, Vision guided autonomous robotic assembly and as-built scanning on unstructured construction sites, *Autom Constr.* 59 (2015) 128–138. <https://doi.org/10.1016/j.autcon.2015.06.002>.
- [63] L. Xu, C. Feng, V.R. Kamat, C.C. Menassa, An Occupancy Grid Mapping enhanced visual SLAM for real-time locating applications in indoor GPS-denied environments, *Autom Constr.* 104 (2019) 230–245. <https://doi.org/10.1016/j.autcon.2019.04.011>.
- [64] T. Zhou, Q. Zhu, J. Du, Intuitive robot teleoperation for civil engineering operations with virtual reality and deep learning scene reconstruction, *Advanced Engineering Informatics.* 46 (2020) 101170. <https://doi.org/10.1016/j.aei.2020.101170>.
- [65] J. Park, Y.K. Cho, Point Cloud Information Modeling: Deep Learning–Based Automated Information Modeling Framework for Point Cloud Data, *J Constr Eng Manag.* 148 (2022). [https://doi.org/10.1061/\(asce\)co.1943-7862.0002227](https://doi.org/10.1061/(asce)co.1943-7862.0002227).

- [66] V. Kamat, J.C. Martinez, AUTOMATED GENERATION OF DYNAMIC, OPERATIONS LEVEL VIRTUAL CONSTRUCTION SCENARIOS, *Journal of Information Technology in Construction*. 8 (2003) 65–84. <http://www.itcon.org/2003/6>.
- [67] C.-J. Liang, W. Mcgee, C.C. Menassa, V.R. Kamat, Real-time state synchronization between physical construction robots and process-level digital twins, *Construction Robotics*. (2022). <https://doi.org/10.1007/s41693-022-00068-1>.
- [68] J.J. Roldán, E. Peña-Tapia, D. Garzón-Ramos, J. de León, M. Garzón, J. del Cerro, A. Barrientos, Multi-robot Systems, Virtual Reality and ROS: Developing a New Generation of Operator Interfaces, in: *Robot Operating System (ROS)*. Springer, Cham., Springer Verlag, 2019: pp. 29–64. https://doi.org/10.1007/978-3-319-91590-6_2.
- [69] S. Meschini, K. Iturralde, T. Linner, T. Bock, Novel applications offered by Integration of Robotic Tools in BIM-based Design Workflow for Automation in Construction Processes, in: *CIB* IAARC W199 CIC 2016 Workshop*, 2016.
- [70] R. Pietroforte, A. Member, Shop Drawing Process of Stone Veneered Cladding Systems, *Journal of Architectural Engineering*. 3 (1997) 70–79. [https://doi.org/10.1061/\(ASCE\)1076-0431\(1997\)3:2\(70\)](https://doi.org/10.1061/(ASCE)1076-0431(1997)3:2(70)).
- [71] K. Kim, J.W. Park, C. Cho, Framework for Automated Generation of Constructible Steel Erection Sequences Using Structural Information of Static Indeterminacy Variation in BIM, *KSCE Journal of Civil Engineering* 2020 24:11. 24 (2020) 3169–3178. <https://doi.org/10.1007/S12205-020-0163-6>.
- [72] S. Levine, P. Pastor, A. Krizhevsky, J. Ibarz, D. Quillen, Learning hand-eye coordination for robotic grasping with deep learning and large-scale data collection., *The International Journal of Robotic Research*. 37 (2017) 421–436. <https://doi.org/10.1177/0278364917710318>.
- [73] A. Adel, A. Thoma, M. Helmreich, F. Gramazio, M. Kohler, Design of Robotically Fabricated Timber Frame Structures, in: *38th Annual Conference of the Association for Computer Aided Design in Architecture (ACADIA 2018)*, 2018: pp. 394–403. <https://doi.org/10.52842/conf.acadia.2018.394>.
- [74] Siemens, GitHub - ROS#, (2021). <https://github.com/siemens/ros-sharp> (accessed March 21, 2022).
- [75] McNeel, Rhino - Rhino.Inside, (2022). <https://www.rhino3d.com/features/rhino-inside/> (accessed March 21, 2022).
- [76] S. Chitta, I. Sukan, S. Cousins, MoveIt!, *IEEE Robot Autom Mag*. 19 (2012) 18–19. <https://doi.org/10.1109/MRA.2011.2181749>.

- [77] V.R. Kamat, J.C. Martinez, 3D VISUALIZATION OF SIMULATED CONSTRUCTION OPERATIONS, in: Winter Simulation Conference (Cat. No.00CH37165), 2000: pp. 1933–1937. <https://doi.org/10.1109/WSC.2000.899189>.
- [78] COMPAS, COMPAS, (2021). <https://compas.dev/> (accessed March 21, 2022).
- [79] Beckhoff, Beckhoff Information System - ADS Introduction, (2022). https://infosys.beckhoff.com/english.php?content=../content/1033/tcadscommon/html/tcad_scommon_intro.htm&id= (accessed March 21, 2022).
- [80] M. Krogius, A. Haggemiller, E. Olson, Flexible Layouts for Fiducial Tags, in: IEEE/RSJ International Conference on Intelligent Robots and Systems (IROS), 2019: pp. 1898–1903.
- [81] K.M. Lundeen, S. Dong, N. Fredricks, M. Akula, J. Seo, V.R. Kamat, Optical marker-based end effector pose estimation for articulated excavators, *Autom Constr.* 65 (2016) 51–64. <https://doi.org/10.1016/j.autcon.2016.02.003>.
- [82] C. Feng, V.R. Kamat, Plane registration leveraged by global constraints for context-aware AEC applications, *Computer-Aided Civil and Infrastructure Engineering.* 28 (2013) 325–343. <https://doi.org/10.1111/j.1467-8667.2012.00795.x>.
- [83] G. Du, K. Wang, S. Lian, K. Zhao, Vision-based robotic grasping from object localization, object pose estimation to grasp estimation for parallel grippers: a review, *Artif Intell Rev.* 54 (2021) 1677–1734. <https://doi.org/10.1007/s10462-020-09888-5>.
- [84] J. Fan, P. Zheng, S. Li, Vision-based holistic scene understanding towards proactive human–robot collaboration, *Robot Comput Integr Manuf.* 75 (2022). <https://doi.org/10.1016/j.rcim.2021.102304>.
- [85] A. Adel, Computational Design for Cooperative Robotic Assembly of Nonstandard Timber Frame Buildings, ETH Zurich, 2020. <https://doi.org/10.3929/ethz-b-000439443>.
- [86] C.-J. Liang, V.R. Kamat, C.C. Menassa, W. Mcgee, Trajectory-Based Skill Learning for Overhead Construction Robots Using Generalized Cylinders with Orientation, *Journal of Computing in Civil Engineering.* 36 (2021) 04021036. [https://doi.org/10.1061/\(ASCE\)CP.1943-5487.0001004](https://doi.org/10.1061/(ASCE)CP.1943-5487.0001004).
- [87] N. Emaminejad, R. Akhavian, Trustworthy AI and robotics: Implications for the AEC industry, *Autom Constr.* 139 (2022). <https://doi.org/10.1016/j.autcon.2022.104298>.