

LoViT: Long Video Transformer for Surgical Phase Recognition

Yang Liu¹, Maxence Boels¹, Luis C. Garcia-Peraza-Herrera¹, Tom Vercauteren¹,
Prokar Dasgupta², Alejandro Granados¹, Sébastien Ourselin¹

¹Department of Surgical & Interventional Engineering, King’s College London

²Department of Peter Gorer Department of Immunobiology, King’s College London

E-mail: yang.9.liu@kcl.ac.uk

Abstract

Online surgical phase recognition plays a significant role towards building contextual tools that could quantify performance and oversee the execution of surgical workflows. Current approaches are limited since they train spatial feature extractors using frame-level supervision that could lead to incorrect predictions due to similar frames appearing at different phases, and poorly fuse local and global features due to computational constraints which can affect the analysis of long videos commonly encountered in surgical interventions. In this paper, we present a two-stage method, called Long Video Transformer (LoViT) for fusing short- and long-term temporal information that combines a temporally-rich spatial feature extractor and a multi-scale temporal aggregator consisting of two cascaded L-Trans modules based on self-attention, followed by a G-Informer module based on ProbSparse self-attention for processing global temporal information. The multi-scale temporal head then combines local and global features and classifies surgical phases using phase transition-aware supervision. Our approach outperforms state-of-the-art methods on the Cholec80 and AutoLaparo datasets consistently. Compared to Trans-SVNet, LoViT achieves a 2.4 pp (percentage point) improvement in video-level accuracy on Cholec80 and a 3.1 pp improvement on AutoLaparo. Our results demonstrate the effectiveness of our approach in achieving state-of-the-art performance of surgical phase recognition on two datasets of different surgical procedures and temporal sequencing characteristics whilst introducing mechanisms that cope with long videos. The code will be available at <https://github.com/MRUILL/LoViT>

1. Introduction

Surgical Data Science (SDS) aims to improve the quality of interventional healthcare through the capture, modelling, and analysis of patient data from medical devices within the operating room (OR) [1]. Surgical phase and action recognition are paramount in comprehending surgical processes, evaluating surgeon performance, and providing assistance that is reactive to the surgical context [2]. Specifically, automatic recognition of surgical phases and actions plays a crucial role in developing surgical skills and enhancing the efficiency and safety of surgeries by providing immediate feedback to the surgical team. This is critical in advancing surgical practices and education through continuous improvement. During endoscopic-based interventions, surgical phase recognition aims to classify every video frame into high-level stages of surgery [3], while action recognition aims to classify each frame into granular and fine tasks entirely from data. In contrast to action recognition, surgical phase recognition requires approaches that process videos over long time frames since each phase typically contains several actions. Compared to offline recognition that can be used for automated annotation of prerecorded videos, online recognition allows recognizing current activity without future information, which could be used to alert surgeons of those tasks that are likely to lead to complications [4] and support their decision making [5].

Early work related to surgical phase recognition focused mostly on statistical models. Blum *et al.* [6] analyzed surgical signals, including the use of surgical instruments and high-frequency coagulation and cutting, for dimensionality reduction of video frames into image features. Padoy *et al.* [7] processed synchronized signals based on Dynamic Time Warping [8] and Hidden Markov Models (HMM) [9]. Bardram *et al.* [10] presented a sensor platform and a machine learning approach to sense surgical phases. Holden *et al.* [11] developed a workflow segmentation algorithm for

needle interventions using needle tracking data. However, these techniques exploit extra information, such as manual instrument annotation or equipment installation, that might be inconvenient to collect and could cause workload, rather than only video. Pure video-based methods were then proposed to overcome the aforementioned limitations. Quellec *et al.* [4] presented a multiscale motion characterization approach based on adaptive spatio-temporal polynomials. Dergachyova *et al.* [5] trained a set of *AdaBoost* classifiers capable of distinguishing one surgical phase from others, and then adopted a hidden semi-Markov model to obtain a final decision. Since vision features and temporal context of surgical video are highly complex, these methods show limited representation capabilities with pre-defined dependencies [12, 13].

With the advent of deep learning, approaches entirely based on video frames as input data were proposed. EndoNet [14] was the first work to use a Convolutional Neural Network (CNN) [15] for multiple recognition tasks, which extracted spatial features that were fed into a hierarchical HMM for modeling temporal information. Twinanda [16] used Long Short-term Memory (LSTM) [17], a type of Recurrent Neural Network (RNN) gate, rather than an HMM to enhance EndoNet’s ability to understand the temporal context. Jin *et al.* [18] presented a multi-task framework called MTRCNet-CL, which used a correlation loss to exploit the relatedness between tool presence detection and surgical phase recognition with the aim of simultaneously boosting the performance of both tasks. Similar to early work, these methods are based on multi-task learning which necessitates additional tool annotations in addition to phase labels, thus increasing workload and costs. To mitigate this, the following methods have shifted focus to solely learning a single task using only phase labels. SV-RCNet [12] leveraged a Residual network (ResNet) [19] and an LSTM network to learn spatial and temporal features end-to-end, respectively. Yi *et al.* [20] presented an Online Hard Frame Mapper (OHFM) to handle the detected hard frames, that defined as some frames with indistinguishable visual features but are separately assigned with different labels. Gao *et al.* [21] designed a framework using a tree search algorithm to consider future information from LSTM. However, the ability of LSTMs to retain memory is limited due to their vanishing gradients problem, which affects their ability to capture information from long sequences. This particularly affects their use on surgical videos for temporal feature extraction since interventions could last a few hours [22]. In contrast, TMRNet [23] employed a non-local bank operator to establish the relationship between the current frame and all previous features generated by LSTM. However, the contribution of all previous features to the current frame is only a simple weighted sum, resulting in a lack of effective capture of global information. Czemp

piel *et al.* [22] presented TeCNO, based on Temporal Convolutional Networks (TCNs) [24, 25], that is able to capture long-term temporal correlations. However, by essentially adapting dilated convolutions [26] for long sequences using TCNs, the increased receptive field obtained through dilation can result in a loss of fine-grained relationships between more distant time steps. In other words, the information captured by TCNs becomes coarser as the sequence length increases. This can result in a loss of detail in the learned representations and reduce performance.

With the rise of Transformers in Natural Language Processing (NLP) [27], the parallel nature of attention blocks were quickly used to replace CNNs and RNNs architectures. In vision-related tasks, Vision Transformer (ViT) [28] was proposed by replacing word tokens of vanilla Transformers with sequences of 16×16 pixels image patches. Temporal attention was then introduced with TimeSformer [29] and VideoViT [30] approaches for video classification with self-attention on sequences of frame-level patches. The Anticipative Video Transformer (AVT) [31] then ranked first in EPIC-Kitchens-100 Challenge [32] by using a ViT backbone and a causal head layer to predict the next actions with the disadvantage of working only on videos being dozens of frames long. Czempiel *et al.* [33] first introduced a Transformer-based temporal future extractor for surgical phase recognition. This was then followed by Trans-SVNet [13], which aimed to address the issue of lost fine-grained information in TCNs by using a small Transformer model to complement the spatial and temporal features that were previously ignored. Despite this attempt, the drawback of the dilated convolution structure in TCNs still remains. This problem exacerbates since time and memory complexity of Transformers are quadratic due to their dot-product operations, a particular problem for long videos commonly resulting from surgical interventions. Informer [34] was proposed to overcome the limitations of Transformers when processing long sequences. It utilizes attention mechanisms to accurately capture long-range dependencies within the sequences. To address the inherent problems of Transformers, such as their quadratic time complexity and high memory usage of $\mathcal{O}(L^2)$ (where L means the input sequence length), Informer introduces a novel *ProbSparse* self-attention mechanism that reduces the time and memory complexity to $\mathcal{O}(L \log(L))$.

Motivated by designing deep learning algorithms that can efficiently interpret surgical phases of long videos without impacting performance, we propose **LoViT** – a Long Video Transformer – that outperforms state-of-the-art work. The specific contributions of this work include:

- a temporally-rich spatial feature extractor that leverages temporal information to improve the precision of spatial feature learning,

- multiscale temporal feature aggregation of local information using vanilla self-attention, and global relationships following *ProbSparse* self-attention, and
- a simple but effective phase transition-aware supervision for highlighting critical temporal information of phase transitions.

2. Methods

In this work, we target the problem of online surgical phase recognition. Formally, this is a video classification problem where we aim to solve for a mapping f such that $f_{\theta}(X_t) \approx p_t$, where $X_t = \{\mathbf{x}_j\}_{j=1}^t$ is a given input video stream, and $\mathbf{x}_j \in \mathbb{R}^{H \times W \times C}$. The symbols H , W , C represent the image height, width, and number of channels, respectively. As in our work we deal with RGB images, $C = 3$. The height and width of each video frame change from dataset to dataset. The first frame of the video is noted as \mathbf{x}_1 , and the current t -th frame as \mathbf{x}_t . The output $p_t \in \{k\}_{k=1}^K$ is the class index corresponding to the surgical phase of the video frame \mathbf{x}_t , where K is the total number of classes or surgical phases. The symbol θ is a vector of parameters corresponding to the weights of our network model f , which we call LoViT throughout the paper.

2.1. Overview of LoViT architecture

Our LoViT embodies a temporally-rich spatial feature extractor followed by a multi-scale temporal feature aggregator. Specifically, the temporally-rich spatial feature extractor embeds surgical video frames, and then feeds them to the multi-scale temporal feature aggregator, where includes Transformer-based module L-Trans for abstracting short fine-grained information, such as actions and tools, and Informer-based module G-Informer for processing long-term information, such as key clip information of current phase and the relationship among phases. Moreover, a multi-scale temporal fusion head integrates local and global features together that is used for classifying surgical phases with the support of phase transition-aware supervision.

2.2. Temporally-rich spatial feature extractor

Currently, surgical phase recognition methods typically rely on long sequences of frame inputs due to the strong interdependence of surgical phases. However, the duration of surgical videos often lasts for several hours, making it difficult to train a model in an end-to-end manner. To overcome this challenge, a two-step model is widely used, where a spatial feature extractor is trained first to encode spatial features, followed by training a temporal feature extractor with the encoded features. The prevalent approach to training the spatial feature extractor involves using frame-level supervision, where each image is input and the expected out-

put is the corresponding phase. However, similar actions and screens appearing in different phases during a surgical video can result in confusion when recognizing the phases, as depicted in Fig. 2. This can lead to insufficient training of the spatial feature extractor if only relying on frame-level supervision. Given a video frame, its corresponding phase relies on current frame itself and previous frames' features. So only current video frame is insufficient to recognize a phase label. We propose a new method to train a temporally-rich spatial feature extractor as shown in Fig. 3, which builds a more accurate (image set \rightarrow phase) mapping relationship instead of (image \rightarrow phase) mapping relationship.

We start by selecting a set of frames X'_t from image sequence X_t and embedding each image frame $x \in X'_t$ into a spatial feature vector $e \in \mathbb{R}^{D_s}$ using the spatial feature extractor \mathcal{S}^R . D_s is the dimension of the spatial feature. These features are then grouped into a feature sequence E_t , which is inputted into the temporal aggregator \mathcal{T} for surgical phase classification. \mathcal{S}^R and \mathcal{T} are jointly trained in an end-to-end manner, leading to a temporally-rich spatial feature extractor \mathcal{S}^R . Due to limitations in computing resources and the assumption that key temporal information typically appears at the beginning (b_p -th frame in the video) of each phase p , we only select a small number of $\alpha = 30$ image frames from the beginning $x_{b_{p_t}}$ of the current phase p_t up to the current frame x_t at equal intervals $w_t = \lceil \frac{t-b_{p_t}}{\alpha} \rceil$ to form the image set X'_t :

$$X'_t = (x_{t-w_t(\alpha-1)}, x_{t-w_t(\alpha-2)}, \dots, x_t). \quad (1)$$

Then the predicted phase \hat{p}_t of t -th frame is formulated as:

$$\begin{aligned} \hat{p}_t &= \mathcal{T}(E_t) \\ &= \mathcal{T}((\mathcal{S}^R(x_{t-w_t(\alpha-1)}), \mathcal{S}^R(x_{t-w_t(\alpha-2)}), \dots, \mathcal{S}^R(x_t))). \end{aligned} \quad (2)$$

To this end, inspired by the Transformer-based model AVT [31] that performs efficiently in action anticipation tasks of short videos, we use the proposed architecture of AVT, whereby spatial feature extractor \mathcal{S}^R is based on ViT [28] and temporal aggregator \mathcal{T} is based on a Transformer with causal-masked attention. Moreover, we use the cross-entropy loss for training this model. Note that we throw out the temporal aggregator \mathcal{T} after training the spatial feature extractor \mathcal{S}^R , and use the fixed weight of \mathcal{S}^R to embed each image frame x into spatial feature e , which is fed to the following temporal feature aggregator.

2.2.1 Local temporal feature aggregator

We designed a local Transformer-based temporal feature aggregator (**L-Trans**) to extract local fine-grained temporal information, which is visualized in Fig. 4. L-Trans begins by analyzing the current local temporal features with the assistance of the previous clip's output, using a fusion module.

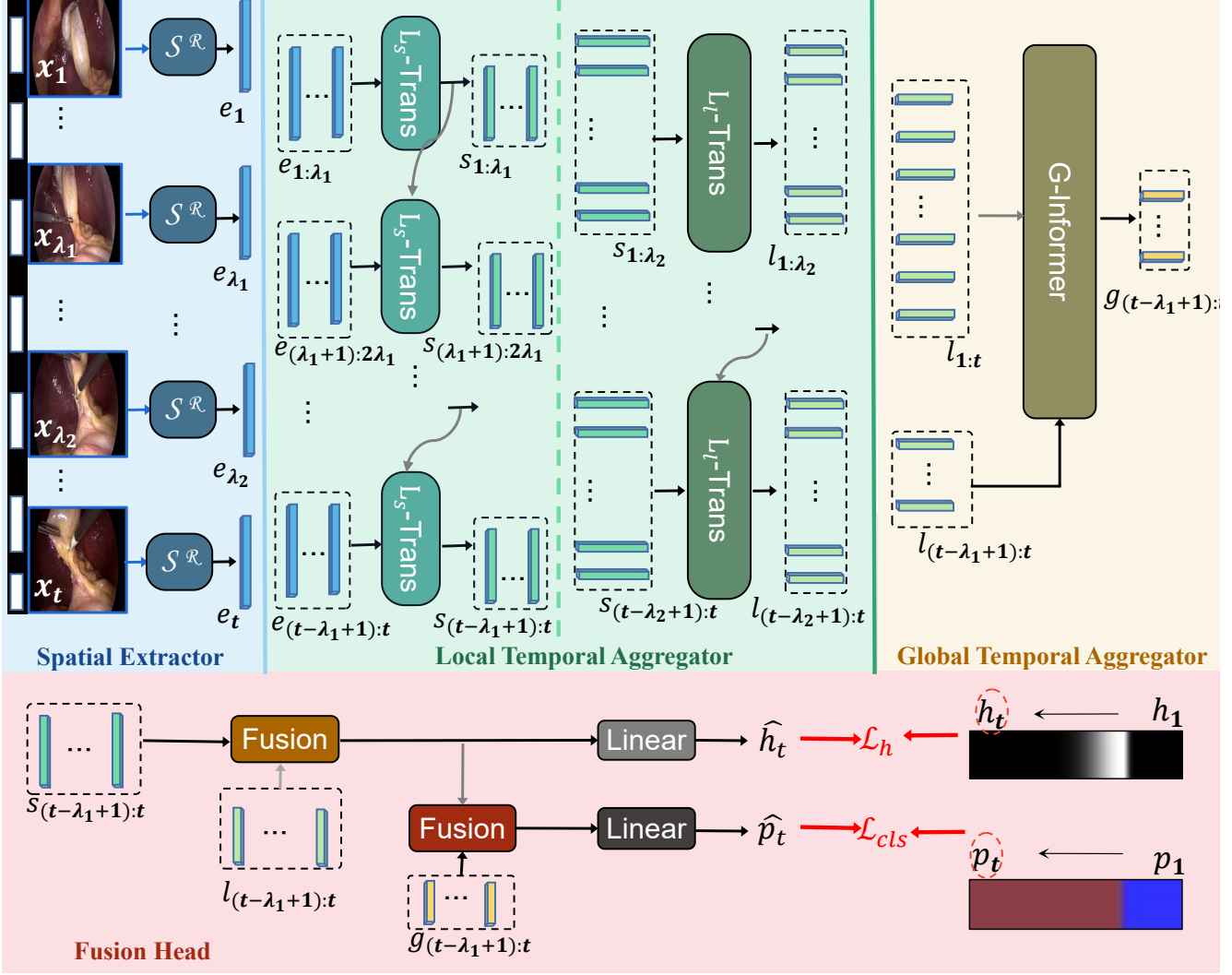

Figure 1: The proposed LoViT framework for surgical video phase recognition. The \mathcal{S}^R module extracts temporally-rich spatial features e from each video frame x . Two cascaded L-Trans modules (L_s -Trans and L_l -Trans) output local temporal features s and l with inputs of different local window sizes (λ_1 and λ_2). G-Informer captures the global relationships to generate the temporal feature g . A fusion head combines the multi-scale features s , l , and g , followed by two linear layers that learn a phase transition map \hat{h}_t and a phase label \hat{p}_t of the current t -th video frame x_t . Modules with the same color share the same weight. During training, \mathcal{S}^R is trained separately and its weights are then frozen to train the other temporal modules of LoViT.

A second fusion module then refines the output by incorporating initial current features. Fig. 4 also depicts the fusion module, which consists of an m -layer self-attention encoder for auxiliary features and an n -layer cascaded self-attention module with cross-attention for the encoder’s output and the decoder branch input.

The self-attention mechanism reduces the length between every network signal to the shortest $\mathcal{O}(1)$ through the dot-product computation between every two signals and avoids the recurrent structure, whereby Transformer is used

for temporal feature aggregation. The self-attention mechanism, per [27], is formulated as:

$$\mathcal{A}(Q, K, V) = \text{Softmax}\left(\frac{QK^T}{\sqrt{d_k}}\right)V, \quad (3)$$

where $Q \in \mathbb{R}^{L_Q \times d}$, $K \in \mathbb{R}^{L_K \times d}$, $V \in \mathbb{R}^{L_V \times d}$, and d is the input dimension. Q , K , and V represent the standard matrices referred to as query, key, and value in Transformer-based architectures, respectively. In contrast, cross-attention refers to the attention mechanism that takes

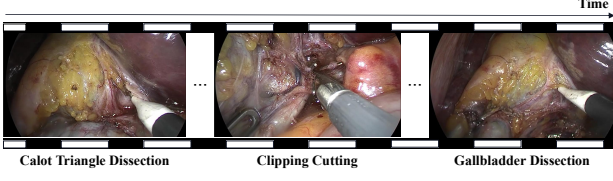

Figure 2: Example of similar frames (first and third) corresponding to different phases in Cholec80 dataset [14].

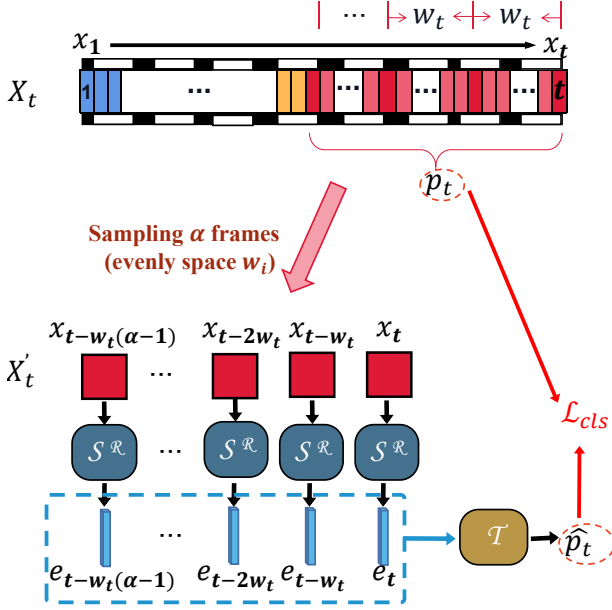

Figure 3: The architecture of training the temporally-rich spatial feature extractor. During the t -th frame training, a video stream $X_t = \{x_j\}_{j=1}^t$ is sampled at evenly spaced intervals w_t from the start of the current phase to the current frame, producing $X'_t \subseteq X_t$. Each frame $x \in X'_t$ is embedded using the spatial feature extractor \mathcal{S}^R , then grouped into a feature sequence (with a blue dashed box). A temporal aggregator \mathcal{T} follows to add temporal information for recognition. The predicted phase \hat{p}_t is compared to the corresponding ground truth phase p_t to compute a cross-entropy loss. We will throw \mathcal{T} and only retain \mathcal{S}^R for spatial feature extraction after the training stage.

into account both the query and key inputs from different sources.

To capture local temporal information of different granularities, we utilize two cascaded L-Trans: a small one (**L_s-Trans**) and a large one (**L_l-Trans**), each receiving input sequences of length λ_1 and λ_2 , respectively. We first feed the spatial feature set e resulting from our temporally-rich spatial feature extractor to L_s-Trans and output the small-local feature s . Note that we also include the previous out-

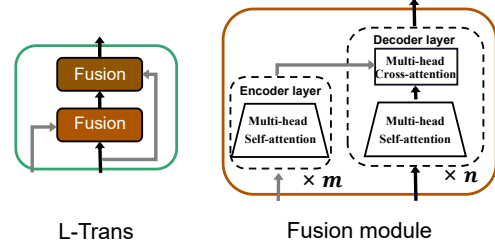

Figure 4: **L-Trans**: The L-Trans adopts two cascaded fusion modules to process two-branch temporal inputs (grey line and black line). **Fusion module**: It consists of an encoder and a decoder. The encoder is comprised of an m -layer self-attention layer for the grey line input, and the decoder is composed of an n -layer cascaded self-attention with cross-attention for processing the encoder’s output and the black line input.

put of L_s-Trans as input. Then, we feed the sequence s to L_l-Trans to obtain the large-local feature l . Similarly, note that we also include the previous output of L_l-Trans as input. To speed up the training time and reduce the training memory, we only calculate the gradient of the last clip ($x_{t-\lambda+1}, \dots, x_t$) and drop all the previous gradients when recognising t -th frame for training.

2.2.2 Global temporal feature aggregator

Despite the self-attention mechanism inherent in Transformer-based architectures has the capability of extracting temporal relationships (see Eq. 3), it requires quadratic dot-product $\mathcal{O}(L_Q L_K)$ time computation and memory usage, which limits the processing of long sequences. To overcome this limitation, we propose the use of Informer [34], which consists of a more efficient implementation of the self-attention mechanism called *ProbSparse*, whereby only a few dot-product pairs contribute to the major attention. *ProbSparse* reduces time and memory usage to $\mathcal{O}(L \ln(L))$ where L represents the input sequence length. *ProbSparse* is formulated as:

$$A_{PS}(Q, K, V) = \text{Softmax}\left(\frac{\bar{Q}K^T}{\sqrt{d_k}}\right)V, \quad (4)$$

where q_i represents the i -th row in Q , and \bar{Q} is a sparse matrix of the same size as q , containing only the top u queries under the sparsity max-mean measurement:

$$\bar{M}(q_i, K) = \max_j \left(\frac{q_i k_j^T}{\sqrt{d_k}} \right) - \frac{1}{L_K} \sum_{j=1}^{L_K} \frac{q_i k_j^T}{\sqrt{d_k}}. \quad (5)$$

Under the long tail distribution, we randomly sample $U = L_K \ln(L_Q)$ dot-product pairs to calculate $\bar{M}(q_i, K)$, and fill the rest with zeros.

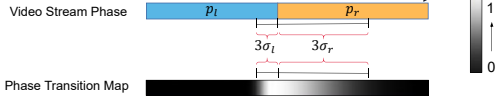

Figure 5: The example of building phase transition map. We project phase transition area onto a phase transition map using a left-right asymmetric Gaussian kernel where left- and right-side kernel lengths are $3\sigma_l$ and $3\sigma_r$, respectively. p_l and p_r mean adjacent different phases.

We designed a Global Temporal Informer (**G-Informer**) to capture long-range dependencies more efficiently. The G-Informer framework contains two branches for processing two types of inputs: a long local feature sequence (l_1, \dots, l_t) and the current local feature $(l_{t-\lambda_1+1}, \dots, l_t)$. Unlike the fusion model used for L-Trans, the first input branch of G-Informer for the long sequence uses the *ProbSparse* self-attention mechanism.

2.3. Multi-scale temporal feature fusion head.

Feature down-sampling and sparse attention unfortunately lead to the loss of fine-grained characteristics in G-Informer. To overcome this limitation, we employ a multi-scale temporal feature fusion head to combine the local (small and large) and global features from L-Trans and G-Informer, respectively. As illustrated at the bottom of Fig. 1, the multi-scale head contains two fusion modules. The first one is to merge the short and the long local temporal features, $(s_{t-\lambda_1+1}, \dots, s_t)$ and $(l_{t-\lambda_1+1}, \dots, l_t)$, obtained from L_s -Trans and L_l -Trans, respectively. Subsequently, another fusion module is utilized to merge the fused local features with the global temporal features $(g_{t-\lambda_1+1}, \dots, g_t)$ obtained from G-Informer.

2.4. Phase transition-aware supervision.

To be able to give importance to previous key information, especially during phase transitions, we project transition frames, which are adjacent to other phase frames, onto a phase transition map h using a one-dimensional asymmetric Gaussian kernel, as shown in Fig. 5. The map value of the t -th frame is formulated as:

$$h_t = \begin{cases} \exp\left(-\frac{(t-b_{p_t})^2}{2\sigma_l^2}\right), & b_{p_t} - 3\sigma_l < t < b_{p_t} \\ \exp\left(-\frac{(t-b_{p_t})^2}{2\sigma_r^2}\right), & b_{p_t} < t < b_{p_t} + 3\sigma_r \\ 0, & \text{otherwise} \end{cases} \quad (6)$$

where the left-side kernel length of the transition map is $3\sigma_l$ and the right-side kernel length is $3\sigma_r$, both departing from b_{p_t} , the position of the frame where the phase transition occurs. Accordingly, the loss function of our proposed LoViT model is a weighted sum of the phase transition map loss and phase class loss:

$$\mathcal{L}^* = \mathcal{L}_1(\hat{h}) + \mathcal{L}_{CE}(\hat{p}), \quad (7)$$

where $\mathcal{L}_1(\hat{h})$ refers to the L_1 loss between predicted phase transition map value \hat{h} and its ground truth h , and $\mathcal{L}_{CE}(\hat{p})$ refers to cross-entropy loss between predicted phase \hat{p} and its ground truth p .

3. Experimental Design

3.1. Datasets.

We extensively performed experiments on two publicly available surgical video datasets, namely Cholec80 [14] and AutoLaparo [35], capturing cholecystectomy and hysterectomy surgical interventions, respectively. Cholec80 [14] consists of 80 high-resolution, of either 1920×1080 or 854×480 pixels, laparoscopic surgical videos with an average video duration of 39 minutes at 25 frames-per-second (fps). These databases are provided with manual annotations done by surgeons indicating the surgical phase each video frame belongs to and the tools appearing in the scene. Cholec80 videos consist of seven phases. For this study, we only use phase annotations. For a fair comparison with previous methods [12–14, 20], we keep intact the splitting of the dataset into first 40 videos for training and the remaining 40 videos for testing. AutoLaparo [35] consists of 21 videos with 7 phases, recorded at 25 Hz of a resolution of 1920×1080 pixels with an average video duration of 66 minutes. We split the dataset into 10 videos for training, 4 videos for validation and 7 videos for testing following [35]. Note that, similar to other works presented in the literature [12–14], we sampled both datasets into 1 fps and resized the frame size to 250×250 pixels.

3.2. Implementation details.

Our method is implemented with the PyTorch framework [36]. All experiments were carried out on an Intel Xeon W-2195 CPU (2.3 GHz), 125GB RAM, and a single NVIDIA Tesla V100 GPU. Following the AVT model [31], our temporally-rich spatial feature extractor is a 12-head, 12-layer Transformer encoder model that uses the ViT-B/16 architecture, which is pretrained on ImageNet-1K (IN1k) [37] with input image size of 248×248 pixels and output size of $D_s = 768D$ representations. We trained the feature extractor with SGD+momentum for 35 epochs, with a 5-epoch warmup [38] and cosine annealed decay. The rest of LoViT was trained for 50 epochs with SGD+momentum, weight decay of $1e-5$, learning rate of $3e-4$, and a 5-epoch warmup and 45-epoch cosine annealed decay. During experiments, LoViT was fed 3000 video frames and produced outputs with dimensions of 512, 64, and 8 for L_s -Trans, L_l -Trans, and G-Informer, respectively. Both L_s -Trans and L_l -Trans have a fusion module each with a 2-layer encoder and a 2-layer decoder. G-Informer has a

Table 1: The results (%) of different state-of-the-art methods on both the Cholec80 and AutoLaparo datasets. The best results are marked in bold. Note that the ‘*’ denotes methods based on multi-task learning that requires extra tool labels, and ‘+’ denotes the use of 10-second relaxed boundary metrics¹.

Dataset	Method	Video-level Metric		Phase-level Metric	
		Accuracy \uparrow	Precision \uparrow	Recall \uparrow	Jaccard \uparrow
Cholec80	EndoNet [14]**	81.7 \pm 4.2	73.7 \pm 16.1	79.6 \pm 7.9	-
	MTRCNet-CL [18]**	89.2 \pm 7.6	86.9 \pm 4.3	88.0 \pm 6.9	-
	PhaseNet [39]+	78.8 \pm 4.7	71.3 \pm 15.6	76.6 \pm 16.6	-
	SV-RCNet [12]+	85.3 \pm 7.3	80.7 \pm 7.0	83.5 \pm 7.5	-
	OHFM [20]+	87.3 \pm 5.7	-	-	67.0 \pm 13.3
	TeCNO [22]+	88.6 \pm 7.8	86.5 \pm 7.0	87.6 \pm 6.7	75.1 \pm 6.9
	TMRNet [23]+	90.1 \pm 7.6	90.3 \pm 3.3	89.5 \pm 5.0	79.1 \pm 5.7
	Trans-SVNet [13]+	90.3 \pm 7.1	90.7 \pm 5.0	88.8 \pm 7.4	79.3 \pm 6.6
	LoViT (ours)+	92.40 \pm 6.3	89.9 \pm 6.1	90.6 \pm 4.4	81.2 \pm 9.1
	Trans-SVNet	89.1 \pm 7.0	84.7	83.6	72.5
AVT [31]	86.7 \pm 7.6	77.3	82.1	66.4	
LoViT (ours)	91.5 \pm 6.1	83.1	86.5	74.2	
AutoLaparo	SV-RCNet	75.6	64.0	59.7	47.2
	TMRNet	78.2	66.0	61.5	49.6
	TeCNO	77.3	66.9	64.6	50.7
	Trans-SVNet	78.3	64.2	62.1	50.7
	AVT	77.8 \pm 9.4	68.0	62.2	50.7
	LoViT (ours)	81.4 \pm 7.6	85.1	65.9	55.9

2-layer encoder and a 1-layer decoder. The fusion modules in the multi-scale head have a 2-layer encoder and a 1-layer decoder. To improve efficiency, the gradients for L_s -Trans were calculated using the last $\lambda_1 = 100$ frames and the gradients for L_l -Trans were calculated using the last $\lambda_2 = 500$ frames. About the proposed phase transition map, we set $\sigma_l = 3$ and $\sigma_r = 12$.

3.3. Evaluation.

In this paper, we investigate the performance of LoViT in comparison with state-of-the-art approaches, followed by extensive ablation experiments to demonstrate the effect its different components have on a surgical phase recognition task. In accordance with previous work, we use four frequently-used measures in surgical phase recognition, namely accuracy (AC), precision (PR), recall (RE), and Jaccard (JA). AC refers to the percentage of correctly recognized frames and is video-based. However, the video class is imbalanced, and the short phases only have little impact on the whole video’s accuracy. To evaluate our model in multiple dimensions, we further adapt class- (phase-) level precision, recall, and Jaccard, which represent positive predictive value, positive rate, and intersection rate of recognition versus ground truth, respectively.

4. Results

4.1. Comparison with state-of-the-art methods

¹Refer to the code: <https://github.com/YuemingJin/TMRNet/blob/main/code/eval/result/matlab-eval/Evaluate.m>. These metrics consider predictions that fall into neigh-

To evaluate the effectiveness of our proposed method, we conducted a comparative analysis of LoViT against other state-of-the-art approaches that are relevant to action anticipation and surgical phase recognition tasks. This analysis was carried out on two datasets: Cholec80 [14] and AutoLaparo [35].

The quantitative comparison on Cholec80 dataset is organised in the top section of Table 1. Note that we re-implemented Trans-SVNet using the model weights provided with the original manuscript. For AVT, we used 30 input frames based on the publicly available code provided with their published manuscript. The results of the other state-of-the-art methods were extracted verbatim from their respective published works. We did not include other state-of-the-art methods such as OperA [33] in our study as they use a different dataset split for training and testing and do not have publicly available code accompanying their manuscript. Table 1 demonstrates that LoViT outperforms other methods on most metrics, with the exception of precision and recall on the Cholec80 dataset. Specifically, for precision, LoViT ranks third after MTRCNet-CL and Trans-SVNet, and for recall, it ranks second after MTRCNet-CL. LoViT achieves higher accuracy than the current state-of-the-art benchmark Trans-SVNet, with a margin of 2.4 pp (percentage points). Even compared to MTRCNet-CL, a multi-task learning method that requires additional information in the form of tool labels, LoViT exhibited higher performance with a margin of 2.3 pp accuracy. LoViT also outperformed AVT, which is the champion model for action anticipation and is similar to phase recognition, by 4.8 pp accuracy. Furthermore, our model showed a lower standard deviation of the accuracy of approximately 1.5 pp compared to Trans-SVNet, MTRCNet-CL, and AVT.

The quantitative comparison on AutoLaparo dataset is depicted in the bottom section of Table 1. We reference [35] to populate Table 1 with existing methods evaluated on this dataset. We observe that TMRNet [23], TeCNO [22], and Trans-SVNet [13] perform similarly on this dataset with average accuracy of 77%. Evidence [35] suggests that AutoLaparo is more challenging because of the complex workflow with a small dataset scale. Compared to the state-of-the-art method Trans-SVNet, we observed LoViT had a higher performance with a 3.1 pp accuracy margin. Besides video-level accuracy, we highlight that reported phase-level metrics are crucial due to the imbalance of phase distribution. Compared with Trans-SVNet, an increase of 20.9 pp (64.2% \rightarrow 85.1%), 3.8 pp (62.1% \rightarrow 65.9%), and 5.2 pp (50.7% \rightarrow 55.9%) margins were achieved using LoViT in relation to precision, recall, and Jaccard, respectively. In

bouring phases as correct, within a 10-second window around the phase transition. We do not support this approach of allowing boundary mistakes to improve metric values, as phase transition prediction is also an important indicator of a model’s ability. However, we include this approach to ensure a fair comparison with previous methods.

summary, LoViT consistently outperformed in both video-level and phase-level as evidenced by these evaluation metric results.

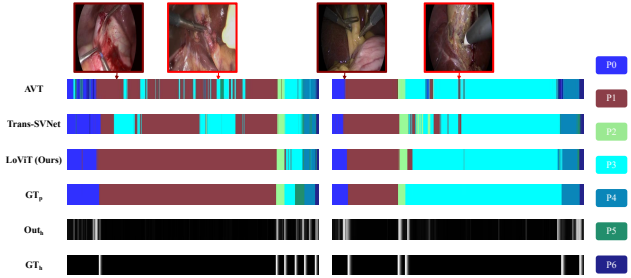

Figure 6: Qualitative comparisons with some other methods on Cholec80 dataset. The first line presents some images in the video corresponding to the moment pointed by the red arrow, where light red present wrong examples of both AVT and Trans-SVNet, and dark red present wrong examples of only Trans-SVNet. The following four lines represent the phase results recognised by different methods and corresponding Ground Truth GT_p . The last two lines mean the output of heatmap by proposed LoViT \hat{h} and its Ground Truth GT_h .

To illustrate the performance of our approach in comparison with the state-of-the-art, in Fig. 6 we present a qualitative comparison of two examples drawn from the Cholec80 testing dataset. As observed in Fig. 6, for some ambiguous frames shown (first row), Trans-SVNet was unable to classify the correct phase effectively. Even though the surgical phases of laparoscopic cholecystectomy are linearly executed, video frames are misclassified into phases that are strictly nonlinear. In contrast, LoViT learned a better long-term temporal context than Trans-SVNet, even when a few misclassifications are still nonlinear. Even for some examples (first row with dark red box), Trans-SVNet performs worse than AVT, which inputs short video clips. This further proves that Trans-SVNet loses some fine-grained and continuity information while processing long videos. When investigating the performance in learning the heatmap capturing phase transitions, we observed that LoViT’s performance is highly accurate compared to the ground truth, as shown in the last two rows of Fig. 6. In our ablation studies, we demonstrate the benefit of including heatmap information since it further helps to extract relationships among phases.

4.2. Evaluating LoViT architecture performance

We conducted experiments to measure the contributions of the three modules that comprise our proposed model, LoViT. These modules are: 1) Local Temporal Feature Aggregator (L-Trans), 2) Global Temporal Feature Aggregator

Table 2: The results (%) of different parts of proposed LoViT on both the Cholec80 and the AutoLaparo datasets. The best results are marked in bold.

Dataset	Model	Video-level Metric		Phase-level Metric	
		Accuracy \uparrow	Precision \uparrow	Recall \uparrow	Jaccard \uparrow
Cholec80	L-Trans	90.81 \pm 5.85	82.51	86.48	72.92
	G-Informer	91.52 \pm 5.76	83.29	86.98	74.55
	LoViT	91.50 \pm 6.10	83.07	86.5	74.15
AutoLaparo	L-Trans	80.60 \pm 6.93	69.70	65.08	54.02
	G-Informer	79.75 \pm 7.32	70.33	63.64	53.43
	LoViT	81.43 \pm 7.35	85.07	65.85	55.90

(G-Informer), and 3) Multi-scale Temporal Feature Fusion Module (MF-Trans). Specifically, we conducted the following experiments:

- **L-Trans:** We evaluated the performance of the time aggregation model when it only contained the L-Trans module for capturing local fine-grained features without the integration of global relationships.
- **G-Informer:** We evaluated the performance of a model that included time aggregation by the G-Informer module following the L-Trans. The coarse-grained information resulting from G-Informer was then directly fed into the classifier.
- **LoViT:** We evaluated the performance of our full LoViT model, which includes both the temporal local and global Transformers, followed by a multi-scale temporal fusion head.

The quantitative experiment results are shown in Table 2. Based on the results of L-Trans and G-Informer, it can be observed that G-Informer performed better on the Cholec80 dataset while L-Trans performed better on the AutoLaparo dataset. This suggests that global relationships are more helpful for recognizing the videos in Cholec80, while fine-grained features are more critical for AutoLaparo. This finding is consistent with the fact that most videos in AutoLaparo contain recurring phases, while the workflow in Cholec80 videos is much more linear. Thus, global relationships are more critical for Cholec80, while fine-grained features are more critical for AutoLaparo, as indicated by the experimental results. Comparing the performance of LoViT with that of L-Trans and G-Informer, we can see that LoViT performs only slightly worse than G-Informer on Cholec80, but outperforms the other two models when evaluated on AutoLaparo. This suggests that while global relationships are important for Cholec80, fine-grained features are crucial for AutoLaparo. Moreover, it is evident that the feature map g produced by G-Informer is more prone to losing fine-grained information than l , which is extracted by L-Trans. However, LoViT overcomes this limitation through the multi-scale fusion of l and g , allowing the analysis of

Table 3: Effects (%) of Temporally-rich spatial feature extractor (\mathcal{R}) on Cholec80 and AutoLaparo datasets. The best results are marked in bold.

Dataset	\mathcal{R}	Video-level Metric		Phase-level Metric	
		Accuracy \uparrow	Precision \uparrow	Recall \uparrow	Jaccard \uparrow
Cholec80		90.66 \pm 6.89	80.81	85.21	71.42
	\checkmark	91.50 \pm 6.10	83.07	86.5	74.15
AutoLaparo		79.53 \pm 8.36	79.61	64.85	53.74
	\checkmark	81.43 \pm 7.35	85.07	65.85	55.90

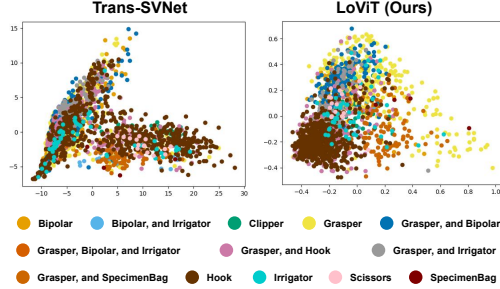

Figure 7: Visualization for the spatial feature distribution of different extractors. Point set: Video frames of Video 60 in Cholec80. Different colors: different tool annotations. First column: the spatial feature distribution of the frame-only spatial feature extractor in Trans-SVNet. Second column: the spatial feature distribution of the temporally-rich spatial feature extractor in our LoViT.

every frame from different dimensions and resulting in improved recognition accuracy and greater stability.

4.3. Evaluating temporally-rich spatial feature extractor performance

We investigated the impact of our temporally-rich spatial feature extractor. The results in Table 3 demonstrate that using video clips as inputs for training temporally-rich spatial feature extractor contributes to higher performance, where the extractor inputs every single frame separately. This increase in performance is particularly notable on the AutoLaparo dataset, where we observe an improvement margin of 1.9 pp in accuracy. It is worth noting that even after replacing the temporally-rich spatial feature extractor with a normal spatial feature extractor, LoViT still outperforms current state-of-the-art methods. To better understand the superiority of our temporally-rich spatial feature extractor compared to Trans-SVNet, we conducted a principal component analysis (PCA) [40] on their feature space and projected them into a two-dimensional reduced space representation for visualization. In Fig. 7, we plotted the 2-dim feature representation of all frames in a video, labeled by the instruments appearing in each frame. We observed that our proposed temporally-rich spatial feature extractor was more

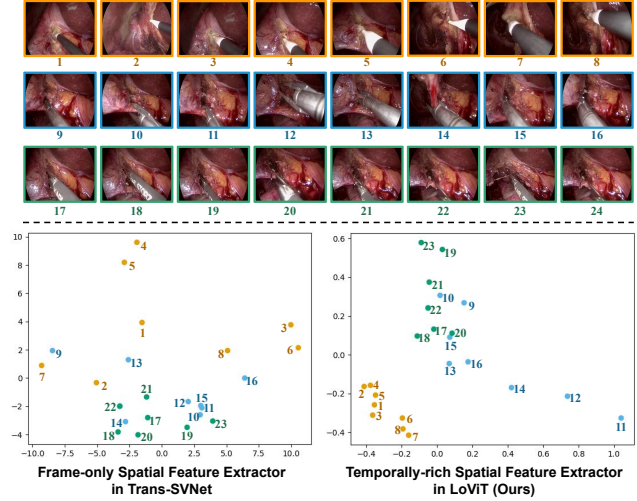

Figure 8: Examples of spatial feature distribution of similar video frames. *Top*: three rows depict each frame that is similar, i.e. in regards to the tool environment. *Bottom*: Visualization of the spatial feature distribution of example images using two different extractors.

Table 4: Effects of adding phase transition-aware supervision on video- and phase-level metrics (%) when evaluated on Cholec80 and AutoLaparo datasets. Note that ‘ \checkmark ’ means adding phase transition-aware supervision.

Dataset	Phase Transition-aware	Video-level Metric		Phase-level Metric	
		Accuracy \uparrow	Precision \uparrow	Recall \uparrow	Jaccard \uparrow
Cholec80		90.07 \pm 5.98	82.23	84.58	71.67
	\checkmark	91.50 \pm 6.10	83.07	86.5	74.15
AutoLaparo		77.86 \pm 7.88	71.03	64.78	52.56
	\checkmark	81.43 \pm 7.35	85.07	65.85	55.90

effective in differentiating between different tools than the frame-only training method used in Trans-SVNet, as there was greater distinction between labeled frames in the reduced space. However, using tool labels to describe spatial features is insufficient for studying feature representations, since other objects appearing in a scene such as organs may also affect image features. To further investigate this, we manually selected three groups of illustrative frames with similar organ context and grouped them by the instrument appearing in the scene. We then visualized their spatial feature distributions in Fig. 8, providing further evidence of the superiority of our method over previous spatial feature extractors.

4.4. Evaluating phase transition-aware supervision performance

We evaluate the influence of our proposed heatmap for better learning phase transitions of surgical videos. Table 4 illustrates the improvement in our model’s performance on

both datasets when we used supervised phase transition map to capture the phase transition areas. These findings emphasize the importance of phase transition areas in surgical videos, as they contain critical information for identifying the start and end of each phase. By capturing these transitions, we gain a better understanding of phase relationships, which ultimately helps in reducing confusion between similar clips.

4.5. Discussion

Spatial feature extractor networks are typically trained for surgical phase recognition using image-only level supervision due to limited computing resources. However, our work indicates that a temporally-rich spatial feature extractor is essential for supporting an accurate recognition network. In this study, we demonstrate that our temporally-rich spatial feature extractor on two datasets whilst having video clips as inputs is better than image-only level supervision for training a spatial feature extractor. This approach is particularly beneficial for surgical videos since there might be a large number of frames with similar characteristics across different phases due to some scenes changing only slightly and showing a limited amount of tools. We illustrate this in Fig. 2 with scenes having similar spatial features and actions occasionally appearing at different phases (classes), resulting in the extractor being confused and in our model to overfit because different labels supervise the same spatial features. Since key information in surgical videos is generally found at the beginning of every phase for distinguishing the phase of a given frame, we select a fix number of frame images from the beginning of the current phase to the current frame considered for classification spaced at regular intervals, whilst having the current frame’s phase label as output to train our rich spatial feature extractor. By doing this, our model retains the key temporal information to recognize the phase of the current frame on the limitation of memory capacity.

Similar to the above mentioned problem, similar actions occasionally appear at different surgical phases. Therefore, surgical phase recognition requires models that can process long sequences of video frames and extract their temporal relationships since interventions are typically long, generally lasting between one to two hours for cholecystectomy (Cholec80) and hysterectomy (AutoLaparo), whilst other interventions could even last longer, especially when complications arise. Although the two most recent state-of-the-art methods for surgical phase recognition, namely TeCNO [22] and Trans-SVNet [13], are capable of processing long videos using TCNs [24], their dilated temporal aggregation approach is unable to handle misclassifications of surgical phases due to the loss of fine-grained features. In this work, we adopted a Transformer-based model to aggregate temporal features, including vanilla self-attention

mechanism for local short video clips and *ProbSparse* self-attention mechanism for global long video, which outperforms TeCNO and Trans-SVNet. Moreover, even Trans-SVNet under-performed AVT in some cases as shown in Fig. 6, a method that could only input short videos. Accordingly, from our results, it is suggested that dilated convolution operations that are part of TCN result in the model losing fine-grained features and continuous information. In this way, vanilla and *ProbSparse* self-attention operations demonstrate better performance over TCNs within the scope of our study.

Surgical videos are characterised by time dependency among phases, and pinpointing the phase transition areas is essential for discovering such dependency. To the best of our knowledge, we are the first to represent phase transitions with a phase transition map, which is utilised to supervise the model. From the experimental results, we observe that this phase transition map improves the performance of our proposed model. We notice that phase transition-aware supervision is an easy operation and does not impose an additional burden on the model.

Considering the experiment results on datasets Cholec80 and AutoLaparo, we observe that AutoLaparo is more challenging than Cholec80. Apart from the lower performances of all methods on AutoLaparo, we found that different previous methods performed similarly on it. However, LoViT outperformed TMRNet, TeCNO, and Trans-SVNet. Specifically, we proved that local information is more valuable than the global relationship in the experimental results. Most videos in AutoLaparo contain repeated phases, which causes more complex phase relationships than videos in Cholec80. This limitation is exacerbated by the small sample size of AutoLaparo, which result in models having lower performance when compared to their performance observed in Cholec80.

5. Conclusions

We propose a new surgical phase recognition method named LoViT, which adopts video-clip level supervision to train a temporally-rich spatial feature extractor first and then uses the Multi-scale temporal feature aggregator to combine local fine-grained and global macroscopic information to recognise phases. Specifically, our Transformer-based LoViT allows long video feeds with less loss of information than other existing methods. Moreover, our LoViT utilises the heatmap to learn phases transition, which is significant to grab the relationship between phases. The proposed LoViT achieves state-of-the-art performance with great improvement over existing methods.

Even though LoViT shows superior performance, it remains difficult for LoViT to accurately recognise some phases that appear in an unusual operation process. As shown in the left video of Fig. 6, ‘P5’ appears after ‘P4’

in most videos, but before ‘P4’ in this video, which is difficult to be recognised by LoViT, and other recognition methods. We believe future research on online surgical phase recognition will focus more on discovering complex relationships between phases, an area we envisage continuing to investigate on. Furthermore, despite the efficiency of LoViT’s *ProbSparse* self-attention mechanism, it still requires feeding all previous spatial features into the temporal model for recognition of each current frame. As the duration of the surgery increases, the inference speed of LoViT will deteriorate if it takes all video frames input. An ideal method, however, should avoid redundant calculations by utilizing the previous analysis results, thereby reducing time and memory costs, improving the stability of the system’s inference speed, and enabling the processing of videos of any length, which aligns with our research direction.

References

- [1] L. Maier-Hein, M. Eisenmann, and S. Speidel, “Surgical data science - from concepts to clinical translation,” *CoRR*, vol. abs/2011.02284, 2020.
- [2] T. Vercauteren, M. Unberath, N. Padoy, and N. Navab, “CAI4CAI: the rise of contextual artificial intelligence in computer-assisted interventions,” *Proc. IEEE*, vol. 108, no. 1, pp. 198–214, 2020.
- [3] C. R. Garrow, K.-F. Kowalewski, L. Li, M. Wagner, M. W. Schmidt, S. Engelhardt, D. A. Hashimoto, H. G. Kenngott, S. Bodenstedt, S. Speidel *et al.*, “Machine learning for surgical phase recognition: a systematic review,” *Annals of surgery*, vol. 273, no. 4, pp. 684–693, 2021.
- [4] G. Quellec, M. Lamard, B. Cochener, and G. Cazuguel, “Real-time task recognition in cataract surgery videos using adaptive spatiotemporal polynomials,” *IEEE Trans. Medical Imaging*, vol. 34, no. 4, pp. 877–887, 2015.
- [5] O. Dergachyova, D. Bouget, A. Huault, X. Morandi, and P. Jannin, “Automatic data-driven real-time segmentation and recognition of surgical workflow,” *Int. J. Comput. Assist. Radiol. Surg.*, vol. 11, no. 6, pp. 1081–1089, 2016.
- [6] T. Blum, H. Feußner, and N. Navab, “Modeling and segmentation of surgical workflow from laparoscopic video,” in *Medical Image Computing and Computer-Assisted Intervention - MICCAI 2010, 13th International Conference, Beijing, China, September 20-24, 2010, Proceedings, Part III*, 2010, pp. 400–407.
- [7] N. Padoy, T. Blum, S. Ahmadi, H. Feußner, M. Berger, and N. Navab, “Statistical modeling and recognition of surgical workflow,” *Medical Image Anal.*, vol. 16, no. 3, pp. 632–641, 2012.
- [8] H. Sakoe and S. Chiba, “Dynamic programming algorithm optimization for spoken word recognition,” *IEEE Transactions on Acoustics, Speech, and Signal Processing*, vol. 26, no. 1, pp. 43–49, 1978.
- [9] L. R. Rabiner, “A tutorial on hidden markov models and selected applications in speech recognition,” *Proc. IEEE*, vol. 77, no. 2, pp. 257–286, 1989.
- [10] J. E. Bardram, A. Doryab, R. M. Jensen, P. M. Lange, K. L. G. Nielsen, and S. T. Petersen, “Phase recognition during surgical procedures using embedded and body-worn sensors,” in *Ninth Annual IEEE International Conference on Pervasive Computing and Communications, PerCom 2011, 21-25 March 2011, Seattle, WA, USA, Proceedings*, 2011, pp. 45–53.
- [11] M. S. H. *et al.*, “Feasibility of real-time workflow segmentation for tracked needle interventions,” *IEEE Trans. Biomed. Eng.*, vol. 61, no. 6, pp. 1720–1728, 2014.
- [12] Y. J. *et al.*, “Sv-rcnet: Workflow recognition from surgical videos using recurrent convolutional network,” *IEEE Trans. Medical Imaging*, vol. 37, no. 5, pp. 1114–1126, 2018.
- [13] X. Gao, Y. Jin, Y. Long, Q. Dou, and P. Heng, “Trans-svnet: Accurate phase recognition from surgical videos via hybrid embedding aggregation transformer,” in *Medical Image Computing and Computer Assisted Intervention - MICCAI 2021 - 24th International Conference, Strasbourg, France, September 27 - October 1, 2021, Proceedings, Part IV*, 2021, pp. 593–603.
- [14] A. P. Twinanda, S. Shehata, D. Mutter, J. Marescaux, M. de Mathelin, and N. Padoy, “Endonet: A deep architecture for recognition tasks on laparoscopic videos,” *IEEE Trans. Medical Imaging*, vol. 36, no. 1, pp. 86–97, 2017.
- [15] Y. Lecun, L. Bottou, Y. Bengio, and P. Haffner, “Gradient-based learning applied to document recognition,” *Proceedings of the IEEE*, vol. 86, no. 11, pp. 2278–2324, 1998.
- [16] A. P. Twinanda, “Vision-based approaches for surgical activity recognition using laparoscopic and RGBD videos. (approches basées vision pour la reconnaissance d’activités chirurgicales à partir de vidéos laparoscopiques et multi-vues RGBD),” Ph.D. dissertation, University of Strasbourg, France, 2017.
- [17] S. Hochreiter and J. Schmidhuber, “Long short-term memory,” *Neural Computation*, vol. 9, no. 8, pp. 1735–1780, 1997.
- [18] Y. J. *et al.*, “Multi-task recurrent convolutional network with correlation loss for surgical video analysis,” *Medical Image Anal.*, vol. 59, 2020.
- [19] K. He, X. Zhang, S. Ren, and J. Sun, “Deep residual learning for image recognition,” in *2016 IEEE Conference on Computer Vision and Pattern Recognition, CVPR 2016, Las Vegas, NV, USA, June 27-30, 2016*, 2016, pp. 770–778.
- [20] F. Yi and T. Jiang, “Hard frame detection and online mapping for surgical phase recognition,” in *Medical Image Computing and Computer Assisted Intervention - MICCAI 2019 - 22nd International Conference, Shenzhen, China, October 13-17, 2019, Proceedings, Part V*, 2019, pp. 449–457.
- [21] X. Gao, Y. Jin, Q. Dou, and P. Heng, “Automatic gesture recognition in robot-assisted surgery with reinforcement

- learning and tree search,” in *2020 IEEE International Conference on Robotics and Automation, ICRA 2020, Paris, France, May 31 - August 31, 2020*, 2020, pp. 8440–8446.
- [22] T. C. et al., “Tecno: Surgical phase recognition with multi-stage temporal convolutional networks,” in *Medical Image Computing and Computer Assisted Intervention - MICCAI 2020 - 23rd International Conference, Lima, Peru, October 4-8, 2020, Proceedings, Part III*, 2020, pp. 343–352.
- [23] Y. Jin, Y. Long, C. Chen, Z. Zhao, Q. Dou, and P. Heng, “Temporal memory relation network for workflow recognition from surgical video,” *IEEE Trans. Medical Imaging*, vol. 40, no. 7, pp. 1911–1923, 2021.
- [24] C. Lea, R. Vidal, A. Reiter, and G. D. Hager, “Temporal convolutional networks: A unified approach to action segmentation,” in *Computer Vision - ECCV 2016 Workshops - Amsterdam, The Netherlands, October 8-10 and 15-16, 2016, Proceedings, Part III*, 2016, pp. 47–54.
- [25] Y. A. Farha and J. Gall, “MS-TCN: multi-stage temporal convolutional network for action segmentation,” in *IEEE Conference on Computer Vision and Pattern Recognition, CVPR 2019, Long Beach, CA, USA, June 16-20, 2019*, 2019, pp. 3575–3584.
- [26] A. van den Oord et al., “Wavenet: A generative model for raw audio,” in *The 9th ISCA Speech Synthesis Workshop, Sunnyvale, CA, USA, 13-15 September 2016*, 2016, p. 125.
- [27] A. V. et al., “Attention is all you need,” in *Advances in Neural Information Processing Systems 30: Annual Conference on Neural Information Processing Systems 2017, December 4-9, 2017, Long Beach, CA, USA*, 2017, pp. 5998–6008.
- [28] A. D. et al., “An image is worth 16x16 words: Transformers for image recognition at scale,” in *9th International Conference on Learning Representations, ICLR 2021, Virtual Event, Austria, May 3-7, 2021*, 2021.
- [29] G. Bertasius, H. Wang, and L. Torresani, “Is space-time attention all you need for video understanding?” in *Proceedings of the International Conference on Machine Learning (ICML)*, July 2021.
- [30] A. Arnab, M. Dehghani, G. Heigold, C. Sun, M. Lucic, and C. Schmid, “Vivit: A video vision transformer,” in *2021 IEEE/CVF International Conference on Computer Vision, ICCV 2021, Montreal, QC, Canada, October 10-17, 2021*, 2021, pp. 6816–6826.
- [31] R. Girdhar and K. Grauman, “Anticipative video transformer,” in *2021 IEEE/CVF International Conference on Computer Vision, ICCV 2021, Montreal, QC, Canada, October 10-17, 2021*, 2021, pp. 13 485–13 495.
- [32] D. Damen, H. Doughty, G. M. Farinella, , A. Furnari, J. Ma, E. Kazakos, D. Moltisanti, J. Munro, T. Perrett, W. Price, and M. Wray, “Rescaling egocentric vision: Collection, pipeline and challenges for epic-kitchens-100,” *International Journal of Computer Vision (IJCV)*, vol. 130, p. 33–55, 2022.
- [33] T. Czempiel, M. Paschali, D. Ostler, S. T. Kim, B. Busam, and N. Navab, “Opera: Attention-regularized transformers for surgical phase recognition,” in *Medical Image Computing and Computer Assisted Intervention - MICCAI 2021 - 24th International Conference, Strasbourg, France, September 27 - October 1, 2021, Proceedings, Part IV*, 2021, pp. 604–614.
- [34] H. Z. et al., “Informer: Beyond efficient transformer for long sequence time-series forecasting,” in *Thirty-Fifth AAAI Conference on Artificial Intelligence, AAAI 2021*, 2021, pp. 11 106–11 115.
- [35] Z. Wang, B. Lu, Y. Long, F. Zhong, T.-H. Cheung, Q. Dou, and Y. Liu, “Autolaparo: A new dataset of integrated multi-tasks for image-guided surgical automation in laparoscopic hysterectomy,” in *Medical Image Computing and Computer Assisted Intervention - MICCAI 2022*, 2022.
- [36] A. Paszke, S. Gross, and S. Chintala, “Pytorch: An imperative style, high-performance deep learning library,” in *Advances in Neural Information Processing Systems 32: Annual Conference on Neural Information Processing Systems 2019, NeurIPS 2019, December 8-14, 2019, Vancouver, BC, Canada*, 2019, pp. 8024–8035.
- [37] J. Deng, W. Dong, R. Socher, L. Li, K. Li, and L. Fei-Fei, “Imagenet: A large-scale hierarchical image database,” in *2009 IEEE Computer Society Conference on Computer Vision and Pattern Recognition (CVPR 2009)*, 20-25 June 2009, Miami, Florida, USA, 2009, pp. 248–255.
- [38] P. G. et al., “Accurate, large minibatch SGD: training imagenet in 1 hour,” *CoRR*, vol. abs/1706.02677, 2017.
- [39] A. P. Twinanda, D. Mutter, J. Marescaux, M. de Mathelin, and N. Padoy, “Single- and multi-task architectures for surgical workflow challenge at M2CAI 2016,” *CoRR*, vol. abs/1610.08844, 2016.
- [40] H. Hotelling, “Analysis of a complex of statistical variables into principal components.” *Journal of educational psychology*, vol. 24, no. 6, p. 417, 1933.