

An Adversarial Non-Autoregressive Model for Text Generation with Incomplete Information

Da Ren

*Department of Computing
The Hong Kong Polytechnic University
Hong Kong, China*

CSDREN@COMP.POLYU.EDU.HK

Yi Cai

*Key Laboratory of Big Data and Intelligent Robot (SCUT)
MOE of China
School of Software Engineering
South China University of Technology
Guangzhou, China*

YCAI@SCUT.EDU.CN

Qing Li

*Department of Computing
The Hong Kong Polytechnic University
Hong Kong, China*

CSQLI@COMP.POLYU.EDU.HK

Editor: -

Abstract

Non-autoregressive models have been widely studied in the Complete Information Scenario (CIS), in which the input has complete information of corresponding output. However, their explorations in the Incomplete Information Scenario (IIS) are extremely limited. Our analyses reveal that the IIS’s incomplete input information will augment the inherent limitations of existing non-autoregressive models trained under Maximum Likelihood Estimation. In this paper, we propose for the IIS an Adversarial Non-autoregressive Transformer (ANT) which has two features: 1) Position-Aware Self-Modulation to provide more reasonable hidden representations, and 2) Dependency Feed Forward Network to strengthen its capacity in dependency modeling. We compare ANT with other mainstream models in the IIS and demonstrate that ANT can achieve comparable performance with much fewer decoding iterations. Furthermore, we show its great potential in various applications like latent interpolation and semi-supervised learning.

Keywords: Non-Autoregressive, GANs, Incomplete Information, Text Generation, Generative Models

1 Introduction

Non-autoregressive (NAR) models have lower decoding latency compared with autoregressive (AR) models hence received growing attention from the research community (Huang et al., 2022a). NAR models are emerging in tasks like machine translation (Gu et al., 2018) and text summarization (Liu et al., 2022). These tasks are based on the scenario where the input contains complete information of target sentences. However, another scenario in which the input does not possess complete target information, is seldomly explored in

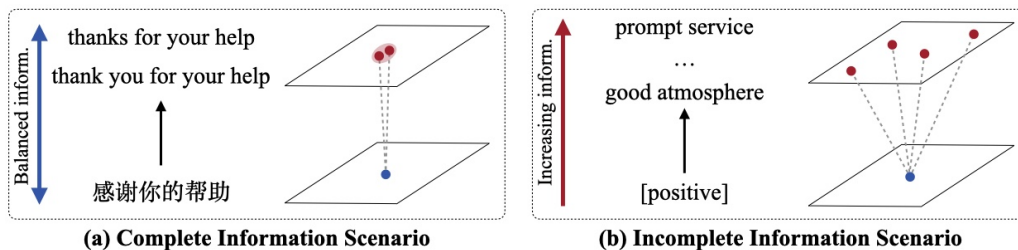

Figure 1: Comparisons between the CIS and IIS. (a) Translating a sentence. (b) Generating comments based on an emotion label.

the study of NAR models. For convenience, we denote these two scenarios as the **Complete Information Scenario (CIS)** and **Incomplete Information Scenario (IIS)**, respectively.

The IIS covers both unconditional and conditional generation tasks, such as generating sentences based on given attributes (Keskar et al., 2019), writing stories based on limited clues (Fan et al., 2018) and supporting semi-supervised learning (Xu et al., 2017). Models for these tasks need to obtain long texts or even infer new data during training process. The decoding latency will be augmented, thereby significantly increasing the computation cost. Extending NAR models (which have lower decoding latency) to the IIS is therefore a promising line of further developments for these tasks.

To this end, we begin with a thorough analysis of existing NAR models which are trained on Maximum Likelihood Estimation (MLE). Due to the lost of word dependencies, these models tend to mix words in different candidates. This problem, which is known as the multi-modality problem (Gu et al., 2018), will be exacerbated in the IIS. As shown in Figure 1, in the CIS, the number of possible candidates and their diversity are significantly constrained by the input so as to maintain balanced input and output information. In the IIS, however, because of the incomplete input information, addition information is needed to obtain the output. Complementing different information will lead to completely different results, so the candidate number and the output diversity will significantly increase. Models without word dependencies will easily mix words in different candidates and generate ungrammatical sentences.

The limitations of existing NAR models can also be analyzed from a theoretical perspective. More specifically, optimizing NAR models with MLE remains non-negative lower bounds between the learned distributions and the real distributions (Huang et al., 2022a). The increase of candidate number in the IIS will increase the lower bounds, and thus increase the discrepancy between the distributions of real data and generated data. This unavoidable limitation will directly lead the models to generate sentences out of real distributions which are always ungrammatical ones.

The inherent limitations of MLE prompt us to pay attention to another family of generative models: Generative Adversarial Networks (GANs) (Goodfellow et al., 2014). The synthetic distributions of GANs can theoretically converge to the real distributions regardless of model structures, so they are free from the multi-modality problem. More importantly, it can obtain high quality samples in one single forward pass, which exactly meets

the needs of NAR models. Instead of adopting unstable *REINFORCE* (Williams, 1992) or biased *continuous relaxations* (Jang et al., 2017) to process the non-differentiable sampling operation in language GANs, we follow the research line of representation modeling methods (Ren and Li, 2022) and propose an **Adversarial Non-autoregressive Transformer (ANT)** for the IIS. There are two features in ANT: Position-Aware Self-modulation for obtaining more reasonable hidden representations; and Dependency Feed Forward network (Dependency FFN) for helping the model to capture more accurate word dependencies in the unstable training of GANs. The experimental results demonstrate that ANT gets comparable performance as existing AR models in the IIS but achieves lower decoding latency. The contributions of this paper can be summarized as follows:

- We articulate the significance of the IIS in text generation, and compare the differences between the CIS and IIS. Moreover, we reveal the limitations of existing (MLE-based) NAR models in the IIS from both empirical and theoretical aspects.
- Based on GANs, we propose an Adversarial Non-autoregressive Transformer (ANT), which supports two features, Position-Aware Self-modulation and Dependency FFN, to further improve its performance by providing more reasonable representations and enhance its capacity in dependency modeling.
- We compare the performance of ANT with existing models. The experimental results demonstrate that ANT can get comparable performance as other models with much lower decoding latency. We also show the great potential of ANT in various applications like latent interpolation and semi-supervised learning. To the best of our knowledge, it is the first work demonstrating the effectiveness of GANs in building NAR models.

This paper is structured as follows. In Section 2, we analyze the limitations of exiting MLE-based NAR models and give an overview to the development of NAR models and language GANs. In Section 3, we introduce the details about ANT. We introduce our experiments and analyze experiment results in Section 4. Finally, we draw a conclusion in Section 5.

2 Background

2.1 Limitations of MLE in the IIS

NAR models were first proposed for machine translation (Gu et al., 2018) and later extended to other tasks like text summarization (Liu et al., 2022). Most of them are based on MLE and have low decoding latency, but always sacrifice sample quality. Existing NAR models suffer from the multi-modality problem due to the lack of word dependencies. This problem will be augmented in the IIS, since there are more candidates, and it can also be illustrated from a theoretical perspective.

2.1.1 THEORETICAL ANALYSIS

Given a MLE-based NAR model $P_\theta(Y|X)$, Huang et al. (2022a) reveal a non-negative lower bound between the leaned distribution and the real distribution. More specifically,

$\min_{\theta} KL(P_{data}(Y|X)||P_{\theta}(Y|X)) \geq C$, where $C = \sum_{i=1}^l H_{data}(y_i|X) - H_{data}(Y|X)$. C is also known as conditional total correlation. Based on it, we further analyze the difference of the conditional total correlation when the scenario is changed from CIS to IIS. We analyze this problem by considering the transformations from two different input \mathbb{A} and \mathbb{B} to output \mathbb{T} . Due to the complexity of real data, our analysis is based on the simplifications in **Assumption 1**.

Assumption 1. *Each target sequence $Y \in \mathbb{T}$ is consisted of l elements. There are no identical elements in the candidates. Each input $X_A \in \mathbb{A}$ has n target sequences as candidates and each input $X_B \in \mathbb{B}$ has m target candidates. Each Y can only be mapped by a specific input. All the input and target sequences follow uniform distributions.*

Based on **Assumption 1**, we obtain **Theorem 1** to describe the difference of the conditional total correlation between two different input \mathbb{A} and \mathbb{B} .

Theorem 1. *The difference between the conditional total correlation of input \mathbb{A} and \mathbb{B} has the following relation: $C_A - C_B = (l - 1) \cdot \log(n/m)$.*

The proof of **Theorem 1** can be found in Appendix A. **Theorem 1** reveals the relations between the difference of the conditional total correlation, sequence length l , and candidate numbers n and m . Furthermore, we obtain a mark on **Theorem 1**:

Mark 1. *If $n > m$, then $C_A > C_B$. Higher l and n lead to higher difference between C_A and C_B .*

Comparing to the CIS, input in the IIS always corresponds to more possible candidates, so its conditional total correlation will be higher. The larger gap between the learned distributions and the real distributions will lead MLE-based NAR models to generate more ungrammatical results in the IIS.

2.1.2 EXISTING NAR MODELS IN THE IIS

To narrow down the gaps between NAR models and AR models, researchers improve performance from different perspectives including simplifying data distributions (Gu et al., 2018), adopting new training objectives (Du et al., 2021), and designing new modeling methods (Ghazvininejad et al., 2019).

Among them, there are two most popular techniques: 1) simplifying output with knowledge distillation (Kim and Rush, 2016); 2) enhancing input based on conditional masked language models (Ghazvininejad et al., 2019). Knowledge distillation simplifies the original one-to-many mapping relations into one-to-one relations, so to prevent models from mixing words in different candidates. However, the IIS requires the model to obtain a number of diverse results with same conditions, so it is necessary to directly model the original one-to-many relations. Conditional masked language models obtain results following an iteration manner, so it will inevitably have higher latency. Although these two techniques are so popular that most of exiting NAR models are deeply bound to at least one of them, they are not applicable methods if we want to build a fully NAR model in the IIS.

Recently, two NAR models, which do not rely on the two techniques above, are proposed: Diffusion-lm (Li et al., 2022) and Directed Acyclic Transformer (DA-Transformer) (Huang et al., 2022b). Diffusion-lm draws the idea of diffusion models (Ho et al., 2020; Dhariwal and Nichol, 2021) into text generation. It starts with Gaussian noise vectors and gradually

denoises them into specific word representations. Although it is effective on various tasks, it inherits the high latency feature of diffusion models. During inference, it requires 200-2000 steps to obtain the results, which has much higher decoding latency than AR models (Li et al., 2022).

DA-Transformer (Huang et al., 2022b) remedies the multi-modality problem by assigning various candidates to different paths in a directed acyclic graph. Although it obtains remarkable performance in machine translation, its theoretical convergence has not been proved yet. In our experiments, it fails to converge when migrating to the IIS. The key to its successful training is the peak path distributions led by the limited number of candidates. This kind of path distributions can avoid the model changing the candidates of other paths when updating the sample in one path (Huang et al., 2022b). In the IIS, each input corresponds to a lot of diverse candidates, and each vertex thus has many possible next vertices. The model needs to assign comparable transition probabilities to all these vertices and finally leads to a flat path distribution. In this time, the candidates in other paths will be inevitably changed when updating the sample in one path, and the model will finally fail to learn different candidates. Therefore, although there are various NAR models in the CIS, they are not reasonable choices for building fully NAR models in the IIS.

2.2 Language GANs

In contrast, GANs (Goodfellow et al., 2014) indicate a more promising training method for NAR models under the IIS. Their global optimal is achieved if and only if the learned distribution is exactly the same as the target one (Goodfellow et al., 2014). Their effectiveness is demonstrated in various tasks (Karras et al., 2020; Biau et al., 2021; Allouche et al., 2022; Sauer et al., 2022; Bot et al., 2023), but their explorations in NAR text generation are extremely limited. GANs can converge to the global optimal in both AR and NAR structures and thus do not have the multi-modality problem. More importantly, GANs can obtain high quality samples in one single forward pass, which exactly meets the needs of building fully NAR models.

Most of existing language GANs are based on AR structures (Yu et al., 2017; Che et al., 2017; Lin et al., 2017; Fedus et al., 2018). To tackle the non-differentiable sampling operation, they adopt *REINFORCE* (Williams, 1992) or *continuous relaxations* (Jang et al., 2017) which are of either high variance or biased estimators (Lin et al., 2020). Our work thus follows another research line, namely representation modeling method (Ren and Li, 2022). This method firstly maps words into representations and trains a generator to model these representations. It avoids the non-differentiable sampling operation during training process, so the gradients from discriminators can pass through to generators directly. This method is free from the limitations in *REINFORCE* or *continuous relaxations* and is demonstrated to be an effective way to train language GANs (Ren and Li, 2022).

NAGAN (Huang et al., 2021), which also adopts GANs to build NAR models, is the most similar work to ours, yet our work is different in three aspects: 1) we give in-depth analyses about the limitations of existing MLE-based NAR models from the perspective of incomplete information; 2) the performance of their model is significantly limited by the biased *straight-through estimator* (Bengio et al., 2013), whereas our model is free from this problem; 3) our proposed facilities: Position-Aware Self-Modulation and Dependency Feed

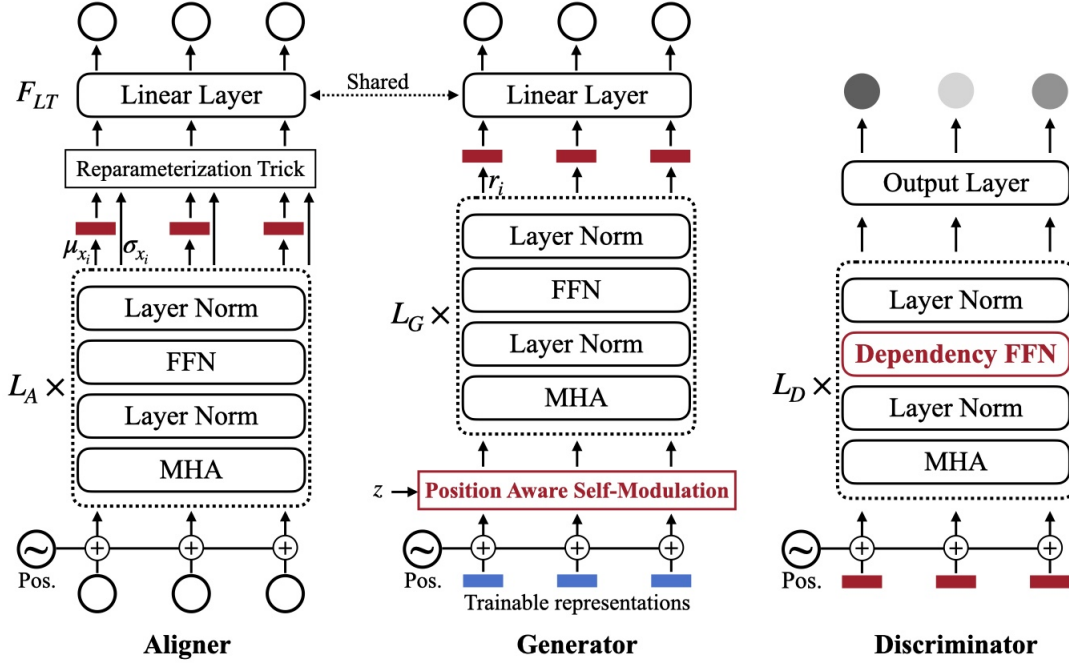

Figure 2: Structure of Adversarial Non-autoregressive Transformer (ANT)

Forward Network can further boost model performance and it is not explored in previous work.

3 Model

3.1 Model Structure

Based on the representation modeling framework (Ren and Li, 2022), we propose an Adversarial Non-autoregressive Transformer (ANT) which generates text in a fully NAR manner. As shown in Figure 2, there are three parts in ANT: aligner, discriminator and generator. The aligner maps words into representations, and the generator tries to recover these representations from input. The discriminator needs to identify whether input representations are from the aligner or the generator. We adopt Transformer (Vaswani et al., 2017) as the backbones of all the three parts to support highly parallel computation. An input is firstly added with a positional encoding and fed into encoder layers. Each encoder layer has a multi-head attention (MHA) module and feed forward network (FFN) module. A layer normalization is added after each module.

The aligner is trained to reconstruct words based on the masked input, which is the same as the training process of BERT (Devlin et al., 2019). Following the previous work which adopts representation modeling methods to train language GANs (Ren and Li, 2022), we use the loss function of variational autoencoder (VAE) (Kingma and Welling, 2014) to train the aligner:

$$L_A = -\mathbb{E}_{z'_i \sim q(z'_i|x_i)}(\log p(x_i|z'_i)) + KL(q(z'_i|x_i)||p(z'_i)) \quad (1)$$

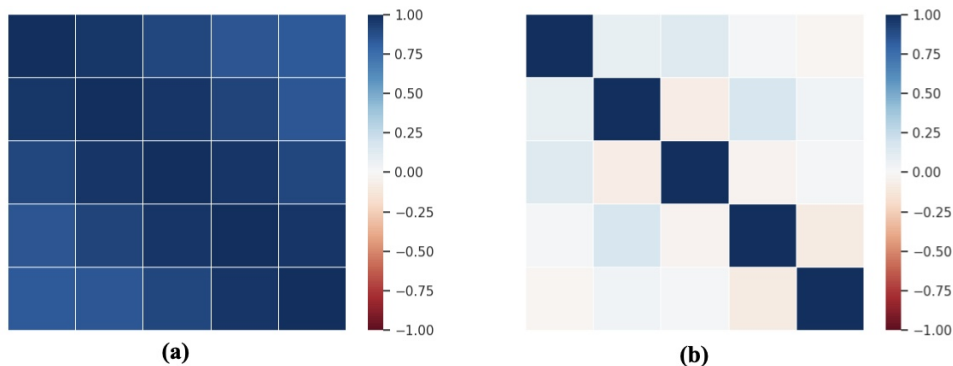

Figure 3: Cosine similarity of the output from (a) Self-Modulation; and (b) Position-Aware Self-Modulation.

where x_i is the i -th word in the sentence, z'_i is obtained by using reparameterization trick: $z'_i = \mu_{x_i} + \sigma_{x_i} \cdot \mathcal{N}(0, 1)$, and z'_i is transformed back into words with a linear transformation layer F_{LT} . Different from cross entropy which maps words into specific points in the representation space, this method describes a region for each word, so representations slightly away from their central points μ_{x_i} can still be transformed into correct words.

A non-autoregressive generator can not adopt previously generated words as the input, so we use trainable representations as input and incorporate latent variables into the representations. The generator then gives output representations r_i in different positions and uses the same linear transformation layer F_{LT} in the aligner to transform these representations back into words. The discriminator adopts the output representations from the aligner and the generator (μ_{x_i} and r_i) as input, and identifies whether they are synthetic or not. Different from image GANs whose discriminators give a single scalar output for an image, our discriminator gives output for each representation. During training, the aligner will be trained first, and its parameters are fixed during the training of the discriminator and the generator. The representations given by the generator need not be transformed into words in training process, so the gradients from the discriminator can directly pass through to the generator.

Casual masks are adopted in both the discriminator and the generator to break the possible symmetry in the input. We use Wasserstein distance (Arjovsky et al., 2017) as the training objective and adopt Lipschitz penalty (Petzka et al., 2018) to regularize the discriminator. More specifically, the loss functions of the discriminator L_D and the generator L_G are:

$$L_D = -\mathbb{E}_{\mu_{x_i} \sim P_x} [D(\mu_{x_i})] + \mathbb{E}_{z \sim P_z} [D(G(z))] \quad (2)$$

$$L_G = -\mathbb{E}_{z \sim P_z} [D(G(z))] \quad (3)$$

where μ_{x_i} is obtained by the aligner and z is the latent variable sampled from a pre-defined distribution.

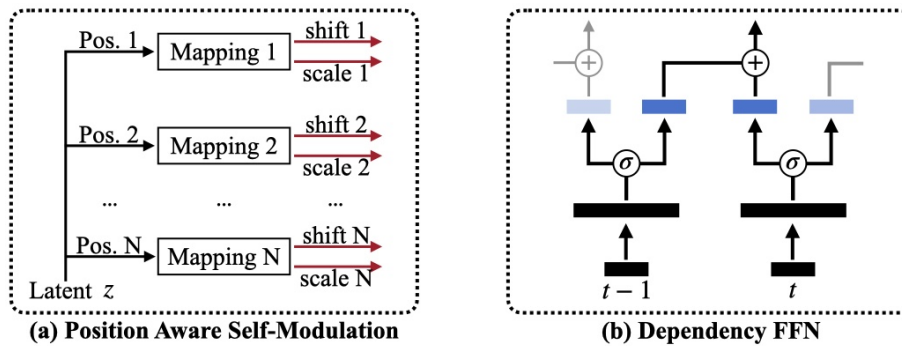

Figure 4: Proposed Facilities in ANT.

However, there is still a gap between our basic model and existing autoregressive models. To improve its performance, we propose Position-Aware Self-Modulation and Dependency Feed Forward Network (Dependency FFN).

3.2 Position-Aware Self-Modulation

An effective sampling method plays a key role in the success of GANs. Recent studies about Transformer in image GANs (Lee et al., 2021) adopt self-modulation (Chen et al., 2019) to sample data. Self-modulation assigns the same shift and scale factors to the normalized results in different positions, which leads the representations in various positions to be highly similar even with positional encodings (as shown in Figure 3 (a)). However, the output of the generator (i.e., word representations in different positions) are of high diversities. Similar input representations can not provide clear signals to the generator to obtain those diverse output representations. It brings difficulties for the generator to converge and recover the data distribution.

To tackle this problem, we propose **Position-Aware Self-Modulation**. As shown in Figure 4 (a), this method adopts different mapping layers for the calculations in different positions so as to gain diverse results. In practice, a parallel implementation is adopted to improve the computation efficiency, which is:

$$\begin{pmatrix} \mathbf{h}'_1 \\ \mathbf{h}'_2 \\ \vdots \\ \mathbf{h}'_N \end{pmatrix} = MLP(z) \quad (4)$$

$$\mathbf{h}_i = \gamma(\mathbf{h}'_i) \circ LN(\mathbf{x}_i) + \beta(\mathbf{h}'_i)$$

where z is the latent variable, \mathbf{h}'_i is the hidden representation in the i -th position, $MLP(\cdot)$ is a non-linear transformation whose activation function is GELU (Hendrycks and Gimpel, 2016), $LN(\cdot)$ is the layer normalization, N is the length of the sentence, and $\gamma(\cdot)$ and $\beta(\cdot)$ are linear transformations. In Position-Aware Self-Modulation, representations in different positions are calculated based on unique parameters and have clear differences (as shown in Figure 3 (b)), so as to provide more effective signals to recover original sentences.

Table 1: FED and I. BLEU on the COCO Dataset and EMNLP Dataset.

Model	DI	COCO		EMNLP	
		FED ↓	I. BLEU ↑	FED ↓	I. BLEU ↑
Training Data	-	0.007	35.36	0.010	20.62
Transformer	O(N)	0.008	34.28	0.014	19.50
RelGAN	O(N)	0.062	29.53	0.136	14.74
ScratchGAN	O(N)	0.014	30.76	0.018	17.19
InitialGAN	O(N)	0.013	33.06	0.025	17.74
V-CMLM	O(k)	0.016	27.65	0.062	16.67
V-NAT	O(1)	0.024	26.41	0.111	11.38
NAGAN	O(1)	0.084	24.98	0.748	2.01
ANT	O(1)	0.013	31.12	0.026	15.51

Our preliminary experiment shows that representations obtained by Position-Aware Self-Modulation are of high diversities, while equipping it in every layer will slow down the convergence. Thus, we adopt it only in the input and use dropout as an additional sampling method by using it in both training and inference stage (Ren and Li, 2022). It can improve model performance by injecting slight random noise and regularizing the model at the same time.

3.3 Dependency Feed Forward Network

Transformer (Vaswani et al., 2017) builds word dependencies solely based on the attention mechanism by assigning weights dynamically. This process, however, is unstable under the training of GANs. It will lead the models to lose word dependencies, and finally result in ungrammatical sentences. To tackle this problem, we propose Dependency Feed Forward Network (Dependency FFN) to strengthen the FFN module with the capacity of dependency modeling. The structure of Dependency FFN is shown in Figure 4 (b), and it is calculated as follows:

$$\begin{aligned}
 \mathbf{s}_t &= \sigma(\mathbf{x}_t W_s + b_s) \\
 \mathbf{o}_t &= \mathbf{s}_{t-1} W_a + \mathbf{s}_t W_b + b_o
 \end{aligned}
 \tag{5}$$

where $\sigma(\cdot)$ is an activation function which is GELU in this work. With casual masks, \mathbf{s}_{t-1} and \mathbf{s}_t contain the information of first $(t-1)$ and t words, respectively. Using the sum of these two variables can help the model to explicitly build stable dependencies between the t -th word and previous $(t-1)$ words in the fragile training process of GANs.

In our experiment, adopting Dependency FFN in the discriminator can significantly improve model performance, while its effectiveness to the generator is limited. A powerful discriminator can guide the generator to model word dependencies with the original structure. We thus only adopt Dependency FFN in the discriminator.

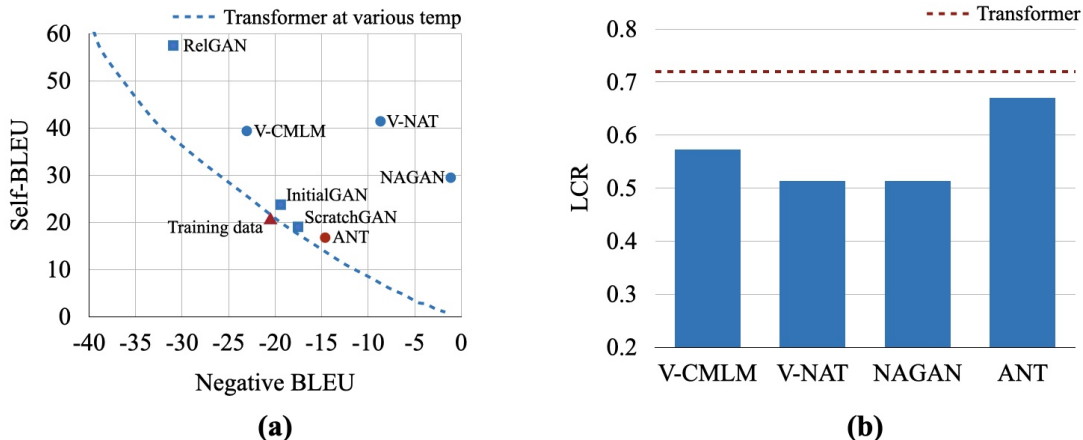

Figure 5: Additional Experimental Results. (a) Model Performance at Various Temperature. (b) Least Coverage Rate.

3.4 Extension to Conditional Generation

IIS not only covers unconditional generation tasks, but also includes conditional generation tasks. In the following, we introduce how to extend ANT to conditional generation. Given a condition representation c , the generator can consider it by shifting the original latent variable z . We find that using trainable factors to assign weights to z and c can slightly improve the performance. Thus, we incorporate the condition as follows:

$$\hat{z} = \alpha_1 \circ z + \alpha_2 \circ c \quad (6)$$

where α_1 and α_2 are two trainable variables. Then, \hat{z} is fed into Position-Aware Self-Modulation, so the generator can consider the condition representation.

For the discriminator, we use the sum of word representations x_t^d and conditional representations c as the input: $\hat{x}_t^d = x_t^d + c$. Then, \hat{x}_t^d is fed into the remaining modules of the discriminator.

4 Experiment

4.1 Experiment Setup

The experiment covers both unconditional generation and conditional generation to evaluate model performance under the IIS comprehensively. For the unconditional generation, we follow previous work (de Masson d’Autume et al., 2019; Ren and Li, 2022) and use sentences from two datasets: the COCO Image Caption Dataset (Lin et al., 2014)¹ and the EMNLP 2017 News Dataset². The size of training sets of the COCO dataset and the EMNLP dataset are set to be 50,000 and 200,000, respectively. The COCO dataset can support evaluations in short sentence generation, while the EMNLP dataset focuses on long sentence generation.

1. <https://cocodataset.org>

2. <http://www.statmt.org/wmt17/>

Table 2: FED, I. BLEU and Acc. on the Yelp dataset

Model	DI	FED	I. BLEU	Acc.
Training Data	-	0.008	24.18	92.47%
Transformer	O(N)	0.011	23.04	91.73%
V-CMLM	O(k)	0.015	18.35	87.85%
V-NAT	O(1)	0.032	11.81	83.54%
ANT	O(1)	0.018	19.08	88.35%

For the conditional generation, we randomly select 100,000 sentences from the Yelp Dataset³ as training data and use emotion labels (positive or negative) as conditions.

4.2 Evaluation Metrics

The evaluation is conducted at both embedding level and token level. In embedding level, we use Universal Sentence Encoder⁴ (Cer et al., 2018) to transform sentences into embeddings. Then, we calculate both **Fréchet Embedding Distance (FED)** (de Masson d’Autume et al., 2019) and **Least Coverage Rate (LCR)** (Ren and Li, 2022) to evaluate the overall similarity and the fine-grained similarity of two distributions, respectively.

In token level, we use **Inverse-BLEU (I. BLEU)** to evaluate model performance in terms of quality and diversity together. The Inverse-BLEU uses generated sentences as references and sentences in the test set as inferences. A model can get high Inverse BLEU only if it can obtain a good trade-off between quality and diversity (Ren and Li, 2022). We also draw a curve of **BLEU** (Papineni et al., 2002) and **Self-BLEU** (Zhu et al., 2018) by tuning the temperature of the model to evaluate the overall performance (Caccia et al., 2020). For conditional generation, we additionally use Universal Sentence Encoder to construct a classifier and use it to calculate **Accuracy (Acc.)**, so as to verify whether the models generate sentences with expected labels or not.

4.3 Compared Model

Transformer (Vaswani et al., 2017) is an important compared model in our experiment, since it is now the mainstream model in various text generation tasks. Considering ANT is a GAN-based model, we also choose several representative models in language GANs for comparisons: RelGAN (Nie et al., 2019), which uses *Gumbel-softmax* to obtain gradients; ScratchGAN (de Masson d’Autume et al., 2019), which is based on *REINFORCE*; InitialGAN (Ren and Li, 2022), which does not use the above two method and adopts representation modeling. All the models mentioned-above are AR models whose Decoding Iteration (DI) is $O(N)$ (N is the sequence length).

For the NAR models, we compare with NAGAN (Huang et al., 2021), which is also a GAN-based NAR model. Although existing MLE-based NAR models can not be adopted to the IIS directly, we still want to compare the differences between MLE-based methods

3. <https://www.yelp.com/dataset>

4. <https://tfhub.dev/google/universal-sentence-encoder/4>

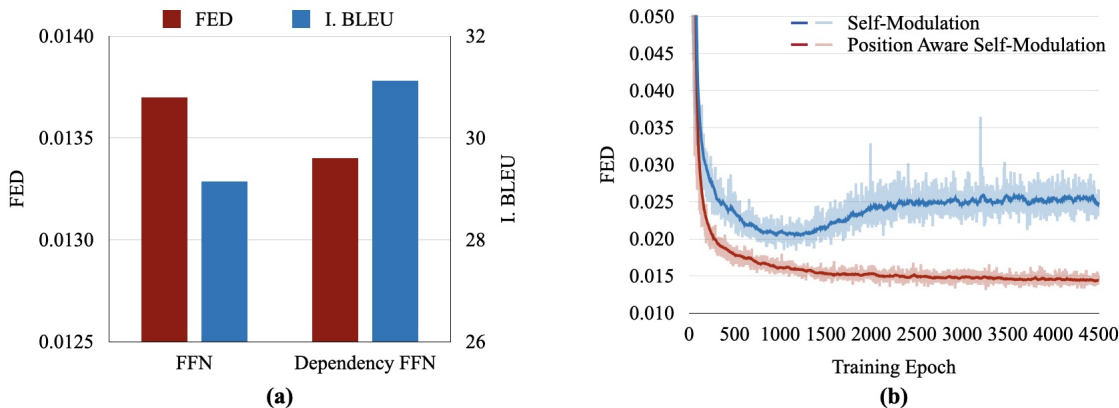

Figure 6: Ablation study of (a) Dependency FFN, and (b) Position-Aware Self-Modulation.

and GAN-based methods. Thus, we use the idea of VAE to get the hidden representations of sentences and adapt two existing popular NAR models into the IIS. One is based on Non-autoregressive Transformer (NAT) (Gu et al., 2018) which uses the hidden representations to generate sentences in a fully NAR manner; we denote this model as V-NAT. Another one is based on conditional masked language model (CMLM) (Ghazvininejad et al., 2019) which generates sentences by iteratively masking and generating words; we denote this model as V-CMLM. The iteration number k of V-CMLM is set to be 10 as in previous work (Ghazvininejad et al., 2019; Huang et al., 2022c). More illustrations about experiment details can be found in Appendix B. We will release our code to the public in the future.

4.4 Experimental Result

4.4.1 UNCONDITIONAL GENERATION

The experimental results of the unconditional generation are shown in Table 1. “DI” indicates Decoding Iteration. For the COCO dataset, Transformer gets the best performance in AR models, while ANT is the best one in NAR models. ANT gets 0.013 in FED, which is better than other NAR models and close to AR models like ScratchGAN and InitialGAN. Similar results can be found in Inverse BLEU. ANT gets 31.12 in I. BLEU and it is much better than other NAR models. There are large gaps between MLE-based NAR models (V-NAT and V-CMLM) and AR models, and it is consistent with our theoretical analyses. The input with incomplete information increases the difficulties of MLE training. NAGAN, another GAN-based NAR model, is inferior to all the other models. It shows the limitations of the biased *straight-through estimator*.

For the EMNLP dataset, Transformer is still the best model. ANT outperforms other NAR models in FED, while V-CMLM can slightly outperform ANT in Inverse BLEU. The iterative decoding mechanism helps V-CMLM to better process complicated datasets with higher decoding latency. To further discuss their performance in the token level, we draw the curve of Self-BLEU and Negative BLEU by tuning the temperature in Transformer and show the results in Figure 5 (a). ANT is the only NAR model which can get comparable

Table 3: Effectiveness of ANT in Semi-supervised Learning (Num.: number of labeled data).

Method	Num.	P	R	F1
SL	500	91.28%	89.06%	90.15%
SSL		90.77%	92.15%	91.46%
SL	1000	92.42%	91.33%	91.87%
SSL		94.87%	92.39%	93.62%

performance with AR models, while other NAR models (including V-CMLM) remain behind obviously. Specifically, NAGAN gets extremely low BLEU, which indicates that NAGAN can not generate fluency sentences. It reveals the difficulties of NAGAN to converge on complicated datasets. Furthermore, we compare Least Coverage Rate (LCR) of Transformer and other NAR models in Figure 5 (b). ANT outperform V-CMLM with lower decoding iterations, and it is the only NAR model which can get close performance with Transformer.

4.4.2 CONDITIONAL GENERATION

The experimental results of conditional generation are shown in Table 2. Transformer gets the best performance in all the evaluation metrics with more decoding iterations. Among NAR models, ANT gets comparable performance with V-CMLM in FED, and achieves higher Inverse BLEU and Accuracy with lower decoding latency. V-NAT, which has the same decoding iterations as ANT, is inferior to other models. Given an emotion label, there are a large number of possible candidates, and it will augment the inherent multi-modality problem in MLE-based NAR models. Thus, fully NAR models trained under MLE will easily mix words in different candidates and finally obtains poor performance. For the accuracy, ANT gets 88.35% which is the highest one among all the NAR models. ANT can generate sentences that are consistent with the given labels. It reveals that ANT has great potential in both unconditional generation and conditional generation.

4.4.3 ABLATION STUDY

We design two features for ANT: 1) Dependency FFN, which strengthens model capacity in dependency modeling; and 2) Position-Aware Self-Modulation, which provides clearer signals for the model to recover the original data. We also conduct experiments to demonstrate the effectiveness of these two modules.

For Dependency FFN, we compare the performance between Dependency FFN and the original FFN on the COCO dataset and show the results in Figure 6 (a). ANT with Dependency FFN has lower FED and higher Inverse BLEU. It obtains better performance in both the token-level metrics and the embedding-level metrics. These results show that Dependency FFN can help improve model performance by modeling more accurate word dependencies.

For Position-Aware Self-Modulation, we compare the training curves with original Self-Modulation with FED. The results are shown in Figure 6 (b). ANT with Position-Aware Self-Modulation converges faster, and finally achieves better performance. Position-Aware

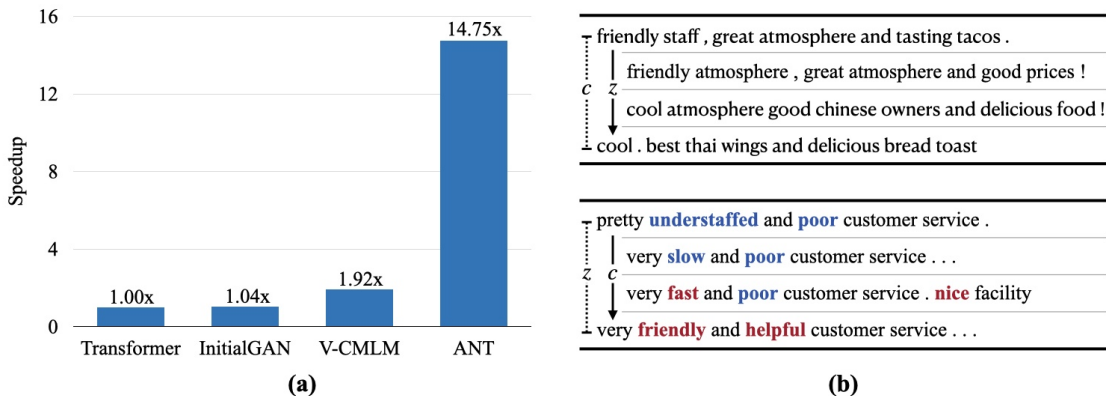

Figure 7: (a) Speedup of Different Models. (b) Case Study of Latent Interpolation

Self-Modulation can provide clearer input signals for the model and further enhance model performance.

4.5 Discussion

ANT is a fully NAR model so it has much lower decoding latency. We compare the speedup of different models and show the results in Figure 7 (a). ANT can generate sentences 14.75 times faster than Transformer. Even comparing with V-CMLM, it also has much lower decoding latency while obtaining comparable or even better performance.

Generative models can also boost the performance of classification models based on semi-supervised learning (SSL). We investigate the application of ANT in SSL by incorporating it into the training of a classification model. The classification model is trained to identify emotion labels of sentences in the Yelp dataset. We prepare two training sets. One is composed of 500 labeled data and the other one consists of 1,000 labeled data. The results are shown in Table 3. The classification models trained in SSL consistently outperform the ones trained in supervised learning (SL). ANT can obtain data following same distributions as the original data so as to help the classification model capture more accurate data distribution and achieve better performance.

Besides, ANT enables latent interpolation just like image GANs. There are two latent variables in ANT: z , which is sampled from a pre-defined distribution; and c , which is a condition representation. We fix one of them and gradually change the other one. The upper part of Figure 7 (b) shows the samples given by tuning z with fixed c , in which ANT transforms one sentence into another one, with the middle sentences kept understandable. The lower part of Figure 7 (b) shows the samples given by changing c from the negative representation to the positive representation. ANT gradually transforms negative words into positive ones while keeping the main structure of the sentence. Such latent interpolation is seldomly explored by NAR models, and it may inspire further ideas for related tasks.

5 Conclusion

In this work, we firstly analyze the limitations of existing NAR models in the IIS. The features of the IIS will augment the inherent multi-modality problems of MLE-based NAR models and the lower bounds between their learned distributions and real distributions will be higher under the IIS. Instead, we find GANs denote a more promising method to train NAR models in the IIS. Thus, we propose an Adversarial Non-autoregressive Transformer (ANT) based on GANs. ANT supports two novel features: Position-Aware Self-Modulation and Dependency FFN. With the help of these two facilities, ANT can get comparable performance as other AR models but with much lower decoding latency. Besides, we also demonstrate the great potential of ANT in various tasks like smooth latent interpolation and semi-supervised learning.

Although ANT can significantly reduce the decoding latency, it still does not outperform Transformer. In the future, we will explore more techniques to further improve the performance of ANT and extend it into other tasks.

Acknowledgments and Disclosure of Funding

The authors are grateful to Hongzhi Zhao for his help in mathematical proofs.

Appendix A. Proof

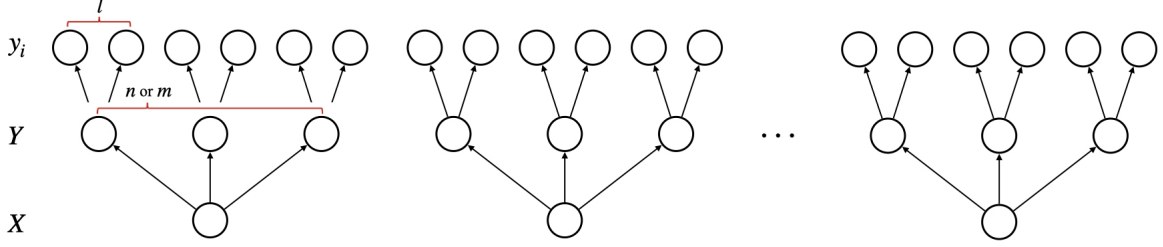

Figure 8: Mapping Relations Described in Assumption 1.

Assumption 1 describes a relation which is shown in Figure 8. Giving an input, it has n or m possible mapping candidates and each candidate is consisted of l elements. Based on it, we can obtain the following conditional probabilities:

$$\begin{aligned} P_{data}(Y|X_A) &= P_{data}(y_i|X_A) = 1/n \\ P_{data}(Y|X_B) &= P_{data}(y_i|X_B) = 1/m \end{aligned} \quad (7)$$

It should be noted that $P_{data}(y_i|X_A)$ and $P_{data}(y_i|X_B)$ are not related to the sequence length l in this scenario. Given a specific input, there are only n or m possible candidate elements at each position. Based on the conditional probabilities, we have:

$$\begin{aligned} C_A &= \sum_{i=1}^l H_{data}(y_i|X_A) - H_{data}(Y|X_A) \\ &= -l \cdot \log(1/n) + \log(1/n) \\ &= -(l-1) \cdot \log(1/n) \end{aligned} \quad (8)$$

$$\begin{aligned} C_B &= \sum_{i=1}^l H_{data}(y_i|X_B) - H_{data}(Y|X_B) \\ &= -l \cdot \log(1/m) + \log(1/m) \\ &= -(l-1) \cdot \log(1/m) \end{aligned} \quad (9)$$

Thus, we can calculate their difference as follows:

$$\begin{aligned} C_A - C_B &= (l-1) \cdot [-\log(1/n) + \log(1/m)] \\ &= (l-1) \cdot \log(n/m) \end{aligned} \quad (10)$$

Thus, higher l and n lead to higher difference between C_A and C_B . In addition to the theoretical analyses, our experimental results also demonstrate the difficulties of MLE-based NAR models in the IIS empirically.

Appendix B. Experiment Details

B.1 Implementation Details

The layer numbers of the aligner, generator and discriminator are all set to be 4. Their input dimension is 256, and the hidden dimension of FFN / Dependency FFN is 1,024. The head number is set to be 8. We use AdamW (Loshchilov and Hutter, 2019) as the optimizer of the aligner and the weight decay is set to be 1e-5; its learning rate is 0.0001. During the adversarial training, AdamW (Loshchilov and Hutter, 2019) is used as the optimizer of the discriminator whose weight decay is set to be 0.0001; its learning rate is 0.0002 for the COCO and Yelp dataset, and 0.00015 for the EMNLP dataset. We choose Adam (Kingma and Ba, 2015) as the optimizer of the generator and its learning rate is 0.0001. The β_1 and β_2 in the optimizers of the discriminator and the generator are set to be 0.5 and 0.9, respectively. The maximum training epoch is set to be 4,500. We implement our model based on Tensorflow⁵ (Abadi et al., 2015) and the model is trained on NVIDIA GeForce RTX 3090.

B.2 V-NAT and V-CMLM

Both NAT (Gu et al., 2018) and CMLM (Ghazvininejad et al., 2019) are designed for machine translation, so their original structures contains an encoder to encode input in source language. However, the input in the IIS is too limited to be processed by an encoder, so this structure can not be used in the IIS directly. Besides, the model also needs a method to sample different data. Considering the problems above, we use the idea of VAE to obtain hidden representations, so they can sample different representations and generate various sentences based on them.

More specifically, a Transformer-based encoder is adopted to encode the sentences into hidden representations during training. Then, these representations are fed into the decoder to reconstruct the input sentences. During inference, representations sampled from the standard normal distribution will be fed into the decoder, and the decoder will generate sentences based on the sampled representations. The original structure of NAT and CMLM are kept as much as possible. For V-NAT the representations are fed into decoder as input (which is same with NAT). For V-CMLM, the representations are concatenated with the embeddings of input tokens (masked or unmasked words). The hyperparameters of V-NAT and V-CMLM are set as close as possible to those of ANT.

B.3 Evaluation Metrics

Fréchet Embedding Distance (FED) (de Masson d’Autume et al., 2019) is same with the Fréchet Inception Distance (FID) (Heusel et al., 2017) except for the encoding model. The encoding model is changed to be fit into text generation. We adopts Universal Sentence Encoder following the settings of the previous work (de Masson d’Autume et al., 2019). It is calculated as follows:

$$FED = \|\mu_1 - \mu_2\|_2^2 + Tr(c_1 + c_2 - 2(c_1c_2)^{1/2}) \quad (11)$$

where μ_1 and μ_2 are the mean, and c_1 and c_2 are the covariance.

5. <https://www.tensorflow.org>

Least Coverage Rate (LCR) (Ren and Li, 2022) is proposed to be a compliment when the FED of two models are too close to each other, since LCR is more sensitive to the change of data quality (Ren and Li, 2022). Given two sets of sentence $X_i^a \in \mathbb{X}_a$ and $X_i^b \in \mathbb{X}_b$, LCR is calculated as follows:

$$\begin{aligned}
 S_{ij} &= \text{Sim}(\mathbf{Emb}(X_i^a), \mathbf{Emb}(X_j^b)) \\
 R_a &= \frac{1}{|\mathbb{X}_a|} \sum_{i=1}^{|\mathbb{X}_a|} \delta\left(\sum_{j=1}^{|\mathbb{X}_b|} S_{ij} \geq \tau\right) \\
 R_b &= \frac{1}{|\mathbb{X}_b|} \sum_{j=1}^{|\mathbb{X}_b|} \delta\left(\sum_{i=1}^{|\mathbb{X}_a|} S_{ij} \geq \tau\right) \\
 \text{LCR}(\mathbb{X}_a, \mathbb{X}_b) &= \min(R_a, R_b)
 \end{aligned} \tag{12}$$

where X_i^a and X_i^b are the i -th and j -th sentences from sentence sets \mathbb{X}_a and \mathbb{X}_b , respectively. $\mathbf{Emb}(\cdot)$ is the model used to transform sentences into embeddings (which is Universal Sentence Encoder in this work), τ is a hyperparameter, $\text{Sim}(\cdot)$ is cosine similarity and $\delta(\cdot)$ is a function which returns 1 if input is higher than 0, and 0 for others.

The idea of LCR is to identify whether a specific mode in one set is covered by the sentences in another set or not. Then, it uses the minimum coverage rates as the output, so LCR can be sensitive to two common problems in text generative models: 1) models tend to generate sentences which are out of the real distributions; and 2) the generated sentences are in high similarities.

All the token level metrics (i.e., **BLEU**, **Self-BLEU**, and **Inverse BLEU**) are calculated up to 5 grams following previous work (de Masson d’Autume et al., 2019; Ren and Li, 2022).

References

- Martín Abadi, Ashish Agarwal, Paul Barham, Eugene Brevdo, Zhifeng Chen, Craig Citro, Greg S. Corrado, Andy Davis, Jeffrey Dean, Matthieu Devin, Sanjay Ghemawat, Ian Goodfellow, Andrew Harp, Geoffrey Irving, Michael Isard, Yangqing Jia, Rafal Jozefowicz, Lukasz Kaiser, Manjunath Kudlur, Josh Levenberg, Dandelion Mané, Rajat Monga, Sherry Moore, Derek Murray, Chris Olah, Mike Schuster, Jonathon Shlens, Benoit Steiner, Ilya Sutskever, Kunal Talwar, Paul Tucker, Vincent Vanhoucke, Vijay Vasudevan, Fernanda Viégas, Oriol Vinyals, Pete Warden, Martin Wattenberg, Martin Wicke, Yuan Yu, and Xiaoqiang Zheng. TensorFlow: Large-scale machine learning on heterogeneous systems, 2015. Software available from tensorflow.org.
- Michaël Allouche, Stéphane Girard, and Emmanuel Gobet. EV-GAN: simulation of extreme events with relu neural networks. *J. Mach. Learn. Res.*, 23:150:1–150:39, 2022.
- Martín Arjovsky, Soumith Chintala, and Léon Bottou. Wasserstein generative adversarial networks. In *ICML*, pages 214–223, 2017.

- Yoshua Bengio, Nicholas Léonard, and Aaron C. Courville. Estimating or propagating gradients through stochastic neurons for conditional computation. *CoRR*, abs/1308.3432, 2013.
- G erard Biau, Maxime Sangnier, and Ugo Tanielian. Some theoretical insights into wasserstein gans. *J. Mach. Learn. Res.*, 22:119:1–119:45, 2021.
- Radu Ioan Bot, Michael Sedlmayer, and Phan Tu Vuong. A relaxed inertial forward-backward-forward algorithm for solving monotone inclusions with application to gans. *J. Mach. Learn. Res.*, 24:8:1–8:37, 2023.
- Massimo Caccia, Lucas Caccia, William Fedus, Hugo Larochelle, Joelle Pineau, and Laurent Charlin. Language gans falling short. In *ICLR*, 2020.
- Daniel Cer, Yinfei Yang, Sheng-yi Kong, Nan Hua, Nicole Limtiaco, Rhomni St. John, Noah Constant, Mario Guajardo-Cespedes, Steve Yuan, Chris Tar, Brian Strope, and Ray Kurzweil. Universal sentence encoder for english. In *EMNLP*, 2018. doi: 10.18653/v1/d18-2029.
- Tong Che, Yanran Li, Ruixiang Zhang, R. Devon Hjelm, Wenjie Li, Yangqiu Song, and Yoshua Bengio. Maximum-likelihood augmented discrete generative adversarial networks. *CoRR*, abs/1702.07983, 2017.
- Ting Chen, Mario Lucic, Neil Houlsby, and Sylvain Gelly. On self modulation for generative adversarial networks. In *ICLR*, 2019.
- Cyprien de Masson d’Autume, Shakir Mohamed, Mihaela Rosca, and Jack W. Rae. Training language gans from scratch. In *NeurIPS*, pages 4302–4313, 2019.
- Jacob Devlin, Ming-Wei Chang, Kenton Lee, and Kristina Toutanova. BERT: pre-training of deep bidirectional transformers for language understanding. In *NAACL-HLT*, pages 4171–4186, 2019. doi: 10.18653/v1/n19-1423.
- Prafulla Dhariwal and Alexander Quinn Nichol. Diffusion models beat gans on image synthesis. In Marc’Aurelio Ranzato, Alina Beygelzimer, Yann N. Dauphin, Percy Liang, and Jennifer Wortman Vaughan, editors, *NeurIPS*, pages 8780–8794, 2021.
- Cunxiao Du, Zhaopeng Tu, and Jing Jiang. Order-agnostic cross entropy for non-autoregressive machine translation. In *ICML*, pages 2849–2859, 2021.
- Angela Fan, Mike Lewis, and Yann N. Dauphin. Hierarchical neural story generation. In *ACL*, pages 889–898, 2018. doi: 10.18653/v1/P18-1082.
- William Fedus, Ian J. Goodfellow, and Andrew M. Dai. Maskgan: Better text generation via filling in the ----- . In *ICLR*, 2018.
- Marjan Ghazvininejad, Omer Levy, Yinhan Liu, and Luke Zettlemoyer. Mask-predict: Parallel decoding of conditional masked language models. In *EMNLP-IJCNLP*, pages 6111–6120, 2019. doi: 10.18653/v1/D19-1633.

- Ian J. Goodfellow, Jean Pouget-Abadie, Mehdi Mirza, Bing Xu, David Warde-Farley, Sherjil Ozair, Aaron C. Courville, and Yoshua Bengio. Generative adversarial networks. *CoRR*, abs/1406.2661, 2014.
- Jiatao Gu, James Bradbury, Caiming Xiong, Victor O. K. Li, and Richard Socher. Non-autoregressive neural machine translation. In *ICLR*, 2018.
- Dan Hendrycks and Kevin Gimpel. Bridging nonlinearities and stochastic regularizers with gaussian error linear units. *CoRR*, abs/1606.08415, 2016.
- Martin Heusel, Hubert Ramsauer, Thomas Unterthiner, Bernhard Nessler, and Sepp Hochreiter. Gans trained by a two time-scale update rule converge to a local nash equilibrium. In *NeurIPS*, pages 6626–6637, 2017.
- Jonathan Ho, Ajay Jain, and Pieter Abbeel. Denoising diffusion probabilistic models. In *NeurIPS*, 2020.
- Fei Huang, Jian Guan, Pei Ke, Qihan Guo, Xiaoyan Zhu, and Minlie Huang. A text {gan} for language generation with non-autoregressive generator, 2021.
- Fei Huang, Tianhua Tao, Hao Zhou, Lei Li, and Minlie Huang. On the learning of non-autoregressive transformers. In *ICML*, pages 9356–9376, 2022a.
- Fei Huang, Hao Zhou, Yang Liu, Hang Li, and Minlie Huang. Directed acyclic transformer for non-autoregressive machine translation. In *ICML*, pages 9410–9428, 2022b.
- Xiao Shi Huang, Felipe Perez, and Maksims Volkovs. Improving non-autoregressive translation models without distillation. In *ICLR*, 2022c.
- Eric Jang, Shixiang Gu, and Ben Poole. Categorical reparameterization with gumbel-softmax. In *ICLR*, 2017.
- Tero Karras, Samuli Laine, Miika Aittala, Janne Hellsten, Jaakko Lehtinen, and Timo Aila. Analyzing and improving the image quality of stylegan. In *CVPR*, pages 8107–8116, 2020. doi: 10.1109/CVPR42600.2020.00813.
- Nitish Shirish Keskar, Bryan McCann, Lav R. Varshney, Caiming Xiong, and Richard Socher. CTRL: A conditional transformer language model for controllable generation. *CoRR*, abs/1909.05858, 2019.
- Yoon Kim and Alexander M. Rush. Sequence-level knowledge distillation. In *EMNLP*, pages 1317–1327, 2016. doi: 10.18653/v1/d16-1139.
- Diederik P. Kingma and Jimmy Ba. Adam: A method for stochastic optimization. In *ICLR*, 2015.
- Diederik P. Kingma and Max Welling. Auto-encoding variational bayes. In *ICLR*, 2014.
- Kwonjoon Lee, Huiwen Chang, Lu Jiang, Han Zhang, Zhuowen Tu, and Ce Liu. Vitgan: Training gans with vision transformers. *CoRR*, abs/2107.04589, 2021.

- Xiang Li, John Thickstun, Ishaan Gulrajani, Percy Liang, and Tatsunori B. Hashimoto. Diffusion-lm improves controllable text generation. In *NeurIPS*, 2022.
- Chun-Hsing Lin, Siang-Ruei Wu, Hung-yi Lee, and Yun-Nung Chen. Taylorgan: Neighbor-augmented policy update for sample-efficient natural language generation. *CoRR*, abs/2011.13527, 2020.
- Kevin Lin, Dianqi Li, Xiaodong He, Ming-Ting Sun, and Zhengyou Zhang. Adversarial ranking for language generation. In *NeurIPS*, pages 3155–3165, 2017.
- Tsung-Yi Lin, Michael Maire, Serge J. Belongie, James Hays, Pietro Perona, Deva Ramanan, Piotr Dollár, and C. Lawrence Zitnick. Microsoft COCO: common objects in context. In *ECCV*, pages 740–755, 2014. doi: 10.1007/978-3-319-10602-1_48.
- Puyuan Liu, Chenyang Huang, and Lili Mou. Learning non-autoregressive models from search for unsupervised sentence summarization. In *ACL*, pages 7916–7929, 2022.
- Ilya Loshchilov and Frank Hutter. Decoupled weight decay regularization. In *ICLR*, 2019.
- Weili Nie, Nina Narodytska, and Ankit Patel. Relgan: Relational generative adversarial networks for text generation. In *ICLR*, 2019.
- Kishore Papineni, Salim Roukos, Todd Ward, and Wei-Jing Zhu. Bleu: a method for automatic evaluation of machine translation. In *ACL*, pages 311–318, 2002. doi: 10.3115/1073083.1073135.
- Henning Petzka, Asja Fischer, and Denis Lukovnikov. On the regularization of wasserstein gans. In *ICLR*, 2018.
- Da Ren and Qing Li. Initialgan: A language gan with completely random initialization. *CoRR*, abs/2208.02531, 2022. doi: 10.48550/arXiv.2208.02531.
- Axel Sauer, Katja Schwarz, and Andreas Geiger. Stylegan-xl: Scaling stylegan to large diverse datasets. In Munkhtsetseg Nandigjav, Niloy J. Mitra, and Aaron Hertzmann, editors, *SIGGRAPH*, pages 49:1–49:10, 2022. doi: 10.1145/3528233.3530738.
- Ashish Vaswani, Noam Shazeer, Niki Parmar, Jakob Uszkoreit, Llion Jones, Aidan N. Gomez, Lukasz Kaiser, and Illia Polosukhin. Attention is all you need. In *NeurIPS*, pages 5998–6008, 2017.
- Ronald J. Williams. Simple statistical gradient-following algorithms for connectionist reinforcement learning. *Mach. Learn.*, 8:229–256, 1992. doi: 10.1007/BF00992696.
- Weidi Xu, Haoze Sun, Chao Deng, and Ying Tan. Variational autoencoder for semi-supervised text classification. In *AAAI*, pages 3358–3364, 2017.
- Lantao Yu, Weinan Zhang, Jun Wang, and Yong Yu. Seqgan: Sequence generative adversarial nets with policy gradient. In *AAAI*, pages 2852–2858, 2017.
- Yaoming Zhu, Sidi Lu, Lei Zheng, Jiaxian Guo, Weinan Zhang, Jun Wang, and Yong Yu. Taxygen: A benchmarking platform for text generation models. In *SIGIR*, pages 1097–1100, 2018. doi: 10.1145/3209978.3210080.