



Representation Matters: The Game of Chess Poses a Challenge to Vision Transformers

Johannes Czech¹  Jannis Blüml^{1,2}  Kristian Kersting^{1,2,3,4} 

¹ Artificial Intelligence and Machine Learning Lab, TU Darmstadt, Germany

² Hessian Center for Artificial Intelligence (hessian.AI), Darmstadt, Germany

³ Centre for Cognitive Science, TU Darmstadt, Germany

⁴ German Research Center for Artificial Intelligence (DFKI), Darmstadt, Germany

E-mail: {johannes.czech, blueml, kersting}@cs.tu-darmstadt.de

Abstract

While transformers have gained the reputation as the “Swiss army knife of AI”, no one has challenged them to master the game of chess, one of the classical AI benchmarks. Simply using vision transformers (ViTs) within AlphaZero does not master the game of chess, mainly because ViTs are too slow. Even making them more efficient using a combination of MobileNet and NextViT does not beat what actually matters: a simple change of the input representation and value loss, resulting in a greater boost of up to 180 Elo points over AlphaZero.

Keywords: Transformer, Input Representation, Loss Formulation, Chess, Monte-Carlo Tree Search, AlphaZero

1 Introduction

The transformer architecture is a neural network architecture used in natural language processing (NLP) tasks such as machine translation, sentiment analysis, and text summarization but also computer vision and multi-modal applications. It was introduced in 2017 by [28]. What distinguishes transformers from traditional convolutional neural networks (CNNs) is the use of self-attention mechanisms. This allows the network to weigh the importance of different elements in the input sequence, rather than simply processing the sequence sequentially or using a fixed size context window. As a result, transformers have achieved state-of-the-art performance on a wide range of NLP and vision tasks and have become a cornerstone of AI models.

The popularity of transformers can be attributed to their ability to handle long-range dependencies, a feature which is also very important in the field of computer vision, where

the relationships between objects in an image can be very complex and span a large spatial area. With transformers, this information can be effectively captured and modeled, whereas with CNNs it can be more challenging. This is one reason, why nowadays transformer models are taken over classical CNN approaches in computer vision and other domains [6]. Moreover, by combining the strengths of transformers and reinforcement learning (RL), it is possible to develop powerful models for solving complex sequential decision-making problems [2, 13]. They can be used to model the state representation, policy, and value function, and can be pre-trained for transfer learning [11, 17]. They even make great world models [18].

Are transformer really the “Swiss army knife of AI”? At the end of the day, they are very large and need to have several billions of parameters to work properly. Indeed, this makes them very powerful, but this also comes with some crucial limitations. Among other issues, they are difficult to keep efficient and show a high latency [21, 30]. In chess, for example, low latency is of central importance. Using transformers only because they are becoming more popular in a lot of domains does not always lead to improvement, as shown for example by [23]. They investigated the influence the transformer architecture has on their application example (continuous control tasks) and achieved better results by simply replacing the transformer with a Long Short-Term Memory network (LSTM).

Here, we challenge transformers in mastering the game of chess, one of the classical AI benchmarks. For chess, AlphaZero [24, 25] is a well-known architecture that combines neural networks with Monte-Carlo tree search (MCTS) [14]. It has achieved remarkable results in games such as Go, chess and shogi, outperforming the strongest previous algorithms and even surpassing top human players. AlphaZero showed huge successes because of its abil-

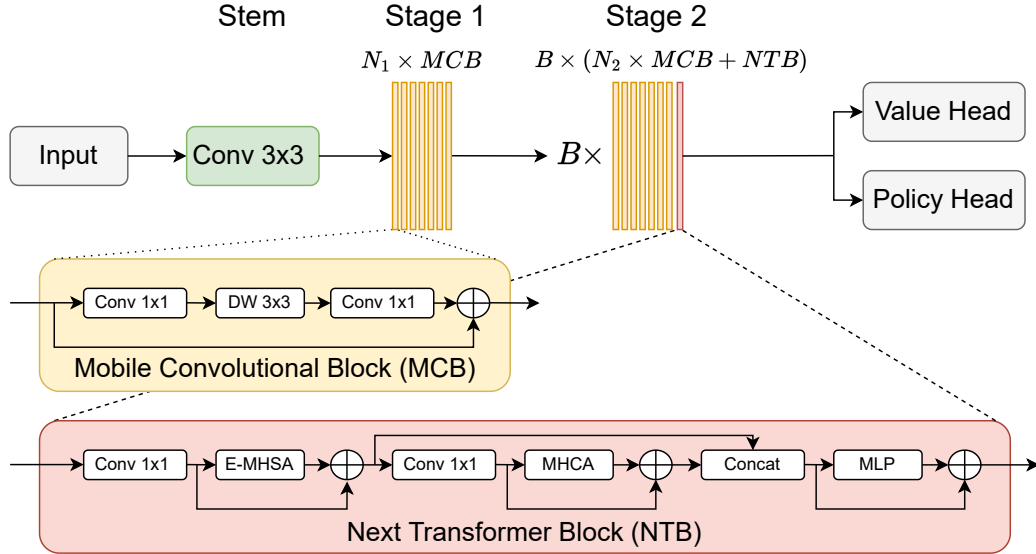

Figure 1. Architecture overview of the predictor network within AlphaVile. The mobile convolutional block, here MCB, was introduced by Sandler et al. [22] and the next transformer block (NTB) has been integrated from Li et al. [16]. B defines the number of hybrid blocks in the architecture and can be used to scale the model. Our normal-sized AlphaVile model uses ten MCBs in Stage 1 ($N_1 = 10$), and two Stage 2 Blocks ($B = 2$), each having seven MCBs ($N_2 = 7$) and one NTB.

ity to learn from scratch, to generalize to new problems, to achieve strong performance, and has implications for decision-making and optimization. It is a powerful framework for how machines can learn to solve complex problems. Specifically, we investigate the performance of vision transformers in combination with AlphaZero in the domain of chess. We introduce AlphaVile¹, a convolutional transformer hybrid network and investigate empirically whether transformers and CNNs can benefit from each other. While it is common belief that “deep learning removes the need for feature engineering” as argued by [3] in his book, we believe that by making specific changes in the feature representation, improvements can be achieved for approaches like AlphaZero. For this reason, in addition to changing the architecture, we investigate a possible improvement in our feature representation.

We proceed as follows. We start off by introducing AlphaVile and its necessary background. Afterwards we discuss an improved input representation and value loss. Then we present empirical evaluation, showing that representation matters. Before concluding we touch upon related work.

¹Our network architectures, input representations and value loss formulations can be found at: <https://github.com/QueensGambit/CrazyAra/pull/196>, accessed 2023-04-28

2 AlphaVile: Using Transformers in AlphaZero

AlphaZero [24, 25] is a well-known model-based reinforcement learning approach. Its main advantage derives from its ability to make predictions about how a situation is likely to unfold using MCTS [14], i.e., it learns to predict the quality of actions and uses this information to think ahead, while staying scalable. Thereby, the introduced combination of search and neural networks is one of the most important aspects.

Our idea is to replace the residual network architecture (ResNet) [9] used by AlphaZero, which relies heavily on the use of convolutional layers, with a transformer-based architecture. Other elements, such as the search algorithm MCTS, or the loss function

$$\ell = \alpha [z - v]^2 - \pi^\top \log \mathbf{p} + c \cdot \|\theta\|_2^2, \quad (1)$$

which calculates a combined loss for the value and policy network outputs, stay the same. In the loss function $[z - v]^2$ describe the mean square error between the correct value, i.e., the outcome of the game, z and the predicted value v . $\pi^\top \log \mathbf{p}$ is the cross entropy of the correct policy vector π and our predicted one \mathbf{p} , remain unchanged from [24]. The scalar α describes a weighting parameter for the value loss. We set it to 0.01 in our experiments to reduce the risk of overfitting.

[6] compared its vision transformer architecture with state-of-the-art ResNet [9] and EfficientNet [26] architectures, which are based on CNNs. The results show that ViT performs better for image classification tasks on well-known benchmark data sets such as ImageNet or CIFAR. [8] pick up on this work and again compared vision transformer architectures to current CNN-based architectures and again highlight the immense potential of transformers. However, they also specifically address the problem of efficiency, i.e., transformer models are usually very large and computationally more expensive than comparable CNN approaches and often rely on massive datasets for training. In their work, they further investigate whether a combination of CNN and transformer can improve efficiency and conclude that CNN and transformer can support each other when combined. Another way to tackle the efficiency problem of ViT are current efforts to improve performance, using TensorRT and specifically adapted architectures, like Trt-ViT [30] and NextViT [16].

Regarding convolutional neural networks, we have to introduce the MobileNet architecture by [10]. MobileNet uses a combination of depthwise separable convolutions and pointwise convolutions to reduce the computational cost and memory requirements of traditional convolutional neural networks, while still maintaining high accuracy. MobileNets have been shown to achieve high accuracy on a range of computer vision tasks, while being significantly faster and more memory-efficient than traditional CNNs. This makes them well-suited for usage within AlphaZero. Several variations of MobileNets have been proposed, including MobileNetV2 and MobileNetV3, which introduce additional optimizations and improvements over the original architecture. For training, we also make use of stochastic depth [12] in order to both speed up training and improve convergence. The scaling technique that allows to generate networks in different sizes is adapted from EfficientNet [26].

To be more precise, AlphaVile, is the combination of AlphaZero [24], NextViT [16] and MobileNet [10]. We propose to use the Next Hybrid Strategy as presented by [16], where a single transformer block is preceded by multiple convolutional blocks. The architecture can be seen in Figure 1 and is optimized using TensorRT. To evaluate the performance of AlphaVile, we started to compare the used MobileNet block with ResNet [9] and the so called “Next Convolution Block” which was already compared against the ConvNext Transformer, PoolFormer and Uniformer block in the work by Li et al. [16]. The three convolutional blocks are displayed in Figure 2. The results of our evaluation are shown in Table 1. As it can be seen, the mobile convolutional block [22] performs slightly better than the classical residual block [9] and the next convolutional block [16] performs considerably worse under the same latency con-

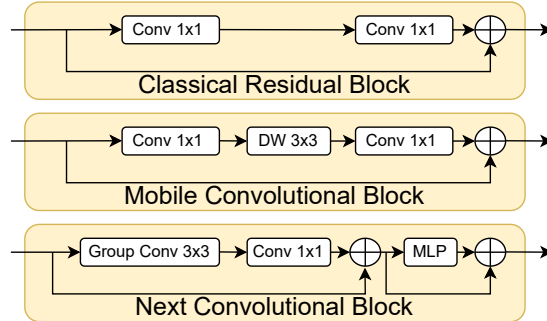

Figure 2. Architecture comparison of different convolution-based blocks. DW stands for Depthwise Convolution. Batchnorm and ReLU layers are omitted for brevity. The classical residual block was introduced by He et al. [9], the mobile convolutional block by Sandler et al. [22] is used in MobileNet and AlphaVile and the next convolutional block was introduced and used in NextViT by Li et al. [16].

straints. Therefore, we use the mobile convolutional block as our default convolutional base block in AlphaVile.

We further investigated different amounts of transformer blocks into the convolutional architecture, as shown in Table 2. As proposed in the work by Li et al. [16] we are putting a single transformer block after a specified number of convolutional blocks, rather than putting all transformer blocks at the end of the network. It turns out that for this size of 15 convolutional blocks, low amounts give better results than high amounts of transformer blocks and two transformer blocks give the best results.

3 AlphaVile-FX: Representation Matters

AlphaZero traditionally represents the board position, i.e., the game state, in the form of a stack of so-called planes. Each plane is encoded as an 8×8 board, where each coordinate represents a field on the chess board. A basic board representation for chess can be found in the top section of Table 3. We distinguish between two types of planes, called *bool* and *int*. The first type describe planes, where the value of each field is either 0 or 1. As an example, the first plane describes which fields are occupied by pawns of player one, i.e., is 1 if a pawn of player one occupies the field and 0 else. The second type, called *int*, describes a natural number instead of a binary value per field. For better processing and numerical stability, we scale the *int*-features into the 0-1 range using the maximum feature value respectively. In total, we have 39 planes, i.e., our input is described as a tensor with length $39 \times 8 \times 8$. The input representation is identical to the representation used by Czech et al. [4].

Table 1. Training results of comparing different convolution blocks in the core part of the model. The mobile convolutional block using an expansion ratio of three performs slightly better than the classical residual block and significantly better than the next convolutional block. All three setups have a similar latency on GPU. The best results are shown in bold.

Convolutional Block	Blocks	Channels	Combined Loss	Policy Acc. (%)
Classical residual block [9]	10	192	1.235 ± 0.0031	57.5 ± 0.14
Mobile conv. block [22]	9	256	1.2343 ± 0.0023	57.53 ± 0.05
Next conv. block[16]	10	256	1.2411 ± 0.0009	57.33 ± 0.05

Table 2. Grid search results of different transformer block configurations in the AlphaVile model, as described in Figure 1. Using two stage 2 blocks (B) gives the best result, shown in **bold**. The number of Mobile Blocks (N_1, N_2) is adapted so that the model stays comparable in size. The number of transformer blocks (NTBs) is equal to B .

#Stage 2 Blocks (B)	N_1	N_2	Combined Loss	Policy Acc. (%)
0	18	0	1.1901 ± 0.0049	58.67 ± 0.17
1	8	8	1.192 ± 0.0021	58.57 ± 0.17
2	5	5	1.1887 ± 0.0065	58.67 ± 0.12
3	5	4	1.2061 ± 0.014	58.3 ± 0.43
4	4	3	1.2327 ± 0.0045	57.57 ± .047

3.1 Extending the Representation

It is widely acknowledged that representation plays a significant role in traditional machine learning in achieving desirable result and is currently under debate of its role in deep learning. Consequently, we start by investigating whether we can improve the representation of our input features and loss function independently of the architecture we use.

In an alternative input representation, see top and bottom section of Table 3, we add additional features such as a representation of the material configuration of both players and remove the color information and current move count to avoid overfitting to this data information. In fact, our new input definition performs better both with respect to the policy and value loss. We argue that this is the case because although these new features can be inferred by processing existing features, they prove to be useful and implicitly increase the capacity of the network as they do not need to be computed by the network itself. As Table 4 shows, feature engineering can still prove to be useful even in the field of deep neural networks.

3.1.1 New Value Loss Representation

As proposed in other engines for the game of Go [29], using auxiliary targets in the loss function during training appears to be beneficial in chess, too. Here, Henrik Forstén sug-

gested using a separate Win-Draw-Loss-Head (WDL)² to predict the percentage ratio of winning, drawing and losing and a Moves Left Head³ to predict the number of moves until the games is over. In our case, we integrate an additional output to the value head to predict the number of remaining plys (half-moves) until the end of the game and refer to the new value head as WDLP Value Head. One can use

$$\text{value}_{\text{output}} = -L_{\text{output}} + W_{\text{output}} \quad (2)$$

to infer the classical value $\text{value}_{\text{output}} \in [-1, +1]$ from the WDL output expression. Here, L_{output} presents the probability of losing and W_{output} describes the probability of winning the game. Table 5 verifies that using new loss formulation proves to be beneficial.

This results in an updated loss function, where we use a shared value policy loss with the number of plys remaining as an auxiliary target:

$$\ell = -\alpha(\text{WDL}_t \log \text{WDL}_p) - \pi \log \mathbf{p} + \beta(\text{ply}_t - \text{ply}_p)^2 + c \|\theta\| \quad (3)$$

Instead of expressing the value loss as a mean squared error $\in [-1, +1]$, we define it using WDL_p , a distribution over the predicted chance of winning, drawing or losing. Finally, α and β are scalar value to adjust the weighting of the individual loss components.

²<https://github.com/LeelaChessZero/lc0/pull/635>, accessed 2022-11-11

³<https://github.com/LeelaChessZero/lc0/pull/961>, accessed 2022-11-11

Table 3. Plane representation for chess. Features are encoded as binary maps and features with * are single values set over the entire 8×8 plane. The history is represented by a trajectory over the last eight moves. The table starts with the traditional input features (all features above the dashed line). The extended input representation adds the features following the dashed line and removes two features indicated by ~~strike-through~~.

Feature	Planes	Type	Comment
P1 piece	6	bool	order: {PAWN, KNIGHT, BISHOP, ROOK, QUEEN, KING}
P2 piece	6	bool	order: {PAWN, KNIGHT, BISHOP, ROOK, QUEEN, KING}
Repetitions*	2	bool	how often the board positions has occurred
En-passant square	1	bool	the square where en-passant capture is possible
Colour*	1	bool	all zeros for black and all ones for white
Total move count*	1	int	integer value setting the move count (UCI notation)
P1 castling*	2	bool	binary plane, order: {KING_SIDE, QUEEN_SIDE}
P2 castling*	2	bool	binary plane, order: {KING_SIDE, QUEEN_SIDE}
No-progress count*	1	int	sets the no progress counter (FEN halfmove clock)
Last Moves	16	bool	origin and target squares of the last eight moves
is960*	1	bool	if the 960 variant is active
<hr style="border-top: 1px dashed black;"/>			
P1 pieces	1	bool	grouped mask of all P1 pieces
P2 pieces	1	bool	grouped mask of all P2 pieces
Checkerboard	1	bool	chess board pattern
P1 Material difference*	5	int	order: {PAWN, KNIGHT, BISHOP, ROOK, QUEEN}
Opposite color bishops*	1	bool	if they are only two bishops of opposite color
Checkers	1	bool	all pieces giving check
P1 material count*	5	int	order: {PAWN, KNIGHT, BISHOP, ROOK, QUEEN}
Total	52		

Table 4. Results of using different input representations. Using an adapted input representation improves both the value and policy loss. **Bold** shows best results.

Input Representation	Combined Loss	Policy Acc. (%)	Value Loss
Inputs V.1.0	1.1918 ± 0.0028	58.63 ± 0.05	0.4448 ± 0.0007
Inputs V.2.0	1.1901 ± 0.0049	58.67 ± 0.17	0.4371 ± 0.0002

Our experiments have shown that both the extension of the input features and the adjustment of the loss function lead to an improvement in terms of loss, and more specifically in terms of accuracy. Therefore, we introduce the suffix “FX”, indicating that the model is using our Feature eXtension, meaning the extended input representation and the WDLP value head.

4 Representation Matters to Master the Game of Chess

Our intention here is to investigate empirically AlphaZero, AlphaVile and their “-FX” variants with respect to accuracy, latency and their playing strength against each other, as well as against some other baselines. The training hyperparameters for all our experiments can be found in the

Appendix. Moreover, we used three seeds for our setups to improve statistical significance. As our database we used the KingBase Lite 2019 data set⁴. KingBase Lite 2019 is a free chess database containing over 1 million chess games played since 2000 by human expert players with a player ELO rating greater than 2200. Latency is measured on an RTX 2070 OC using a batch-size of 64 with a TensorRT-8.0.1.6 backend.

4.1 Trade-off between Efficiency and Accuracy

As described in Han et al. [8], transformers can often experience high latency, which is a major disadvantage in competitive situations when high throughput becomes as relevant as a good precision. By combining convolutional

⁴<https://archive.org/details/KingBaseLite2019>, accessed-2022-11-02

Table 5. Results of using different value heads. Using a WDLP as the value head performs best. **Bold** shows best.

Value Head Type	Combined Loss	Policy Acc. (%)	Value Loss
MSE	1.1933 ± 0.0021	58.5 ± 0.08	0.4406 ± 0.0002
WDLP	1.1901 ± 0.0051	58.73 ± 0.12	0.4356 ± 0.0006

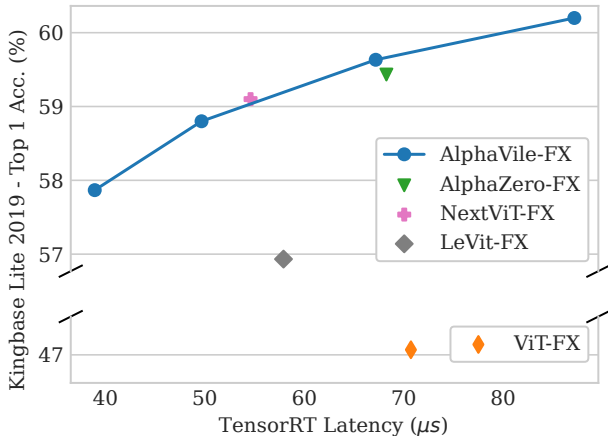

Figure 3. Comparison among AlphaVile and efficient networks with respect to accuracy-latency trade-off. Results are measured using three seeds. Details can be found in Table 6

base blocks and transformer blocks, we aim to reduce the latency without losing a significant amount of accuracy on our test data set. To show the effect of the network size on its latency, we propose four different sizes for our AlphaVile architecture, a description can be found in the Appendix. Since the AlphaVile architecture in Section 2 is very small with a total number of 17 Blocks ($N_1 = N_2 = 5, B = 2$) and has a rather low latency, between our new tiny and small model, we scaled AlphaVile to have similar latencies to the other architectures.

We start by investigating the performance of a plain full transformer based neural network, ViT [6], in combination with AlphaZero. We reduced the network size for these approaches, so they have comparable latency values. A ViT model with the same amount of blocks as our AlphaVile model would have much higher latency. As can be seen in Table 6 or Figure 3 these networks achieve a relatively high loss and a low accuracy compared to AlphaZero. Consequently, we evaluate the combination of convolutional and transformer blocks. We tested LeViT [7], NextViT [16] and our own AlphaVile, also shown in Table 6. These approaches improve over the pure ViT based approach and can reach comparable numbers too AlphaZero. It is also clearly recognizable that the latency, as well as the accuracy,

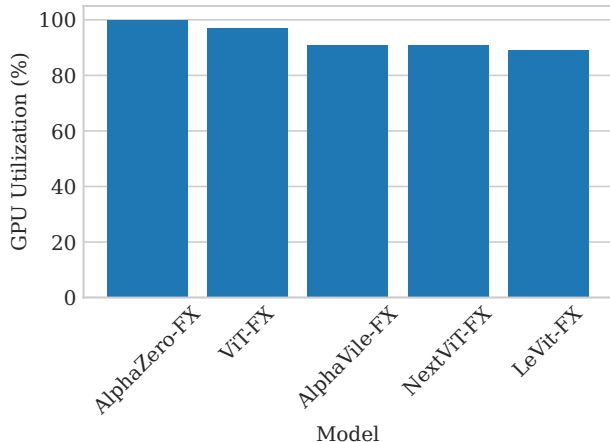

Figure 4. The standard AlphaZero-FX network has the best GPU utilization compared to other model architectures.

scales with our network size. As can be seen in Figure 4 the pure convolutional ResNet architecture of AlphaZero has the highest GPU utilization of 100%. The GPU utilization of different vision transformer architectures varies between 89% and 97%.

4.2 Comparing Playing Strength

Finally, in order to test the playing strength of our ViT models, we let AlphaVile, ViT and AlphaZero compete against each other in a round-robin tournament. The results can be found in Figure 5. It can be seen that ViT does not come close to the playing strength of AlphaZero and AlphaVile. This is consistent with the results in Figure 3. AlphaVile-FX can perform comparable to AlphaZero if it gets enough time per move. However, it is worth noting that the best model tested was the improved AlphaZero-FX model, using the extended input and loss representation. In situations with less time per move, our AlphaZero models perform fundamentally better than our AlphaVile model. It can also be seen that our changes in input and loss representation yield an improvement of about 180 Elo for AlphaZero. The situation is similar for AlphaVile and our ViT model. All games are played using a fixed number of milliseconds per move ranging from 0.1s to 1.6s. We also use opening suites to allow a greater game variety.

Table 6. Comparison of different neural network architectures. All networks use the extended input representation and WDLP value loss formulation. It can be seen that our largest AlphaVile model gives the best result with the trade-off for having a higher latency, while the normal-sized AlphaVile is comparable with ResNet in context of accuracy and latency.

Network Architecture	Combined Loss	Policy Acc. (%)	Latency (μ s)
AlphaZero-FX [24]	1.1673 ± 0.004	59.43 ± 0.09	68.25
LeViT-FX [7]	1.2596 ± 0.004	56.93 ± 0.09	57.9
NextViT-FX [16]	1.1725 ± 0.004	59.1 ± 0.08	54.59
ViT-FX [6]	1.6866 ± 0.0014	47.4 ± 0.16	70.72
AlphaVile-FX (large)	1.1323 ± 0.0053	60.2 ± 0.16	87.15
AlphaVile-FX (normal)	1.1531 ± 0.0037	59.63 ± 0.13	67.18
AlphaVile-FX (small)	1.1861 ± 0.0082	58.8 ± 0.22	49.66
AlphaVile-FX (tiny)	1.2193 ± 0.0101	57.87 ± 0.25	38.92

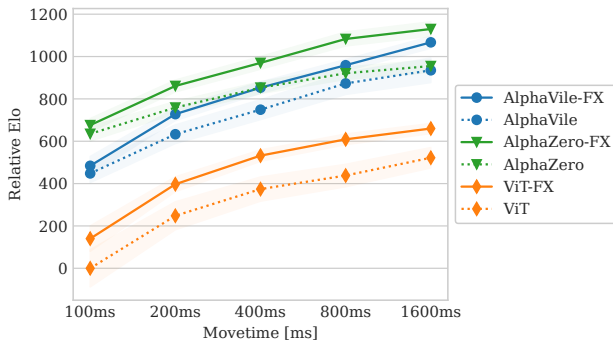

Figure 5. The AlphaZero-FX network outperforms the vanilla version that uses input representation version 1 and no WDLP head. The AlphaVile network approaches AlphaZero network in strength at higher move times.

5 Related Work

Even though transformers were primarily developed for supervised learning settings, such as those often found in natural language processing or computer vision, they are now also being used repeatedly in the field of reinforcement learning. The goal of combining transformers and reinforcement learning is often to model and in many cases improve the decision-making process through the use of attention. Many RL problems can be viewed and modelled as sequential problems [13]. There are multiple possibilities for combining transformers and RL, for example in the area of architecture enhancement or trajectory optimization [11]. The best-known current approaches include Trajectory Transformer [13] and Decision Transformer [2]. A good overview on the topic of transformers in RL can be found in the works by Li et al. [17] and Hu et al. [11].

The use of transformers in the domain of chess was also tried before [5, 20, 27]. However, these approaches are fun-

damentally different from ours. All of them try to learn chess using a Large Language Model (LLM). They use the so-called PGN notation or their own vocabulary to display chess positions in a textual form and approach the problem from a natural language perspective. While they were able to learn the rules of chess, they were not able to play it on the level of AlphaZero or AlphaVile. An idea different from using transformers to play chess, is to use them to generate comments on chess positions to improve comprehensibility and traceability [15].

The current state-of-the-art in chess can best be described with two model architectures. On the one hand, we have agents who have taken up the idea of AlphaZero and developed it further, with Leela Chess Zero (Lc0) probably being the best-known representative here.

On the other hand, there is Stockfish, one of the oldest chess engines, which nowadays is using the so-called NNUE architecture. “NNUE” stands for “Efficiently Updatable Neural Network” and is a neural network architecture first introduced by Nasu [19] for the game of shogi. It allows more efficient updates to the network weights during gameplay, leading to better playing performance in shogi. NNUE is a very specific architecture, therefore it is rather unknown outside the shogi and chess community.

In recent years, these two approaches have dominated the chess domain, as can be seen in the results of the Top Chess Engine Championship (TCEC) between 2019 and 2023.

6 Conclusion

The new input representation and value loss definition exceeded our expectations of their effect on playing strength. A common but falsely assumption is that feature engineering has become obsolete for deep learning networks. An improved input representation, however, can be beneficial, as proven by NNUE networks which are in contrast to ResNet shallow multi-layer perceptrons. We show

that this also holds true, both for deep convolution networks and vision transformers. Our new input representation makes use of new features which are either a combination of other features, e.g., material difference and material count, or features that are implicitly available by the rules of chess, e.g., features like checkers and opposite color bishops. The material difference features are the core of many hand-crafted evaluation functions for chess. By giving the neural network direct access to it, we allow the network to focus on more complex abstracts of the game position. Otherwise, the model has to generate relevant features on its own. A simple input representation has some advantages as well, e.g., by being more generally applicable, however, by introducing new features and some beneficial bias, we can help and accelerate learning. Feature engineering is and remains an interesting field, even in times of DL and large transformer models.

Transformers have the advantage of generalized global feature processing and handling long input sequences via the attention mechanism. Nevertheless, they are not the panacea for all use cases and have their own problems. In competitive timed games, such as chess, it is not only accuracy that matters, but also the efficiency of the models. By combining transformers with CNNs, we benefit of their efficient pattern recognition ability. However, even if we address the latency problem of transformers in this way, our combined models cannot improve over our pure convolutional network baseline AlphaZero. It is worth noting that ViTs are just one of many transformer architectures, and others like Decision Transformer [2] may provide different results. It is also possible that transformers that are specifically adapted to chess could actually lead to an improvement over conventional approaches. Current experiments by the Lc0 developer team on this seem promising. This paper does not aim to be conclusive, but rather to emphasize that incorporating transformers into chess algorithms is not a straightforward but interesting task. Nevertheless, we believe that transformers hold great potential for enhancing computer chess, especially areas such as multimodal inputs [31] and retrieval-based approaches [1] could open new ways to how computers play chess.

The main take away message of our paper is, however, that representation matters: changes to the input features and loss function improved the chess performance far more than replacing ResNet with a transformer: Feature engineering is not dead. In contrary, it stays “forever young”.

Acknowledgements

We thank the following persons for reviewing, early discussions, and providing many helpful comments and suggestions: Hung-Zhe Lin and Felix Friedrich for their input and ideas. Ofek Shochat for his feedback and comments. We are also thankful for the discussion with Daniel Monroe about Lc0.

Funding

This work was partially funded by the Hessian Ministry of Science and the Arts (HMWK) within the cluster project “The Third Wave of Artificial Intelligence - 3AI”.

References

- [1] S. Borgeaud, A. Mensch, J. Hoffmann, T. Cai, E. Rutherford, K. Millican, G. B. Van Den Driessche, J.-B. Lespiau, B. Damoc, A. Clark, et al. Improving language models by retrieving from trillions of tokens. In *International conference on machine learning*, pages 2206–2240. PMLR, 2022.
- [2] L. Chen, K. Lu, A. Rajeswaran, K. Lee, A. Grover, M. Laskin, P. Abbeel, A. Srinivas, and I. Mordatch. Decision transformer: Reinforcement learning via sequence modeling. In M. Ranzato, A. Beygelzimer, Y. Dauphin, P. Liang, and J. W. Vaughan, editors, *Advances in Neural Information Processing Systems*, volume 34, pages 15084–15097. Curran Associates, Inc., 2021. URL <https://proceedings.neurips.cc/paper/2021/file/7f489f642a0ddb10272b5c31057f0663-Paper.pdf>.
- [3] F. Chollet. *Deep learning with Python*. Simon and Schuster, 2021.
- [4] J. Czech, P. Korus, and K. Kersting. Improving alphazero using monte-carlo graph search. In *Proceedings of the International Conference on Automated Planning and Scheduling*, volume 31, pages 103–111, 2021.
- [5] M. DeLeo and E. Guven. Learning chess with language models and transformers. In *Data Science and Machine Learning*. Academy and Industry Research Collaboration Center (AIRCC), sep 2022. doi: 10.5121/csit.2022.121515. URL <https://doi.org/10.5121/csit.2022.121515>.
- [6] A. Dosovitskiy, L. Beyer, A. Kolesnikov, D. Weissenborn, X. Zhai, T. Unterthiner, M. Dehghani,

- M. Minderer, G. Heigold, S. Gelly, et al. An image is worth 16x16 words: Transformers for image recognition at scale. *arXiv preprint arXiv:2010.11929*, 2020.
- [7] B. Graham, A. El-Nouby, H. Touvron, P. Stock, A. Joulin, H. Jégou, and M. Douze. Levit: a vision transformer in convnet’s clothing for faster inference. In *Proceedings of the IEEE/CVF international conference on computer vision*, pages 12259–12269, 2021.
- [8] K. Han, Y. Wang, H. Chen, X. Chen, J. Guo, Z. Liu, Y. Tang, A. Xiao, C. Xu, Y. Xu, Z. Yang, Y. Zhang, and D. Tao. A survey on vision transformer. *IEEE Transactions on Pattern Analysis and Machine Intelligence*, 45(1):87–110, jan 2023. doi: 10.1109/tpami.2022.3152247. URL <https://doi.org/10.1109%2Ftpami.2022.3152247>.
- [9] K. He, X. Zhang, S. Ren, and J. Sun. Deep residual learning for image recognition. In *Proceedings of the IEEE conference on computer vision and pattern recognition*, pages 770–778, 2016.
- [10] A. Howard, M. Sandler, G. Chu, L.-C. Chen, B. Chen, M. Tan, W. Wang, Y. Zhu, R. Pang, V. Vasudevan, et al. Searching for mobilenetv3. In *Proceedings of the IEEE/CVF international conference on computer vision*, pages 1314–1324, 2019.
- [11] S. Hu, L. Shen, Y. Zhang, Y. Chen, and D. Tao. On transforming reinforcement learning by transformer: The development trajectory, 2023.
- [12] G. Huang, Y. Sun, Z. Liu, D. Sedra, and K. Q. Weinberger. Deep networks with stochastic depth. In *European conference on computer vision*, pages 646–661. Springer, 2016.
- [13] M. Janner, Q. Li, and S. Levine. Offline reinforcement learning as one big sequence modeling problem. In *Advances in Neural Information Processing Systems*, 2021.
- [14] L. Kocsis and C. Szepesvári. Bandit based monte-carlo planning. In *European conference on machine learning*, pages 282–293. Springer, 2006.
- [15] A. Lee, D. Wu, E. Dinan, and M. Lewis. Improving chess commentaries by combining language models with symbolic reasoning engines, 2022.
- [16] J. Li, X. Xia, W. Li, H. Li, X. Wang, X. Xiao, R. Wang, M. Zheng, and X. Pan. Next-vit: Next generation vision transformer for efficient deployment in realistic industrial scenarios. *arXiv preprint arXiv:2207.05501*, 2022.
- [17] W. Li, H. Luo, Z. Lin, C. Zhang, Z. Lu, and D. Ye. A survey on transformers in reinforcement learning. *arXiv preprint arXiv:2301.03044*, 2023.
- [18] V. Micheli, E. Alonso, and F. Fleuret. Transformers are sample-efficient world models, 2023.
- [19] Y. Nasu. Efficiently updatable neural-network-based evaluation functions for computer shogi. *The 28th World Computer Shogi Championship Appeal Document*, 185, 2018.
- [20] D. Noever, M. Ciolino, and J. Kalin. The chess transformer: Mastering play using generative language models. *arXiv preprint arXiv:2008.04057*, 2020.
- [21] R. Pope, S. Douglas, A. Chowdhery, J. Devlin, J. Bradbury, A. Levskaya, J. Heek, K. Xiao, S. Agrawal, and J. Dean. Efficiently scaling transformer inference. *arXiv preprint arXiv:2211.05102*, 2022.
- [22] M. Sandler, A. Howard, M. Zhu, A. Zhmoginov, and L.-C. Chen. Mobilenetv2: Inverted residuals and linear bottlenecks. In *Proceedings of the IEEE conference on computer vision and pattern recognition*, pages 4510–4520, 2018.
- [23] M. Siebenborn, B. Belousov, J. Huang, and J. Peters. How crucial is transformer in decision transformer? *arXiv preprint arXiv:2211.14655*, 2022.
- [24] D. e. a. Silver. Mastering the game of Go without human knowledge. *Nature*, 550(7676):354–359, Oct. 2017. ISSN 1476-4687. doi: 10.1038/nature24270. URL <https://doi.org/10.1038/nature24270>.
- [25] D. e. a. Silver. A general reinforcement learning algorithm that masters chess, shogi, and Go through self-play. *Science*, 362(6419):1140–1144, Dec. 2018. ISSN 0036-8075, 1095-9203. doi: 10.1126/science.aar6404. URL <https://www.sciencemag.org/lookup/doi/10.1126/science.aar6404>.
- [26] M. Tan and Q. Le. Efficientnet: Rethinking model scaling for convolutional neural networks. In *International conference on machine learning*, pages 6105–6114. PMLR, 2019.
- [27] S. Toshniwal, S. Wiseman, K. Livescu, and K. Gimpel. Chess as a testbed for language model state tracking. In *Proceedings of the AAAI Conference on Artificial Intelligence*, volume 36, pages 11385–11393, 2022.

- [28] A. Vaswani, N. Shazeer, N. Parmar, J. Uszkoreit, L. Jones, A. N. Gomez, Ł. Kaiser, and I. Polosukhin. Attention is all you need. *Advances in neural information processing systems*, 30, 2017.
- [29] D. J. Wu. Accelerating self-play learning in go. *arXiv preprint arXiv:1902.10565*, 2019.
- [30] X. Xia, J. Li, J. Wu, X. Wang, M. Wang, X. Xiao, M. Zheng, and R. Wang. Trt-vit: Tensorrt-oriented vision transformer. *arXiv preprint arXiv:2205.09579*, 2022.
- [31] P. Xu, X. Zhu, and D. A. Clifton. Multimodal learning with transformers: A survey. *arXiv preprint arXiv:2206.06488*, 2022.

Appendix

Table 7. Hyperparameter configuration for running the experiments.

Hyperparameter	Value	Hyperparameter	Value
max learning rate	0.07	value loss factor	0.01
min learning rate	0.00001	policy loss factor	0.988
batch size	1024	wdl loss factor	0.01
max momentum	0.95	plys to end loss factor	0.002
min momentum	0.8	stochastic depth probability	0.05
epochs	7	pytorch version	1.12.0
optimizer	NAG		

Table 8. Architecture definition of AlphaVile for sizes tiny, small, normal and large. All versions use a channel expansion ratio of 2 and a ratio of 50% 3×3 and 50% 5×5 convolutions.

Size	B	N_1	N_2	Total Number of Blocks	Base Channels
AlphaVile (tiny)	1	8	6	15	192
AlphaVile (small)	1	11	10	22	192
AlphaVile (normal)	2	10	7	26	224
AlphaVile (large)	2	13	11	37	224