

## Phylo2Vec: a vector representation for binary trees

MATTHEW J PENN<sup>1\*</sup>, NEIL SCHEIDWASSER<sup>2\*</sup>, MARK P KHURANA<sup>2</sup>, DAVID A DUCHÊNE<sup>5</sup>, CHRISTL A DONNELLY<sup>1,3</sup>, AND SAMIR BHATT<sup>2,4</sup>

<sup>1</sup> *Department of Statistics, University of Oxford, Oxford, United Kingdom*

<sup>2</sup> *Section of Epidemiology, University of Copenhagen, Copenhagen, Denmark*

<sup>3</sup> *Pandemic Sciences Institute, University of Oxford, Oxford, United Kingdom*

<sup>4</sup> *MRC Centre for Global Infectious Disease Analysis, Imperial College London, London, United Kingdom*

<sup>5</sup> *Center for Evolutionary Hologenomics, University of Copenhagen, Copenhagen, Denmark*

\* *Equal contribution*

CORRESPONDENCE: [neil.clow@sund.ku.dk](mailto:neil.clow@sund.ku.dk)

### ABSTRACT

Binary phylogenetic trees inferred from biological data are central to understanding the shared evolutionary history of organisms. Inferring the placement of latent nodes in a tree by any optimality criterion (e.g., maximum likelihood) is an NP-hard problem, propelling the development of myriad heuristic approaches. Yet, these heuristics often lack a systematic means of uniformly sampling random trees or effectively exploring a tree space that grows factorially, which are crucial to optimisation problems such as machine learning. Accordingly, we present Phylo2Vec, a new parsimonious representation of a phylogenetic tree. Phylo2Vec maps any binary tree with  $n$  leaves to an integer vector of length  $n - 1$ . We prove that Phylo2Vec is both well-defined and bijective to the space of phylogenetic trees. The advantages of Phylo2Vec are twofold: i) easy uniform sampling of binary trees and ii) systematic ability to traverse tree space in very large or small jumps. As a proof of concept, we use Phylo2Vec for maximum likelihood inference on five real-world datasets and show that a simple hill climbing-based optimisation can efficiently traverse the vastness of tree space from a random to an optimal tree.

*Keywords:* phylogenetics, representation, binary trees, optimisation

Phylogenetic trees are a fundamental tool in depicting evolutionary processes, whether linguistic (evolution of different languages and language families) or biological (evolution of biological entities). In the latter field, phylogenetic trees are integral to multiple research domains, including evolution ([Morlon et al., 2010](#)), conservation ([Rolland et al., 2011](#)), and epidemiology, where they allow us to better understand infectious disease transmission dynamics ([Ypma et al., 2013](#); [Faria et al., 2021](#)).

A multitude of computer-readable formats have been proposed to store and represent (binary) phylogenetic trees. While basic data structures such as arrays or linked lists can be used for this purpose, the Newick format, as outlined by [Olsen \(1990\)](#) and [Felsenstein \(2004\)](#), has emerged as the standard notation. This format characterises a tree through a string of nested parentheses. Each parenthesis encloses a pair of leaf nodes or subtrees, separated by a comma. Additional metadata such as branch lengths can be added after a colon which follows the leaf node or subtree. Although a compact and intuitive notation, several limitations exist. First, comparing (large) trees using the Newick format can be difficult for human readers, especially as isomorphic trees can be obtained by permuting nodes or subtrees within a set of parentheses. Second, sampling random Newick strings is non-trivial. Alternative, bijective representations do exist. For instance, a number of methods have been proposed to assign unique integers to binary trees with unlabelled ([Rotem and Varol, 1978](#); [Proskurowski, 1980](#)), fully labelled ([Knuth, 1973](#)), and partially labelled nodes ([Rohlf, 1983](#)) (only leaf nodes). More recently, [Palacios et al. \(2022\)](#) investigated several enumeration strategies of binary trees compatible with a perfect phylogeny. However, as mentioned by [Rohlf \(1983\)](#), using single-integer representations for downstream phylogenetic analyses is computationally difficult for large trees due to the factorial rate at which the size of binary tree space grows [Cavalli-Sforza and Edwards \(1967\)](#). Conversely, several vectorial representations such as graph polynomials ([Liu, 2021](#); [Liu et al., 2022](#)) and the compact bijective ladderized vector [Voznica et al. \(2022\)](#) were introduced as a support for model selection and estimation of evolutionary or epidemiological parameters. Other vectorial representations of

tree topology, such as pair matchings (Diaconis and Holmes, 1998) and F matrices Kim et al. (2020), are focused on the polynomial-time computation of the distance between any two trees (to measure similarity). However, methods to systematically sample random trees or change tree topology with respect to an objective function by leveraging such vectorial representations have been understudied. In particular, creating sampling schemes around standard tree arrangements is cumbersome, and, although inferring phylogenetic trees is a common task in evolutionary biology, tree search using any optimality criteria (including maximum likelihood) is NP-hard (Roch, 2006). Another critical challenge is the size of the tree space: for a tree with  $n$  leaves, there are  $(2n - 3) \cdot (2n - 5) \cdot \dots \cdot 5 \cdot 3 \cdot 1$  possible rooted binary trees (Cavalli-Sforza and Edwards, 1967). Lastly, optimisation-based approaches often face a jagged “loss” landscape containing many trees with the same criterion score (Sanderson et al., 2011).

To overcome these limitations, we introduce Phylo2Vec, a new representation for any binary tree. In this framework, a binary tree’s topology can be completely described by a single integer vector  $\mathbf{v}$  of dimension  $n - 1$ , where  $n$  is the number of leaves in the tree. The vector’s construction is intrinsically related to the branching pattern of the tree, and is defined by a simple constraint:  $\mathbf{v}$  is  $v_j \in \{0, 1, \dots, 2(j - 1)\}$  for all  $j \in \{1, \dots, n - 1\}$ . The approach we present here is most similar to that previously introduced by Rohlf (1983), but we focus on the integer representation and its mathematical properties, rather than counting or labelling trees. Additionally, this formulation naturally offers a new measure of distance between trees (e.g., by comparing two vectors using the Hamming distance) and yields a new mechanism to radically explore tree space which diverges from traditional heuristics such as subtree, prune and regraft (SPR). To further demonstrate its utility, as a proof of concept, we apply Phylo2Vec to several phylogenetic inference problems, where the task is to find an optimal tree given a set of genetic sequences using maximum likelihood estimation. While state-of-the-art frameworks for phylogenetic inference typically rely on search heuristics based on deterministic tree arrangements, Phylo2Vec provides the first steps to a more systematic criterion for optimisation.

## MATERIALS AND METHODS

We first describe an intuitive, but incomplete (as not bijective) integer representation of trees as birth processes. Second, we define and characterise Phylo2Vec as a bijective generalisation of this first representation and formalise its properties. Third, we showcase the utility of Phylo2Vec by applying the representation for MLE-based phylogenetic inference on empirical datasets.

Our bijection draws from an existing method of assigning integer counts to trees (Rohlf, 1983), although we focus on vector representations. Our encoding is distinct in labelling the tree edges, motivated by a simple and intuitive representation of birth processes. By applying our bijection to these *ordered* trees, we are able to move around tree space similarly to subtree-prune and regraft methods. In contrast, it would be very difficult to list all of these ordered trees according to existing depth-first methods of labelling, and so the optimisation algorithm provided in this paper would not work were we using previously-proposed representations. Furthermore, we provide a rigorous proof of its bijectivity alongside a range of algorithms (all implemented into a Python package) which allows researchers to build on the phylogenetic optimisation algorithm we present here. Thus, we provide a significantly different method to those proposed previously (Rohlf, 1983), by focusing our efforts towards practical transitions in tree space.

### *An incomplete integer representation of trees as birth processes*

Let a rooted phylogenetic tree  $\mathcal{T}$  with  $n$  leaf nodes representing (biological) taxa, and a key-value mapping (or dictionary)  $\mathcal{D}$  which associates a non-negative integer (the keys) to each leaf node (the values).

Using this mapping, *for a subset of all trees*, we can summarise their topology using an integer vector  $\mathbf{v}$  of size  $n - 1$  such that:

$$v_j \in \{0, 1, \dots, j - 1\} \quad \forall j \in \{1, \dots, n - 1\} \quad (1)$$

The construction of this vector is inspired by birth processes: assuming a 2 leaf-tree with leaves labelled 0 and 1, we process  $\mathbf{v}$  from left to right.  $v_j$  (also noted as  $\mathbf{v}[j]$  throughout the

paper) denotes the addition of leaf  $j$  such that it forms a cherry with leaf  $v[j]$ . In other words, the branch leading to leaf  $v[j]$  “gives birth” to leaf  $j$ . Algorithms illustrating the conversion from a tree to a vector and *vice versa* are shown in Figure 1.

Although a simple representation of tree topology, it is easy to see from Equation 1 that this construction is incomplete. Indeed, there are  $j$  possible values for any  $v[j]$ , and thus, for  $n$  leaves, there are  $1 \cdot 2 \cdot \dots \cdot (n - 1) = (n - 1)!$  possible vectors, which is less than the number of binary rooted trees,  $(2n - 3)!!$  (where  $!!$  denotes the semifactorial) (Cavalli-Sforza and Edwards, 1967; Felsenstein, 1978; Diaconis and Holmes, 1998). This discrepancy stems from the assumptions of this construction, whereby a new leaf  $j$  has to form a cherry with a previously processed leaf  $0, 1, \dots, j - 1$ . For instance, leaf 2 has to form a cherry with either leaf 0 or 1, but cannot be an outgroup of the (0, 1) subtree. We thus denote trees that follow this incomplete construction of tree space as “ordered” trees, as they require a precise ordering of the leaf nodes.

### *Phylo2Vec*

In this section, we define and formalise the properties of Phylo2Vec, an integer vector representation which extends the formulation presented above to be valid for any binary rooted tree. To ensure bijectivity to this space, we need the vector  $v$  to satisfy the following constraints:

$$v_j \in \{0, 1, \dots, 2(j - 1)\} \forall j \in \{1, \dots, n - 1\} \quad (2)$$

We say  $v \in \mathbb{V}$  if Equation 2 is satisfied. For this representation, there are  $2j - 1$  entries for any position  $j$ . Therefore, the number of possible vectors matches the number of possible binary rooted trees:

$$\prod_{j=1}^{n-1} (2j - 1) = (2(n - 1) - 1)!! = (2n - 3)!!$$

From this observation, we can prove the bijectivity of the mapping simply by showing injectivity - that is, that no two distinct vectors  $v$  and  $w$  lead to the same tree. A proof is presented in the Appendix ([Phylo2Vec details](#)).

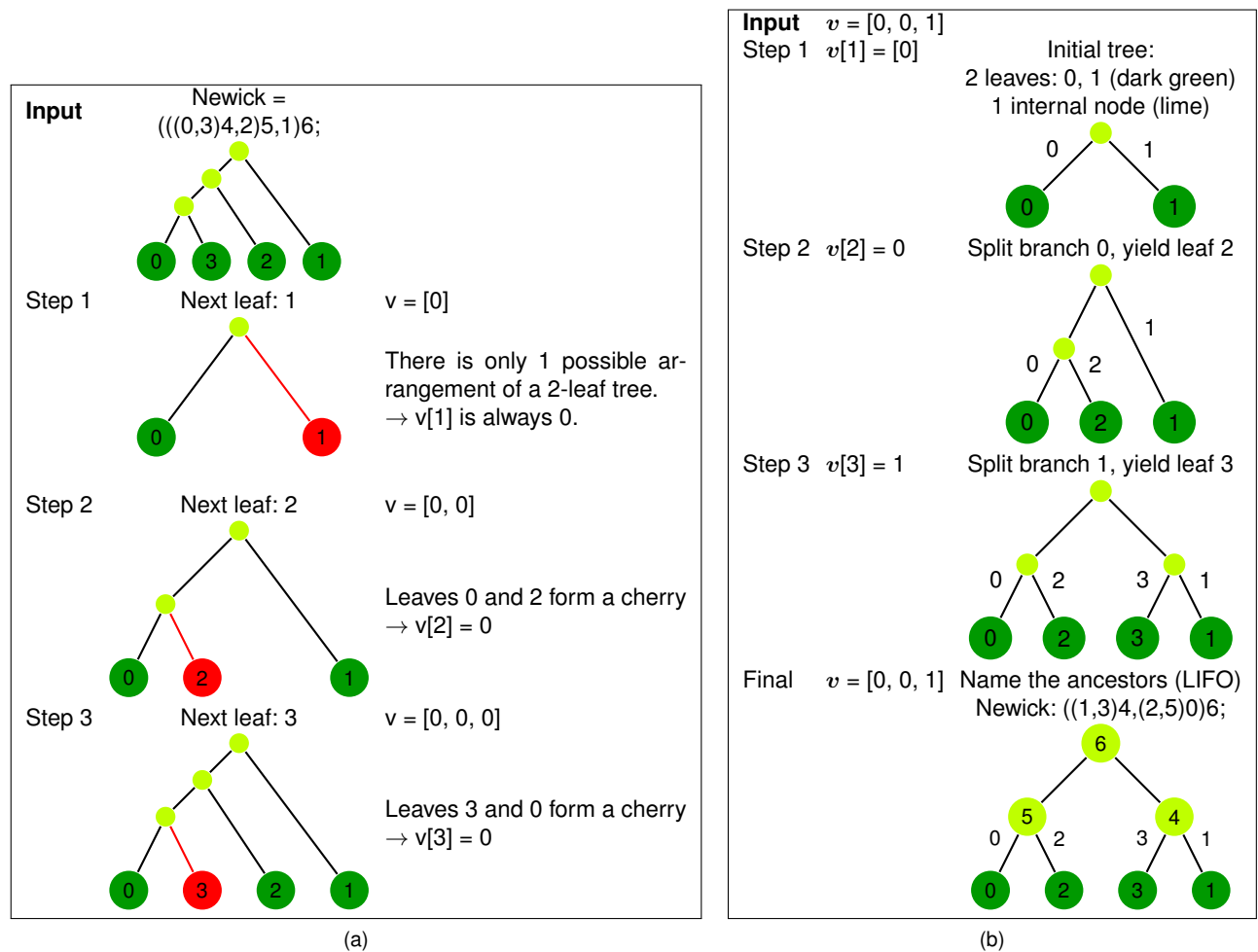

Fig. 1. An incomplete integer representation of tree topology as birth processes. **(a)** Labelling a tree as an ordered vector: example for  $v = [0, 0, 0]$ . We process leaves from in ascending order. For each leaf  $j$ , we search its sibling, which corresponds to  $v[j]$ . **(b)** Recovering a tree from an ordered vector: example for  $v = [0, 0, 1]$ . We process  $v$  from left to right. Ancestors are named in last-in-first-out (LIFO) fashion: The ancestor of the last added leaf  $L - 1$  (here, leaf 3) is named  $L$  (here, 4), the ancestor of the second-to-last added leaf  $L - 2$  (here, leaf 2) is named  $L + 1$  (here, 5) etc. In both cases, the lengths of the edges are arbitrary.

*Recovering a tree from a Phylo2Vec vector* Building a binary tree from  $v$  follows closely the algorithm in Figure 1, but incorporates two additional requirements. First, we start from a two-leaf tree, whereby the leaves are labelled 0 and 1. The branches that lead to leaves 0, 1 are also labelled 0, 1, respectively. Second, we draw an additional node (called the “extra root”) which is initially connected to the root by a branch labelled 2 (see second row in Figure 2).

The addition of a temporary root in the construction of  $v$  from a tree and vice versa ensures that there are  $2j - 1$  branches from which a leaf  $j$  can descend from. From these

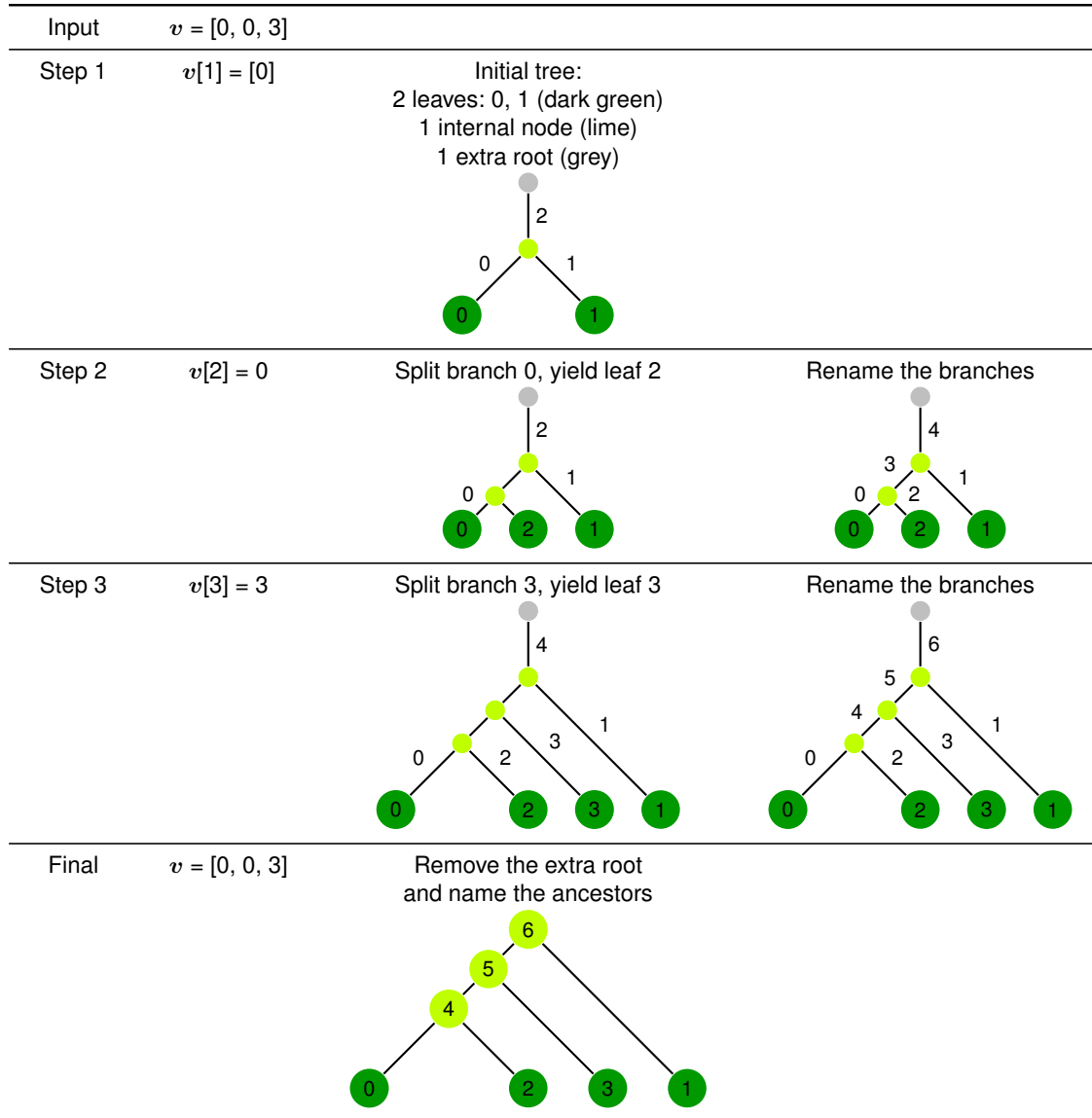

Fig. 2. Recovering a tree from an ordered vector: example for  $v = [0, 0, 3]$ . We process  $v$  from left to right. The branch renaming step depends on the branch type. Leaf branches: For leaf branches, branches that end on leaves  $0, \dots, L - 1$  are labelled  $0, \dots, L - 1$ , respectively. For internal branches, the next branch ( $L$ ) to label is **1**, the deepest and **2**, with the highest children (if there are ties for case 1.). We repeat the same process for internal branches  $L + 1, \dots, 2(L - 1) - 1$ , and label the last branch leading to the extra root  $2(L - 1)$ . See Algorithm S5 and Fig. S2a for more details about implementation and complexity.

requirements, we can build a unique rooted tree  $\mathcal{T}$  by processing  $v$  from left to right, where  $v[j]$  indicates the branch that will split and yield leaf  $j$ . Figure 2 shows a detailed example of this scheme, and other example representations for trees with  $n = 4$  leaves are shown in Figure 3. We also describe (and prove its existence in the Appendix) an inverse algorithm to convert a tree represented in Newick format as a Phylo2Vec vector in Figure 4.

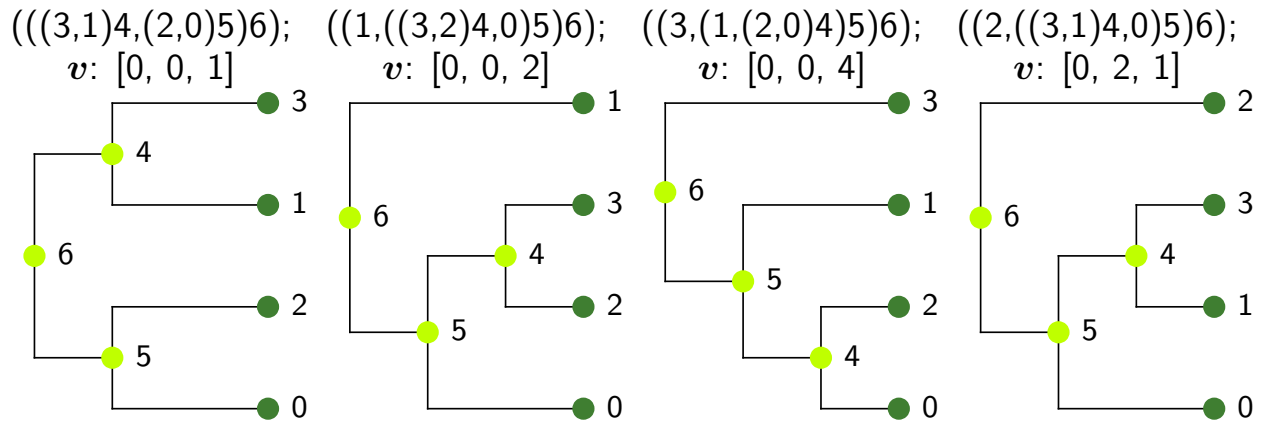
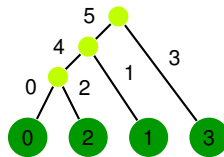

Fig. 3. Example of trees with  $n = 4$  leaves represented in both Newick and Phylo2Vec vector formats. Leaf and internal nodes are coloured in dark green and lime, respectively.

### Input

Newick =  $((((0,2)4,1)5,3)6);$



### Step 1

Next leaf: 1

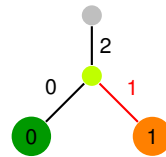

Only 1 possible arrangement of a 2-leaf tree  
 $\rightarrow v[1]$  is always 0.  
 $v = [0]$

### Step 2

Next leaf: 2

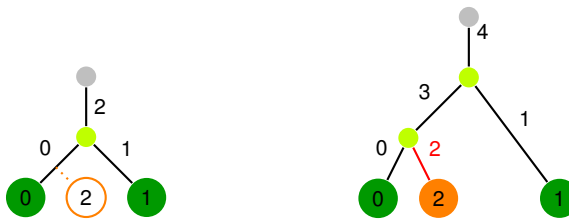

Branch 0 splits and yields leaf 2  
 $\rightarrow v[2] = 0$   
 $v = [0, 0]$

### Step 3

Next leaf: 3

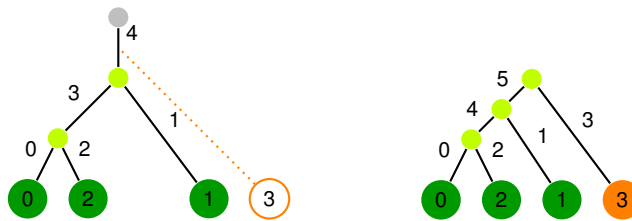

Branch 4 splits and yields leaf 3  
 $\rightarrow v[3] = 4$   
 $v = [0, 0, 4]$

Fig. 4. Labelling a tree as a Phylo2Vec vector  $v$ : example for  $v = [0, 0, 4]$ . We process leaves from in ascending order. For each leaf  $j$ , we search the branch that split and yielded leaf  $j$ , which corresponds to  $v[j]$ . At each step, we re-label the branches with the same process as in Figure 2.



*Complexity* The algorithm underlying Figure 2 and detailed in Algorithm S3 generally runs in linear time (see Fig. S2a). A basic version using NumPy (Harris et al., 2020) runs in a few milliseconds for  $n = 1000$  taxa on a modern CPU. The inverse algorithm (converting a Newick string to a Phylo2Vec  $\mathbf{v}$ ), detailed in Algorithm S4, is of log linear complexity when internal nodes are already labelled and quadratic otherwise (see Fig. S2b). Speedups are made through just-in-time compilation, e.g., using Numba (Lam et al., 2015) in Python.

*Distances between trees* Our formulation of  $\mathbf{v}$  naturally creates a measure of distance between trees. For any two Phylo2Vec trees  $\mathbf{v}$  and  $\mathbf{w}$ , a Hamming distance can be defined as

$$\mu(\mathbf{v}, \mathbf{w}) = \sum_{i=1}^{n-1} \mathbb{I}_{v_i \neq w_i} \quad (3)$$

To compare this distance with other established tree distance measures, we consider a simple discrete random walk in the space of possible Phylo2Vec vectors  $\mathbb{V}$ . At each step, we create a new vector  $\mathbf{w}$  from the previous vector  $\mathbf{v}$  as follows. First, we choose a random subset of the indices  $\mathcal{I} \subseteq \{2, \dots, n-2\}$ . For each  $i \notin \mathcal{I}$ , we set  $w_i = v_i$  and for each  $i \in \mathcal{I}$ ,  $w_i = \min(0, \max(v_i + J(i), 2(i-1)))$  where the  $J(i)$  are iid random variables uniform on the set  $\{-1, 1\}$ . Note that the values of  $J(i)$  at different steps of the walk are also independent, and that the minimum and maximum in the definition of  $w_i$  ensure that it satisfies the constraint  $0 \leq w_i \leq 2(i-1)$ .

As  $1, n-1 \notin \mathcal{I}$ , we fix  $w_1 = 0$  (by our constraints) and  $w_{n-1} = 2(n-2)$  (to ensure that we move in the unrooted tree space). Figure 5 compares  $\mu$  to an approximate subtree prune and regraft (SPR) distance (De Oliveira Martins et al., 2016), Robinson-Foulds (RF) distance (Robinson and Foulds, 1981) and the Kuhner and Felsenstein (KF) distance (Kuhner and Felsenstein, 1994). We note that exact, rooted distance for SPR is NP-hard to compute (Bordewich and Semple, 2005) and therefore cannot be directly compared to our rooted Phylo2Vec formulation. For all distances, we see a nonlinear correspondence, especially for RF and KF distance. Small changes in  $\mathbf{v}$  can lead to very large topological jumps, but equally, small

jumps are also possible. Modifying several indexes in  $\mathbf{v}$  results in significant jumps across tree space, leading to new trees that are very dissimilar. As a result, SPR, RF, or KF distance saturate as we increase the number of changes in  $\mathbf{v}$  (St. John, 2017). However, we note that small changes in  $\mathbf{v}_i$  can also readily correspond to very minor topological changes.

In the exploration of tree space, the number of possible moves for both SPR and Phylo2Vec is of the order  $\mathcal{O}(n^2)$  (see [Phylo2Vec details](#) in the Appendix). Consequently, Phylo2Vec is expected to explore tree space more systematically than proposals based on nearest neighbour interchange but less than those by tree bisection reconnection. However, the number of *single* SPR changes is approximately four times greater than the number of *single* changes in  $\mathbf{v}$  as SPR considers internal nodes while  $\mathbf{v}$  is defined across the leaves, and so Phylo2Vec changes are likely a subset of possible SPR changes.

Whereas Figure 5 shows distances between unrooted trees, our framework, is built on rooted phylogenies at its core. Knowing that all rootings produce the same likelihood due to the pulley principle and reversibility of nucleotide substitution models (Felsenstein, 2004), we can, for any rooted phylogeny, switch to one that is rooted at a different outgroup and has exactly the same likelihood. Therefore, an equivalence class  $\mathcal{V}$  exists where, given a likelihood or parsimony score  $\ell$ , any given Phylo2Vec vector  $\mathbf{v} \in \mathcal{V}$  has the same  $\ell(\mathbf{v})$ , an SPR or RF distance of 0, but a Phylo2Vec distance of  $\mu > 0$ . In practice,  $\mu$  is often very large (comparable to half the maximum SPR distance) between  $\mathbf{v} \in \mathcal{V}$  (see Figure S1), and therefore allows Phylo2Vec an additional mechanism to explore tree space.

*Shuffling Indices* This distance between two trees is not symmetric with respect to the labelling of the trees, as discussed further in the Appendix ([Phylo2Vec details](#)). Depending on the choice of labelling, certain portions of the tree may be easier to optimise than others. This is an undesirable quality and can be remedied by a simple reordering of indices within our algorithm. An example of a reordering algorithm is presented in Figure 6.

Consider a tree  $\mathcal{T}$  where the leaves are labelled by a fixed set of indices  $\{1, 2, \dots, n - 1\}$ . Suppose that  $\sigma$  is a perturbation of  $\{1, 2, \dots, n - 1\}$ , and consider a shuffled tree  $\sigma(\mathcal{T})$  to be a

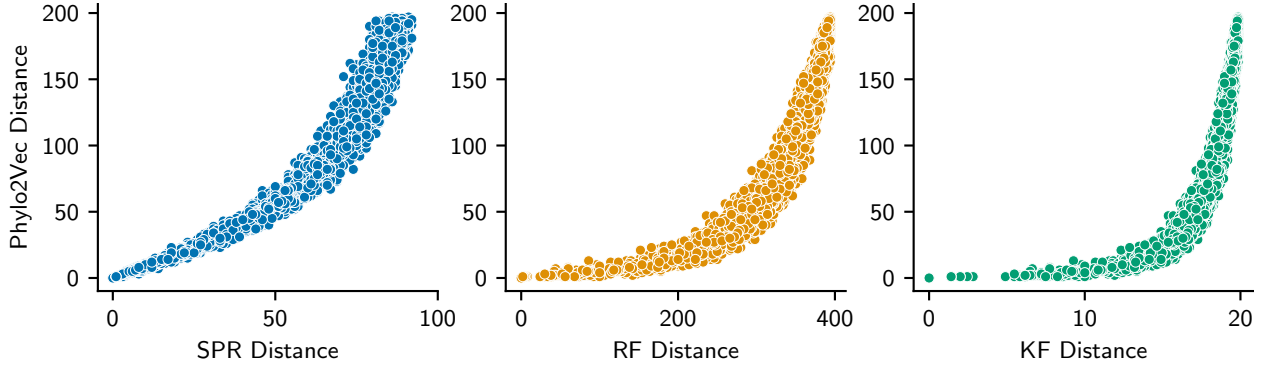

Fig. 5. Comparison of Phylo2Vec moves with three popular tree distances: subtree-prune-and-regraft (SPR; left), Robinson-Foulds (RF; middle), and Kuhner-Felsenstein (KF; right). To generate the distances, a random walk of 5000 steps was performed from a random initial  $\mathbf{v}$  with 200 taxa. At each step, each  $v_i$  can increment, decrement or remain unchanged.

tree with the same topological structure as  $\mathcal{T}$ , but where, for each  $j \in \{1, 2, \dots, n-1\}$ , the leaf with original label  $i$  now has label  $\sigma(j)$ .

Calculating the likelihood requires a tree and a set of genetic data

$\mathcal{D} = (D_1, D_2, \dots, D_{n-1})$ , where  $D_j$  corresponds to the genotype of leaf  $j$  as well as tree  $\mathcal{T}$ . We can then write the likelihood as  $L = L(\mathcal{T}, \mathcal{D})$ . Moreover, defining the shuffled genetic data as  $\sigma(\mathcal{D}) = (D_{\sigma^{-1}(1)}, D_{\sigma^{-1}(2)}, \dots, D_{\sigma^{-1}(n-1)})$ , we can then see that  $L(\mathcal{T}, \mathcal{D}) = L(\sigma(\mathcal{T}), \sigma(\mathcal{D}))$ . This occurs because when computing the likelihood, any calculation for  $L(\mathcal{T}, \mathcal{D})$  that involves the node with original label  $i$  (and hence genetic data  $D_i$ ) will now involve the node with label  $\sigma(i)$  and hence genetic data  $D_{\sigma^{-1}(\sigma(i))} = D_i$ . Thus, since the topological structure of  $\mathcal{T}$  is the same as  $\sigma(\mathcal{T})$ , the likelihood will remain unchanged. A more rigorous proof can be found in the Appendix ([Phylo2Vec details](#)).

One can also recover the vector  $\mathbf{v}$  corresponding to the shuffled tree  $\sigma(\mathcal{T})$ . This is possible because of the bijective relationship between the space of  $\mathbf{v}$ 's and the space of trees. We provide an algorithm that inverts our map from  $\mathbf{v}$  to  $M$  in the Appendix ([Phylo2Vec details](#)). Thus, one can equivalently define a shuffled vector  $\sigma(\mathbf{v})$  (such that  $\sigma(\mathbf{v})$  generates  $\sigma(\mathcal{T})$ ) and consider the likelihood relationship as  $L(\mathbf{v}, \mathcal{D}) = L(\sigma(\mathbf{v}), \sigma(\mathcal{D}))$ . This allows for discrete optimisation steps to be taken with respect to the new shuffled  $\mathbf{v}$ , increasing the flexibility of the algorithm while

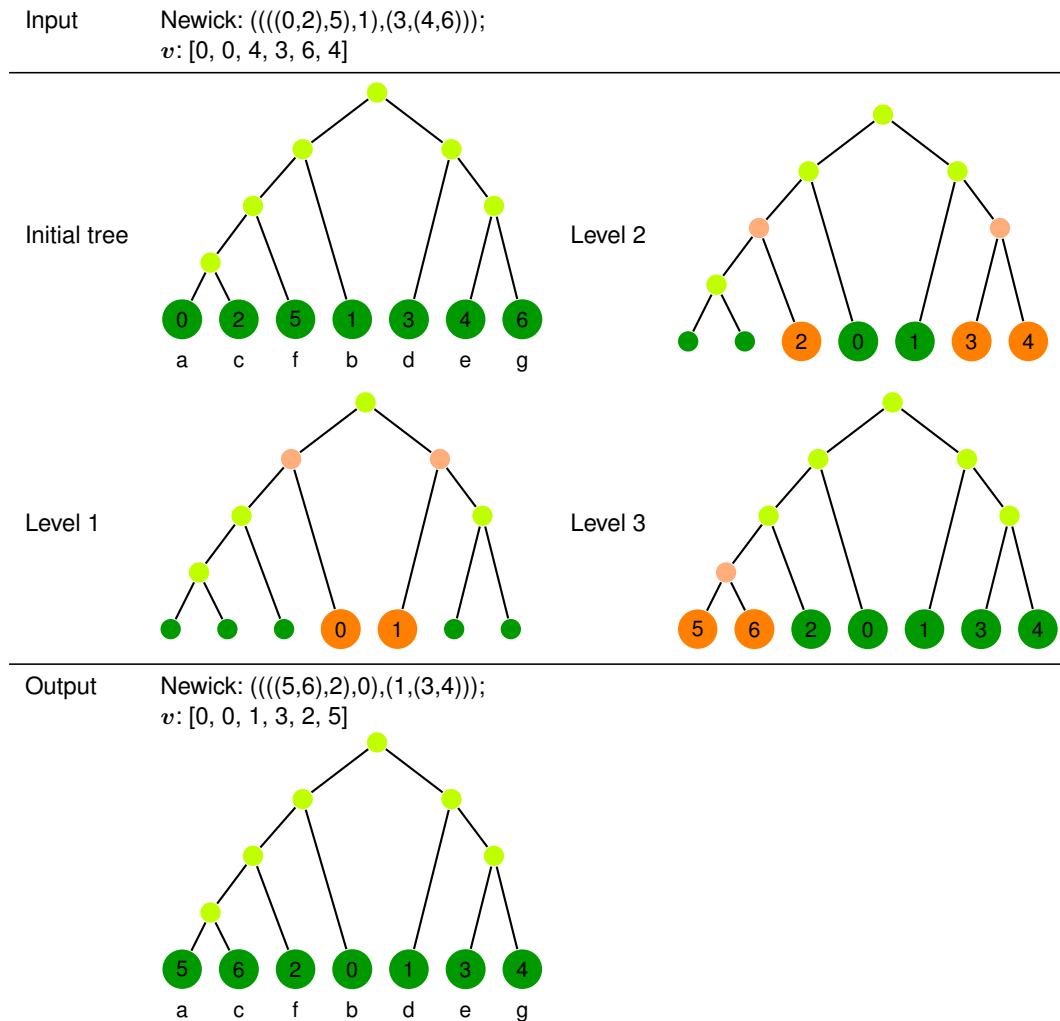

Fig. 6. Example of a reordering scheme of  $v$  using level-order traversal. Starting from the root, for each level, we relabel the immediately descending leaf nodes with the smallest integers available (from 0 to  $n - 1$ ; shown in orange). The letters (a-g) indicate the taxa, showing that reordering the leaves does not affect tree topology but simply changes the integer-taxon mapping.

removing the asymmetric effects of the initial labelling.

*Branch lengths* In addition to tree topology, determining the branch lengths of a tree is an important facet in phylogenetic inference. When making small changes to the tree topology, a number of portions of the tree will remain identical and, therefore, it is likely that the optimal values of subtree branch lengths will not change. It is therefore helpful to represent branch lengths in a method that is robust to these changes to avoid carrying out the full optimisation process every time the topology is changed.

Within the Phylo2Vec framework, there are several approaches in which branch lengths can be integrated. First, given each  $v_j$  refers to the branch splitting and leading to leaf  $j$ , a simple solution would consist in adding a second vector specifying the length of this new branch. Alternatively, it is possible to assign each leaf node a “position”, calculate internal node positions as some weighted average of the positions of the nearby leaf nodes, and then calculate branch lengths based on the distance between a pair of nodes. This would have the advantage of branch lengths being independent of the choice of root, allowing the algorithm to more easily switch between the unrooted equivalence classes discussed previously.

For the examples in this paper, we used RAxML-NG (Kozlov et al., 2019) to optimise the branch lengths at each step of the algorithm without using information from previous branch lengths. This reduces the speed of the optimisation and is an area for improvement in future work.

### Evaluation

*Problem and data* To demonstrate the utility of Phylo2Vec, we apply our new representation for phylogenetic inference of five popular empirical molecular sequence datasets under the maximum likelihood (ML) criterion. This dataset corpus spans across different biological entities, taxa, and genetic sequence sizes.

Table 1. Evaluation datasets, sorted by number of taxa.

Name	Reference	Type	# taxa	# bases
Yeast	<a href="#">Rokas et al. (2003)</a> ; <a href="#">Schliep (2011)</a>	Fungi	8	127,018
H3N2	<a href="#">Sagulenko et al. (2018)</a>	Virus	19	1,407
M501	<a href="#">Garey et al. (1996)</a>	Animal	29	2,520
FluA	<a href="#">Fourment and Darling (2019)</a>	Virus	69	987
Zika	<a href="#">Sagulenko et al. (2018)</a>	Virus	86	10,807

It has been proved that ML inference for phylogenetic trees is NP-hard (Roch, 2006) and therefore our key goal is to define a sensible heuristic that can explore the vastness of tree space. Moreover, the likelihood surface exhibits high curvature (Sanderson et al., 2011) and being trapped in a local optima is a persistent problem across all heuristic phylogenetic approaches.

*Tree topology optimisation using hill-climbing* A simple way to explore the space of possible trees is to use hill climbing where we simply compute the difference in likelihood after a single element is changed. We define the neighbour matrix

$$\Delta\ell(\mathbf{v})_{ij} = \ell((v_1, \dots, v_{i-1}, j, v_{i+1}, \dots, v_{n-1})) - \ell(\mathbf{v}), \quad (4)$$

that is, the tree considered in the first likelihood has identical entries except for the  $i^{\text{th}}$  entry, which is changed to  $j$ . For  $(i, j)$  such that  $v_i = j$  is infeasible, we set  $\Delta\ell_{ij} = 0$ . We have found that considering each row of the neighbour matrix yields good results, i.e., if  $\max(\Delta\ell_i) > 0$ , then we find  $j = \operatorname{argmax}_j(\Delta\ell_{ij})$  and change the value of  $v_i$  to  $j$ . This algorithm is guaranteed to converge to a point where  $\max(\Delta\ell) \leq 0$  as no change in  $\mathbf{v}$  results in a gradient that is greater than zero. Moreover, as there are only finitely many possible  $\mathbf{v}$ , and  $\ell$  is strictly decreasing after each iteration of the while loop, the algorithm must converge in finite time. More complicated optimisation algorithms can be readily created and is an especially useful aspect of our representation. An example is performing hill-climbing over paired changes in  $\mathbf{v}$ . Exploratory analysis suggests that paired changes are far more robust to being trapped in local minima, but at the cost of higher complexity. For challenging phylogenies, a simpler parsimony or minimum evolution score can be used to perform hill-climbing over pairs as an exploratory search.

However, as highlighted above, a fundamental asymmetry exists in Phylo2Vec which can make optimisation inefficient. A simple solution to mitigating this asymmetry is to reorder the integer-taxon mapping to obtain an ordered vector (and thus, an ordered tree), as described previously in [An incomplete integer representation of trees as birth processes](#) and Figure 6. The advantage of carrying out our hill climbing scheme on these ordered trees is that it removes the secondary effects of changing an element of  $\mathbf{v}$  which can occur by the processing order dramatically shifting. That is, if only the value of  $v_i$  is changed, the nodes in  $\{1, \dots, n-1\} \setminus \{i\}$  will still be processed in reverse order. This prevents our algorithm from getting stuck in local minima, as it means that more parts of the tree can be easily edited.

The resulting algorithm is detailed in Algorithm 1. Our investigations have shown that all the possible trees that are one step from some ordered  $\mathbf{v}$  are also one SPR move from the original

tree (though the converse is not true - not all SPR moves will be one step from  $v$ ). This is proved in the Appendix ([Phylo2Vec details](#)). Thus, this application of our Phylo2Vec formulation falls within the SPR framework, and provides a mathematically convenient and principled way to explore tree space using well-tested SPR methodology.

We note that we could additionally explore rooted equivalence classes to further prevent being stuck in local minima. In particular, there is more freedom in the movements of nodes further down the tree, and re-rooting at the deepest node would allow all nodes to be easily moved to a variety of locations. However, for the experiments presented hereafter, we found this extra degree of freedom to be unnecessary.

---

**Algorithm 1** Hill-climbing optimisation of a tree with  $n$  leaves

---

<b>Input</b> $v \in \mathcal{T}_n$	▷ Initialise with a random $v$
$\ell_{\text{best}} \leftarrow \ell(v)$	▷ Initial best likelihood value
<b>repeat</b>	
Reorder( $v$ )	▷ Reorder the labels (see Figure 6)
Sample $i \in \{1, \dots, n - 1\}$	▷ Sample an index of $v$
$G_i \leftarrow \Delta \ell(v)_{ij}$	▷ $G_{ij}$ = likelihood difference from changing $v_i$ to $j$
$j \leftarrow \operatorname{argmax}(G_i)$	▷ Find the best change
$v_i \rightarrow j$	▷ Change $v_i$
$\ell_{\text{best}} \leftarrow \ell(v)$	
<b>until</b> $\max(G_{i=1, \dots, n-1}) = 0$	▷ Continue iterating until local minimum

---

### *Implementation*

Phylo2Vec algorithms, and related optimisation methods presented in the main text were implemented in Python 3.10 using NumPy ([Harris et al., 2020](#)) and numba ([Harris et al., 2020](#)). Tree manipulation scripts were written using ete3 ([Huerta-Cepas et al., 2016](#)). Dataset construction was based on phangorn ([Schliep, 2011](#)) in R and TreeTime ([Sagulenko et al., 2018](#)) in Python. Maximum likelihood estimation was performed using RAxML-NG ([Kozlov](#)

et al., 2019). An implementation is available at: <https://github.com/Neclow/phylo2vec>.

Benchmarking was executed using Python’s `timeit` on a machine equipped with a 64-core CPU @ 7 GHz, with 256 GB of RAM.

## RESULTS

We test Phylo2Vec by performing inference on five popular empirical datasets described in Table 1. This dataset corpus spans across different biological entities, taxa, and genetic sequence sizes.

For each dataset, we use the optimisation procedure described in [Evaluation](#), using RAxML-NG for branch length and substitution matrix optimisation. We report performance using the negative log version of the tree likelihood defined by [Felsenstein \(1983\)](#).

Figure 7 shows the optimisation results for four of the datasets described in Table 1. We observe that from 10 random starting trees, we always achieve the same minimal loss without being trapped in local optima. This is comparable to state-of-the-art software that also searches topological space ([Stamatakis, 2014](#); [Minh et al., 2020](#)). For each dataset, only two epochs of changes were generally needed to achieve a minimal negative log-likelihood. In addition, for M501 for example, only a total of around 10,000 likelihood optimisations for each run were needed to reach a minimum - a vanishingly small fraction of the total number of trees possible with 29 taxa ( $\sim 8e^{36}$ ). The choice of the number of optimisations can be shortened depending on the optimisation stoppage criteria, but with the trade-off of being trapped in local minima. We also note that in the Zika virus example, two runs converged at a loss slightly (0.07%) greater than the minimum from the other eight runs. The resultant trees from these minima show that we get trapped in these suboptimal minima due to rooting issues, preventing single changes in  $\nu$  from finding a better optimum. This highlights once again that our algorithm is attempting to solve a more difficult problem than is strictly necessary by searching the space of rooted trees rather than unrooted trees. Due to the pulley principle ([Felsenstein, 2004](#)), all rootings of an unrooted tree have the same negative log-likelihood and therefore no paths between rooted trees exist to aid our



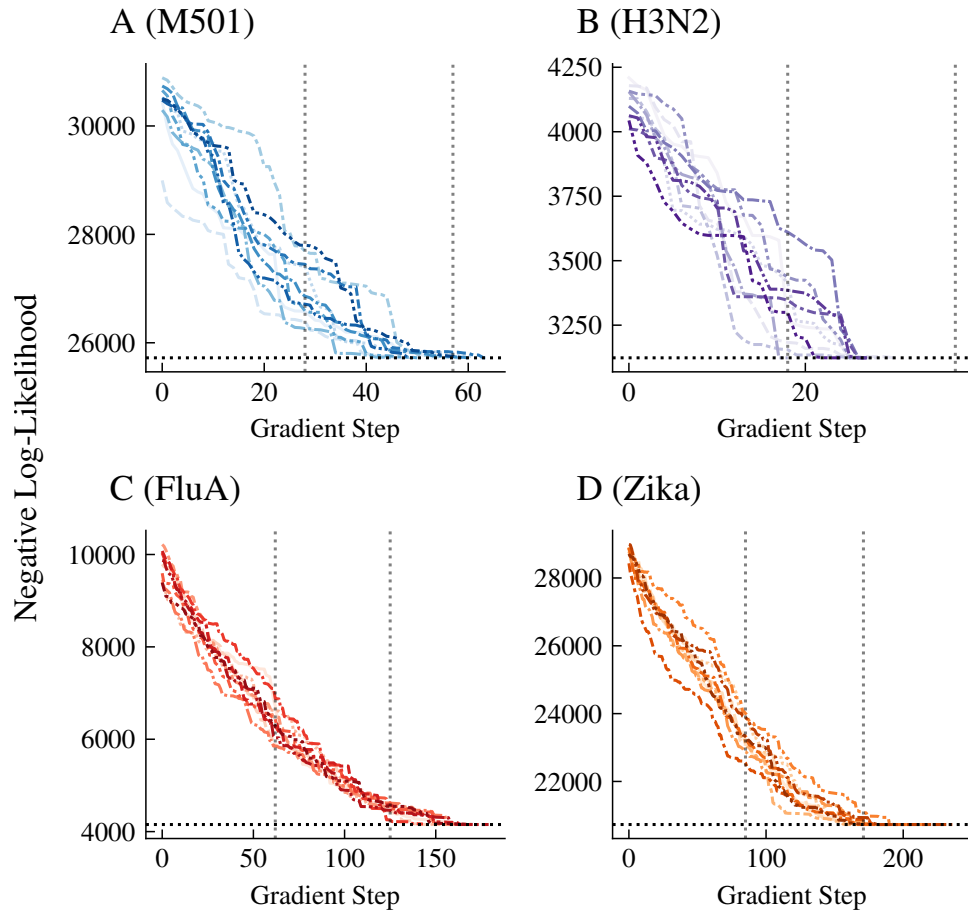

Fig. 7. Phylo2Vec-based likelihood optimisation results for four datasets described in Table 1. The horizontal and vertical lines indicate local minima and epochs (i.e., one pass through every single  $v_i$ ), respectively.

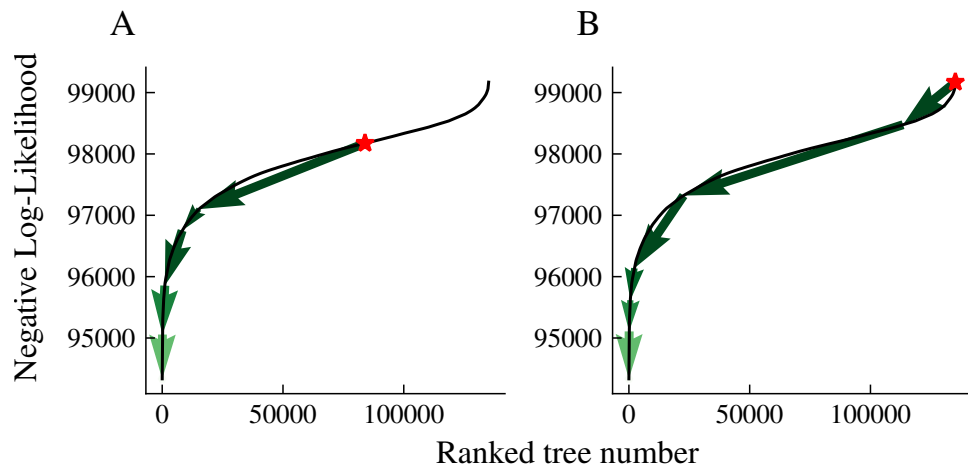

Fig. 8. Negative log-likelihood path drawn from all possible trees of the Yeast dataset. A and B respectively show the path to the minimum from a random tree and the worst possible tree. The black line shows the sorted phylogenetic likelihoods for all trees. The green arrows show the proposal moves for two searches, one from a random tree (A) and one from the worst possible tree (B).

optimisation algorithm. In practice, especially for large phylogenies, it is common to begin optimisation from a sensible starting point (Paradis et al., 2004) (e.g., a maximum parsimony or neighbour joining tree). In our experiments, we have chosen to start from a completely random tree to highlight the utility of simple algorithms based on Phylo2Vec to traverse tree space.

Subsequently, we apply the same optimisation procedure for the yeast dataset (8 taxa) initially presented in (Rokas et al., 2003) and studied in (Money and Whelan, 2012). Given the smaller number of taxa, we were able to exhaustively calculate the likelihood for every possible rooted tree. As shown in Figure 8, we notice a broad region of numerous trees with comparable likelihoods, in addition to a considerably smaller group of trees exhibiting increasing likelihood. Regardless of whether we start from a random tree or the worst possible tree, our algorithm quickly converges to the accurate tree reported in (Rokas et al., 2003). Across several runs, Algorithm 1 required 96 total likelihood evaluations - a very small fraction of the total number of trees.

## DISCUSSION

Phylo2Vec is a parsimonious representation for phylogenetic trees whose validity extends to any binary tree. This representation facilitates the calculation of distances between trees and allows the formation of a simple algorithm for phylogenetic optimisation. Following from trends in phylogenetics, Phylo2Vec should be integrated within state-of-the-art computing libraries (e.g., `libpll` (Flouri et al., 2015) or `Beagle` (Ayres et al., 2012)) to facilitate its use. We have not yet considered Bayesian inference, but this is likely a useful application of Phylo2Vec, where random walks can be trivially implemented (see Figure 5). Although Phylo2Vec does allow for unrooted trees, it is primarily an algorithm for rooted trees. In the examples in this paper, we only consider reversible Markov models where rooting is irrelevant due to the pulley principle (Felsenstein, 2004). Irreversible Markov models are both mathematically and biologically more principled (Sumner et al., 2012) but require rooted trees. Therefore, a useful application of Phylo2Vec could be in the inference of phylogenies with irreversible Markov models.

The use of empirical datasets served as a proof of concept that maximum likelihood estimation can be performed using Phylo2Vec vectors. We show that, using a simple hill-climbing scheme, we can recover the same topology optimum found by state-of-the-art MLE frameworks such as RAxML-NG (Kozlov et al., 2019). It is important to note, however, that this approach is nowhere near as optimised as RAxML-NG. As it only performs topology changes at a single vector index at a time, its inherent greediness makes inference of large datasets difficult.

That being said, the simplicity of the Phylo2Vec formulation means that it can be used in other more efficient and complex optimisation schemes can also be developed. For instance, Phylo2Vec can also benefit from fast SPR changes (Guindon et al., 2010) and other heuristic optimizations that are currently in RAxML(-NG). In addition, by construction, we have ensured that Phylo2Vec can be differentiable through transforming  $v$  into a matrix  $W \in \mathbb{R}^{0,1}$  such that  $W_{ij} = \mathbb{P}(v_i = j)$ . Via this transform, inference in a continuous tree space using gradient descent-based optimisation frameworks is theoretically possible, but its particulars remain to be developed. Similarly, we expect Phylo2Vec-based representations to be applied in Monte Carlo tree search (MCTS) frameworks which may explore tree space more efficiently, or used as an embedding to regularly infer phylogenetic trees using well-established machine learning paradigms such as self-supervised learning from large existing tree libraries (e.g., TreeBase (Piel et al., 2009)).

#### DATA AND CODE AVAILABILITY

All code relevant to reproduce the experiments is available online:

<https://github.com/Neclow/phylo2vec>. Instructions to access the publicly available datasets are included in the `datasets` folder of the repository.

#### AUTHOR CONTRIBUTIONS

S.B, N.S and M.J.P conceived of the study. S.B supervised. S.B, N.S, M.J.P designed the study. S.B, M.J.P and N.S performed optimisation runs. S.B, M.J.P, N.S performed analysis. S.B, M.J.P

and N.S drafted the first original draft. All authors contributed to editing the original draft. N.S and D.A.D contributed to revisions of the methodology. M.J.P, N.S and S.B. drafted the appendix.

#### COMPETING INTERESTS

The authors declare no competing interests.

#### FUNDING

M.J.P acknowledges support from his EPSRC DTP studentship, awarded by the University of Oxford to fund his DPhil in Statistics. S.B. and C.A.D acknowledge support from the MRC Centre for Global Infectious Disease Analysis (MR/R015600/1), jointly funded by the UK Medical Research Council (MRC) and the UK Foreign, Commonwealth & Development Office (FCDO), under the MRC/FCDO Concordat agreement, and also part of the EDCTP2 programme supported by the European Union. SB is funded by the National Institute for Health Research (NIHR) Health Protection Research Unit in Modelling and Health Economics, a partnership between the UK Health Security Agency, Imperial College London and LSHTM (grant code NIHR200908). Disclaimer: "The views expressed are those of the author(s) and not necessarily those of the NIHR, UK Health Security Agency or the Department of Health and Social Care." S.B. acknowledges support from the Novo Nordisk Foundation via The Novo Nordisk Young Investigator Award (NNF20OC0059309). S.B. acknowledges support from the Danish National Research Foundation via a chair grant which also supports N.S. S.B. acknowledges support from The Eric and Wendy Schmidt Fund For Strategic Innovation via the Schmidt Polymath Award (G-22-63345). S.B and N.S acknowledge the Pioneer Centre for AI, DNRF grant number P1 as affiliate researchers. C.A.D receives support from the NIHR HPRU in Emerging and Zoonotic Infections, a partnership between the UK Health Security Agency, University of Liverpool, University of Oxford and Liverpool School of Tropical Medicine (grant code NIHR200907). D.A.D. is funded by a European Research Council Marie Skłodowska-Curie fellowship (H2020-MSCA-IF-2019-883832).

## REFERENCES

- Ayres, D. L., A. Darling, D. J. Zwickl, P. Beerli, M. T. Holder, P. O. Lewis, J. P. Huelsenbeck, F. Ronquist, D. L. Swofford, M. P. Cummings, et al. 2012. BEAGLE: an application programming interface and high-performance computing library for statistical phylogenetics. *Syst. Biol.* 61:170–173.
- Bordewich, M. and C. Semple. 2005. On the computational complexity of the rooted subtree prune and regraft distance. *Ann. Comb.* 8:409–423.
- Cavalli-Sforza, L. L. and A. W. Edwards. 1967. Phylogenetic analysis. models and estimation procedures. *Am. J. Hum. Genet.* 19:233–257.
- De Oliveira Martins, L., D. Mallo, and D. Posada. 2016. A bayesian supertree model for genome-wide species tree reconstruction. *Syst. Biol.* 65:397–416.
- Diaconis, P. W. and S. P. Holmes. 1998. Matchings and phylogenetic trees. *PNAS* 95:14600–14602.
- Faria, N. R., T. A. Mellan, C. Whittaker, I. M. Claro, D. d. S. Candido, S. Mishra, M. A. Crispim, F. C. Sales, I. Hawryluk, J. T. McCrone, et al. 2021. Genomics and epidemiology of the P. 1 SARS-CoV-2 lineage in Manaus, Brazil. *Science* 372:815–821.
- Felsenstein, J. 1978. The number of evolutionary trees. *Syst. Biol.* 27:27–33.
- Felsenstein, J. 1983. Statistical inference of phylogenies. *J R Stat Soc Ser A* 146:246–262.
- Felsenstein, J. 2004. *Inferring phylogenies vol. 2*. Sinauer Associates, Sunderland, MA.
- Flouri, T., F. Izquierdo-Carrasco, D. Darriba, A. J. Aberer, L.-T. Nguyen, B. Minh, A. Von Haeseler, and A. Stamatakis. 2015. The phylogenetic likelihood library. *Syst. Biol.* 64:356–362.
- Fourment, M. and A. E. Darling. 2019. Evaluating probabilistic programming and fast variational bayesian inference in phylogenetics. *PeerJ* 7:e8272.

- Garey, J. R., T. J. Near, M. R. Nonnemacher, and S. A. Nadler. 1996. Molecular evidence for acanthocephala as a subtaxon of rotifera. *J. Mol. Evol.* 43:287–292.
- Guindon, S., J.-F. Dufayard, V. Lefort, M. Anisimova, W. Hordijk, and O. Gascuel. 2010. New algorithms and methods to estimate maximum-likelihood phylogenies: assessing the performance of phylml 3.0. *Systematic biology* 59:307–321.
- Harris, C. R., K. J. Millman, S. J. van der Walt, R. Gommers, P. Virtanen, D. Cournapeau, E. Wieser, J. Taylor, S. Berg, N. J. Smith, R. Kern, M. Picus, S. Hoyer, M. H. van Kerkwijk, M. Brett, A. Haldane, J. F. del Río, M. Wiebe, P. Peterson, P. Gérard-Marchant, K. Sheppard, T. Reddy, W. Weckesser, H. Abbasi, C. Gohlke, and T. E. Oliphant. 2020. Array programming with NumPy. *Nature* 585:357–362.
- Huerta-Cepas, J., F. Serra, and P. Bork. 2016. ETE 3: reconstruction, analysis, and visualization of phylogenomic data. *Mol. Biol. Evol.* 33:1635–1638.
- Kim, J., N. A. Rosenberg, and J. A. Palacios. 2020. Distance metrics for ranked evolutionary trees. *PNAS* 117:28876–28886.
- Knuth, D. 1973. *The Art of Computer Programming vol. 1*. Addison-Wesley, Reading, MA.
- Kozlov, A. M., D. Darriba, T. Flouri, B. Morel, and A. Stamatakis. 2019. Raxml-ng: a fast, scalable and user-friendly tool for maximum likelihood phylogenetic inference. *Bioinformatics* 35:4453–4455.
- Kuhner, M. K. and J. Felsenstein. 1994. A simulation comparison of phylogeny algorithms under equal and unequal evolutionary rates. *Mol. Biol. Evol.* 11:459–468.
- Lam, S. K., A. Pitrou, and S. Seibert. 2015. Numba: A LLVM-based Python JIT compiler. Pages 1–6 *in Proc. LLVM-HPC*.
- Liu, P. 2021. A tree distinguishing polynomial. *Discrete Applied Mathematics* 288:1–8.
- Liu, P., P. Biller, M. Gould, and C. Colijn. 2022. Analyzing phylogenetic trees with a tree lattice coordinate system and a graph polynomial. *Syst. Biol.* 71:1378–1390.

- Minh, B. Q., H. A. Schmidt, O. Chernomor, D. Schrempf, M. D. Woodhams, A. von Haeseler, and R. Lanfear. 2020. IQ-TREE 2: New models and efficient methods for phylogenetic inference in the genomic era. *Mol. Biol. Evol.* 37:1530–1534.
- Money, D. and S. Whelan. 2012. Characterizing the phylogenetic tree-search problem. *Syst. Biol.* 61:228–239.
- Morlon, H., M. D. Potts, and J. B. Plotkin. 2010. Inferring the dynamics of diversification: A coalescent approach. *PLoS Biol.* 8.
- Olsen, G. 1990. Gary Olsen's interpretation of the "Newick's 8: 45" tree format standard. [https://phylipweb.github.io/phylip/newick\\_doc.html](https://phylipweb.github.io/phylip/newick_doc.html).
- Palacios, J. A., A. Bhaskar, F. Disanto, and N. A. Rosenberg. 2022. Enumeration of binary trees compatible with a perfect phylogeny. *Journal of Mathematical Biology* 84:54.
- Paradis, E., J. Claude, and K. Strimmer. 2004. APE: analyses of phylogenetics and evolution in R language. *Bioinformatics* 20:289–290.
- Piel, W. H., L. Chan, M. J. Dominus, J. Ruan, R. A. Vos, and V. Tannen. 2009. TreeBASE v. 2: A Database of Phylogenetic Knowledge. *in e-BioSphere*.
- Proskurowski, A. 1980. On the generation of binary trees. *Journal of the ACM (JACM)* 27:1–2.
- Robinson, D. F. and L. R. Foulds. 1981. Comparison of phylogenetic trees. *Math. Biosci.* 53:131–147.
- Roch, S. 2006. A short proof that phylogenetic tree reconstruction by maximum likelihood is hard. *IEEE/ACM Trans. Comput. Biol. Bioinform.* 3:92–94.
- Rohlf, F. J. 1983. Numbering binary trees with labeled terminal vertices. *Bull. Math. Biol.* 45:33–40.
- Rokas, A., B. L. Williams, N. King, and S. B. Carroll. 2003. Genome-scale approaches to resolving incongruence in molecular phylogenies. *Nature* 425:798–804.

- Rolland, J., M. W. Cadotte, J. Davies, V. Devictor, S. Lavergne, N. Mouquet, S. Pavoine, A. Rodrigues, W. Thuiller, L. Turcati, and et al. 2011. Using phylogenies in conservation: New perspectives. *Biol. Lett.* 8:692-694.
- Rotem, D. and Y. L. Varol. 1978. Generation of binary trees from ballot sequences. *Journal of the ACM (JACM)* 25:396–404.
- Sagulenko, P., V. Puller, and R. A. Neher. 2018. TreeTime: Maximum-likelihood phylodynamic analysis. *Virus Evol.* 4:vex042.
- Sanderson, M. J., M. M. McMahon, and M. Steel. 2011. Terraces in phylogenetic tree space. *Science* 333:448–450.
- Schliep, K. P. 2011. phangorn: phylogenetic analysis in R. *Bioinformatics* 27:592–593.
- St. John, K. 2017. Review paper: The shape of phylogenetic treespace. *Syst. Biol.* 66:e83–e94.
- Stamatakis, A. 2014. RAxML version 8: a tool for phylogenetic analysis and post-analysis of large phylogenies. *Bioinformatics* 30:1312–1313.
- Sumner, J. G., P. D. Jarvis, J. Fernández-Sánchez, B. T. Kaine, M. D. Woodhams, and B. R. Holland. 2012. Is the general time-reversible model bad for molecular phylogenetics? *Syst. Biol.* 61:1069–1074.
- Voznica, J., A. Zhukova, V. Boskova, E. Saulnier, F. Lemoine, M. Moslonka-Lefebvre, and O. Gascuel. 2022. Deep learning from phylogenies to uncover the epidemiological dynamics of outbreaks. *Nat. Commun.* 13:1–14.
- Ypma, R. J., W. M. van Ballegooijen, and J. Wallinga. 2013. Relating phylogenetic trees to transmission trees of infectious disease outbreaks. *Genetics* 195:1055-1062.



## FIGURE CAPTIONS

1. An incomplete integer representation of tree topology as birth processes. **(a)** Labelling a tree as an ordered vector: example for  $v = [0, 0, 0]$ . We process leaves from in ascending order. For each leaf  $j$ , we search its sibling, which corresponds to  $v[j]$ . **(b)** Recovering a tree from an ordered vector: example for  $v = [0, 0, 1]$ . We process  $v$  from left to right. Ancestors are named in last-in-first-out (LIFO) fashion: The ancestor of the last added leaf  $L - 1$  (here, leaf 3) is named  $L$  (here, 4), the ancestor of the second-to-last added leaf  $L - 2$  (here, leaf 2) is named  $L + 1$  (here, 5) etc. In both cases, the lengths of the edges are arbitrary
2. Recovering a tree from an ordered vector: example for  $v = [0, 0, 3]$ . We process  $v$  from left to right. The branch renaming step depends on the branch type. Leaf branches: For leaf branches, branches that end on leaves  $0, \dots, L - 1$  are labelled  $0, \dots, L - 1$ , respectively. For internal branches, the next branch ( $L$ ) to label is **1.** the deepest and **2.** with the highest children (if there are ties for case 1.). We repeat the same process for internal branches  $L + 1, \dots, 2(L - 1) - 1$ , and label the last branch leading to the extra root  $2(L - 1)$ . See Algorithm S5 and Fig. S2a for more details about implementation and complexity
3. Example of trees with  $n = 4$  leaves represented in both Newick and Phylo2Vec vector formats. Leaf and internal nodes are coloured in dark green and lime, respectively
4. Labelling a tree as a Phylo2Vec vector  $v$ : example for  $v = [0, 0, 4]$ . We process leaves from in ascending order. For each leaf  $j$ , we search the branch that split and yielded leaf  $j$ , which corresponds to  $v[j]$ . At each step, we re-label the branches with the same process as in Figure 2
5. Comparison of Phylo2Vec moves with three popular tree distances: subtree-prune-and-regraft (SPR; left), Robinson-Foulds (RF; middle), and Kuhner-Felsenstein (KF; right). To generate the distances, a random walk of 5000 steps was performed from a random initial  $v$  with 200 taxa. At each step, each  $v_i$  can increment,

decrement or remain unchanged

6. Example of a reordering scheme of  $v$  using level-order traversal. Starting from the root, for each level, we relabel the immediately descending leaf nodes with the smallest integers available (from 0 to  $n - 1$ ; shown in orange). The letters (a-g) indicate the taxa, showing that reordering the leaves does not affect tree topology but simply changes the integer-taxon mapping
7. Phylo2Vec-based likelihood optimisation results for four datasets described in Table 1. The horizontal and vertical lines indicate local minima and epochs (i.e., one pass through every single  $v_i$ ), respectively
8. Negative log-likelihood path drawn from all possible trees of the Yeast dataset. A and B respectively show the path to the minimum from a random tree and the worst possible tree. The black line shows the sorted phylogenetic likelihoods for all trees. The green arrows show the proposal moves for two searches, one from a random tree (A) and one from the worst possible tree (B)

## APPENDIX

In this appendix, we present a rigorous mathematical framework summarising the results in this paper. We also detail further algorithms that may be useful in the implementation of Phylo2Vec.

*Notations and definitions*

*Notations* We shall use the notation  $\mathcal{T}$  to refer to a tree,  $\mathbf{b}$  for the branch lengths of  $\mathcal{T}$  and  $n$  as the number of leaves (or taxa).

*Node labels* In a tree with  $n$  leaves, we set the convention that the leaf nodes are labelled from 0 to  $n - 1$ , the internal nodes are labelled from  $n$  to  $2n - 3$  and the root (if it exists) is labelled as  $2n - 2$ .

*Generation* In a tree, there is a unique path connecting each pair of nodes (as otherwise, there would be cycles, which would be a contradiction). Suppose that the path from node  $i$  to the root contains the nodes  $i, a_1, \dots, a_{g_i}$  in that order (and the root is hence  $a_{g_i}$ ). We call  $g_i$  the *generation* of node  $i$ .

The path from any  $a_x$  to the root must be  $a_x, a_{x+1}, \dots, a_{g_i}$  and hence  $g_{a_x} = g_i - x$ .

*Unrooting* Suppose that, in a rooted tree, the two children of the root are  $x$  and  $y$ . To “unroot” the tree, we remove the edges connecting  $x$  and  $y$  to the root and add in a new edge connecting  $x$  and  $y$ . This edge is given length  $b_x + b_y$  where, for example,  $b_x$  is the length of the original edge joining  $x$  to the root. We shall use  $\mathcal{T}'$  to refer to the unrooted tree and  $\mathbf{b}'$  to its branch lengths.

*Phylo2Vec details*

*Vector representation* As described in the main text, Phylo2Vec is a way to represent binary trees with  $n$  leaves using a single integer vector,  $\mathbf{v}$  of dimension  $n - 1$  that is simply

constrained by

$$v[j] \in \{0, 1, \dots, 2(j-1)\} \forall j \in \{1, \dots, n-1\}$$

The construction of the tree from this representation and the bijectivity between  $v$  and the space of trees are covered in the main text.

*Bijection of  $v$  to the space of all possible trees* We can show that our mapping from  $\mathbb{V}$  to the space of trees is a bijection.

**LEMMA A.1** *The mapping between the set of vectors  $v \in \mathbb{V}$  and the set of (topologically equivalent, labelled) trees is a bijection.*

**Proof:** As, by construction, the number of possible vectors  $v$  and the number of trees are the same  $((2n-3)!!)$ , it is simply necessary to show that this mapping is injective.

For any two nodes,  $a$  and  $b$  we define  $M(a, b)$  to be their most recent common ancestor (MRCA). Moreover, for any nodes  $a$  and  $b$ , we use the notation  $a \prec b$  if  $a$  is an ancestor of  $b$ .

We can use the fact that the MRCA of any pair of leaf nodes in the tree is unchanged during the Phylo2Vec construction process (once both nodes have been added to the tree). Note that the path from a node  $x$  to the root changes through the addition of an extra node if and only if a new node is appended to an edge on this path. Thus,  $M(a, b) = x$ ,  $x$  will remain on the paths from  $a$  and  $b$  to the root. Moreover, nodes of higher generation than  $x$  can only be added to one of the paths (as otherwise there would have to be an edge connecting at least one node of higher generation than  $x$  on both the original paths, contradicting  $x$  being the MRCA). Thus, the MRCA of  $a$  and  $b$  will be unchanged. Similarly, we can see that  $c \prec d$  for two nodes  $c$  and  $d$ , this relationship will be unchanged throughout the construction process.

Suppose that two vectors  $v$  and  $v'$  result in trees  $\mathcal{T}$  and  $\mathcal{T}'$ , and that  $v \neq v'$ . Define  $\mathcal{I} := \{i : v_i \neq v'_i\}$ , and suppose that the tree construction algorithm is run up to the first point where a node  $i \in \mathcal{I}$  is processed in one of the two cases (so that, up to this point, the two trees are identical). Without loss of generality, suppose that it is processed in the case of  $v$ , but not

necessarily  $v'$ .

Define  $X$  to be the set of leaf nodes that, just before node  $i$  is added, are descended from the edge to which node  $i$  is appended when constructing the tree according to  $v$ , and  $X'$  to be the equivalent set for  $v'$ . We have  $X \neq X'$ , as each edge has a unique set of nodes descended from it.

If both  $X/X'$  and  $X'/X$  are non-empty, suppose that  $a \in X/X'$  and  $b \in X'/X$ . Then, in  $\mathcal{T}$ , it must be the case that  $M(b, i) \prec M(a, i)$  once node  $i$  has been added (as the  $M(a, i)$  will be the new internal node and  $M(i, b)$  cannot be either  $i$  or this new internal node). A similar argument shows that  $M(a, i) \prec M(b, i)$  in  $\mathcal{T}$  and hence  $\mathcal{T} \neq \mathcal{T}'$ .

If only one of  $X/X'$  and  $X'/X$  is non-empty, suppose without loss of generality that  $X/X'$  is non-empty and choose  $a \in X/X'$ . Necessarily,  $|X'| \geq 1$  and so  $|X| > 2$  so we can choose a distinct node  $b \in X' \cap X$ . Then,  $M(i, a)$  is the newly-added internal node in the construction of  $\mathcal{T}$ , but not in the construction of  $\mathcal{T}'$ . However, in both cases,  $M(i, b)$  is the newly-added node. Hence, in  $\mathcal{T}$ ,  $M(i, a) = M(i, b)$ , but in  $\mathcal{T}'$ , they are distinct. Thus,  $\mathcal{T}' \neq \mathcal{T}$ .

Hence, topological non-equivalence holds in both cases, and the map from  $v$  to the set of trees is therefore injective and therefore bijective.

*Label-asymmetry of  $v$ -induced distance* As discussed in the main text,  $v$  induces a natural distance function between trees - namely, that the distance between  $v$  and  $w$  is equal to  $\sum_{i=0}^k \mathbb{I}_{v_i \neq w_i}$ .

However, this distance function is dependent on the labels assigned to each leaf (and is hence label-asymmetric). A simple example of this can be found in the case of four leaves.

Consider the tree given by  $v_1 = (0, 1, 2)$ . This is a ladder tree (that is, each internal node and the root is parent to at least one leaf node) with nodes in order  $0, 1, \{2, 3\}$  (where the  $\{2, 3\}$  is used to denote the fact that nodes 2 and 3 are from the same generation and so could be read in either order). This is distance 1 away from  $v_2 = (0, 1, 4)$ , which is again a ladder tree with nodes now ordered as  $3, 0, \{1, 2\}$ . Thus, if distance were symmetric, then any ladder tree with ordered nodes  $a, b, \{c, d\}$  would be distance 1 away from the ladder trees with ordered nodes  $d, a, \{b, c\}$  and  $c, a, \{b, d\}$ . However, the ladder tree with ordered nodes  $2, 0, \{1, 3\}$  is given by  $v_3 = (0, 2, 1)$ ,

which is distance 2 away from  $v_1$ . Thus, the distance function is not label-symmetric.

*Unrooted tree equivalence classes* Noting from the main text that there are  $(2k - 3)!! = \prod_{i=0}^{k-2} (2i + 1)$  unrooted trees with  $k + 1$  leaves, we can partition the space of trees with  $k + 1$  leaves into  $(2k - 3)!!$  equivalence classes  $\{\mathcal{E}_i : i = 1, 2, \dots, (2k - 3)!!\}$  such that the removing the root from each of the trees in a given class  $\mathcal{E}_i$  (according to the procedure described in [Notations and definitions](#) in the Appendix) results in the same unrooted tree. These equivalence classes all contain  $(2k - 1)$  trees (as, reversing the unrooting procedure, a root can be added onto each of the  $(2k - 1)$  edges of an unrooted tree).

From the previous work, Felsenstein's likelihood is constant in each equivalence class. This has two consequences when attempting to maximise the likelihood. Firstly, a global minimum in the space of rooted trees will not be unique, as any of the other trees in the same equivalence class will also give a maximal likelihood. Secondly, if  $v$  is a local maximum (that is, all  $w$  with one entry different to  $v$  give a lower likelihood value), equivalence classes provide a way to change to a new vector  $u$  without having to decrease the likelihood.

Similarly to the case of reordering, the set of equivalence classes of vectors that are distance 1 from  $v$  will not in general be the same as the set with distance 1 from  $u$ . One can either change equivalence class randomly or (unlike in the case of reordering), as there are only  $2k - 1$  members of each class, systematically iterate through them. Finding the vectors  $w$  corresponding to the trees in an equivalence class can again be done by constructing the tree matrix  $M$ , making the appropriate changes and then using the inversion algorithm to create a new vector representation

Our experiments have shown that changing  $v$  is effective in increasing algorithmic performance. However, we found that reordering provided somewhat better increase in performance, and therefore did not present this other switching method in the algorithm in the main text.

*Number of moves* Let a vector  $v$  of length  $n - 1$  representing a tree with  $n$  leaves. For each entry  $j$ , there are  $2j - 1 - 1 = 2(j - 1)$  possible moves, as there are  $2j - 1$  possible entries for entry  $j$ , but  $v[j]$  is already set). Summing for all  $j \in 1, \dots, n - 1$  gives:

$$\sum_{j=1}^{n-1} 2(j - 1) = (n - 1)(n - 2) \approx n^2$$

Thus, the number of possible moves for Phylo2Vec is of the order  $\mathcal{O}(n^2)$ .

*Algorithms*

The algorithms provided here are presented in rough descriptive pseudocode; they are written in human-readable fashion to facilitate comprehension, but are not necessarily optimised. Please refer to the GitHub repository (<https://github.com/Neclow/phylo2vec>) for detailed implementation.

---

**Algorithm S1** Labelling a rooted tree as an ordered  $\mathbf{v}$ 

---

**Input** rooted tree  $\mathcal{T}$  with  $n$  leaves

$\mathbf{v} \leftarrow [0]$  ▷ Initial integer vector

**for all** leaves  $j = 2, \dots, n - 1$  **do**

$\mathcal{T}_j \leftarrow$  subtree with leaves  $0, \dots, j$

$s \leftarrow$  leaf in  $\mathcal{T}_j$  such that  $j$  and  $s$  form a cherry

$\mathbf{v}.\text{append}(s)$

**end for**

**return**  $\mathbf{v}$

---



---

**Algorithm S2** Recovering an ordered rooted tree from an ordered  $\mathbf{v}$ 

---

**Input**  $\mathbf{v}$  of size  $n - 1$  satisfying Eq. 1 ▷ Ordered integer vector

$\mathcal{T} \leftarrow$  a rooted tree with two leaves 0 and 1 ▷ Initial tree

**for all**  $j = 2, \dots, n - 1$  **do**

Add a new leaf  $j$  to  $\mathcal{T}$  such that it forms a cherry with  $\mathbf{v}[j]$

$a(j, \mathbf{v}[j]) \leftarrow 2(n - 1) - j + 1$  ▷ Ancestor of  $j$  and  $\mathbf{v}[j]$

**end for**

**return**  $\mathcal{T}$

---



---

**Algorithm S3** Recovering a rooted tree from a Phylo2Vec  $v$ 

---

**Input**  $v$  of dimension  $n - 1$  satisfying Eq. 2 ▷ Phylo2Vec vector

pairs  $\leftarrow [(0, 1)]$  ▷ The objective of the algorithm is find the nodes to merge and their order. The first pair is always (0,1) for a 2-leaf tree.

**for all** leaves  $j = 2, \dots, n - 1$  **do**

**if**  $v[j] \leq j$  **then** ▷ This is like an ordered vector. The branch leading to  $v[j]$  gives birth birth to leaf  $j$

next pair  $\leftarrow (v[j], j)$

position  $\leftarrow 1$  ▷ This pair corresponds to a cherry at height 0, so it should be drawn first.

**else** ▷ The branch to be split is internal

position  $\leftarrow v[j] - \text{len}(\text{pairs}) + 1$  ▷ The index at which the next pair will be inserted

descendant  $\leftarrow \text{pairs}[\text{position} - 1][1]$  ▷ A node that we processed beforehand that is deeper than the branch  $v[j]$

next pair  $\leftarrow (\text{pairs}[\text{descendant}, j])$

**end if**

pairs.insert(position, next pair)

**end for**

**return** pairs ▷ The pairs indicate how to build the tree (and form a Newick string)

---

---

**Algorithm S4** Labelling a rooted tree as a Phylo2Vec vector
 

---

**Input** rooted tree  $r$  with  $n$  leaves     $\triangleright$  We assume a Newick string with integer nodes and labelled internal nodes.  
 Ex: (((2,3)6,1)7,(0,4)5)8;

$M \leftarrow \text{reduce}(r)$      $\triangleright$  "Reduce" the Newick string to a  $(n - 1) \times 3$  matrix.  
 Columns 1-2 = children nodes  
 Column 3 = ancestor  
 Ex:  $\begin{matrix} 0 & 4 & 5 \\ 2 & 3 & 6 \\ 1 & 6 & 7 \\ 5 & 7 & 8 \end{matrix}$

$C \leftarrow \text{extract\_cherries}(M)$      $\triangleright$  Starting from the smallest internal node, replace the internal nodes by their smallest child (and discard the third column). This is equivalent to the pairs in Algorithm S3  
 Ex:  $\begin{matrix} 0 & 4 \\ 2 & 3 \\ 1 & 2 \\ 0 & 1 \end{matrix}$

$v \leftarrow \text{build\_vector}(C)$      $\triangleright$  Use the same logic as Algorithm S3 to retrieve each  $v_j$  from the position of the containing leaf  $j$

**return**  $v$

---



---

**Algorithm S5** Labelling edges in the Phylo2Vec framework
 

---

**Input** rooted tree  $\mathcal{T}$  with  $n$  leaves     $\triangleright$  Leaves labelled  $1, \dots, n - 1$

$e \leftarrow []$      $\triangleright$  Edges

**for all** leaves  $j = 1, \dots, n - 1$  **do**

$e(j, a(j)) \leftarrow j$      $\triangleright$  The edge from which leaf  $j$  descends from is labelled  $j$

**end for**

$j \leftarrow n$      $\triangleright$  The label of the next edge

**for all** heights  $h = 1, \dots, n - 1$  **do**     $\triangleright$  height = number of edges on the path from a given node to the furthest leaf node

$a_j \leftarrow$  ancestor of height  $h$  with the greatest child

$e(a_j, a(a_j)) \leftarrow j$      $\triangleright$  The edge connecting  $a_j$  and its ancestor is labelled  $j$

$j \leftarrow j + 1$      $\triangleright$  Increment  $j$

**end for**

**return**  $e$

---

## Supplementary Figures

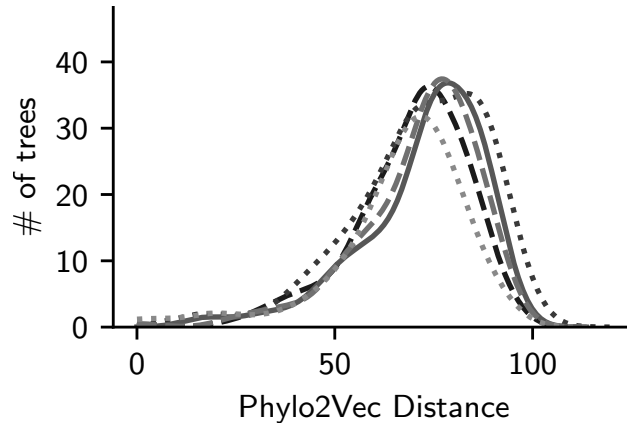

Fig. S1. Density plots of Phylo2Vec distance  $\mu$  for an equivalence set of rooted trees with 200 taxa with a fixed Phylo2Vec vector  $v$ . 5 random  $v$  are shown.

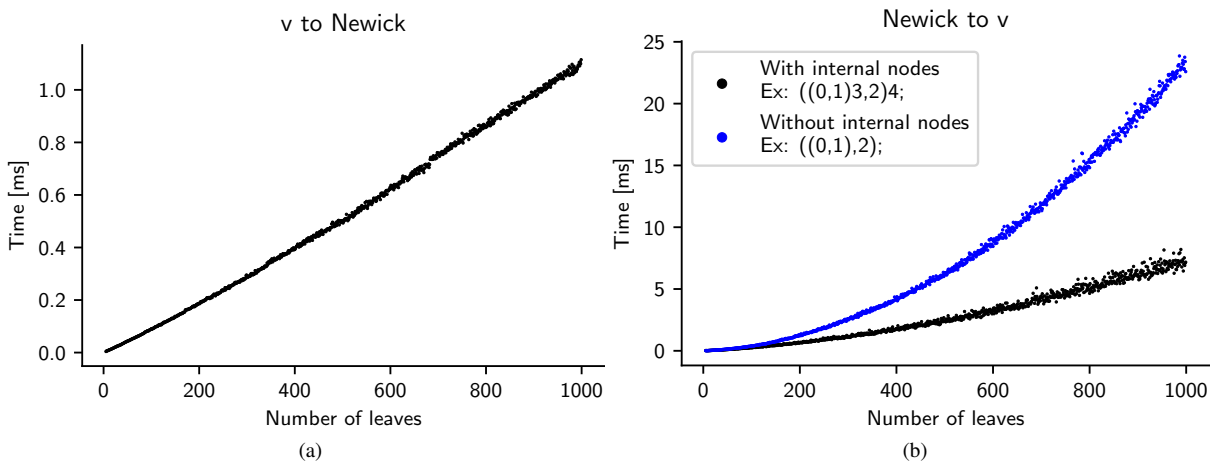

Fig. S2. Execution times for different tree sizes of (a) Algorithm S3 ( $\mathcal{O}(n)$ ) to recover a rooted tree from a Phylo2Vec  $v$  and (b) Algorithm S4 (with internal nodes:  $\mathcal{O}(n \log n)$ ; without internal nodes:  $\mathcal{O}(n^2)$ ) to label a rooted tree as a Phylo2Vec  $v$ . For each size, we evaluated the execution time with a fixed configuration of 100 executions in a loop and 7 repeats using `timeit` in Python. When the number of taxa is large, manipulations on long strings to produce or process the Newick string can increase memory and thus increase execution time.