

BOUNDED LITTLEWOOD IDENTITIES FOR CYLINDRIC SCHUR FUNCTIONS

JISUN HUH, JANG SOO KIM, CHRISTIAN KRATTENTHALER, AND SOICHI OKADA

ABSTRACT. The identities which are in the literature often called “bounded Littlewood identities” are determinantal formulas for the sum of Schur functions indexed by partitions with bounded height. They have interesting combinatorial consequences such as connections between standard Young tableaux of bounded height, lattice walks in a Weyl chamber, and noncrossing matchings. In this paper we prove affine analogs of the bounded Littlewood identities. These are determinantal formulas for sums of cylindric Schur functions. We also study combinatorial aspects of these identities. As a consequence we obtain an unexpected connection between cylindric standard Young tableaux and r -noncrossing and s -nonnesting matchings.

1. INTRODUCTION

Schur functions $s_\lambda(\mathbf{x})$, where λ is a partition and $\mathbf{x} = \{x_1, x_2, \dots\}$ is a set of variables, are an extensively studied class of symmetric functions which play an important role in many areas of mathematics including geometry, representation theory and combinatorics. (We refer the reader to [27] or [35, Ch. 7], respectively to Subsection 2.2 for background on symmetric functions.) They form a basis of the space of symmetric functions, and the Jacobi–Trudi formulas

$$(1.1) \quad s_\lambda(\mathbf{x}) = \det(h_{\lambda_i - i + j}(\mathbf{x})), \quad s_{\lambda'}(\mathbf{x}) = \det(e_{\lambda_i - i + j}(\mathbf{x}))$$

give a way to express Schur functions in terms of complete homogeneous symmetric functions $h_k(\mathbf{x})$ and elementary symmetric functions $e_k(\mathbf{x})$, where λ' denotes the conjugate of the partition λ .

It is well known [35, Cor. 7.13.8] that the sum of all Schur functions has a simple product formula, namely

$$\sum_{\lambda} s_\lambda(\mathbf{x}) = \frac{1}{\prod_i (1 - x_i) \prod_{i < j} (1 - x_i x_j)}.$$

This identity can be found in Littlewood’s book [26, p. 238], together with other identities of similar kind, where the summation index λ is subject to certain restrictions. Altogether, these identities are commonly called “Littlewood identities”. The above identity however was stated earlier in an equivalent form by Schur [34, p. 456].

The term “bounded Littlewood identity” is used for summation identities in which the number of parts of the summation index λ (a partition), or the first part of λ , is bounded from above by a fixed positive integer. Motivated by enumeration problems for plane partitions and tableaux, such identities were found in the 1970s and 1980s. We state two prototypical “bounded Littlewood identities” in the theorem below. It is difficult to give a precise attribution. In the form below, they have been first stated by Stembridge [36, Th. 7.1] (modulo the symmetric function involution interchanging complete homogeneous and elementary symmetric functions). However, due to known properties of symplectic and orthogonal characters, they appear in an equivalent form in Macdonald’s book [27, Ch. I, Sec. 5, Ex. 16]. To make the situation even more confusing, Stembridge makes it clear that all the ingredients to prove the identities are already contained in

2020 *Mathematics Subject Classification.* Primary 05E05; Secondary 05A15, 05A19.

Key words and phrases. Cylindric tableau, vacillating tableau, oscillating tableau, Schur function, set partition, matching, lattice walk, nonintersecting lattice paths.

determinantal-Pfaffian formulas due to Gordon and Houten, namely [15, Lemma 1] and [14, Lemma 1]. We may restate [36, Th. 7.1] as follows.

Theorem 1.1 (TWO BOUNDED LITTLEWOOD IDENTITIES). *For a nonnegative integer h , we have*

$$(1.2) \quad \sum_{\lambda: \ell(\lambda) \leq 2h+1} s_{\lambda'}(\mathbf{x}) = \sum_{k \geq 0} e_k(\mathbf{x}) \det_{1 \leq i, j \leq h} (f_{-i+j}(\mathbf{x}) - f_{i+j}(\mathbf{x}))$$

and

$$(1.3) \quad \sum_{\lambda: \ell(\lambda) \leq 2h} s_{\lambda'}(\mathbf{x}) = \det_{1 \leq i, j \leq h} (f_{-i+j}(\mathbf{x}) + f_{i+j-1}(\mathbf{x})),$$

where

$$(1.4) \quad f_r(\mathbf{x}) = \sum_{n \in \mathbb{Z}} e_n(\mathbf{x}) e_{n+r}(\mathbf{x}).$$

We remark that the right-hand sides of (1.2) and (1.3) are (essentially) irreducible characters indexed by a rectangular shape of the odd orthogonal group $\mathrm{SO}_{2n+1}(\mathbb{C})$ (cf. [36, Cor. 7.4(a)]). More bounded Littlewood identities can be found in [21, Th. 2] and [31, Th. 2.3] (to some of which we will come back in Section 3).

The first main result of our paper is an affine analog of Theorem 1.1 (see Theorem 3.1 for a more compact statement).

Theorem 1.2 (TWO AFFINE BOUNDED LITTLEWOOD IDENTITIES). *For positive integers h and w , we have*

$$(1.5) \quad \sum_{\substack{\lambda: \ell(\lambda) \leq 2h+1 \\ \lambda_1 - \lambda_{2h+1} \leq w}} \sum_{\substack{k_1, \dots, k_{2h+1} \in \mathbb{Z} \\ k_1 + \dots + k_{2h+1} = 0}} \det_{1 \leq i, j \leq 2h+1} (e_{\lambda_i - i + j + (2h+w+1)k_i}(\mathbf{x})) \\ = \sum_{k \geq 0} e_k(\mathbf{x}) \sum_{k_1, \dots, k_h \in \mathbb{Z}} \det_{1 \leq i, j \leq h} (f_{-i+j+(2h+w+1)k_i}(\mathbf{x}) - f_{i+j+(2h+w+1)k_i}(\mathbf{x}))$$

and

$$(1.6) \quad \sum_{\substack{\lambda: \ell(\lambda) \leq 2h \\ \lambda_1 - \lambda_{2h} \leq w}} \sum_{\substack{k_1, \dots, k_{2h} \in \mathbb{Z} \\ k_1 + \dots + k_{2h} = 0}} \det_{1 \leq i, j \leq 2h} (e_{\lambda_i - i + j + (2h+w)k_i}(\mathbf{x})) \\ = \sum_{k_1, \dots, k_h \in \mathbb{Z}} (-1)^{\sum_{i=1}^h k_i} \det_{1 \leq i, j \leq h} (f_{-i+j+(2h+w)k_i}(\mathbf{x}) + f_{i+j-1+(2h+w)k_i}(\mathbf{x})),$$

with $f_r(\mathbf{x})$ being defined in (1.4).

We explain the meaning of ‘‘affine’’ in this context in Remark 3.2(3). More affine bounded Littlewood identities are presented in Section 3; see Theorems 3.3 and 3.4.

It is obvious that, in the limit $w \rightarrow \infty$, the identities (1.5) and (1.6) reduce to (1.2) and (1.3), respectively. Nevertheless, the reader may wonder whether the identities in Theorem 1.2 would have any significance beyond being extensions of the bounded Littlewood identities in Theorem 1.1. Towards an answer to this question, we first point out that the summand depending on λ on the left-hand sides of (1.5) and (1.6),

$$(1.7) \quad \sum_{\substack{k_1, \dots, k_h \in \mathbb{Z} \\ k_1 + \dots + k_h = 0}} \det_{1 \leq i, j \leq h} (e_{\lambda_i - i + j + (h+w)k_i}(\mathbf{x})),$$

is a ‘‘cylindric’’ analog of the Schur function $s_{\lambda'}(\mathbf{x})$. Namely, as the Schur function $s_{\lambda'}(\mathbf{x})$ is equal to a generating function for semistandard Young tableaux of shape λ' (see (2.1)), by a result of Gessel and the third author [10], the expression in (1.7) is equal to a generating function for semistandard Young tableaux of

shape λ' that satisfy a “cylindric” constraint. We call these tableaux *cylindric semistandard Young tableaux*; see Proposition 2.6 and Theorem 2.8 in Subsection 2.2. In fact, the *cylindric Schur functions* — as we shall call the expressions in (1.7) — appeared for the first time explicitly in a geometric context in [32, Sec. 6]. For further occurrences of cylindric semistandard Young tableaux and (skew) cylindric Schur functions see [1, 24, 28].

Returning to the question of the significance of the affine bounded Littlewood identities (1.5) and (1.6): as we already mentioned, the origin of the bounded Littlewood identities in Theorem 1.1 lies in the enumeration of plane partitions and tableaux. Via the Robinson–Schensted algorithm and variations thereof, tableaux are related to other combinatorial objects, such as permutations, set partitions, and involutions, where the latter may also be regarded as (partial) matchings; see [3, 22]. Hence, the identities (1.5) and (1.6) have more combinatorial applications. One particularly interesting implication of (1.2) (which may be derived by extracting coefficients of $x_1 x_2 \cdots x_n$ on both sides of (1.2) and combining the result with Gessel and Zeilberger’s random-walks-in-Weyl-chambers formula [12] and Chen et al.’s bijection in [3] between vacillating tableaux and matchings) is¹

$$(1.8) \quad |\text{SYT}_n(2h+1)| = |\text{NC}_n(h+1)|,$$

where $\text{SYT}_n(2h+1)$ denotes the set of standard Young tableaux of size n with at most $2h+1$ rows, and $\text{NC}_n(h+1)$ is the set of (partial) matchings on $\{1, 2, \dots, n\}$ without an $(h+1)$ -crossing; see Subsection 2.1 for the definition of standard Young tableaux, and Definition 8.3 for the definition of crossings. Similarly, the affine bounded Littlewood identities in Theorem 1.2 are related to several combinatorial objects, among which cylindric semistandard Young tableaux, walks in type A alcoves, and (partial) matchings with restrictions on their crossings *and* their nestings. Consequently they have as well combinatorial applications. One particular implication is

$$(1.9) \quad |\text{CSYT}_n(2h+1, 2w+1)| = |\text{NCNN}_n(h+1, w+1)|,$$

where $\text{CSYT}_n(2h+1, 2w+1)$ denotes the set of $(2h+1, 2w+1)$ -cylindric standard Young tableaux of size n , and $\text{NCNN}_n(h+1, w+1)$ denotes the set of (partial) matchings on $\{1, 2, \dots, n\}$ without an $(h+1)$ -crossing and without a $(w+1)$ -nesting; see Subsection 2.1 for the definition of cylindric standard Young tableaux, Definition 8.3 for the definition of crossings and nestings, and Equation (8.10) in Corollary 8.9 for the result.

As a matter of fact, the equality (1.9) stood at the beginning of our investigations that in the long run led to (1.5) and the other results reported in this article. More precisely, our original (relatively modest) motivation was to find a bijective proof of a seemingly unrelated result of Mortimer and Prellberg [29] on lattice walks in a triangular region and bounded Motzkin paths. We discovered (1.9) — *experimentally* — as a generalization of their result. How this — at the time — conjecture, more or less “inevitably”, guided us to discover (1.5) and (1.6) is explained in Appendix A.

Our paper is organized as follows. In Section 2 we give basic definitions and some preliminaries on tableaux and symmetric functions. In Section 3 we present our affine bounded Littlewood identities. These include (1.5) and (1.6) in more compact notation; see Theorem 3.1. The section contains moreover also affine analogs of the known bounded Littlewood identity in which the sum of Schur functions is restricted to partitions all of whose parts (row lengths) are even (see [36, Cor. 7.2]), and another in which the sum is over partitions all of whose column lengths are even *or* all of them are odd (see [31, Th. 2.3(3)]). Our corresponding results are presented in Theorems 3.3 and 3.4. We prove (1.5) and (1.6) in Section 5, following the “recipe” in [36, Proof of Th. 7.1], essentially due to Gordon and Houten. In Section 6 we introduce a systematic approach that provides an alternative proof of the affine bounded Littlewood identities (1.5)

¹Alternatively, the identity (1.8) can be proved bijectively, essentially by a variant of the Robinson–Schensted correspondence. We explain this in Appendix B, using the growth diagrams of Fomin. There, we also present a uniform treatment of the related results on standard Young tableaux and walks in a Weyl chamber of type A in [7, 37].

and (1.6). Moreover, it also gives proofs of the additional identities in Theorems 3.3 and 3.4. The theme of Section 7 is combinatorial interpretations for the right-hand sides of the affine bounded Littlewood identities (1.5) and (1.6) in terms of up-down tableaux. These interpretations are then used in Section 8 to derive several combinatorial identities that put cylindric standard Young tableaux in relation with so-called vacillating tableaux (which may also be considered as walks in a Weyl chamber of type A); see Corollary 8.2. If this is combined with the bijection in [3, 22], further identities are obtained that relate cylindric standard Young tableaux and matchings with restrictions on their crossings and nestings; see Corollary 8.9. In particular, the identity (1.9) from above is proved in (8.10). In the final section, Section 9, we discuss the special case where $h = 1$. In that case, the cylindric standard Young tableaux may be related to certain walks in a triangle, and the matchings may be related to Motzkin and Dyck paths and prefixes. This leads to the identities in Theorem 9.3. In particular, there we come full circle and explain how the earlier mentioned result of Mortimer and Prellberg fits into the picture. Courtiel, Elvey Price and Marcovici [4] had found a bijective proof of their result, while we failed to find a bijective proof but instead found the much more general results presented in this article — with highly non-bijective proofs — as we describe in Appendix A. We do however provide bijective proofs of the variations of the result of Mortimer and Prellberg that are contained in Theorem 9.3, see the second half of Section 9. As a bonus, in Appendix B we explain how to use Fomin’s growth diagrams to construct — in a uniform manner — bijections for the “marginal” cases of our identities between numbers of standard Young tableaux, matchings, and vacillating tableaux in Section 8.

2. DEFINITIONS AND PRELIMINARIES

In this section, we give basic definitions for partitions, tableaux, and symmetric functions, together with a few preliminary results. In particular, in Definition 2.5 we introduce the cylindric Schur functions which are central objects in our paper.

2.1. Partitions and tableaux. A *partition* of a nonnegative integer n is a weakly decreasing sequence $\lambda = (\lambda_1, \lambda_2, \dots, \lambda_k)$ of positive integers, called *parts*, such that $\sum_{i \geq 1} \lambda_i = n$. This also includes the empty partition $()$, denoted by \emptyset . If λ is a partition of n into k parts, we write $|\lambda| = n$ and $\ell(\lambda) = k$ and say that λ has *size* n and *height* (or *length*) k . We denote by Par the set of all partitions. It is often convenient to identify a partition $(\lambda_1, \lambda_2, \dots, \lambda_k)$ with the infinite sequence $(\lambda_1, \lambda_2, \dots, \lambda_k, 0, 0, \dots)$. Using this convention, we define $\lambda_i = 0$ for $i > \ell(\lambda)$.

The *Young diagram* of a partition $\lambda = (\lambda_1, \lambda_2, \dots, \lambda_k)$ is the set $\{(i, j) \in \mathbb{Z}^2 : 1 \leq i \leq k, 1 \leq j \leq \lambda_i\}$. Each element (i, j) in a Young diagram is called a *cell*. The Young diagram of λ is visualized as a left-justified array of unit square cells with λ_i cells in the i -th row, $i = 1, 2, \dots, k$, from top to bottom. We identify λ with its Young diagram. The *conjugate* (or *transpose*) λ' of a partition λ is the partition whose Young diagram is given by $\{(j, i) : (i, j) \in \lambda\}$. For two partitions λ and μ we write $\mu \subseteq \lambda$ to mean that the Young diagram of μ is contained in that of λ . If $\mu \subseteq \lambda$, the *skew shape* λ/μ is the set-theoretic difference $\lambda - \mu$ of the Young diagrams of λ and μ . Each partition λ is also considered as the skew shape λ/\emptyset .

A *tableau* of shape λ/μ is a filling of the cells in λ/μ with positive integers. For a tableau T of shape $\lambda = (\lambda_1, \lambda_2, \dots)$, the *size*, *height*, and *width* are defined to be $|\lambda|$, $\ell(\lambda)$, and λ_1 , respectively. A *semistandard Young tableau* (SSYT) (respectively *row-strict tableau* (RST)) is a tableau in which the entries along rows (respectively columns) are weakly increasing and the entries along columns (respectively rows) are strictly increasing. A *standard Young tableau* (SYT) is a semistandard Young tableau (or equivalently, row-strict tableau) whose entries are the integers $1, 2, \dots, n$, where n is the size of the tableau.

Definition 2.1. An SSYT (respectively RST) T is (h, w) -*cylindric* if T has at most h rows and $T \cup (T + (h, -w))$ is an SSYT (respectively RST) of a valid skew shape, where $T + (h, -w)$ is the SSYT (respectively RST) obtained by shifting T by h units down and w units to the left (see Figure 1).

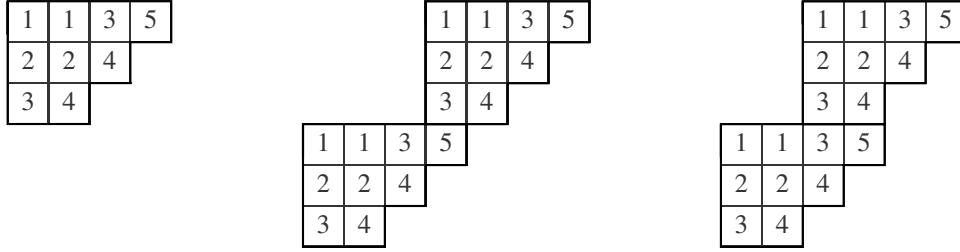

FIGURE 1. The SSYT T on the left is $(3, 3)$ -cylindric but not $(3, 2)$ -cylindric because the tableau in the middle is an SSYT but the tableau on the right is not an SSYT. Moreover, T is not $(3, 1)$ -cylindric because $T \cup (T + (3, -1))$ is not of a skew shape.

Definition 2.2. We write $\text{Par}(h)$ for the set of partitions λ with $\ell(\lambda) \leq h$, and $\text{Par}(h, w)$ for the subset of $\text{Par}(h)$ consisting of the partitions that satisfy in addition $\lambda_1 - \lambda_h \leq w$. For $\lambda \in \text{Par}(h, w)$, we denote by $\text{CSSYT}(\lambda; h, w)$ (respectively $\text{CRST}(\lambda; h, w)$) the set of all (h, w) -cylindric SSYT (respectively RST) of shape λ . Let

$$\text{CSSYT}(h, w) = \bigcup_{\lambda \in \text{Par}(h, w)} \text{CSSYT}(\lambda; h, w), \quad \text{CRST}(h, w) = \bigcup_{\lambda \in \text{Par}(h, w)} \text{CRST}(\lambda; h, w).$$

We also write $\text{CSYT}_n(h, w)$ for the set of (h, w) -cylindric standard Young tableaux of size n .

Note that, for a partition λ with $\ell(\lambda) \leq h$, we have $\text{CSSYT}(\lambda; h, w) = \emptyset$ unless $\lambda_1 - \lambda_h \leq w$ because if $\lambda_1 - \lambda_h > w$, then $T \cup (T + (h, -w))$ is not of a skew shape.

Definition 2.3. Let h and w be positive integers. For $\lambda \in \text{Par}(h, w)$, the (h, w) -cylindric shape $\lambda[h, w]$ is defined by

$$\lambda[h, w] = \{(i, j) + (kh, -kw) : (i, j) \in \lambda, k \in \mathbb{Z}\} / \sim$$

with the relation $(i, j) \sim (i', j')$ if and only if $(i, j) = (i', j') + (kh, -kw)$ for some $k \in \mathbb{Z}$. The transpose $\lambda[h, w]'$ of $\lambda[h, w]$ is defined by $\lambda[h, w]' = \{[(j, i)] : [(i, j)] \in \lambda[h, w]\}$, where $[(i, j)]$ is the equivalence class containing (i, j) . See Figure 2. The (h, w) -transpose $\text{tr}(\lambda; h, w)$ of λ is defined by

$$\text{tr}(\lambda; h, w) = \{(i, j) : [(i, j)] \in \lambda[h, w]', 1 \leq i \leq w\}.$$

By definition one can easily see that $\lambda[h, w]' = \text{tr}(\lambda; h, w)[w, h]$. The map $\lambda \mapsto \text{tr}(\lambda; h, w)$ is essentially the same as the map Ψ due to Goodman and Wenzl [13, p. 253].

One can naturally identify an (h, w) -cylindric SSYT (or RST) T of shape λ with a filling of the cylindric shape $\lambda[h, w]$ by filling each cell $(i', j') \in [(i, j)]$ with the same entry as the one in (i, j) . Then the transpose T' and the (h, w) -transpose $\text{tr}(T; h, w)$ are defined in the obvious way as shown in Figure 3.

Proposition 2.4. Let h and w be positive integers. Then the map $T \mapsto \text{tr}(T; h, w)$ is a bijection between $\text{CRST}(h, w)$ and $\text{CSSYT}(w, h)$ (and also between $\text{CSSYT}(h, w)$ and $\text{CRST}(w, h)$). Moreover, for $\lambda \in \text{Par}(h, w)$, this map induces a bijection between $\text{CRST}(\lambda; h, w)$ and $\text{CSSYT}(\text{tr}(\lambda; h, w); w, h)$ and also a bijection between $\text{CSYT}_n(h, w)$ and $\text{CSYT}_n(w, h)$. In particular, we have

$$|\text{CSYT}_n(h, w)| = |\text{CSYT}_n(w, h)|.$$

Proof. This is immediate from the construction of the map $T \mapsto \text{tr}(T; h, w)$. □

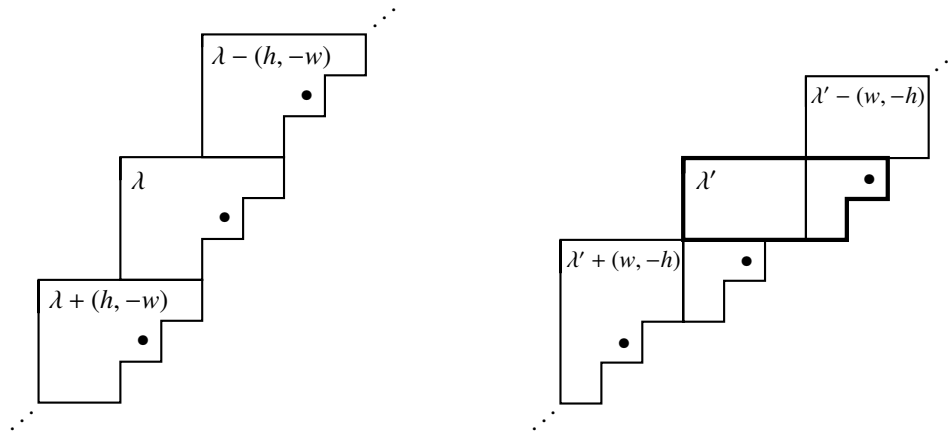

FIGURE 2. The $(3, 2)$ -cylindric shape $\lambda[3, 2]$ of $\lambda = (4, 3, 2)$ is shown on the left. Its transpose $\lambda[3, 2]'$ is shown on the right, where the $(3, 2)$ -transpose $\text{tr}(\lambda; 3, 2)$ of λ is drawn with thick boundary. The cells with dots are identified by the relation \sim .

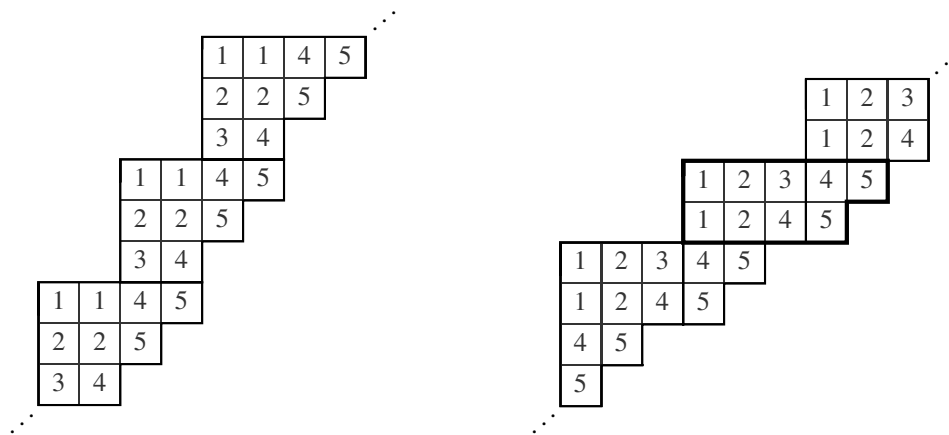

FIGURE 3. The left diagram shows a $(3, 2)$ -cylindric SSYT T of shape $\lambda = (4, 3, 2)$ identified with a filling of the cylindric shape $\lambda[3, 2]$. The right diagram shows the transpose T' as a filling of $\lambda[3, 2]'$ and the $(3, 2)$ -transpose $\text{tr}(T; 3, 2)$ of T whose shape is $\text{tr}(\lambda; 3, 2) = (5, 4)$ drawn with thick boundary.

2.2. Symmetric functions. In this paper we shall be concerned with the following symmetric functions in the variables $\mathbf{x} = \{x_1, x_2, \dots\}$.

The n -th complete homogeneous symmetric function $h_n(\mathbf{x})$ and the n -th elementary symmetric function $e_n(\mathbf{x})$ are defined by

$$h_n(\mathbf{x}) = \sum_{i_1 \leq i_2 \leq \dots \leq i_n} x_{i_1} x_{i_2} \cdots x_{i_n}, \quad e_n(\mathbf{x}) = \sum_{i_1 < i_2 < \dots < i_n} x_{i_1} x_{i_2} \cdots x_{i_n},$$

respectively. We set $h_0(\mathbf{x}) = e_0(\mathbf{x}) = 1$ and define $h_n(\mathbf{x})$ and $e_n(\mathbf{x})$ to be zero for $n < 0$.

For any tableau T , let $\mathbf{x}^T = x_1^{\alpha_1} x_2^{\alpha_2} \cdots$, where α_i is the number of i 's in T . For a partition λ , the *Schur function* $s_\lambda(\mathbf{x})$ is defined by

$$(2.1) \quad s_\lambda(\mathbf{x}) = \sum_T \mathbf{x}^T,$$

where the sum is over all semistandard Young tableaux T of shape λ . If instead in (2.1) we sum over *cylindric* semistandard Young tableaux of a given shape, then we call the resulting object ‘‘cylindric Schur function’’.

Definition 2.5. Let h and w be positive integers and let $\lambda \in \text{Par}(h, w)$. The (h, w) -*cylindric Schur function* $s_{\lambda[h, w]}(\mathbf{x})$ of shape $\lambda[h, w]$ is defined by

$$s_{\lambda[h, w]}(\mathbf{x}) = \sum_{T \in \text{CSSYT}(\lambda; h, w)} \mathbf{x}^T.$$

By definition, we have

$$(2.2) \quad \lim_{w \rightarrow \infty} s_{\lambda[h, w]}(\mathbf{x}) = s_\lambda(\mathbf{x}).$$

Recall that each tableau $T \in \text{CSSYT}(\lambda; h, w)$ can be understood as a filling of the cylindric shape $\lambda[h, w]$. Therefore our definition of a cylindric Schur function is equivalent to that of Postnikov [32, Sec. 6].

For our purpose it is more convenient to deal with $s_{\lambda[h, w]'}(\mathbf{x})$, which is a (w, h) -cylindric Schur function. The following proposition shows that $s_{\lambda[h, w]'}(\mathbf{x})$ can also be seen as the generating function for cylindric row-strict tableaux.

Proposition 2.6. *Let h and w be positive integers and $\lambda \in \text{Par}(h, w)$. Then we have*

$$s_{\lambda[h, w]'}(\mathbf{x}) = \sum_{T \in \text{CRST}(\lambda; h, w)} \mathbf{x}^T.$$

Proof. Since $\lambda[h, w]' = \text{tr}(\lambda; h, w)[w, h]$, we have

$$s_{\lambda[h, w]'}(\mathbf{x}) = \sum_{T \in \text{CSSYT}(\text{tr}(\lambda; h, w); w, h)} \mathbf{x}^T.$$

On the other hand, by the map in Proposition 2.4,

$$\sum_{T \in \text{CRST}(\lambda; h, w)} \mathbf{x}^T = \sum_{T \in \text{CSSYT}(\text{tr}(\lambda; h, w); w, h)} \mathbf{x}^T.$$

Combining the above two equations, we obtain the assertion of the proposition. \square

The *quantum Kostka numbers* $K_{\lambda[h, w]}^\alpha$ are defined by

$$s_{\lambda[h, w]}(\mathbf{x}) = \sum_{\alpha} K_{\lambda[h, w]}^\alpha \mathbf{x}^\alpha,$$

where the sum is over all sequences $\alpha = (\alpha_1, \alpha_2, \dots)$ of nonnegative integers. By Proposition 2.6, $K_{\lambda[h, w]}^\alpha$ is the number of tableaux $T \in \text{CRST}(\lambda; h, w)$ in which the number of i 's is equal to α_i for all $i \geq 1$. There is another description of $K_{\lambda[h, w]}^\alpha$ in terms of lattice paths.

Proposition 2.7. *Let h and w be positive integers, λ a partition in $\text{Par}(h, w)$, and $\alpha = (\alpha_1, \alpha_2, \dots)$ a sequence of nonnegative integers. Then $K_{\lambda[h, w]}^\alpha$ equals the number of paths in \mathbb{Z}^h from the origin to $(\lambda_1, \dots, \lambda_h)$ and staying in the region*

$$\{(x_1, x_2, \dots, x_h) : x_1 \geq x_2 \geq \cdots \geq x_h \geq x_1 - w\},$$

where the i -th step is a vector with α_i coordinates equal to 1 and $h - \alpha_i$ coordinates equal to 0.

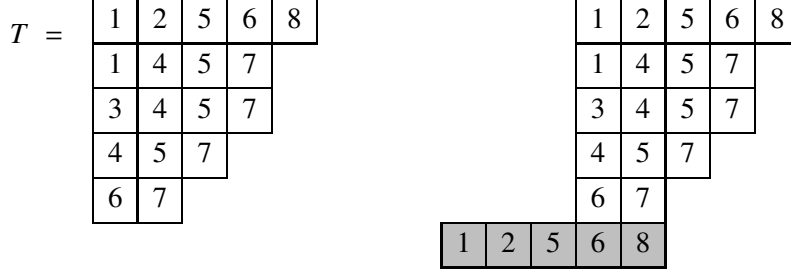

FIGURE 4. The left diagram shows a row-strict tableau $T \in \text{CRST}(\lambda; h, w)$ for $\lambda = (5, 4, 4, 3, 2)$, $h = 5$, and $w = 3$. The right diagram shows T together with a copy of its first row translated by $(h, -w)$.

Proof. We obtain the proposition by reading the vectors of row lengths of the subtableaux containing all entries at most i for $i = 0, 1, \dots$. For example, the $(2, 3)$ -cylindric row-strict tableau in the right diagram of Figure 3 corresponds to the lattice path

$$(0, 0) \rightarrow (1, 1) \rightarrow (2, 2) \rightarrow (3, 2) \rightarrow (4, 3) \rightarrow (5, 4).$$

The property that the tableau is (h, w) -cylindric translates into the property that the lattice walk is in the given region. \square

As reported in [32, Eq. (11)], the results on cylindric tableaux of Gessel and the third author [10] imply a Jacobi–Trudi-type formula for the cylindric Schur functions. For the sake of completeness, we also provide the corresponding proof.

Theorem 2.8. *For positive integers h and w and a partition $\lambda \in \text{Par}(h, w)$, we have*

$$(2.3) \quad s_{\lambda[h, w]'}(\mathbf{x}) = \sum_{\substack{k_1, \dots, k_h \in \mathbb{Z} \\ k_1 + \dots + k_h = 0}} \det_{1 \leq i, j \leq h} \left(e_{\lambda_i - i + j + (h+w)k_i}(\mathbf{x}) \right).$$

Proof. By Proposition 2.6, the cylindric Schur function on the left-hand side of (2.3) is a generating function for cylindric row-strict tableaux. We first show that these tableaux are in bijection with certain families of nonintersecting lattice paths. In order to see this, we place ourselves in the setting of Section 9 in [10]. Namely, we consider the graph with vertices being the points in the integer plane \mathbb{Z}^2 , and with edges being horizontal edges $(i-1, j) \rightarrow (i, j)$ and vertical edges $(i, j-1) \rightarrow (i, j)$. We define the weight of vertical edges to be 1 and the weight of a horizontal edge e from $(i-1, j)$ to (i, j) to be $\omega(e) := x_{i+j}$. By definition, the weight $\omega(P)$ of a path P is the product of the weights of all its edges, and the weight $\omega(\mathbf{P})$ of a family $\mathbf{P} = (P_1, P_2, \dots, P_k)$ of paths is $\prod_{i=1}^k \omega(P_i)$. Now, given $T \in \text{CRST}(\lambda; w, h)$, we convert it into a family $\mathbf{P} = (P_1, P_2, \dots, P_h)$ of paths in the graph, by mapping the i -th row of T to the path P_i from $(-i+1, i-1)$ to $(\lambda_i - i + 1, \infty)$ such that the weights of the horizontal steps of P_i are indexed by the entries in that row. For example, see Figure 5 for the family of paths corresponding to the tableau in Figure 4.

The property of T having weak increase of entries along columns translates into the property of \mathbf{P} being nonintersecting, and the property of T being (h, w) -cylindric translates into the property that the shift of P_1 by $(-h-w, h+w)$ does not intersect P_h (and, thus, also not any other paths). In Figure 5, this shift of P_1 is indicated by the dotted path.

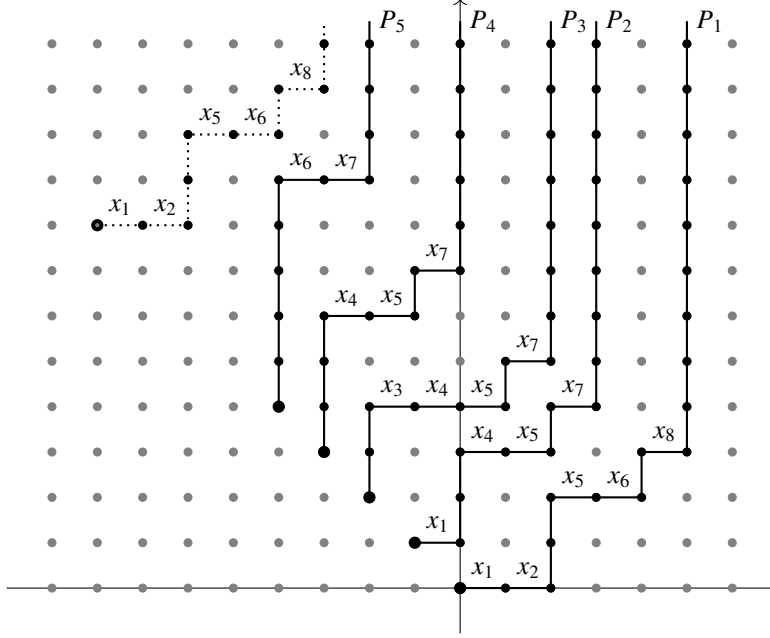

FIGURE 5. The family $\mathbf{P} = (P_1, P_2, P_3, P_4, P_5)$ of paths corresponding to the tableau T in Figure 4. The shift of P_1 is indicated by the dotted path.

Therefore the left-hand side of (2.3) equals the generating function $\sum_{\mathbf{P}} \omega(\mathbf{P})$ for these families \mathbf{P} of nonintersecting lattice paths. As explained in [10, Sec. 9] this generating function is equal to

$$\sum_{\substack{k_1, \dots, k_h \in \mathbb{Z} \\ k_1 + \dots + k_h = 0}} \det_{1 \leq i, j \leq h} \left(e_{\lambda_i - i + j + (h+w)k_i}(\mathbf{x}) \right),$$

which is exactly the right-hand side of (2.3). \square

3. AFFINE BOUNDED LITTLEWOOD IDENTITIES

In this section, we present our affine bounded Littlewood identities, see Theorems 3.1, 3.3, and 3.4. A first proof of Theorem 3.1 is given in Section 5. In the subsequent Section 6 we develop a uniform approach to prove affine bounded Littlewood identities. This leads to an alternative proof of Theorem 3.1, as well as to proofs of Theorems 3.3 and 3.4.

We start by restating the identities (1.5) and (1.6) in a more compact form. As explained in the introduction, these are affine extensions of the bounded Littlewood identities (1.2) and (1.3). Moreover, as pointed out after Theorem 1.1, the latter two identities express odd orthogonal characters indexed by a rectangular shape in terms of Schur functions.

Theorem 3.1 (TWO AFFINE BOUNDED LITTLEWOOD IDENTITIES: ODD ORTHOGONAL CASE). *For positive integers h and w , we have*

$$(3.1) \quad \sum_{\lambda \in \text{Par}(2h+1, w)} s_{\lambda[2h+1, w]'}(\mathbf{x}) = \sum_{k \geq 0} e_k(\mathbf{x}) \det_{1 \leq i, j \leq h} \left(F_{-i+j, 2h+1+w}(\mathbf{x}) - F_{i+j, 2h+1+w}(\mathbf{x}) \right),$$

$$(3.2) \quad \sum_{\lambda \in \text{Par}(2h, w)} s_{\lambda[2h, w]'}(\mathbf{x}) = \det_{1 \leq i, j \leq h} \left(\bar{F}_{-i+j, 2h+w}(\mathbf{x}) + \bar{F}_{i+j-1, 2h+w}(\mathbf{x}) \right),$$

where $\text{Par}(m, w)$ is the set of partitions λ with $\ell(\lambda) \leq m$ and $\lambda_1 - \lambda_m \leq w$, and

$$F_{r,N}(\mathbf{x}) = \sum_{k \in \mathbb{Z}} f_{r+Nk}(\mathbf{x}),$$

$$\bar{F}_{r,N}(\mathbf{x}) = \sum_{k \in \mathbb{Z}} (-1)^k f_{r+Nk}(\mathbf{x}),$$

with

$$f_r(\mathbf{x}) = \sum_{i \in \mathbb{Z}} e_i(\mathbf{x}) e_{i+r}(\mathbf{x}),$$

as before.

Remarks 3.2. (1) It should be obvious that the identities (3.1) and (3.2) are equivalent with (1.5) and (1.6), respectively.

(2) Note that $f_r(\mathbf{x}) = f_{-r}(\mathbf{x})$, $F_{r,N}(\mathbf{x}) = F_{-r,N}(\mathbf{x})$, $\bar{F}_{r,N}(\mathbf{x}) = \bar{F}_{-r,N}(\mathbf{x})$, and

$$\lim_{N \rightarrow \infty} F_{r,N}(\mathbf{x}) = \lim_{N \rightarrow \infty} \bar{F}_{r,N}(\mathbf{x}) = f_r(\mathbf{x}).$$

In particular, as $w \rightarrow \infty$, the identities (3.1) and (3.2) reduce to (1.2) and (1.3), respectively.

(3) Why do we call the identities in Theorem 3.1 ‘‘affine’’ bounded Littlewood identities, i.e., what is the meaning of ‘‘affine’’ in this context? To understand this, we observe that, by (1.1), the summand indexed by λ on the left-hand sides of (1.5) and (1.6) can be written as

$$s_{\lambda'}(\mathbf{x}) = \det_{1 \leq i, j \leq m} (e_{\lambda_i - i + j}(\mathbf{x})) = \sum_{\sigma \in \mathfrak{S}_m} \text{sgn } \sigma \prod_{i=1}^m e_{\lambda_i - i + \sigma(i)}(\mathbf{x}),$$

where $m = 2h + 1$ respectively $m = 2h$. The right-hand side is a sum over the symmetric group \mathfrak{S}_m . In the classification of finite Coxeter groups, this is the reflection group of type A_{m-1} (cf. [18, p. 41]). On the other hand, by (2.3), the summand indexed by λ on the left-hand sides of (3.1) and (3.2) can be written as

$$s_{\lambda[m,w]}(\mathbf{x}) = \sum_{\substack{k_1, \dots, k_m \in \mathbb{Z} \\ k_1 + \dots + k_m = 0}} \det_{1 \leq i, j \leq m} (e_{\lambda_i - i + j + (m+w)k_i}(\mathbf{x})) = \sum_{\substack{k_1, \dots, k_m \in \mathbb{Z} \\ k_1 + \dots + k_m = 0}} \sum_{\sigma \in \mathfrak{S}_m} \text{sgn } \sigma \prod_{i=1}^m e_{\lambda_i - i + \sigma(i) + (m+w)k_i}(\mathbf{x}),$$

where m has the same meaning as before. The right-hand side is now a sum over the *affine* symmetric group $\tilde{\mathfrak{S}}_m$ defined by

$$\tilde{\mathfrak{S}}_m := \mathfrak{S}_m \times \{(k_1, k_2, \dots, k_m) \in \mathbb{Z}^m : k_1 + k_2 + \dots + k_m = 0\}.$$

In the classification of affine Coxeter groups, this is the reflection group of (affine) type \tilde{A}_{m-1} (cf. [2, Sec. 8.3]).

Our next identities provide affine extensions of

$$(3.3) \quad \sum_{\substack{\lambda: \lambda_1 \leq 2h \\ \lambda \text{ even}}} s_{\lambda}(\mathbf{x}) = \det_{1 \leq i, j \leq h} (f_{-i+j}(\mathbf{x}) - f_{i+j}(\mathbf{x})),$$

where a partition λ is called *even* if all of its parts are even (cf. [36, Eq. (7.2)], modulo an application of the symmetric function involution interchanging complete homogeneous and elementary symmetric functions). We point out that the right-hand side of this identity is (essentially) an irreducible character of rectangular shape of the symplectic group $\text{Sp}_{2n}(\mathbb{C})$ (see [36, Cor. 7.4(b)]).

Theorem 3.3 (TWO AFFINE BOUNDED LITTLEWOOD IDENTITIES: SYMPLECTIC CASE). *Let h and w be positive integers. For a partition λ with length $\leq 2h$ and $\lambda_1 - \lambda_{2h} \leq w$, we define*

$$(3.4) \quad c_{2h,w}^{\pm}(\lambda) = \begin{cases} 1, & \text{if } \lambda_{2i-1} = \lambda_{2i} \text{ for all } 1 \leq i \leq h, \\ \pm 1, & \text{if } \lambda_1 - \lambda_{2h} = w \text{ and } \lambda_{2i} = \lambda_{2i+1} \text{ for all } 1 \leq i \leq h-1, \\ 0, & \text{otherwise.} \end{cases}$$

Then we have

$$(3.5) \quad \sum_{\lambda \in \text{Par}(2h,w)} c_{2h,w}^+(\lambda) s_{\lambda[2h,w]'}(\mathbf{x}) = \det_{1 \leq i, j \leq h} (\bar{F}_{-i+j, 2h+w}(\mathbf{x}) - \bar{F}_{i+j, 2h+w}(\mathbf{x})),$$

$$(3.6) \quad \sum_{\lambda \in \text{Par}(2h,w)} c_{2h,w}^-(\lambda) s_{\lambda[2h,w]'}(\mathbf{x}) = \det_{1 \leq i, j \leq h} (F_{-i+j, 2h+w}(\mathbf{x}) - F_{i+j, 2h+w}(\mathbf{x})),$$

where $F_{r,N}(\mathbf{x})$ and $\bar{F}_{r,N}(\mathbf{x})$ are defined in Theorem 3.1.

Clearly, using (2.2), we see that, in the limit $w \rightarrow \infty$, both (3.5) and (3.6) reduce to (3.3).

The last set of identities in this section consists of affine extensions of the identities

$$(3.7) \quad \sum_{\substack{\lambda: \lambda_1 \leq 2h+1 \\ \lambda' \text{ even}}} s_{\lambda}(\mathbf{x}) + \sum_{\substack{\lambda: \lambda_1 \leq 2h+1 \\ \lambda' \text{ odd}}} s_{\lambda}(\mathbf{x}) = \frac{1}{2} \det_{1 \leq i, j \leq h} (f_{-i+j}(\mathbf{x}) + f_{i+j-2}(\mathbf{x})),$$

$$(3.8) \quad \sum_{\substack{\lambda: \lambda_1 \leq 2h+1 \\ \lambda' \text{ even}}} s_{\lambda}(\mathbf{x}) - \sum_{\substack{\lambda: \lambda_1 \leq 2h+1 \\ \lambda' \text{ odd}}} s_{\lambda}(\mathbf{x}) = e(\mathbf{x}) \cdot \bar{e}(\mathbf{x}) \det_{1 \leq i, j \leq h-1} (f_{-i+j}(\mathbf{x}) - f_{i+j}(\mathbf{x})),$$

$$(3.9) \quad \sum_{\substack{\lambda: \lambda_1 \leq 2h \\ \lambda' \text{ even}}} s_{\lambda}(\mathbf{x}) + \sum_{\substack{\lambda: \lambda_1 \leq 2h \\ \lambda' \text{ odd}}} s_{\lambda}(\mathbf{x}) = e(\mathbf{x}) \det_{1 \leq i, j \leq h} (f_{-i+j}(\mathbf{x}) - f_{i+j-1}(\mathbf{x})),$$

$$(3.10) \quad \sum_{\substack{\lambda: \lambda_1 \leq 2h \\ \lambda' \text{ even}}} s_{\lambda}(\mathbf{x}) - \sum_{\substack{\lambda: \lambda_1 \leq 2h \\ \lambda' \text{ odd}}} s_{\lambda}(\mathbf{x}) = \bar{e}(\mathbf{x}) \det_{1 \leq i, j \leq h} (f_{-i+j}(\mathbf{x}) + f_{i+j-1}(\mathbf{x})),$$

where a partition is called *odd* if all of its parts are odd, and where

$$(3.11) \quad e(\mathbf{x}) = \sum_{i \geq 0} e_i(\mathbf{x}), \quad \bar{e}(\mathbf{x}) = \sum_{i \geq 0} (-1)^i e_i(\mathbf{x}).$$

These are universal character identities resulting from Theorem 2.3(3) in [31], if seen in combination with the Weyl denominator formula (cf. [9, Eq. (24.40)] or [31, Prop. 1.1]) and determinantal identities that can be found in [9, App. A.64–A.67]. The right-hand sides are (essentially) sums, or differences, of two irreducible characters of (signed) rectangular shape of the even orthogonal group $\text{SO}_{2n}(\mathbb{C})$.

Theorem 3.4 (FOUR AFFINE BOUNDED LITTLEWOOD IDENTITIES: EVEN ORTHOGONAL CASE). *For a partition λ of length $\leq m$ for which $\lambda_1 - \lambda_m \leq w$, we define*

$$(3.12) \quad d_{m,w}^{\pm}(\lambda) = \begin{cases} 1, & \text{if } \lambda_1, \dots, \lambda_m \in 2\mathbb{Z}, \\ \pm 1, & \text{if } \lambda_1, \dots, \lambda_m \in 2\mathbb{Z} + 1, \\ 0, & \text{otherwise.} \end{cases}$$

For an integer $h \geq 1$ and an even integer $w \geq 2$, we have

$$(3.13) \quad \sum_{\lambda \in \text{Par}(2h,w)} d_{2h,w}^+(\lambda) s_{\lambda[2h,w]'}(\mathbf{x}) = \frac{1}{2} \det_{1 \leq i, j \leq h} (\bar{F}_{-i+j, 2h+w}(\mathbf{x}) + \bar{F}_{i+j-2, 2h+w}(\mathbf{x})),$$

$$(3.14) \quad \sum_{\lambda \in \text{Par}(2h,w)} d_{2h,w}^-(\lambda) s_{\lambda[2h,w]'}(\mathbf{x}) = e(\mathbf{x}) \cdot \bar{e}(\mathbf{x}) \det_{1 \leq i, j \leq h-1} \left(F_{-i+j, 2h+w}(\mathbf{x}) - F_{i+j, 2h+w}(\mathbf{x}) \right),$$

$$(3.15) \quad \sum_{\lambda \in \text{Par}(2h+1,w)} d_{2h+1,w}^+(\lambda) s_{\lambda[2h+1,w]'}(\mathbf{x}) = e(\mathbf{x}) \det_{1 \leq i, j \leq h} \left(F_{-i+j, 2h+1+w}(\mathbf{x}) - F_{i+j-1, 2h+1+w}(\mathbf{x}) \right),$$

$$(3.16) \quad \sum_{\lambda \in \text{Par}(2h+1,w)} d_{2h+1,w}^-(\lambda) s_{\lambda[2h+1,w]'}(\mathbf{x}) = \bar{e}(\mathbf{x}) \det_{1 \leq i, j \leq h} \left(\bar{F}_{-i+j, 2h+1+w}(\mathbf{x}) + \bar{F}_{i+j-1, 2h+1+w}(\mathbf{x}) \right),$$

where $F_{r,N}(\mathbf{x})$ and $\bar{F}_{r,N}(\mathbf{x})$ are defined in Theorem 3.1, the determinant of an empty matrix is defined to be 1, and $e(\mathbf{x})$ and $\bar{e}(\mathbf{x})$ are given in (3.11).

Again using (2.2), we see that, in the limit $w \rightarrow \infty$, the identities (3.13)–(3.16) reduce to (3.7)–(3.10), respectively.

Remark 3.5. Obviously, the reader will ask what happens when w is odd. What we can tell is that all of (3.13)–(3.16) do not hold if w is odd. We do not know whether it is possible to modify the right-hand sides in order to obtain valid identities, or whether there are no determinantal formulas at all for odd w .

4. PFAFFIANS AND SUMS OF MINORS

In this section, we recall two Pfaffian/determinantal formulas, which will be crucial in the proofs of the affine bounded Littlewood identities in Section 3, given in the coming two sections. These are the minor summation formula of Ishikawa and Wakayama (see Theorem 4.2) — of which we state an important special case in Corollary 4.3 separately — and Gordon's Pfaffian-to-determinant reduction (see Lemma 4.4) together with simple consequences given in Corollary 4.5. The reader should recall (cf. [36, Sec. 2]) that Pfaffians are defined for upper triangular arrays. As usual, we extend the Pfaffian to skew-symmetric matrices A , with the understanding that $\text{Pf } A$ is by definition the Pfaffian of the upper triangular part of A . In the sequel, for a matrix M , its transpose is denoted by M^t .

Definition 4.1. Let $A = (a_{i,j})_{i \in I, j \in J}$ be a matrix and let $R = (r_1, \dots, r_p)$ and $S = (s_1, \dots, s_q)$ be sequences of row and column indices respectively. We define

$$A_S^R = (a_{r_i, s_j})_{1 \leq i \leq p, 1 \leq j \leq q}.$$

We also define $(r_1, \dots, r_p) \sqcup (r'_1, \dots, r'_{p'}) = (r_1, \dots, r_p, r'_1, \dots, r'_{p'})$.

The minor summation formula of Ishikawa and Wakayama is the following.

Theorem 4.2 ([19, Th. 1]). *Let m and p be positive integers and $M = (M_{i,j})_{1 \leq i \leq m, 1 \leq j \leq p}$ any $m \times p$ matrix.*

(1) *If m is even and $A = (a_{r,s})_{1 \leq r, s \leq p}$ is any $p \times p$ skew-symmetric matrix, then we have*

$$\sum_K \text{Pf} \left(A_K^K \right) \det \left(M_K^{[m]} \right) = \text{Pf} \left(M A M^t \right) = \text{Pf}_{1 \leq i < j \leq m} \left(\sum_{r,s=1}^p a_{r,s} M_{i,r} M_{j,s} \right),$$

where $K = (k_1, \dots, k_m)$ runs over all increasing sequences $1 \leq k_1 < \dots < k_m \leq p$ of integers, and $[m] := (1, 2, \dots, m)$.

(2) *If m is odd and $A = (a_{r,s})_{0 \leq r, s \leq p}$ is any $(p+1) \times (p+1)$ skew-symmetric matrix, then we have*

$$\sum_K \text{Pf} \left(A_{(0) \sqcup K}^{(0) \sqcup K} \right) \det \left(M_K^{[m]} \right) = \text{Pf}_{0 \leq i < j \leq m} \left(\begin{cases} \sum_{r=1}^p a_{0,r} M_{j,r}, & \text{if } i = 0 \\ \sum_{r,s=1}^p a_{r,s} M_{i,r} M_{j,s}, & \text{if } i > 0 \end{cases} \right),$$

where $K = (k_1, \dots, k_m)$ runs over all increasing sequences $1 \leq k_1 < \dots < k_m \leq p$ of integers.

We note that Theorem 4.2 is also valid in the limiting case $p = \infty$ provided that the limits of both sides exist.

For convenience, we state the special case where A is the skew-symmetric matrix with all 1's above the diagonal, which, in abuse of notation, we write as (1). It should be noted that $\text{Pf}_{1 \leq i < j \leq 2p}(1) = 1$ for all p (see [36, Prop. 2.3(c)]).

Corollary 4.3 ([30, Th. 3]). *Let m and p be positive integers and $M = (M_{i,j})_{1 \leq i \leq m, 1 \leq j \leq p}$ any $m \times p$ matrix.*

(1) *If m is even, then we have*

$$\sum_K \det M_K^{[m]} = \text{Pf} \left(\sum_{1 \leq r < s \leq p} (M_{i,r} M_{j,s} - M_{i,s} M_{j,r}) \right),$$

where $K = (k_1, \dots, k_m)$ runs over all increasing sequences $1 \leq k_1 < \dots < k_m \leq p$ of integers.

(2) *If m is odd, then we have*

$$\sum_K \det M_K^{[m]} = \text{Pf} \left(\begin{cases} \sum_{1 \leq r \leq p} M_{j,r}, & \text{if } i = 0 \\ \sum_{1 \leq r < s \leq p} (M_{i,r} M_{j,s} - M_{i,s} M_{j,r}), & \text{if } i > 0 \end{cases} \right),$$

where $K = (k_1, \dots, k_m)$ runs over all increasing sequences $1 \leq k_1 < \dots < k_m \leq p$ of integers.

The following identity between a Pfaffian and a determinant is due to Gordon.

Lemma 4.4 ([14, Lem. 1]). *If the quantities z_i , $i \in \mathbb{Z}$, satisfy $z_{-i} = -z_i$, then we have*

$$(4.1) \quad \text{Pf}_{1 \leq i, j \leq 2h} (z_{j-i}) = \det_{1 \leq i, j \leq h} (z_{|j-i|+1} + z_{|j-i|+3} + z_{|j-i|+5} + \dots + z_{i+j-1}).$$

It is convenient to rewrite the determinant above in the following form. Equation (4.2) below was used in the proof of [36, Th. 7.1(a)].

Corollary 4.5. *If the quantities z_i , $i \in \mathbb{Z}$, satisfy $z_{-i} = -z_i$, then we have*

$$(4.2) \quad \text{Pf}_{1 \leq i, j \leq 2h} (z_{j-i}) = \det_{1 \leq i, j \leq h} \left(\sum_{s=0}^{2 \min(i,j)-2} (-1)^s (z_{i+j-1-s} - z_{i+j-2-s}) \right)$$

$$(4.3) \quad = \det_{1 \leq i, j \leq h} \left(\sum_{s=0}^{2 \min(i,j)-2} (z_{i+j-1-s} + z_{i+j-2-s}) \right)$$

$$(4.4) \quad = \det_{1 \leq i, j \leq h} \begin{cases} z_1, & \text{if } i = j = 1 \\ z_i - z_{i-2}, & \text{if } j = 1 \text{ and } i \geq 2 \\ z_j - z_{j-2}, & \text{if } i = 1 \text{ and } j \geq 2 \\ z_{i+j-1} - z_{i+j-3} + z_{|j-i|+1} - z_{|j-i|-1}, & \text{if } i \geq 2 \text{ and } j \geq 2 \end{cases}.$$

Proof. Equation (4.2) (respectively (4.3)) is obtained from (4.1) by subtracting the $(i-1)$ -st row from the i -th (respectively adding the $(i-1)$ -st row to the i -th), $i = h, h-1, \dots, 2$, and then doing the analogous column operations. Similarly, we obtain (4.4) from (4.1) by subtracting the $(i-2)$ -nd row from the i -th, $i = h, h-1, \dots, 3$ and performing the same operations on the columns. \square

5. PROOF OF THE AFFINE BOUNDED LITTLEWOOD IDENTITIES IN THEOREM 3.1

In this section, we prove the affine bounded Littlewood identities in (3.1) and (3.2).

For a positive integer N and an integer t , let $R_N(t)$ denote the remainder of t when divided by N , that is, $t = \lfloor t/N \rfloor N + R_N(t)$ and $0 \leq R_N(t) < N$. For a statement S we let $\chi[S] = 1$ if the statement S is true and $\chi[S] = 0$ otherwise.

We start by rewriting and rearranging the terms on the left-hand sides of (3.1) and (3.2), with the goal of expressing them as sums of minors, so that the minor summation theorem in Corollary 4.3 can be applied.

Lemma 5.1. *Let m and N be positive integers such that $m < N$ and m is odd. Then*

$$(5.1) \quad \sum_{\substack{\mu_1, \dots, \mu_m \in \mathbb{Z} \\ \mu_1 > \dots > \mu_m \text{ and } \mu_1 - \mu_m < N}} \sum_{\substack{k_1, \dots, k_m \in \mathbb{Z} \\ k_1 + \dots + k_m = 0}} \det_{1 \leq i, j \leq m} (e_{\mu_i + Nk_i + j}(\mathbf{x})) = \sum_{\substack{\alpha_1, \dots, \alpha_m \in \mathbb{Z} \\ R_N(\alpha_1) > \dots > R_N(\alpha_m)}} \det_{1 \leq i, j \leq m} (e_{\alpha_i + j}(\mathbf{x})).$$

Remark 5.2. In view of (2.3), the left-hand side of (3.1) equals (cf. (1.5))

$$\sum_{\substack{\lambda: \ell(\lambda) \leq 2h+1 \\ \lambda_1 - \lambda_{2h+1} \leq w}} \sum_{\substack{k_1, \dots, k_{2h+1} \in \mathbb{Z} \\ k_1 + \dots + k_{2h+1} = 0}} \det_{1 \leq i, j \leq 2h+1} (e_{\lambda_i - i + j + (2h+w+1)k_i}(\mathbf{x})).$$

If we now do the substitution $\lambda_i = \mu_i + i$, then we see that we obtain the left-hand side of (5.1) with $m = 2h + 1$ and $N = 2h + 1 + w$.

Proof of Lemma 5.1. Let U be the set of pairs (μ, k) of m -tuples $\mu = (\mu_1, \dots, \mu_m) \in \mathbb{Z}^m$ and $k = (k_1, \dots, k_m) \in \mathbb{Z}^m$ with $\mu_1 > \dots > \mu_m$, $\mu_1 - \mu_m < N$, and $k_1 + \dots + k_m = 0$. Let V be the set of m -tuples $\alpha = (\alpha_1, \dots, \alpha_m) \in \mathbb{Z}^m$ for which $R_N(\alpha_1) > \dots > R_N(\alpha_m)$. Then what we need to show is

$$(5.2) \quad \sum_{(\mu, k) \in U} \det_{1 \leq i, j \leq m} (e_{\mu_i + Nk_i + j}(\mathbf{x})) = \sum_{\alpha \in V} \det_{1 \leq i, j \leq m} (e_{\alpha_i + j}(\mathbf{x})).$$

Suppose $(\mu, k) \in U$. Let $q = \lfloor \mu_m / N \rfloor$ and, for $1 \leq i \leq m$, let r_i be the integer such that $\mu_i = qN + r_i$. Then there is a unique integer $0 \leq t < m$ such that

$$(5.3) \quad N + r_m > r_1 > \dots > r_t \geq N > r_{t+1} > \dots > r_m \geq 0.$$

Now let $\beta = (\beta_1, \dots, \beta_m)$, where $\beta_i = \mu_i + Nk_i$. By (5.3), we have

$$(5.4) \quad \sum_{i=1}^m \lfloor \beta_i / N \rfloor = \sum_{i=1}^m (\lfloor \mu_i / N \rfloor + k_i) = \sum_{i=1}^m \lfloor \mu_i / N \rfloor = qm + t.$$

Moreover, we have $R_N(\beta_i) = R_N(\mu_i)$, which is equal to r_i if $t + 1 \leq i \leq m$ and to $r_i - N$ if $1 \leq i \leq t$. Since the integers $q, t \in \mathbb{Z}$ with $0 \leq t < m$ are determined by β via to (5.4), the pair (μ, k) can be recovered from the sequence β as follows:

$$(5.5) \quad \mu_i = \begin{cases} (q+1)N + R_N(\beta_i), & \text{if } 1 \leq i \leq t, \\ qN + R_N(\beta_i), & \text{if } t+1 \leq i \leq m, \end{cases}$$

$$(5.6) \quad k_i = \frac{\beta_i - \mu_i}{N}.$$

On the other hand, by (5.3), we have

$$(5.7) \quad R_N(\beta_{t+1}) > \dots > R_N(\beta_m) > R_N(\beta_1) > \dots > R_N(\beta_t).$$

Let $\alpha = (\alpha_1, \dots, \alpha_m) = (\beta_{t+1}, \dots, \beta_m, \beta_1, \dots, \beta_t)$. By (5.7), we have $\alpha \in V$.

Observe that $\det(e_{\mu_i + Nk_i + j}(\mathbf{x})) = \det(e_{\beta_i + j}(\mathbf{x})) = \det(e_{\alpha_i + j}(\mathbf{x}))$ because cyclically shifting indices of an $m \times m$ matrix does not change its determinant when m is odd. Thus, to prove (5.2), it suffices to show that the map $(\mu, k) \mapsto \alpha$ is a bijection between U and V .

Suppose $\alpha \in V$. Let q and t be the unique integers satisfying $\sum_{i=1}^m \lfloor \alpha_i / N \rfloor = qm + t$ and $0 \leq t < m$. Let $\beta = (\alpha_{m-t+1}, \dots, \alpha_m, \alpha_1, \dots, \alpha_{m-t})$. Finally, define (μ, k) using (5.5) and (5.6). It is easy to check that the map $\alpha \mapsto (\mu, k)$ is the desired inverse map. \square

Lemma 5.3. *Let m and N be positive integers with $m < N$ and m is even. Then*

$$(5.8) \quad \sum_{\substack{\mu_1, \dots, \mu_m \in \mathbb{Z} \\ \mu_1 > \dots > \mu_m \text{ and } \mu_1 - \mu_m < N}} \sum_{\substack{k_1, \dots, k_m \in \mathbb{Z} \\ k_1 + \dots + k_m = 0}} \det_{1 \leq i, j \leq m} (e_{\mu_i + Nk_i + j}(\mathbf{x})) = \sum_{\substack{\alpha_1, \dots, \alpha_m \in \mathbb{Z} \\ R_N(\alpha_1) > \dots > R_N(\alpha_m)}} (-1)^{\sum_{i=1}^m \lfloor \alpha_i / N \rfloor} \det_{1 \leq i, j \leq m} (e_{\alpha_i + j}(\mathbf{x})).$$

Remark 5.4. Similarly to Remark 5.2, in view of (2.3), the left-hand side of (3.2) equals (cf. (1.6)) the left-hand side of (5.8) with $m = 2h$ and $N = 2h + w$.

Proof of Lemma 5.3. This can be proved by the same arguments as in the proof of Lemma 5.1. The only difference is that, if (μ, k) corresponds to α , then $\det(e_{\mu_i + Nk_i + j}(\mathbf{x})) = \det(e_{\beta_i + j}(\mathbf{x})) = (-1)^t \det(e_{\alpha_i + j}(\mathbf{x}))$ because cyclically shifting indices of an $m \times m$ matrix changes the sign of its determinant when m is even. Since $(-1)^t = (-1)^{\sum_{i=1}^m \lfloor \alpha_i / N \rfloor - qm} = (-1)^{\sum_{i=1}^m \lfloor \alpha_i / N \rfloor}$, we obtain the desired formula. \square

In view of Remark 5.2, the identity (3.1) will follow once we show the following equality.

Proposition 5.5. *For nonnegative integers h and N with $N > 2h + 1$, we have*

$$\sum_{\substack{\alpha_1, \dots, \alpha_{2h+1} \in \mathbb{Z} \\ R_N(\alpha_1) > \dots > R_N(\alpha_{2h+1})}} \det_{1 \leq i, j \leq 2h+1} (e_{\alpha_i + j}(\mathbf{x})) = \sum_{k \geq 0} e_k(\mathbf{x}) \det_{1 \leq i, j \leq h} (F_{-i+j, N}(\mathbf{x}) - F_{i+j, N}(\mathbf{x})).$$

Similarly, in view of Remark 5.4, the identity (3.2) will follow once we show the equality in the proposition below.

Proposition 5.6. *For positive integers h and N with $N > 2h$, we have*

$$\sum_{\substack{\alpha_1, \dots, \alpha_{2h} \in \mathbb{Z} \\ R_N(\alpha_1) > \dots > R_N(\alpha_{2h})}} (-1)^{\sum_{i=1}^{2h} \lfloor \alpha_i / N \rfloor} \det_{1 \leq i, j \leq 2h} (e_{\alpha_i + j}(\mathbf{x})) = \det_{1 \leq i, j \leq h} (\bar{F}_{-i+j, N}(\mathbf{x}) + \bar{F}_{i+j-1, N}(\mathbf{x})).$$

In the next two subsections, we prove Propositions 5.5 and 5.6. Our approach parallels the one in Stembridge's proof of the bounded Littlewood identities (1.2) and (1.3) (see [36, Th. 7.1]).

5.1. Proof of Proposition 5.5. Let h and N be nonnegative integers satisfying $N > 2h + 1$. Throughout this subsection we write $e(\mathbf{x}) = \sum_{k \geq 0} e_k(\mathbf{x})$, as in Theorem 3.4 before, and E is the $1 \times (2h + 1)$ matrix whose entries are all equal to $e(\mathbf{x})$.

For two integers i and j , we define

$$d_N(i, j) = \sum_{\substack{m, n \in \mathbb{Z} \\ R_N(m-i) > R_N(n-j)}} e_m(\mathbf{x}) e_n(\mathbf{x}) - \sum_{\substack{m, n \in \mathbb{Z} \\ R_N(m-i) < R_N(n-j)}} e_m(\mathbf{x}) e_n(\mathbf{x}).$$

By definition, $d_N(j, i) = -d_N(i, j)$ and $d_N(i, i) = 0$. For a nonnegative integer n , let $D_N(n)$ denote the $n \times n$ skew-symmetric matrix given by

$$D_N(n) = (d_N(i, j))_{1 \leq i, j \leq n}.$$

We will prove the following three identities:

$$(5.9) \quad \sum_{\substack{\alpha_1, \dots, \alpha_{2h+1} \in \mathbb{Z} \\ R_N(\alpha_1) > \dots > R_N(\alpha_{2h+1})}} \det_{1 \leq i, j \leq 2h+1} (e_{\alpha_i + j}(\mathbf{x})) = \text{Pf} \begin{pmatrix} 0 & E \\ -E^t & D_N(2h+1) \end{pmatrix},$$

$$(5.10) \quad \text{Pf} \begin{pmatrix} 0 & E \\ -E^t & D_N(2h+1) \end{pmatrix} = e(\mathbf{x}) \text{Pf}_{1 \leq i, j \leq 2h} (F_{j-i-1, N}(\mathbf{x}) - F_{j-i+1, N}(\mathbf{x})),$$

$$(5.11) \quad \text{Pf}_{1 \leq i, j \leq 2h} (F_{j-i-1, N}(\mathbf{x}) - F_{j-i+1, N}(\mathbf{x})) = \det_{1 \leq i, j \leq h} (F_{-i+j, N}(\mathbf{x}) - F_{i+j, N}(\mathbf{x})).$$

It is obvious that (5.9)–(5.11) together yield Proposition 5.5, as desired.

In the remainder of this subsection, we provide the proofs of (5.9)–(5.11).

Proof of (5.9). By taking the transpose we may rewrite the left-hand side of (5.9) as (5.12)

$$\sum_{N > r_1 > \dots > r_{2h+1} \geq 0} \sum_{k_1, \dots, k_{2h+1} \in \mathbb{Z}} \det_{1 \leq i, j \leq 2h+1} (e_{k_j N + r_j + i}(\mathbf{x})) = \sum_{1 \leq r_1 < \dots < r_{2h+1} \leq N} (-1)^{\binom{2h+1}{2}} \det_{1 \leq i, j \leq 2h+1} \left(\sum_{k \in \mathbb{Z}} e_{kN + i + r_j - 1}(\mathbf{x}) \right).$$

Let $M = (M_{i,j})_{1 \leq i \leq 2h+1, 1 \leq j \leq N}$ be the matrix whose (i, j) -entry is $M_{i,j} = \sum_{k \in \mathbb{Z}} e_{kN + i + j - 1}(\mathbf{x})$. Note that, for $1 \leq j \leq 2h+1$, we have

$$\sum_{1 \leq r \leq N} M_{j,r} = \sum_{1 \leq r \leq N} \sum_{k \in \mathbb{Z}} e_{kN + r + j - 1}(\mathbf{x}) = \sum_{\ell \in \mathbb{Z}} e_{\ell}(\mathbf{x}) = e(\mathbf{x}),$$

and, for $1 \leq i < j \leq 2h+1$,

$$\begin{aligned} \sum_{1 \leq r < s \leq N} (M_{i,r} M_{j,s} - M_{i,s} M_{j,r}) &= \sum_{1 \leq r < s \leq N} \sum_{k, \ell \in \mathbb{Z}} (e_{kN + i + r - 1}(\mathbf{x}) e_{\ell N + j + s - 1}(\mathbf{x}) - e_{kN + i + s - 1}(\mathbf{x}) e_{\ell N + j + r - 1}(\mathbf{x})) \\ &= -d_N(i, j). \end{aligned}$$

Thus, by the minor summation formula in Corollary 4.3(2) with $n = 2h+1$ and $p = N$, the right-hand side of (5.12) equals

$$(-1)^h \text{Pf} \begin{pmatrix} 0 & E \\ -E^t & -D_N(2h+1) \end{pmatrix} = \text{Pf} \begin{pmatrix} 0 & E \\ -E^t & D_N(2h+1) \end{pmatrix},$$

as desired. \square

Proof of (5.10). Let A be the matrix on the left-hand side of (5.10). In the matrix A subtract row/column $i-1$ from row/column i for $i = 2h+2, 2h+1, \dots, 2$. Then the resulting matrix is of the form

$$\begin{pmatrix} 0 & e(\mathbf{x}) & 0 \\ -e(\mathbf{x}) & * & * \\ 0 & * & B \end{pmatrix},$$

where $B = (B_{i,j})_{1 \leq i, j \leq 2h}$ is the matrix whose (i, j) -entry is

$$B_{i,j} = d_N(i, j) - d_N(i-1, j) - d_N(i, j-1) + d_N(i-1, j-1).$$

Since $\text{Pf } A = e(\mathbf{x}) \text{Pf } B$, it remains to show that $B_{i,j} = F_{j-i-1, N}(\mathbf{x}) - F_{j-i+1, N}(\mathbf{x})$.

We claim that

$$(5.13) \quad d_N(i, j) - d_N(i-1, j) = 2 \sum_{m, n \in \mathbb{Z}} \chi[R_N(m-i) = N-1] e_m(\mathbf{x}) e_n(\mathbf{x}) - F_{j-i, N}(\mathbf{x}) - F_{j-i+1, N}(\mathbf{x}).$$

To prove the claim note that $d_N(i, j) - d_N(i-1, j) = P - Q$, where

$$P = \sum_{m, n \in \mathbb{Z}} (\chi[R_N(m-i) > R_N(n-j)] - \chi[R_N(m-i+1) > R_N(n-j)]) e_m(\mathbf{x}) e_n(\mathbf{x}),$$

$$Q = \sum_{m, n \in \mathbb{Z}} (\chi[R_N(m-i) < R_N(n-j)] - \chi[R_N(m-i+1) < R_N(n-j)]) e_m(\mathbf{x}) e_n(\mathbf{x}).$$

One can easily check that the coefficient of $e_m(\mathbf{x}) e_n(\mathbf{x})$ in P is equal to

$$\begin{aligned} \chi[R_N(m-i) = N-1 \neq R_N(n-j)] - \chi[R_N(m-i) = R_N(n-j) \neq N-1] \\ = \chi[R_N(m-i) = N-1] - \chi[R_N(m-i) = R_N(n-j)]. \end{aligned}$$

Thus, we have

$$P = \sum_{m,n \in \mathbb{Z}} \chi[R_N(m-i) = N-1] e_m(\mathbf{x}) e_n(\mathbf{x}) - \sum_{m,n \in \mathbb{Z}} \chi[R_N(m-i) = R_N(n-j)] e_m(\mathbf{x}) e_n(\mathbf{x}),$$

and similarly,

$$Q = \sum_{m,n \in \mathbb{Z}} \chi[R_N(m-i+1) = R_N(n-j)] e_m(\mathbf{x}) e_n(\mathbf{x}) - \sum_{m,n \in \mathbb{Z}} \chi[R_N(m-i) = N-1] e_m(\mathbf{x}) e_n(\mathbf{x}).$$

Since

$$\sum_{m,n \in \mathbb{Z}} \chi[R_N(m-i) = R_N(n-j)] e_m(\mathbf{x}) e_n(\mathbf{x}) = \sum_{m \in \mathbb{Z}} \sum_{k \in \mathbb{Z}} e_m(\mathbf{x}) e_{kN+m+j-i}(\mathbf{x}) = \sum_{k \in \mathbb{Z}} f_{kN+j-i}(\mathbf{x}) = F_{j-i,N}(\mathbf{x}),$$

$P - Q$ is equal to the right-hand side of (5.13), and we obtain the claim.

By (5.13) we have

$$B_{i,j} = (-F_{j-i,N}(\mathbf{x}) - F_{j-i+1,N}(\mathbf{x})) - (-F_{j-i-1,N}(\mathbf{x}) - F_{j-i,N}(\mathbf{x})) = F_{j-i-1,N}(\mathbf{x}) - F_{j-i+1,N}(\mathbf{x}),$$

and the proof is completed. \square

Proof of (5.11). If $z_i = F_{i-1,N}(\mathbf{x}) - F_{i+1,N}(\mathbf{x})$, then

$$z_{|j-l+1} + z_{|j-l+3} + \cdots + z_{i+j-1} = F_{|j-l,N}(\mathbf{x}) - F_{i+j,N}(\mathbf{x}) = F_{j-i,N}(\mathbf{x}) - F_{i+j,N}(\mathbf{x}).$$

Thus (5.11) follows from Lemma 4.4. \square

As pointed out before the statement of Proposition 5.5, with this proposition being established, the identity (3.1) follows.

5.2. Proof of Proposition 5.6. Let h and N be nonnegative integers satisfying $N > 2h$. For two integers i and j , we define

$$\bar{d}_N(i, j) = \sum_{\substack{m,n \in \mathbb{Z} \\ R_N(m-i) > R_N(n-j)}} (-1)^{\lfloor (m-i)/N \rfloor + \lfloor (n-j)/N \rfloor} e_m(\mathbf{x}) e_n(\mathbf{x}) - \sum_{\substack{m,n \in \mathbb{Z} \\ R_N(m-i) < R_N(n-j)}} (-1)^{\lfloor (m-i)/N \rfloor + \lfloor (n-j)/N \rfloor} e_m(\mathbf{x}) e_n(\mathbf{x}).$$

By definition, $\bar{d}_N(j, i) = -\bar{d}_N(i, j)$ and $\bar{d}_N(i, i) = 0$.

We will prove the following three identities:

$$(5.14) \quad \sum_{\substack{\alpha_1, \dots, \alpha_{2h} \in \mathbb{Z} \\ R_N(\alpha_1) > \cdots > R_N(\alpha_{2h})}} (-1)^{\sum_{i=1}^{2h} \lfloor \alpha_i/N \rfloor} \det_{1 \leq i, j \leq 2h} (e_{\alpha_i + j}(\mathbf{x})) = \text{Pf}_{1 \leq i, j \leq 2h} (\bar{d}_N(i, j)),$$

$$(5.15) \quad \text{Pf}_{1 \leq i, j \leq 2h} (\bar{d}_N(i, j)) = \text{Pf}_{1 \leq i, j \leq 2h} \left(\sum_{r=-j+i+1}^{j-i} \bar{F}_{r,N}(\mathbf{x}) \right),$$

$$(5.16) \quad \text{Pf}_{1 \leq i, j \leq 2h} \left(\sum_{r=-j+i+1}^{j-i} \bar{F}_{r,N}(\mathbf{x}) \right) = \det_{1 \leq i, j \leq h} (\bar{F}_{j-i,N}(\mathbf{x}) + \bar{F}_{i+j-1,N}(\mathbf{x})).$$

It is obvious that (5.14)–(5.16) together yield Proposition 5.6, as desired.

In the remainder of this subsection, we provide the proofs of (5.14)–(5.16).

Proof of (5.14). We rewrite the left-hand side of (5.14) as

$$\sum_{N > r_1 > \cdots > r_{2h} \geq 0} \det_{1 \leq i, j \leq 2h} \left(\sum_{k \in \mathbb{Z}} (-1)^k e_{kN+r_j+i}(\mathbf{x}) \right) = \sum_{1 \leq r_1 < \cdots < r_{2h} \leq N} (-1)^{\binom{2h}{2}} \det_{1 \leq i, j \leq 2h} \left(\sum_{k \in \mathbb{Z}} (-1)^k e_{kN+i+r_j-1}(\mathbf{x}) \right).$$

Then, as in the proof of (5.9), we obtain (5.14) using the minor summation formula in Corollary 4.3(1) with $n = 2h$, $p = N$, and $M_{i,j} = \sum_{k \in \mathbb{Z}} (-1)^k e_{kN+i+j-1}(\mathbf{x})$. \square

Proof of (5.15). We claim that, for any integers $i, j \in \mathbb{Z}$ with $i \leq j$, we have

$$\bar{d}_N(i, j) = \sum_{r=-j+i+1}^{j-i} \bar{F}_{r,N}(\mathbf{x}) = \sum_{r \in \mathbb{Z}: r \leq j-i} \bar{F}_{r,N}(\mathbf{x}) - \sum_{r \in \mathbb{Z}: r \leq i-j} \bar{F}_{r,N}(\mathbf{x}).$$

Clearly, this would establish (5.15).

If $j = i$, then both sides of the equation are equal to zero. Thus, by induction on $j - i$, it suffices to show that, for $i < j$, we have

$$\bar{d}_N(i, j) - \bar{d}_N(i, j-1) = \bar{F}_{-j+i+1,N}(\mathbf{x}) + \bar{F}_{j-i,N}(\mathbf{x}) = \bar{F}_{j-i-1,N}(\mathbf{x}) + \bar{F}_{j-i,N}(\mathbf{x}).$$

Using the definition of $\bar{d}_N(i, j)$, we have

$$\bar{d}_N(i, j) - \bar{d}_N(i, j-1) = \sum_{m,n \in \mathbb{Z}} (-1)^{\lfloor (m-i)/N \rfloor + \lfloor (n-j)/N \rfloor} a_{m,n}(i, j) e_m(\mathbf{x}) e_n(\mathbf{x}),$$

where

$$\begin{aligned} a_{m,n}(i, j) &= \chi[R_N(m-i) > R_N(n-j)] - \chi[R_N(m-i) < R_N(n-j)] \\ &\quad - (-1)^{\chi[R_N(n-j)=N-1]} \left(\chi[R_N(m-i) > R_N(n-j+1)] - \chi[R_N(m-i) < R_N(n-j+1)] \right). \end{aligned}$$

On the other hand, we have

$$\begin{aligned} \bar{F}_{j-i,N}(\mathbf{x}) &= \sum_{k \in \mathbb{Z}} (-1)^k f_{kN+j-i}(\mathbf{x}) = \sum_{k \in \mathbb{Z}} (-1)^k \sum_{m \in \mathbb{Z}} e_m(\mathbf{x}) e_{m+kN+j-i}(\mathbf{x}) \\ &= \sum_{m,n \in \mathbb{Z}} (-1)^{(n-m-j+i)/N} \chi[R_N(m-i) = R_N(n-j)] e_m(\mathbf{x}) e_n(\mathbf{x}). \end{aligned}$$

Note that, if $R_N(m-i) = R_N(n-j)$, then

$$(-1)^{(n-m-j+i)/N} = (-1)^{((n-j)-(m-i))/N} = (-1)^{\lfloor (n-j)/N \rfloor - \lfloor (m-i)/N \rfloor} = (-1)^{\lfloor (m-i)/N \rfloor + \lfloor (n-j)/N \rfloor}.$$

Thus,

$$\bar{F}_{j-i-1,N}(\mathbf{x}) + \bar{F}_{j-i,N}(\mathbf{x}) = \sum_{m,n \in \mathbb{Z}} (-1)^{\lfloor (m-i)/N \rfloor + \lfloor (n-j)/N \rfloor} b_{m,n}(i, j) e_m(\mathbf{x}) e_n(\mathbf{x}),$$

where

$$b_{m,n}(i, j) = \chi[R_N(m-i) = R_N(n-j)] + (-1)^{\chi[R_N(n-j)=N-1]} \chi[R_N(m-i) = R_N(n-j+1)].$$

By considering the two cases $R_N(n-j) = N-1$ and $R_N(n-j) \neq N-1$ separately, one can easily check that $a_{m,n}(i, j) = b_{m,n}(i, j)$ for all $m, n \in \mathbb{Z}$, which proves (5.15). \square

Proof of (5.16). Let $z_i = \sum_{r \leq i} \bar{F}_{r,N}(\mathbf{x}) - \sum_{r \leq -i} \bar{F}_{r,N}(\mathbf{x})$. Then, by (5.15) and (4.2), we have

$$\text{Pf}_{1 \leq i, j \leq 2h}(\bar{d}_N(i, j)) = \text{Pf}_{1 \leq i, j \leq 2h}(z_{j-i}) = \det_{1 \leq i, j \leq h} \left(\sum_{s=0}^{2 \min(i,j)-2} (-1)^s (z_{i+j-1-s} - z_{i+j-2-s}) \right).$$

Using the fact $z_i - z_{i-1} = \bar{F}_{i,N}(\mathbf{x}) + \bar{F}_{-i+1,N}(\mathbf{x}) = \bar{F}_{i,N}(\mathbf{x}) + \bar{F}_{i-1,N}(\mathbf{x})$, we see that the above determinant equals

$$\det_{1 \leq i, j \leq h} (\bar{F}_{j-i,N}(\mathbf{x}) + \bar{F}_{i+j-1,N}(\mathbf{x})),$$

as desired. \square

As pointed out before the statement of Proposition 5.6, with this proposition being established, the identity (3.2) follows.

6. A SYSTEMATIC APPROACH TO AFFINE BOUNDED LITTLEWOOD IDENTITIES

In this section, we develop a general approach to deriving affine bounded Littlewood identities, see Subsection 6.1. It is based on the essentials of the line of argument of the proof of Theorem 3.1 in the previous section. It is however more general as we allow the application of the full minor summation formula of Theorem 4.2, as opposed to “just” its special case in Corollary 4.3 that we used in Section 5. This approach allows us to provide an alternative proof of the affine bounded Littlewood in Theorem 3.1, that is, different from the previous section. Moreover, it also gives us the means to prove the affine bounded Littlewood identities in Theorem 3.3, see Subsection 6.2, as well as the affine bounded Littlewood identities in Theorem 3.4, see Subsection 6.4.

6.1. General framework. Recall that, for positive integers m and w , we denote by $\text{Par}(m, w)$ the set of partitions of length at most m satisfying $\lambda_1 - \lambda_m \leq w$. In this subsection, we consider sums of the form

$$\sum_{\lambda \in \text{Par}(m, w)} \sum_{\substack{k_1, \dots, k_m \in \mathbb{Z} \\ k_1 + \dots + k_m = 0}} u(\lambda) \det_{1 \leq i, j \leq m} \left(e_{\lambda_i - i + j + Nk_i}(\mathbf{x}) \right),$$

where $N = m + w$, and u is a statistic on $\text{Par}(m, w)$, and give Pfaffian formulas for the summations under certain conditions.

Let, as in Definition 2.2, $\text{Par}(m)$ be the set of partitions of length at most m . To such a partition λ , we associate the sequence $I_m(\lambda)$ given by

$$I_m(\lambda) = (\lambda_m + 1, \lambda_{m-1} + 2, \dots, \lambda_1 + m).$$

Then the correspondence $\lambda \mapsto I_m(\lambda) = (i_1, \dots, i_m)$ gives a bijection between $\text{Par}(m)$ and the set of increasing sequences of positive integers of length m , and $\lambda \in \text{Par}(m, w)$ if and only if $i_1 < \dots < i_m < i_1 + N$.

Recall the notation in Definition 4.1. For brevity we also define $A^K := A_K^K$. Recall that $R_N(t)$ is the remainder of t when divided by N so that $0 \leq R_N(t) \leq N - 1$.

Proposition 6.1. *Let m and w be positive integers and put $N = m + w$. Let $u : \text{Par}(m, w) \rightarrow \mathbb{Z}$ be a statistic on $\text{Par}(m, w)$. Let p be a nonnegative integer such that $p + m$ is even. Suppose that A is a skew-symmetric matrix with rows/columns indexed by the totally ordered set $\{0_1 < 0_2 < \dots < 0_p < 1 < 2 < \dots\}$ satisfying the following three conditions:*

(i) *For $\lambda \in \text{Par}(m, w)$, we have*

$$\text{Pf } A^{I_0 \sqcup I_m(\lambda)} = u(\lambda),$$

where $I_0 = (0_1, 0_2, \dots, 0_p)$.

(ii) *For an increasing sequence (i_1, \dots, i_m) of positive integers with $i_m - i_1 > N$, we have*

$$\text{Pf } A^{I_0 \sqcup (i_1 + N, i_2, \dots, i_{m-1}, i_m - N)} = \text{Pf } A^{I_0 \sqcup (i_1, i_2, \dots, i_m)}.$$

(iii) *For an increasing sequence (i_1, \dots, i_m) of positive integers with $i_k \equiv i_\ell \pmod{N}$ for some $k < \ell$, we have*

$$\text{Pf } A^{I_0 \sqcup (i_1, \dots, i_m)} = 0.$$

Then we have

$$\sum_{\lambda \in \text{Par}(m, w)} u(\lambda) s_{\lambda[m, w]'}(\mathbf{x}) = \text{Pf} \left(T_p A T_p^t \right),$$

where T_p is the following matrix with rows indexed by $\{0_1, \dots, 0_p, 1, 2, \dots, m\}$ and columns indexed by $\{0_1, \dots, 0_p, 1, 2, \dots\}$:

$$(6.1) \quad T_p = \begin{pmatrix} \mathbf{I}_p & O \\ O & (e_{j-i}(\mathbf{x}))_{1 \leq i \leq m, j \geq 1} \end{pmatrix}.$$

Here \mathbf{I}_p stands for the identity matrix of size p .

For the proof of the proposition, we need an auxiliary result, which essentially extracts the essence of the proof of Lemma 5.1.

Lemma 6.2. *Let m and w be positive integers and let $N = m + w$. There is a bijection Φ between*

$$X = \{(\lambda, k) \in \text{Par}(m, w) \times \mathbb{Z}^m : k_1 + \dots + k_m = 0, \text{ and } \lambda_i + m - i + Nk_i \geq 0 \text{ for } 1 \leq i \leq m\}$$

and

$$Y = \{\kappa \in \text{Par}(m) : R_N(\kappa_i + m - i), 1 \leq i \leq m, \text{ are distinct}\}$$

such that, if $\Phi(\lambda, k) = \kappa$, then

$$\det_{1 \leq i, j \leq m} (e_{\lambda_i - i + j + Nk_i}(\mathbf{x})) = \text{sgn}(\sigma) \det_{1 \leq i, j \leq m} (e_{\kappa_i - i + j}(\mathbf{x})),$$

where $\sigma \in \mathfrak{S}_m$ is the unique permutation that rearranges the vector $(\lambda_i + m - i + Nk_i)_{1 \leq i \leq m}$ in decreasing order.

Proof. In the proof of Lemma 5.1, it was (implicitly) shown that there is a bijection between the set

$$U = \{(\mu, k) \in \mathbb{Z}^m \times \mathbb{Z}^m : \mu_1 > \dots > \mu_m, \mu_1 - \mu_m < N, \text{ and } k_1 + \dots + k_m = 0\}$$

and the set

$$V' = \{\beta \in \mathbb{Z}^m : R_N(\beta_{t+1}) > \dots > R_N(\beta_m) > R_N(\beta_1) > \dots > R_N(\beta_t) \text{ for some } t \text{ with } 0 \leq t < m\}.$$

More precisely, the bijection is given by $\beta_i = \mu_i + Nk_i$, for $1 \leq i \leq m$.

Now, the set U is in bijection with the set

$$\begin{aligned} X' &= \{(\lambda, k) \in \mathbb{Z}^m \times \mathbb{Z}^m : \lambda_1 \geq \dots \geq \lambda_m, \lambda_1 - \lambda_m \leq w, \text{ and } k_1 + \dots + k_m = 0\} \\ &= \{(\lambda, k) \in \text{Par}(m, w) \times \mathbb{Z}^m : k_1 + \dots + k_m = 0\} \end{aligned}$$

via $\mu_i = \lambda_i + m - i$, for $1 \leq i \leq m$. On the other hand, the set V' is in bijection with the set

$$Y' = \{\gamma \in \mathbb{Z}^m : \gamma_1 > \dots > \gamma_m \text{ and } R_N(\gamma_i), 1 \leq i \leq m, \text{ are distinct}\}.$$

Indeed, to go from V' to Y' , one orders the components of the elements $\beta \in V'$, while, to go from Y' to V' , one orders the remainders $R_N(\gamma_1), \dots, R_N(\gamma_m)$ of an element $\gamma \in Y'$. Furthermore, trivially, the set Y' is in bijection with

$$Y'' = \{\nu \in \mathbb{Z}^m : \nu_1 \geq \dots \geq \nu_m \text{ and } R_N(\nu_i + m - i), 1 \leq i \leq m, \text{ are distinct}\}.$$

The asserted bijection arises from the one described above by restricting X' to X and Y'' to Y . The property that it is claimed to satisfy follows straightforwardly from the construction. \square

We use the above lemma to prove Proposition 6.1.

Proof of Proposition 6.1. We extend the statistic u on $\text{Par}(m, w)$ to $\tilde{u} : \text{Par}(m) \rightarrow \mathbb{Z}$ by

$$\tilde{u}(\kappa) = \begin{cases} \text{sgn}(\sigma)u(\lambda), & \text{if } \kappa \in Y, \\ 0, & \text{otherwise,} \end{cases}$$

where Y is the subset of $\text{Par}(m)$ given in Lemma 6.2 and $\sigma \in \mathfrak{S}_m$ and $\lambda \in \text{Par}(m, w)$ are determined by the bijection of that lemma. It then follows from Theorem 2.8 and Lemma 6.2 that

$$(6.2) \quad \sum_{\lambda \in \text{Par}(m, w)} u(\lambda) s_{\lambda[m, w]'}(\mathbf{x}) = \sum_{\lambda \in \text{Par}(m, w)} \sum_{\substack{k_1, \dots, k_m \in \mathbb{Z} \\ k_1 + \dots + k_m = 0}} u(\lambda) \det_{1 \leq i, j \leq m} (e_{\lambda_i - i + j + Nk_i}(\mathbf{x})) = \sum_{\kappa \in \text{Par}(m)} \tilde{u}(\kappa) \det_{1 \leq i, j \leq m} (e_{\kappa_i - i + j}(\mathbf{x})).$$

We shall show that, for all $\kappa \in \text{Par}(m)$,

$$(6.3) \quad \tilde{u}(\kappa) = \text{Pf } A^{I_0 \sqcup I_m(\kappa)}.$$

We write $I_m(\kappa) = (i_1, \dots, i_m)$. If $\kappa \notin Y$, then $i_p \equiv i_q \pmod{N}$ for some $p < q$. Hence Condition (iii) implies $\text{Pf } A^{I_0 \sqcup I_m(\kappa)} = 0 = \tilde{u}(\kappa)$.

From now on, we assume $\kappa \in Y$ and proceed by induction on $i_m - i_1$. If $i_m - i_1 < N$, then $\kappa \in \text{Par}(m, w)$, and $\tilde{u}(\kappa) = u(\kappa)$. So, by Condition (i), we obtain $\text{Pf } A^{I_0 \sqcup I_m(\kappa)} = \tilde{u}(\kappa)$.

Suppose that $i_m - i_1 > N$. Let (j_1, \dots, j_m) be the rearrangement of $(i_1 + N, i_2, \dots, i_{m-1}, i_m - N)$ in increasing order and $\tau \in \mathfrak{S}_m$ the permutation achieving this rearrangement. Let ι be the partition such that $I_m(\iota) = (j_1, \dots, j_m)$. Then

$$\iota = \tau(\kappa - N\theta + \delta) - \delta,$$

where $\theta = (1, 0, \dots, 0, -1)$ and $\delta = (m-1, m-2, \dots, 1, 0)$. By using Condition (ii) and the alternating property of the Pfaffian, we obtain $\text{Pf } A^{I_0 \sqcup I_m(\kappa)} = \text{sgn}(\tau) \text{Pf } A^{I_0 \sqcup I_m(\iota)}$. Since $j_1 = \min\{i_1 + N, i_2, i_m - N\} > i_1$ and $j_m = \max\{i_1 + N, i_{m-1}, i_m - N\} < i_m$, we see that $j_m - j_1 < i_m - i_1$. By applying the induction hypothesis to ι , we have $\text{Pf } A^{I_0 \sqcup I_m(\iota)} = \text{sgn}(\rho)u(\lambda)$, where $\lambda \in \text{Par}(m, w)$ and $\iota = \rho(\lambda + Nk + \delta) - \delta$. On the other hand, since

$$\begin{aligned} \kappa &= \tau^{-1}(\iota + \delta) + N\theta - \delta \\ &= \tau^{-1}(\rho(\lambda + Nk + \delta)) + N\theta - \delta \\ &= \tau^{-1}\rho(\lambda + N(k + \rho^{-1}\tau\theta) + \delta) - \delta, \end{aligned}$$

we have $\tilde{u}(\kappa) = \text{sgn}(\tau^{-1}\rho)u(\lambda)$, or equivalently $\text{sgn}(\rho)u(\lambda) = \text{sgn}(\tau)\tilde{u}(\kappa)$. Combining these facts, we obtain

$$\text{Pf } A^{I_0 \sqcup I_m(\kappa)} = \text{sgn}(\tau) \text{Pf } A^{I_0 \sqcup I_m(\iota)} = \text{sgn}(\tau) \text{sgn}(\rho)u(\lambda) = \text{sgn}(\tau) \text{sgn}(\tau)\tilde{u}(\kappa) = \tilde{u}(\kappa),$$

which completes the proof of (6.3).

Now, by (6.2) and (6.3), we have

$$\sum_{\lambda \in \text{Par}(m, w)} u(\lambda) s_{\lambda[m, w]'}(\mathbf{x}) = \sum_{\kappa \in \text{Par}(m)} \text{Pf } A^{I_0 \sqcup I_m(\kappa)} \det_{1 \leq i, j \leq m} (e_{\kappa_i - i + j}(\mathbf{x})).$$

For an increasing subsequence K of $I_0 \sqcup (1, 2, \dots)$ of length $p + m$, we have

$$\det(T_p)_K^{[m]} = \begin{cases} \det_{1 \leq i, j \leq m} (e_{\kappa_i - i + j}(\mathbf{x})), & \text{if } K = I_0 \sqcup I_m(\kappa) \text{ for some } \kappa \in \text{Par}(m), \\ 0, & \text{otherwise.} \end{cases}$$

Hence we have

$$\sum_{\lambda \in \text{Par}(m, w)} u(\lambda) s_{\lambda[m, w]'}(\mathbf{x}) = \sum_K \text{Pf } A^K \det(T_p)_K^{[m]},$$

where K runs over all increasing subsequences of $I_0 \sqcup (1, 2, \dots)$ of length $p + m$. The desired result follows from the minor summation formula in Theorem 4.2. \square

6.2. Proof of Theorem 3.1. We apply Proposition 6.1 to prove Theorem 3.1. For that purpose, we introduce a skew-symmetric matrix A that satisfies the conditions in Proposition 6.1 with the statistic u being equal to the statistic b defined by $b(\lambda) = 1$ for all $\lambda \in \text{Par}(m, w)$.

Lemma 6.3. *Let m and w be positive integers and put $N = m + w$.*

(1) *Suppose that $m = 2h + 1$ is odd. Let β_ℓ , $\ell \in \mathbb{Z}$, be the sequence defined by*

$$\beta_\ell = \begin{cases} 2k + 1, & \text{if } \ell = kN + r, \text{ where } k, r \in \mathbb{Z} \text{ and } 0 < r < N, \\ 2k, & \text{if } \ell = kN, \text{ where } k \in \mathbb{Z}, \end{cases}$$

and $B = (B_{r,s})$ the skew-symmetric matrix with rows/columns indexed by nonnegative integers whose (r, s) -entry, $0 \leq r < s$, is given by

$$B_{r,s} = \begin{cases} 1, & \text{if } r = 0, \\ \beta_{s-r}, & \text{if } r \geq 1. \end{cases}$$

Then B satisfies the three conditions in Proposition 6.1 for $u = b$ and $p = 1$.

(2) *Suppose that $m = 2h$ is even. Let $\bar{\beta}_\ell$, $\ell \in \mathbb{Z}$, be the sequence defined by*

$$\bar{\beta}_\ell = \begin{cases} (-1)^k, & \text{if } \ell = kN + r, \text{ where } k, r \in \mathbb{Z} \text{ and } 0 < r < N, \\ 0, & \text{if } \ell = kN, \text{ where } k \in \mathbb{Z}, \end{cases}$$

and $\bar{B} = (\bar{B}_{r,s})$ the skew-symmetric matrix with rows/columns indexed by positive integers whose (r, s) -entry is given by $\bar{B}_{r,s} = \bar{\beta}_{s-r}$. Then \bar{B} satisfies the three conditions in Proposition 6.1 for $u = b$ and $p = 0$.

Proof. Let $I = (i_1, \dots, i_m)$ be an increasing sequence of positive integers.

(1) For Condition (i) of Proposition 6.1, it suffices to show that, if $i_m - i_1 < N$, then $\text{Pf } B^{(0)\sqcup I} = 1$. Since $i_m - i_1 < N$ implies that $0 < i_\ell - i_k < N$ for any k and ℓ with $1 \leq k < \ell \leq m$, we see that $B^{(0)\sqcup I}$ is the skew-symmetric matrix with all 1's above the diagonal. So we have $\text{Pf } B^{(0)\sqcup I} = 1$. For the second condition, Condition (ii), suppose that $i_m - i_1 > N$ and let $J = (i_1 + N, i_2, \dots, i_{m-1}, i_m - N)$. By noting $\beta_{\ell+N} = \beta_\ell + 2$, for $1 \leq r < s$ we have

$$B_{r+N,s} = B_{r,s} - 2, \quad B_{r+N,s-N} = B_{r,s} - 4, \quad B_{r,s-N} = B_{r,s} - 2.$$

Hence the matrix $B^{(0)\sqcup J}$ is obtained from $B^{(0)\sqcup I}$ by adding the 0-th row/column multiplied by -2 to the first row/column and adding the 0-th row/column multiplied by 2 to the n -th row/column. These operations do not change the value of the Pfaffian. Hence we have $\text{Pf } B^{(0)\sqcup I} = \text{Pf } B^{(0)\sqcup J}$. For the third condition, Condition (iii), suppose $i_\ell - i_k = cN$. Since $B_{r+cN,s} = B_{r,s} - 2c$, we see that the 0-th, k -th and ℓ -th rows of $B^{(0)\sqcup I}$ are linearly dependent, so we have $\text{Pf } B^{(0)\sqcup I} = 0$.

(2) Condition (i) of Proposition 6.1 can be proved similarly as in (1). For Condition (ii), suppose $i_m - i_1 > N$ and $J = (i_1 + N, i_2, \dots, i_{m-1}, i_m - N)$. Since $\bar{\beta}_{\ell+N} = -\bar{\beta}_\ell$, we have

$$\bar{B}_{r+N,s} = -\bar{B}_{r,s}, \quad \bar{B}_{r+N,s-N} = \bar{B}_{r,s}, \quad \bar{B}_{r,s-N} = -\bar{B}_{r,s}.$$

Hence, by multiplying the first row/column of \bar{B}^J by -1 and the m -th row/column by -1 , we obtain $\text{Pf } \bar{B}^J = (-1)^2 \text{Pf } \bar{B}^I = \text{Pf } \bar{B}^I$. For the last condition, Condition (iii), suppose $i_\ell - i_k = cN$. Since $\bar{B}_{r+cN,s} = (-1)^c \bar{B}_{r,s}$, we see that the k -th and ℓ -th rows of \bar{B}^I are proportional to each other, hence we have $\text{Pf } \bar{B}^I = 0$. \square

We are now ready for the proof of Theorem 3.1. We start with the second identity in the theorem.

Proof of (3.2). Here $m = 2h$ is even. By applying Proposition 6.1 to the statistic $b(\lambda) = 1$, for $\lambda \in \text{Par}(m, w)$, and the skew-symmetric matrix \bar{B} given in Lemma 6.3(2), we get

$$\sum_{\lambda \in \text{Par}(2h, w)} s_{\lambda[2h, w]'}(\mathbf{x}) = \text{Pf}(T_0 \bar{B} T_0^t),$$

where $T_0 = (e_{j-i}(\mathbf{x}))_{1 \leq i \leq m, j \geq 1}$ as given in (6.1) with $p = 0$. The (i, j) -entry of $T_0 \bar{B} T_0^t$ equals

$$\sum_{r, s \geq 1} e_{r-i}(\mathbf{x}) \bar{\beta}_{s-r} e_{s-j}(\mathbf{x}) = \sum_{\ell \in \mathbb{Z}} \bar{\beta}_\ell f_{\ell-j+i}(\mathbf{x}).$$

If we put $z_r = \sum_{\ell \in \mathbb{Z}} \bar{\beta}_\ell f_{\ell-r}(\mathbf{x})$, then we have

$$\sum_{\lambda \in \text{Par}(2h, w)} s_{\lambda[2h, w]'}(\mathbf{x}) = \text{Pf}_{1 \leq i < j \leq m} (z_{j-i}) = \det_{1 \leq i, j \leq h} \left(\sum_{s=0}^{2 \min(i, j)-2} (-1)^s (z_{i+j-1-s} - z_{i+j-2-s}) \right),$$

where the last equality follows from (4.2). Since we have

$$\bar{\beta}_\ell - \bar{\beta}_{\ell-1} = \begin{cases} (-1)^k, & \text{if } \ell = Nk \text{ or } Nk + 1, \\ 0, & \text{otherwise,} \end{cases}$$

we obtain

$$(6.4) \quad z_r - z_{r-1} = \sum_{\ell \in \mathbb{Z}} (\bar{\beta}_\ell - \bar{\beta}_{\ell-1}) f_{\ell-r}(\mathbf{x}) = \sum_{k \in \mathbb{Z}} (-1)^k (f_{kN-r}(\mathbf{x}) + f_{kN+1-r}(\mathbf{x})) \\ = \bar{F}_{-r, N}(\mathbf{x}) + \bar{F}_{1-r, N}(\mathbf{x}) = \bar{F}_{r, N}(\mathbf{x}) + \bar{F}_{r-1, N}(\mathbf{x}).$$

Thus,

$$\sum_{s=0}^{2 \min(i, j)-2} (-1)^s (z_{i+j-1-s} - z_{i+j-2-s}) = \bar{F}_{i+j-1, N}(\mathbf{x}) + \bar{F}_{|i-j|, N}(\mathbf{x}) = \bar{F}_{i+j-1, N}(\mathbf{x}) + \bar{F}_{j-i, N}(\mathbf{x}).$$

This completes the proof of (3.2). \square

Next we prove the first identity in Theorem 3.1.

Proof of (3.1). Here $m = 2h + 1$ is odd. By applying Proposition 6.1 to the skew-symmetric matrix B given in Lemma 6.3(1), we get

$$\sum_{\lambda \in \text{Par}(2h+1, w)} s_{\lambda[2h+1, w]'}(\mathbf{x}) = \text{Pf}(T_1 B T_1^t),$$

where T_1 is given by (6.1) with $p = 1$. If we put $e(\mathbf{x}) = \sum_{i \geq 0} e_i(\mathbf{x})$, as before in (3.11), and $w_r = \sum_{\ell \in \mathbb{Z}} \beta_\ell f_{\ell-r}(\mathbf{x})$, then the (i, j) -entry $Q_{i, j}$, $0 \leq i < j \leq m$, of $Q := T_1 B T_1^t$ is given by

$$Q_{i, j} = \begin{cases} e(\mathbf{x}), & \text{if } i = 0, \\ w_{j-i}, & \text{if } i \geq 1. \end{cases}$$

By subtracting the $(i-1)$ -st row/column from the i -th row/column for $i = m, m-1, \dots, 2$, and then expanding the resulting Pfaffian along the 0-th row/column, we obtain

$$\text{Pf } Q = \text{Pf}(T_1 B T_1^t) = e(\mathbf{x}) \cdot \text{Pf}_{2 \leq i < j \leq n} (w_{j-i} - w_{j-i-1} - w_{j-i+1} + w_{j-i}).$$

Since we have

$$\beta_\ell - \beta_{\ell-1} = \begin{cases} 1, & \text{if } R_N(\ell) = 0 \text{ or } 1, \\ 0, & \text{otherwise,} \end{cases}$$

by a similar computation as in (6.4) we get $w_r - w_{r-1} = F_{r,N}(\mathbf{x}) + F_{r-1,N}(\mathbf{x})$ and $w_r - w_{r-1} - w_{r+1} + w_r = F_{r-1,N}(\mathbf{x}) - F_{r+1,N}(\mathbf{x})$. Now, by using (4.1) with $z_r = F_{r-1,N}(\mathbf{x}) - F_{r+1,N}(\mathbf{x})$, we complete the proof of (3.1). \square

6.3. Proof of Theorem 3.3. In this subsection, we prove the affine bounded Littlewood identities in Theorem 3.3. The idea of the proof is the same as that of the proof of Theorem 3.1, so we shall only provide a sketch.

The following lemma gives a skew-symmetric matrix that satisfies the conditions in Proposition 6.1 for $u = c_{2h,w}^\pm$, given by (3.4).

Lemma 6.4. *Let $m = 2h$ be a positive even integer and w a positive integer, and put $N = 2h + w$. We define the sequences γ_ℓ^+ and γ_ℓ^- , $\ell \in \mathbb{Z}$, by*

$$\gamma_\ell^+ = \begin{cases} (-1)^k, & \text{if } \ell = kN + 1 \text{ or } kN + (N - 1), \text{ where } k \in \mathbb{Z}, \\ 0, & \text{otherwise,} \end{cases}$$

$$\gamma_\ell^- = \begin{cases} 1, & \text{if } \ell = kN + 1, \text{ where } k \in \mathbb{Z}, \\ -1, & \text{if } \ell = kN + (N - 1), \text{ where } k \in \mathbb{Z}, \\ 0, & \text{otherwise.} \end{cases}$$

Let $C^+ = (C_{r,s}^+)$ (respectively $C^- = (C_{r,s}^-)$) be the skew-symmetric matrix with rows/columns indexed by positive integers whose (r, s) -entry, $r < s$, is given by $C_{r,s}^+ = \gamma_{s-r}^+$ (respectively by $C_{r,s}^- = \gamma_{s-r}^-$). Then the matrix C^+ (respectively C^-) satisfies the conditions in Proposition 6.1 for $u = c_{m,w}^+$ (respectively $u = c_{m,w}^-$) and $p = 0$.

Proof. We only prove the first part, namely $\text{Pf}(C^\pm)^{I_m(\lambda)} = c_{m,w}^\pm(\lambda)$ for $\lambda \in \text{Par}(m, w)$. (Since $\gamma_{\ell+N}^+ = -\gamma_\ell^+$ and $\gamma_{\ell+N}^- = \gamma_\ell^-$, the other parts can be proved in exactly the same way as in the proof of Lemma 6.3(1).)

Let $M^\pm = (m_{i,j}^\pm)_{1 \leq i, j \leq N}$ be the skew-symmetric matrix with entries given by

$$m_{i,j}^\pm = \begin{cases} 1, & \text{if } j = i + 1, \\ \pm 1, & \text{if } i = 1 \text{ and } j = N, \\ 0, & \text{otherwise.} \end{cases}$$

Then we have $(C^\pm)^{I_m(\lambda)} = (M^\pm)^{I_m(\lambda^0)}$, where $\lambda^0 = (\lambda_1 - \lambda_m, \lambda_2 - \lambda_m, \dots, \lambda_{m-1} - \lambda_m, 0)$. By using [31, Lem. 3.4(3)], we obtain $\text{Pf}(C^\pm)^{I_m(\lambda)} = c_{m,w}^\pm(\lambda)$. \square

Proof of Theorem 3.3. By Proposition 6.1 and Lemma 6.4 with $m = 2h$ and $N = 2h + w$, we obtain

$$\sum_{\lambda \in \text{Par}(2h,w)} c_{m,w}^\pm(\lambda) s_{\lambda[2h,w]}(\mathbf{x}) = \text{Pf}(T_0 C^\pm T_0^t) = \text{Pf}_{1 \leq i < j \leq 2h} (v_{j-i}^\pm),$$

where $v_r^+ = \overline{F}_{r-1,N}(\mathbf{x}) - \overline{F}_{r+1,N}(\mathbf{x})$ and $v_r^- = F_{r-1,N}(\mathbf{x}) - F_{r+1,N}(\mathbf{x})$. Then the proof is completed by applying (4.1). \square

6.4. Proof of Theorem 3.4. Again, we only provide a sketch here since the idea of the proof is the same as that of the proof of Theorem 3.1. Recall that the statistics $d_{m,w}^+$ and $d_{m,w}^-$ on $\text{Par}(m, w)$ (see (3.12)) are given by

$$d_{m,w}^\pm(\lambda) = \begin{cases} 1, & \text{if } \lambda \text{ is even,} \\ \pm 1, & \text{if } \lambda \text{ is odd,} \\ 0, & \text{otherwise,} \end{cases}$$

where, as earlier in Section 3, a partition λ is called *even* (respectively *odd*) if all its parts $\lambda_1, \dots, \lambda_m$ are even (respectively odd).

Lemma 6.5. *Let m be a positive integer and w a positive even integer, and put $N = m + w$.*

- (1) *Suppose that $m = 2h$ is even and define a sequence δ_ℓ^+ , $\ell \in \mathbb{Z}$, by*

$$\delta_\ell^+ = \begin{cases} (-1)^k, & \text{if } \ell \text{ is odd and } \ell = kN + r, \text{ where } k, r \in \mathbb{Z} \text{ and } 0 < r < N, \\ 0, & \text{if } \ell \text{ is even.} \end{cases}$$

Let $D^+ = (D_{r,s}^+)$ be the skew-symmetric matrix with rows/columns indexed by $\{1, 2, \dots\}$ whose (r, s) -entry is given by $D_{r,s}^+ = \delta_{s-r}^+$. Then D^+ satisfies the conditions of Proposition 6.1 for $u = 2^{h-1} \cdot d_{2h,w}^+$ and $p = 0$.

- (2) *Suppose that $m = 2h$ is even and define a sequence δ_ℓ^- , $\ell \in \mathbb{Z}$, by*

$$\delta_\ell^- = \begin{cases} 2k + 1, & \text{if } \ell \text{ is odd and } \ell = kN + r, \text{ where } k, r \in \mathbb{Z} \text{ and } 0 < r < N, \\ 0, & \text{if } \ell \text{ is even.} \end{cases}$$

Let $D^- = (D_{r,s}^-)$ be the skew-symmetric matrix with rows/columns indexed by $\{0, 0', 1, 2, \dots\}$ whose entries are given by

$$D_{0,0'}^- = 0, \quad D_{0,s}^- = 1, \quad D_{0',s}^- = (-1)^{s-1}, \quad D_{r,s}^- = \delta_{s-r}^-,$$

where $r, s \geq 1$. Then D^- satisfies the conditions of Proposition 6.1 for $u = 2^h \cdot d_{2h,w}^-$ and $p = 2$.

- (3) *Suppose that $m = 2h + 1$ is odd and define a sequence δ_ℓ^+ , $\ell \in \mathbb{Z}$, by*

$$\delta_\ell^+ = \begin{cases} kN' + \lceil r/2 \rceil, & \text{if } \ell = kN + r, \text{ where } k, r \in \mathbb{Z} \text{ and } 0 < r < N, \\ kN', & \text{if } \ell = kN, \text{ where } k \in \mathbb{Z}, \end{cases}$$

where $N' = (N + 1)/2$ and $\lceil x \rceil$ is the smallest integer greater than or equal to x . Let $D^+ = (D_{r,s}^+)$ be the skew-symmetric matrix with rows/columns indexed by $\{0, 1, 2, \dots\}$ whose entries are given by

$$D_{0,s}^+ = 1, \quad D_{r,s}^+ = \delta_{s-r}^+,$$

where $r, s \geq 1$. Then D^+ satisfies the conditions of Proposition 6.1 for $u = d_{2h+1,w}^+$ and $p = 1$.

- (4) *Suppose that $m = 2h + 1$ is odd and define a sequence δ_ℓ^- , $\ell \in \mathbb{Z}$, by*

$$\delta_\ell^- = (-1)^{\ell+1} \delta_\ell^+ = \begin{cases} (-1)^{\ell+1} (kN' + \lceil r/2 \rceil), & \text{if } \ell = kN + r, \text{ where } k, r \in \mathbb{Z} \text{ and } 0 < r < N, \\ (-1)^{\ell+1} kN', & \text{if } \ell = kN, \text{ where } k \in \mathbb{Z}. \end{cases}$$

Let $D^- = (D_{r,s}^-)$ be the skew-symmetric matrix with rows/columns indexed by $\{0, 1, 2, \dots\}$ whose entries are given by

$$D_{0,s}^- = (-1)^{s-1}, \quad D_{r,s}^- = \delta_{s-r}^-,$$

where $r, s \geq 1$. Then D^- satisfies the conditions of Proposition 6.1 for $u = d_{2h+1,w}^-$ and $p = 1$.

For example, if $N = 7$, then the sequences δ^+ and δ^- defined in (3) and (4) are the following:

ℓ	...	-9	-8	-7	-6	-5	-4	-3	-2	-1	0	1	2	3	4	5	6	7	8	9	10	...
δ_ℓ^+	...	-5	-5	-4	-3	-3	-2	-2	-1	-1	0	1	1	2	2	3	3	4	5	5	6	...
δ_ℓ^-	...	-5	5	-4	3	-3	2	-2	1	-1	0	1	-1	2	-2	3	-3	4	-5	5	-6	...

Proof. (1) We only show that $\text{Pf}(D^+)^{I_m(\lambda)} = d_{m,w}^+(\lambda)$ if $\lambda \in \text{Par}(m, w)$. (Since $\delta_{\ell+N}^+ = -\delta_\ell^+$, the proof of the other parts is the same as in the proof of Lemma 6.3(1).) If λ is neither even nor odd, then there is an index k such that $i_k \equiv i_{k+1} \pmod{2}$, where $I_m(\lambda) = (i_1, \dots, i_m)$. In that case, we see that the k -th row of $D_{I_m(\lambda)}^+$ is the same as the $(k+1)$ -st row, hence we have $\text{Pf}(D^+)^{I_m(\lambda)} = 0$. If λ is even or odd, then the (i, j) -entry, $i < j$, of

$(D^+)^{I_m(\lambda)}$ is equal to 1 if $j-i \equiv 1 \pmod 2$ and 0 otherwise. By performing elementary row/column operations and using the expansion of the Pfaffian, we obtain $\text{Pf}(D^+)^{I_m(\lambda)} = 2^{m/2-1}$.

(2) Condition (i) of Proposition 6.1 for $\text{Pf}(D^-)^{I_m(\lambda)}$ with $\lambda \in \text{Par}(m, w)$ is checked by an argument similar to that of (1). Conditions (ii) and (iii) can be verified by using the relation $\delta_{\ell+N}^- = \delta_\ell^- + 1 - (-1)^\ell$.

(3) In order to prove $\text{Pf}(D^+)^{I_m(\lambda)} = d_{m,w}^+(\lambda)$ for $\lambda \in \text{Par}(m, w)$, we note the relation

$$\delta_\alpha^+ - \delta_\ell^+ = \lceil \alpha/2 \rceil - \lceil \ell/2 \rceil.$$

If λ is neither even nor odd, then there is an index k such that $i_k \equiv i_{k+1} \pmod 2$, where $I_m(\lambda) = (i_1, \dots, i_m)$. We can use the above relation to see that the 0-th, k -th and $(k+1)$ -st rows are linearly dependent, hence we have $\text{Pf}(D^+)^{I_m(\lambda)} = 0$. If λ is even or odd, then, by using the above relation, we can perform row/column operations to transform the skew-symmetric matrix $(D^+)^{I_m(\lambda)}$ into the skew-symmetric matrix $M = (M_{i,j})_{0 \leq i, j \leq m}$ with entries $M_{i,j}$, $i < j$, given by

$$M_{i,j} = \begin{cases} 1, & \text{if } i = 0 \text{ and } j = 1, \\ 1, & \text{if } i = 1 \text{ and } j \text{ is even,} \\ (-1)^{j-i-1}, & \text{if } i \geq 2, \\ 0, & \text{otherwise.} \end{cases}$$

Hence, by expanding the Pfaffian along the 0-th row/column, we see that

$$\text{Pf}(D^+)^{I_m(\lambda)} = \text{Pf } M = \text{Pf}_{2 \leq i < j \leq m} \left((-1)^{j-i-1} \right) = 1,$$

where we used [19, Lem. 7] in the last equality. Therefore we have $\text{Pf}(D^+)^{I_m(\lambda)} = d_{2h+1,w}^+(\lambda)$.

Using the relation $\delta_{\ell+N}^+ = \delta_\ell^+ + N'$, we can prove that D^+ satisfies Conditions (ii) and (iii).

(4) The proof is the same as (3) up to a sign, so we omit it. \square

We are now in the position to prove the identities in Theorem 3.4.

Proof of (3.13). By applying Proposition 6.1 to the skew-symmetric matrix D^+ given in Lemma 6.5 (1), we get

$$2^{h-1} \sum_{\lambda \in \text{Par}(2h,w)} d_{2h,w}^+(\lambda) s_{\lambda[2h,w]'}(\mathbf{x}) = \text{Pf}(T_0 D^+ T_0^t) = \text{Pf}_{1 \leq i < j \leq 2h} (v_{j-i}^+),$$

where $v_r^+ = \sum_{k \in \mathbb{Z}} \delta_k^+ f_{-k+r}(\mathbf{x})$. Since $\delta_\ell^+ - \delta_{\ell-2}^+ = 2(-1)^k$ if $\ell = kN + 1$ and 0 otherwise, we obtain $v_1^+ = \overline{F}_{0,N}(\mathbf{x})$ and $v_r^+ - v_{r-2}^+ = 2\overline{F}_{r-1,N}(\mathbf{x})$. Hence, by using (4.4), we have

$$\begin{aligned} \text{Pf}_{1 \leq i < j \leq 2h} (v_{j-i}^+) &= \det \begin{pmatrix} \overline{F}_{0,N}(\mathbf{x}) & (2\overline{F}_{j-1,N}(\mathbf{x}))_{2 \leq j \leq h} \\ (2\overline{F}_{i-1,N}(\mathbf{x}))_{2 \leq i \leq h} & (2\overline{F}_{i+j-2,N}(\mathbf{x}) + 2F_{|j-i|,N}(\mathbf{x}))_{2 \leq i, j \leq h} \end{pmatrix} \\ &= 2^{h-2} \det_{1 \leq i, j \leq h} (\overline{F}_{-i+j,N}(\mathbf{x}) + \overline{F}_{i+j-2,N}(\mathbf{x})). \end{aligned} \quad \square$$

Proof of (3.14). By applying Proposition 6.1 to the skew-symmetric matrix D^- given in Lemma 6.5(2), we get

$$2^{h-1} \sum_{\lambda \in \text{Par}(2h,w)} d_{2h,w}^-(\lambda) s_{\lambda[2h,w]'}(\mathbf{x}) = \text{Pf}(T_2 D^- T_2^t).$$

Here the entries $Q_{i,j}$, $i, j \in \{0, 0', 1, \dots, m\}$ and $i < j$, of the matrix $Q := T_2 D^- T_2^t$ are given by

$$Q_{0,0'} = 0, \quad Q_{0,j} = e(\mathbf{x}), \quad Q_{0',j} = (-1)^{j-1} \overline{e}(\mathbf{x}), \quad Q_{i,j} = \sum_{\ell \in \mathbb{Z}} \delta_\ell^- f_{-\ell+j-i}(\mathbf{x}),$$

where $i, j \geq 1$. In Pf Q , we subtract the $(i-2)$ -nd row/column from the i -th row/column for $i = m, m-1, \dots, 3$, and then add the $0'$ -th row/column to the 0 -th row/column. Then, by expanding the resulting Pfaffian along the 0 -th row/column, we see that

$$\text{Pf}(T_2 D^- T_2^t) = 2e(\mathbf{x}) \bar{e}(\mathbf{x}) \text{Pf}_{1 \leq i, j \leq 2h-2} (v_{j-i}^- - v_{j-i-2}^- - v_{j-i+2}^- + v_{j-i}^-),$$

where $v_r^- = \sum_{\ell \in \mathbb{Z}} \delta_\ell^- f_{-\ell+j-i}(\mathbf{x})$. Since $\delta_\ell^- - \delta_{\ell-2}^- = 2$ if $\ell = kN + 1$ and 0 otherwise, we have $v_r^- - v_{r-2}^- = 2F_{r-1, N}(\mathbf{x})$. Now, by using (4.1), we obtain the desired identity. \square

Proof of (3.15). By using Proposition 6.1 and a computation similar to the proof of (3.2), we have

$$\sum_{\lambda \in \text{Par}(2h+1, w)} d_{2h+1, w}^+(\lambda) s_{\lambda[2h+1, w]'}(\mathbf{x}) = e(\mathbf{x}) \cdot \text{Pf}_{2 \leq i, j \leq 2h+1} (v_{j-i}^+ - v_{j-i-1}^+ - v_{j-i+1}^+ + v_{j-i}^+).$$

Since we have

$$\delta_\ell^+ - \delta_{\ell-1}^+ - \delta_{\ell+1}^+ + \delta_\ell^+ = \begin{cases} 1, & \text{if } \ell = Nk + r, \text{ where } k, r \in \mathbb{Z} \text{ such that } 0 < r < N \text{ and } r \text{ is odd,} \\ -1, & \text{if } \ell = Nk + r, \text{ where } k, r \in \mathbb{Z} \text{ such that } 0 < r < N \text{ and } r \text{ is even,} \\ 0, & \text{otherwise,} \end{cases}$$

we see that

$$v_r^+ - v_{r-1}^+ - v_{r+1}^+ + v_r^+ = \sum_{t=1}^{N-1} (-1)^t F_{r+t, N}(\mathbf{x}),$$

where we note that $N = 2h + 1 + w$ is odd since w is even by assumption, and $F_{r+N, N}(\mathbf{x}) = F_{r, N}(\mathbf{x})$. Then we can complete the proof by applying (4.3). \square

Proof of (3.16). The proof is similar to that of the proof of (3.15). In this case, we use the relation

$$\delta_\ell^+ + \delta_{\ell-1}^+ + \delta_{\ell+1}^+ + \delta_\ell^+ = \begin{cases} (-1)^k, & \text{if } \ell = Nk + r, \text{ where } k, r \in \mathbb{Z} \text{ and } 0 < r < N, \\ 0, & \text{otherwise,} \end{cases}$$

and the formula (4.2). \square

7. UP-DOWN TABLEAUX

In this section, we provide combinatorial interpretations of the right-hand sides of the affine bounded Littlewood identities (3.1) and (3.2) (which are the same as (1.5) and (1.6)) using up-down tableaux. The latter are sequences of partitions satisfying certain conditions. Note that there is a combinatorial meaning of the left-hand sides of the affine bounded Littlewood identities (3.1) and (3.2) in terms of cylindric semistandard Young tableaux, respectively in terms of cylindric row-strict Young tableaux, see Definition 2.5 and Proposition 2.6.

To be specific, in Theorem 7.2 we provide a combinatorial interpretation of the determinant on the right-hand side of (3.1) for the case where w is odd. It is then simple to derive a combinatorial interpretation of the right-hand side of (3.1) itself, see Corollary 7.4. In Theorem 7.6 we give a combinatorial interpretation of the determinant on the right-hand side of (3.1) when w is even, as well as for the determinant on the right-hand side of (3.2) for both odd and even w . The resulting combinatorial interpretations of the full right-hand sides of (3.1) with w even, and of (3.2) are the subject of Corollaries 7.9–7.11.

We start by defining the above-mentioned up-down tableaux precisely.

Definition 7.1. An (h, w) -up-down tableau is a sequence $(\lambda^0, \lambda^1, \dots, \lambda^{2n})$ of partitions satisfying the following properties:

- (i) $\emptyset = \lambda^0 \subseteq \lambda^1 \supseteq \lambda^2 \subseteq \lambda^3 \supseteq \lambda^4 \subseteq \dots \subseteq \lambda^{2n-1} \supseteq \lambda^{2n} = \emptyset$;

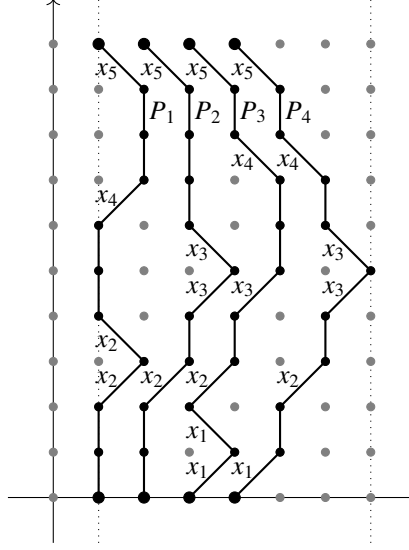

FIGURE 6. An example of a family $\mathbf{P} = (P_1, P_2, P_3, P_4)$ of nonintersecting paths.

- (ii) each pair $(\lambda^{i-1}, \lambda^i)$ differs by a vertical strip (that is, by a collection of cells which contains at most one cell in each row), $i = 1, 2, \dots, 2n$;
- (iii) each λ^i has at most h rows, $i = 1, 2, \dots, 2n$;
- (iv) each λ^{2i} has at most w columns, $i = 1, 2, \dots, n$.

Let $\text{UD}_n(h, w)$ denote the set of (h, w) -up-down tableaux $(\lambda^0, \lambda^1, \dots, \lambda^{2n})$. For $T = (\lambda^0, \lambda^1, \dots, \lambda^{2n}) \in \text{UD}_n(h, w)$, we define its weight by

$$\omega(T) = \prod_{i=1}^n x_i^{-|\lambda^{2i-2}| + 2|\lambda^{2i-1}| - |\lambda^{2i}|}.$$

Note that $-|\lambda^{2i-2}| + 2|\lambda^{2i-1}| - |\lambda^{2i}|$ is the sum of the differences in sizes of $(\lambda^{2i-2}, \lambda^{2i-1})$ and of $(\lambda^{2i-1}, \lambda^{2i})$.

The following theorem provides a combinatorial interpretation of the determinant on the right-hand side of (3.1) in terms of up-down tableaux for the case where w is odd.

Theorem 7.2. *For positive integers h, w , and n , we have*

$$(7.1) \quad \det_{1 \leq i, j \leq h} \left(F_{-i+j, 2h+2w+2}(x_1, \dots, x_n) - F_{i+j, 2h+2w+2}(x_1, \dots, x_n) \right) = \sum_{T \in \text{UD}_n(h, w)} \omega(T).$$

We will prove this theorem with the help of the idea of *nonintersecting lattice paths* (see [25, 11]), with the particular setting being the one from [20]. We need some preparations first, however.

Following [20, Sec. 2], we consider lattice paths in the plane integer lattice with steps from the set

$$(7.2) \quad S = \{(i, j) \rightarrow (i, j+1), (i, 2j-2) \rightarrow (i+1, 2j-1), (i, 2j-1) \rightarrow (i-1, 2j) : i, j \in \mathbb{Z}\}.$$

In words, the set of steps consists of vertical steps s_v north, forward diagonal steps s_f northeast from even height to odd height, and backward diagonal steps s_b northwest from odd height to even height. Throughout, when we say ‘lattice path’ or simply ‘path’ we always mean a lattice path with steps from the set S . Several such lattice paths are displayed in Figure 6.

We define the weight $\omega(s_v)$ of a vertical step s_v to be 1, the weight $\omega(s_f)$ of a forward diagonal step s_f from $(i, 2j - 2)$ to $(i + 1, 2j - 1)$ to be x_j , and the weight $\omega(s_b)$ of a backward diagonal step from $(i, 2j - 1)$ to $(i - 1, 2j)$ to be also x_j . The weight of a path equals the product of the weights of its steps.

Let $L(u \rightarrow v)$ denote the set of lattice paths from u to v . Let $L(a, b; u \rightarrow v)$ denote the set of $P \in L(u \rightarrow v)$ for which every point $(i, 2j)$ of even height in P satisfies $a \leq i \leq b$. Note that, if $P \in L(a, b; (r, 0) \rightarrow (s, 2n))$ for some integers r, s with $a \leq r, s \leq b$, then every point $(i, 2j + 1)$ of odd height in P always satisfies $a \leq i \leq b + 1$.

Lemma 7.3. *For positive integers i, j, N and n with $1 \leq i, j < N$, we have*

$$(7.3) \quad F_{-i+j, 2N+2}(x_1, \dots, x_n) - F_{i+j, 2N+2}(x_1, \dots, x_n) = \sum_{P \in L(1, N; (i, 0) \rightarrow (j, 2n))} \omega(P).$$

Proof. Since

$$(7.4) \quad \sum_{P \in L((a, 0) \rightarrow (b, 2n))} \omega(P) = \sum_{k \in \mathbb{Z}} e_k(x_1, \dots, x_n) e_{b-a+k}(x_1, \dots, x_n) = f_{b-a}(x_1, \dots, x_n),$$

we can rewrite (7.3) as follows:

$$(7.5) \quad \sum_{\substack{k \in \mathbb{Z}, \varepsilon \in \{-1, +1\} \\ P \in L((\varepsilon i + k(2N+2), 0) \rightarrow (j, 2n))}} \varepsilon \cdot \omega(P) = \sum_{P \in L(1, N; (i, 0) \rightarrow (j, 2n))} \omega(P).$$

We prove (7.5) by constructing a sign-reversing involution, say φ , on the set

$$\mathcal{B} := \left(\bigcup_{k \in \mathbb{Z}} \bigcup_{\varepsilon \in \{-1, +1\}} L((\varepsilon i + k(2N+2), 0) \rightarrow (j, 2n)) \right) \setminus L(1, N; (i, 0) \rightarrow (j, 2n)),$$

where the sign of $P \in L((\varepsilon i + k(2N+2), 0) \rightarrow (j, 2n))$ is defined to be ε .

Let $P \in \mathcal{B}$. Then there is at least one point (x, y) in P such that $x \in \{0, N + 1\}$ and y is even. Choose such a point (x, y) with maximal y . We let P' be the portion of P from its starting point up to (x, y) and P'' the portion from (x, y) up to P 's end point. Then we define $\varphi(P) = \mathfrak{R}(P')P''$, where \mathfrak{R} means the modified reflection from [20, Proof of (1.1)]. To be specific, beginning from P 's starting point up to (x, y) , we group steps in pairs. If a pair consists of two vertical steps then we leave them invariant, as well as if the pair consists of a forward diagonal step followed by a backward diagonal step. If a pair consists of a forward diagonal step followed by a vertical step, then we replace this pair by the pair consisting of a vertical step followed by a backward diagonal step, and vice versa.

Since the map φ leaves the portion of the path after (x, y) invariant, twofold application of φ will bring us back to P . Thus, the map φ is indeed an involution. To see that φ is sign-reversing on the set \mathcal{B} , suppose that the starting point of P is $(\varepsilon i + k(2N+2), 0)$ so that the sign of P is ε . Then the starting point of $\varphi(P)$ is $(-\varepsilon i - k(2N+2), 0)$ if $x = 0$, respectively $(-\varepsilon i + (1 - k)(2N+2), 0)$ if $x = N + 1$. Thus the sign of $\varphi(P)$ is always $-\varepsilon$. Furthermore, the map φ is clearly weight-preserving. This completes the proof of (7.5), and thus of (7.3). \square

We are now in the position to prove the claimed combinatorial interpretation of the determinant on the right-hand side of (3.1).

Proof of Theorem 7.2. By Lemma 7.3, the left-hand side of (7.1) is equal to

$$(7.6) \quad \sum_{\sigma \in \mathfrak{S}_h} \text{sgn}(\sigma) \prod_{j=1}^h \sum_{P_j \in L(1, h+w; (\sigma(j), 0) \rightarrow (j, 2n))} \omega(P_j) = \sum_{\mathbf{P} \in X} \text{sgn}(\mathbf{P}) \omega(\mathbf{P}),$$

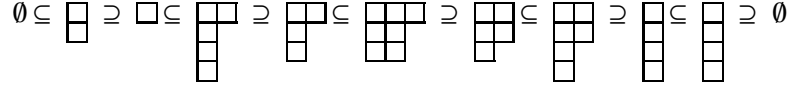
FIGURE 7. The up-down tableau corresponding to the family \mathbf{P} in Figure 6.

where X is the set of families of paths $\mathbf{P} = (P_1, P_2, \dots, P_h)$ for which $P_j \in L(1, h+w; (\sigma(j), 0) \rightarrow (j, 2n))$, $j = 1, 2, \dots, h$, for some $\sigma \in \mathfrak{S}_h$, $\text{sgn}(\mathbf{P}) = \text{sgn}(\sigma)$ and $\omega(\mathbf{P}) = \prod_{j=1}^h \omega(P_j)$. We claim that the right-hand side of (7.6) is equal to $\sum_{\mathbf{P} \in Y} \text{sgn}(\mathbf{P}) \omega(\mathbf{P})$, where Y is the set of all families $\mathbf{P} = (P_1, P_2, \dots, P_h)$ of nonintersecting lattice paths with $P_j \in L(1, h+w; (j, 0) \rightarrow (j, 2n))$ for $j = 1, 2, \dots, h$.

To see this, suppose that $\mathbf{P} = (P_1, P_2, \dots, P_h) \in X$ has some intersection points. We choose the intersection point (x, y) with maximal y , and if there are several of them, then among these the one with minimal x . Let (s, t) be lexicographically minimal such that (x, y) is a point on P_s and P_t . We then do the usual ‘‘Lindström–Gessel–Viennot’’ switching (cf. [25, 11]) of the initial portions of P_s and P_t up to the intersection point (x, y) . If $\text{sgn}(\mathbf{P}) = \text{sgn}(\sigma)$, then the corresponding family \mathbf{P}' satisfies $\text{sgn}(\mathbf{P}') = \text{sgn}(\sigma \circ (s, t)) = -\text{sgn}(\sigma)$. Thus the map $\mathbf{P} \mapsto \mathbf{P}'$ gives a sign-reversing and weight-preserving involution on $X \setminus Y$, and the claim is proved.

It remains to show that there is a weight-preserving bijection between Y and $\text{UD}_n(h, w)$. In order to see this, we start from a family $\mathbf{P} = (P_1, P_2, \dots, P_h) \in Y$ of nonintersecting lattice paths. See Figure 6, which shows an example for $n = 5$, $h = 4$, and $w = 2$. In particular, the bounding line $x = h + w + 1 = 7$ is indicated by the dotted line in the figure.

For $j = 0, 1, \dots, 2n$, we now read the vector of x -coordinates of the points of the lattice paths that are at height j . For our running example from Figure 6, we get the sequence

$$(1, 2, 3, 4), (1, 2, 4, 5), (1, 2, 3, 5), (2, 3, 4, 6), (1, 3, 4, 6), (1, 4, 5, 7), \\ (1, 3, 5, 6), (2, 3, 5, 6), (2, 3, 4, 5), (2, 3, 4, 5), (1, 2, 3, 4).$$

In the next step, we subtract i from the i -th coordinate of each vector, $i = 1, 2, \dots, h$, and we reverse the order of the coordinates. In our example, this leads to

$$(0, 0, 0, 0), (1, 1, 0, 0), (1, 0, 0, 0), (2, 1, 1, 1), (2, 1, 1, 0), (3, 2, 2, 0), \\ (2, 2, 1, 0), (2, 2, 1, 1), (1, 1, 1, 1), (1, 1, 1, 1), (0, 0, 0, 0).$$

Finally, each of the vectors is interpreted as a Young diagram. In this manner, in our example we arrive at the (h, w) -up-down tableau in Figure 7. It is straightforward to verify that this correspondence is a weight-preserving bijection between Y and $\text{UD}_n(h, w)$, which completes the proof. \square

An immediate consequence of Theorem 7.2 is the following corollary, which gives a combinatorial interpretation of the right-hand side of the affine bounded Littlewood identity (3.1) when w is odd.

Corollary 7.4. *The coefficient of $x_1^{m_1} x_2^{m_2} \dots x_n^{m_n}$ in*

$$\sum_{k \geq 0} e_k(\mathbf{x}) \det_{1 \leq i, j \leq h} (F_{-i+j, 2h+2w+2}(\mathbf{x}) - F_{i+j, 2h+2w+2}(\mathbf{x}))$$

equals the number of (h, w) -up-down tableaux $(\lambda^0, \lambda^1, \dots, \lambda^{2n})$ which satisfy $-|\lambda^{2i-2}| + 2|\lambda^{2i-1}| - |\lambda^{2i}| \in \{m_i, m_i - 1\}$, $i = 1, 2, \dots, n$.

We now turn to the right-hand sides of the affine bounded Littlewood identities (3.1) with w even and (3.2). Our combinatorial interpretations of these identities are in terms of *marked* up-down tableaux, which we define next.

Definition 7.5. An (h^*, w) -up-down tableau (respectively (h, w^*) -up-down tableau) is a pair (T, M) of an (h, w) -up-down tableau $T = (\lambda^0, \lambda^1, \dots, \lambda^{2n})$ and a subset $M \subseteq \{1, 2, \dots, n\}$ with the property that if $j \in M$ then $\lambda_h^{2j-1} = 0$ (respectively $\lambda_1^{2j-1} = w + 1$). An (h^*, w^*) -up-down tableau is a triple (T, M_1, M_2) of an (h, w) -up-down tableau $T = (\lambda^0, \lambda^1, \dots, \lambda^{2n})$ and subsets $M_1, M_2 \subseteq \{1, 2, \dots, n\}$ with the property that if $j \in M_1$ then $\lambda_h^{2j-1} = 0$, and if $j \in M_2$ then $\lambda_1^{2j-1} = w + 1$.

One may consider an (h^*, w) -up-down tableau as an (h, w) -up-down tableau $(\lambda^0, \lambda^1, \dots, \lambda^{2n})$ in which each last part λ_h^{2j-1} , if it exists, may be marked if it equals zero. We may think of (h, w^*) -up-down tableaux and (h^*, w^*) -up-down tableaux in an analogous way.

We define $\text{UD}_n(h^*, w)$ to be the set of (h^*, w) -up-down tableaux (T, M) with $T \in \text{UD}_n(h, w)$. The sets $\text{UD}_n(h, w^*)$ and $\text{UD}_n(h^*, w^*)$ are defined similarly. For $(T, M_1) \in \text{UD}_n(h^*, w)$, $(T, M_2) \in \text{UD}_n(h, w^*)$, and $(T, M_1, M_2) \in \text{UD}_n(h^*, w^*)$, we define their weights by

$$\begin{aligned}\omega(T, M_1) &= \omega(T) \prod_{j \in M_1} x_j, \\ \omega(T, M_2) &= \omega(T) \prod_{j \in M_2} \left(-\frac{1}{x_j}\right), \\ \omega(T, M_1, M_2) &= \omega(T) \prod_{j \in M_1} x_j \prod_{j \in M_2} \left(-\frac{1}{x_j}\right).\end{aligned}$$

In the theorem below, we present combinatorial interpretations of the determinants on the right-hand sides of (3.1) with w even and of (3.2).

Theorem 7.6. For positive integers h, w , and n , we have

$$(7.7) \quad \det_{1 \leq i, j \leq h} \left(F_{-i+j, 2h+2w+1}(x_1, \dots, x_n) - F_{i+j, 2h+2w+1}(x_1, \dots, x_n) \right) = \sum_{(T, M) \in \text{UD}_n(h, w^*)} \omega(T, M),$$

$$(7.8) \quad \det_{1 \leq i, j \leq h} \left(\bar{F}_{-i+j, 2h+2w+1}(x_1, \dots, x_n) + \bar{F}_{i+j-1, 2h+2w+1}(x_1, \dots, x_n) \right) = \sum_{(T, M) \in \text{UD}_n(h^*, w)} \omega(T, M),$$

$$(7.9) \quad \det_{1 \leq i, j \leq h} \left(\bar{F}_{-i+j, 2h+2w}(x_1, \dots, x_n) + \bar{F}_{i+j-1, 2h+2w}(x_1, \dots, x_n) \right) = \sum_{(T, M_1, M_2) \in \text{UD}_n(h^*, w^*)} \omega(T, M_1, M_2).$$

Again, we need some preparations first before we are able to turn to the proof of the theorem. It will again be based on nonintersecting lattice paths. Here, the lattice paths will come with a ‘‘decoration’’ though.

Definition 7.7. A 1-branch point of a lattice path P is a point $(1, 2j - 1)$ with the property that P passes through $(1, 2j - 2)$, $(1, 2j - 1)$, and $(1, 2j)$. For an integer $N > 1$, an N -branch point of a lattice path P is a point $(N + 1, 2j - 1)$ with the property that P passes through $(N, 2j - 2)$, $(N + 1, 2j - 1)$, and $(N, 2j)$.

For an integer $t \geq 1$, a t -marked lattice path is a pair (P, M) of a lattice path P and a set M of t -branch points of P . For integers $t_1, t_2 \geq 1$, a (t_1, t_2) -marked lattice path is a triple (P, M_1, M_2) , where P is a lattice path, and M_i is a set of t_i -branch points of P for $i = 1, 2$.

For a t -branch point u of height $2j - 1$, we define its weight by

$$\omega(u) = \begin{cases} x_j, & \text{if } t = 1, \\ -1/x_j, & \text{if } t > 1. \end{cases}$$

We also define

$$\omega(P, M) = \omega(P)\omega(M) \quad \text{and} \quad \omega(P, M_1, M_2) = \omega(P)\omega(M_1)\omega(M_2),$$

where $\omega(M) = \prod_{u \in M} \omega(u)$.

A marked lattice path may be considered as a lattice path in which some branch points are marked. Note that the weight of a marked lattice path also contains a sign, which is the product of -1 for each marked t -branch point for $t > 1$.

Recall that $L(u \rightarrow v)$ is the set of lattice paths from u to v and $L(a, b; u \rightarrow v)$ is the set of $P \in L(u \rightarrow v)$ with the property that every point $(i, 2j)$ of even height in P satisfies $a \leq i \leq b$. Let $L(1^*, b; u \rightarrow v)$ denote the set of 1-marked lattice paths (P, M) with $P \in L(1, b; u \rightarrow v)$. The sets $L(1, b^*; u \rightarrow v)$ and $L(1^*, b^*; u \rightarrow v)$ are defined similarly.

Lemma 7.8. *For positive integers i, j, N , and n with $1 \leq i, j < N$, we have*

$$(7.10) \quad F_{-i+j, 2N+1}(x_1, \dots, x_n) - F_{i+j, 2N+1}(x_1, \dots, x_n) = \sum_{(P, M) \in L(1, N^*; (i, 0) \rightarrow (j, 2n))} \omega(P, M),$$

$$(7.11) \quad \bar{F}_{-i+j, 2N+1}(x_1, \dots, x_n) + \bar{F}_{i+j-1, 2N+1}(x_1, \dots, x_n) = \sum_{(P, M) \in L(1^*, N; (i, 0) \rightarrow (j, 2n))} \omega(P, M),$$

$$(7.12) \quad \bar{F}_{-i+j, 2N}(x_1, \dots, x_n) + \bar{F}_{i+j-1, 2N}(x_1, \dots, x_n) = \sum_{(P, M_1, M_2) \in L(1^*, N^*; (i, 0) \rightarrow (j, 2n))} \omega(P, M_1, M_2).$$

Proof. By (7.4), we can rewrite the identities (7.10)–(7.12) as follows:

$$(7.13) \quad \sum_{\substack{k \in \mathbb{Z}, \varepsilon \in \{-1, +1\} \\ P \in L((\varepsilon i + k(2N+1), 0) \rightarrow (j, 2n))}} \varepsilon \cdot \omega(P) = \sum_{(P, M) \in L(1, N^*; (i, 0) \rightarrow (j, 2n))} \omega(P, M),$$

$$(7.14) \quad \sum_{\substack{k \in \mathbb{Z}, \varepsilon \in \{-1, +1\} \\ P \in L((\varepsilon(i-1/2) + 1/2 + k(2N+1), 0) \rightarrow (j, 2n))}} (-1)^k \omega(P) = \sum_{(P, M) \in L(1^*, N; (i, 0) \rightarrow (j, 2n))} \omega(P, M),$$

$$(7.15) \quad \sum_{\substack{k \in \mathbb{Z}, \varepsilon \in \{-1, +1\} \\ P \in L((\varepsilon(i-1/2) + 1/2 + k(2N), 0) \rightarrow (j, 2n))}} (-1)^k \omega(P) = \sum_{(P, M_1, M_2) \in L(1^*, N^*; (i, 0) \rightarrow (j, 2n))} \omega(P, M_1, M_2).$$

For the identity (7.13) we proceed similarly as in the proof of Lemma 7.3 by constructing a sign-reversing involution using a point (x, y) in P with $x \in \{0, 2N+1\}$ and y even, if such a point exists. This will give

$$(7.16) \quad \sum_{\substack{k \in \mathbb{Z}, \varepsilon \in \{-1, +1\} \\ P \in L((\varepsilon i + k(2N+1), 0) \rightarrow (j, 2n))}} \varepsilon \cdot \omega(P) = \sum_{P \in L(1, 2N; (i, 0) \rightarrow (j, 2n))} \omega(P) - \sum_{P \in L(1, 2N; (2N+1-i, 0) \rightarrow (j, 2n))} \omega(P).$$

Now let $P \in L(1, 2N; (i, 0) \rightarrow (j, 2n)) \cup L(1, 2N; (2N+1-i, 0) \rightarrow (j, 2n))$. We will construct an N -marked path $(Q, M) \in L(1, N^*; (i, 0) \rightarrow (j, 2n))$ as follows.

First, let $(Q, M) = (P, \emptyset)$. We will modify (Q, M) repeatedly until it becomes an element in $L(1, N^*; (i, 0) \rightarrow (j, 2n))$. If $(Q, M) \in L(1, N^*; (i, 0) \rightarrow (j, 2n))$, then there is nothing to do. Otherwise, choose the largest even integer y such that $(N+1, y)$ is a point in Q . Then Q must pass through all points $(N+1, y)$, $(N+1, y+1)$ and $(N, y+2)$. Let Q' be the portion of Q from its starting point up to $(N+1, y)$ and Q'' the portion from $(N, y+2)$ up to Q 's end point, i.e., $Q = Q' s_y s_b Q''$. Then we update Q to $\mathfrak{R}(Q') s_f s_b Q''$ and add the point $(N+1, y+1)$ to the set M , where \mathfrak{R} has the same meaning as in the proof of Lemma 7.3. Repeating this process eventually yields $(Q, M) \in L(1, N^*; (i, 0) \rightarrow (j, 2n))$. For example, see Figure 8. It is easy to see that the map $P \mapsto (Q, M)$ is a weight-preserving bijection between $L(1, 2N; (i, 0) \rightarrow (j, 2n)) \cup L(1, 2N; (2N+1-i, 0) \rightarrow (j, 2n))$ and $L(1, N^*; (i, 0) \rightarrow (j, 2n))$. This shows that the right-hand sides of (7.13) and (7.16) are equal, completing the proof of (7.13).

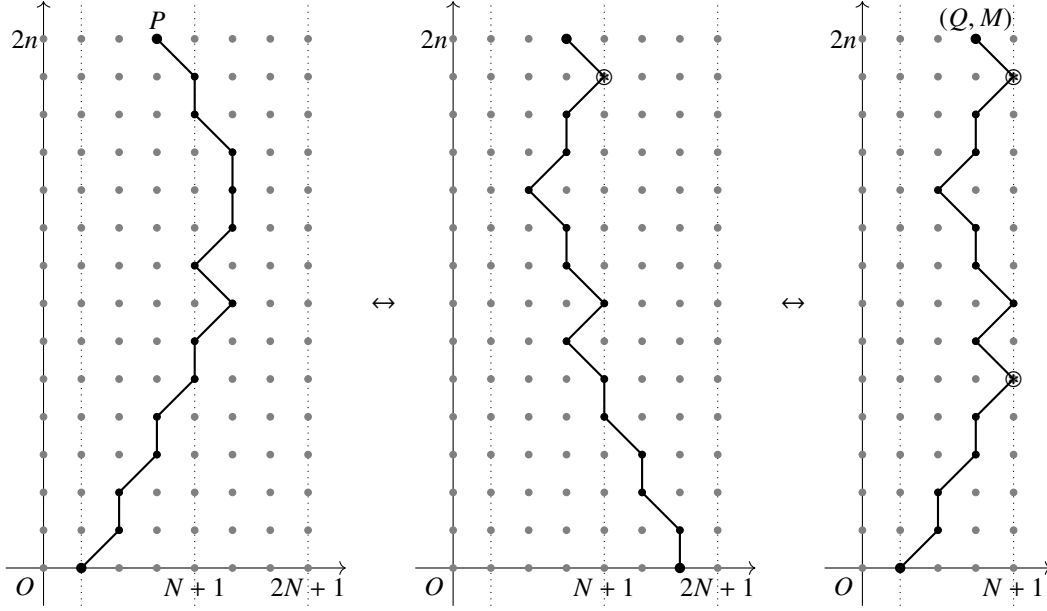

FIGURE 8. An example of a path $P \in L(1, 2N; (i, 0) \rightarrow (j, 2n))$ and its corresponding N -marked path $(Q, M) \in L(1, N^*; (i, 0) \rightarrow (j, 2n))$ with $N = 3, i = 1, j = 2$ and $n = 7$. Each N -branch point $\in M$ is indicated by \otimes .

The identity (7.14) can be proved similarly as (7.13). We first construct a sign-reversing involution using a point (x, y) in P with $x \in \{-N, N+1\}$ and y even, if such a point exists. This will give

$$\sum_{\substack{k \in \mathbb{Z}, s \in \{-1, +1\} \\ P \in L((\varepsilon(i-1/2)+1/2+k(2N+1), 0) \rightarrow (j, 2n))}} (-1)^k \omega(P) = \sum_{P \in L(1-N, N; (i, 0) \rightarrow (j, 2n))} \omega(P) + \sum_{P \in L(1-N, N; (1-i, 0) \rightarrow (j, 2n))} \omega(P).$$

For each $P \in L(1-N, N; (i, 0) \rightarrow (j, 2n)) \cup L(1-N, N; (1-i, 0) \rightarrow (j, 2n))$, we construct $(Q, M) \in L(1^*, N; (i, 0) \rightarrow (j, 2n))$ as follows. Let $(Q, M) = (P, \emptyset)$. If $(Q, M) \in L(1^*, N; (i, 0) \rightarrow (j, 2n))$, then there is nothing to do. Otherwise, choose the largest even integer y such that $(0, y)$ is a point in Q . Then Q must pass through all points $(0, y), (1, y+1)$ and $(1, y+2)$. Let Q' be the portion of Q from its starting point up to $(0, y)$ and Q'' the portion from $(1, y+2)$ up to Q 's end point. Then we update Q to $\Re(Q')_{s_v, s_v} Q''$ and add the point $(1, y+1)$ to the set M . Repeating this process eventually yields $(Q, M) \in L(1^*, N; (i, 0) \rightarrow (j, 2n))$. An example is given in Figure 9. Again, the map $P \mapsto (Q, M)$ is a weight-preserving bijection between $L(1-N, N; (i, 0) \rightarrow (j, 2n)) \cup L(1-N, N; (1-i, 0) \rightarrow (j, 2n))$ and $L(1^*, N; (i, 0) \rightarrow (j, 2n))$, and we obtain (7.14).

For the last identity (7.15) we do not need a sign-reversing involution. Instead, we construct $(Q, M_1, M_2) \in L(1^*, N^*; (i, 0) \rightarrow (j, 2n))$ directly from $P \in L((\varepsilon(i-1/2)+1/2+k(2N), 0) \rightarrow (j, 2n))$. To do this, as before, we first set $(Q, M_1, M_2) = (P, \emptyset, \emptyset)$. If $(Q, M_1, M_2) \in L(1^*, N^*; (i, 0) \rightarrow (j, 2n))$, then we are done. Otherwise, find the largest even y such that $(0, y)$ or $(N+1, y)$ is a point in Q . Then we modify Q by the same method as above and add $(1, y+1)$ to M_1 (respectively $(N+1, y+1)$ to M_2) if $(0, y)$ (respectively $(N+1, y)$) is a point of Q . This proves (7.15). \square

We have now all prerequisites at our disposal to embark on the proof of Theorem 7.6. Since this proof is very similar to the one of Theorem 7.2, we content ourselves with providing a brief sketch.

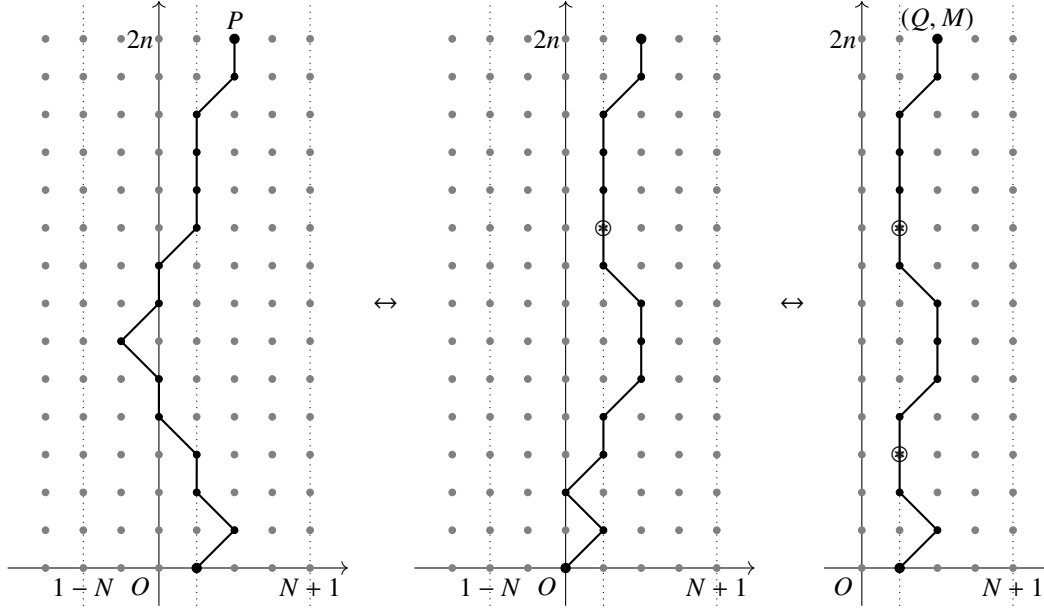

FIGURE 9. An example of a path $P \in L(1-N, N; (i, 0) \rightarrow (j, 2n))$ and its corresponding 1-marked path $(Q, M) \in L(1^*, N; (i, 0) \rightarrow (j, 2n))$ with $N = 3, i = 1, j = 2$, and $n = 7$. Each 1-branch point $\in M$ is indicated by \otimes .

Sketch of proof of Theorem 7.6. We proceed in a similar manner as in the proof of Theorem 7.2, here however using Lemma 7.8. The only thing that needs careful thought is whether the chosen intersection point (x, y) is a t -branch point of some path for $t \in \{1, h+w\}$. This never happens because we have chosen the intersection point (x, y) with y maximal. To see this, suppose that (x, y) is a common point of P_r and P_s , and (x, y) is a 1-branch point of P_r . Then $(x, y) = (1, 2j-1)$ for some j , and P_r passes through $(1, 2j-2)$ and $(1, 2j)$ as well. Recalling the step set (7.2), the only possible steps starting from $(1, 2j-1)$ are a vertical step or a backward diagonal step. Thus P_s must pass through $(1, 2j)$ or $(0, 2j)$. However, since (x, y) is chosen to be the intersection point with y maximal, P_s does not pass through $(1, 2j)$, and since $P_s \in L(1, h+w; u \rightarrow v)$ for some points u and v , it does not pass through $(0, 2j)$. This is a contradiction and therefore (x, y) is not a 1-branch point of any path. Similarly, it is not an $(h+w)$ -branch point. Therefore the ‘‘Lindström–Gessel–Viennot’’ switching (cf. [25, 11]) works. \square

As consequences of Theorem 7.6 we obtain combinatorial interpretations for the right-hand sides of the affine bounded Littlewood identities (3.1) with w even and (3.2). Note that these combinatorial interpretations use up-down tableaux *without* marking.

We start with the right-hand side of (3.1) with even w .

Corollary 7.9. *The coefficient of $x_1^{m_1} x_2^{m_2} \cdots x_n^{m_n}$ in*

$$\sum_{k \geq 0} e_k(\mathbf{x}) \det_{1 \leq i, j \leq h} (F_{-i+j, 2h+2w+1}(\mathbf{x}) - F_{i+j, 2h+2w+1}(\mathbf{x}))$$

equals the number of (h, w) -up-down tableaux $(\lambda^0, \lambda^1, \dots, \lambda^{2n})$ satisfying

$$-|\lambda^{2i-2}| + 2|\lambda^{2i-1}| - |\lambda^{2i}| = \begin{cases} m_i \text{ or } m_i - 1, & \text{if } \lambda_1^{2i-1} \leq w \text{ and not } \lambda_1^{2i-2} = \lambda_1^{2i-1} = \lambda_1^{2i} = w, \\ m_i, & \text{if } \lambda_1^{2i-2} = \lambda_1^{2i-1} = \lambda_1^{2i} = w, \\ m_i - 1, & \text{if } \lambda_1^{2i-1} = w + 1, \end{cases}$$

for $i = 1, 2, \dots, n$.

Proof. By (7.7), the coefficient in question is equal to $\sum_{(T,M) \in X} (-1)^{|M|}$, where X is the set of $(T, M) \in \text{UD}_n(h, w^*)$ with $T = (\lambda^0, \lambda^1, \dots, \lambda^{2n})$ satisfying

$$-|\lambda^{2i-2}| + 2|\lambda^{2i-1}| - |\lambda^{2i}| = \begin{cases} m_i \text{ or } m_i - 1, & \text{if } i \notin M, \\ m_i \text{ or } m_i + 1, & \text{if } i \in M. \end{cases}$$

Given T and i with $\lambda_1^{2i-1} = w + 1$, there are the two cases $i \notin M$ or $i \in M$. These two cases cancel with each other if $-|\lambda^{2i-2}| + 2|\lambda^{2i-1}| - |\lambda^{2i}| = m_i$. Thus, if $\lambda_1^{2i-1} = w + 1$, there remains only the case where $-|\lambda^{2i-2}| + 2|\lambda^{2i-1}| - |\lambda^{2i}| \in \{m_i + 1, m_i - 1\}$. If $\lambda_1^{2i-1} \leq w$, then we always have $i \notin M$, and there are the two cases $-|\lambda^{2i-2}| + 2|\lambda^{2i-1}| - |\lambda^{2i}| \in \{m_i, m_i - 1\}$. Moreover, the case where $\lambda_1^{2i-1} = w + 1$ and $-|\lambda^{2i-2}| + 2|\lambda^{2i-1}| - |\lambda^{2i}| = m_i + 1$ cancels with the case where $\lambda_1^{2i-2} = \lambda_1^{2i-1} = \lambda_1^{2i} = w$ and $-|\lambda^{2i-2}| + 2|\lambda^{2i-1}| - |\lambda^{2i}| = m_i - 1$. This establishes the assertion of the corollary. \square

Next we address the right-hand side of (3.2) with odd w .

Corollary 7.10. *The coefficient of $x_1^{m_1} x_2^{m_2} \dots x_n^{m_n}$ in*

$$\det_{1 \leq i, j \leq h} (\overline{F}_{-i+j, 2h+2w+1}(\mathbf{x}) + \overline{F}_{i+j-1, 2h+2w+1}(\mathbf{x}))$$

equals the number of (h, w) -up-down tableaux $(\lambda^0, \lambda^1, \dots, \lambda^{2n})$ that satisfy the following properties for $i = 1, 2, \dots, n$:

$$-|\lambda^{2i-2}| + 2|\lambda^{2i-1}| - |\lambda^{2i}| = \begin{cases} m_i, & \text{if } \lambda_h^{2i-1} \geq 1, \\ m_i \text{ or } m_i - 1, & \text{if } \lambda_h^{2i-1} = 0. \end{cases}$$

Proof. This is an immediate consequence of (7.8). \square

Finally, we give the combinatorial interpretation of the right-hand side of (3.2) with even w .

Corollary 7.11. *The coefficient of $x_1^{m_1} x_2^{m_2} \dots x_n^{m_n}$ in*

$$\det_{1 \leq i, j \leq h} (\overline{F}_{-i+j, 2h+2w}(\mathbf{x}) + \overline{F}_{i+j-1, 2h+2w}(\mathbf{x}))$$

equals $A - B$, where A (respectively B) is the number of (h, w) -up-down tableaux $(\lambda^0, \lambda^1, \dots, \lambda^{2n})$ that satisfy the following properties:

(i) for $i = 1, 2, \dots, n$,

$$-|\lambda^{2i-2}| + 2|\lambda^{2i-1}| - |\lambda^{2i}| = \begin{cases} m_i, & \text{if } \lambda_h^{2i-1} \neq 0 \text{ and } \lambda_1^{2i-1} \neq w + 1, \\ m_i \text{ or } m_i + 1, & \text{if } \lambda_h^{2i-1} \neq 0 \text{ and } \lambda_1^{2i-1} = w + 1, \\ m_i \text{ or } m_i - 1, & \text{if } \lambda_h^{2i-1} = 0 \text{ and } \lambda_1^{2i-1} \neq w + 1, \\ m_i - 1 \text{ or } m_i + 1, & \text{if } \lambda_h^{2i-1} = 0 \text{ and } \lambda_1^{2i-1} = w + 1; \end{cases}$$

(ii) *there is an even (respectively odd) number of integers $i = 1, 2, \dots, n$ satisfying $-|\lambda^{2i-2}| + 2|\lambda^{2i-1}| - |\lambda^{2i}| = m_i + 1$.*

Proof. By (7.9), the coefficient in question is equal to $\sum_{(T, M_1, M_2) \in X} (-1)^{|M_2|}$, where X is the set of $(T, M_1, M_2) \in \text{UD}_n(h^*, w^*)$ with $T = (\lambda^0, \lambda^1, \dots, \lambda^{2n})$ satisfying

$$-|\lambda^{2i-2}| + 2|\lambda^{2i-1}| - |\lambda^{2i}| = \begin{cases} m_i, & \text{if } i \notin M_1 \text{ and } i \notin M_2, \\ m_i + 1, & \text{if } i \notin M_1 \text{ and } i \in M_2, \\ m_i - 1, & \text{if } i \in M_1 \text{ and } i \notin M_2, \\ m_i, & \text{if } i \in M_1 \text{ and } i \in M_2. \end{cases}$$

Now fix T and i and consider the following four cases. For brevity, let $L = -|\lambda^{2i-2}| + 2|\lambda^{2i-1}| - |\lambda^{2i}|$.

- (1) If $\lambda_h^{2i-1} \neq 0$ and $\lambda_1^{2i-1} \neq w + 1$, then $i \notin M_1$ and $i \notin M_2$. Thus $L = m_i$.
- (2) If $\lambda_h^{2i-1} \neq 0$ and $\lambda_1^{2i-1} = w + 1$, then $i \notin M_1$ and ($i \notin M_2$ or $i \in M_2$). Thus $L \in \{m_i, m_i + 1\}$.
- (3) If $\lambda_h^{2i-1} = 0$ and $\lambda_1^{2i-1} \neq w + 1$, then ($i \notin M_1$ or $i \in M_1$) and $i \notin M_2$. Thus $L \in \{m_i, m_i - 1\}$.
- (4) If $\lambda_h^{2i-1} = 0$ and $\lambda_1^{2i-1} = w + 1$, then ($i \notin M_1$ or $i \in M_1$) and ($i \notin M_2$ or $i \in M_2$). Thus $L \in \{m_i - 1, m_i, m_i + 1\}$. The case $L = m_i$ occurs twice, namely for ($i \notin M_1$ or $i \in M_1$) and for ($i \in M_1$ or $i \in M_2$). These two cases cancel with each other. Therefore it is only the cases where $L \in \{m_i - 1, m_i + 1\}$ which remain.

This establishes the assertion of the corollary. \square

8. CYLINDRIC STANDARD YOUNG TABLEAUX AND NONCROSSING AND NONNESTING MATCHINGS

In this section, we concentrate on the coefficients of $x_1 x_2 \cdots x_n$ on both sides of the affine bounded Littlewood identities in Theorem 3.1. Clearly, by Proposition 2.6 and Corollaries 7.4, and 7.9–7.11, we obtain enumeration results that connect cylindric standard Young tableaux and certain up-down tableaux which we shall call *vacillating tableaux*. (The reader must be warned that our use of the term “vacillating” deviates from the one in [3].) These results are presented in Corollary 8.2. On the other hand, from [3] (and the alternative [22]) we know that these vacillating tableaux are in bijection with (*partial*) *matchings*. This allows us to connect cylindric standard Young tableaux with matchings. The corresponding results are the subject of Corollary 8.9.

We begin by defining vacillating tableaux.

Definition 8.1. An (h, w) -*vacillating tableau* is a sequence $(\lambda^0, \lambda^1, \dots, \lambda^n)$ of partitions that satisfies the following three conditions:

- (i) $\lambda^0 = \lambda^n = \emptyset$;
- (ii) the partitions λ^{i-1} and λ^i differ by at most one cell, $i = 1, 2, \dots, n$;
- (iii) each λ^i has at most h rows and at most w columns, $i = 1, 2, \dots, n$.

Let $\text{VT}_n(h, w)$ denote the set of (h, w) -vacillating tableaux $(\lambda^0, \lambda^1, \dots, \lambda^n)$.

Suppose $T = (\lambda^0, \lambda^1, \dots, \lambda^n) \in \text{VT}_n(h, w)$. Then, by definition, we can identify each λ^i with an h -tuple of nonincreasing integers, which is an element of \mathbb{Z}^h . Using this identification, we may also consider T as a walk of length n from $\mathbf{0}$ to $\mathbf{0}$ consisting of steps in $\{\pm \varepsilon_i : 1 \leq i \leq h\} \cup \{\mathbf{0}\}$, where ε_i is the i -th standard basis vector, staying in the region

$$(8.1) \quad \{(x_1, \dots, x_h) \in \mathbb{Z}^h : w \geq x_1 \geq \dots \geq x_h \geq 0\}.$$

We define $\text{VT}_n(h, w^*)$ (respectively $\text{VT}_n(h^*, w)$) to be the set of walks in $\text{VT}_n(h, w)$ with the property that a zero step can never (respectively only) occur on the hyperplane $x_1 = w$ (respectively $x_h = 0$). We also define $\text{VT}'_n(h, w)$ to be the set of walks in $\text{VT}_n(h, w)$ with the property that a zero step can only occur on the hyperplane $x_h = 0$ or $x_1 = w$ but not both. For $p \in \text{VT}'_n(h, w)$, let $z(p)$ denote the number of zero steps on the hyperplane $x_1 = w$.

By a combination of Definition 2.5 and Corollaries 7.4, and 7.9–7.11, taking the coefficients of $x_1 x_2 \cdots x_n$ on both sides of the affine bounded Littlewood identities in (3.1) and (3.2) leads us to the following corollary.

Corollary 8.2. *For positive integers h, w , and n , we have*

$$(8.2) \quad |\text{CSYT}_n(2h + 1, 2w + 1)| = |\text{VT}_n(h, w)|,$$

$$(8.3) \quad |\text{CSYT}_n(2h + 1, 2w)| = |\text{VT}_n(h, w^*)|,$$

$$(8.4) \quad |\text{CSYT}_n(2h, 2w + 1)| = |\text{VT}_n(h^*, w)|,$$

$$(8.5) \quad |\text{CSYT}_n(2h, 2w)| = \sum_{T \in \text{VT}'_n(h, w)} (-1)^{z(T)}.$$

Proof. For the first identity, i.e., (8.2), we take the coefficients of $x_1 x_2 \cdots x_n$ on both sides of (3.1) with w replaced by $2w + 1$. By Proposition 2.6, the coefficient of $x_1 x_2 \cdots x_n$ on the left-hand side is $|\text{CSYT}_n(2h + 1, 2w + 1)|$. By Corollary 7.4, the coefficient of $x_1 x_2 \cdots x_n$ on the right-hand side is equal to the number of (h, w) -up-down tableaux $(\lambda^0, \lambda^1, \dots, \lambda^{2n})$ with the property that each subsequence $\lambda^{2i-2} \subseteq \lambda^{2i-1} \supseteq \lambda^{2i}$ satisfies one of the following:

- (1) λ^{2i-2} and λ^{2i} differ by one cell and $\lambda^{2i-1} = \lambda^{2i-2} \cup \lambda^{2i}$ (in other words, λ^{2i-1} is the larger partition between λ^{2i-2} and λ^{2i});
- (2) $\lambda^{2i-2} = \lambda^{2i-1} = \lambda^{2i}$.

At this point, we see that the odd-indexed partitions λ^{2i-1} are redundant. If we suppress them, then the sequence $(\lambda^0, \lambda^2, \dots, \lambda^{2n})$ is an (h, w) -vacillating tableau. Thus the coefficient is equal to $|\text{VT}_n(h, w)|$, and we obtain (8.2).

For the identity (8.3), consider the coefficient of $x_1 x_2 \cdots x_n$ on the right-hand side of (3.1) with w replaced by $2w$. By Corollary 7.9, this is equal to the number of (h, w) -up-down tableaux $(\lambda^0, \lambda^1, \dots, \lambda^{2n})$ with the property that each subsequence $\lambda^{2i-2} \subseteq \lambda^{2i-1} \supseteq \lambda^{2i}$ satisfies one of the following:

- (1) $\lambda_1^{2i-1} \leq w$, not $\lambda_1^{2i-2} = \lambda_1^{2i-1} = \lambda_1^{2i} = w$, λ^{2i-2} and λ^{2i} differ by one cell, and $\lambda^{2i-1} = \lambda^{2i-2} \cup \lambda^{2i}$;
- (2) $\lambda_1^{2i-1} < w$ and $\lambda^{2i-1} = \lambda^{2i-1} = \lambda^{2i}$;
- (3) $\lambda_1^{2i-2} = \lambda_1^{2i-1} = \lambda_1^{2i} = w$, and λ^{2i-2} and λ^{2i} differ by one cell;
- (4) $\lambda_1^{2i-1} = w + 1$ and $\lambda^{2i-2} = \lambda^{2i-1} = \lambda^{2i}$.

In fact, Cases (3) and (4) are impossible. Since the remaining cases give $(\lambda^0, \lambda^2, \dots, \lambda^{2n}) \in \text{VT}_n(h, w^*)$, we obtain (8.3). The third identity (8.4) can be proved similarly.

Finally, for the identity (8.5), we need some additional arguments. Consider the coefficient of $x_1 x_2 \cdots x_n$ on the right-hand side of (3.2) with w replaced by $2w$. By Corollary 7.11, this is equal to $A - B$, where A (respectively B) is the number of (h, w) -up-down tableaux $(\lambda^0, \lambda^1, \dots, \lambda^{2n})$ with the property that each subsequence $\lambda^{2i-2} \subseteq \lambda^{2i-1} \supseteq \lambda^{2i}$ satisfies one of the following:

- (1) $\lambda_h^{2i-1} \neq 0$, $\lambda_1^{2i-1} \neq w + 1$, λ^{2i-2} and λ^{2i} differ by one cell, and $\lambda^{2i-1} = \lambda^{2i-2} \cup \lambda^{2i}$;
- (2) $\lambda_h^{2i-1} \neq 0$, $\lambda_1^{2i-1} = w + 1$, λ^{2i-2} and λ^{2i} differ by one cell, and $\lambda^{2i-1} = \lambda^{2i-2} \cup \lambda^{2i}$;
- (3) $\lambda_h^{2i-1} \neq 0$, $\lambda_1^{2i-1} = w + 1$, and $\lambda^{2i-2} = \lambda^{2i}$ is obtained from λ^{2i-1} by deleting one cell in the first row;
- (4) $\lambda_h^{2i-1} = 0$, $\lambda_1^{2i-1} \neq w + 1$, λ^{2i-2} and λ^{2i} differ by one cell, and $\lambda^{2i-1} = \lambda^{2i-2} \cup \lambda^{2i}$;
- (5) $\lambda_h^{2i-1} = 0$, $\lambda_1^{2i-1} \neq w + 1$, and $\lambda^{2i-2} = \lambda^{2i-1} = \lambda^{2i}$;
- (6) $\lambda_h^{2i-1} = 0$, $\lambda_1^{2i-1} = w + 1$, and $\lambda^{2i-2} = \lambda^{2i}$ is obtained from λ^{2i-1} by deleting one cell in the first row;
- (7) $\lambda_h^{2i-1} = 0$, $\lambda_1^{2i-1} = w + 1$, and $\lambda^{2i-2} = \lambda^{2i-1} = \lambda^{2i}$,

where the total number of occurrences of Cases (3) and (6) is even (respectively odd). As before, Cases (2) and (7) are impossible because $\lambda_1^{2i-2}, \lambda_1^{2i} \leq w$. Case (5) with $\lambda_1^{2i-1} = w$ cancels with Case (6). The remaining cases give $(\lambda^0, \lambda^2, \dots, \lambda^{2n}) \in \text{VT}'_n(h, w)$. More precisely, Cases (1) and (4) correspond to the case where λ^{2i-2} and λ^{2i} differ by one cell, Case (3) corresponds to the case where $\lambda^{2i-2} = \lambda^{2i}$ with $\lambda_h^{2i} \neq 0$ and $\lambda_1^{2i} = w$, and Case (5) with $\lambda_1^{2i-1} \leq w - 1$ corresponds to the case where $\lambda^{2i-2} = \lambda^{2i}$ with $\lambda_h^{2i} = 0$ and $\lambda_1^{2i} \neq w$. Thus $A - B$ is equal to the right-hand side of (8.5), which completes the proof. \square

The limit case as $w \rightarrow \infty$ of the identities (8.2) and (8.3) is the main result in [37], while the limit case as $w \rightarrow \infty$ of (8.4) appears in [7, Conjecture 1.2, proved in Theorem 1.3]. See Corollary B.5 in Appendix B for a uniform bijective treatment of both.

Vacillating tableaux are closely related to matchings. A (*partial*) *matching* on $\{1, 2, \dots, n\}$ is a set partition of $\{1, 2, \dots, n\}$ into blocks of size one or two. The element in a singleton block is called a *fixed point* and a pair (i, j) of integers $i < j$ that are contained in a block of size two is called an *arc*. Next we define various kinds of crossings and nestings for matchings, and various sets of matchings subject to restrictions on their crossings and nestings.

Definition 8.3. Let k be a positive integer. A k -*crossing* is a set of k arcs $(i_1, j_1), \dots, (i_k, j_k)$ for which $i_1 < \dots < i_k < j_1 < \dots < j_k$. A k -*nesting* is a set of k arcs $(i_1, j_1), \dots, (i_k, j_k)$ for which $i_1 < \dots < i_k < j_k < \dots < j_1$. We say that a matching is k -*noncrossing* (respectively k -*nonnesting*) if it does not have any k -crossing (respectively k -nesting).

We denote the set of r -noncrossing and s -nonnesting matchings on $\{1, 2, \dots, n\}$ by $\text{NCNN}_n(r, s)$.

Definition 8.4. Let k be a positive integer. A $(k + 1/2)$ -*crossing* is a set of k arcs $(i_1, j_1), \dots, (i_k, j_k)$ and a fixed point v for which $i_1 < \dots < i_k < v < j_1 < \dots < j_k$. A $(k + 1/2)$ -*nesting* is a set of k arcs $(i_1, j_1), \dots, (i_k, j_k)$ and a fixed point v for which $i_1 < \dots < i_k < v < j_k < \dots < j_1$. We say that a matching is $(k + 1/2)$ -*noncrossing* (respectively $(k + 1/2)$ -*nonnesting*) if it does not have any t -crossing (respectively t -nesting) for $t \geq k + 1/2$.

Note that a matching is $(k + 1/2)$ -noncrossing if and only if it has neither a $(k + 1/2)$ -crossing nor a $(k + 1)$ -crossing. A similar remark holds for $(k + 1/2)$ -nonnesting matchings.

For an integer n and integers or half-integers r and s , we denote by $\text{NCNN}_n(r, s)$ the set of r -noncrossing and s -nonnesting matchings on $\{1, 2, \dots, n\}$.

Definition 8.5. Let $\text{NCNN}'_n(h + 1, w + 1)$ to be the set of matchings in $\text{NCNN}_n(h + 1, w + 1)$ in which every fixed point v satisfies one of the following conditions:

- v is not contained in any $(h + 1/2)$ -crossing and any $(w + 1/2)$ -nesting,
- v is contained in both an $(h + 1/2)$ -crossing and a $(w + 1/2)$ -nesting.

For $M \in \text{NCNN}'_n(h + 1, w + 1)$, let $z(M)$ be the number of fixed points in M that are contained in both an $(h + 1/2)$ -crossing and a $(w + 1/2)$ -nesting.

The following lemma connects $(h + 1)$ -noncrossing and $(w + 1)$ -nonnesting matchings and vacillating tableaux in $\text{VT}_n(h, w)$.

Lemma 8.6. Let h, w , and n be positive integers. There is a bijection $\phi : \text{NCNN}_n(h + 1, w + 1) \rightarrow \text{VT}_n(h, w)$ such that, if $\phi(M) = T = (\lambda^0, \lambda^1, \dots, \lambda^n)$, then the following hold:

- i is a fixed point of M if and only if the i -th step of T is a zero step, i.e., $\lambda^{i-1} = \lambda^i$,
- i is a fixed point of M contained in an $(h + 1/2)$ -crossing if and only if the i -th step of T is a zero step not on the hyperplane $x_h = 0$, i.e., $\lambda^{i-1} = \lambda^i$ and $\lambda_h^i > 0$,
- i is a fixed point of M contained in a $(w + 1/2)$ -nesting if and only if the i -th step of T is a zero step on the hyperplane $x_1 = w$, i.e., $\lambda^{i-1} = \lambda^i$ and $\lambda_1^i = w$.

Proof. Consider the bijection due to Chen et al. [3, Sec. 5] between complete matchings and oscillating tableaux, which are vacillating tableaux without zero steps. We can extend this map to partial matchings and vacillating tableaux by doing nothing when we encounter a fixed point. Alternatively, consider the growth diagram version of the same bijection in [22, end of Sec. 3], and treat fixed points as indicated in [22, Fig. 6].

It is straightforward to check that this bijection satisfies the given conditions. \square

Example 8.7. Let $n = 3, h = 1$, and $w = 1$. Then $\text{NCNN}_n(h + 1, w + 1/2) = \text{NCNN}_n(h + 1/2, w + 1)$ has three elements, namely, $\emptyset, \{(1, 2)\}, \{(2, 3)\}$, where we only consider the arcs and omit the fixed points. Here,

$\{(1, 3)\}$ is the only forbidden matching. The corresponding lattice paths of length 3 in $\{1 \geq x_1 \geq 0\}$ are $(0, 0, 0, 0)$, $(0, 1, 0, 0)$, and $(0, 0, 1, 0)$. Note that $(0, 1, 1, 0)$ is not allowed because a zero step is used when $x_1 = 1$.

The following proposition is an immediate consequence of Lemma 8.6.

Proposition 8.8. *For positive integers h , w , and n , we have*

$$(8.6) \quad |\text{NCNN}_n(h+1, w+1)| = |\text{VT}_n(h, w)|,$$

$$(8.7) \quad |\text{NCNN}_n(h+1, w+1/2)| = |\text{VT}_n(h, w^*)|,$$

$$(8.8) \quad |\text{NCNN}_n(h+1/2, w+1)| = |\text{VT}_n(h^*, w)|,$$

$$(8.9) \quad \sum_{M \in \text{NCNN}'_n(h+1, w+1)} (-1)^{z(M)} = \sum_{T \in \text{VT}'_n(h, w)} (-1)^{z(T)}.$$

By Corollary 8.2 and Proposition 8.8, we are able to connect cylindric standard Young tableaux and matchings.

Corollary 8.9. *For positive integers h , w , and n , we have*

$$(8.10) \quad |\text{CSYT}_n(2h+1, 2w+1)| = |\text{NCNN}_n(h+1, w+1)|,$$

$$(8.11) \quad |\text{CSYT}_n(2h+1, 2w)| = |\text{NCNN}_n(h+1, w+1/2)|,$$

$$(8.12) \quad |\text{CSYT}_n(2h, 2w+1)| = |\text{NCNN}_n(h+1/2, w+1)|,$$

$$(8.13) \quad |\text{CSYT}_n(2h, 2w)| = \sum_{M \in \text{NCNN}'_n(h+1, w+1)} (-1)^{z(M)}.$$

Clearly, the identities (8.10) and (8.11) reduce to (1.8) for $w \rightarrow \infty$. The latter identity, together with the limit case as $w \rightarrow \infty$ of (8.12) are discussed in Appendix B from a bijective point of view; see Corollary B.3.

In the next section we will show that (8.10) and (8.11) reduce to a result of Mortimer and Prellberg [29] if $h = 1$. We will also give a bijective proof of (8.12) and (8.13) for $h = 1$. Finding a bijective proof for the general case is an open problem.

Problem 8.10. Find a bijective proof of Corollary 8.9 for general h and w .

The results of Corollary 8.9 — or rather the results missing there — raise two further questions.

Problem 8.11. Is there a “signless” relation between the cylindric standard Young tableaux in $\text{CSYT}(2h, 2w)$ and matchings with restrictions on their crossings and nestings?

Problem 8.12. Are the matchings in $\text{NCNN}(h+1/2, w+1/2)$ related to cylindric standard Young tableaux?

Problem 8.13. Find an explicit formula for the number of elements in $\text{NCNN}(h+1/2, w+1/2)$.

9. MORTIMER AND PRELLBERG’S RESULT AND BIJECTIVE PROOFS

Here we focus our attention on the special case of Corollary 8.9 where $h = 1$. We show that if $h = 1$ then the first two identities, (8.10) and (8.11), are equivalent to a result of Mortimer and Prellberg [29], for which a bijective proof has been given by Courtiel, Elvey Price and Marcovici [4]. We then give a bijective proof of the last two identities, (8.12) and (8.13), for $h = 1$.

The above mentioned result of Mortimer and Prellberg involves walks in a triangle respectively bounded Motzkin paths, which we define next.

Definition 9.1. We let $T_n(m)$ denote the set of walks p of length n from $(0, 0)$ to any point in \mathbb{Z}^2 consisting of steps in $\{(1, 0), (0, 1), (-1, -1)\}$ with the property that p is contained in the triangular region $\{(x_1, x_2) \in \mathbb{R}^2 : m \geq x_1 \geq x_2 \geq 0\}$.

Definition 9.2. A *Motzkin path* of length n is a path from $(0, 0)$ to $(n, 0)$ consisting of *up steps* $(1, 1)$, *down steps* $(1, -1)$, and *horizontal steps* $(1, 0)$ that never goes below the x -axis. The *height* of a Motzkin path is the largest y -coordinate of a point in it. We denote by $\text{Mot}_n(m)$ the set of Motzkin paths of length n with height at most m .

We consider the following three subsets of $\text{Mot}_n(w)$:

$$\text{Mot}'_n(w) = \{p \in \text{Mot}_n(w) : p \text{ has no horizontal step on the line } x_2 = w\},$$

$$\text{Mot}^1_n(w) = \{p \in \text{Mot}_n(w) : \text{every horizontal step of } p \text{ lies on the line } x_2 = 0\},$$

$$\text{Mot}^2_n(w) = \{p \in \text{Mot}_n(w) : \text{every horizontal step of } p \text{ lies on the lines } x_2 = 0 \text{ and } x_2 = w\}.$$

A Motzkin path without horizontal steps is called a *Dyck path*. A *Dyck prefix* is a sequence of points that can be extended to a Dyck path. Let $\text{DP}_n(w)$ denote the set of Dyck prefixes of length n contained in the region $\{(x_1, x_2) \in \mathbb{R}^2 : 0 \leq x_2 \leq w\}$. We now give an equivalent statement of Corollary 8.9 with $h = 1$.

Theorem 9.3. For positive integers w and n ,

$$(9.1) \quad |T_n(2w + 1)| = |\text{Mot}_n(w)|,$$

$$(9.2) \quad |T_n(2w)| = |\text{Mot}'_n(w)|,$$

$$(9.3) \quad |\text{DP}_n(2w + 1)| = |\text{Mot}^1_n(w)|,$$

$$(9.4) \quad |\text{DP}_n(2w)| = \sum_{p \in \text{Mot}^2_n(w)} (-1)^{k(p)},$$

where $k(p)$ is the number of horizontal steps of p on the line $x_2 = w$.

Proof. First, we give a bijection between $\text{CSYT}_n(3, w)$ and $T_n(w)$. Let $T \in \text{CSYT}_n(3, w)$. Then the corresponding path $p = (p_0, \dots, p_n) \in T_n(w)$ is constructed as follows. Let $p_0 = (0, 0)$ and define p_i by

$$p_i = \begin{cases} p_{i-1} + (1, 0), & \text{if } i \text{ is in the first row of } T, \\ p_{i-1} + (0, 1), & \text{if } i \text{ is in the second row of } T, \\ p_{i-1} + (-1, -1), & \text{if } i \text{ is in the third row of } T, \end{cases}$$

for $i = 1, 2, \dots, n$. It is easy to check that the map $T \mapsto p$ is a bijection between $\text{CSYT}_n(3, w)$ and $T_n(w)$.

Second, we give a bijection between $\text{CSYT}_n(2, w)$ and $\text{DP}_n(w)$ in a similar way. For $T \in \text{CSYT}_n(2, w)$, the corresponding path $p = (p_0, \dots, p_n) \in \text{DP}_n(w)$ is defined by $p_0 = (0, 0)$ and

$$p_i = \begin{cases} p_{i-1} + (1, 1), & \text{if } i \text{ is in the first row of } T, \\ p_{i-1} + (1, -1), & \text{if } i \text{ is in the second row of } T, \end{cases}$$

for $i = 1, 2, \dots, n$. It is also easy to check that the map $T \mapsto p$ is a bijection between $\text{CSYT}_n(2, w)$ and $\text{DP}_n(w)$.

Third, we find a bijection between $\text{NCNN}_n(2, w + 1)$ and $\text{Mot}_n(w)$. This is in fact a well-known bijection between noncrossing matchings and Motzkin paths. Let $M \in \text{NCNN}_n(2, w + 1)$. Recall that i is a fixed point of M if i is not connected to any integer by an arc. An integer i is called an *opener* (respectively *closer*) of M if it is connected to j by an arc for some $j > i$ (respectively $j < i$). Since M does not have any 2-crossings, it is determined by its openers, closers, and fixed points. Therefore we can construct the corresponding Motzkin path $p = (p_0, \dots, p_n)$ as follows. Let $p_0 = (0, 0)$ and define

$$p_i = \begin{cases} p_{i-1} + (1, 1), & \text{if } i \text{ is an opener of } M, \\ p_{i-1} + (1, -1), & \text{if } i \text{ is a closer of } M, \\ p_{i-1} + (1, 0), & \text{if } i \text{ is a fixed point of } M, \end{cases}$$

for $i = 1, 2, \dots, n$. Since M does not have a $(w + 1)$ -nesting, the Motzkin path p stays in the region $\{(x_1, x_2) \in \mathbb{R}^2 : 0 \leq x_2 \leq w\}$. One can easily check that the map $M \mapsto p$ is a bijection between $\text{NCNN}_n(2, w + 1)$ and $\text{Mot}_n(w)$.

Similarly one can check that the same map $M \mapsto p$ also induces a bijection between $\text{NCNN}_n(2, w + 1/2)$ and $\text{Mot}'_n(w)$, a bijection between $\text{NCNN}_n(1 + 1/2, w + 1)$ and $\text{Mot}^1_n(w)$, and a bijection between $\text{NCNN}'_n(2, w + 1)$ and $\text{Mot}^2_n(w)$. Moreover, if $M \in \text{NCNN}'_n(2, w + 1)$ corresponds to $p \in \text{Mot}^2_n(w)$, then $z(M) = k(p)$.

Applying the above bijections to Corollary 8.9 with $h = 1$, we immediately obtain the desired identities. \square

The identities (9.1) and (9.2) were first proved by Mortimer and Prellberg [29] using the kernel method. Recently, Courtiel, Elvey Price and Marcovici [4] found a bijective proof of these two identities. In the rest of this section, we give bijective proofs of (9.3) and of (9.4). To simplify the right-hand side of (9.4), we need the following definition and lemma.

Definition 9.4. For $p = (p_0, p_1, \dots, p_n) \in \text{Mot}^2_n(w)$, a horizontal step $p_{j+1} - p_j$ is called *special* if one of the following conditions holds:

- $p_{j+1} - p_j$ lies on the line $x_2 = w$;
- $p_{j+1} - p_j$ lies on the line $x_2 = 0$, $(p_0, p_1, \dots, p_j) \in \text{Mot}^1_j(w)$ with an even number of horizontal steps, and there is an integer i with $j < i < n$ such that $(p_{j+1}, p_{j+2}, \dots, p_{i+1})$ is a (translated) Dyck prefix from $(j + 1, 0)$ to $(i + 1, w)$.

We define

$$\text{Mot}^3_n(w) = \{p \in \text{Mot}^2_n(w) : p \text{ has no special horizontal step}\},$$

so that $\text{Mot}^3_n(w) \subseteq \text{Mot}^1_n(w)$.

Lemma 9.5. For positive integers w and n ,

$$|\text{Mot}^3_n(w)| = \sum_{p \in \text{Mot}^2_n(w)} (-1)^{k(p)},$$

where $k(p)$ is the number of horizontal steps of p on the line $x_2 = w$.

Proof. For $p \in \text{Mot}^2_n(w)$, we define $\text{sgn}(p) = (-1)^{k(p)}$. It suffices to find a sign-reversing involution ϕ on $\text{Mot}^2_n(w)$ whose fixed points are exactly those in $\text{Mot}^3_n(w)$.

Let $p \in \text{Mot}^2_n(w)$. If $p \in \text{Mot}^3_n(w)$, then define $\phi(p) = p$. Otherwise, we can find the smallest integer j with $0 \leq j < n$ such that $p_{j+1} - p_j$ is special. Suppose that the first special horizontal step $p_{j+1} - p_j$ lies on the line $x_2 = w$. Then we can find the largest integer i with $0 \leq i < j$ such that $(p_i, p_{i+1}, \dots, p_j)$ is a (translated) Dyck prefix. Define $\phi(p) = (p_0, \dots, p_i, r(p_j), r(p_{j-1}), \dots, r(p_{i+1}), p_{j+1}, \dots, p_n)$, where r is the reflection about the point $((j - i + 1)/2, w/2)$. Then $q = \phi(p)$ has the first special horizontal step $q_{i+1} - q_i$ on the line $x_2 = 0$ and $k(q) = k(p) - 1$. Now suppose that p has the first special horizontal step $p_{j+1} - p_j$ on the line $x_2 = 0$. Then $(p_0, p_1, \dots, p_j) \in \text{Mot}^1_j(w)$ with an even number of horizontal steps, and we can find the smallest integer i with $j < i < n$ such that $(p_{j+1}, p_{j+2}, \dots, p_{i+1})$ is a translated Dyck prefix from $(j + 1, 0)$ to $(i + 1, w)$. Define $\phi(p) = (p_0, \dots, p_j, r(p_i), r(p_{i-1}), \dots, r(p_{j+1}), p_{i+1}, \dots, p_n)$, where r is the reflection about the point $((i - j + 1)/2, w/2)$. In this case, $q = \phi(p)$ has the first special horizontal step $q_{i+1} - q_i$ on the line $x_2 = w$ and $k(q) = k(p) + 1$. One can easily check that ϕ is an involution, which completes the proof. \square

Figure 10 shows an example of the involution ϕ defined in the proof of Lemma 9.5.

By Lemma 9.5, the identity (9.4) is equivalent to $|\text{DP}_n(2w)| = |\text{Mot}^3_n(w)|$. To prove (9.3) and (9.4), we adopt a bijection between the set of bounded Dyck prefixes and the set of bounded up-down paths due to Dershowitz.

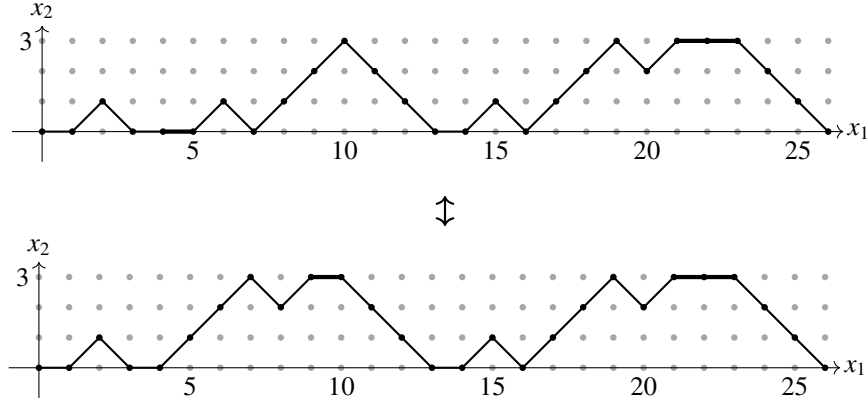

FIGURE 10. An example of the involution ϕ on $\text{Mot}_{26}^2(3)$. The thick horizontal lines indicate the special horizontal steps.

An up-down path of length n is a path from $(0, 0)$ to $(n, (1 + (-1)^{n+1})/2)$ consisting of upward diagonal steps $(1, 1)$ and downward diagonal steps $(1, -1)$. Let $\text{UDP}_n(w)$ denote the set of up-down paths of length n staying in the region

$$\left\{ (x_1, x_2) \in \mathbb{R}^2 : -\left\lfloor \frac{w}{2} \right\rfloor \leq x_2 \leq \left\lfloor \frac{w+1}{2} \right\rfloor \right\}.$$

A standard reflection argument (cf. [23, Th. 10.3.3] under rotation by 45°) yields

$$|\text{DP}_n(w)| = |\text{UDP}_n(w)| = \sum_{j \in \mathbb{Z}} (-1)^j \binom{n}{\lfloor \frac{n+(w+2)j}{2} \rfloor}.$$

Recently, Gu and Prodinger [17] and Dershowitz [5] found simple bijections between $\text{DP}_n(w)$ and $\text{UDP}_n(w)$ independently. Here, we briefly introduce Dershowitz's bijection.

Let p be an up-down path from $(0, 0)$ to (n, m) . For an integer k , the *TA representation of p relative to k* is the word $r_1 r_2 \dots r_n$, where r_i is the letter T (respectively A) if the i -th step of p moves towards (respectively away from) the line $x_2 = k$. Note that any up-down path (whose starting point is $(0, 0)$) is uniquely determined by its TA representation. Now let $p \in \text{DP}_n(w)$. Suppose that $r_1 r_2 \dots r_n$ is the TA representation of p relative to $\lceil h(p)/2 \rceil - 1/2$, where $h(p)$ is the largest x_2 -coordinate of the points in p . Let j be the smallest integer such that the height of the ending point of the j -th step of p equals $\lfloor h/2 \rfloor$. Then define $\phi(p)$ to be the up-down path whose TA representation relative to $1/2$ is $r_{j+1} r_{j+2} \dots r_n r_j r_{j-1} \dots r_1$. Dershowitz [5] showed that $\phi : \text{DP}_n(w) \rightarrow \text{UDP}_n(w)$ is a bijection.

Our last ingredient is a map $\psi : \text{UDP}_n(w) \rightarrow \text{Mot}_n^1(\lfloor w/2 \rfloor)$. For $p = (p_0, p_1, \dots, p_n) \in \text{UDP}_n(w)$, define $\psi(p) = (q_0, q_1, \dots, q_n)$, where

$$q_i = \begin{cases} p_i + (0, -1), & \text{if } p_i \text{ is above the line } x_2 = 1/2, \\ -p_i, & \text{otherwise,} \end{cases}$$

for $i = 0, 1, \dots, n$. One can easily see that $\psi : \text{UDP}_n(2w+1) \rightarrow \text{Mot}_n^1(w)$ and $\psi : \text{UDP}_n(2w) \rightarrow \text{Mot}_n^3(w)$ are bijections. The combination of the maps ϕ and ψ completes the proof of (9.3) and (9.4). Figure 11 shows examples of the maps $\phi : \text{DP}_{26}(6) \rightarrow \text{UDP}_{26}(6)$ and $\psi : \text{UDP}_{26}(6) \rightarrow \text{Mot}_{26}^3(3)$.

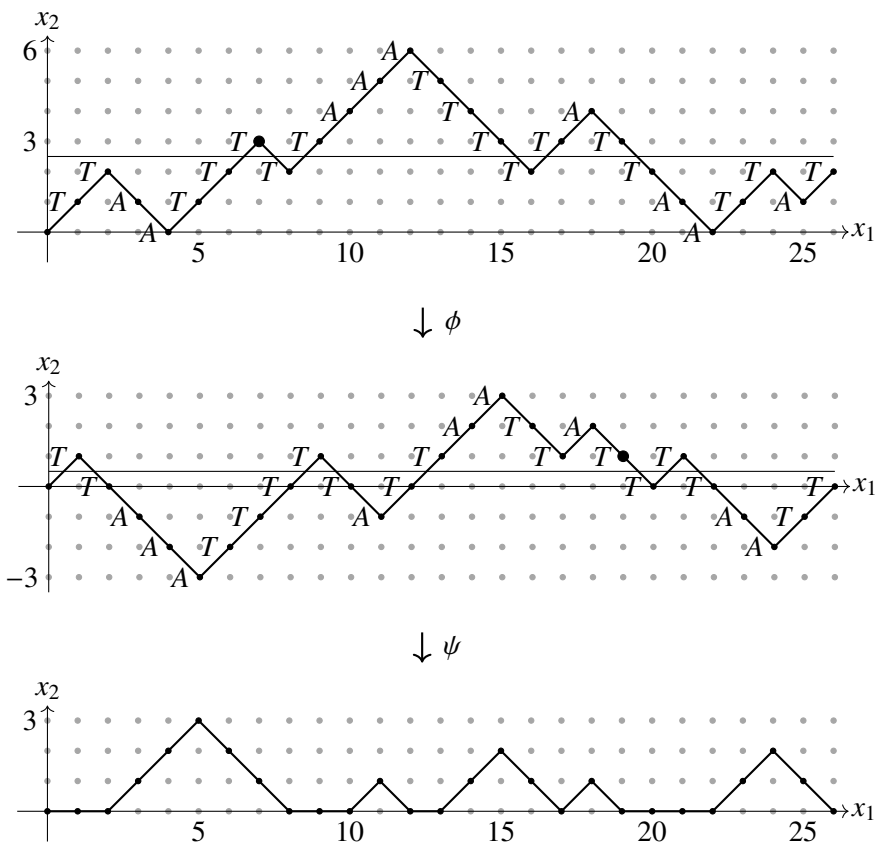

FIGURE 11. An example of the bijection between $DP_{26}(6)$ and $Mot_{26}^3(3)$.

APPENDIX A. THE DISCOVERY OF THE BOUNDED LITTLEWOOD IDENTITIES FOR CYLINDRIC SCHUR FUNCTIONS

Since we believe that the path of discovery of the new bounded Littlewood identities in Theorem 1.2 (restated in Theorem 3.1) is quite interesting (and unexpected), and therefore should not be kept a secret from the reader, we dedicate this appendix to a description of our line of thought that — in the end — led us to the identities in (3.1) and (3.2), and the further identities in Theorems 3.3 and 3.4.

Our original goal was to find a bijective proof of the enumeration result of Mortimer and Prellberg [29] that we discussed in Section 9, and which these authors established by some generating function calculus based on the kernel method. In order to state their result, we must recall from Definition 9.1 that $T_n(m)$ denotes the set of walks of length n starting at the origin, consisting of steps $(1, 0)$, $(0, 1)$, and $(-1, -1)$, and staying in the triangular region $\{(x_1, x_2) \in \mathbb{R}^2 : m \geq x_1 \geq x_2 \geq 0\}$, and from Definition 9.2 that $Mot_n(h)$ is the set of Motzkin paths of length n of height at most h .

Mortimer and Prellberg [29] proved the following surprising identity using the kernel method:

$$(A.1) \quad |T_n(2h + 1)| = |Mot_n(h)|.$$

As given away above, we wanted to construct a bijective proof of this intriguing identity. We first observed that (A.1) is not the most transparent formulation of this identity. In order to motivate our reformulation below, let us first consider the limiting case where $h \rightarrow \infty$, i.e.,

$$(A.2) \quad |T_n(\infty)| = |Mot_n(\infty)|.$$

Each walk $p = (p_0, \dots, p_n) \in T_n(\infty)$ can be identified with the sequence $(\lambda^0, \dots, \lambda^n)$ of partitions with at most three rows, where $\lambda^0 = \emptyset$ and λ^i is obtained from λ^{i-1} by adding a cell to the first (respectively second and third) row if p_i is $(1, 0)$ (respectively $(0, 1)$ and $(-1, -1)$). This sequence of partitions is in turn naturally identified with a standard Young tableau of size n with height at most 3; see the proof of Theorem 9.3 for more details. On the other hand, there is a simple and well-known bijection between $\text{Mot}_n(\infty)$ and the set of 2-noncrossing matchings on $\{1, 2, \dots, n\}$. (We described it in the proof of Theorem 9.3.) Therefore (A.2) is equivalent to

$$|\text{SYT}_n(3)| = |\text{NC}_n(2)|,$$

where as before $\text{SYT}_n(3)$ is the set of standard Young tableaux of size n with at most 3 rows and $\text{NC}_n(2)$ is the set of 2-noncrossing matchings on $\{1, 2, \dots, n\}$.

It is not hard to check that the bijection between $T_n(\infty)$ and $\text{SYT}_n(3)$ induces a bijection between $T_n(2w+1)$ and $\text{CSYT}_n(3, 2w+1)$.² On the other hand, the bijection between Motzkin paths and 2-noncrossing matchings also implies $|\text{Mot}_n(w)| = |\text{NCNN}_n(2, w+1)|$. Therefore we can restate Mortimer and Prellberg's result (A.1) as follows:

$$|\text{CSYT}_n(3, 2w+1)| = |\text{NCNN}_n(2, w+1)|.$$

One may now speculate that this identity holds in greater generality, namely that we have

$$(A.3) \quad |\text{CSYT}_n(2h+1, 2w+1)| = |\text{NCNN}_n(h+1, w+1)|$$

(which was stated as (1.9) in the introduction, and proved in Corollary 8.9). Indeed, computer experiments confirmed the truth of (A.3).

The question now was how to prove this more general identity. Obviously, the most desirable proof would consist in finding a bijection between $\text{CSYT}_n(2h+1, 2w+1)$ and $\text{NCNN}_n(h+1, w+1)$. In lack of a good idea, we went instead for a computational proof based on explicit formulas. Indeed, as we explained in Proposition 2.7, the tableaux in $\text{CSYT}_n(2h+1, 2w+1)$ are in bijection with lattice paths in \mathbb{Z}^{2h+1} starting at the origin, consisting of positive unit steps in coordinate directions, and staying in the region

$$\{(x_1, x_2, \dots, x_{2h+1}) : x_1 \geq x_2 \geq \dots \geq x_{2h+1} \geq x_1 - (2w+1)\}.$$

If the end point is also given, say $(\lambda_1, \lambda_2, \dots, \lambda_{2h+1})$, then there is a formula which gives the number of such paths due to Filaseta [8] (which turned out to be a special case of the more general random-walks-in-Weyl-chambers formula of Gessel and Zeilberger [12]). Using this formula, we get the following formula for the number of our tableaux:

$$(A.4) \quad |\text{CSYT}_n(2h+1, 2w+1)| = \sum_{|\lambda|=n} \sum_{\substack{k_1, \dots, k_{2h+1} \in \mathbb{Z} \\ \lambda_1 - \lambda_{2h+1} \leq 2w+1, k_1 + \dots + k_{2h+1} = 0}} n! \det_{1 \leq i, j \leq 2h+1} \left(\frac{1}{(\lambda_i - i + j + (2h+2w+2)k_i)!} \right).$$

On the other hand, by a result of Chen et al. [3, Sec. 3] (see [22] for a more transparent presentation), the matchings in $\text{NCNN}_n(h+1, w+1)$ are in bijection with vacillating tableaux $\emptyset = \rho_0, \rho_1, \dots, \rho_{n-1}, \rho_n = \emptyset$, where each ρ_i has at most h rows and at most w columns. (Here, ‘‘vacillating’’ does not have the same meaning as in [3], but rather means that two successive partitions in the above sequence differ by at most one cell; one obtains these sequences from those of [3, Sec. 3] by ignoring the partitions in odd positions and just keeping those in even positions; no information is lost since it is only the special case of partial matchings that we are interested in.) In turn, these vacillating tableaux can be seen as lattice paths in \mathbb{Z}^h starting at and returning to the origin, consisting of positive *and negative* unit steps in coordinate directions *and zero steps*, and staying in the region

$$\{(x_1, x_2, \dots, x_h) : w \geq x_1 \geq x_2 \geq \dots \geq x_h \geq 0\}.$$

²Elizalde [6] also found this bijection independently.

Also for these paths there exists a formula (also following from the result of Gessel and Zeilberger), namely [16, Eq. (19)]. Applied to our situation, it gives the following formula for the above number of matchings:

$$(A.5) \quad |\text{NCNN}_n(h+1, w+1)| = \sum_{m \geq 0} \binom{n}{2m} \cdot \left\langle \frac{x^{2m}}{(2m)!} \right\rangle \sum_{k_1, \dots, k_h \in \mathbb{Z}} \det_{1 \leq i, j \leq h} \left(I_{-i+j+(2h+2w+2)k_i}(2x) - I_{i+j+(2h+2w+2)k_i}(2x) \right),$$

where $I_\alpha(x)$ is the modified Bessel function given by

$$I_\alpha(x) = \sum_{\ell \geq 0} \frac{(x/2)^{2\ell+\alpha}}{\ell! (\ell + \alpha)!},$$

and $\langle x^M \rangle g(x)$ denotes the coefficient of x^M in the power series $g(x)$. The task now is to establish equality of the expressions in (A.4) and (A.5). Again, we were short of a good idea.

On the other hand, a “general principle” says that, by making things more general, they may become easier. Now, there is another “general principle” that says that, whenever one encounters an identity related to, respectively involving *standard* Young tableaux, then there should exist a more general identity for *semistandard* Young tableaux! In its turn, this more general identity would be formulated in terms of *symmetric functions*. This “principle” is based on the simple fact that

$$\frac{n!}{m_1! m_2! \cdots m_k!} = \langle x_1 x_2 \cdots x_n \rangle e_{m_1}(\mathbf{x}) \cdots e_{m_k}(\mathbf{x}),$$

with $m_1 + m_2 + \cdots + m_k = n$. In other words, a multinomial coefficient is a product of elementary symmetric functions *in disguise*. This is straightforward to carry out for (A.4), which becomes

$$(A.6) \quad |\text{CSYT}_n(2h+1, 2w+1)| = \langle x_1 x_2 \cdots x_n \rangle \sum_{|\lambda|=n} \sum_{\substack{k_1, \dots, k_{2h+1} \in \mathbb{Z} \\ \lambda_1 - \lambda_{2h+1} \leq 2w+1, k_1 + \cdots + k_{2h+1} = 0}} \det_{1 \leq i, j \leq 2h+1} \left(e_{\lambda_i - i + j + (2h+2w+2)k_i}(\mathbf{x}) \right).$$

It takes not much more effort to see that, under this perspective, (A.5) becomes

$$(A.7) \quad |\text{NCNN}_n(h+1, w+1)| = \langle x_1 x_2 \cdots x_n \rangle \sum_{k \geq 0} e_k(\mathbf{x}) \sum_{k_1, \dots, k_h \in \mathbb{Z}} \det_{1 \leq i, j \leq h} \left(f_{-i+j+(2h+2w+2)k_i}(\mathbf{x}) - f_{i+j+(2h+2w+2)k_i}(\mathbf{x}) \right),$$

where, as before,

$$f_\alpha(\mathbf{x}) = \sum_{\ell \geq 0} e_\ell(\mathbf{x}) e_{\ell+\alpha}(\mathbf{x}).$$

One may now speculate that the equality of (A.4) and (A.5) is just the “shadow” of a symmetric function identity. In other words, maybe the symmetric functions on the right-hand sides of (A.6) and (A.7) are the same:

$$(A.8) \quad \sum_{\substack{\lambda: \ell(\lambda) \leq 2h+1 \\ \lambda_1 - \lambda_{2h+1} \leq 2w+1}} \sum_{\substack{k_1, \dots, k_{2h+1} \in \mathbb{Z} \\ k_1 + \cdots + k_{2h+1} = 0}} \det_{1 \leq i, j \leq 2h+1} \left(e_{\lambda_i - i + j + (2h+2w+2)k_i}(\mathbf{x}) \right) \\ = \sum_{k \geq 0} e_k(\mathbf{x}) \sum_{k_1, \dots, k_h \in \mathbb{Z}} \det_{1 \leq i, j \leq h} \left(f_{-i+j+(2h+2w+2)k_i}(\mathbf{x}) - f_{i+j+(2h+2w+2)k_i}(\mathbf{x}) \right).$$

Computer experiments confirmed that. At this point, one becomes cocky: is it really important to have $2w + 1$ as constraint on the difference between λ_1 and λ_{2h+1} ? Phrased differently, does (A.8) continue to hold if we replace $2w + 1$ by w , i.e., is it true that

$$(A.9) \quad \sum_{\substack{\lambda: \ell(\lambda) \leq 2h+1 \\ \lambda_1 - \lambda_{2h+1} \leq w}} \sum_{\substack{k_1, \dots, k_{2h+1} \in \mathbb{Z} \\ k_1 + \dots + k_{2h+1} = 0}} \det_{1 \leq i, j \leq 2h+1} \left(e_{\lambda_i - i + j + (2h+w+1)k_i}(\mathbf{x}) \right) \\ = \sum_{k \geq 0} e_k(\mathbf{x}) \sum_{k_1, \dots, k_h \in \mathbb{Z}} \det_{1 \leq i, j \leq h} \left(f_{-i+j+(2h+w+1)k_i}(\mathbf{x}) - f_{i+j+(2h+w+1)k_i}(\mathbf{x}) \right),$$

for positive integers w ? Obviously, we consulted again the computer, and it said “yes”. We had found (1.5)!

In view of these findings, another obvious question was what would happen if, instead of replacing $2w + 1$ by w , we would replace $2h + 1$ by $2h$. (One could not hope for an identity that would be uniform in odd *and* even bounds on the difference of the first and last part of λ in the sum on the left-hand side.) It did not escape our attention that, for $w \rightarrow \infty$, the identity (A.9) reduces to the bounded Littlewood identity (1.2). As is well known, this identity in turn comes with a companion identity, namely (1.3). We thus had an “obvious” candidate for an “even” analog of (A.9):

$$\sum_{\substack{\lambda: \ell(\lambda) \leq 2h \\ \lambda_1 - \lambda_{2h} \leq w}} \sum_{\substack{k_1, \dots, k_{2h} \in \mathbb{Z} \\ k_1 + \dots + k_{2h} = 0}} \det_{1 \leq i, j \leq 2h} \left(e_{\lambda_i - i + j + (2h+w)k_i}(\mathbf{x}) \right) \stackrel{?}{=} \sum_{k_1, \dots, k_h \in \mathbb{Z}} \det_{1 \leq i, j \leq h} \left(f_{-i+j+(2h+w)k_i}(\mathbf{x}) + f_{i+j-1+(2h+w)k_i}(\mathbf{x}) \right).$$

Alas, computer calculations quickly told us that this identity is wrong. However, not too much! Inspection of the first terms in the expansion and further computer calculations led us to discover that there was only a sign missing on the right-hand side:

$$(A.10) \quad \sum_{\substack{\lambda: \ell(\lambda) \leq 2h \\ \lambda_1 - \lambda_{2h} \leq w}} \sum_{\substack{k_1, \dots, k_{2h} \in \mathbb{Z} \\ k_1 + \dots + k_{2h} = 0}} \det_{1 \leq i, j \leq 2h} \left(e_{\lambda_i - i + j + (2h+w)k_i}(\mathbf{x}) \right) \\ = \sum_{k_1, \dots, k_h \in \mathbb{Z}} (-1)^{\sum_{i=1}^h k_i} \det_{1 \leq i, j \leq h} \left(f_{-i+j+(2h+w)k_i}(\mathbf{x}) + f_{i+j-1+(2h+w)k_i}(\mathbf{x}) \right).$$

We had found (1.6)!

Of course, there was still the problem of finding proofs of (A.9) and (A.10). However, now we were in a much better situation: we stood on firm grounds, by knowing where all this belonged to, namely to the area of *bounded Littlewood identities*. Stembridge [36, Th. 7.1] had provided a blueprint for the line of proof: write the left-hand side as a sum of minors of a given matrix; apply the minor summation formula in Corollary 4.3 to obtain a Pfaffian; apply Gordon’s reduction in Lemma 4.4 to reduce the Pfaffian to a determinant of half the size; simplify the determinant by applying elementary row and column operations, see Corollary 4.5. We managed to rewrite our left-hand sides as sums of minors of a given matrix; see the proofs of (5.9) and (5.14). It is interesting to note that, from there on, we “just” had to do the same steps as in Stembridge’s blueprint, except that the details of the calculations turned out to be more demanding.

Further investigations along the same lines — but somewhat more general since we now based the calculations on the full minor summation formula in Theorem 4.2 (instead of just Corollary 4.3) — in the end led us to come up with the further affine bounded Littlewood identities in Theorems 3.3 and 3.4.

In conclusion, while we still had (and have) no bijective proof of Mortimer and Prellberg’s identity (A.1) (as mentioned earlier, such a bijection was in fact found by Courtiel, Elvey Price and Marcovici [4]), nor of the generalization (A.3), instead we found new conceptual symmetric function identities that in particular *implied* (A.3) (and thus also (A.1)), namely the affine bounded Littlewood identities in Theorem 3.1. These

led us to many more combinatorial and algebraic results; see Sections 8 and 9, and a forthcoming sequel to this article.

APPENDIX B. BIJECTIONS BETWEEN STANDARD YOUNG TABLEAUX, MATCHINGS, AND VACILLATING TABLEAUX USING GROWTH DIAGRAMS

The purpose of this appendix is to review and clarify the relations between standard Young tableaux, matchings, and vacillating tableaux that one finds in the literature. We do this by using Fomin's growth diagrams, which allow us to give a uniform presentation.

More precisely, with $h = \lfloor m/2 \rfloor$, by means of explicit bijections, we are going to relate:

- * the set $\text{SYT}_n(m)$ of standard Young tableaux of size n with at most m rows;
- * the set $\text{NN}_n(h+1)$ of (partial) matchings on $\{1, 2, \dots, n\}$ without an $(h+1)$ -nesting;
- * the set $\text{NC}_n(h+1)$ of (partial) matchings on $\{1, 2, \dots, n\}$ without an $(h+1)$ -crossing;
- * the set $\text{VT}_n(h)$ of vacillating tableaux with at most h rows, that is, the set of sequences $(\emptyset = \lambda^0, \lambda^1, \dots, \lambda^n = \emptyset)$ of partitions, where λ^{i-1} and λ^i differ by at most one cell for $i = 1, 2, \dots, n$, and where λ^i has at most h rows for $i = 0, 1, \dots, n$.

We refer to Subsection 2.1 for the definition of standard Young tableaux, and to Definition 8.3 for the definition of crossings and nestings in matchings. We shall also need the subset $\text{NN}_n(h+1/2)$ of $\text{NN}_n(h+1)$, which by definition is the set of all elements of $\text{NN}_n(h+1)$ without an $(h+1/2)$ -nesting (cf. Definition 8.4). Similarly, we let $\text{NC}_n(h+1/2)$ be the subset of $\text{NC}_n(h+1)$ consisting of all elements of $\text{NC}_n(h+1)$ without an $(h+1/2)$ -crossing (cf. again Definition 8.4). Furthermore, we write $\text{VT}_n(h^*)$ for the subset of $\text{VT}_n(h)$ consisting of all those elements (walks) for which a zero step cannot occur on the hyperplane $x_h = 0$. The reader should also recall the meaning of $\text{NCNN}_n(r, s)$ from the paragraph above Definition 8.5.

We are going to provide bijections for the identities in the theorems and corollaries below. We start with the (enumerative) symmetry of matchings concerning crossings and nestings of matchings that has been the main theme in [3] (in the more general context of set partitions). Although not stated explicitly in [3], identity (B.1) below for integers r and s is a special case of the main theorem of [3] (namely [3, Th. 1.1] restricted to matchings).

Theorem B.1. *For positive integers n and positive integers of half-integers r and s , we have*

$$(B.1) \quad |\text{NCNN}_n(r, s)| = |\text{NCNN}_n(s, r)|.$$

The next theorem connects standard Young tableaux and matchings.

Theorem B.2. *For positive integers n and h , we have*

$$(B.2) \quad |\text{SYT}_n(2h+1)| = |\text{NN}_n(h+1)|,$$

$$(B.3) \quad |\text{SYT}_n(2h)| = |\text{NN}_n(h+1/2)|.$$

By combining Theorems B.1 and B.2, we obtain the following equalities. Since we are going to provide bijective proofs for the two theorems above, the appropriate combination of bijections also yields bijective proofs of these equalities.

Corollary B.3. *For positive integers n and h , we have*

$$(B.4) \quad |\text{SYT}_n(2h+1)| = |\text{NC}_n(h+1)|,$$

$$(B.5) \quad |\text{SYT}_n(2h)| = |\text{NC}_n(h+1/2)|.$$

Identity (B.4) was stated already as (1.8) in the introduction and, as explained in Appendix A, it inspired us to discover the more general identity in (8.10). Identity (B.4) arises from (8.12) as the limit case where $w \rightarrow \infty$.

Next, we relate matchings with restrictions on their nestings to vacillating tableaux (walks).

Theorem B.4. *For positive integers n and h , we have*

$$(B.6) \quad |\text{NN}_n(h+1)| = |\text{VT}_n(h)|,$$

$$(B.7) \quad |\text{NN}_n(h+1/2)| = |\text{VT}_n(h^*)|.$$

Here, identity (B.6) arises from (8.6) and (8.8) in the limit as $h \rightarrow \infty$, whereas identity (B.7) arises from (8.7) in the limit as $h \rightarrow \infty$.

Clearly, by combining Theorems B.2 and B.4 we obtain the following corollary. Since we are going to present bijections that prove Theorems B.2 and B.4, the appropriate combinations of bijective proofs also provide bijections for the identities below.

Corollary B.5. *For positive integers n and h , we have*

$$(B.8) \quad |\text{SYT}_n(2h+1)| = |\text{VT}_n(h)|,$$

$$(B.9) \quad |\text{SYT}_n(2h)| = |\text{VT}_n(h^*)|.$$

Identity (B.8) is the result of [37]. It is also stated in an equivalent form in [7, Th. 1.1], together with a bijective proof. Identity (B.9) is also stated in an equivalent form in [7], see Conjecture 1.2 and Theorem 1.3 there, and it is proved in [7] by a bijection.

We are now going to outline bijective proofs of (B.1)–(B.3) and of (B.6) and (B.7) using Fomin’s growth diagrams. We assume that the reader is familiar with the concept and application of growth diagrams, say as described in [22, Sec. 2]. In particular, we need the consequence of Greene’s theorem that prescribes the lengths of the first row and the first column of a partition in the growth diagram in terms of the lengths of longest NE- and SE-chains of the configuration of X ’s in the region to the left and below the partition; see [22, Th. 2].

Our first observation is that the identities in Theorem B.2 result directly from the application of the (inverse) Robinson–Schensted correspondence to the pair (T, T) , where T is the standard Young tableau from $\text{SYT}_n(2h+1)$ or $\text{SYT}_n(2h)$ that we are considering.

Proof of (B.2). Let $T \in \text{SYT}_n(2h+1)$. We illustrate all steps in parallel by considering the running example

1	2	5	6
3	7		
4	9		
8	10		
11			

which is a standard Young tableau of size 11 with 5 rows, that is, an element of $\text{SYT}_{11}(5) = \text{SYT}_{11}(2 \cdot 2 + 1)$.

Given T , we now fill an $n \times n$ growth diagram by putting the sequence of partitions arising by recording the subshapes of T formed by the entries $1, 2, \dots, i$ for $i = 0, 1, \dots, n$, along the left side of the $n \times n$ square of cells, in increasing order from the bottom to the top, and along the top side of the square, in increasing order from right to left. In our running example, this sequence of subshapes is

$$\emptyset \subseteq 1 \subseteq 2 \subseteq 21 \subseteq 211 \subseteq 311 \subseteq 411 \subseteq 421 \subseteq 4211 \subseteq 4221 \subseteq 4222 \subseteq 42221.$$

We have put this sequence to the left and on top of the 11×11 square in Figure 12. (The other labels in the diagram should be ignored at this point).

Now we apply the inverse growth diagram algorithm in direction bottom/right. This produces a collection of crosses that is symmetric with respect to the right/down diagonal of the square; see Figure 12. By labeling

42221	4222	4221	4211	421	411	311	211	21	2	1	0
						X					
4222	4221	4211	4111	411	311	311	211	21	2	1	0
					X						
4221	4211	4111	3111	311	311	311	211	21	2	1	0
			X								
4211	4111	3111	3111	311	311	311	211	21	2	1	0
										X ₁	
421	411	311	311	31	31	31	21	2	1		0
		X									
411	311	311	311	31	31	31	21	2	1	1	0
311	X	311	311	31	31	31	21	2	1	1	0
211	211	211	211	21	21	21	X ₂₁	2	1	1	0
21	21	21	21	2	2	2	2	1	X ₁	1	0
2	2	2	2	1	1	1	1	X ₁	1	1	0
1	1	1	1	X ₁	1	1	1	1	1	1	0
											X
0	0	0	0	0	0	0	0	0	0	0	0

FIGURE 12. Example for the bijection between $\text{SYT}_{11}(5)$ and $\text{NN}_{11}(3)$.

the rows by $1, 2, \dots, n$ from top to bottom and the columns from left to right, these crosses correspond to a matching (involution) on $\{1, 2, \dots, n\}$. In our running example, this matching is

$$(B.10) \quad \{(1, 6), (2, 5), (4, 10), (8, 9)\},$$

with $3, 7, 11$ being fixed points of the matching. The largest nestings have size 2 — namely $\{(1, 6), (2, 5)\}$ and $\{(4, 10), (8, 9)\}$ — hence this matching is an element of $\text{NN}_{11}(3)$.

Greene’s theorem implies that the number of rows of the original standard Young tableau T equals the length of the longest NE-chain of X’s. Since $T \in \text{SYT}_n(2h+1)$, this length is bounded above by $2h+1$. Since we are in a symmetric situation, the length of a longest NE-chain will occur among symmetric NE-chains. This in turn implies that the largest nesting of the matching encoded by the crosses has size at most h . In other words, the matching is an element of $\text{NN}_n(h+1)$. This establishes the identity. \square

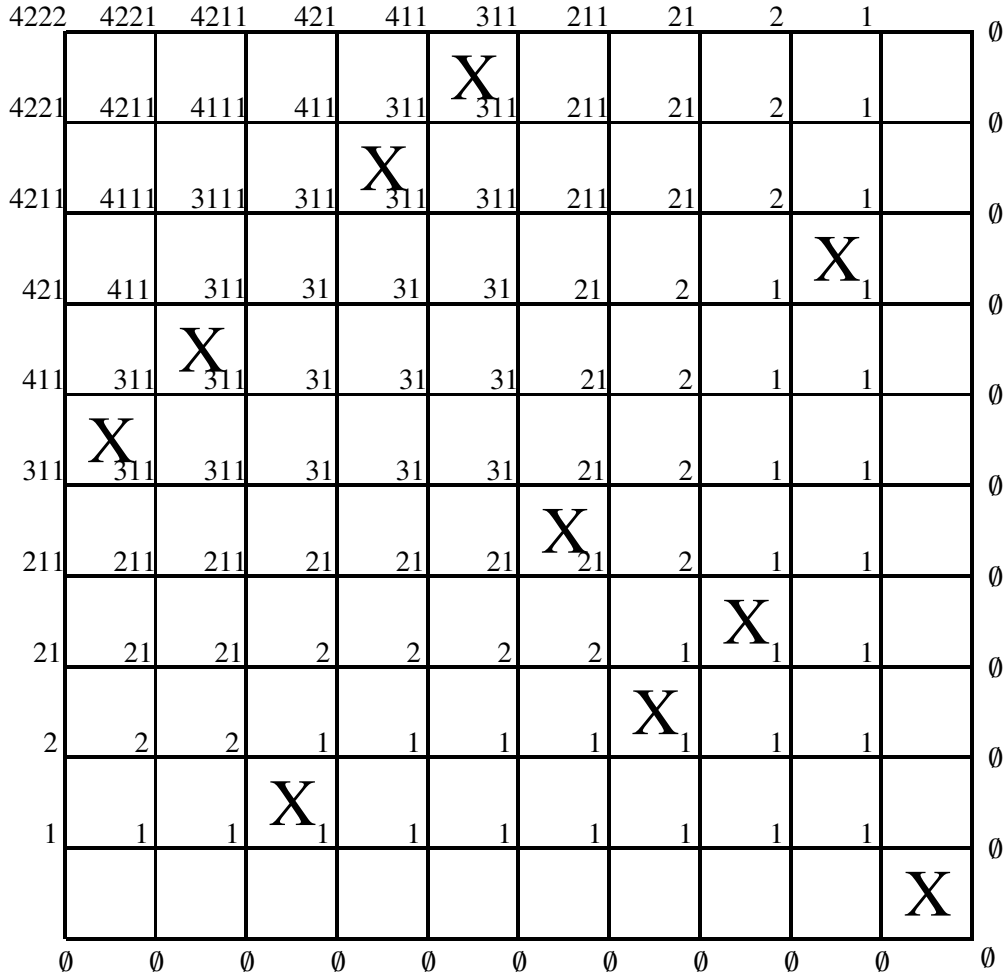

FIGURE 13. Example for the bijection between $\text{SYT}_{10}(4)$ and $\text{NN}_{10}(2 + 1/2)$.

Proof of (B.3). We proceed in the same manner as in the previous proof. Here, our running example is the standard Young tableau

1	2	5	6
3	7		
4	9		
8	10		

which is an element of $\text{SYT}_{10}(4) = \text{SYT}_{10}(2 \cdot 2)$. The growth diagram that results in this case is shown in Figure 13. The matching that corresponds to the crosses in the figure is

$$(B.11) \quad \{(1, 5), (2, 4), (3, 9), (7, 8)\},$$

with 6 and 10 being fixed points of the matching. The largest nestings have size 2 — namely $\{(1, 5), (2, 4)\}$ and $\{(3, 9), (7, 8)\}$. Moreover, the largest “half-nesting” is $\{(3, 9)\} \cup \{6\}$, which is a $(1 + 1/2)$ -nesting. Hence, this matching is an element of $\text{NN}_{10}(2 + 1/2)$.

By Greene’s theorem again, the length of the longest NE-chain of crosses is bounded above by $2h$. Also here, we may restrict our attention to symmetric NE-chains. The previous observation implies that the size

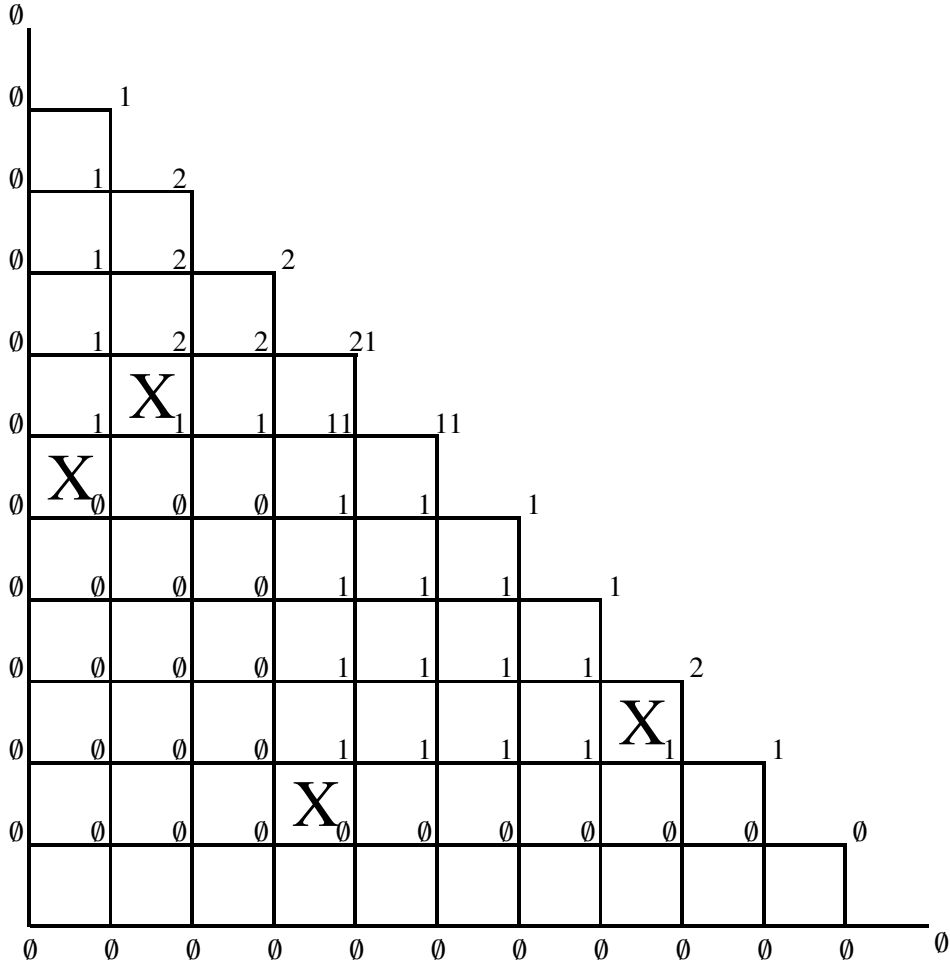

FIGURE 14. Example for the bijection between $NN_{11}(3)$ and $VT_{11}(2)$.

of a nesting in the matching (involution) corresponding to the crosses can be at most h . Moreover, a cross on the right-down diagonal of the square must not be part of a (symmetric) NE-chain of length $2h + 1$. Translated into the corresponding property for the matching defined by the set of crosses, this means that the matching does not contain an $(h + 1/2)$ -nesting. In other words, the matching is an element of $NN_n(h + 1/2)$.

This completes the proof of the identity. □

Next we prove the identities in Theorem B.4.

Proof of (B.6). Let M be a matching in $NN_n(h + 1)$. Obviously, in the square growth diagrams that we used in the proofs of (B.2) and (B.3) (cf. Figures 12 and 13), only one half of the information is essential, the rest is redundant. Indeed, here we content ourselves with just one half of the square, namely the triangular region below the right-down diagonal. We put the matching M as crosses into the triangle in the same fashion as in the proofs of (B.2) and (B.3). Also here, we illustrate all the steps of the construction by a running example, namely the matching in (B.10), which is an element of $NN_{11}(3) = NN_{11}(2 + 1)$. Figure 14 shows that matching filled in the triangular region forming half of an 11×11 rectangle. (Obviously this is half of the cell diagram of Figure 12, excluding the fixed points along the right-down diagonal.) The labelings should be ignored at this point.

Now we place empty diagrams along the bottom side and along the left side of the triangular cell arrangement. Subsequently we apply the (forward) growth diagram algorithm in direction top/right. Figure 14 shows the result in our running example.

We read the sequence $(\lambda^0, \lambda^1, \dots, \lambda^{2n})$ of diagrams that we obtain along the diagonal of the triangular region. In our example, we obtain

$$(\emptyset, \emptyset, 1, 1, 2, 2, 2, 2, 21, 11, 11, 1, 1, 1, 1, 1, 2, 1, 1, \emptyset, \emptyset, \emptyset, \emptyset).$$

However, again, this sequence contains a lot of redundant information. Namely, since we filled a matching into the triangular cell arrangement, there are exactly three possibilities for the subsequences of the form $\lambda^{2i}, \lambda^{2i+1}, \lambda^{2i+2}$, for $i = 0, 1, \dots, n-1$:

- $\lambda^{2i} = \lambda^{2i+1} \subsetneq \lambda^{2i+2}$;
- $\lambda^{2i} \supsetneq \lambda^{2i+1} = \lambda^{2i+2}$;
- $\lambda^{2i} = \lambda^{2i+1} = \lambda^{2i+2}$.

Hence it suffices to keep all the even-indexed partitions $(\lambda^0, \lambda^2, \dots, \lambda^{2n})$; the odd-indexed ones can be reconstructed from them. In our running example, this leads to the reduced sequence

$$(\emptyset, 1, 2, 2, 21, 11, 1, 1, 2, 1, \emptyset, \emptyset).$$

Since we started with a matching without an $(h+1)$ -nesting, the longest NE-chain of crosses is bounded above by h . By Greene's theorem, this implies that the first rows of the diagrams λ^{2i} are also bounded above by h .

In the final step we conjugate all partitions λ^{2i} in the (reduced) sequence and obtain $((\lambda^0)', (\lambda^2)', \dots, (\lambda^{2n})')$. Clearly, this produces a vacillating tableau in $\text{VT}_n(h)$. In the case of our example, we obtain

$$(\emptyset, 1, 11, 11, 21, 2, 1, 1, 11, 1, \emptyset, \emptyset).$$

This completes the proof. □

Proof of (B.7). Let $M \in \text{NN}(h+1/2)$. We proceed as in the proof of (B.6), with one exception: here, when we put our matching M in the form of crosses into the triangular cell arrangement, we keep the crosses corresponding to fixed points of M along the right-down diagonal. As running example we choose the matching in (B.11). It is a matching in $\text{NN}_{10}(2+1/2)$. The corresponding arrangement of crosses is shown in Figure 15. For better recognition, the fixed points are placed into dotted cells.

The condition of M not having an $(h+1)$ -nesting and not having an $(h+1/2)$ -nesting translates into the condition that all NE-chains of crosses in the configuration have length at most h , may they contain a cross on the right-down diagonal (that is, a fixed point) or not.

Now, as in the proof of (B.6), we place empty diagrams along the bottom side and along the left side of the triangular cell arrangement. Subsequently we apply the (forward) growth diagram algorithm in direction top/right; see Figure 15. Again, we read every second diagram along the right-down diagonal, say $(\lambda^0, \lambda^2, \dots, \lambda^{2n})$. In our running example in Figure 15, we read

$$(\emptyset, 1, 2, 21, 11, 1, 1, 2, 1, \emptyset, \emptyset).$$

Since the longest NE-chain of crosses is bounded above by h , Greene's theorem implies that the first rows of the diagrams λ^{2i} are bounded above by h . Moreover, we have $\lambda^{2i} = \lambda^{2i+2}$ for some i if and only if at this place we find a cross corresponding to a fixed point of the matching M . Consequently, again by Greene's theorem, in this case the length of the first row of $\lambda^{2i} = \lambda^{2i+2}$ is in fact at most $h-1$.

As before, the final step consists in conjugating all partitions of the sequence $(\lambda^0, \lambda^2, \dots, \lambda^{2n})$. By the above observations it should be obvious that in this manner we obtain an element of $\text{VT}_n(h^*)$. In our

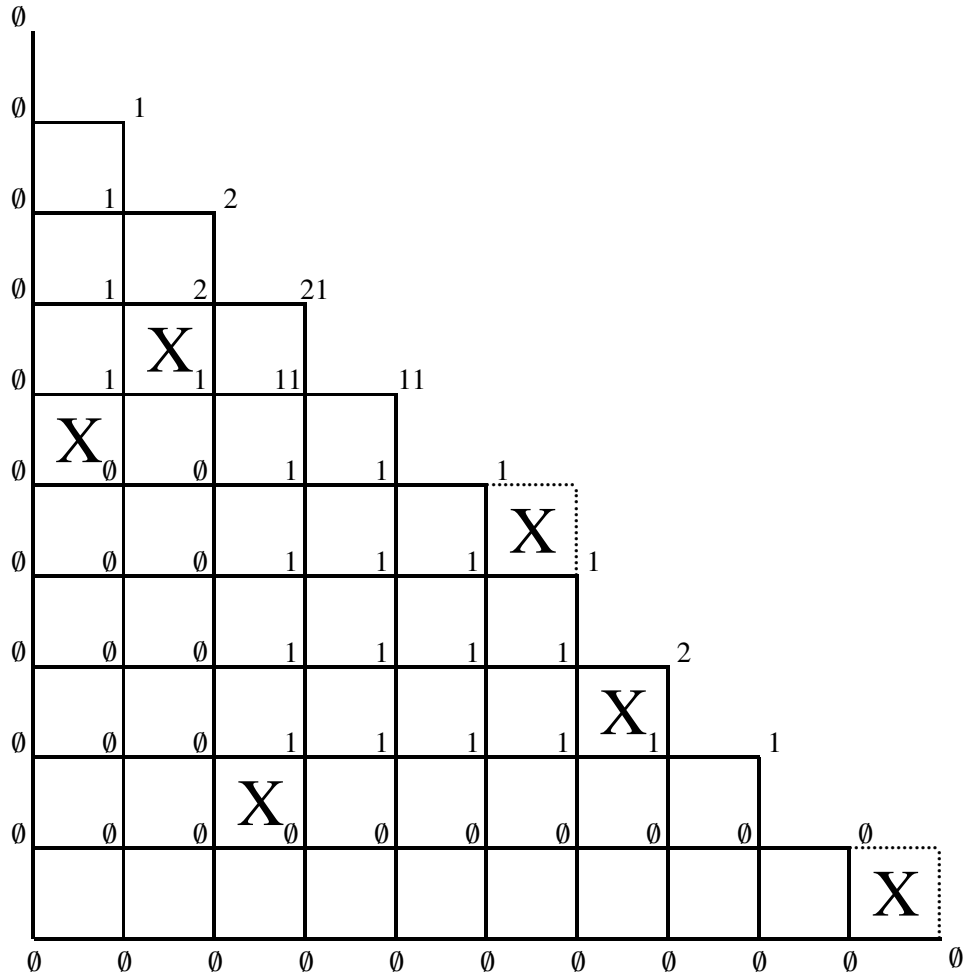

FIGURE 15. Example for the bijection between $NN_{10}(2 + 1/2)$ and $VT_{10}(2^*)$.

example, we obtain

$$(\emptyset, 1, 11, 21, 2, 1, 1, 11, 1, \emptyset, \emptyset),$$

which is indeed an element of $VT_{10}(2 + 1/2)$. This finishes the proof. \square

Finally, for the sake of completeness, we recall the growth diagram bijection from [22, last paragraph of Sec. 3] that proves the symmetry relation in Theorem B.1.

Proof of (B.1). We are going to describe a bijection between matchings M_1 and M_2 that has the property that, if M_1 has a p -crossing and a q -nesting, then M_2 has a q -crossing and a p -nesting, for any positive integers or half-integers p and q . It is easy to see that such a bijection implies the relation (B.1).

In brief, the bijection works by taking the matching M_1 , putting it in form of an arrangement of crosses into a triangular cell arrangement of the appropriate size as in the proof of (B.7), then applying the forward growth diagram algorithm as in that proof, subsequently conjugating all partitions along the right-down diagonal and forgetting all other partition labels and the crosses that do not correspond to fixed points, and by finally applying the inverse (backward) growth diagram algorithm (keeping the crosses that corresponded to fixed points). The crosses that one obtains define the image matching M_2 . Greene's theorem implies the asserted properties concerning crossings and nestings.

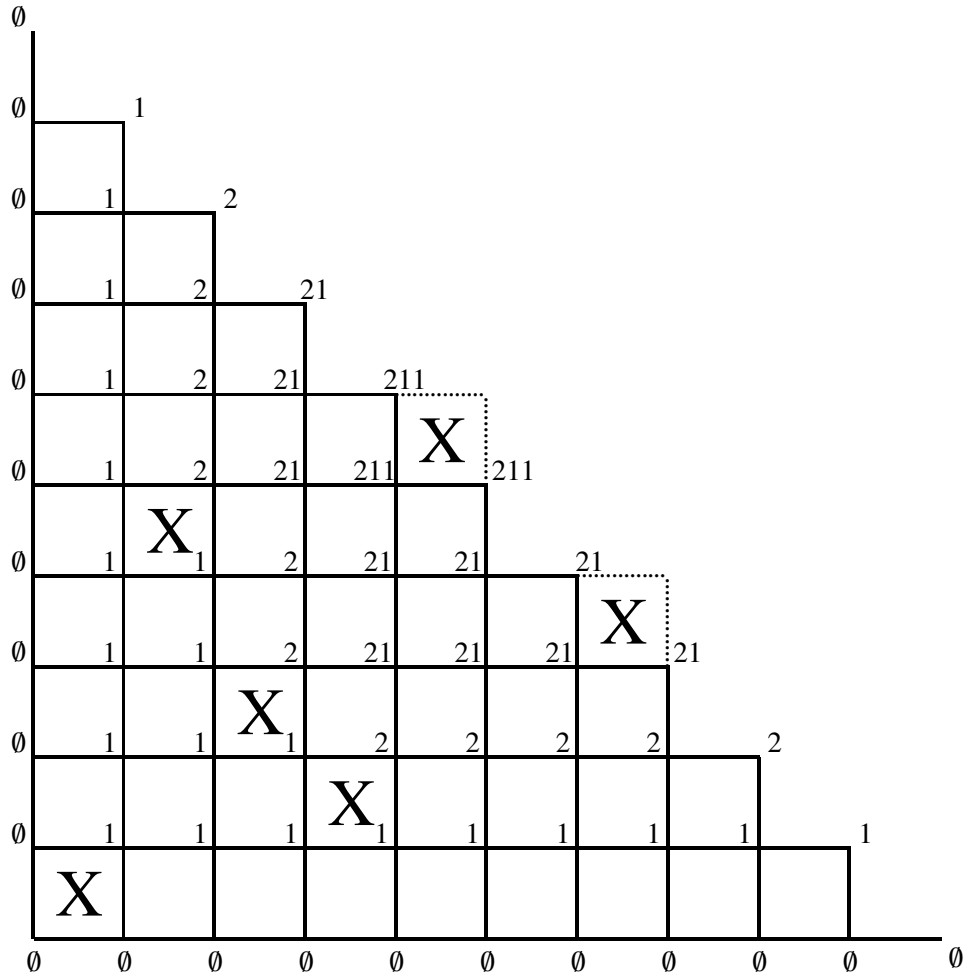

FIGURE 16. Example for the bijection between $\text{NCNN}_{10}(r, s)$ and $\text{NCNN}_{10}(s, r)$ — forward algorithm.

We illustrate this construction by considering the matching

$$\{(1, 10), (2, 6), (3, 8), (4, 9)\}$$

with fixed points 5 and 7. It has a 3-crossing — namely $\{(2, 6), (3, 8), (4, 9)\}$ —, a $(3 + 1/2)$ -crossing together with the fixed point 5, several 2-nestings — namely e.g. $\{(1, 10), (3, 8)\}$ —, and a $(2 + 1/2)$ -nesting together with the fixed point 7. The corresponding arrangement of crosses together with the forward growth diagram construction is shown in Figure 16.

Figure 17 shows the growth diagram that results from conjugating the partitions along the right-down diagonal and subsequently applying the inverse growth diagram algorithm. The resulting arrangement of crosses corresponds to the matching

$$\{(1, 9), (2, 10), (3, 8), (4, 6)\}$$

with the (same) fixed points 5 and 7. Indeed, this matching has a 3-nesting — namely $\{(2, 10), (3, 8), (4, 6)\}$ —, a $(3 + 1/2)$ -nesting together with the fixed point 5, a 2-crossing — namely $\{(1, 9), (2, 10)\}$ —, and a $(2 + 1/2)$ -crossing together with the fixed point 7.

This completes the proof. □

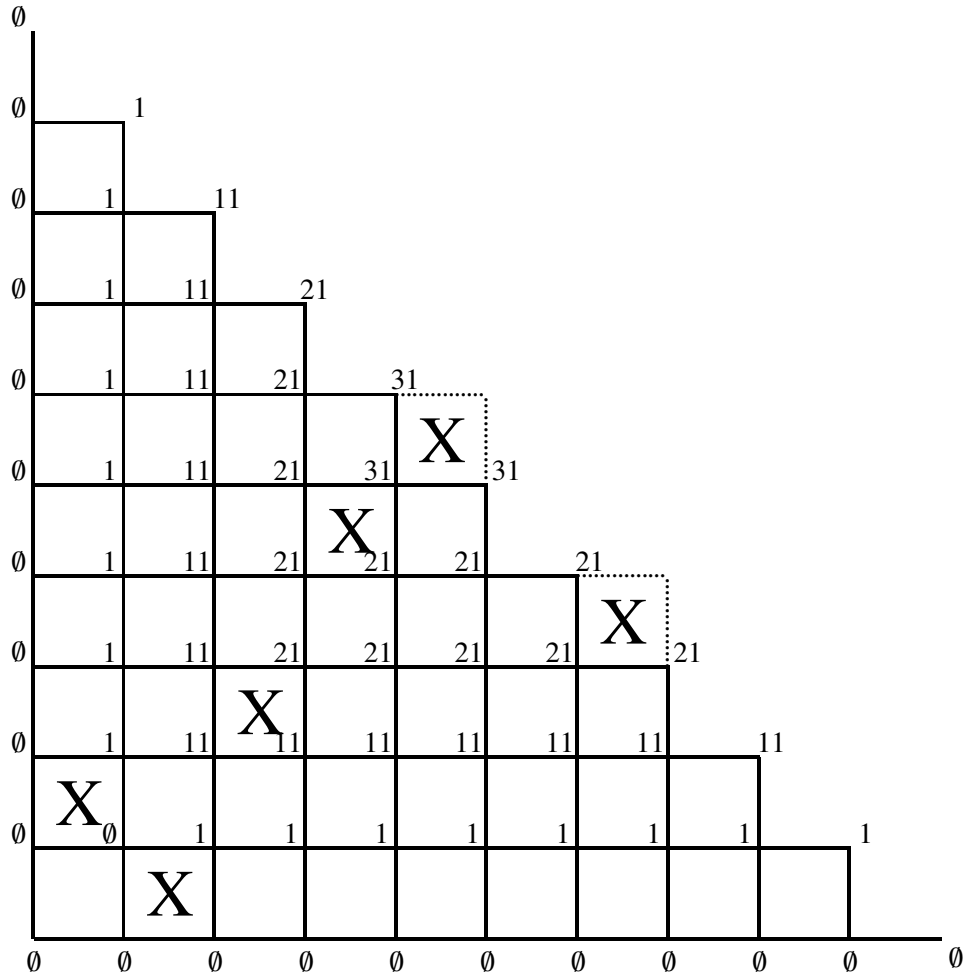

FIGURE 17. Example for the bijection between $\text{NCNN}_{10}(r, s)$ and $\text{NCNN}_{10}(s, r)$ — backward algorithm.

REFERENCES

[1] A. Bertram, I. Ciocan-Fontanine, and W. Fulton. Quantum multiplication of Schur polynomials. *J. Algebra*, 219(2):728–746, 1999.

[2] A. Björner and F. Brenti. *Combinatorics of Coxeter Groups*. Springer–Verlag, New York, 2005.

[3] W. Y. C. Chen, E. Y. P. Deng, R. R. X. Du, R. P. Stanley, and C. H. Yan. Crossings and nestings of matchings and partitions. *Trans. Amer. Math. Soc.*, 359(4):1555–1575 (electronic), 2007.

[4] J. Courtiel, A. Elvey Price, and I. Marcovici. Bijections between walks inside a triangular domain and Motzkin paths of bounded amplitude. *Electron. J. Combin.*, 28(2):Paper No. 2.6, 44 pp., 2021.

[5] N. Dershowitz. Between Broadway and the Hudson: a bijection of corridor paths. *J. Integer Seq.*, 24(2):Art. 21.2.8, 19 pp., 2021.

[6] S. Elizalde. Walks in simplices, cylindric tableaux, and asymmetric exclusion processes. *Sémin. Lotharingien Combin.*, 86B:Art. 86B.8, 12 pp., 2022.

[7] S.-P. Eu, T.-S. Fu, J. T. Hou, and T.-W. Hsu. Standard Young tableaux and colored Motzkin paths. *J. Combin. Theory Ser. A*, 120(7):1786–1803, 2013.

[8] M. Filaseta. A new method for solving a class of ballot problems. *J. Combin. Theory Ser. A*, 39(1):102–111, 1985.

[9] W. Fulton and J. Harris. *Representation Theory*. Springer–Verlag, New York, 1991.

[10] I. M. Gessel and C. Krattenthaler. Cylindric partitions. *Trans. Amer. Math. Soc.*, 349(2):429–479, 1997.

- [11] I. M. Gessel and X. Viennot. Binomial determinants, paths, and hook length formulae. *Adv. Math.*, 58:300–321, 1985.
- [12] I. M. Gessel and D. Zeilberger. Random walk in a Weyl chamber. *Proc. Amer. Math. Soc.*, 115(1):27–31, 1992.
- [13] F. M. Goodman and H. Wenzl. Littlewood-Richardson coefficients for Hecke algebras at roots of unity. *Adv. Math.*, 82(2):244–265, 1990.
- [14] B. Gordon. Notes on plane partitions. V. *J. Combinatorial Theory Ser. B*, 11:157–168, 1971.
- [15] B. Gordon and L. Houten. Notes on plane partitions. II. *J. Combinatorial Theory*, 4:81–99, 1968.
- [16] D. J. Grabiner. Random walk in an alcove of an affine Weyl group, and non-colliding random walks on an interval. *J. Combin. Theory Ser. A*, 97(2):285–306, 2002.
- [17] N. S. S. Gu and H. Prodinger. Combinatorics on lattice paths in strips. *European J. Combin.*, 94:Paper No. 103310, 14 pp., 2021.
- [18] J. E. Humphreys. *Reflection groups and Coxeter groups*, volume 29 of *Cambridge Studies in Advanced Mathematics*. Cambridge University Press, Cambridge, 1990.
- [19] M. Ishikawa and M. Wakayama. Minor summation formula of Pfaffians. *Linear and Multilinear Algebra*, 39(3):285–305, 1995.
- [20] C. Krattenthaler. Oscillating tableaux and nonintersecting lattice paths. *J. Statist. Plann. Inference*, 54(1):75–85, 1996.
- [21] C. Krattenthaler. Identities for classical group characters of nearly rectangular shape. *J. Algebra*, 209:1–64, 1998.
- [22] C. Krattenthaler. Growth diagrams, and increasing and decreasing chains in fillings of Ferrers shapes. *Adv. Appl. Math.*, 37:404–431, 2006.
- [23] C. Krattenthaler. Lattice path enumeration. In: *Handbook of Enumerative Combinatorics*. M. Bóna (ed.). CRC Press, Boca Raton, London, New York, 2015, pp. 589–678.
- [24] S. J. Lee. Positivity of cylindric skew Schur functions. *J. Combin. Theory Ser. A*, 168:26–49, 2019.
- [25] B. Lindström. On the vector representations of induced matroids. *Bull. London Math. Soc.*, 5:85–90, 1973.
- [26] D. E. Littlewood, *The theory of group characters*. Second edition. Oxford University Press, 1950.
- [27] I. G. Macdonald. *Symmetric functions and Hall polynomials*. Second edition. Oxford Mathematical Monographs. The Clarendon Press Oxford University Press, New York, 1995. With contributions by A. Zelevinsky, Oxford Science Publications.
- [28] P. McNamara. Cylindric skew Schur functions. *Adv. Math.*, 205(1):275–312, 2006.
- [29] P. R. G. Mortimer and T. Prellberg. On the number of walks in a triangular domain. *Electron. J. Combin.*, 22(1):Paper 1.64, 15 pp., 2015.
- [30] S. Okada. On the generating functions for certain classes of plane partitions. *J. Combin. Theory Ser. A*, 51(1):1–23, 1989.
- [31] S. Okada. Applications of minor summation formulas to rectangular-shaped representations of classical groups. *J. Algebra*, 205(2):337–367, 1998.
- [32] A. Postnikov. Affine approach to quantum Schubert calculus. *Duke Math. J.*, 128(3):473–509, 2005.
- [33] E. Rains and S. O. Warnaar. Bounded Littlewood identities. *Mem. Amer. Math. Soc.*, 270(1317):vii+115, 2021.
- [34] I. Schur, *Gesammelte Abhandlungen*. Vol. III. Alfred Brauer und Hans Rohrbach (eds.). Springer-Verlag, Berlin–New York, 1973.
- [35] R. P. Stanley. *Enumerative Combinatorics. Vol. 2*, volume 62 of *Cambridge Studies in Advanced Mathematics*. Cambridge University Press, Cambridge, 1999. With a foreword by Gian-Carlo Rota and appendix 1 by Sergey Fomin.
- [36] J. R. Stembridge. Nonintersecting paths, Pfaffians, and plane partitions. *Adv. Math.*, 83(1):96–131, 1990.
- [37] D. Zeilberger. The number of ways of walking in $x_1 \geq \dots \geq x_k \geq 0$ for n days, starting and ending at the origin, where at each day you may either stay in place or move one unit in any direction, equals the number of n -cell standard Young tableaux with $\leq 2k + 1$ rows. *The Personal Journal of Shalosh B. Ekhad and Doron Zeilberger*, <https://sites.math.rutgers.edu/~zeilberg/pj.html>, 2007.

DEPARTMENT OF MATHEMATICS, AJOU UNIVERSITY, SUWON, REPUBLIC OF KOREA
 Email address: hyunyjia@ajou.ac.kr

DEPARTMENT OF MATHEMATICS, SUNGKYUNKWAN UNIVERSITY, SUWON, REPUBLIC OF KOREA
 Email address: jangsookim@skku.edu

FAKULTÄT FÜR MATHEMATIK, UNIVERSITÄT WIEN, OSKAR-MORGENSTERN-PLATZ 1, A-1090 VIENNA, AUSTRIA.
 Email address: Christian.Krattenthaler@univie.ac.at

GRADUATE SCHOOL OF MATHEMATICS, NAGOYA UNIVERSITY, FURO-CHO, CHIKUSA-KU, NAGOYA 464-8602, JAPAN
 Email address: okada@math.nagoya-u.ac.jp