

# The Produoidal Algebra of Process Decomposition

Matt Earnshaw, James Hefford and Mario Román

**Abstract**—We introduce the normal produoidal category of monoidal contexts over an arbitrary monoidal category. In the same sense that a monoidal morphism represents a process, a monoidal context represents an incomplete process: a piece of a decomposition, possibly containing missing parts. We characterize monoidal contexts in terms of universal properties. In particular, symmetric monoidal contexts coincide with monoidal lenses, endowing them with a novel universal property. We apply this algebraic structure to the analysis of multi-party interaction protocols in arbitrary theories of processes.

## 1 INTRODUCTION

Theories of processes, such as *stochastic*, *partial* or *linear* functions, are a foundational tool in computer science. They help us model how systems interact in terms of a solid mathematical foundation. Any theory of processes involving operations for *sequential composition* and *parallel composition*, satisfying reasonable axioms, forms a *monoidal category*.

Monoidal categories are versatile: they can be used in the description of quantum circuits [AC09], stochastic processes [CJ19], [Fri20], relational queries [BSS18] and non-terminating processes [CL02], among many other applications [CFS16].

At the same time, monoidal categories have two intuitive, sound and complete calculi: the first in terms of *string diagrams* [JS91], and the second in terms of their *linear type theory* [Shu16]. String diagrams are a 2-dimensional syntax in which processes are represented by boxes, and their inputs and outputs are connected by wires. The type theory of symmetric monoidal categories is the basis of the more specialized *arrow do-notation* used in functional programming languages [Hug00], [Pat01], which becomes *do-notation* for Kleisli categories of commutative monads [Mog91], [Gui80]. Let us showcase monoidal categories, their string diagrams and the use of do-notation in the description of a protocol.

### 1.1 Protocol Description

The Transmission Control Protocol (TCP) is a connection-based communication protocol. Every connection begins with a *three-way handshake*: an exchange of messages that synchronizes the state of both parties. This handshake is defined in RFC793 to have three steps: SYN, SYN-ACK and ACK [Pos81].

The client initiates the communication by sending a synchronization packet (SYN) to the server. The synchronization packet contains a pseudorandom number associated to the session, the Initial Sequence Number of the client (CLI).

The server acknowledges this packet and sends a message (ACK) containing its own sequence number (SRV) together with the client's sequence number plus one (CLI+1). These two form the SYN-ACK message. Finally, the client sends a final ACK message with the server's sequence number plus one, SRV+1.

When the protocol works correctly, both client and server end up with the pair (CLI + 1, SRV + 1).

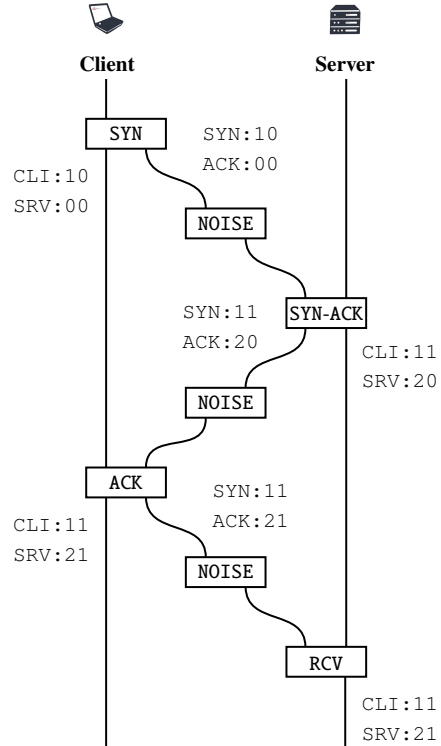

Fig. 1: TCP Three way handshake.

This protocol is traditionally described in terms of a communication diagram (Figure 1). This diagram can be taken seriously as a formal mathematical object: it is a string diagram describing a *morphism* in a monoidal category.

```
syn :: Client ~> (Client, Syn, Ack)
syn(client) = do
  client <- random
  return (client, client, 0)
```

Fig. 2: Implementation of the SYN component.

The implementation of each component of the protocol is traditionally written as pseudocode. This pseudocode can also be taken seriously as the expression of a morphism in the same monoidal category, possibly with extra structure: in this case, a commutative *Freyd category* (Figure 2, see Appendix Section A.1 [Mog91]). That is, symmetric monoidal categories admit two different internal languages, and we can use both to interpret formally the traditional description of a protocol in terms of string diagrams and pseudocode.

## 1.2 Types for Message Passing

The last part in formalizing a multi-party protocol in terms of monoidal categories is to actually separate its component parties. For instance, the three-way handshake can be split into the client, the server and a channel. Here is where the existing literature in monoidal categories seems to fall short: the parts resulting from the decomposition of a monoidal morphism are not necessarily monoidal morphisms themselves (see Figure 3 for the diagrammatic representation). We say that these are only *monoidal contexts*.

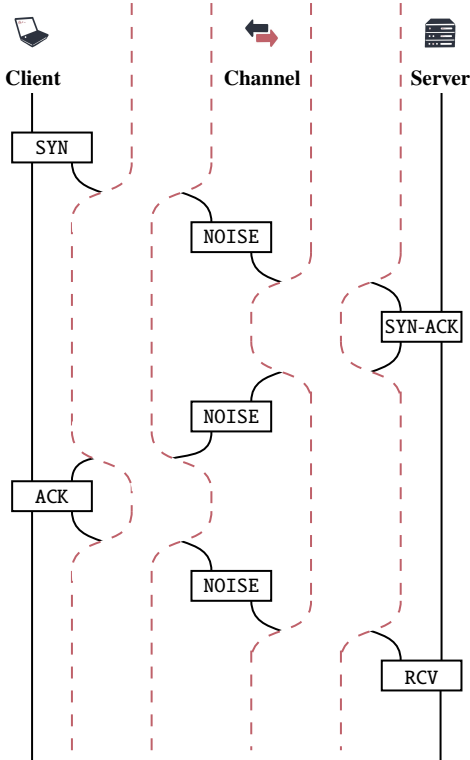

Fig. 3: Parties in the TCP Three-way handshake.

Contrary to monoidal morphisms, which only need to declare their input and output types, monoidal contexts need *behavioural types* [PS93], [HLV<sup>+</sup>16] that specify the order and type of the exchange of information along their boundary.

A monoidal context may declare intermediate *send* (!A) and *receive* (?A) types, separated by a sequencing operator ( $\triangleleft$ ). For instance, the channel is a monoidal morphism just declaring that it takes an input message (**Msg**) and produces another output message; but the client is a monoidal context that transforms its memory type **Client**  $\rightarrow$  **Client** at the same time it *sends*, *receives* and then *sends* a message; and the server transforms its type **Server**  $\rightarrow$  **Server** while, dually to the client, it *receives*, *sends* and then *receives* a message.

$$\begin{aligned} \text{Client} &\in \mathcal{LC}(\text{Client}_{\text{Client}}; !\text{Msg} \triangleleft ?\text{Msg} \triangleleft !\text{Msg}); \\ \text{Server} &\in \mathcal{LC}(\text{Server}_{\text{Server}}; ?\text{Msg} \triangleleft !\text{Msg} \triangleleft ?\text{Msg}); \\ \text{NOISE} &\in \mathbb{C}(\text{Msg}; \text{Msg}); \end{aligned}$$

Session types [HYC08], including the send (!A) and receive (?A) polarized types, have been commonplace in logics of message passing. Cockett and Pastro [CP09] already proposed a categorical semantics for message-passing which, however, needs to go beyond monoidal categories, into *linear actegories* and *polyactegories*.

Our claim is that, perhaps surprisingly, monoidal categories already have the necessary algebraic structure to define *monoidal contexts* and their send-receive polarized types. Latent to any monoidal category, there exists a universal category of contexts with polarized types (!/? ) and parallel/sequence operators ( $\otimes/\triangleleft$ ).

## 1.3 Reasoning with Contexts

This manuscript introduces the notion of monoidal context and symmetric monoidal context; and it explains how dinaturality allows us to reason with them. In the same way that we reason with monoidal morphisms using string diagrams, we can reason about monoidal contexts using *incomplete string diagrams* [BDSPV15], [Rom21].

For instance, consider the following fact about the TCP three-way handshake: the client does not need to store a starting SRV number for the server, as it will be overwritten as soon as the real one arrives. This fact only concerns the actions of the client, and it is independent of the server and the channel. We would like to reason about it preserving this modularity, and this is what the incomplete diagrams in Figure 4 achieve.

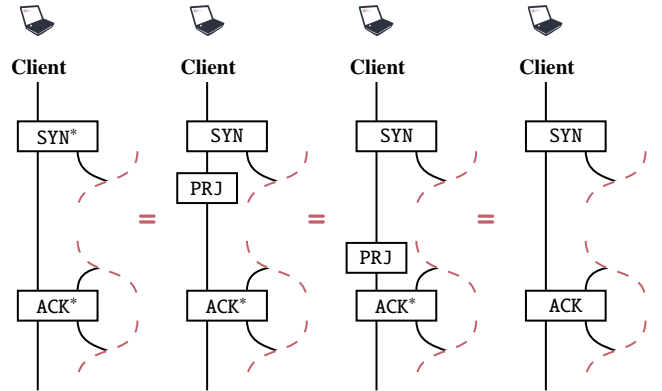

Fig. 4: Reasoning only with the Client.

Here, we define  $\text{SYN}^* = \text{SYN}; \text{PRJ}$  to be the same as the SYN process but projecting out only the client CLI number. We also define a new  $\text{ACK}^*$  that ignores the server SRV number, so that  $\text{ACK} = \text{PRJ}; \text{ACK}^*$ . These two equations are enough to complete our reasoning.

Monoidal contexts and their incomplete diagrams are defined to be convenient tuples of morphisms, e.g.  $(\text{SYN}|\text{ACK})$  in our example; what makes them interesting is the equivalence relation we impose on them: this equivalence relation makes the pair  $(\text{SYN}; \text{PRJ}|\text{ACK}^*)$  equal to  $(\text{SYN}|\text{PRJ}; \text{ACK}^*)$ . *Dinaturality* is the name we give to this relation, and we will see how it arises canonically from the algebra of profunctors.

## 1.4 The Produoidal Algebra of Monoidal Context

Despite the relative popularity of string diagrams and other forms of formal 2-dimensional syntax, the algebra of incomplete monoidal morphisms has remained obscure. This manuscript elucidates this algebra: we show that, as monoidal morphisms together with their string diagrams form *monoidal categories*, monoidal contexts together with their incomplete string diagrams form *normal produoidal categories*. Normal produoidal categories were a poorly understood categorical structure, for which we provide examples. Let us motivate “normal produoidal categories” by parts.

First, the “*duoidal*” part. Monoidal contexts can be composed sequentially and in parallel, but also nested together to fill the missing parts. Nesting is captured by categorical composition, so we need specific tensors for both sequential ( $\triangleleft$ ) and parallel ( $\otimes$ ) composition. This is what duoidal categories provide. Duoidal categories are categories with two monoidal structures, e.g.  $(\triangleleft, N)$  and  $(\otimes, I)$ . These two monoidal structures are in principle independent but, whenever they share the same unit ( $I \cong N$ ), they become well-suited to express process dependence [SS22]: they become “*normal*”.

Finally, the “*pro-*” prefix. It is not that we want to impose this structure on top of the monoidal one, but we want to capture the structure morphisms already form. The two tensors  $(\triangleleft, \otimes)$  do not necessarily exist in the original category; in technical terms, they are not *representable* or *functorial*, but *virtual* or *profunctorial*. This makes us turn to the produoidal categories of Booker and Street [BS13].

Not only is all of this algebra present in monoidal contexts. Monoidal contexts are the *canonical* such algebra; in a precise sense given by universal properties. The slogan for the main result of this manuscript (Theorem 6.6) is that

Monoidal contexts are the *free* normalization of the *cofree* produoidal category over a monoidal category.

## 1.5 Related Work

Far from being the proposal of yet another paradigm, monoidal contexts form a novel algebraic formalization of a widespread paradigm. We argue that the idea of monoidal contexts has been recurrent in the literature, just never appearing explicitly and formally. Our main contribution is to formalize an algebra of monoidal contexts, in the form of a *normal produoidal* category.

In fact, the Symposium on Logic in Computer Science has recently seen multiple implicit applications of monoidal contexts. Kissinger and Uijlen [KU17] describe higher order quantum processes using contexts with holes in compact closed monoidal categories. Ghani, Hedges, Winschel and Zahn [GHWZ18] describe economic game theory in terms of *lenses* and incomplete processes in cartesian monoidal categories. Bonchi, Piedeleu, Sobociński and Zanasi [BPSZ19] study contextual equivalence in their monoidal category of affine signal flow graphs. Di Lavore, de Felice and Román [DLdFR22] define *monoidal streams* by iterating monoidal context coalgebraically.

*Language theory.* Motivated by language theory and the Chomsky-Schützenberger theorem, Melliès and Zeilberger [MZ22] were the first to present the multicategorical *splice-contour* adjunction. We are indebted to their exposition, which we extend to the promonoidal and produoidal cases. Earnshaw and Sobociński [ES22] described a congruence on formal languages of string diagrams using monoidal contexts. We prove how monoidal contexts arise from an extended produoidal splice-contour adjunction; unifying these two threads.

*Session types.* Session types [Hon93], [HYC08] are the mainstay type formalism for communication protocols, and they have been extensively applied to the  $\pi$ -calculus [SW01]. Our approach is not set up to capture all of the features of a fully fledged session type theory [KPT96]. Arguably, this makes it more general in what it does: it always provides a universal way of implementing send ( $!A$ ) and receive ( $?A$ ) operations in an arbitrary theory of processes represented by a monoidal category. For instance, recursion and the internal/external choice duality [GH99], [PS93] are not discussed, although they could be considered as extensions in the same way they are to monoidal categories: via trace [Has97] and linear distributivity [CS97].

*Lenses and incomplete diagrams.* Lenses are a notion of bidirectional transformation [FGM<sup>+</sup>07] that can be cast in arbitrary monoidal categories. The first mention of monoidal lenses separate from their classical database counterparts [JRW12] is due to Pastro and Street [PS07], who identify them as an example of a promonoidal category. However, it was with a different monoidal structure [Ril18] that they became popular in recent years, spawning applications not only in bidirectional transformations [FGM<sup>+</sup>07] but also in functional programming [PGW17], [CEG<sup>+</sup>20], open games [GHWZ18], polynomial functors [NS22] and quantum combs [HC22]. Relating this monoidal category of lenses with the previous promonoidal category of lenses was an open problem; and the promonoidal structure was mostly ignored in applications.

We solve this problem, proving that lenses are a universal normal symmetric produoidal category (the symmetric monoidal contexts), which endows them with a novel algebra and a novel universal property. This also extends work on the relation between *incomplete diagrams*, *comb-shaped diagrams*, and *lenses* [Rom20], [Rom21].

Finally, Nester et al. have recently proposed a syntax for lenses and message-passing [Nes23], [BNR22] and lenses themselves have been applied to protocol specification [VC22]. Spivak [Spi13] also discusses the multicategory of *wiring diagrams*, later used for incomplete diagrams [PSV21] and related to lenses [SSV20]. The promonoidal categories we use can be seen as multicategories with an extra coherence property. In this sense, we contribute the missing algebraic structure of the universal multicategory of *wiring diagrams relative to a monoidal category*.

## 1.6 Contributions

Our main contribution is the original definition of a produoidal category of *monoidal contexts* over a monoidal cat-

egory (Definition 6.1) and its characterization in terms of universal properties (Theorem 6.6).

Section 2 presents expository material on profunctors, dinaturality and promonoidal categories; the rest are novel contributions. Section 3 constructs spliced arrows as the cofree promonoidal over a category (Theorem 3.7). Section 4, on top of this, constructs spliced monoidal arrows as the cofree produoidal over a monoidal category (Theorem 4.9). Section 6 explicitly constructs a produoidal algebra of monoidal contexts (Proposition 6.5) as a free normalization. Section 7 constructs a symmetric produoidal algebra of monoidal lenses (Proposition 7.2), universally characterizing them (Theorem 7.3), and an interpretation of send/receive types (!/? ) (Proposition 7.6). Section 5 introduces a novel free normalization procedure (Theorems 5.3 and 5.4) as an idempotent monad on produoidal categories, employed in Sections 6 and 7.

## 2 PROFUNCTORS AND VIRTUAL STRUCTURES

Profunctors describe families of processes indexed by the input and output types of a category. Profunctors provide canonical notions for *composition*, *dinaturality* and *virtual structure*. These notions are not only canonical, but also easy to reason with thanks to *coend calculus* [Lor21].

**Definition 2.1.** A *profunctor*  $P: \mathbb{B}_0 \times \dots \times \mathbb{B}_m \bullet \dashv \vdash \mathbb{A}_0 \times \dots \times \mathbb{A}_n$  is a functor  $P: \mathbb{A}_0^{op} \times \dots \times \mathbb{A}_n^{op} \times \mathbb{B}_0 \times \dots \times \mathbb{B}_m \rightarrow \mathbf{Set}$ .

For our purposes, a profunctor  $P(A_0, \dots, A_n; B_0, \dots, B_m)$  is a family of processes indexed by contravariant inputs  $A_0, \dots, A_n$  and covariant outputs  $B_0, \dots, B_m$ . The profunctor is endowed with jointly functorial left  $(\succ_0, \dots, \succ_m)$  and right  $(\prec_0, \dots, \prec_n)$  actions of the morphisms of  $\mathbb{A}_0, \dots, \mathbb{A}_n$  and  $\mathbb{B}_0, \dots, \mathbb{B}_m$ , respectively [Bén00], [Lor21].<sup>1</sup>

### 2.1 Dinaturality

Composing profunctors is subtle: the same processes could arise as the composite of different pairs of processes and so, we need to impose a careful equivalence relation. Fortunately, profunctors come with a canonical notion of dinatural equivalence which achieves precisely this.

Imagine we try to connect two different processes:  $p \in P(A_0, \dots, A_n; B_0, \dots, B_m)$ , and  $q \in Q(C_0, \dots, C_k; D_0, \dots, D_h)$ ; and we have some morphism  $f: B_i \rightarrow C_j$  that translates the  $i$ -th output port of  $p$  to the  $j$ -th input port of  $q$ . Let us write  $(i|_j)$  for this connection operation. Note that we could connect them in two different ways:

- we could use  $f$  to change *the output of the first process*  $p \prec_i f$  before connecting both,  $(p \prec_i f) i|_j q$ ;
- and we could use  $f$  to change *the input of the second process*  $f \succ_j q$  before connecting both,  $p i|_j (f \succ_j q)$ .

These are different descriptions, made up of two different components. However, they essentially describe the same process: they are *dinaturally equal* [DLdFR22]. Indeed, profunctors are canonically endowed with a notion of *dinatural equivalence*

<sup>1</sup>We simply use  $(\prec/\succ)$  without any subscript whenever the input/output is unique. See Appendix, Section B for more details on profunctors.

[Bén00], [Lor21], which precisely equates these two descriptions. Profunctors, and their elements, are thus composed *up to dinatural equivalence*.

**Definition 2.2** (Dinatural equivalence). Consider two profunctors  $P: \mathbb{B}_0 \times \dots \times \mathbb{B}_m \bullet \dashv \vdash \mathbb{A}_0 \times \dots \times \mathbb{A}_n$  and  $Q: \mathbb{C}_0 \times \dots \times \mathbb{C}_k \bullet \dashv \vdash \mathbb{D}_0 \times \dots \times \mathbb{D}_h$  such that  $\mathbb{B}_i = \mathbb{C}_j$ ; and let  $\mathbf{S}_{P,Q}^{i,j}(A; C)$  be the set

$$\sum_{X \in \mathbb{B}_i} P(A_0 \dots A_n; B_0 \dots X \dots B_m) \times Q(C_0 \dots X \dots C_k; D_0 \dots D_h).$$

*Dinatural equivalence*,  $(\sim)$ , on the set  $\mathbf{S}_{P,Q}^{i,j}(A; C)$  is the smallest equivalence relation satisfying  $(p \prec_i f i|_j q) \sim (p i|_j f \succ_j q)$ . The *coend* is defined as this coproduct quotiented by dinaturality,  $\mathbf{S}_{P,Q}^{i,j}(A; C)/(\sim)$ , and written as an integral.

$$\int^{X \in \mathbb{C}} P(A_0 \dots A_n; B_0 \dots X \dots B_m) \times Q(C_0 \dots X \dots C_k; D_0 \dots D_h).$$

**Definition 2.3** (Profunctor composition). Consider two profunctors  $P: \mathbb{B}_0 \times \dots \times \mathbb{B}_m \bullet \dashv \vdash \mathbb{A}_0 \times \dots \times \mathbb{A}_n$  and  $Q: \mathbb{C}_0 \times \dots \times \mathbb{C}_k \bullet \dashv \vdash \mathbb{D}_0 \times \dots \times \mathbb{D}_h$  such that  $\mathbb{B}_i = \mathbb{C}_j$ ; their *composition* along ports  $i$  and  $j$  is a profunctor; we write it marking this connection

$$P(A_0 \dots A_n; B_0 \dots \bullet_x \dots B_n) \diamond Q(C_0 \dots \bullet_x \dots C_k; D_0 \dots D_h),$$

and it is defined as the coproduct of the product of both profunctors, indexed by the common variable, and quotiented by dinatural equivalence,

$$\int^{X \in \mathbb{C}} P(A_0 \dots A_n; B_0 \dots X \dots B_m) \times Q(C_0 \dots X \dots C_k; D_0 \dots D_h).$$

**Remark 2.4** (Representability). Every functor  $F: \mathbb{A} \rightarrow \mathbb{B}$  gives rise to two different profunctors: its representable profunctor  $\mathbb{A}(F\bullet, \bullet): \mathbb{A} \dashv \vdash \mathbb{B}$ , and its corepresentable profunctor  $\mathbb{A}(\bullet, F\bullet): \mathbb{A} \bullet \dashv \vdash \mathbb{B}$ . We say that a profunctor is *representable* or *corepresentable* if it arises in this way. Under this interpretation, functors are profunctors that happen to be representable. This suggests that we can repeat structures based on functors, such as monoidal categories, now in terms of profunctors.

We justified in the introduction the importance of monoidal categories: they are the algebra of processes composing sequentially and in parallel, joining and splitting resources. However, there exist some theories that can deal only with splitting without being necessarily full theories of processes: that is, we may be able to talk about splitting without being able to talk about joining. Such “monoidal categories on one side” are *promonoidal categories*.

The difference between monoidal categories and promonoidal categories is that the tensor is no longer a functor but is instead a profunctor.<sup>2</sup> In other words, the tensor is no longer representable – such a structure is called *virtual*, as in *virtual double* and *virtual duoidal categories* [CS10], [Shu17].

<sup>2</sup>In more technical terms, monoidal categories are pseudomonoids in the monoidal bicategory of categories *and functors*; while promonoidal categories are pseudomonoids in the monoidal bicategory of categories *and profunctors*.

## 2.2 Promonoidal Categories

Promonoidal categories are the algebra of *coherent decomposition*. A category  $\mathbb{C}$  contains sets of *morphisms*,  $\mathbb{C}(X; Y)$ . In the same way, a promonoidal category  $\mathbb{V}$  contains sets of *splits*,  $\mathbb{V}(X; Y_0 \triangleleft Y_1)$ , *morphisms*,  $\mathbb{V}(X; Y)$ , and *units*,  $\mathbb{V}(X; N)$ , where  $N$  is the virtual tensor unit. Splits,  $\mathbb{V}(X; Y_0 \triangleleft Y_1)$ , represent a way of decomposing objects of type  $X$  into objects of type  $Y_0$  and  $Y_1$ . Morphisms,  $\mathbb{V}(X; Y)$ , as in any category, are transformations of  $X$  into  $Y$ . Units,  $\mathbb{V}(X; N)$ , are the atomic pieces of type  $X$ .

These decompositions must be coherent. For instance, imagine we want to split  $X$  into  $Y_0$ ,  $Y_1$  and  $Y_2$ . Splitting  $X$  into  $Y_0$  and something  $(\bullet)$ , and then splitting that something into  $Y_1$  and  $Y_2$  *should be doable in essentially the same ways* as splitting  $X$  into something  $(\bullet)$  and  $Y_2$ , and then splitting that something into  $Y_0$  and  $Y_1$ . Formally, we are saying that,

$$\mathbb{V}(X; Y_0 \triangleleft \bullet) \diamond \mathbb{V}(\bullet; Y_1 \triangleleft Y_2) \cong \mathbb{V}(X; \bullet \triangleleft Y_2) \diamond \mathbb{V}(\bullet; Y_0 \triangleleft Y_1),$$

and, in fact, we just write  $\mathbb{V}(X; Y_0 \triangleleft Y_1 \triangleleft Y_2)$  for the set of such decompositions.

**Definition 2.5** (Promonoidal category). A *promonoidal category* is a category  $\mathbb{V}(\bullet; \bullet)$  endowed with profunctors

$$\mathbb{V}(\bullet; \bullet \triangleleft \bullet): \mathbb{V} \times \mathbb{V} \multimap \mathbb{V}, \text{ and } \mathbb{V}(\bullet; N): 1 \multimap \mathbb{V}.$$

Equivalently, these are functors

$$\mathbb{V}(\bullet; \bullet \triangleleft \bullet): \mathbb{V}^{\text{op}} \times \mathbb{V} \times \mathbb{V} \rightarrow \mathbf{Set}, \text{ and } \mathbb{V}(\bullet; N): \mathbb{V}^{\text{op}} \rightarrow \mathbf{Set}.$$

Moreover, promonoidal categories must be endowed with the following natural isomorphisms,

$$\begin{aligned} \mathbb{V}(X; \bullet \triangleleft Y_2) \diamond \mathbb{V}(\bullet; Y_0 \triangleleft Y_1) &\cong \mathbb{V}(X; \bullet \triangleleft Y_2) \diamond \mathbb{V}(\bullet; Y_0 \triangleleft Y_1), \\ \mathbb{V}(X; \bullet \triangleleft Y) \diamond \mathbb{V}(\bullet; N) &\cong \mathbb{V}(X; Y), \\ \mathbb{V}(X; Y \triangleleft \bullet) \diamond \mathbb{V}(\bullet; N) &\cong \mathbb{V}(X; Y), \end{aligned}$$

called  $\alpha, \lambda, \rho$ , respectively, and asked to satisfy the pentagon and triangle coherence equations,  $\alpha \circledast \alpha = (\alpha \diamond 1) \circledast \alpha \circledast (1 \diamond \alpha)$ , and  $(\rho \diamond 1) = \alpha \circledast (\lambda \diamond 1)$ .

**Definition 2.6** (Promonoidal functor). Let  $\mathbb{V}$  and  $\mathbb{W}$  be promonoidal categories. A *promonoidal functor*  $F: \mathbb{V}(\bullet; \bullet) \rightarrow \mathbb{W}(\bullet; \bullet)$  is a functor between the two categories, together with natural transformations:

$$\begin{aligned} F_{\triangleleft}: \mathbb{V}(A; B \triangleleft C) &\rightarrow \mathbb{W}(FA; FB \triangleleft FC), \text{ and} \\ F_N: \mathbb{V}(A; N) &\rightarrow \mathbb{W}(FA; N), \end{aligned}$$

that satisfy  $\lambda \circledast F_{\text{map}} = (F_{\triangleleft} \times F_N) \circledast \lambda$ ,  $\rho \circledast F_{\text{map}} = (F_{\triangleleft} \times F_N) \circledast \rho$ , and  $\alpha \circledast (F_{\triangleleft} \times F_{\triangleleft}) \circledast i = (F_{\triangleleft} \times F_{\triangleleft}) \circledast i \circledast \alpha$ . We denote by **Promon** the category of promonoidal categories and promonoidal functors.

**Remark 2.7** (Promonoidal coherence). As with monoidal categories, the pentagon and triangle equations imply that every formal equation written out of coherence isomorphisms holds. This means we can write  $\mathbb{V}(\bullet; \bullet \triangleleft \bullet \triangleleft \bullet)$  without specifying which one of the two sides of the associator we are describing.

**Remark 2.8** (Multicategories). The reader may be more familiar with the algebra of not-necessarily-coherent decomposition:

*multicategories*. Every promonoidal category  $\mathbb{V}$  induces a co-multicategory with morphisms given by elements of the following sets  $\mathbb{V}(\bullet; \bullet \triangleleft \bullet \triangleleft \bullet)$ . Similarly,  $\mathbb{V}^{\text{op}}$  is a copromonoidal category and thus induces a multicategory. These are special kinds of (co-)multicategories, they are *coherent* so that every  $n$ -to-1 morphism splits, in any possible shape, as 2-to-1 and 0-to-1 morphisms; moreover, they do so *uniquely up to dinaturality*. Appendix B.2 spells out this relation.

The next section studies how to coherently decompose morphisms of a category. Categories are an algebraic structure for sequential composition: they contain a “sequencing” operator  $(\circledast)$  and a neutral element,  $\text{id}$ . We present an algebra for decomposing sequential compositions in terms of promonoidal categories.

## 3 SEQUENTIAL CONTEXT

Assume a morphism factors as follows,

$$f_0 \circledast g_0 \circledast h \circledast g_1 \circledast f_1 \circledast k \circledast f_2.$$

We can say that this morphism came from the context  $f_0 \circledast \square \circledast f_1 \circledast \square \circledast f_2$ , filled on its left side with the context  $g_0 \circledast \square \circledast g_1$ , then filled with  $h$ , and finally completed on its right side with the morphism  $k$ . Figure 5 expresses this decomposition.

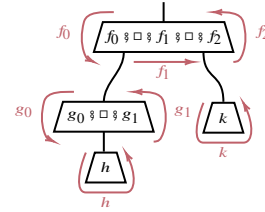

Fig. 5: Decomposition of  $f_0 \circledast g_0 \circledast h \circledast g_1 \circledast f_1 \circledast k \circledast f_2$ .

Contexts compose in a tree-like structure, and their resulting morphism is extracted by *contouring* that tree. This section presents the algebra of *context* and *decomposition*. We then prove that they are two sides of the same coin: the two sides of an adjunction of categories.

### 3.1 Contour of a Promonoidal Category

Any promonoidal category freely generates another category, its *contour*. This can be interpreted as the category that tracks the processes of decomposition that the promonoidal category describes. The construction is particularly pleasant from the geometric point of view: it takes its name from the fact that it can be constructed by following the contour of the shape of the decomposition.

**Definition 3.1** (Contour). The *contour* of a promonoidal category  $\mathbb{V}$  is a category  $C\mathbb{V}$  that has two objects,  $X^L$  (left-handed) and  $X^R$  (right-handed), for each object  $X \in \mathbb{V}_{\text{obj}}$ ; and has arrows those that arise from *contouring* the decompositions of the promonoidal category.

Specifically, it is freely presented by (i) a morphism  $a_0 \in C\mathbb{V}(A^L; A^R)$ , for each unit  $a \in \mathbb{V}(A; N)$ ; (ii) a pair of morphisms  $b_0 \in C\mathbb{V}(B^L; X^L)$ ,  $b_1 \in C\mathbb{V}(X^R; B^R)$ , for each

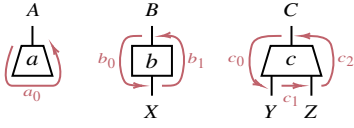

Fig. 6: Contour of a promonoidal.

morphism  $b \in \mathbb{V}(B; X)$ ; and (iii) a triple of morphisms  $c_0 \in C\mathbb{V}(C^L; Y^L)$ ,  $c_1 \in C\mathbb{V}(Y^R; Z^L)$ ,  $c_2 \in C\mathbb{V}(Z^R; C^R)$  for each split  $c \in \mathbb{V}(C; Y \triangleleft Z)$ , see Figure 6.

For each equality  $\alpha(a|b) = (c|d)$ , we impose the equations  $a_0 = c_0 \circledast d_0$ ;  $a_1 \circledast b_0 = d_1$  and  $b_1 = d_2 \circledast c_1$ ;  $a_2 \circledast b_2 = c_2$ . For each equality  $\rho(a|b) = c = \lambda(d|e)$ , we impose  $a_0 = c_0 = d_0 \circledast e_0 \circledast d_1$  and  $a_1 \circledast b_0 \circledast a_2 = c_1 = d_2$ . Graphically, these follow Figure 7.

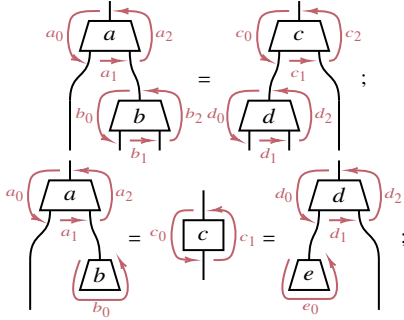

Fig. 7: Equations between contours from  $\alpha, \rho$ , and  $\lambda$  in  $\mathbb{V}$ .

**Proposition 3.2.** *Contour gives a functor  $C : \mathbf{Promon} \rightarrow \mathbf{Cat}$ .*

*Proof.* See Appendix, Proposition C.1.  $\square$

*Remark 3.3.* The contour of a multicategory was first introduced by Melliès and Zeilberger [MZ22]. Definition 3.1 and the following Theorem 3.7 closely follow their work; although the promonoidal version we introduce does involve fewer equations due to the extra coherence (Remark 2.8).

### 3.2 The Promonoidal Category of Spliced Arrows

We described a category tracking the process of decomposing in a given promonoidal category. However, we want to go the other way around: given a category, what is the promonoidal category describing decomposition in that category? This subsection finds a right adjoint to the contour construction: the spliced arrows promonoidal category. Spliced arrows have already been used to describe context in parsing [MZ22].

**Definition 3.4** (Spliced arrows). Let  $\mathbb{C}$  be a category. The promonoidal category of *spliced arrows*,  $SC$ , has as objects pairs of objects of  $\mathbb{C}$ . It uses the following profunctors to define morphisms, splits and units.

$$\begin{aligned} SC\left(\frac{A}{B}; \frac{X}{Y}\right) &= \mathbb{C}(A; X) \times \mathbb{C}(Y; B); \\ SC\left(\frac{A}{B}; \frac{X}{Y} \triangleleft \frac{X'}{Y'}\right) &= \mathbb{C}(A; X) \times \mathbb{C}(Y; X') \times \mathbb{C}(Y'; B); \\ SC\left(\frac{A}{B}; N\right) &= \mathbb{C}(A; B). \end{aligned}$$

In other words, morphisms are *pairs of arrows*  $f : A \rightarrow X$  and  $g : Y \rightarrow B$ . Splits are *triples of arrows*  $f : A \rightarrow X$ ,  $g : Y \rightarrow$

$X'$  and  $h : Y' \rightarrow B$ . Units are simply *arrows*  $f : A \rightarrow B$ . We use the following notation for

$$\begin{aligned} \text{morphisms,} \quad & f \circledast \square \circledast g && \in SC\left(\frac{A}{B}; \frac{X}{Y}\right); \\ \text{splits,} \quad & f \circledast \square \circledast g \circledast \square \circledast h && \in SC\left(\frac{A}{B}; \frac{X}{Y} \triangleleft \frac{X'}{Y'}\right); \\ \text{and units,} \quad & f && \in SC\left(\frac{A}{B}; N\right). \end{aligned}$$

The profunctor actions, associativity and unitality of the promonoidal category are defined in a straightforward way by *filling the holes*. For instance,

$$\begin{aligned} (f \circledast \square \circledast g \circledast \square \circledast h) <_1 (u \circledast \square \circledast v) &= (f \circledast u \circledast \square \circledast v \circledast g \circledast \square \circledast h), \\ (f \circledast \square \circledast g \circledast \square \circledast h) <_2 (u \circledast \square \circledast v) &= (f \circledast \square \circledast g \circledast u \circledast \square \circledast v \circledast h). \end{aligned}$$

See the Appendix, Section C for details.

**Proposition 3.5.** *Spliced arrows form a promonoidal category with their splits, units, and suitable coherence morphisms.*

*Proof.* See Appendix, Proposition C.2.  $\square$

As a consequence, we can talk about spliced arrows with an arbitrary number of holes: for instance, a three-way split arises as a split filled by another split, in either position. For instance,

$$\langle f_0 \circledast \square \circledast f_1 \circledast \square \circledast f_2 \circledast \square \circledast f_3 \rangle$$

can be written in two different ways,

$$\begin{aligned} \langle f_0 \circledast \square \circledast f_2 \circledast \square \circledast f_3 \rangle <_1 \langle id \circledast \square \circledast f_1 \circledast \square \circledast id \rangle &\quad \text{or} \\ \langle f_0 \circledast \square \circledast f_1 \circledast \square \circledast f_3 \rangle <_2 \langle id \circledast \square \circledast f_2 \circledast \square \circledast id \rangle. \end{aligned}$$

**Proposition 3.6.** *Splice gives a functor  $S : \mathbf{Cat} \rightarrow \mathbf{Promon}$ .*

*Proof.* See Appendix, Proposition C.6.  $\square$

**Theorem 3.7.** *There exists an adjunction between categories and promonoidal categories, where the contour of a promonoidal is the left adjoint, and the splice category is the right adjoint.*

*Proof.* See Appendix, Theorem C.7.  $\square$

Spliced arrows can be computed for *any* category, including monoidal categories. However, we expect the spliced arrows of a monoidal category to have a richer algebraic structure. This extra structure is the subject of the next section.

## 4 PARALLEL-SEQUENTIAL CONTEXT

Monoidal categories are an algebraic structure for sequential and parallel composition: they contain a “tensoring” operator on morphisms,  $(\otimes)$ , apart from the usual sequencing,  $(\circledast)$ , and identities ( $id$ ).

Assume a monoidal morphism factors as follows,

$$f_0 \circledast (g \otimes (h \circledast (k \otimes (l_0 \circledast l_1)))) \circledast f_1.$$

We can say that this morphism came from dividing everything between  $f_0$  and  $f_1$  by a tensor. That is, from a context  $f_0 \circledast (\square \otimes \square) \circledast f_1$ . We filled the first hole of this context with a  $g$ , and then proceeded to split the second part as  $h \circledast (\square \otimes \square) \circledast id$ . Finally, we filled the first part with  $k$  and the second one we left disconnected by filling it with  $l_0$ ,  $id_I$ , and  $l_1$ .

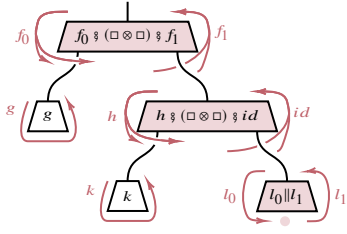

Fig. 8: Decomposition of  $f_0 ; (g \otimes (h ; (k \otimes (l_0 ; l_1)))) ; f_1$ .

This section studies decomposition of morphisms in a *monoidal* category, in the same way we studied decomposition of morphisms in a category before. We present an algebraic structure for decomposing both sequential and parallel compositions: *produoidal categories*.

#### 4.1 Produoidal Categories

Produoidal categories, first defined by Booker and Street [BS13], provide an algebraic structure for the interaction of sequential and parallel decomposition. A produoidal category  $\mathbb{V}$  not only contains *morphisms*,  $\mathbb{V}(X; Y)$ , *sequential splits*,  $\mathbb{V}(X; Y_0 \triangleleft Y_1)$ , and *sequential units*,  $\mathbb{V}(X; N)$ , as a promonoidal category does; it also contains *parallel splits*,  $\mathbb{V}(X; Y_0 \otimes Y_1)$  and *parallel units*,  $\mathbb{V}(X; I)$ .

*Remark 4.1* (Nesting virtual structures). Notation for nesting functorial structures, say  $(\triangleleft)$  and  $(\otimes)$ , is straightforward: we use expressions like  $(X_1 \otimes Y_1) \triangleleft (X_2 \otimes Y_2)$  without a second thought. Nesting the virtual structures  $(\triangleleft)$  and  $(\otimes)$  is more subtle: defining  $\mathbb{V}(\bullet; X \otimes Y)$  and  $\mathbb{V}(\bullet; X \triangleleft Y)$  for each pair of objects  $X$  and  $Y$  does not itself define what something like  $\mathbb{V}(\bullet; (X_1 \otimes Y_1) \triangleleft (X_2 \otimes Y_2))$  means. Recall that, in the virtual case,  $X_1 \triangleleft Y_1$  and  $X_1 \otimes Y_1$  are not objects themselves: they are just names for the profunctors  $\mathbb{V}(\bullet; X_1 \triangleleft Y_1)$  and  $\mathbb{V}(\bullet; X_1 \otimes Y_1)$ .

Instead, when we write  $\mathbb{V}(\bullet; (X_1 \otimes Y_1) \triangleleft (X_2 \otimes Y_2))$ , we formally mean  $\mathbb{V}(\bullet; \bullet_1 \triangleleft \bullet_2) \diamond \mathbb{V}(\bullet_1; X_1 \otimes Y_1) \diamond \mathbb{V}(\bullet_2; X_2 \otimes Y_2)$ . By convention, nesting virtual structures means profunctor composition in this text.

**Definition 4.2** (Produoidal category). A *produoidal category* is a category  $\mathbb{V}$  endowed with two promonoidal structures,

$$\begin{aligned} \mathbb{V}(\bullet; \bullet \otimes \bullet) : \mathbb{V} \times \mathbb{V} &\multimap \mathbb{V}, \text{ and } \mathbb{V}(\bullet; I) : 1 \multimap \mathbb{V}, \\ \mathbb{V}(\bullet; \bullet \triangleleft \bullet) : \mathbb{V} \times \mathbb{V} &\multimap \mathbb{V}, \text{ and } \mathbb{V}(\bullet; N) : 1 \multimap \mathbb{V}, \end{aligned}$$

such that one laxly distributes over the other. This is to say that it is endowed with the following natural *laxators*,

$$\begin{aligned} \psi_2 : \mathbb{V}(\bullet; (X \triangleleft Y) \otimes (Z \triangleleft W)) &\rightarrow \mathbb{V}(\bullet; (X \otimes Z) \triangleleft (Y \otimes W)), \\ \psi_0 : \mathbb{V}(\bullet; I) &\rightarrow \mathbb{V}(\bullet; I \triangleleft I), \\ \varphi_2 : \mathbb{V}(\bullet; N \otimes N) &\rightarrow \mathbb{V}(\bullet; N), \\ \varphi_0 : \mathbb{V}(\bullet; I) &\rightarrow \mathbb{V}(\bullet; N). \end{aligned}$$

Laxators, together with unitors and associators, must satisfy coherence conditions (see Appendix, Definition I.5).

**Definition 4.3** (Produoidal functor). Let  $\mathbb{V}_{\otimes, I, \triangleleft, N}$  and  $\mathbb{W}_{\otimes, J, \triangleleft, M}$  be produoidal categories. A *produoidal functor*  $F$

is a functor between the two categories  $F : \mathbb{V}(\bullet, \bullet) \rightarrow \mathbb{W}(\bullet, \bullet)$  together with natural transformations

$$\begin{aligned} F_{\otimes} : \mathbb{V}(A; B \otimes C) &\rightarrow \mathbb{W}(FA; FB \otimes FC), \\ F_I : \mathbb{V}(A; I) &\rightarrow \mathbb{W}(FA; J), \\ F_{\triangleleft} : \mathbb{V}(A; B \triangleleft C) &\rightarrow \mathbb{W}(FA; FB \triangleleft FC), \text{ and} \\ F_N : \mathbb{V}(A; N) &\rightarrow \mathbb{W}(FA; M), \end{aligned}$$

preserving coherence isomorphisms for each promonoidal structure, and the laxators. Denote by **Produo** the category of produoidal categories and produoidal functors.

#### 4.2 Monoidal Contour of a Produoidal Category

Any produoidal category freely generates a monoidal category, its *monoidal contour*. Again, this is interpreted as a monoidal category tracking the processes of parallel and sequential decomposition described by the produoidal category. And again, the construction follows a pleasant geometric pattern, where we follow the shape of the decomposition, now in both the parallel and sequential dimensions.

**Definition 4.4** (Monoidal contour). The *contour* of a produoidal category  $\mathbb{B}$  is the monoidal category  $\mathcal{DB}$  that has two objects,  $X^L$  (left-handed) and  $X^R$  (right-handed), for each object  $X \in \mathbb{B}_{\text{obj}}$ ; and has arrows those that arise from *contouring* both sequential and parallel decompositions of the promonoidal category.

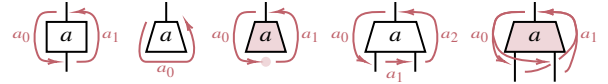

Fig. 9: Generators of the monoidal category of contours.

Specifically, it is freely presented by (i) a pair of morphisms  $a_0 \in \mathcal{DB}(A^L; X^L)$ ,  $a_1 \in \mathcal{DB}(X^R; A^R)$  for each morphism  $a \in \mathbb{B}(A; X)$ ; (ii) a morphism  $a_0 \in \mathcal{DB}(A^L; A^R)$ , for each sequential unit  $a \in \mathbb{C}(A; N)$ ; (iii) a pair of morphisms  $a_0 \in \mathcal{DB}(A^L; I)$  and  $a_0 \in \mathcal{DB}(I; A^R)$ , for each parallel unit  $a \in \mathbb{B}(A; I)$ ; (iv) a triple of morphisms  $a_0 \in \mathcal{DB}(A^L; X^L)$ ,  $a_1 \in \mathcal{DB}(X^R; Y^L)$ ,  $a_2 \in \mathcal{DB}(Y^R; A^R)$  for each sequential split  $a \in \mathbb{B}(A; X \triangleleft Y)$ ; and (v) a pair of morphisms  $a_0 \in \mathcal{DB}(A^L; X^L \otimes Y^L)$  and  $a_1 \in \mathcal{DB}(X^R \otimes Y^R; A^R)$  for each parallel split  $a \in \mathbb{B}(A; X \otimes Y)$ , see Figure 9.

We impose the same equations as in the categorical contour coming from the associator and unitor of the  $\triangleleft$  structure; but moreover, we impose the following new equations, coming from the  $\otimes$  structure: For each application of associativity,  $a \circledast_1 b = c \circledast_2 d$ , we impose the equations  $a_0 \circledast (b_0 \otimes \text{id}) = c_0 \circledast (\text{id} \otimes d_0)$  and  $(b_1 \otimes \text{id}) \circledast a_1 = (\text{id} \otimes d_1) \circledast c_1$ . These follow from Figure 10.

For each application of unitality,  $\lambda(a \circledast_1 b) = c = \rho(d \circledast_2 e)$ , we impose the equations  $a_0 \circledast (b_0 \otimes \text{id}) = c_0 = d_0 \circledast (\text{id} \otimes e_0)$  and  $(b_1 \otimes \text{id}) \circledast a_1 = c_1 = (\text{id} \otimes e_1) \circledast d_1$ . These follow from Figure 11.

For each application of the laxator,  $\psi_2(a | b | c) = (d | e | f)$ , we impose the equation  $a_0 \circledast (b_0 \otimes c_0) = d_0 \circledast e_0$ , the middle

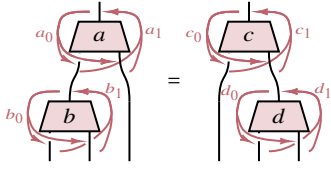

Fig. 10: Equation between contours from  $\otimes$  associator.

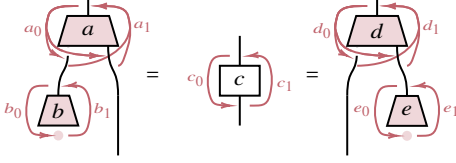

Fig. 11: Equations from  $\otimes$  unitor.

equation  $b_1 \otimes c_1 = e_1 \mathbin{\text{;}} d_1 \mathbin{\text{;}} f_0$ , and  $(b_2 \otimes c_2) \mathbin{\text{;}} a_1 = f_1 \mathbin{\text{;}} d_2$ . These follow Figure 12. We finally impose similar equations for the rest of the laxators, see Definition D.1 for details.

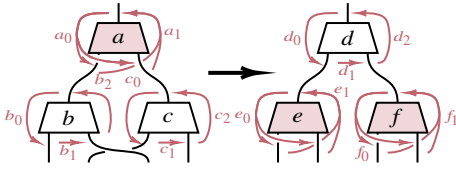

Fig. 12: Equations from the laxator  $\psi_2$ .

**Proposition 4.5.** *Monoidal contour extends to a functor  $\mathcal{D} : \mathbf{Produo} \rightarrow \mathbf{Mon}$ .*

*Proof.* See Appendix, Proposition D.2.  $\square$

### 4.3 Produoidal Category of Spliced Monoidal Arrows

Again, we want to go the other way around: given a monoidal category, what is the produoidal category that tracks decomposition of arrows in that monoidal category? This subsection finds a right adjoint to the monoidal contour construction: the produoidal category of *spliced monoidal arrows*.

**Definition 4.6.** Let  $(\mathbb{C}, \otimes, I)$  be a monoidal category. The produoidal category of *spliced monoidal arrows*,  $\mathcal{TC}$ , has as objects pairs of objects of  $\mathbb{C}$ . It uses the following profunctors to define sequential splits, parallel splits, sequential units, parallel units and morphisms.

$$\begin{aligned} \mathcal{TC}(\overset{A}{\underset{B}{\square}}; \overset{X}{\underset{Y}{\square}}) &= \mathbb{C}(A; X) \times \mathbb{C}(Y; B); \\ \mathcal{TC}(\overset{A}{\underset{B}{\square}}; \overset{X}{\underset{Y}{\square}} \triangleleft \overset{X'}{\underset{Y'}{\square}}) &= \mathbb{C}(A; X) \times \mathbb{C}(Y; X') \times \mathbb{C}(Y'; B); \\ \mathcal{TC}(\overset{A}{\underset{B}{\square}}; \overset{X}{\underset{Y}{\square}} \otimes \overset{X'}{\underset{Y'}{\square}}) &= \mathbb{C}(A; X \otimes X') \times \mathbb{C}(Y \otimes Y'; B); \\ \mathcal{TC}(\overset{A}{\underset{B}{\square}}; N) &= \mathbb{C}(A; B); \\ \mathcal{TC}(\overset{A}{\underset{B}{\square}}; I) &= \mathbb{C}(A; I) \times \mathbb{C}(I; B). \end{aligned}$$

In other words, morphisms are *pairs of arrows*  $f : A \rightarrow X$  and  $g : Y \rightarrow B$ . sequential splits are *triples of arrows*  $f : A \rightarrow X$ ,  $g : Y \rightarrow X'$  and  $h : Y' \rightarrow B$ . Parallel splits are *pairs of arrows*  $f : A \rightarrow X \otimes X'$  and  $g : Y \otimes Y' \rightarrow B$ . Sequential units are *arrows*

$f : A \rightarrow B$ . parallel units are pairs of arrows  $f : A \rightarrow I$  and  $g : I \rightarrow B$ . In summary, we have

$$\begin{aligned} \text{morphisms,} & f \mathbin{\text{;}} \square \mathbin{\text{;}} g && \in \mathcal{TC}(\overset{A}{\underset{B}{\square}}; \overset{X}{\underset{Y}{\square}}); \\ \text{sequential splits,} & f \mathbin{\text{;}} \square \mathbin{\text{;}} g \mathbin{\text{;}} \square \mathbin{\text{;}} h && \in \mathcal{TC}(\overset{A}{\underset{B}{\square}}; \overset{X}{\underset{Y}{\square}} \triangleleft \overset{X'}{\underset{Y'}{\square}}); \\ \text{parallel splits,} & f \mathbin{\text{;}} (\square \otimes \square) \mathbin{\text{;}} h && \in \mathcal{TC}(\overset{A}{\underset{B}{\square}}; \overset{X}{\underset{Y}{\square}} \otimes \overset{X'}{\underset{Y'}{\square}}); \\ \text{sequential units,} & f && \in \mathcal{TC}(\overset{A}{\underset{B}{\square}}; N); \\ \text{and parallel units,} & f \parallel g && \in \mathcal{TC}(\overset{A}{\underset{B}{\square}}; I). \end{aligned}$$

Finally, the laxators unite two different connections between two gaps into a single one. For instance, the last laxator takes parallel sequences of holes,

$$f_0 \mathbin{\text{;}} ((h_0 \mathbin{\text{;}} \square \mathbin{\text{;}} h_1 \mathbin{\text{;}} \square \mathbin{\text{;}} h_2) \otimes (k_0 \mathbin{\text{;}} \square \mathbin{\text{;}} k_1 \mathbin{\text{;}} \square \mathbin{\text{;}} k_2)) \mathbin{\text{;}} f_1$$

into sequences of parallel holes,

$$f_0 \mathbin{\text{;}} (h_0 \otimes k_0) \mathbin{\text{;}} (\square \otimes \square) \mathbin{\text{;}} (h_1 \otimes k_1) \mathbin{\text{;}} (\square \otimes \square) \mathbin{\text{;}} (h_2 \otimes k_2) \mathbin{\text{;}} f_1.$$

See Appendix, Section D.2 for details.

**Proposition 4.7.** *Spliced monoidal arrows form a produoidal category with their sequential and parallel splits, units, and suitable coherence morphisms and laxators.*

*Proof.* See Appendix, Proposition D.3.  $\square$

**Proposition 4.8.** *Spliced monoidal arrows extends to a functor  $\mathcal{T} : \mathbf{Mon} \rightarrow \mathbf{Produo}$ .*

*Proof.* See Appendix, Proposition D.8.  $\square$

As in the categorical case, spliced monoidal arrows and monoidal contour again form an adjunction. This adjunction characterizes spliced monoidal arrows as a cofree construction.

**Theorem 4.9.** *There exists an adjunction between monoidal categories and produoidal categories, where the monoidal contour is the left adjoint, and the produoidal splice category is the right adjoint.*

*Proof.* See Appendix, Theorem D.9.  $\square$

### 4.4 Representable Parallel Structure

A produoidal category has two tensors, and neither is, in principle, representable. However, the cofree produoidal category over a category we have just constructed happens also to have a representable tensor,  $(\otimes)$ . Spliced monoidal arrows form a monoidal category.

**Proposition 4.10.** *Parallel splits and parallel units of spliced monoidal arrows are representable profunctors. Explicitly,*

$$\mathcal{TC}(\overset{A}{\underset{B}{\square}}; \overset{X}{\underset{Y}{\square}} \otimes \overset{X'}{\underset{Y'}{\square}}) \cong \mathcal{TC}(\overset{A}{\underset{B}{\square}}; \overset{X \otimes X'}{\underset{Y \otimes Y'}{\square}}), \text{ and } \mathcal{TC}(\overset{A}{\underset{B}{\square}}; I) \cong \mathcal{TC}(\overset{A}{\underset{B}{\square}}; I).$$

In fact, these sets are equal by definition. However, there is a good reason to work in the full generality of produoidal categories: every produoidal category, representable or not, has an associated *normal* produoidal category, which may be again representable or not. Normalization is a canonical procedure to mix both tensors,  $(\otimes)$  and  $(\triangleleft)$ ; and it will allow us to write *monoidal contexts* in Section 6, which form a produoidal category without representable structure.



*Remark 4.11.* This means  $\mathcal{TC}$  has the structure of a *virtual duoidal category* [Shu17] or *monoidal multicategory*, defined by Aguiar, Haim and López Franco [AHLF18] as a pseudomonoid in the cartesian monoidal 2-category of multicategories.

## 5 INTERLUDE: NORMALIZATION

Produoidal categories seem to contain too much structure: of course, we want to split things in two different ways, sequentially ( $\triangleleft$ ) and in parallel ( $\otimes$ ); but that does not necessarily mean that we want to keep track of two different types of units, parallel ( $I$ ) and sequential ( $N$ ). The atomic components of our decomposition algebra should be the same, without having to care if they are *atomic for sequential composition* or *atomic for parallel composition*.

Fortunately, there exists an abstract procedure that, starting from any produoidal category, constructs a new produoidal category where both units are identified. This procedure is known as *normalization*, and the resulting produoidal categories are called *normal*.

**Definition 5.1** (Normal produoidal category). A *normal produoidal category* is a produoidal category where the laxator  $\varphi_0: \mathbb{V}(\bullet; I) \rightarrow \mathbb{V}(\bullet; N)$  is an isomorphism.

Normal produoidal categories form a category  $\mathbf{nProduo}$  with produoidal functors between them and endowed with fully faithful forgetful functor  $\mathcal{U}: \mathbf{nProduo} \rightarrow \mathbf{Produo}$ .

**Theorem 5.2.** Let  $\mathbb{V}_{\otimes, I, \triangleleft, N}$  be a produoidal category. The profunctor  $N\mathbb{V}(\bullet; \bullet) = \mathbb{V}(\bullet; N \otimes \bullet \otimes N)$  forms a promonad. Moreover, the Kleisli category of this promonad is a normal produoidal category with the following splits and units.

$$\begin{aligned} N\mathbb{V}(A; B) &= \mathbb{V}(A; N \otimes B \otimes N); \\ N\mathbb{V}(A; B \otimes_N C) &= \mathbb{V}(A; N \otimes B \otimes N \otimes C \otimes N); \\ N\mathbb{V}(A; B \triangleleft_N C) &= \mathbb{V}(A; (N \otimes B \otimes N) \triangleleft (N \otimes C \otimes N)); \\ N\mathbb{V}(A; I_N) &= \mathbb{V}(A; N); \\ N\mathbb{V}(A; N_N) &= \mathbb{V}(A; N). \end{aligned}$$

*Proof.* See Appendix, Theorem E.1.  $\square$

A normalization procedure for duoidal categories was given by Garner and López Franco [GF16]; our contribution is its produoidal counterpart. This novel produoidal normalization is better behaved than the duoidal one [GF16]: the latter does not always exist, but we show produoidal normalization does. Indeed, we prove that produoidal normalization forms an idempotent monad. The technical reason for this improvement is that the original required the existence of certain coequalizers in  $\mathbb{V}$ ; produoidal normalization uses coequalizers in  $\mathbf{Set}$ . Appendix E.3 outlines a relation between the two procedures.

**Theorem 5.3.** Normalization extends to an idempotent monad.

*Proof.* See Appendix, Theorem E.3.  $\square$

**Theorem 5.4** (Free normal produoidal). Normalization determines an adjunction between produoidal categories and

normal produoidal categories,  $N: \mathbf{Produo} \rightleftarrows \mathbf{nProduo}: \mathcal{U}$ . That is,  $N\mathbb{V}$  is the free produoidal category over  $\mathbb{V}$ .

*Proof.* See Appendix, Theorem E.5.  $\square$

In the previous Section 4, we constructed the produoidal category of spliced monoidal arrows, which distinguishes between morphisms and morphisms with a hole in the monoidal unit. This is because the latter hole splits the morphism in two parts. Normalization equates both; it sews these two parts. In Section 6, we explicitly construct monoidal contexts, the normalization of spliced monoidal arrows.

### 5.1 Symmetric Normalization

Normalization is a generic procedure that applies to any produoidal category, it does not matter if the parallel split ( $\otimes$ ) is symmetric or not. However, when  $\otimes$  happens to be symmetric, we can also apply a more specialized normalization procedure.

**Definition 5.5** (Symmetric produoidal category). A *symmetric produoidal category* is a produoidal category  $\mathbb{V}_{\triangleleft, N, \otimes, I}$  endowed with a natural isomorphism  $\sigma: \mathbb{V}(A; B \otimes C) \cong \mathbb{V}(A; C \otimes B)$  satisfying the symmetry and hexagon equations.

**Theorem 5.6.** Let  $\mathbb{V}_{\otimes, I, \triangleleft, N}$  be a symmetric produoidal category. The profunctor  $N_\sigma\mathbb{V}(\bullet; \bullet) = \mathbb{V}(\bullet; N \otimes \bullet)$  forms a promonad. Moreover, the Kleisli category of this promonad is a normal symmetric produoidal category with the following splits and units.

$$\begin{aligned} N_\sigma\mathbb{V}(A; B) &= \mathbb{V}(A; N \otimes B); \\ N_\sigma\mathbb{V}(A; B \otimes_N C) &= \mathbb{V}(A; N \otimes B \otimes C); \\ N_\sigma\mathbb{V}(A; B \triangleleft_N C) &= \mathbb{V}(A; (N \otimes B) \triangleleft (N \otimes C)); \\ N_\sigma\mathbb{V}(A; I_N) &= \mathbb{V}(A; N); \\ N_\sigma\mathbb{V}(A; N_N) &= \mathbb{V}(A; N). \end{aligned}$$

*Proof.* See Appendix, Theorem E.6.  $\square$

**Theorem 5.7.** Normalization determines an adjunction between symmetric produoidal and normal symmetric produoidal categories,  $N_\sigma: \mathbf{SymProduo} \rightleftarrows \mathbf{nSymProduo}: \mathcal{U}$ . That is,  $N_\sigma\mathbb{V}$  is the free symmetric produoidal category over  $\mathbb{V}$ .

*Proof.* See Appendix, Theorem E.11.  $\square$

## 6 MONOIDAL CONTEXT: MIXING $\triangleleft$ AND $\otimes$ BY NORMALIZATION

Monoidal contexts formalize the notion of an incomplete morphism in a monoidal category. The category of monoidal contexts will have a rich algebraic structure: we shall be able to still compose contexts sequentially and in parallel and, at the same time, we shall be able to fill a context using another monoidal context. Perhaps surprisingly, then, the category of monoidal contexts is not even monoidal.

We justify this apparent contradiction in terms of profunctorial structure: the category is not monoidal, but it does have two promonoidal structures that precisely represent sequential and parallel composition. These structures form a normal

produoidal category. In fact, we show it to be the normalization of the produoidal category of spliced monoidal arrows.

This section constructs explicitly the normal produoidal category of monoidal contexts.

### 6.1 The Category of Monoidal Contexts

A monoidal context,  $\mathcal{MC}(A; X; Y)$ , represents a process from  $A$  to  $B$  with a hole admitting a process from  $X$  to  $Y$ . In this sense, monoidal contexts are similar to spliced monoidal arrows. The difference with spliced monoidal arrows is that monoidal contexts allow for communication to happen to the left and to the right of this hole.

**Definition 6.1** (Monoidal context). Let  $(\mathbb{C}, \otimes, I)$  be a monoidal category. *Monoidal contexts* are the elements of the following profunctor,

$$\mathcal{MC}(A; X; Y) = \mathbb{C}(A; \bullet_1 \otimes X \otimes \bullet_2) \diamond \mathbb{C}(\bullet_1 \otimes Y \otimes \bullet_2; B).$$

In other words, a *monoidal context* from  $A$  to  $B$ , with a hole from  $X$  to  $Y$ , is an equivalence class consisting of a pair of objects  $M, N \in \mathbb{C}_{\text{obj}}$  and a pair of morphisms  $f \in \mathbb{C}(A; M \otimes X \otimes N)$  and  $g \in \mathbb{C}(M \otimes Y \otimes N; B)$ , quotiented by dinaturality of  $M$  and  $N$  (Figure 13). We write monoidal contexts as

$$(f \ ; \ (\text{id}_M \otimes \blacksquare \otimes \text{id}_N) \ ; \ g) \in \mathcal{MC}(A; X; Y).$$

In this notation, dinaturality explicitly means that

$$\begin{aligned} (f \ ; \ (m \otimes \text{id}_X \otimes n) \ ; \ (\text{id}_W \otimes \blacksquare \otimes \text{id}_H) \ ; \ g) &= \\ (f \ ; \ (\text{id}_M \otimes \blacksquare \otimes \text{id}_N) \ ; \ (m \otimes \text{id}_Y \otimes n) \ ; \ g). \end{aligned}$$

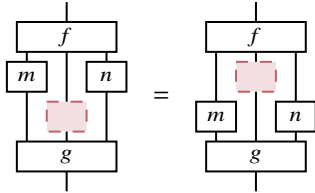

Fig. 13: Dinaturality for monoidal contexts.

**Proposition 6.2.** *Monoidal contexts form a category.*

*Proof.* We define composition of monoidal contexts by the following formula (illustrated in Figure 29, iii).

$$\begin{aligned} (f \ ; \ (\text{id}_M \otimes \blacksquare \otimes \text{id}_N) \ ; \ g) \prec (h \ ; \ (\text{id}_{M'} \otimes \blacksquare \otimes \text{id}_{N'}) \ ; \ k) &= \\ f \ ; \ (\text{id}_M \otimes h \otimes \text{id}_N) \ ; \ (\text{id}_{M \otimes M'} \otimes \blacksquare \otimes \text{id}_{N \otimes N'}) & \\ \ ; \ (\text{id}_M \otimes k \otimes \text{id}_N) \ ; \ g \end{aligned}$$

For each pair of objects, we define the identity monoidal context as  $\text{id}_A \ ; \ \blacksquare \ ; \ \text{id}_B$  (illustrated in Figure 29, ii). We check that this composition is associative and unital in the Appendix, Proposition F.3.  $\square$

*Remark 6.3.* Even when we introduce  $(\text{id} \otimes \blacksquare \otimes \text{id})$  as a piece of suggestive notation, we can still write  $(g \otimes \blacksquare \otimes h)$  unambiguously, because of dinaturality,

$$(g \otimes \text{id} \otimes h) \ ; \ (\text{id} \otimes \blacksquare \otimes \text{id}) = (\text{id} \otimes \blacksquare \otimes \text{id}) \ ; \ (g \otimes \text{id} \otimes h).$$

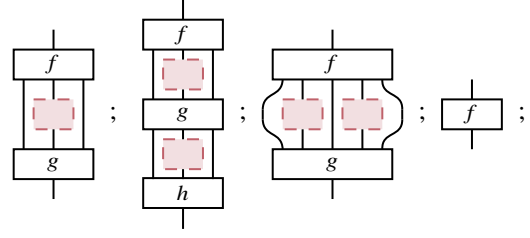

Fig. 14: Morphisms, sequential and parallel splits, and units of the splice monoidal arrow produoidal category.

### 6.2 The Normal Produoidal Algebra of Monoidal Contexts

Let us endow monoidal contexts with their normal produoidal structure.

**Definition 6.4.** The category of monoidal contexts,  $\mathcal{MC}$ , has as objects pairs of objects of  $\mathbb{C}$ . We use the following profunctors to define sequential splits, parallel splits, units and morphisms.

$$\begin{aligned} \mathcal{MC}(A; X; Y) &= \mathbb{C}(A; \bullet_1 \otimes X \otimes \bullet_2) \diamond \mathbb{C}(\bullet_1 \otimes Y \otimes \bullet_2; B); \\ \mathcal{MC}(A; X; Y \prec X') &= \mathbb{C}(A; \bullet_1 \otimes X \otimes \bullet_2) \diamond \\ &\quad \mathbb{C}(\bullet_1 \otimes Y \otimes \bullet_2; \bullet_3 \otimes X' \otimes \bullet_4) \diamond \\ &\quad \mathbb{C}(\bullet_3 \otimes Y' \otimes \bullet_4; B); \\ \mathcal{MC}(A; X; Y \otimes X') &= \mathbb{C}(A; \bullet_1 \otimes X \otimes \bullet_2 \otimes X' \otimes \bullet_3) \diamond \\ &\quad \mathbb{C}(\bullet_1 \otimes Y \otimes \bullet_2 \otimes Y' \otimes \bullet_3; B); \\ \mathcal{MC}(A; B; N) &= \mathbb{C}(A; B). \end{aligned}$$

In other words, sequential splits are triples of arrows  $f: A \rightarrow M \otimes X \otimes N$ ,  $g: M \otimes Y \otimes N \rightarrow M' \otimes X' \otimes N'$  and  $h: M' \otimes Y' \otimes N' \rightarrow B$ , quotiented by dinaturality of  $M, M', N, N'$ . Parallel splits are pairs of arrows  $f: A \rightarrow M \otimes X \otimes N \otimes X' \otimes O$  and  $g: M \otimes Y \otimes N \otimes Y' \otimes O \rightarrow B$ , quotiented by dinaturality of  $M, N, O$ . Units are simply arrows  $f: A \rightarrow B$ . In summary, we have

$$\begin{aligned} \text{morphisms,} & \quad f \ ; \ (\text{id} \otimes \blacksquare \otimes \text{id}) \ ; \ g \\ \text{sequential splits,} & \quad f \ ; \ (\text{id} \otimes \blacksquare \otimes \text{id}) \ ; \ g \ ; \ (\text{id} \otimes \blacksquare \otimes \text{id}) \ ; \ h; \\ \text{parallel splits,} & \quad f \ ; \ (\text{id} \otimes \blacksquare \otimes \text{id} \otimes \blacksquare \otimes \text{id}) \ ; \ g; \\ \text{sequential units,} & \quad f. \end{aligned}$$

Dinaturality for sequential splits and parallel splits is depicted the Appendix, Figures 30 and 31.

**Proposition 6.5.** *The category of monoidal contexts forms a normal produoidal category with its units, sequential and parallel splits.*

*Proof.* See Appendix, Proposition F.4.  $\square$

**Theorem 6.6.** *Monoidal contexts are the free normalization of the cofree produoidal category over a category. In other words, monoidal contexts are the normalization of spliced monoidal arrows,  $\mathcal{NFC} \cong \mathcal{MC}$ .*

*Proof.* See Appendix, Theorem F.12.  $\square$

Monoidal lenses are *symmetric* monoidal contexts. Again, the category of monoidal lenses has a rich algebraic structure; and again, most of this structure exists only virtually in terms of profunctors. In this case, though, the monoidal tensor *does* indeed exist: contrary to monoidal contexts, monoidal lenses form also a monoidal category.

This is perhaps why applications of monoidal lenses have grown popular in recent years [Ril18], with applications in decision theory [GHWZ18], supervised learning [CGG+22], [FJ19] and most notably in functional data accessing [Kme12], [PGW17], [BG18], [CEG+20]. The promonoidal structure of optics was ignored, even when, after now identifying for the first time its relation to the monoidal structure of optics, we argue that it could be potentially useful in these applications: e.g. in multi-stage decision problems, or in multi-stage data accessors.

This section explicitly constructs the normal symmetric produoidal category of *monoidal lenses*. We describe it for the first time by a universal property: it is the free symmetric normalization of the cofree produoidal category.

### 7.1 The Category of Monoidal Lenses

A monoidal lens of type  $\mathcal{LC}(A; X; Y)$  represents a process in a symmetric monoidal category with a hole admitting a process from  $X$  to  $Y$ .

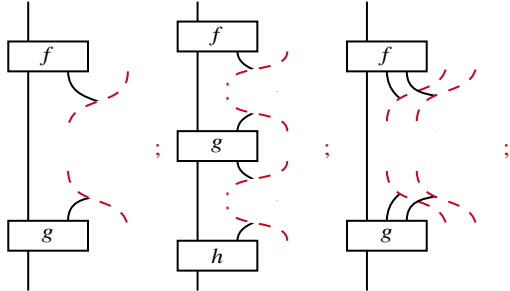

Fig. 15: Generic monoidal lens, sequential and parallel split.

**Definition 7.1** (Monoidal Lens). Let  $(\mathbb{C}, \otimes, I)$  be a symmetric monoidal category. *Monoidal lenses* are the elements of the following profunctor,

$$\mathcal{LC}(A; X; Y) = \mathbb{C}(A; \bullet \otimes X) \diamond \mathbb{C}(\bullet \otimes Y; B).$$

In other words, a *monoidal lens* from  $A$  to  $B$ , with a hole from  $X$  to  $Y$ , is an equivalence class consisting of a pair of objects  $M, N \in \mathbb{C}_{\text{obj}}$  and a pair of morphisms  $f \in \mathbb{C}(A; M \otimes X)$  and  $g \in \mathbb{C}(M \otimes Y; B)$ , quotiented by dinaturality of  $M$ . We write monoidal lenses as

$$f \circledast (\text{id}_M \otimes \blacksquare) \circledast g \in \mathcal{LC}(A; X; Y).$$

**Proposition 7.2.** *Monoidal lenses form a normal symmetric produoidal category with the following morphisms, units, sequential and parallel splits.*

$$\begin{aligned} \mathcal{LC}(A; X; Y) &= \mathbb{C}(A; \bullet \otimes X) \diamond \mathbb{C}(\bullet \otimes Y; B); \\ \mathcal{LC}(A; N) &= \mathbb{C}(A; B); \\ \mathcal{LC}(A; X; Y \triangleleft Y') &= \mathbb{C}(A; \bullet_1 \otimes X) \diamond \\ &\quad \mathbb{C}(\bullet_1 \otimes Y; \bullet_2 \otimes X') \diamond \mathbb{C}(\bullet_2 \otimes Y'; B); \\ \mathcal{LC}(A; X; Y \otimes Y') &= \mathbb{C}(A; \bullet_1 \otimes X \otimes X') \diamond \mathbb{C}(\bullet_1 \otimes Y \otimes Y'; B). \end{aligned}$$

*Proof.* See Appendix, Proposition G.1.  $\square$

**Theorem 7.3.** *Monoidal lenses are the free symmetric normalization of the cofree symmetric produoidal category over a monoidal category.*

*Proof.* See Appendix, Theorem G.9.  $\square$

*Remark 7.4* (Representable parallel structure). The parallel splitting structure of monoidal lenses is representable,

$$\mathcal{LC}(A; X; Y \otimes Y') = \mathcal{LC}(A; X; Y \otimes Y').$$

Lenses over a symmetric monoidal category are known to be monoidal [Ril18], [Hed17], but it remained unexplained why a similar structure was not present in non-symmetric lenses. The contradiction can be solved by noting that both symmetric and non-symmetric lenses are indeed *promonoidal*, even if only symmetric optics provide a representable tensor.

*Remark 7.5* (Session notation for lenses). We will write  $!A = \binom{A}{\bullet}$  and  $?B = \binom{\bullet}{B}$  for the objects of the produoidal category of lenses that have a monoidal unit as one of its objects. These are enough to express all objects because  $!A \otimes ?B = \binom{A}{B}$ ; and, moreover, they satisfy the following properties definitionally.

$$\begin{aligned} \mathbb{C}(\bullet; ?A \triangleleft ?B) &\cong \mathbb{C}(\bullet; ?A \otimes ?B); & !(A \otimes B) &= !A \otimes !B; \\ \mathbb{C}(\bullet; !A \triangleleft !B) &\cong \mathbb{C}(\bullet; !A \otimes !B); & ?(A \otimes B) &= ?A \otimes ?B; \\ \mathbb{C}(\bullet; !A \triangleleft ?B) &\cong \mathbb{C}(\bullet; !A \otimes ?B). \end{aligned}$$

**Proposition 7.6.** *Let  $(\mathbb{C}, \otimes, I)$  be a symmetric monoidal category. There exist monoidal functors  $(!): \mathbb{C} \rightarrow \mathcal{LC}$  and  $(?): \mathbb{C}^{op} \rightarrow \mathcal{LC}$ .*

*Proof.* See Appendix, Proposition G.7.  $\square$

### 7.2 Protocol Analysis

Let us go back to our running example (Figure 1). We can now declare that the client and server have the following types, representing the order in which they communicate,

$$\begin{aligned} \text{Client} &\in \mathcal{LC} \left( \text{Client}; !\text{Msg} \triangleleft ?\text{Msg} \triangleleft !\text{Msg} \right); \\ \text{Server} &\in \mathcal{LC} \left( \text{Server}; ?\text{Msg} \triangleleft !\text{Msg} \triangleleft ?\text{Msg} \right). \end{aligned}$$

Moreover, we can use the duoidal algebra to compose them. Indeed, tensoring client and server, we get the following codomain type,

$$(!\text{Msg} \triangleleft ?\text{Msg} \triangleleft !\text{Msg}) \otimes (? \text{Msg} \triangleleft !\text{Msg} \triangleleft ? \text{Msg}).$$

We then apply the laxators to mix inputs and outputs, obtaining

$$(!\text{Msg} \otimes ?\text{Msg}) \triangleleft (?\text{Msg} \otimes !\text{Msg}) \triangleleft (!\text{Msg} \otimes ?\text{Msg}),$$

and we finally apply the unitors to fill the communication holes with noisy channels.

$$\psi_2 \left( \begin{array}{c} \text{!} \\ \text{?} \end{array} \otimes \begin{array}{c} \text{?} \\ \text{!} \end{array} \right) \triangleleft_{\lambda}^3 \text{NOISE}^3 \in \mathcal{LC} \left( \begin{array}{c} \text{Client} \otimes \text{Server} \\ \text{Client} \otimes \text{Server} \end{array} \right).$$

We end up obtaining the protocol as a single morphism  $\text{Client} \otimes \text{Server} \rightarrow \text{Client} \otimes \text{Server}$  in whatever category we are using to program. Assuming the category of finite stochastic maps, this single morphism represents the distribution over the possible outcomes of the protocol. Finally, by *dinaturality*, we can reason over independent parts of the protocol.

**Proposition 7.7.** *Let  $(\begin{array}{c} \text{!} \\ \text{?} \end{array}) = (\text{SYN}; (\text{id} \otimes \blacksquare); \text{ACK}; (\text{id} \otimes \blacksquare))$ . The equalities in Figure 1 are a consequence of the *dinaturality* of a monoidal lens.*

*Proof.* We recognize the diagram in Figure 1 as representing the elements in the following equation.

$$\begin{aligned} \text{SYN}; (\text{id} \otimes \blacksquare); \text{ACK}; (\text{id} \otimes \blacksquare) &= \\ \text{SYN}^*; (\text{PRJ} \otimes \text{id}); \blacksquare; \text{ACK}; (\text{id} \otimes \blacksquare) &= \\ \text{SYN}^*; (\text{id} \otimes \blacksquare); (\text{PRJ} \otimes \text{id}); \text{ACK}; (\text{id} \otimes \blacksquare) &= \\ \text{SYN}^*; (\text{id} \otimes \blacksquare); \text{ACK}^*; (\text{id} \otimes \blacksquare). & \end{aligned}$$

In the same way we would apply the *interchange law* in completed morphisms, we have applied *dinaturality* over PRJ.  $\square$

### 7.3 Cartesian Lenses

We have worked in full generality, but cartesian lenses are particularly important to applications in game theory [GHWZ18] and functional programming [Kme12], [PGW17]. We introduce their newly constructed produoidal structure.

**Proposition 7.8** (Cartesian Lenses). *Let  $(\mathbb{C}, \cdot, 1)$  be a cartesian monoidal category. Its produoidal category of lenses is given by the following profunctors.*

$$\begin{aligned} \mathcal{LC} \left( \begin{array}{c} A \\ B \end{array}; \begin{array}{c} X \\ Y \end{array} \right) &\cong \mathbb{C}(A; X) \times \mathbb{C}(AY; B), \\ \mathcal{LC} \left( \begin{array}{c} A \\ B \end{array}; \begin{array}{c} X \\ Y \end{array} \triangleleft \begin{array}{c} X' \\ Y' \end{array} \right) &\cong \mathbb{C}(A; X) \times \mathbb{C}(AY; X') \times \mathbb{C}(AYY'; B), \\ \mathcal{LC} \left( \begin{array}{c} A \\ B \end{array}; \begin{array}{c} X \\ Y \end{array} \otimes \begin{array}{c} X' \\ Y' \end{array} \right) &\cong \mathbb{C}(A; XX') \times \mathbb{C}(AYY'; B), \\ \mathcal{LC} \left( \begin{array}{c} A \\ B \end{array} \right) &\cong \mathbb{C}(A; B). \end{aligned}$$

*Proof.* See Appendix, Proposition G.8.  $\square$

## 8 CONCLUSIONS

Monoidal contexts are an algebra of incomplete processes, commonly generalizing lenses [Ril18] and spliced arrows [MZ22]. In the same way that the  $\pi$ -calculus allows input/output channels of an abstract model of computation, monoidal contexts allow input/output communication on arbitrary theories of processes, such as stochastic or partial functions, quantum processes or relational queries.

Monoidal contexts form a normal produoidal category: a highly structured and rich categorical algebra. Moreover, they are the universal such algebra on a monoidal category. This

is good news for applications: the literature on concurrency is rich in frameworks; but the lack of *canonicity* may get us confused when trying to choose, design, or compare among them, as Abramsky [Abr05] has pointed out. Precisely characterizing the universal property of a model addresses this concern. This is also good news for the category theorist: not only is this an example shedding light on a relatively obscure structure; it is a paradigmatic such one.

We rely on two mathematical ideas: *monoidal* and *duoidal* categories on one hand, and *dinaturality* and *profunctorial* structures on the other. *Monoidal categories*, which could be accidentally dismissed as a toy version of cartesian categories, show that their string diagrams can bootstrap our conceptual understanding of new fundamental process structures, while keeping an abstraction over their implementation that cartesian categories cannot afford. Duoidal categories are such an example: starting to appear insistently in computer science [SS22], [HS23], they capture the posetal structure of process dependency and communication. *Dinaturality*, virtual structures and profunctors, even if sometimes judged arcane, show again that they can canonically capture a notion as concrete as process composition.

### 8.1 Further Work

**Dependencies.** Shapiro and Spivak [SS22] prove that normal symmetric duoidal categories with certain limits additionally have the structure of *dependence categories*: they can not only express dependence structures generated by  $(\triangleleft)$  and  $(\otimes)$ , but arbitrary poset-mediated dependence structures. Produoidal categories are better behaved: the limits always exist, and we only require these are preserved by the coend.

**Proposition 8.1.** *Let  $\mathbb{V}$  be a normal and  $\otimes$ -symmetric produoidal category with coends over  $\mathbb{V}$  commuting with finite connected limits. Then,  $[\mathbb{V}^{\text{op}}, \mathbf{Set}]$  is a dependence category in the sense of Shapiro and Spivak [SS22].*

*Proof sketch.* See Appendix, Theorem H.1.  $\square$

Weakening dependence categories in this way combines the ideas of Shapiro and Spivak [SS22] with those of Hefford and Kissinger [HK22], who employ virtual objects to deal with the non-existence of tensor products in models of spacetime.

**Language theory.** Melliès and Zeilberger [MZ22] used a multicategorical form of splice-contour adjunction (Remark 3.3) to give a novel proof of the Chomsky-Schützenberger representation theorem, generalized to context-free languages in categories. Our produoidal splice-contour adjunction (Section 4), combined with recent work on languages of morphisms in monoidal categories [ES22] opens the way for a vertical categorification of the Chomsky-Schützenberger theorem, which we plan to elaborate in future work.

**String diagrams for concurrency.** Nester et al. [Nes23], [BNR22] have recently introduced an alternative description of lenses in terms of *proarrow equipments*, which have a good 2-dimensional syntax [Mye16] we can use for send/receive types  $(!/?)$ . We have shown how this structure arises universally in

symmetric monoidal categories. It remains as further work to determine a good 2-dimensional syntax for concurrent programs with *iteration* and *internal/external choice*.

## 9 ACKNOWLEDGEMENTS

We thank Pawel Sobocinski, Fosco Loregian, Chad Nester and David Spivak for discussion.

Matt Earnshaw and Mario Román were supported by the European Social Fund Estonian IT Academy research measure (project 2014-2020.4.05.19-0001). James Hefford is supported by University College London and the EPSRC [grant number EP/L015242/1].

## REFERENCES

- [Abr05] Samson Abramsky. What are the fundamental structures of concurrency?: We still don't know! In Luca Aceto and Andrew D. Gordon, editors, *Proceedings of the Workshop "Essays on Algebraic Process Calculi", APC 25, Bertinoro, Italy, August 1-5, 2005*, volume 162 of *Electronic Notes in Theoretical Computer Science*, pages 37–41. Elsevier, 2005.
- [AC09] Samson Abramsky and Bob Coecke. Categorical quantum mechanics. In Kurt Engesser, Dov M. Gabbay, and Daniel Lehmann, editors, *Handbook of Quantum Logic and Quantum Structures*, pages 261–323. Elsevier, Amsterdam, 2009.
- [AHLF18] Marcelo Aguiar, Mariana Haim, and Ignacio López Franco. Monads on higher monoidal categories. *Applied Categorical Structures*, 26(3):413–458, Jun 2018.
- [AM10] Marcelo Aguiar and Swapneel Arvind Mahajan. *Monoidal functors, species and Hopf algebras*, volume 29. American Mathematical Society Providence, RI, 2010.
- [BDSPV15] Bruce Bartlett, Christopher L. Douglas, Christopher J. Schommer-Pries, and Jamie Vicary. Modular categories as representations of the 3-dimensional bordism 2-category, 2015.
- [Bén00] Jean Bénabou. Distributors at work. *Lecture notes written by Thomas Streicher*, 11, 2000.
- [BG18] Guillaume Boisseau and Jeremy Gibbons. What you needa know about yoneda: Profunctor optics and the yoneda lemma (functional pearl). *Proceedings of the ACM on Programming Languages*, 2(ICFP):1–27, 2018.
- [BNR22] Guillaume Boisseau, Chad Nester, and Mario Román. Cornering optics. volume abs/2205.00842, 2022.
- [BPSZ19] Filippo Bonchi, Robin Piedeleu, Pawel Sobocinski, and Fabio Zanasi. Graphical affine algebra. In *34th Annual ACM/IEEE Symposium on Logic in Computer Science, LICS 2019, Vancouver, BC, Canada, June 24-27, 2019*, pages 1–12. IEEE, 2019.
- [BS13] Thomas Booker and Ross Street. Tannaka duality and convolution for duoidal categories. *Theory and Applications of Categories*, 28(6):166–205, 2013.
- [BSS18] Filippo Bonchi, Jens Seeber, and Pawel Sobocinski. Graphical conjunctive queries. In Dan R. Ghica and Achim Jung, editors, *27th EACSL Annual Conference on Computer Science Logic, CSL 2018, September 4-7, 2018, Birmingham, UK*, volume 119 of *LIPICs*, pages 13:1–13:23. Schloss Dagstuhl - Leibniz-Zentrum für Informatik, 2018.
- [CEG<sup>+</sup>20] Bryce Clarke, Derek Elkins, Jeremy Gibbons, Fosco Loregian, Bartosz Milewski, Emily Pillmore, and Mario Román. Profunctor optics, a categorical update. *CoRR*, abs/2001.07488, 2020.
- [CFS16] Bob Coecke, Tobias Fritz, and Robert W. Spekkens. A mathematical theory of resources. *Inf. Comput.*, 250:59–86, 2016.
- [CGG<sup>+</sup>22] Geoffrey S. H. Cruttwell, Bruno Gavranović, Neil Ghani, Paul Wilson, and Fabio Zanasi. Categorical foundations of gradient-based learning. In *European Symposium on Programming*, pages 1–28. Springer, Cham, 2022.
- [CJ19] Kenta Cho and Bart Jacobs. Disintegration and Bayesian Inversion via String Diagrams. *Mathematical Structures in Computer Science*, pages 1–34, March 2019.
- [CL02] J. Robin B. Cockett and Stephen Lack. Restriction categories I: categories of partial maps. *Theoretical Computer Science*, 270(1-2):223–259, 2002.
- [CP09] J. Robin B. Cockett and Craig A. Pastro. The logic of message-passing. *Sci. Comput. Program.*, 74(8):498–533, 2009.
- [CS97] J. Robin B. Cockett and Robert A. G. Seely. Weakly distributive categories. *Journal of Pure and Applied Algebra*, 114(2):133–173, 1997.
- [CS10] G.S.H. Cruttwell and Michael A. Shulman. A unified framework for generalized multicategories. *Theory and Applications of Categories*, 24:580–655, 2010.
- [Day70a] Brian Day. *Construction of Biclosed Categories*. PhD thesis, University of New South Wales, 1970.
- [Day70b] Brian Day. On closed categories of functors. In *Reports of the Midwest Category Seminar IV*, volume 137, pages 1–38, Berlin, Heidelberg, 1970. Springer Berlin Heidelberg.
- [DLdFR22] Elena Di Lavore, Giovanni de Felice, and Mario Román. Monoidal streams for dataflow programming. In *Proceedings of the 37th Annual ACM/IEEE Symposium on Logic in Computer Science, LICS '22, New York, NY, USA, 2022*. Association for Computing Machinery.
- [ES22] Matthew Earnshaw and Pawel Sobociński. Regular Monoidal Languages. In Stefan Szeider, Robert Ganian, and Alexandra Silva, editors, *47th International Symposium on Mathematical Foundations of Computer Science (MFCS 2022)*, volume 241 of *Leibniz International Proceedings in Informatics (LIPIcs)*, pages 44:1–44:14, Dagstuhl, Germany, 2022. Schloss Dagstuhl – Leibniz-Zentrum für Informatik.
- [FGM<sup>+</sup>07] J. Nathan Foster, Michael B. Greenwald, Jonathan T. Moore, Benjamin C. Pierce, and Alan Schmitt. Combinators for bidirectional tree transformations: A linguistic approach to the view-update problem. *ACM Transactions on Programming Languages and Systems (TOPLAS)*, 29(3):17–es, 2007.
- [FJ19] Brendan Fong and Michael Johnson. Lenses and learners. *arXiv preprint arXiv:1903.03671*, 2019.
- [Fri20] Tobias Fritz. A synthetic approach to Markov kernels, conditional independence and theorems on sufficient statistics. *Advances in Mathematics*, 370:107239, 2020.
- [GF16] Richard Garner and Ignacio López Franco. Commutativity. *Journal of Pure and Applied Algebra*, 220(5):1707–1751, 2016.
- [GH99] Simon J. Gay and Malcolm Hole. Types and subtypes for client-server interactions. In S. Doaitse Swierstra, editor, *Programming Languages and Systems, 8th European Symposium on Programming, ESOP'99, Held as Part of the European Joint Conferences on the Theory and Practice of Software, ETAPS'99, Amsterdam, The Netherlands, 22-28 March, 1999, Proceedings*, volume 1576 of *Lecture Notes in Computer Science*, pages 74–90. Springer, 1999.
- [GHWZ18] Neil Ghani, Jules Hedges, Viktor Winschel, and Philipp Zahn. Compositional game theory. In Anuj Dawar and Erich Grädel, editors, *Proceedings of the 33rd Annual ACM/IEEE Symposium on Logic in Computer Science, LICS 2018, Oxford, UK, July 09-12, 2018*, pages 472–481. ACM, 2018.
- [Gui80] René Guitart. Tenseurs et machines. *Cahiers de topologie et géométrie différentielle catégoriques*, 21(1):5–62, 1980.
- [Has97] Masahito Hasegawa. *Models of sharing graphs: a categorical semantics of let and letrec*. PhD thesis, University of Edinburgh, UK, 1997.
- [HC22] James Hefford and Cole Comfort. Coend optics for quantum combs. *arXiv preprint arXiv:2205.09027*, 2022.
- [Hed17] Jules Hedges. Coherence for lenses and open games. *arXiv preprint arXiv:1704.02230*, 2017.
- [HK22] James Hefford and Aleks Kissinger. On the pre- and promonoidal structure of spacetime. *arXiv preprint arXiv:2206.09678*, 2022.
- [HLV<sup>+</sup>16] Hans Hüttel, Ivan Lanese, Vasco T. Vasconcelos, Luís Caires, Marco Carbone, Pierre-Malo Deniérou, Dimitris Mostros, Luca Padovani, António Ravara, Emilio Tuosto, Hugo Torres Vieira, and Gianluigi Zavattaro. Foundations of session types and behavioural contracts. *ACM Comput. Surv.*, 49(1):3:1–3:36, 2016.
- [Hon93] Kohei Honda. Types for dyadic interaction. In Eike Best, editor, *CONCUR '93, 4th International Conference on Concurrency Theory, Hildesheim, Germany, August 23-26, 1993, Proceedings*, volume 715 of *Lecture Notes in Computer Science*, pages 509–523. Springer, 1993.

- [HS23] Chris Heunen and Jesse Sigal. Duoidally enriched Freyd categories. *arXiv preprint arXiv:2301.05162*, 2023.
- [Hug00] John Hughes. Generalising monads to arrows. *Science of Computer Programming*, 37(1-3):67–111, 2000.
- [HYC08] Kohei Honda, Nobuko Yoshida, and Marco Carbone. Multi-party asynchronous session types. In George C. Necula and Philip Wadler, editors, *Proceedings of the 35th ACM SIGPLAN-SIGACT Symposium on Principles of Programming Languages, POPL 2008, San Francisco, California, USA, January 7-12, 2008*, pages 273–284. ACM, 2008.
- [JRW12] Michael Johnson, Robert Rosebrugh, and Richard J. Wood. Lenses, fibrations and universal translations. *Mathematical structures in computer science*, 22(1):25–42, 2012.
- [JS91] André Joyal and Ross Street. The geometry of tensor calculus, I. *Advances in Mathematics*, 88(1):55–112, 1991.
- [Kme12] Edward Kmett. lens library, version 4.16. *Hackage* <https://hackage.haskell.org/package/lens-4.16>, 2018, 2012.
- [KPT96] Naoki Kobayashi, Benjamin C. Pierce, and David N. Turner. Linearity and the pi-calculus. In Hans-Juergen Boehm and Guy L. Steele Jr., editors, *Conference Record of POPL'96: The 23rd ACM SIGPLAN-SIGACT Symposium on Principles of Programming Languages, Papers Presented at the Symposium, St. Petersburg Beach, Florida, USA, January 21-24, 1996*, pages 358–371. ACM Press, 1996.
- [KU17] Aleks Kissinger and Sander Uijlen. A categorical semantics for causal structure. In *32nd Annual ACM/IEEE Symposium on Logic in Computer Science, LICS 2017, Reykjavik, Iceland, June 20-23, 2017*, pages 1–12. IEEE Computer Society, 2017.
- [Lor21] Fosco Loregian. *(Co)end Calculus*. London Mathematical Society Lecture Note Series. Cambridge University Press, 2021.
- [Mac78] Saunders Mac Lane. *Categories for the Working Mathematician*. Graduate Texts in Mathematics. Springer New York, 1978.
- [Mog91] Eugenio Moggi. Notions of computation and monads. *Inf. Comput.*, 93(1):55–92, 1991.
- [Mye16] David Jaz Myers. String diagrams for double categories and equipments, 2016.
- [MZ22] Paul-André Melliès and Noam Zeilberger. Parsing as a Lifting Problem and the Chomsky-Schützenberger Representation Theorem. In *MFPS 2022-38th conference on Mathematical Foundations for Programming Semantics*, 2022.
- [Nes23] Chad Nester. Concurrent Process Histories and Resource Transducers. *Logical Methods in Computer Science*, Volume 19, Issue 1, January 2023.
- [NS22] Nelson Niu and David I. Spivak. Polynomial functors: A general theory of interaction. *In preparation*, 2022.
- [Pat01] Ross Paterson. A new notation for arrows. In Benjamin C. Pierce, editor, *Proceedings of the Sixth ACM SIGPLAN International Conference on Functional Programming (ICFP '01), Firenze (Florence), Italy, September 3-5, 2001*, pages 229–240. ACM, 2001.
- [PGW17] Matthew Pickering, Jeremy Gibbons, and Nicolas Wu. Profunctor optics: Modular data accessors. *Art Sci. Eng. Program.*, 1(2):7, 2017.
- [Pos81] J. Postel. Transmission control protocol. RFC 793, RFC Editor, 9 1981.
- [PS93] Benjamin C. Pierce and Davide Sangiorgi. Typing and subtyping for mobile processes. In *Proceedings of the Eighth Annual Symposium on Logic in Computer Science (LICS '93), Montreal, Canada, June 19-23, 1993*, pages 376–385. IEEE Computer Society, 1993.
- [PS07] Craig Pastro and Ross Street. Doubles for Monoidal Categories. *arXiv preprint arXiv:0711.1859*, 2007.
- [PSV21] Evan Patterson, David I. Spivak, and Dmitry Vagner. Wiring diagrams as normal forms for computing in symmetric monoidal categories. *Electronic Proceedings in Theoretical Computer Science*, page 49–64, Feb 2021.
- [Ril18] Mitchell Riley. Categories of Optics. *arXiv preprint arXiv:1809.00738*, 2018.
- [Rom20] Mario Román. Comb Diagrams for Discrete-Time Feedback. *CoRR*, abs/2003.06214, 2020.
- [Rom21] Mario Román. Open diagrams via coend calculus. *Electronic Proceedings in Theoretical Computer Science*, 333:65–78, Feb 2021.
- [Rom22] Mario Román. Promonads and string diagrams for effectful categories. In *ACT '22: Applied Category Theory, Glasgow, United Kingdom, 18 - 22 July, 2022*, volume abs/2205.07664, 2022.
- [Shu16] Michael Shulman. Categorical logic from a categorical point of view. *Available on the web*, 2016.
- [Shu17] Michael Shulman. Duoidal category (nlab entry), section 2., 2017. <https://ncatlab.org/nlab/show/duoidal+category>, Last accessed on 2022-12-14.
- [Spi13] David I. Spivak. The operad of wiring diagrams: formalizing a graphical language for databases, recursion, and plug-and-play circuits. *CoRR*, abs/1305.0297, 2013.
- [SS22] Brandon T. Shapiro and David I. Spivak. Duoidal structures for compositional dependence. *arXiv preprint arXiv:2210.01962*, 2022.
- [SSV20] Patrick Schultz, David I. Spivak, and Christina Vasilakopoulou. Dynamical systems and sheaves. *Applied Categorical Structures*, 28(1):1–57, 2020.
- [SW01] Davide Sangiorgi and David Walker. *The Pi-Calculus - a theory of mobile processes*. Cambridge University Press, 2001.
- [VC22] André Videla and Matteo Capucci. Lenses for composable servers. *CoRR*, abs/2203.15633, 2022.

APPENDIX A  
INTRODUCTION

*A.1 Three Way handshake Implementation*

The following can be interpreted as pseudocode using the linear type theory of symmetric monoidal categories [Shu16]. The type theory of symmetric monoidal categories (Section A.1) uses declarations such as  $(x, y) \leftarrow f(a, b, c)$  to represent morphisms such as  $f: A \otimes B \otimes C \rightarrow X \otimes Y$ .

$$\begin{array}{c}
 \text{GEN} \\
 \frac{f \in \mathcal{G}(A_1, \dots, A_n; B) \quad \Gamma_1 \vdash x_1 : A_1 \dots \Gamma_n \vdash x_n : A_n}{\text{Shuf}(\Gamma_1, \dots, \Gamma_n) \vdash f(x_1, \dots, x_n) : B} \\
 \\
 \begin{array}{cc}
 \text{PAIR} & \text{VAR} \\
 \frac{\Gamma_1 \vdash x_1 : A_1 \dots \Gamma_n \vdash x_n : A_n}{\text{Shuf}(\Gamma_1, \dots, \Gamma_n) \vdash [x_1, \dots, x_n] : A_1 \otimes \dots \otimes A_n} & \frac{}{x : A \vdash x : A}
 \end{array} \\
 \\
 \text{SPLIT} \\
 \frac{\Delta \vdash m : A_1 \otimes \dots \otimes A_n \quad \Gamma, x_1 : A_1, \dots, x_n : A_n \vdash z : C}{\text{Shuf}(\Gamma, \Delta) \vdash [x_1, \dots, x_n] \leftarrow m ; z : C}
 \end{array}$$

Fig. 16: Type theory of symmetric monoidal categories [Shu16].

We can interpret pseudocode as talking about the type theory of monoidal categories. Usually, we will need some extra structure: such as `if-then-else` or explicit functions. It has been found in programming that a good level of concreteness for monoidal categories is given by the Kleisli categories of commutative monads, sometimes abstracted by Freyd categories [Mog91], [Hug00], see [Rom22] for a comparison with plain monoidal categories and string diagrams. For convenience, we assume this setting in the following code, but note that it is not strictly necessary, and that a type-theoretic implementation of monoidal categories would work just the same.

The following code inspired by Haskell's `do`-notation [Hug00] and it has been tested in the Glasgow Haskell Compiler, version 9.2.5.

```

syn :: Client ~> (Client, Syn, Ack)
syn(client) = do
  client <- random
  return (client, client, 0)

synack :: (Syn, Ack, Server) ~> (Syn, Ack, Server)
synack(syn, ack, server) = do
  server <- random
  return (if syn == 0 then (0,0,0) else (server, ack+1, server))

noise :: Noise -> (Syn, Ack) ~> (Syn, Ack)
noise k (syn,ack) = do
  noise <- binomial k
  return (if noise then (0,0) else (syn,ack))

ack :: (Client, Syn, Ack) ~> (Client, Syn, Ack)
ack(client, syn, ack) = do
  return (if client+1 /= ack then (0,0,0) else (client+1, syn+1, client))

```

```

receive :: (Syn, Ack, Server) ~> Server
receive(syn, ack, server) = do
  return (if server+1 /= ack then 0 else server)

```

We can use the *produoidal category of lenses* to provide a modular description of this protocol.

The programmer will not need to know about produoidal categories: they will be able to define *splits* of a process; they will be able to read the type of the *split* in terms of the send-receive steps of the protocol; they will be able to combine them, and the typechecker should produce an error whenever *dinaturality* is not respected. In fact, in the following code, naively combining client and server in a way that does not preserve *dinaturality* will produce a type error because GHC will not be able to match the types. We present the description of the protocol, encoding send/receive types.

```

protocol ::
  Split (Kleisli Distribution) Client Client
  (Syn, Ack) -- !
  (Syn, Ack) -- ?
  (Syn, Ack) -- !
  () -- ?
-> Split (Kleisli Distribution) Server Server
  () -- !
  (Syn, Ack) -- ?
  (Syn, Ack) -- !
  (Syn, Ack) -- ?
-> (Client, Server) ~> (Client, Server)
protocol
  (Split (Kleisli client1) (Kleisli client2) (Kleisli client3))
  (Split (Kleisli server1) (Kleisli server2) (Kleisli server3))
  (client , server) = do
    (server, ()) <- server1(server)
    (client, (s,a)) <- client1(client)
    (s, a) <- noise 0.1 (s,a)
    (server, (s,a)) <- server2(server, (s,a))
    (s, a) <- noise 0.1 (s,a)
    (client, (s,a)) <- client2(client, (s,a))
    (s, a) <- noise 0.1 (s,a)
    (server) <- server3(server, (s,a))
    (client) <- client3(client, ())
    return (client, server)

```

The following Figure 17 and Figure 18 show the separate Haskell code for the client and server modules.



```

client :: Split (Kleisli Distribution) Client Client
(Syn, Ack) -- !
(Syn, Ack) -- ?
(Syn, Ack) -- !
()         -- ?
client = Split {

  -- Part 1: Send a SYN message.
  part1 = Kleisli $ \client -> do
    client <- pure 10
    return (client, (client, 0))

  -- Part 2: Receive ACK, send ACK.
  , part2 = Kleisli $ \(client, (syn, ack)) -> do
    return (if client+1 /= syn then (0,(0,0)) else (client, (client+1, ack+1)))

  -- Part 3: Close protocol.
  , part3 = Kleisli $ \(client, ()) -> do
    return client

}

```

Fig. 17: Haskell code for the client module.

```

server :: Split (Kleisli Distribution) Server Server
()      -- send    ==>
(Syn, Ack) -- receive <==
(Syn, Ack) -- send    ==>
(Syn, Ack) -- receive <==
server = Split

  -- Part 1: Open protocol.
  { part1 = Kleisli $ \server -> do
    return (server, ())

  -- Part 2: Receive SYN and send ACK.
  , part2 = Kleisli $ \(server, (syn, ack)) -> do
    server <- pure 20
    return (if syn == 0 then (0,(0,0)) else (server, (syn+1, server)))

  -- Part 3: Receive ACK.
  , part3 = Kleisli $ \(server, (syn, ack)) -> do
    return (if server+1 /= ack then 0 else server)

}

```

Fig. 18: Code for the server module.

```

data Split c a b x y s t where
  Split :: { part1 :: c a      (m , x)
           , part2 :: c (m , y) (n , s)
           , part3 :: c (n , t) b
           } -> Split c a b x y s t

data Unit c a b where
  Unit :: { unit :: c a b } -> Unit c a b

data Context c a b x y where
  Context :: { partA :: c a (m , x)
            , partB :: c (m , y) (m , b)
            } -> Context c a b x y

type (a ~> b) = (a -> Distribution b)

```

Fig. 19: Code describing the profunctors of monoidal lenses.

APPENDIX B  
PROFUNCTORS AND VIRTUAL STRUCTURES

**Definition B.1.** A *profunctor*  $(P, <, >)$  between two categories  $\mathbb{A}$  and  $\mathbb{B}$ , written  $P(\bullet; \bullet): \mathbb{A} \circ\!\!\!\rightarrow \mathbb{B}$ , is a family of sets  $P(B; A)$  indexed by objects  $A$  and  $B$ , and endowed with jointly functorial left and right actions of the morphisms of  $\mathbb{A}$  and  $\mathbb{B}$ , respectively [Bén00], [Lor21].

Explicitly, the types of these actions are  $(>): \mathbb{B}(B', B) \times P(B, A) \rightarrow P(B', A)$ , and  $(<): P(B, A) \times \mathbb{A}(A, A') \rightarrow P(B, A')$ . These must

- satisfy compatibility,  $(f > p) < g = f > (p < g)$ ,
- preserve identities,  $id > p = p$ , and  $p < id = p$ ,
- and preserve compositions,  $(p < f) < g = p < (f \circ g)$  and  $f > (g > p) = (f \circ g) > p$ .

*Remark B.2.* More succinctly, a profunctor  $P: \mathbb{A} \circ\!\!\!\rightarrow \mathbb{B}$  is a functor  $P: \mathbb{B}^{\text{op}} \times \mathbb{A} \rightarrow \mathbf{Set}$ . Analogously, a profunctor  $P: \mathbb{A} \circ\!\!\!\rightarrow \mathbb{B}$  is a functor  $P: \mathbb{A}^{\text{op}} \times \mathbb{B} \rightarrow \mathbf{Set}$ , or a profunctor  $P: \mathbb{B} \circ\!\!\!\rightarrow \mathbb{A}$ .<sup>3</sup> When presented as a family of sets with a pair of actions, profunctors are sometimes called bimodules.

**Theorem B.3** (Yoneda isomorphisms). *Let  $\mathbb{C}$  be a category. There exist bijections between the following sets defined by coends. These are natural in the copresheaf  $F: \mathbb{C} \rightarrow \mathbf{Set}$ , the presheaf  $G: \mathbb{C}^{\text{op}} \rightarrow \mathbf{Set}$  and  $A \in \mathbb{C}$ ,*

$$\int^X \mathbb{C}(X; A) \times F(X) \cong F(A); \quad \int^X \mathbb{C}(A; X) \times G(X) \cong G(A);$$

and they are defined by  $y_1(f \mid \alpha) = F(f)(\alpha)$  and  $y_2(g \mid \beta) = G(g)(\beta)$ . These are called Yoneda reductions or Yoneda isomorphisms, because they appear in the proof of Yoneda lemma. Moreover, any formal diagram constructed out of these reductions, products, identities and compositions commutes.

### B.1 Promonads

**Definition B.4.** A *promonad*  $(P, \star, \circ)$  over a category  $\mathbb{C}$  is a profunctor  $P: \mathbb{C} \circ\!\!\!\rightarrow \mathbb{C}$  together with two natural transformations representing inclusion  $(\circ): \mathbb{C}(X; Y) \rightarrow P(X; Y)$  and multiplication  $(\star): P(X; Y) \times P(Y; Z) \rightarrow P(X; Z)$ , and such that

- the left action is premultiplication,  $f \circ \star p = f > p$ ,
- the right action is postmultiplication,  $p \star f \circ = p < f$ ,
- multiplication is dinatural,  $p \star (f > q) = (p < f) \star q$ ,
- and multiplication is associative,  $(p_1 \star p_2) \star p_3 = p_1 \star (p_2 \star p_3)$ .

Equivalently, promonads are monoids in the category of endoprofunctors. Every promonad induces a category, its *Kleisli* category, with the same objects as the original  $\mathbb{C}$ , but with hom-sets given by the promonad,  $P(\bullet; \bullet)$ . [Rom22]

### B.2 Multicategories

**Multicategories.** We can explain *promonoidal* categories in terms of their better-known relatives: *multicategories*. Multicategories can be used to describe (non-necessarily-coherent) decomposition. They contain *multimorphisms*,  $X \rightarrow Y_0, \dots, Y_n$  that represent a way of decomposing an object  $X$  into a list of objects  $Y_0, \dots, Y_n$ .

**Definition B.5** (Multicategory). A *multicategory* is a category  $\mathbb{C}$  endowed with a set of multimorphisms,  $\mathbb{C}(X; Y_0, \dots, Y_n)$  for each list of objects  $X_0, \dots, X_n, Y$  in  $\mathbb{C}_{\text{obj}}$ , and a composition Figure 20 operation

$$(\circ)_{Y_k}^{n,m}: \mathbb{C}(X; Y_0, \dots, Y_n) \times \mathbb{C}(Y_i; Z_0, \dots, Z_m) \rightarrow \mathbb{C}(Z; Y_0, \dots, X_0, \dots, X_m, \dots, Y_m).$$

Composition is unital, meaning  $id_{X_i} \circ f = f \circ id_Y$  for any  $f$  making the equation formally well-typed. Composition is also *associative*, meaning  $(h \circ g) \circ f = h \circ (g \circ f)$ ; and  $g \circ (h \circ f) = h \circ (g \circ f)$  holds whenever it is formally well-typed.

<sup>3</sup>Notation for profunctors conflicts in the literature. To side-step this problem, we use the symbols  $(\circ\!\!\!\rightarrow)$  and  $(\bullet\!\!\!\rightarrow)$ , where  $\circ$  marks the contravariant (op) argument. This idea we take from Mike Shulman.

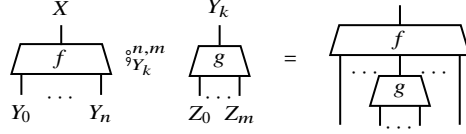

Fig. 20: Multicategorical composition.

**Proposition B.6.** *Multicategorical composition is dinatural on the object we are composing along. This is to say that composition,  $(\circlearrowleft)_k^{n,m}$ , induces a well-defined and dinatural composition operation on the coend the variable  $Y_k$  we are composing along.*

$$(\circlearrowleft)_k^{n,m} : \left( \int^{Y_k \in \mathbb{C}} \mathbb{C}(X; Y_0, \dots, Y_n) \times \mathbb{C}(Y_k; Z_0, \dots, Z_m) \right) \rightarrow \mathbb{C}(Z; Y_0, \dots, X_0, \dots, X_m, \dots, Y_m).$$

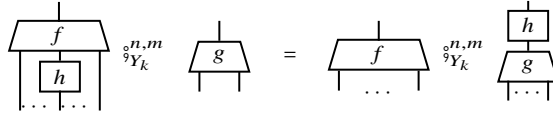

Fig. 21: Multicategorical composition is dinatural.

*Proof.* This is a direct consequence of the associativity of composition for multicategories, inducing an isomorphism.  $\square$

*Remark B.7.* A promonoidal category is a multicategory where *dinatural composition* is invertible.

**Duomulticategories** describe the interaction between two kinds of decomposition: a *sequential* one and a *parallel* one. We can mix this two ways of decomposing: for instance, we can decompose  $X$  sequentially and then decompose each one of its factors in parallel, finally decompose the last one of these sequentially again.

$$\mathbb{C}(X; (Y_0 \cdot Y_1), (Y_2 \cdot (Y_3, Y_4))).$$

**Definition B.8** (Duomulticategory). A *duomulticategory* is a category  $\mathbb{C}$  endowed with a set of multi-morphisms,  $\mathbb{C}(X; E(Y_0, \dots, Y_n))$ , for each list of objects  $Y_0, \dots, Y_n$  in  $\mathbb{C}_{\text{obj}}$  and each expression  $E$  on two monoids. Moreover, it is endowed with a dinatural composition operation

$$(\circlearrowleft)_{Y_k}^{n,m} : \int^{Y_i} \mathbb{C}(X; E_1[Y_0, \dots, Y_n]) \times \mathbb{C}(Y_i; E_2[Z_0, \dots, Z_m]) \longrightarrow \mathbb{C}(X; E_1[Y_0, \dots, E_2[X_0, \dots, X_m], \dots, Y_m]),$$

and laxators relating sequential and parallel composition,

$$\mathbb{C}(X; E_1[Y_0, \dots, ((Z_0, Z_1) \cdot (Z_2, Z_3)), \dots, Y_n]) \longrightarrow \mathbb{C}(X; E_1[Y_0, \dots, ((Z_0 \cdot Z_2), (Z_1 \cdot Z_3)), \dots, Y_n]).$$

*Remark B.9.* In the same sense that a promonoidal category is a category where dinatural composition is invertible in a specific sense, a *produoidal category* can be conjectured to be a duomulticategory where dinatural composition is invertible, inducing an isomorphism.

## APPENDIX C SEQUENTIAL CONTEXT

**Proposition C.1** (From Proposition 3.2). *Contour gives a functor  $C : \mathbf{Promon} \rightarrow \mathbf{Cat}$ .*

*Proof.* Definition 3.1 defines the action on promonoidal categories. We define the action on promonoidal functors. Given a promonoidal functor  $F : \mathbb{V} \rightarrow \mathbb{W}$ , define the functor  $CF : C\mathbb{V} \rightarrow C\mathbb{W}$  by the following morphism of presentations:

$$X^L \mapsto F(X)^L; X^R \mapsto F(X)^R$$

for each  $a \in \mathbb{V}(A; N)$ ,  $a_0 : A^L \rightarrow A^R \mapsto F_N(a)_0$

for each  $b \in \mathbb{V}(X; B)$ ,  $b_0 : B^L \rightarrow X^L \mapsto F(b)_0$ ;  $b_1 : X^R \rightarrow B^R \mapsto F(b)_1$

for each  $c \in \mathbb{V}(C; Y \triangleleft Z)$ ,  $c_0 : C^L \rightarrow Y^L \mapsto F_{\triangleleft}(c)_0$ ;  $c_1 : Y^R \rightarrow Z^L \mapsto F_{\triangleleft}(c)_1$ ;  $c_2 : Z^R \rightarrow C^R \mapsto F_{\triangleleft}(c)_2$ .

It follows from  $F : \mathbb{V} \rightarrow \mathbb{W}$  being a promonoidal functor that the contour equations of Definition 3.1 hold between the images of generators, so this defines a functor. In particular when  $\mathbf{Id}_{\mathbb{V}} : \mathbb{V} \rightarrow \mathbb{V}$  is an identity, it is an identity functor. Let  $G : \mathbb{U} \rightarrow \mathbb{V}$  be another promonoidal functor, then  $C(G \circ F) = C(G) \circ C(F)$  follows from the composition of promonoidal functors.  $\square$

**Proposition C.2** (From Proposition 3.5). *Spliced arrows form a promonoidal category with their sequential splits, units, and suitable coherence morphisms.*

*Proof.* In Lemma C.3, we construct the associator out of Yoneda isomorphisms. In Lemmas C.4 and C.5, we construct both unitors. As they are all constructed with Yoneda isomorphisms, they must satisfy the coherence equations.  $\square$

**Lemma C.3** (Promonoidal splice associator). *We can construct a natural isomorphism,*

$$\alpha : \int_{V \in \mathbb{S}\mathbb{C}}^U \mathbb{S}\mathbb{C} \left( \frac{A; X}{B; Y} \triangleleft \frac{U}{V} \right) \times \mathbb{S}\mathbb{C} \left( \frac{U; X'}{V; Y'} \triangleleft \frac{X''}{Y''} \right) \cong \int_{V \in \mathbb{S}\mathbb{C}}^U \mathbb{S}\mathbb{C} \left( \frac{A; U}{B; V} \triangleleft \frac{X''}{Y''} \right) \times \mathbb{S}\mathbb{C} \left( \frac{U; X}{V; Y} \triangleleft \frac{X'}{Y'} \right),$$

exclusively from Yoneda isomorphisms. This isomorphism is defined by stating that  $\alpha(\langle f_0 \circ f_1 \circ f_2 \rangle | \langle g_0 \circ g_1 \circ g_2 \rangle) = (\langle h_0 \circ h_1 \circ h_2 \rangle | \langle k_0 \circ k_1 \circ k_2 \rangle)$  if and only if

$$\langle f_0 \circ g_0 \circ g_1 \circ g_2 \circ f_1 \circ f_2 \rangle = \langle h_0 \circ h_1 \circ k_0 \circ k_1 \circ k_2 \circ h_2 \rangle.$$

*Proof.* We will show that both sides of the equation are isomorphic to  $\mathbb{C}(A; X) \times \mathbb{C}(Y; X') \times \mathbb{C}(Y'; X'') \times \mathbb{C}(X''; B)$ ; that is, the set of quadruples of morphisms  $\langle p_0 \circ p_1 \circ p_2 \circ p_3 \rangle$  where  $p_0 : A \rightarrow X$ ,  $p_1 : Y \rightarrow X'$ ,  $p_2 : Y' \rightarrow X''$  and  $p_3 : Y'' \rightarrow B$ .

Indeed, the following coend calculus computation constructs an isomorphism,

$$\begin{aligned} & \int_{V \in \mathbb{S}\mathbb{C}}^U \mathbb{S}\mathbb{C} \left( \frac{A; X}{B; Y} \triangleleft \frac{U}{V} \right) \times \mathbb{S}\mathbb{C} \left( \frac{U; X'}{V; Y'} \triangleleft \frac{X''}{Y''} \right) && = \text{(by definition)} \\ & \int_{V \in \mathbb{S}\mathbb{C}}^U \mathbb{C}(A; X) \times \mathbb{C}(Y; U) \times \mathbb{C}(V; B) \times \mathbb{C}(U; X') \times \mathbb{C}(Y'; X'') \times \mathbb{C}(Y''; V) && = \text{(by definition)} \\ & \int_{V \in \mathbb{S}\mathbb{C}}^U \mathbb{C}(A; X) \times \mathbb{S}\mathbb{C} \left( \frac{Y; U}{B; V} \right) \times \mathbb{C}(U; X') \times \mathbb{C}(Y'; X'') \times \mathbb{C}(Y''; V) && \cong \text{(by Yoneda reduction)} \end{aligned}$$

$$\mathbb{C}(A; X) \times \mathbb{C}(Y; X') \times \mathbb{C}(Y'; X'') \times \mathbb{C}(Y''; B),$$

that sends a pair  $\langle f_0 \circ f_1 \circ f_2 \rangle | \langle g_0 \circ g_1 \circ g_2 \rangle$ , quotiented by the equivalence relation generated by  $\langle f_0 \circ f_1 \circ n \circ m \circ f_2 \rangle | \langle g_0 \circ g_1 \circ g_2 \rangle = \langle f_0 \circ f_1 \circ f_2 \rangle | \langle n \circ g_0 \circ g_1 \circ m \circ g_2 \rangle$ , to the canonical form  $\langle f_0 \circ f_1 \circ g_0 \circ g_1 \circ g_2 \circ f_2 \rangle$ .

In the same way, the following coend calculus computation constructs the second isomorphism,

$$\begin{aligned} & \int_{V \in \mathbb{S}\mathbb{C}}^U \mathbb{S}\mathbb{C} \left( \frac{A; U}{B; V} \triangleleft \frac{X''}{Y''} \right) \times \mathbb{S}\mathbb{C} \left( \frac{U; X}{V; Y} \triangleleft \frac{X'}{Y'} \right) && \stackrel{\text{def}}{=} \\ & \int_{V \in \mathbb{S}\mathbb{C}}^U \mathbb{C}(A; U) \times \mathbb{C}(V; X'') \times \mathbb{C}(Y''; B) \times \mathbb{C}(U; X) \times \mathbb{C}(Y; X') \times \mathbb{C}(Y'; V) && \stackrel{\text{def}}{=} \\ & \int_{V \in \mathbb{S}\mathbb{C}}^U \mathbb{S}\mathbb{C} \left( \frac{A; U}{X''; V} \right) \times \mathbb{C}(Y''; B) \times \mathbb{C}(U; X) \times \mathbb{C}(Y; X') \times \mathbb{C}(Y'; V) && \stackrel{y_1}{=} \end{aligned}$$

$$\mathbb{C}(A; X) \times \mathbb{C}(Y; X') \times \mathbb{C}(Y'; X'') \times \mathbb{C}(Y''; B),$$

that sends a pair  $\langle h_0 \circledast h_1 \circledast h_2 \mid \langle k_0 \circledast k_1 \circledast k_2 \rangle \rangle$ , quotiented by the equivalence relation generated by  $\langle h_0 \circledast n \circledast m \circledast h_1 \circledast h_2 \mid \langle k_0 \circledast k_1 \circledast k_2 \rangle \rangle = \langle h_0 \circledast h_1 \circledast h_2 \mid \langle n \circledast k_0 \circledast k_1 \circledast k_2 \circledast m \rangle \rangle$ , to the canonical form  $\langle h_0 \circledast k_0 \circledast k_1 \circledast k_2 \circledast h_1 \circledast h_2 \rangle$ .

In summary, we have that  $\alpha(\langle f_0 \circledast f_1 \circledast f_2 \mid \langle g_0 \circledast g_1 \circledast g_2 \rangle \rangle) = (\langle h_0 \circledast h_1 \circledast h_2 \mid \langle k_0 \circledast k_1 \circledast k_2 \rangle \rangle)$  if and only if

$$\langle f_0 \circledast g_0 \circledast g_1 \circledast g_2 \circledast f_1 \circledast g_2 \rangle = \langle h_0 \circledast h_1 \circledast k_0 \circledast k_1 \circledast k_2 \circledast h_2 \rangle,$$

which is what we wanted to prove.  $\square$

**Lemma C.4** (Promonoidal splice left unitor). *We can construct a natural isomorphism,*

$$\lambda: \int_{V \in \mathbb{S}\mathbb{C}}^U \mathbb{S}\mathbb{C}(A; U \triangleleft_X V) \times \mathbb{S}\mathbb{C}(U; N) \cong \mathbb{S}\mathbb{C}(A; X),$$

exclusively from Yoneda isomorphisms. This isomorphism is defined by  $\lambda(\langle f_0 \circledast f_1 \circledast f_2 \mid g \rangle) = \langle f_0 \circledast g \circledast f_1 \circledast f_2 \rangle$ .

*Proof.* Indeed, the following coend calculus derivation constructs the isomorphism.

$$\begin{aligned} \int_{V \in \mathbb{S}\mathbb{C}}^U \mathbb{S}\mathbb{C}(A; U \triangleleft_X V) \times \mathbb{S}\mathbb{C}(U; N) &= \text{(by definition)} \\ \int_{V \in \mathbb{S}\mathbb{C}}^U \mathbb{C}(A; U) \times \mathbb{C}(V; X) \times \mathbb{C}(Y; B) \times \mathbb{C}(U; V) &= \text{(by definition)} \\ \int_{V \in \mathbb{S}\mathbb{C}}^U \mathbb{S}\mathbb{C}(A; X) \times \mathbb{C}(Y; B) \times \mathbb{C}(U; V) &\cong \text{(by Yoneda reduction)} \\ \mathbb{C}(A; X) \times \mathbb{C}(Y; B). \end{aligned}$$

Thus, it is constructed by a Yoneda isomorphism.  $\square$

**Lemma C.5** (Promonoidal splice right unitor). *We can construct a natural isomorphism,*

$$\rho: \int_{V \in \mathbb{S}\mathbb{C}}^U \mathbb{S}\mathbb{C}(A; X \triangleleft_Y U) \times \mathbb{S}\mathbb{C}(U; N) \cong \mathbb{S}\mathbb{C}(A; X),$$

exclusively from Yoneda isomorphisms. This isomorphism is defined by  $\rho(\langle f_0 \circledast f_1 \circledast f_2 \mid g \rangle) = \langle f_0 \circledast g \circledast f_1 \circledast f_2 \rangle$ .

*Proof.* Indeed, the following coend calculus derivation constructs the isomorphism.

$$\begin{aligned} \int_{V \in \mathbb{S}\mathbb{C}}^U \mathbb{S}\mathbb{C}(A; X \triangleleft_Y U) \times \mathbb{S}\mathbb{C}(U; N) &= \text{(by definition)} \\ \int_{V \in \mathbb{S}\mathbb{C}}^U \mathbb{C}(A; X) \times \mathbb{C}(Y; U) \times \mathbb{C}(V; B) \times \mathbb{C}(U; V) &= \text{(by definition)} \\ \int_{V \in \mathbb{S}\mathbb{C}}^U \mathbb{C}(A; X) \times \mathbb{S}\mathbb{C}(Y; U) \times \mathbb{C}(U; V) &\cong \text{(by Yoneda reduction)} \\ \mathbb{C}(A; X) \times \mathbb{C}(Y; B). \end{aligned}$$

Thus, it is constructed by a Yoneda isomorphism.  $\square$

**Proposition C.6** (From Proposition 3.6). *Splice gives a functor  $S: \mathbf{Cat} \rightarrow \mathbf{Promon}$ .*

*Proof.* Definition 3.4 defines the action on categories. We define the action on functors. Given a functor  $F : \mathbb{C} \rightarrow \mathbb{D}$ , define the promonoidal functor  $SF : \mathbb{S}\mathbb{C} \rightarrow \mathbb{S}\mathbb{D}$  by

$$\begin{aligned} \frac{A}{B} &\mapsto \frac{FA}{FB}, \\ SF &:= F_{A,X} \times F_{Y,B} : \mathbb{S}\mathbb{C}(\frac{A}{B}, X) \rightarrow \mathbb{S}\mathbb{D}(\frac{FA}{FB}, FX), \\ SF_{\triangleleft} &:= F_{A,X} \times F_{Y,X'} \times F_{Y',B} : \mathbb{S}\mathbb{C}(\frac{A}{B}, \frac{X}{Y} \triangleleft \frac{X'}{Y'}) \rightarrow \mathbb{S}\mathbb{D}(\frac{FA}{FB}, \frac{FX}{FY} \triangleleft \frac{FX'}{FY'}), \\ SF_N &:= F_{A,B} : \mathbb{S}\mathbb{C}(\frac{A}{B}, N) \rightarrow \mathbb{S}\mathbb{D}(\frac{FA}{FB}, N). \end{aligned}$$

It follows from the promonoidal structure on spliced arrows (Proposition C.2) that this preserves coherence maps. If  $\mathbf{Id}_{\mathbb{C}} : \mathbb{C} \rightarrow \mathbb{C}$  is an identity functor, then it defines the identity  $\mathbf{Id}_{\mathbb{S}\mathbb{C}}$ , which has underlying functor the identity and identity natural transformations. If  $G : \mathbb{B} \rightarrow \mathbb{C}$  is another functor, then  $S(G \circ F) = SG \circ SF$  follows from composition of functors.  $\square$

**Theorem C.7** (From Theorem 3.7). *There exists an adjunction between categories and promonoidal categories, where the contour of a promonoidal is the left adjoint, and the splice category is the right adjoint.*

*Proof.* Let  $\mathbb{C}$  be a category and let  $\mathbb{B}$  be a promonoidal category. We will show that the promonoidal functors  $\mathbb{B} \rightarrow \mathbb{S}\mathbb{C}$  are in natural correspondence with the functors  $\mathbb{C}\mathbb{B} \rightarrow \mathbb{C}$ . We first observe that the category  $\mathbb{C}\mathbb{B}$  is freely presented; thus, a functor  $\mathbb{C}\mathbb{B} \rightarrow \mathbb{C}$  amounts to a choice of some objects and some morphisms in  $\mathbb{C}$  satisfying some equations. Explicitly, by the definition of *contour*, a functor  $\mathbb{C}\mathbb{B} \rightarrow \mathbb{C}$  amounts to

- for each  $X \in \mathbb{B}_{\text{obj}}$ , a choice of objects  $X^L, X^R \in \mathbb{C}_{\text{obj}}$ ;
- for each element  $a \in \mathbb{B}(X)$ , a choice of morphisms  $a_0 \in \mathbb{C}(X^L, X^R)$ ;
- for each morphism  $a \in \mathbb{B}(A; X)$ , a choice of morphisms  $a_0 \in \mathbb{C}(A^L; X^L)$  and  $a_1 \in \mathbb{C}(X^R; A^R)$ ;
- for each split  $a \in \mathbb{C}(A; X \triangleleft Y)$ , a choice of morphisms  $a_0 \in \mathbb{C}(A^L; X^L)$ ,  $a_1 \in \mathbb{C}(X^R; Y^L)$  and  $a_2 \in \mathbb{C}(Y^R; A^R)$ ;
- the choice must be such that  $\alpha(a | b) = (c | d)$  implies  $a_0 = c_0 \circ d_0$ ;  $a_1 \circ b_0 = d_1$  and  $b_1 = d_2 \circ c_1$ ;  $a_2 \circ b_2 = c_2$ ;
- the choice must be such that  $\rho(a | b) = c = \lambda(d | e)$  implies  $a_0 = c_0 = d_0 \circ e_0 \circ d_1$  and  $a_1 \circ b_0 \circ a_2 = c_1 = d_2$ .

On the other hand, a promonoidal functor  $\mathbb{B} \rightarrow \mathbb{S}\mathbb{C}$ , also amounts to

- for each  $X \in \mathbb{B}_{\text{obj}}$ , an object  $FX = (X^L, X^R) \in \mathbb{S}\mathbb{C}_{\text{obj}}$ , which is a pair of objects of  $\mathbb{C}_{\text{obj}}$ ;
- for each element  $a \in \mathbb{B}(X)$ , a morphism  $F(a) = a_0 \in \mathbb{S}\mathbb{C}(FX)$ ;
- for each element  $a \in \mathbb{B}(A; X)$ , a splice  $F(a) = \langle a_0 \circ \square \circ a_1 \rangle \in \mathbb{S}\mathbb{C}(FA; FX)$ ;
- for each element  $a \in \mathbb{B}(A; X \triangleleft Y)$ , a splice  $F(a) = \langle a_0 \circ \square \circ a_1 \circ \square \circ a_2 \rangle \in \mathbb{S}\mathbb{C}(FA; FX \triangleleft FY)$ ;
- preserving associativity, with  $\alpha(a | b) = (c | d)$  implying  $\alpha(F(a) | F(b)) = F(c) | F(d)$ ;
- preserving unitality, with  $\rho(a | b) = c = \lambda(d | e)$  implying  $\rho(F(a) | F(b)) = F(c) = \lambda(F(d) | F(e))$ ;

by the definition of *splice*, its associativity and unitality, the structure on each one of these points is exactly equal.  $\square$

### C.1 Spliced arrow multicategory

As a consequence of the previous discussion, the  $n$ -morphisms are the sequences of arrows in  $\mathbb{C}$  separated by  $n$  gaps; the sequence of arrows goes from  $A$  to  $B$ , with holes typed by  $\{X_i, Y_i\}_{i \in [1, \dots, n]}$ . In other words,

$$\mathbb{S}\mathbb{C}\left(\frac{A}{B}; \frac{X_1}{Y_1} \otimes \dots \otimes \frac{X_n}{Y_n}\right) = \mathbb{C}(A; X_1) \times \left( \prod_{k=1}^{n-1} \mathbb{C}(Y_k, X_{k+1}) \right) \times \mathbb{C}(Y_n, B).$$

Composition in the multicategory is defined by substitution of a spliced arrow into one of the gaps of the second; the identity is just  $\text{id}_A - \text{id}_B$ , the spliced arrow with a single gap typed by  $(A, B)$ .

**Proposition C.8.** *The multicategory of spliced arrows,  $\mathbb{S}\mathbb{C}$ , is precisely the promonoidal category induced by the duality  $\mathbb{C}^{\text{op}} \dashv \mathbb{C}$  in the monoidal bicategory of profunctors: a promonoidal category over  $\mathbb{C} \times \mathbb{C}^{\text{op}}$ .*

APPENDIX D  
PARALLEL-SEQUENTIAL CONTEXT

D.1 Monoidal Contour

**Definition D.1** (Monoidal contour, from Definition 4.4). The *contour* of a *produoidal* category  $\mathbb{B}$  is the monoidal category  $\mathcal{D}\mathbb{B}$  that has two objects,  $X^L$  (left-handed) and  $X^R$  (right-handed), for each object  $X \in \mathbb{B}_{obj}$ ; and has arrows those that arise from *contouring* both sequential and parallel decompositions of the promonoidal category.

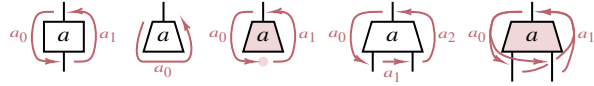

Fig. 22: Generators of the monoidal category of contours.

Specifically, it is freely presented by (i) a pair of morphisms  $a_0 \in \mathcal{D}\mathbb{B}(A^L; X^L)$ ,  $a_1 \in \mathcal{D}\mathbb{B}(X^R; A^R)$  for each morphism  $a \in \mathbb{B}(A; X)$ ; (ii) a morphism  $a_0 \in \mathcal{D}\mathbb{B}(A^L; A^R)$ , for each sequential unit  $a \in \mathbb{C}(A; N)$ ; (iii) a pair of morphisms  $a_0 \in \mathcal{D}\mathbb{B}(A^L; I)$  and  $a_0 \in \mathcal{D}\mathbb{B}(I; A^R)$ , for each parallel unit  $a \in \mathbb{B}(A; I)$ ; (iv) a triple of morphisms  $a_0 \in \mathcal{D}\mathbb{B}(A^L; X^L)$ ,  $a_1 \in \mathcal{D}\mathbb{B}(X^R; Y^L)$ ,  $a_2 \in \mathcal{D}\mathbb{B}(Y^R; A^R)$  for each sequential split  $a \in \mathbb{B}(A; X \triangleleft Y)$ ; and (v) a pair of morphisms  $a_0 \in \mathcal{D}\mathbb{B}(A^L; X^L \otimes Y^L)$  and  $a_1 \in \mathcal{D}\mathbb{B}(X^R \otimes Y^R; A^R)$  for each parallel split  $a \in \mathbb{B}(A; X \otimes Y)$ , see Figure 22.

For each equality  $a \circledast^2 b = c \circledast^1 d$ , we impose the equations  $a_0 = c_0 \circledast d_0$ ;  $a_1 \circledast b_0 = d_1$  and  $b_1 = d_2 \circledast c_1$ ;  $a_2 \circledast b_2 = c_2$ . For each equality  $a \circledast^2 b = c = d \circledast^1 e$ , we impose  $a_0 = c_0 = d_0 \circledast e_0 \circledast d_1$  and  $a_1 \circledast b_0 \circledast a_2 = c_1 = d_2$ . These follow from Figure 7.

For each application of associativity,  $\alpha(a \circledast_1 b) = c \circledast_2 d$ , we impose the equations  $a_0 \circledast (b_0 \otimes \text{id}) = c_0 \circledast (\text{id} \otimes d_0)$  and  $(b_1 \otimes \text{id}) \circledast a_1 = (\text{id} \otimes d_1) \circledast c_1$ . These follow from Figure 23.

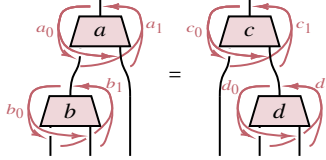

Fig. 23: Equation from associativity.

For each application of unitality,  $\lambda(a \circledast_1 b) = c = \rho(d \circledast_2 e)$ , we impose the equations  $a_0 \circledast (b_0 \otimes \text{id}) = c_0 = d_0 \circledast (\text{id} \otimes e_0)$  and  $(b_1 \otimes \text{id}) \circledast a_1 = c_1 = (\text{id} \otimes e_1) \circledast d_1$ . These follow from Figure 24.

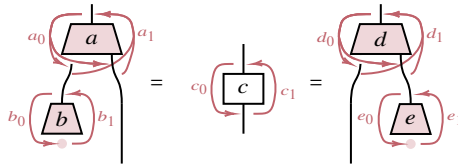

Fig. 24: Equations from unitality.

For each application of the laxator,  $\psi_2(a | b | c) = (d | e | f)$ , we impose the equation  $a_0 \circledast (b_0 \otimes c_0) = d_0 \circledast e_0$ , the middle equation  $b_1 \otimes c_1 = e_1 \circledast d_1 \circledast f_0$ , and  $(b_2 \otimes c_2) \circledast a_1 = f_1 \circledast d_2$ . These follow Figure 25.

For each application of the laxator,  $\psi_0(a) = (b |_1 c |_2 d)$ , we impose an equation  $a_0 = b_0 \circledast c_0$ , an equation  $\text{id} = c_1 \circledast b_1 \circledast d_0$ , and an equation  $a_1 = d_1 \circledast b_2$ . This follows Figure 26.

For each application of the laxator,  $\varphi_2(a |_1 b |_2 c) = d$ , we impose an equation  $a_0 \circledast (b_0 \otimes c_0) \circledast a_1 = d_0$ . This follows Figure 27.

For each application of the laxator,  $\varphi_0(a) = b$ , we impose an equation  $a_0 \circledast a_1 = b_0$ . This follows Figure 28.



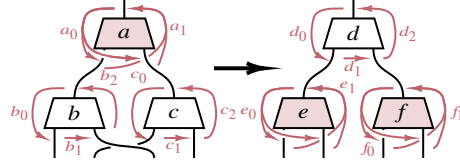

Fig. 25: Equations for the first laxator.

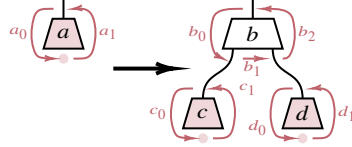

Fig. 26: Equations for the second laxator.

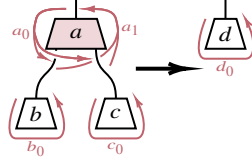

Fig. 27: Equations for the third laxator.

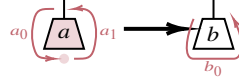

Fig. 28: Equations for the fourth laxator.

**Proposition D.2** (From Proposition 4.5). *Monoidal contour gives a functor  $\mathcal{D} : \mathbf{Produo} \rightarrow \mathbf{Mon}$ .*

*Proof.* Definition 4.4 defines the action on produoidal categories. We define the action on produoidal functors. Given a produoidal functor  $F : \mathbb{V} \rightarrow \mathbb{W}$ , define the strict monoidal functor  $\mathcal{D}F : \mathcal{D}\mathbb{V} \rightarrow \mathcal{D}\mathbb{W}$  by the following morphism of presentations:

- the objects  $X^L$  and  $X^R$  are mapped to  $F(X)^L$  and  $F(X)^R$ ;
- for each  $a \in \mathbb{V}(A; N)$ , the morphism  $a_0 : A^L \rightarrow A$  is mapped to  $F_N(a)_0$ ;
- for each  $b \in \mathbb{V}(A; I)$ , both  $b_0 : A^L \rightarrow I$  and  $b_1 : I \rightarrow A^R$  are mapped to  $F_I(b)_0$  and  $F_I(b)_1$ ;
- for each  $c \in \mathbb{V}(X; B)$ , the morphisms  $c_0 : B^L \rightarrow X^L$ ,  $c_1 : X^R \rightarrow B^R$  are mapped to  $F(c)_0$  and  $F(c)_1$ ;
- for each  $d \in \mathbb{V}(C; Y \otimes Z)$ , the morphisms  $d_0 : C^L \rightarrow Y^L$ ,  $d_1 : Y^R \rightarrow Z^L$  and  $d_2 : Z^R \rightarrow C^R$  are mapped to  $F_{\triangleleft}(d)_0$ ,  $F_{\triangleleft}(d)_1$  and  $F_{\triangleleft}(d)_2$ ;
- for each  $e \in \mathbb{V}(C; Y \triangleleft Z)$ , the morphisms  $e_0 : C^L \rightarrow Y^L$ ,  $e_1 : Y^R \rightarrow Z^L$  and  $e_2 : Z^R \rightarrow C^R$  are mapped to  $F_{\triangleleft}(e)_0$ ,  $F_{\triangleleft}(e)_1$  and  $F_{\triangleleft}(e)$ .

It follows from  $F : \mathbb{V} \rightarrow \mathbb{W}$  being a produoidal functor that the contour equations of Definition 3.1 hold between the images of generators, so this assignment extends freely to a strict monoidal functor. In particular when  $\mathbf{Id}_{\mathbb{V}} : \mathbb{V} \rightarrow \mathbb{V}$  is an identity, it is an identity functor. Let  $G : \mathbb{U} \rightarrow \mathbb{V}$  be another produoidal functor, then  $C(G \mathbin{\text{;}} F) = C(G) \mathbin{\text{;}} C(F)$  follows from the composition of produoidal functors.  $\square$

## D.2 Spliced Monoidal Arrows

**Proposition D.3** (From Proposition 4.7). *Spliced monoidal arrows form a produoidal category with their sequential and parallel splits, units, and suitable coherence morphisms and laxators.*

*Proof.* We use the laxators constructed in Lemmas D.4 to D.7. Because these laxators are constructed out of compositions and Yoneda lemma, they do satisfy all formal coherence equations.  $\square$

**Lemma D.4** (Produoidal splice, first laxator). *We can construct a natural transformation,*

$$\psi_2 : \mathcal{TC} \left( \begin{matrix} A \\ B \end{matrix}; \left( \begin{matrix} X \\ Y \end{matrix} \triangleleft \begin{matrix} X' \\ Y' \end{matrix} \right) \otimes \left( \begin{matrix} U \\ V \end{matrix} \triangleleft \begin{matrix} U' \\ V' \end{matrix} \right) \right) \rightarrow \mathcal{TC} \left( \begin{matrix} A \\ B \end{matrix}; \left( \begin{matrix} X \\ Y \end{matrix} \otimes \begin{matrix} U \\ V \end{matrix} \right) \triangleleft \left( \begin{matrix} X' \\ Y' \end{matrix} \otimes \begin{matrix} U' \\ V' \end{matrix} \right) \right),$$

exclusively from compositions and Yoneda isomorphisms. This laxator is defined by

$$\psi_2(\langle f_0 \circledast f_1 \mid \langle h_0 \circledast h_1 \circledast h_2 \mid \langle k_0 \circledast k_1 \circledast k_2 \rangle \rangle = \langle g_0 \circledast g_1 \circledast g_2 \mid \langle p_0 \circledast p_1 \mid \langle q_0 \circledast q_1 \rangle \rangle$$

if and only if

$$\langle f_0 \circledast (h_0 \otimes k_0) \circledast h_1 \otimes k_1 \circledast (h_2 \otimes k_2) \circledast f_1 \rangle = \langle g_0 \circledast p_0 \circledast p_1 \circledast g_1 \circledast q_0 \circledast q_1 \circledast g_2 \rangle.$$

*Proof.* We will show that the right hand side is isomorphic to the following set. Then, we construct a map from the left hand to this same set,

$$\mathbb{C}(A; X \otimes X') \times \mathbb{C}(Y \otimes Y'; U \otimes U') \times \mathbb{C}(V \otimes V'; B).$$

Indeed the following coend derivation constructs an isomorphism.

$$\begin{aligned} \mathcal{TC} \left( \frac{A}{B}; \left( \frac{X}{Y} \otimes \frac{X'}{Y'} \right) \triangleleft \left( \frac{U}{V} \otimes \frac{U'}{V'} \right) \right) & \stackrel{\text{def}}{=} \\ \int^{\frac{Z}{W}, \frac{Z'}{W'} \in \mathcal{TC}} \mathcal{TC} \left( \frac{A}{B}; \frac{Z}{W} \triangleleft \frac{Z'}{W'} \right) \times \mathcal{TC} \left( \frac{Z}{W}; \frac{X}{Y} \otimes \frac{X'}{Y'} \right) \times \mathcal{TC} \left( \frac{Z'}{W'}; \frac{U}{V} \otimes \frac{U'}{V'} \right) & \stackrel{\text{def}}{=} \\ \int^{\frac{Z}{W}, \frac{Z'}{W'} \in \mathcal{TC}} \mathcal{TC} \left( \frac{A}{B}; \frac{Z}{W} \triangleleft \frac{Z'}{W'} \right) \times \mathbb{C}(Z; X \otimes X') \times \mathbb{C}(Y \otimes Y'; W) \times \mathbb{C}(Z'; U \otimes U') \times \mathbb{C}(V \otimes V'; W') & \stackrel{\text{def}}{=} \\ \int^{\frac{Z}{W}, \frac{Z'}{W'} \in \mathcal{TC}} \mathcal{TC} \left( \frac{A}{B}; \frac{Z}{W} \triangleleft \frac{Z'}{W'} \right) \times \mathcal{TC} \left( \frac{Z}{W}; \frac{X \otimes X'}{Y \otimes Y'} \right) \times \mathcal{TC} \left( \frac{Z'}{W'}; \frac{U \otimes U'}{V \otimes V'} \right) & \stackrel{\mathcal{Y}_1}{\cong} \\ \mathcal{TC} \left( \frac{A}{B}; \frac{X \otimes X'}{Y \otimes Y'} \triangleleft \frac{U \otimes U'}{V \otimes V'} \right) & \stackrel{\text{def}}{=} \\ \mathbb{C}(A; X \otimes X') \times \mathbb{C}(Y \otimes Y'; U \otimes U') \times \mathbb{C}(V \otimes V'; B). \end{aligned}$$

The isomorphism sends the triple  $(\langle g_0 \circledast g_1 \circledast g_2 \mid \langle p_0 \circledast p_1 \mid \langle q_0 \circledast q_1 \rangle \rangle)$  to  $\langle g_0 \circledast p_0 \circledast p_1 \circledast g_1 \circledast q_0 \circledast q_1 \circledast g_2 \rangle$ . On the other hand, we define a map from the left hand side of the equation to this set, given by

$$\langle f_0 \circledast f_1 \mid \langle h_0 \circledast h_1 \circledast h_2 \mid \langle k_0 \circledast k_1 \circledast k_2 \rangle \rangle \mapsto \langle f_0 \circledast (h_0 \otimes k_0) \circledast h_1 \otimes k_1 \circledast (h_2 \otimes k_2) \circledast f_1 \rangle.$$

In conclusion, composing both the isomorphism and the map,  $\psi_2(\langle f_0 \circledast f_1 \mid \langle h_0 \circledast h_1 \circledast h_2 \mid \langle k_0 \circledast k_1 \circledast k_2 \rangle \rangle = \langle g_0 \circledast g_1 \circledast g_2 \mid \langle p_0 \circledast p_1 \mid \langle q_0 \circledast q_1 \rangle \rangle$  if and only if

$$\langle f_0 \circledast (h_0 \otimes k_0) \circledast (h_1 \otimes k_1) \circledast (h_2 \otimes k_2) \circledast f_1 \rangle = \langle g_0 \circledast p_0 \circledast p_1 \circledast g_1 \circledast q_0 \circledast q_1 \circledast g_2 \rangle,$$

which is what we wanted to prove.  $\square$

**Lemma D.5** (Produoidal splice, second laxator). *We can construct a natural transformation,*

$$\psi_0: \mathcal{TC} \left( \frac{A}{B}; I \right) \rightarrow \mathcal{TC} \left( \frac{A}{B}; I \triangleleft I \right),$$

exclusively from compositions and Yoneda isomorphisms. This laxator is defined by  $\psi_0(\langle f_0 \circledast f_1 \mid \langle h_0 \circledast h_1 \circledast h_2 \mid \langle k_0 \circledast k_1 \circledast k_2 \rangle \rangle = \langle g_0 \circledast g_1 \circledast g_2 \mid \langle p_0 \circledast p_1 \mid \langle q_0 \circledast q_1 \rangle \rangle$  if and only if

$$\langle f_0 \circledast (h_0 \otimes k_0) \circledast (h_1 \otimes k_1) \circledast (h_2 \otimes k_2) \circledast f_1 \rangle = \langle g_0 \circledast p_0 \circledast p_1 \circledast g_1 \circledast q_0 \circledast q_1 \circledast g_2 \rangle.$$

*Proof.* We will show that the right hand side is isomorphic to the following set. Then, we construct a map from the left hand to this same set,  $\mathbb{C}(A; I) \times \mathbb{C}(I; I) \times \mathbb{C}(I; B)$ . Indeed the following coend derivation constructs an isomorphism.

$$\begin{aligned} \mathcal{TC} \left( \frac{A}{B}; I \triangleleft I \right) & \stackrel{\text{def}}{=} \\ \int^{\frac{Z}{W}, \frac{Z'}{W'} \in \mathcal{TC}} \mathcal{TC} \left( \frac{A}{B}; \frac{Z}{W} \triangleleft \frac{Z'}{W'} \right) \times \mathcal{TC} \left( \frac{Z}{W}; I \right) \times \mathcal{TC} \left( \frac{Z'}{W'}; I \right) & \stackrel{\text{def}}{=} \\ \int^{\frac{Z}{W}, \frac{Z'}{W'} \in \mathcal{TC}} \mathcal{TC} \left( \frac{A}{B}; \frac{Z}{W} \triangleleft \frac{Z'}{W'} \right) \times \mathcal{TC} \left( \frac{Z}{W}; I \right) \times \mathcal{TC} \left( \frac{Z'}{W'}; I \right) & \stackrel{\mathcal{Y}_1}{\cong} \end{aligned}$$

$$\mathcal{TC} \left( \frac{A}{B}; I \triangleleft I \right) \stackrel{\text{def}}{=} \mathbb{C}(A; I) \times \mathbb{C}(I; I) \times \mathbb{C}(I; B).$$

This isomorphism sends the triple  $\langle b_0 \circledast b_1 \circledast b_2 \mid \langle c_0 \circledast c_1 \mid \langle d_0 \circledast d_1 \rangle \rangle$  to  $\langle b_0 \circledast c_0 \circledast c_1 \circledast b_1 \circledast d_0 \circledast d_1 \circledast b_2 \rangle$ . On the other hand, we define a map from the left hand side of the equation to this set, given by

$$\langle a_0 \circledast a_1 \rangle \mapsto \langle a_0 \circledast \text{id}_I \circledast a_1 \rangle.$$

In conclusion, composing both the isomorphism and this function, we get that  $\psi_0 \langle a_0 \circledast a_1 \rangle = \langle b_0 \circledast b_1 \circledast b_2 \mid \langle c_0 \circledast c_1 \mid \langle d_0 \circledast d_1 \rangle \rangle$  if and only if  $\langle a_0 \circledast \text{id}_I \circledast a_1 \rangle = \langle b_0 \circledast c_0 \circledast c_1 \circledast b_1 \circledast d_0 \circledast d_1 \circledast b_2 \rangle$ .  $\square$

**Lemma D.6** (Produoidal splice, third laxator). *We can construct a natural transformation,*

$$\varphi_2: \mathcal{TC} \left( \frac{A}{B}; N \otimes N \right) \rightarrow \mathcal{TC} \left( \frac{A}{B}; N \right),$$

*exclusively from compositions and Yoneda isomorphisms. This laxator is defined by  $\varphi_2(\langle f_0 \circledast f_1 \mid h_0 \mid h_1 \rangle) = f_0 \circledast (h_0 \otimes h_1 \circledast f_1)$ .*

**Lemma D.7** (Produoidal splice, fourth laxator). *We can construct a natural transformation,*

$$\varphi_0: \mathcal{TC} \left( \frac{A}{B}; I \right) \rightarrow \mathcal{TC} \left( \frac{A}{B}; N \right),$$

*exclusively from compositions and Yoneda isomorphisms. This laxator is defined by  $\varphi_0 \langle a_0 \circledast a_1 \rangle = a_0 \circledast a_1$ .*

**Proposition D.8** (From Proposition 4.8). *Monoidal splice gives a functor  $\mathcal{T}: \mathbf{Mon} \rightarrow \mathbf{Produo}$ .*

*Proof.* Definition 4.6 defines the action on monoidal categories. We define the action on monoidal functors. Given a monoidal functor  $F: \mathbb{C} \rightarrow \mathbb{D}$ , define the produoidal functor  $\mathcal{T}F: \mathcal{TC} \rightarrow \mathcal{TD}$  by

$$\begin{aligned} \frac{A}{B} &\mapsto \frac{FA}{FB} \\ \mathcal{T}F &:= F_{A,X} \times F_{Y,B}: \mathcal{TC} \left( \frac{A}{B}; \frac{X}{Y} \right) \rightarrow \mathcal{TD} \left( \frac{FA}{FB}; \frac{FX}{FY} \right) \\ \mathcal{T}F_{\triangleleft} &:= F_{A,X} \times F_{Y,X'} \times F_{Y',B}: \mathcal{TC} \left( \frac{A}{B}; \frac{X}{Y} \triangleleft \frac{X'}{Y'} \right) \rightarrow \mathcal{TD} \left( \frac{FA}{FB}; \frac{FX}{FY} \triangleleft \frac{FX'}{FY'} \right) \\ \mathcal{T}F_{\otimes} &:= F_{A,X \otimes Y} \times F_{X' \otimes Y', B}: \mathcal{TC} \left( \frac{A}{B}; \frac{X}{Y} \otimes \frac{X'}{Y'} \right) \rightarrow \mathcal{TD} \left( \frac{FA}{FB}; \frac{FX}{FY} \otimes \frac{FX'}{FY'} \right) \\ \mathcal{T}F_N &:= F_{A,B}: \mathcal{TC} \left( \frac{A}{B}; N \right) \rightarrow \mathcal{TD} \left( \frac{FA}{FB}; N \right) \\ \mathcal{T}F_I &:= F_{A,I} \times F_{I,B}: \mathcal{TC} \left( \frac{A}{B}; I \right) \rightarrow \mathcal{TD} \left( \frac{FA}{FB}; I \right). \end{aligned}$$

It follows from the produoidal structure on spliced monoidal arrows (Proposition D.3) that this preserves coherence maps. If  $\mathbf{Id}_{\mathbb{C}}: \mathbb{C} \rightarrow \mathbb{C}$  is an identity functor, then it defines the identity  $\mathbf{Id}_{\mathcal{TC}}$ , which has underlying functor the identity and identity natural transformations. If  $G: \mathbb{B} \rightarrow \mathbb{C}$  is another monoidal functor, then  $S(G \circledast F) = SG \circledast SF$  follows from composition of monoidal functors.  $\square$

**Theorem D.9** (From Theorem 4.9). *There exists an adjunction between monoidal categories (and strict monoidal functors) and produoidal categories (and produoidal functors), where the monoidal contour is the left adjoint, and the produoidal splice category is the right adjoint.*

*Proof.* As in Theorem C.7, we again have that  $\mathcal{DB}$  is presented by generators and equations; so, to specify a strict monoidal functor  $\mathcal{DB} \rightarrow \mathbb{M}$ , it is enough to specify images of the generators satisfying the equations. Let  $(\mathbb{M}, \otimes_M, I_M)$  be a monoidal category. Then a strict monoidal functor  $\mathcal{DB} \rightarrow \mathbb{M}$  amounts to the following data.

- For each object  $X \in \mathbb{B}_{\text{obj}}$ , a pair of objects  $X^L, X^R \in \mathbb{M}_{\text{obj}}$ ;
- for each element  $f \in \mathbb{B}(X; N)$ , a morphism  $f_0 \in \mathbb{M}(X^L; X^R)$ ;
- for each unit  $f \in \mathbb{B}(X; I)$ , a choice of morphisms  $f_0 \in \mathbb{M}(X^L; I_M)$ ,  $g_0 \in \mathbb{M}(I_M; X^R)$ ;
- for each morphism  $f \in \mathbb{B}(A; X)$ , a choice of morphisms  $f_0 \in \mathbb{M}(A^L; X^L)$  and  $f_1 \in \mathbb{M}(X^R; A^R)$ ;

- for each sequential split  $f \in \mathbb{B}(A; X \triangleleft Y)$ , a choice of morphisms  $f_0 \in \mathbb{M}(A^L; X^L)$ ,  $f_1 \in \mathbb{M}(X^L; X^R)$ , and  $f_2 \in \mathbb{M}(X^R; A^R)$ ;
- for each parallel split  $f \in \mathbb{B}(A; X \otimes Y)$ , a choice of morphisms  $f_0 \in \mathbb{M}(A^L; X^L \otimes Y^L)$  and  $f_1 \in \mathbb{M}(X^R \otimes Y^R; A^R)$ .

Such that for each promonoidal structure

- $\alpha(a \mathbin{\text{;}}_1 b) = (c \mathbin{\text{;}}_2 d)$  in  $\mathbb{B} \Rightarrow a_0 \mathbin{\text{;}} (b_0 \otimes \text{id}) = c_0 \mathbin{\text{;}} (\text{id} \otimes d_0)$  and  $(b_1 \otimes \text{id}) \mathbin{\text{;}} a_1 = (\text{id} \otimes d_1) \mathbin{\text{;}} c_1$  in  $\mathbb{M}$ ;
- $\lambda(a \mathbin{\text{;}}_1 b) = c = \rho(d \mathbin{\text{;}}_2 e)$  in  $\mathbb{B} \Rightarrow a_0 \mathbin{\text{;}} (b_0 \otimes \text{id}) = c_0 = d_0 \mathbin{\text{;}} (\text{id} \otimes e_0)$  and  $(b_1 \otimes \text{id}) \mathbin{\text{;}} a_1 = c_1 = (\text{id} \otimes e_1) \mathbin{\text{;}} d_1$  in  $\mathbb{M}$ ;

and such that

- $\psi_2(a \mid b \mid c) = (d \mid e \mid f)$  in  $\mathbb{B} \Rightarrow a_0 \mathbin{\text{;}} (b_0 \otimes c_0) = d_0 \mathbin{\text{;}} e_0$ ,  $b_1 \otimes c_1 = e_1 \mathbin{\text{;}} d_1 \mathbin{\text{;}} f_0$  and  $(b_2 \otimes c_2) \mathbin{\text{;}} a_1 = f_1 \mathbin{\text{;}} d_2$  in  $\mathbb{M}$ ;
- $\psi_0(a) = (b \mid c \mid d)$  in  $\mathbb{B} \Rightarrow a_0 = b_0 \mathbin{\text{;}} c_0$ ,  $\text{id} = c_1 \mathbin{\text{;}} b_1 \mathbin{\text{;}} d_0$ , and  $a_1 = d_1 \mathbin{\text{;}} b_2$  in  $\mathbb{M}$ ;
- $\varphi_2(a \mid b \mid c) = d$  in  $\mathbb{B} \Rightarrow a_0 \mathbin{\text{;}} (b_0 \otimes c_0) \mathbin{\text{;}} a_1 = d_0$  in  $\mathbb{M}$ ;
- $\varphi_0(a) = b$  in  $\mathbb{B} \Rightarrow a_0 \mathbin{\text{;}} a_1 = b_0$  in  $\mathbb{M}$ .

On the other hand, a produoidal functor  $F : \mathbb{B} \rightarrow \mathcal{T}\mathbb{M}$ , also amounts to the following data. For each

- $X \in \mathbb{B}_{\text{obj}}$  an object  $F(X) = (X^L, X^R) \in \mathcal{T}\mathbb{M}_{\text{obj}}$ ;
- $f \in \mathbb{B}(X; N)$ , an element  $F(f) = f_0 \in \mathcal{T}\mathbb{M}(X^L; N)$ ;
- $f \in \mathbb{B}(X; I)$ , a unit  $F(f) = \langle f \parallel g \rangle \in \mathcal{T}\mathbb{M}(X^L; I_M)$ ;
- $f \in \mathbb{B}(A; X)$ , a spliced arrow  $F(f) = \langle f_0 \mathbin{\text{;}} \square \mathbin{\text{;}} f_1 \rangle \in \mathcal{T}\mathbb{M}(A^L, X^L; B^L, Y^L)$ ;
- $f \in \mathbb{B}(A; X \triangleleft Y)$ , a spliced arrow  $F(f) = \langle f_0 \mathbin{\text{;}} \square \mathbin{\text{;}} f_1 \mathbin{\text{;}} \square \mathbin{\text{;}} f_2 \rangle \in \mathcal{T}\mathbb{M}(A^L, X^L, X^R \triangleleft Y^L; A^R, X^R, Y^R)$ ;
- $f \in \mathbb{B}(A; X \otimes Y)$ , a spliced monoidal arrow  $F(f) = \langle f_0 \mathbin{\text{;}} \square \otimes \square \mathbin{\text{;}} f_1 \rangle \in \mathcal{T}\mathbb{M}(A^L, X^L, X^R \otimes Y^R; A^R, X^R, Y^R)$ ;

Such that for each promonoidal structure

- $\alpha(a \mid b) = (c \mid d)$  in  $\mathbb{B} \Rightarrow \alpha(Fa \mid Fb) = (Fc \mid Fd)$  in  $\mathcal{T}\mathbb{M}$ ;
- $\lambda(a \mid b) = c = \rho(d \mid e)$  in  $\mathbb{B} \Rightarrow \lambda(Fa \mid Fb) = Fc = \rho(Fd \mid Fe)$  in  $\mathcal{T}\mathbb{M}$ ;

and such that

- $\psi_2(a \mid b \mid c) = (d \mid e \mid f)$  in  $\mathbb{B} \Rightarrow \psi_2(Fa \mid Fb \mid Fc) = (Fd \mid Fe \mid Ff)$  in  $\mathcal{T}\mathbb{M}$ ;
- $\psi_0(a) = (b \mid c \mid d)$  in  $\mathbb{B} \Rightarrow \psi_0(Fa) = (Fa \mid Fc \mid Fd)$  in  $\mathcal{T}\mathbb{M}$ ;
- $\varphi_2(a \mid b \mid c) = d$  in  $\mathbb{B} \Rightarrow \varphi_2(Fa \mid Fb \mid Fc) = Fd$  in  $\mathcal{T}\mathbb{M}$ ;
- $\varphi_0(a) = b$  in  $\mathbb{B} \Rightarrow \varphi_0(Fa) = Fb$  in  $\mathcal{T}\mathbb{M}$ .

Each of these points is exactly equal by definition, which establishes the desired adjunction.  $\square$

APPENDIX E  
NORMALIZATION

E.1 Normalization

**Theorem E.1** (From Theorem 5.2). *Let  $\mathbb{V}_{\otimes, I, \triangleleft, N}$  be a produoidal category. The profunctor  $\mathcal{N}\mathbb{V}(\bullet; \bullet) = \mathbb{V}(\bullet; N \otimes \bullet \otimes N)$  forms a promonad. Moreover, the Kleisli category of this promonad is a normal produoidal category with the following sequential and parallel splits and units.*

$$\begin{aligned}\mathcal{N}\mathbb{V}(A; B) &= \mathbb{V}(A; N \otimes B \otimes N); \\ \mathcal{N}\mathbb{V}(A; B \otimes C) &= \mathbb{V}(A; N \otimes B \otimes N \otimes C \otimes N); \\ \mathcal{N}\mathbb{V}(A; B \triangleleft C) &= \mathbb{V}(A; (N \otimes B \otimes N) \triangleleft (N \otimes C \otimes N)); \\ \mathcal{N}\mathbb{V}(A; I) &= \mathbb{V}(A; N); \\ \mathcal{N}\mathbb{V}(A; N) &= \mathbb{V}(A; N).\end{aligned}$$

*Proof.* We define the following multiplication and unit for the promonad,  $\mathcal{N}\mathbb{V}$ . They are constructed out of laxators of the produoidal category  $\mathbb{V}$  and Yoneda isomorphisms; thus, they must be associative and unital by coherence. The unit is defined by

$$\begin{aligned}\mathbb{V}(A; B) &\cong \text{(by unitality of } \mathbb{V}\text{)} \\ \mathbb{V}(A; I \otimes B \otimes I) &\rightarrow \text{(by the laxators of } \mathbb{V}\text{)} \\ \mathbb{V}(A; N \otimes B \otimes N) &= \text{(by definition)} \\ \mathcal{N}\mathbb{V}(A; B).\end{aligned}$$

The multiplication is defined by,

$$\begin{aligned}\int^{B \in \mathbb{V}} \mathcal{N}\mathbb{V}(A; B) \times \mathcal{N}\mathbb{V}(B; C) &= \text{(by definition)} \\ \int^{B \in \mathbb{V}} \mathbb{V}(A; N \otimes B \otimes N) \times \mathbb{V}(B; N \otimes C \otimes N) &\cong \text{(by Yoneda reduction)} \\ \mathbb{V}(A; N \otimes N \otimes C \otimes N \otimes N) &\rightarrow \text{(by laxators of } \mathbb{V}\text{)} \\ \mathbb{V}(A; N \otimes C \otimes N) &= \text{(by definition)} \\ \mathcal{N}\mathbb{V}(A; C).\end{aligned}$$

Let us now construct the unitors and the associators. Again, they are constructed out of laxators of the produoidal category  $\mathbb{V}$ , the associators and unitors of  $\mathbb{V}$ , and Yoneda isomorphisms. We first consider the right unitor.

$$\begin{aligned}\int^{X \in \mathcal{N}\mathbb{V}} \mathcal{N}\mathbb{V}(A; B \otimes X) \times \mathcal{N}\mathbb{V}(X; N) &= \text{(by definition)} \\ \int^{X \in \mathcal{N}\mathbb{V}} \mathbb{V}(A; N \otimes B \otimes N \otimes X \otimes N) \times \mathcal{N}\mathbb{V}(X; N) &\cong \text{(by associativity of } \mathbb{V}\text{)} \\ \int^{X \in \mathcal{N}\mathbb{V}, P \in \mathbb{V}} \mathbb{V}(A; N \otimes B \otimes P) \times \mathbb{V}(P; N \otimes X \otimes N) \times \mathcal{N}\mathbb{V}(X; N) &= \text{(by definition)} \\ \int^{X \in \mathcal{N}\mathbb{V}, P \in \mathbb{V}} \mathbb{V}(A; N \otimes B \otimes P) \times \mathcal{N}\mathbb{V}(P; X) \times \mathcal{N}\mathbb{V}(X; N) &\cong \text{(by Yoneda reduction)} \\ \int^{P \in \mathbb{V}} \mathbb{V}(A; N \otimes B \otimes P) \times \mathcal{N}\mathbb{V}(P; N) &= \text{(by definition)} \\ \int^{P \in \mathbb{V}} \mathbb{V}(A; N \otimes B \otimes P) \times \mathbb{V}(P; N) &\cong \text{(by unitality)} \\ \int^{P \in \mathbb{V}} \mathbb{V}(A; N \otimes B \otimes N).\end{aligned}$$

We now consider the left unitor.

$$\begin{aligned}
& \int^{X \in \mathcal{NV}} \mathcal{NV}(A; X \otimes B) \times \mathcal{NV}(X; N) && = \text{(by definition)} \\
& \int^{X \in \mathcal{NV}} \mathbb{V}(A; N \otimes X \otimes N \otimes B \otimes N) \times \mathcal{NV}(X; N) && \cong \text{(by associativity of } \mathbb{V} \text{)} \\
& \int^{X \in \mathcal{NV}, P \in \mathbb{V}} \mathbb{V}(A; P \otimes B \otimes N) \times \mathbb{V}(P; N \otimes X \otimes N) \times \mathcal{NV}(X; N) && = \text{(by definition)} \\
& \int^{X \in \mathcal{NV}, P \in \mathbb{V}} \mathbb{V}(A; P \otimes B \otimes N) \times \mathcal{NV}(P; X) \times \mathcal{NV}(X; N) && \cong \text{(by Yoneda reduction)} \\
& \int^{P \in \mathbb{V}} \mathbb{V}(A; P \otimes B \otimes N) \times \mathcal{NV}(P; N) && = \text{(by definition)} \\
& \int^{P \in \mathbb{V}} \mathbb{V}(A; P \otimes B \otimes N) \times \mathbb{V}(P; N) && \cong \text{(by unitality)} \\
& \int^{P \in \mathbb{V}} \mathbb{V}(A; N \otimes B \otimes N).
\end{aligned}$$

Finally, we consider the associator. We can do so in two steps, showing that both sides of the equation

$$\int^{X \in \mathcal{NV}} \mathcal{NV}(A; B \otimes X) \times \mathcal{NV}(X; C \otimes D) \cong \int^{Y \in \mathcal{NV}} \mathcal{NV}(A; Y \otimes D) \times \mathcal{NV}(Y; B \otimes C)$$

are isomorphic to  $\mathbb{V}(A; N \otimes B \otimes N \otimes C \otimes N \otimes D \otimes N)$ . The first side by

$$\begin{aligned}
& \int^{X \in \mathcal{NV}} \mathcal{NV}(A; B \otimes X) \times \mathcal{NV}(X; C \otimes D) && = \text{(by definition)} \\
& \int^{X \in \mathcal{NV}} \mathbb{V}(A; N \otimes B \otimes N \otimes X \otimes N) \times \mathcal{NV}(X; C \otimes D) && \cong \text{(by associativity)} \\
& \int^{X \in \mathcal{NV}, P \in \mathbb{V}} \mathbb{V}(A; N \otimes B \otimes P) \times \mathbb{V}(P; N \otimes X \otimes N) \times \mathcal{NV}(X; C \otimes D) && = \text{(by definition)} \\
& \int^{X \in \mathcal{NV}, P \in \mathbb{V}} \mathbb{V}(A; N \otimes B \otimes P) \times \mathcal{NV}(P; X) \times \mathcal{NV}(X; C \otimes D) && \cong \text{(by Yoneda reduction)} \\
& \int^{P \in \mathbb{V}} \mathbb{V}(A; N \otimes B \otimes P) \times \mathcal{NV}(P; C \otimes D) && = \text{(by definition)} \\
& \int^{P \in \mathbb{V}} \mathbb{V}(A; N \otimes B \otimes P) \times \mathbb{V}(P; N \otimes C \otimes N \otimes D \otimes N) && \cong \text{(by associativity)} \\
& \mathbb{V}(A; N \otimes B \otimes N \otimes C \otimes N \otimes D \otimes N),
\end{aligned}$$

and the second side by

$$\begin{aligned}
& \int^{Y \in \mathcal{NV}} \mathcal{NV}(A; Y \otimes D) \times \mathcal{NV}(Y; B \otimes C) && = \text{(by definition)} \\
& \int^{Y \in \mathcal{NV}} \mathbb{V}(A; N \otimes Y \otimes N \otimes D \otimes N) \times \mathcal{NV}(Y; B \otimes C) && \cong \text{(by associativity)} \\
& \int^{Y \in \mathcal{NV}, P \in \mathbb{V}} \mathbb{V}(A; P \otimes D \otimes N) \times \mathbb{V}(P; N \otimes Y \otimes N) \times \mathcal{NV}(Y; B \otimes C) && = \text{(by definition)} \\
& \int^{Y \in \mathcal{NV}, P \in \mathbb{V}} \mathbb{V}(A; P \otimes D \otimes N) \times \mathcal{NV}(P; X) \times \mathcal{NV}(X; B \otimes C) && \cong \text{(by Yoneda reduction)} \\
& \int^{P \in \mathbb{V}} \mathbb{V}(A; P \otimes D \otimes N) \times \mathcal{NV}(P; B \otimes C) && = \text{(by definition)} \\
& \int^{P \in \mathbb{V}} \mathbb{V}(A; P \otimes D \otimes N) \times \mathbb{V}(P; N \otimes B \otimes N \otimes C \otimes N) && \cong \text{(by associativity)}
\end{aligned}$$

$$\mathbb{V}(A; N \otimes B \otimes N \otimes C \otimes N \otimes D \otimes N).$$

Precisely because they are constructed out of coherence morphisms for the base produoidal category  $\mathbb{V}$ , we know that these satisfy the pentagon and triangle equations and define a promonoidal category. The unitors and associators for the sequential promonoidal structure are defined similarly. Finally, we define the laxators of  $\mathcal{N}\mathbb{V}$ , making it into a produoidal category.

The first laxator,

$$\psi_2 : \mathcal{N}\mathbb{V}(A; (B_1 \triangleleft C_1) \otimes (B_2 \triangleleft C_2)) \longrightarrow \mathcal{N}\mathbb{V}(A; (B_1 \otimes B_2) \triangleleft (C_1 \otimes C_2)),$$

is defined by the following reasoning.

$$\begin{aligned} & \mathcal{N}\mathbb{V}(A; (B_1 \triangleleft C_1) \otimes (B_2 \triangleleft C_2)) \\ &= \text{(by definition)} \\ & \mathbb{V}(A; N \otimes ((N \otimes B_1 \otimes N) \triangleleft (N \otimes C_1 \otimes N)) \otimes N \otimes ((N \otimes B_2 \otimes N) \triangleleft (N \otimes C_2 \otimes N)) \otimes N) \\ & \rightarrow \text{(by } \psi_2 \text{ of } \mathbb{V}) \\ & \mathbb{V}(A; ((N \otimes N \otimes B_1 \otimes N) \triangleleft (N \otimes N \otimes B_2 \otimes N)) \otimes ((N \otimes N \otimes B_2 \otimes N \otimes N) \triangleleft (N \otimes C_2 \otimes N \otimes N))) \\ & \rightarrow \text{(by } \psi_2 \text{ of } \mathbb{V}) \\ & \mathbb{V}(A; (N \otimes N \otimes B_1 \otimes N \otimes N \otimes N \otimes B_2 \otimes N \otimes N) \triangleleft (N \otimes N \otimes C_1 \otimes N \otimes N \otimes N \otimes C_2 \otimes N \otimes N)) \\ & \rightarrow \text{(by } \varphi_2 \text{ of } \mathbb{V}) \\ & \mathbb{V}(A; (N \otimes N \otimes B_1 \otimes N \otimes B_2 \otimes N \otimes N) \triangleleft (N \otimes N \otimes C_1 \otimes N \otimes C_2 \otimes N \otimes N)) \\ &= \text{(by definition)} \\ & \mathcal{N}\mathbb{V}(A; (B_1 \otimes B_2) \triangleleft (C_1 \otimes C_2)). \end{aligned}$$

The remaining laxators are isomorphisms that arise from applications of unitality or just as identities.

$$\begin{aligned} \psi_0 &: \mathcal{N}\mathbb{V}(A, I) \xrightarrow{\cong} \mathcal{N}\mathbb{V}(A; I \triangleleft I) \\ \varphi_2 &: \mathcal{N}\mathbb{V}(A; N \otimes N) \xrightarrow{\cong} \mathcal{N}\mathbb{V}(A; N) \\ \varphi_0 &: \mathcal{N}\mathbb{V}(A; I) \xrightarrow{id} \mathcal{N}\mathbb{V}(A; N) \end{aligned}$$

This has shown that the resulting category is also a *normal* produoidal category.  $\square$

**Proposition E.2.** *Normalization extends to a endofunctor of produoidal categories  $\mathcal{N} : \mathbf{Produo} \rightarrow \mathbf{Produo}$ .*

*Proof.* Let  $\mathbb{V}_{\otimes, I, \triangleleft, N}$  and  $\mathbb{W}_{\otimes, J, \triangleleft, M}$  be produoidal categories.  $\mathcal{N}$  sends  $\mathbb{V}$  to its normalization  $\mathcal{N}\mathbb{V}$ . Let  $(F, F_{\otimes}, F_I, F_{\triangleleft}, F_N) : \mathbb{V} \rightarrow \mathbb{W}$  be a produoidal functor. Then  $\mathcal{N}F : \mathcal{N}\mathbb{V} \rightarrow \mathcal{N}\mathbb{W}$  has underlying functor defined by  $F$  on objects and on morphisms by

$$\begin{aligned} & \mathbb{V}(A; N \otimes B \otimes N) &&= \text{(by definition)} \\ & \int^{X, Y \in \mathbb{V}} \mathbb{V}(A; X \otimes B \otimes Y) \times \mathbb{V}(X; N) \times \mathbb{V}(Y; N) &&\rightarrow \text{(induced by } F_{\otimes}, F_N) \\ & \int^{X, Y \in \mathbb{V}} \mathbb{W}(FA; FX \otimes FB \otimes FY) \times \mathbb{W}(FX; M) \times \mathbb{W}(FY; M) &&\rightarrow \text{(inclusion, universal prop. of coend)} \\ & \int^{P, Q \in \mathbb{W}} \mathbb{W}(FA; P \otimes FB \otimes Q) \times \mathbb{W}(P; M) \times \mathbb{W}(Q; M) &&= \text{(by definition)} \\ & \mathbb{W}(FA; M \otimes FB \otimes M). \end{aligned}$$

$\mathcal{N}F_{\otimes}$  and  $\mathcal{N}F_{\triangleleft}$  are defined similarly, and  $\mathcal{N}F_N$  is  $F_N$ . We have  $\mathcal{N}\mathbf{Id}_{\mathbb{V}} = \mathbf{Id}_{\mathcal{N}\mathbb{V}}$ , since all the data of the left hand side is given by identity maps on  $\mathcal{N}\mathbb{V}$ , and if  $G : \mathbb{U} \rightarrow \mathbb{V}$  is another produoidal functor, then  $\mathcal{N}(G \circ F) = \mathcal{N}G \circ \mathcal{N}F$  follows from the naturality of the components of  $F$  and  $G$ .  $\square$

**Theorem E.3** (From Theorem 5.3). *The functor  $\mathcal{N} : \mathbf{Produo} \rightarrow \mathbf{Produo}$  from Proposition E.2 is an idempotent monad.*

*Proof.* Let  $\mathbb{V}_{\otimes, I, \triangleleft, N}$  be a produoidal category and let  $\triangleleft_N, \otimes_N, N$  denote the sequential splits, parallel splits, and unit in its normalization  $\mathcal{N}\mathbb{V}$ .

The monad has unit  $\eta$  with component at  $\mathbb{V}$  the following produoidal functor  $\eta_{\mathbb{V}} : \mathbb{V} \rightarrow \mathcal{N}\mathbb{V}$ . The underlying functor is the functor induced by the promonad [Rom22, Lemma 3.8]: it is identity on objects, and acts on morphisms by the unit of the promonad. The following components of the produoidal functor preserve laxators and coherence maps since they are constructed only from laxators and coherence maps.

$$\begin{aligned} \eta_{\otimes} &: \mathbb{V}(A; B \otimes C) \xrightarrow{\lambda, \rho} \mathbb{V}(A; I \otimes B \otimes I \otimes C \otimes I) \xrightarrow{\varphi_0} \mathbb{V}(A; N \otimes B \otimes N \otimes C \otimes N), \\ \eta_I &: \mathbb{V}(A; I) \xrightarrow{\varphi_0} \mathbb{V}(A; N), \\ \eta_{\triangleleft} &: \mathbb{V}(A; B \triangleleft C) \xrightarrow{\lambda, \rho} \mathbb{V}(A; (I \otimes B \otimes I) \triangleleft (I \otimes C \otimes I)) \xrightarrow{\varphi_0} \mathbb{V}(A; (N \otimes B \otimes N) \triangleleft (N \otimes C \otimes N)), \\ \eta_N &: \mathbb{V}(A; N) \xrightarrow{\text{id}} \mathbb{V}(A; N). \end{aligned}$$

The monad has multiplication  $\mu$  with component at  $\mathbb{V}$  the following isomorphism  $\mu_{\mathbb{V}} : \mathcal{N}\mathcal{N}\mathbb{V} \cong \mathcal{N}\mathbb{V}$  of produoidal categories (witnessing that the monad is idempotent). The underlying functor is identity on objects, and acts on morphisms by

$$\mathcal{N}\mathcal{N}\mathbb{V}(A; B) = \mathcal{N}\mathbb{V}(A; N \otimes_N B \otimes_N N) \xrightarrow{\lambda, \rho} \mathcal{N}\mathbb{V}(A; B).$$

The following natural transformations make this a produoidal functor:

$$\begin{aligned} \mu_{\otimes} &: \mathcal{N}\mathcal{N}\mathbb{V}(A; B \otimes_N C) = \mathcal{N}\mathbb{V}(A; N \otimes_N B \otimes_N N \otimes_N C \otimes_N N) \xrightarrow{\lambda, \rho} \mathcal{N}\mathbb{V}(A; B \otimes_N C), \\ \mu_N = \mu_I &: \mathcal{N}\mathcal{N}\mathbb{V}(A; N) = \mathcal{N}\mathbb{V}(A; N), \\ \mu_{\triangleleft} &: \mathcal{N}\mathcal{N}\mathbb{V}(A; B \triangleleft_N C) = \mathcal{N}\mathbb{V}(A; (N \otimes_N B \otimes_N N) \triangleleft_N (N \otimes_N C \otimes_N N)) \xrightarrow{\lambda, \rho} \mathcal{N}\mathbb{V}(A; B \triangleleft_N C). \end{aligned}$$

Finally we verify the monad laws.  $\eta_{\mathcal{N}\mathbb{V}} \circ \mu_{\mathbb{V}}$  is identity on objects and on morphisms applies left and right unitors followed by their inverses, thus has underlying functor equal to the identity. The components of the natural transformations are also identities, since the laxator  $\varphi_0$  is an identity for  $\mathcal{N}\mathbb{V}$ , and they are otherwise composed of unitors followed by their inverses, and similarly for the other unit law (using the unitality coherence equations of Figure 36).  $\mu_{\mathcal{N}\mathbb{V}} \circ \mu_{\mathbb{V}}$  and  $\mathcal{N}\mu_{\mathbb{V}} \circ \mu_{\mathbb{V}}$  are identity on objects and amount to applying left and right unitors twice on morphisms, and similarly for their components.  $\square$

**Lemma E.4.** *A produoidal category  $\mathbb{V}$  has exactly one algebra structure for the normalization monad when it is normal, and none otherwise.*

*Proof.* Let  $(f_{\text{map}}, f_{\otimes}, f_I, f_{\triangleleft}, f_N) : \mathcal{N}\mathbb{V} \rightarrow \mathbb{V}$  be an algebra. This means that the following commutative diagrams with the unit and multiplication of the normalization monad must commute.

$$\begin{array}{ccc} \mathbb{V} & \xrightarrow{\eta} & \mathcal{N}\mathbb{V} \\ & \searrow \text{id} & \downarrow f \\ & & \mathbb{V} \end{array} \qquad \begin{array}{ccc} \mathcal{N}\mathcal{N}\mathbb{V} & \xrightarrow{\mu} & \mathcal{N}\mathbb{V} \\ \mathcal{N}f \downarrow & & \downarrow f \\ \mathcal{N}\mathbb{V} & \xrightarrow{f} & \mathbb{V} \end{array}$$

Now, consider how the laxator  $\psi_0 : \mathbb{V}(\bullet; I) \rightarrow \mathbb{V}(\bullet; N)$  is transported by these maps.



$$\begin{array}{ccccc}
& & \mathbb{V}(\bullet; N) & & \\
& \nearrow \eta_I & \downarrow \text{id} & \searrow f_I & \\
\mathbb{V}(\bullet; I) & & \mathbb{V}(\bullet; N) & & \mathbb{V}(\bullet; I) \\
\downarrow \psi_0 & \nearrow \text{id} & \text{id} & \searrow f_N & \downarrow \psi_0 \\
\mathbb{V}(\bullet; N) & & \mathbb{V}(\bullet; N) & & \mathbb{V}(\bullet; N) \\
& \searrow \text{id} & & \nearrow \text{id} & \\
& & \mathbb{V}(\bullet; N) & & 
\end{array}$$

We conclude that  $\eta_I = \psi_0$ , but also that  $f_N = \text{id}$ . As a consequence,  $\psi_0$  is invertible and  $f_I$  must be its inverse. We have shown that the produoidal category  $\mathbb{V}$  must be normal.

We will now show that this already determines all of the functor  $f$ . We know that  $\eta_{\otimes}, \eta_{\triangleleft}, \eta_{\text{map}}$  are isomorphisms because they are constructed from the unitors, associators, and the laxator  $\psi_0$ , which is an isomorphism in this case. This determines that  $f_{\otimes}, f_{\triangleleft}, f_{\text{map}}$  must be their inverses. By construction, these satisfy all coherence morphisms.  $\square$

**Theorem E.5** (From Theorem 5.4). *Normalization determines an adjunction between produoidal categories and normal produoidal categories,*

$$\mathcal{N} : \mathbf{Produo} \rightleftarrows \mathbf{nProduo} : \mathcal{U}$$

That is,  $\mathcal{N}\mathbb{V}$  is the free normal produoidal category over  $\mathbb{V}$ .

*Proof.* We know that the algebras for the normalization monad are exactly the normal produoidal categories (Lemma E.4). We also know that the normalization monad is idempotent (Theorem 5.3). This implies that the forgetful functor from its category of algebras is fully faithful, and thus, the algebra morphisms are exactly the produoidal functors. As a consequence, the canonical adjunction to the category of algebras of the monad is exactly an adjunction to the category of normal produoidal categories.  $\square$

## E.2 Symmetric Normalization

**Theorem E.6** (From Theorem 5.6). *Let  $\mathbb{V}_{\otimes, I, \triangleleft, N}$  be a symmetric produoidal category. The profunctor  $\mathcal{N}_{\sigma}\mathbb{V}(\bullet; \bullet) = \mathbb{V}(\bullet; N \otimes \bullet)$  forms a promonad. Moreover, the Kleisli category of this promonad is a normal symmetric produoidal category with the following sequential and parallel splits and units.*

$$\begin{aligned}
\mathcal{N}_{\sigma}\mathbb{V}(A; B) &= \mathbb{V}(A; N \otimes B); \\
\mathcal{N}_{\sigma}\mathbb{V}(A; B \otimes_N C) &= \mathbb{V}(A; N \otimes B \otimes C); \\
\mathcal{N}_{\sigma}\mathbb{V}(A; B \triangleleft_N C) &= \mathbb{V}(A; (N \otimes B) \triangleleft (N \otimes C)); \\
\mathcal{N}_{\sigma}\mathbb{V}(A; N) &= \mathbb{V}(A; N); \\
\mathcal{N}_{\sigma}\mathbb{V}(A; I) &= \mathbb{V}(A; N).
\end{aligned}$$

*Proof.* The unit and multiplication of the promonad are given in essentially the same way as in the proof of Theorem E.1. Likewise the associators, unitors and laxators of  $\mathcal{N}_{\sigma}\mathbb{V}$  are given in essentially the same way, though one must use the fact that  $\mathbb{V}$  is symmetric. We need additionally a symmetry natural isomorphism for  $\mathcal{N}_{\sigma}\mathbb{V}$ . Its components are defined by,

$$\begin{aligned}
\mathcal{N}_{\sigma}\mathbb{V}(A; B \otimes C) &= \text{(by definition)} \\
\mathbb{V}(A; N \otimes B \otimes C) &\cong \text{(by associativity)} \\
\int^{X \in \mathbb{V}} \mathbb{V}(A; N \otimes X) \times \mathbb{V}(X; B \otimes C) &\cong \text{(by symmetry of } \mathbb{V}) \\
\int^{X \in \mathbb{V}} \mathbb{V}(A; N \otimes X) \times \mathbb{V}(X; C \otimes B) &\cong \text{(by associativity)} \\
\mathbb{V}(A; N \otimes C \otimes B) &= \text{(by definition)}
\end{aligned}$$

$$\mathcal{N}_\sigma \mathbb{V}(A; C \otimes B).$$

These satisfy hexagon and symmetry identities because these are satisfied by  $\mathbb{V}$ , and we only use symmetries and coherences of  $\mathbb{V}$ . Thus we have a normal symmetric produoidal category  $\mathcal{N}_\sigma \mathbb{V}$ .  $\square$

**Definition E.7** (Symmetric produoidal functor). A *symmetric produoidal functor* is a produoidal functor  $F: \mathbb{V} \rightarrow \mathbb{W}$  that moreover preserves the symmetry, in that  $F_\otimes \circ \sigma_{\mathbb{V}} = \sigma_{\mathbb{W}} \circ F_\otimes$ . We denote by **SymProduo** the category of symmetric produoidal categories and symmetric produoidal functors.

**Proposition E.8.** *Symmetric normalization extends to a endofunctor of symmetric produoidal categories*  $\mathcal{N}_\sigma: \mathbf{SymProduo} \rightarrow \mathbf{SymProduo}$ .

*Proof.* The construction is essentially the same as in Proposition E.2. The only thing left to check is that  $\mathcal{N}_\sigma F$  there constructed preserves symmetries whenever  $F$  does (see Theorem E.6). This is because the symmetry of  $\mathcal{N}_\sigma \mathbb{V}$  is constructed out of associativity and symmetries of  $\mathbb{V}$ , which  $\mathcal{N}_\sigma F_\otimes$ , constructed itself out of  $F_\otimes$ , associativity, and symmetries of  $\mathbb{V}$ , must preserve.  $\square$

**Theorem E.9.** *The functor  $\mathcal{N}_\sigma: \mathbf{SymProduo} \rightarrow \mathbf{SymProduo}$  from Proposition E.2 is an idempotent monad.*

*Proof.* The construction is again essentially the same as in Theorem E.3. It is left to check that the unit and multiplication constructed in this way preserve the symmetries. Indeed,  $\eta_\sigma: \mathbb{V} \rightarrow \mathcal{N}_\sigma \mathbb{V}$  is symmetric produoidal because  $\eta_\otimes$  is constructed out of natural associators and laxators that commute with the symmetry.  $\square$

**Lemma E.10.** *A symmetric produoidal category  $\mathbb{V}$  has exactly one algebra structure for the symmetric normalization monad when it is normal, and none otherwise.*

*Proof.* The proof essentially follows the same reasoning as Lemma E.4, replacing the construction with the symmetric version and the previous lemmas.  $\square$

**Theorem E.11** (From Theorem 5.7). *Symmetric normalization determines an adjunction between symmetric produoidal categories and normal symmetric produoidal categories,*

$$\mathcal{N}_\sigma: \mathbf{SymProduo} \rightleftarrows \mathbf{nSymProduo}: \mathcal{U}$$

Where we define the category of normal symmetric produoidal categories, **nSymProduo**, to use as functors the symmetric produoidal functors, acquiring a full forgetful functor  $\mathcal{U}$ .

That is,  $\mathcal{N}_\sigma \mathbb{V}$  is the free symmetric normal produoidal category over the symmetric produoidal category  $\mathbb{V}$ .

*Proof.* The proof essentially follows Theorem E.5, now using the previous lemmas and Lemma E.10.  $\square$

### E.3 Normalization of duoidal and normalization of produoidals

We conjecture that the normalization of a produoidal category could still be seen to arise from the normalization procedure for duoidal categories outlined by Garner and López Franco [GF16]. Every produoidal category  $\mathbb{V}$  induces a closed duoidal structure on its presheaf category  $\hat{\mathbb{V}} := [\mathbb{V}^{\text{op}}, \mathbf{Set}]$ : indeed, by a result of Day, any promonoidal structure induces a closed monoidal structure on the presheaf category [Day70b], [Day70a]; furthermore, one can confirm that the two closed monoidal structures on  $\hat{\mathbb{V}}$  interact in such a way as to make the category duoidal (Theorem I.6).

Normalizing the duoidal  $\hat{\mathbb{V}}$  yields the category of algebras  $\mathbf{EM}(\mathcal{N}\mathbb{V})$  for the promonad  $\mathcal{N}\mathbb{V}$  – or, equivalently, the category of algebras for the cocontinuous monad induced by  $\mathcal{N}\mathbb{V}$  on  $\hat{\mathbb{V}}$ .  $\mathbf{EM}(\mathcal{N}\mathbb{V})$  is now normal duoidal, and furthermore the closure of the tensors on  $\hat{\mathbb{V}}$  carries across to make  $\mathbf{EM}(\mathcal{N}\mathbb{V})$  also closed. Now, one notes that we have the following isomorphism  $\mathbf{EM}(\mathcal{N}\mathbb{V}) \cong [\mathcal{N}\mathbb{V}^{\text{op}}, \mathbf{Set}]$ , that is, the category of algebras is the presheaf category of the Kleisli object  $\mathcal{N}\mathbb{V}$  of the promonad in **Prof**. Therefore, the closed monoidal structures of  $\mathbf{EM}(\mathcal{N}\mathbb{V})$  must correspond to promonoidal structures of  $\mathcal{N}\mathbb{V}$  and these interact so as to make  $\mathcal{N}\mathbb{V}$  produoidal.

APPENDIX F  
MONOIDAL CONTEXT

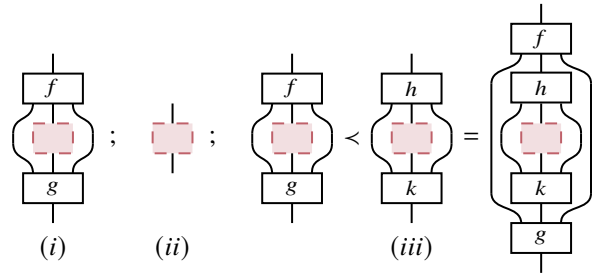

Fig. 29: Generic monoidal context (i), identity (ii) and composition (iii).

*Remark F.1* (Algebra of monoidal contexts). We explicitly state all the operations that form the normal produoidal algebra of monoidal contexts. We do so using 1-dimensional notation for compactness, but we do believe the conceptual picture is clearer when they are translated into 2-dimensional string diagrams.

(Identity)

$$(\text{id}_A \mathbin{\text{;}} \blacksquare \mathbin{\text{;}} \text{id}_B)$$

(Composition)

$$(f \mathbin{\text{;}} (\text{id}_M \otimes \blacksquare \otimes \text{id}_N) \mathbin{\text{;}} g) < (h \mathbin{\text{;}} (\text{id}_P \otimes \blacksquare \otimes \text{id}_Q) \mathbin{\text{;}} k) = \\ (f \mathbin{\text{;}} (\text{id}_M \otimes h \otimes \text{id}_N) \mathbin{\text{;}} (\text{id}_{M \otimes P} \otimes \blacksquare \otimes \text{id}_{Q \otimes N}) \mathbin{\text{;}} (\text{id}_M \otimes k \otimes \text{id}_N) \mathbin{\text{;}} g),$$

(Unit action)

$$(f \mathbin{\text{;}} (\text{id}_M \otimes \blacksquare \otimes \text{id}_N) \mathbin{\text{;}} g) < h = f \mathbin{\text{;}} (\text{id}_M \otimes h \otimes \text{id}_N) \mathbin{\text{;}} g,$$

(Seq. split first action)

$$(f \mathbin{\text{;}} (\text{id}_M \otimes \blacksquare \otimes \text{id}_N) \mathbin{\text{;}} g \mathbin{\text{;}} (\text{id}_K \otimes \blacksquare \otimes \text{id}_L) \mathbin{\text{;}} h) <_1 (u \mathbin{\text{;}} (\text{id}_P \otimes \blacksquare \otimes \text{id}_Q) \mathbin{\text{;}} v) = \\ f \mathbin{\text{;}} (\text{id}_M \otimes u \otimes \text{id}_N) \mathbin{\text{;}} (\text{id}_{M \otimes P} \otimes \blacksquare \otimes \text{id}_{Q \otimes N}) \mathbin{\text{;}} (\text{id}_M \otimes v \otimes \text{id}_N) \mathbin{\text{;}} g \mathbin{\text{;}} (\text{id}_K \otimes \blacksquare \otimes \text{id}_L) \mathbin{\text{;}} h,$$

(Seq. split second action)

$$(f \mathbin{\text{;}} (\text{id}_M \otimes \blacksquare \otimes \text{id}_N) \mathbin{\text{;}} g \mathbin{\text{;}} (\text{id}_K \otimes \blacksquare \otimes \text{id}_L) \mathbin{\text{;}} h) <_2 (u \mathbin{\text{;}} (\text{id}_P \otimes \blacksquare \otimes \text{id}_Q) \mathbin{\text{;}} v) = \\ f \mathbin{\text{;}} (\text{id}_M \otimes \blacksquare \otimes \text{id}_N) \mathbin{\text{;}} g \mathbin{\text{;}} (\text{id}_K \otimes u \otimes \text{id}_L) \mathbin{\text{;}} (\text{id}_{K \otimes P} \otimes \blacksquare \otimes \text{id}_{Q \otimes L}) \mathbin{\text{;}} (\text{id}_K \otimes v \otimes \text{id}_L) \mathbin{\text{;}} h,$$

(Seq. split third action)

$$(f \mathbin{\text{;}} (\text{id}_M \otimes \blacksquare \otimes \text{id}_N) \mathbin{\text{;}} g) < (u \mathbin{\text{;}} (\text{id}_P \otimes \blacksquare \otimes \text{id}_Q) \mathbin{\text{;}} v \mathbin{\text{;}} (\text{id}_R \otimes \blacksquare \otimes \text{id}_S) \mathbin{\text{;}} w) = \\ f \mathbin{\text{;}} (\text{id}_M \otimes u \otimes \text{id}_N) \mathbin{\text{;}} (\text{id}_{M \otimes P} \otimes \blacksquare \otimes \text{id}_{Q \otimes N}) \mathbin{\text{;}} (\text{id}_M \otimes v \otimes \text{id}_N) \mathbin{\text{;}} (\text{id}_{M \otimes R} \otimes \blacksquare \otimes \text{id}_{S \otimes N}) \\ \mathbin{\text{;}} (\text{id}_M \otimes w \otimes \text{id}_N) \mathbin{\text{;}} g,$$

(Seq. left associativity)

$$(f \mathbin{\text{;}} (\text{id}_M \otimes \blacksquare \otimes \text{id}_N) \mathbin{\text{;}} g \mathbin{\text{;}} (\text{id}_K \otimes \blacksquare \otimes \text{id}_L) \mathbin{\text{;}} h) <_1^\alpha (u \mathbin{\text{;}} (\text{id}_P \otimes \blacksquare \otimes \text{id}_Q) \mathbin{\text{;}} v \mathbin{\text{;}} (\text{id}_R \otimes \blacksquare \otimes \text{id}_S) \mathbin{\text{;}} w) = \\ f \mathbin{\text{;}} (\text{id}_M \otimes u \otimes \text{id}_N) \mathbin{\text{;}} (\text{id}_{M \otimes P} \otimes \blacksquare \otimes \text{id}_{Q \otimes N}) \mathbin{\text{;}} (\text{id}_M \otimes v \otimes \text{id}_N) \mathbin{\text{;}} (\text{id}_{M \otimes R} \otimes \blacksquare \otimes \text{id}_{S \otimes N}) \\ \mathbin{\text{;}} (\text{id}_M \otimes w \otimes \text{id}_N) \mathbin{\text{;}} g \mathbin{\text{;}} (\text{id}_K \otimes \blacksquare \otimes \text{id}_L) \mathbin{\text{;}} h,$$

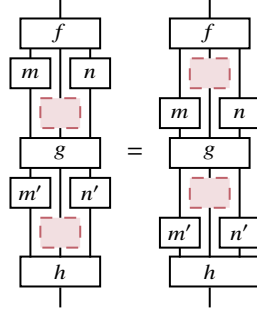

Fig. 30: Dinaturality of sequential splits of monoidal contexts.

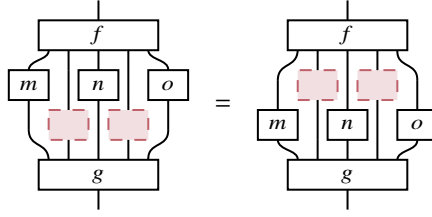

Fig. 31: Parallel splits for monoidal contexts.

(Seq. right associativity)

$$(f \circledast (\text{id}_M \otimes \blacksquare \otimes \text{id}_N) \circledast g \circledast (\text{id}_K \otimes \blacksquare \otimes \text{id}_L) \circledast h) <_2^\alpha (u \circledast (\text{id}_P \otimes \blacksquare \otimes \text{id}_Q) \circledast v \circledast (\text{id}_R \otimes \blacksquare \otimes \text{id}_S) \circledast w) = \\ f \circledast (\text{id}_M \otimes \blacksquare \otimes \text{id}_N) \circledast g \circledast (\text{id}_K \otimes u \otimes \text{id}_L) \circledast (\text{id}_{K \otimes P} \otimes \blacksquare \otimes \text{id}_{R \otimes L}) \circledast (\text{id}_K \otimes v \otimes \text{id}_L) \\ \circledast (\text{id}_{K \otimes R} \otimes \blacksquare \otimes \text{id}_{S \otimes L}) \circledast (\text{id}_L \otimes w \otimes \text{id}_L) \circledast h,$$

(Seq. left unitor)

$$(f \circledast (\text{id}_M \otimes \blacksquare \otimes \text{id}_N) \circledast g \circledast (\text{id}_K \otimes \blacksquare \otimes \text{id}_L) \circledast h) <^\lambda u = \\ f \circledast (\text{id}_M \otimes u \otimes \text{id}_N) \circledast g \circledast (\text{id}_K \otimes \blacksquare \otimes \text{id}_L) \circledast h,$$

(Seq. right unitor)

$$(f \circledast (\text{id}_M \otimes \blacksquare \otimes \text{id}_N) \circledast g \circledast (\text{id}_K \otimes \blacksquare \otimes \text{id}_L) \circledast h) <^p u = \\ f \circledast (\text{id}_M \otimes \blacksquare \otimes \text{id}_N) \circledast g \circledast (\text{id}_K \otimes u \otimes \text{id}_L) \circledast h,$$

(Par. split first action)

$$(f \circledast (\text{id}_M \otimes \blacksquare \otimes \text{id}_N \otimes \blacksquare \otimes \text{id}_O) \circledast g) <_1 (u \circledast (\text{id}_P \otimes \blacksquare \otimes \text{id}_Q) \circledast v) = \\ f \circledast (\text{id}_M \otimes u \otimes \text{id}_{N \otimes X' \otimes O}) \circledast (\text{id}_{M \otimes P} \otimes \blacksquare \otimes \text{id}_{Q \otimes N} \otimes \blacksquare \otimes \text{id}_O) \circledast (\text{id}_M \otimes v \otimes \text{id}_{N \otimes Y' \otimes O}) \circledast g,$$

(Par. split second action)

$$(f \circledast (\text{id}_M \otimes \blacksquare \otimes \text{id}_N \otimes \blacksquare \otimes \text{id}_O) \circledast g) <_2 (u \circledast (\text{id}_P \otimes \blacksquare \otimes \text{id}_Q) \circledast v) = \\ f \circledast (\text{id}_{M \otimes X \otimes N} \otimes u \otimes \text{id}_O) \circledast (\text{id}_M \otimes \blacksquare \otimes \text{id}_{N \otimes P} \otimes \blacksquare \otimes \text{id}_{O \otimes Q}) \circledast (\text{id}_{M \otimes Y \otimes N} \otimes v \otimes \text{id}_O) \circledast g,$$

(Par. split third action)

$$(f \circledast (\text{id}_M \otimes \blacksquare \otimes \text{id}_N) \circledast g) < (u \circledast (\text{id}_P \otimes \blacksquare \otimes \text{id}_Q \otimes \blacksquare \otimes \text{id}_R) \circledast v) = \\ f \circledast (\text{id}_M \otimes u \otimes \text{id}_N) \circledast (\text{id}_{M \otimes P} \otimes \blacksquare \otimes \text{id}_Q \otimes \blacksquare \otimes \text{id}_{R \otimes N}) \circledast (\text{id}_M \otimes w \otimes \text{id}_N) \circledast g,$$

(Par. left associativity)

$$(f \circledast (\text{id}_M \otimes \blacksquare \otimes \text{id}_N \otimes \blacksquare \otimes \text{id}_O) \circledast g) \prec_1^\alpha (u \circledast (\text{id}_P \otimes \blacksquare \otimes \text{id}_Q \otimes \blacksquare \otimes \text{id}_R) \circledast v) = \\ f \circledast (\text{id}_M \otimes u \otimes \text{id}_{N \otimes X \otimes O}) \circledast (\text{id}_{M \otimes P} \otimes \blacksquare \otimes \text{id}_Q \otimes \blacksquare \otimes \text{id}_{R \otimes N} \otimes \blacksquare \otimes \text{id}_O) \\ \circledast (\text{id}_M \otimes v \otimes \text{id}_{N \otimes Y \otimes O}) \circledast g,$$

(Par. right associativity)

$$(f \circledast (\text{id}_M \otimes \blacksquare \otimes \text{id}_N \otimes \blacksquare \otimes \text{id}_O) \circledast g) \prec_2^\alpha (u \circledast (\text{id}_P \otimes \blacksquare \otimes \text{id}_Q \otimes \blacksquare \otimes \text{id}_R) \circledast v) = \\ f \circledast (\text{id}_{M \otimes X \otimes N} \otimes u \otimes \text{id}_O) \circledast (\text{id}_M \otimes \blacksquare \otimes \text{id}_{N \otimes P} \otimes \blacksquare \otimes \text{id}_Q \otimes \blacksquare \otimes \text{id}_{R \otimes O}) \\ \circledast (\text{id}_{M \otimes Y \otimes N} \otimes v \otimes \text{id}_O) \circledast g,$$

(Par. left unitor)

$$(f \circledast (\text{id}_M \otimes \blacksquare \otimes \text{id}_N \otimes \blacksquare \otimes \text{id}_O) \circledast g) \prec^\lambda u = \\ f \circledast (\text{id}_M \otimes u \otimes \text{id}_{N \otimes X' \otimes O}) \circledast (\text{id}_{M \otimes Y \otimes N} \otimes \blacksquare \otimes \text{id}_O) \circledast g = \\ f \circledast (\text{id}_{M \otimes Y \otimes N} \otimes \blacksquare \otimes \text{id}_O) \circledast (\text{id}_M \otimes u \otimes \text{id}_{N \otimes X' \otimes O}) \circledast g,$$

(Par. right unitor)

$$(f \circledast (\text{id}_M \otimes \blacksquare \otimes \text{id}_N \otimes \blacksquare \otimes \text{id}_O) \circledast g) \prec^\rho v = \\ f \circledast (\text{id}_{M \otimes X \otimes N} \otimes v \otimes \text{id}_O) \circledast (\text{id}_M \otimes \blacksquare \otimes \text{id}_{N \otimes Y' \otimes O}) \circledast g = \\ f \circledast (\text{id}_M \otimes \blacksquare \otimes \text{id}_{N \otimes Y' \otimes O}) \circledast (\text{id}_{M \otimes X \otimes N} \otimes v \otimes \text{id}_O) \circledast g,$$

(Laxator, left side)

$$(f \circledast (\text{id}_M \otimes \blacksquare \otimes \text{id}_N \otimes \blacksquare \otimes \text{id}_O) \circledast g) \\ < \psi_1 (j_0 \circledast (\text{id}_U \otimes \blacksquare \otimes \text{id}_V) \circledast j_1 \circledast (\text{id}_{U'} \otimes \blacksquare \otimes \text{id}_{V'}) \circledast j_2) \\ < \psi_2 (k_0 \circledast (\text{id}_W \otimes \blacksquare \otimes \text{id}_T) \circledast k_1 \circledast (\text{id}_{W'} \otimes \blacksquare \otimes \text{id}_{T'}) \circledast k_2) = \\ f \circledast (\text{id}_M \otimes j_0 \otimes \text{id}_N \otimes k_0 \otimes \text{id}_O) \circledast (\text{id}_{M \otimes U} \otimes \blacksquare \otimes \text{id}_{V \otimes N \otimes U'} \otimes \blacksquare \otimes \text{id}_{V' \otimes O}) \\ \circledast (\text{id}_M \otimes j_1 \otimes \text{id}_N \otimes k_1 \otimes \text{id}_O) \circledast (\text{id}_{M \otimes W} \otimes \blacksquare \otimes \text{id}_{T \otimes N \otimes W'} \otimes \blacksquare \otimes \text{id}_{T' \otimes O}) \\ \circledast (\text{id}_M \otimes j_2 \otimes \text{id}_N \otimes k_2 \otimes \text{id}_O) \circledast g,$$

(Laxator, right side)

$$(f \circledast (\text{id}_M \otimes \blacksquare \otimes \text{id}_N) \circledast g \circledast (\text{id}_K \otimes \blacksquare \otimes \text{id}_L) \circledast h) \\ < \psi_1 (j_0 \circledast (\text{id}_P \otimes \blacksquare \otimes \text{id}_Q \otimes \blacksquare \otimes \text{id}_R) \circledast j_1) \\ < \psi_2 (k_0 \circledast (\text{id}_{P'} \otimes \blacksquare \otimes \text{id}_{Q'} \otimes \blacksquare \otimes \text{id}_{R'}) \circledast k_1) = \\ f \circledast (\text{id}_M \otimes j_0 \otimes \text{id}_N) \circledast (\text{id}_{M \otimes P} \otimes \blacksquare \otimes \text{id}_Q \otimes \blacksquare \otimes \text{id}_{R \otimes N}) \\ \circledast (\text{id}_M \otimes j_1 \otimes \text{id}_N) \circledast g \circledast (\text{id}_K \otimes k_0 \otimes \text{id}_L) \circledast (\text{id}_{K \otimes P'} \otimes \blacksquare \otimes \text{id}_{Q'} \otimes \blacksquare \otimes \text{id}_{R' \otimes L}) \\ \circledast (\text{id}_K \otimes k_1 \otimes \text{id}_L) \circledast h.$$

*Remark F.2.* In the following derivations, we understand that an isolated ( $\blacksquare$ ) actually means  $(\text{id}_I \otimes \blacksquare \otimes \text{id}_I)$ .

**Proposition F.3** (From Proposition 6.2). *Monoidal contexts form a category. Composition of monoidal contexts is associative and unital.*

*Proof.* We first check that the composition of monoidal contexts is associative.

$$((f \circledast (\text{id}_M \otimes \blacksquare \otimes \text{id}_N) \circledast g) \circledast (f' \circledast (\text{id}_{M'} \otimes \blacksquare \otimes \text{id}_{N'}) \circledast g')) \circledast (f'' \circledast (\text{id}_{M''} \otimes \blacksquare \otimes \text{id}_{N''}) \circledast g'') =$$

$$\begin{aligned}
& (f \circledast (\text{id}_M \otimes f' \otimes \text{id}_N) \circledast (\text{id}_{M \otimes M'} \otimes \blacksquare \otimes \text{id}_{N' \otimes N}) \circledast (\text{id}_M \otimes g' \otimes \text{id}_N) \circledast g) < \\
& \quad (f'' \circledast (\text{id}_{M''} \otimes \blacksquare \otimes \text{id}_{N''}) \circledast g'') \quad = \\
& f \circledast (\text{id}_M \otimes f' \otimes \text{id}_N) \circledast (\text{id}_{M \otimes M'} \otimes f'' \otimes \text{id}_{N \otimes N'}) \\
& \quad \circledast (\text{id}_{M \otimes M' \otimes M''} \otimes \blacksquare \otimes \text{id}_{N'' \otimes N' \otimes N}) \circledast (\text{id}_{M \otimes M'} \otimes g'' \otimes \text{id}_{N' \otimes N}) \circledast (\text{id}_N \otimes g' \otimes \text{id}_N) \circledast g \quad = \\
& f \circledast (\text{id}_M \otimes (f' \circledast (\text{id}_{M'} \otimes f'' \otimes \text{id}_{N'})) \otimes \text{id}_N) \\
& \quad \circledast (\text{id}_{M \otimes M' \otimes M''} \otimes \blacksquare \otimes \text{id}_{N'' \otimes N' \otimes N}) \circledast (\text{id}_M \otimes ((\text{id}_{M'} \otimes g'' \otimes \text{id}_{N'}) \circledast g') \otimes \text{id}_N) \circledast g \quad = \\
& (f \circledast (\text{id}_M \otimes \blacksquare \otimes \text{id}_N) \circledast g) < (f' \circledast (\text{id}_{M'} \otimes f'' \otimes \text{id}_{N'})) \circledast \\
& \quad (\text{id}_{M' \otimes M''} \otimes \blacksquare \otimes \text{id}_{N'' \otimes N'}) \circledast (\text{id}_{M'} \otimes g'' \otimes \text{id}_{N'}) \circledast g' \quad = \\
& (f \circledast (\text{id}_M \otimes \blacksquare \otimes \text{id}_N) \circledast g) < ((f' \circledast (\text{id}_{M'} \otimes \blacksquare \otimes \text{id}_{N'})) \circledast g') < (f'' \circledast (\text{id}_{M''} \otimes \blacksquare \otimes \text{id}_{N''}) \circledast g'')
\end{aligned}$$

We now check left unitality of the identities,

$$\begin{aligned}
& (f \circledast (\text{id}_M \otimes \blacksquare \otimes \text{id}_N) \circledast g) < (\text{id}_X \circledast (\text{id}_I \otimes \blacksquare \otimes \text{id}_I) \circledast \text{id}_Y) \quad = \\
& \quad (f \circledast (\text{id}_M \otimes \text{id}_X \otimes \text{id}_N) \circledast (\text{id}_M \otimes \blacksquare \otimes \text{id}_N) \circledast (\text{id}_M \otimes \text{id}_X \otimes \text{id}_N) \circledast g) \quad = \\
& \quad (f \circledast (\text{id}_M \otimes \blacksquare \otimes \text{id}_N) \circledast g),
\end{aligned}$$

and right unitality,

$$\begin{aligned}
& (\text{id}_A \circledast (\text{id}_I \otimes \blacksquare \otimes \text{id}_I) \circledast \text{id}_B) < (f \circledast (\text{id}_M \otimes \blacksquare \otimes \text{id}_N) \circledast g) \quad = \\
& \quad (\text{id}_A \circledast (\text{id}_I \otimes f \otimes \text{id}_I) \circledast (\text{id}_M \otimes \blacksquare \otimes \text{id}_N) \circledast (\text{id}_I \otimes g \otimes \text{id}_I) \circledast \text{id}_B) \quad = \\
& \quad (f \circledast (\text{id}_M \otimes \blacksquare \otimes \text{id}_N) \circledast g).
\end{aligned}$$

This concludes the proof.  $\square$

**Proposition F.4** (From Proposition 6.5). *The category of monoidal contexts forms a normal produoidal category with its units, sequential and parallel splits.*

*Proof.* Lemmas F.5 to F.7 construct the associators and unitors for the sequential promonoidal structure, and Lemmas F.8 to F.10 define the associators and unitors for the parallel promonoidal structure. As they are all constructed with Yoneda isomorphisms, they must satisfy the coherence equations. Lemma F.11 defines the laxators, again using only Yoneda isomorphisms and composition in  $\mathbb{C}$ . For concision, our proofs freely elide the tensor product of objects, writing  $XY$  for  $X \otimes Y$ .  $\square$

**Lemma F.5** (Monoidal contexts sequential associator). *We construct a natural isomorphism*

$$\langle \cdot \rangle_2^\alpha : \int_{V \in \text{MC}} \text{MC} \left( \begin{matrix} A \\ B \\ Y \end{matrix} ; \begin{matrix} X \\ Y \end{matrix} \triangleleft V \right) \times \text{MC} \left( \begin{matrix} U \\ V \\ Y'' \end{matrix} ; \begin{matrix} X' \\ Y' \end{matrix} \triangleleft Y'' \right) \cong \int_{V \in \text{MC}} \text{MC} \left( \begin{matrix} A \\ B \\ V \end{matrix} ; \begin{matrix} U \\ Y \end{matrix} \triangleleft Y'' \right) \times \text{MC} \left( \begin{matrix} U \\ V \\ Y' \end{matrix} ; \begin{matrix} X \\ Y' \end{matrix} \triangleleft Y' \right) : \langle \cdot \rangle_1^\alpha,$$

satisfying the coherence equations of produoidal categories. This isomorphism is defined on representatives of the equivalence class as

$$\begin{aligned}
& (f_0 \circledast (\text{id} \otimes \blacksquare \otimes \text{id}) \circledast f_1 \circledast (\text{id} \otimes \blacksquare \otimes \text{id}) \circledast f_2) <_2^\alpha (g_0 \circledast (\text{id} \otimes \blacksquare \otimes \text{id}) \circledast g_1 \circledast (\text{id} \otimes \blacksquare \otimes \text{id}) \circledast g_2) = \\
& ((h_0 \circledast (\text{id} \otimes \blacksquare \otimes \text{id}) \circledast h_1 \circledast (\text{id} \otimes \blacksquare \otimes \text{id}) \circledast h_2) \mid (k_0 \circledast (\text{id} \otimes \blacksquare \otimes \text{id}) \circledast k_1 \circledast (\text{id} \otimes \blacksquare \otimes \text{id}) \circledast k_2))
\end{aligned}$$

if and only if

$$\begin{aligned}
& f_0 \circledast (\text{id} \otimes \blacksquare \otimes \text{id}) \circledast f_1 \circledast (\text{id} \otimes g_0 \otimes \text{id}) \circledast (\text{id} \otimes \blacksquare \otimes \text{id}) \circledast (\text{id} \otimes g_1 \otimes \text{id}) \circledast (\text{id} \otimes \blacksquare \otimes \text{id}) \circledast (\text{id} \otimes g_2 \otimes \text{id}) \circledast f_2 = \\
& h_0 \circledast (\text{id} \otimes k_0 \otimes \text{id}) \circledast (\text{id} \otimes \blacksquare \otimes \text{id}) \circledast (\text{id} \otimes k_1 \otimes \text{id}) \circledast (\text{id} \otimes \blacksquare \otimes \text{id}) \circledast (\text{id} \otimes k_2 \otimes \text{id}) \circledast h_1 \circledast (\text{id} \otimes \blacksquare \otimes \text{id}) \circledast h_2.
\end{aligned}$$

*Proof.* Firstly, we construct an isomorphism between the left hand side and a set of quadruples of morphisms. This isomorphism sends the pair

$$\begin{aligned}
& (f_0 \circledast (\text{id} \otimes \blacksquare \otimes \text{id}) \circledast f_1 \circledast (\text{id} \otimes \blacksquare \otimes \text{id}) \circledast f_2) \mid (g_0 \circledast (\text{id} \otimes \blacksquare \otimes \text{id}) \circledast g_1 \circledast (\text{id} \otimes \blacksquare \otimes \text{id}) \circledast g_2) \\
& \text{to } (f_0 \circledast (\text{id} \otimes \blacksquare \otimes \text{id}) \circledast f_1 \circledast (\text{id} \otimes g_0 \otimes \text{id}) \circledast (\text{id} \otimes \blacksquare \otimes \text{id}) \circledast g_1 \circledast (\text{id} \otimes \blacksquare \otimes \text{id}) \circledast (\text{id} \otimes g_2 \otimes \text{id}) \circledast f_2).
\end{aligned}$$

The isomorphism is constructed by the following coend derivation.

$$\begin{aligned}
& \int^{U \in \mathcal{MC}} \mathcal{MC} \left( \frac{A}{B}; \frac{X}{Y} \triangleleft \frac{U}{V} \right) \times \mathcal{MC} \left( \frac{U}{V}; \frac{X'}{Y'} \triangleleft \frac{X''}{Y''} \right) && \stackrel{\text{def}}{=} \\
& \int^{U \in \mathcal{MC}, M, N, O, P \in \mathcal{C}} \mathbb{C}(A; MXN) \times \mathbb{C}(MYN; OUP) \times \mathbb{C}(OVP; B) \times \mathcal{MC} \left( \frac{U}{V}; \frac{X'}{Y'} \triangleleft \frac{X''}{Y''} \right) && \stackrel{\text{def}}{=} \\
& \int^{U \in \mathcal{MC}, M, N, O, P, Q, R \in \mathcal{C}} \mathbb{C}(A; MXN) \times \mathcal{MC} \left( \frac{MYN}{B}; \frac{U}{V} \right) \times \mathbb{C}(U; OX'P) \times \mathbb{C}(OY'P; QX''R) \times \mathbb{C}(QY''R; V) && \stackrel{y_2}{\cong} \\
& \int^{M, N, O, P, Q, R \in \mathcal{C}} \mathbb{C}(A; MXN) \times \mathbb{C}(MYN; OX'P) \times \mathbb{C}(OY'P; QX''R) \times \mathbb{C}(QY''R; B).
\end{aligned}$$

Now we construct an isomorphism between the right hand side and the same set of quadruples of morphisms. This isomorphism sends the pair

$$\begin{aligned}
& (h_0 \circ (\text{id} \otimes \blacksquare \otimes \text{id}) \circ h_1 \circ (\text{id} \otimes \blacksquare \otimes \text{id}) \circ h_2) \mid (k_0 \circ (\text{id} \otimes \blacksquare \otimes \text{id}) \circ k_1 \circ (\text{id} \otimes \blacksquare \otimes \text{id}) \circ k_2) \\
\text{to } & (h_0 \circ (\text{id} \otimes k_0 \otimes \text{id}) \circ (\text{id} \otimes \blacksquare \otimes \text{id}) \circ k_1 \circ (\text{id} \otimes \blacksquare \otimes \text{id}) \circ (\text{id} \otimes k_2 \otimes \text{id}) \circ h_1 \circ (\text{id} \otimes \blacksquare \otimes \text{id}) \circ h_2).
\end{aligned}$$

$$\begin{aligned}
& \int^{U \in \mathcal{MC}} \mathcal{MC} \left( \frac{A}{B}; \frac{U}{V} \triangleleft \frac{X''}{Y''} \right) \times \mathcal{MC} \left( \frac{U}{V}; \frac{X}{Y} \triangleleft \frac{X'}{Y'} \right) && \stackrel{\text{def}}{=} \\
& \int^{U \in \mathcal{MC}, M, N, O, P \in \mathcal{C}} \mathbb{C}(A; MUN) \times \mathbb{C}(MVN; OX''P) \times \mathbb{C}(OY''P; B) \times \mathcal{MC} \left( \frac{U}{V}; \frac{X}{Y} \triangleleft \frac{X'}{Y'} \right) && \stackrel{\text{def}}{=} \\
& \int^{U \in \mathcal{MC}, M, N, O, P, Q, R \in \mathcal{C}} \mathcal{MC} \left( \frac{A}{OX''P}; \frac{U}{V} \right) \times \mathbb{C}(OY''P; B) \times \mathbb{C}(U; MXN) \times \mathbb{C}(MYN; QX'R) \times \mathbb{C}(QY'R; V) && \stackrel{y_2}{\cong} \\
& \int^{M, N, O, P, Q, R \in \mathcal{C}} \mathbb{C}(A; MXN) \times \mathbb{C}(MYN; QX'R) \times \mathbb{C}(QY'R; OX''P) \times \mathbb{C}(OY''P; B).
\end{aligned}$$

Composing both isomorphisms, we obtain the desired associator. Since it is composed exclusively from Yoneda isomorphisms, it must satisfy the coherence equations of produoidal categories (Definition I.5).  $\square$

**Lemma F.6** (Monoidal contexts sequential left unitor). *We construct a natural isomorphism*

$$\langle \cdot \rangle^\lambda : \int^{U \in \mathcal{MC}} \mathcal{MC} \left( \frac{A}{B}; \frac{U}{V} \triangleleft \frac{X}{Y} \right) \times \mathcal{MC} \left( \frac{U}{V}; N \right) \cong \mathcal{MC} \left( \frac{A}{B}; \frac{X}{Y} \right),$$

satisfying the coherence equations of produoidal categories. This isomorphism is defined on representatives of the equivalence class as

$$\begin{aligned}
& (f_0 \circ (\text{id}_M \otimes \blacksquare \otimes \text{id}_N) \circ f_1 \circ (\text{id}_K \otimes \blacksquare \otimes \text{id}_L) \circ f_2) \langle \cdot \rangle^\lambda g \\
& f_0 \circ (\text{id}_M \otimes g \otimes \text{id}_N) \circ f_1 \circ (\text{id}_K \otimes \blacksquare \otimes \text{id}_L) \circ f_2.
\end{aligned} =$$

*Proof.* We need to prove that this function is well-defined and does indeed induce an isomorphism after quotienting. We show this by constructing the isomorphism using coend calculus.

$$\begin{aligned}
& \int^{U \in \mathcal{MC}} \mathcal{MC} \left( \frac{A}{B}; \frac{U}{V} \triangleleft \frac{X}{Y} \right) \times \mathcal{MC} \left( \frac{U}{V}; N \right) && \stackrel{\text{def}}{=} \\
& \int^{U \in \mathcal{MC}, P, Q, R, S \in \mathcal{C}} \mathbb{C}(A; PUQ) \times \mathbb{C}(PVQ; RXS) \times \mathbb{C}(RYS; B) \times \mathcal{MC} \left( \frac{U}{V}; N \right) && \stackrel{\text{def}}{=} \\
& \int^{U \in \mathcal{MC}, R, S \in \mathcal{C}} \mathcal{MC} \left( \frac{A}{RXS}; \frac{U}{V} \right) \times \mathbb{C}(RYS; B) \times \mathcal{MC} \left( \frac{U}{V}; N \right) && \stackrel{y_2}{\cong} \\
& \int^{R, S \in \mathcal{C}} \mathbb{C}(A; RXS) \times \mathbb{C}(RYS; B) && \stackrel{\text{def}}{=} \\
& \mathcal{MC} \left( \frac{A}{B}; \frac{X}{Y} \right).
\end{aligned}$$

Since it is composed exclusively from Yoneda isomorphisms, it must satisfy the coherence equations of produoidal categories (Definition I.5).  $\square$

**Lemma F.7** (Monoidal contexts sequential right unitor). *We construct a natural isomorphism*

$$(<^\rho) : \int_{V \in \text{MC}}^U \text{MC} \left( \frac{A}{B}; \frac{X}{Y} \triangleleft \frac{U}{V} \right) \times \text{MC} \left( \frac{U}{V}; N \right) \cong \text{MC} \left( \frac{A}{B}; \frac{X}{Y} \right)$$

satisfying the coherence equations of produoidal categories. This isomorphism is defined on representatives of the equivalence class as

$$\begin{aligned} (f_0 \mathbin{\text{;}} (\text{id}_M \otimes \blacksquare \otimes \text{id}_N) \mathbin{\text{;}} f_1 \mathbin{\text{;}} (\text{id}_K \otimes \blacksquare \otimes \text{id}_L) \mathbin{\text{;}} f_2) <^\rho g &= \\ f_0 \mathbin{\text{;}} (\text{id}_M \otimes \blacksquare \otimes \text{id}_N) \mathbin{\text{;}} f_1 \mathbin{\text{;}} (\text{id}_K \otimes g \otimes \text{id}_L) \mathbin{\text{;}} f_2. & \end{aligned}$$

*Proof.* As above, we do this by coend calculus:

$$\begin{aligned} & \int_{V \in \text{MC}}^U \text{MC} \left( \frac{A}{B}; \frac{X}{Y} \triangleleft \frac{U}{V} \right) \times \text{MC} \left( \frac{U}{V}; N \right) && \stackrel{\text{def}}{=} \\ & \int_{V \in \text{MC}, P, Q, R, S \in \mathbb{C}}^U \mathbb{C}(A; PXQ) \times \mathbb{C}(PYQ; RUS) \times \mathbb{C}(RVS; B) \times \text{MC} \left( \frac{U}{V}; N \right) && \stackrel{\text{def}}{=} \\ & \int_{V \in \text{MC}, P, Q, R, S \in \mathbb{C}}^U \mathbb{C}(A; PXQ) \times \text{MC} \left( \frac{PYQ}{B}; \frac{U}{V} \right) \times \text{MC} \left( \frac{U}{V}; N \right) && \stackrel{\cong}{=} \\ & \int_{R, S \in \mathbb{C}}^R \mathbb{C}(A; RXS) \times \mathbb{C}(RYS; B) && \stackrel{\text{def}}{=} \\ & \text{MC} \left( \frac{A}{B}; \frac{X}{Y} \right). \end{aligned}$$

Since it is composed exclusively from Yoneda isomorphisms, it must satisfy the coherence equations of produoidal categories (Definition I.5).  $\square$

**Lemma F.8** (Monoidal contexts parallel associator). *We construct a natural isomorphism*

$$(<_2^\alpha) : \int_{V \in \text{MC}}^U \text{MC} \left( \frac{A}{B}; \frac{X}{Y} \otimes \frac{U}{V} \right) \times \text{MC} \left( \frac{U}{V}; \frac{X'}{Y'} \otimes \frac{X''}{Y''} \right) \cong \int_{V \in \text{MC}}^U \text{MC} \left( \frac{A}{B}; \frac{U}{V} \otimes \frac{X''}{Y''} \right) \times \text{MC} \left( \frac{U}{V}; \frac{X}{Y} \otimes \frac{X'}{Y'} \right) : (<_1^\alpha)$$

exclusively from Yoneda isomorphisms. This isomorphism is defined on representatives of the equivalence class as

$$\begin{aligned} (f_0 \mathbin{\text{;}} (\text{id} \otimes \blacksquare \otimes \text{id} \otimes \blacksquare \otimes \text{id}) \mathbin{\text{;}} f_1) <_1^\alpha (g_0 \mathbin{\text{;}} (\text{id} \otimes \blacksquare \otimes \text{id} \otimes \blacksquare \otimes \text{id}) \mathbin{\text{;}} g_1) &= \\ (h_0 \mathbin{\text{;}} (\text{id} \otimes \blacksquare \otimes \text{id} \otimes \blacksquare \otimes \text{id}) \mathbin{\text{;}} h_1) \mid (j_0 \mathbin{\text{;}} (\text{id} \otimes \blacksquare \otimes \text{id} \otimes \blacksquare \otimes \text{id}) \mathbin{\text{;}} j_1) & \end{aligned}$$

if and only if

$$\begin{aligned} f_0 \mathbin{\text{;}} (\text{id}_M \otimes g_0 \otimes \text{id}_{N \otimes X \otimes O}) \mathbin{\text{;}} (\text{id}_{M \otimes P} \otimes \blacksquare \otimes \text{id}_Q \otimes \blacksquare \otimes \text{id}_{R \otimes N} \otimes \blacksquare \otimes \text{id}_O) \mathbin{\text{;}} (\text{id}_M \otimes g_1 \otimes \text{id}_{N \otimes Y \otimes O}) \mathbin{\text{;}} f_1 = \\ h_0 \mathbin{\text{;}} (\text{id}_{M \otimes X \otimes N} \otimes j_0 \otimes \text{id}_O) \mathbin{\text{;}} (\text{id}_M \otimes \blacksquare \otimes \text{id}_{N \otimes P} \otimes \blacksquare \otimes \text{id}_Q \otimes \blacksquare \otimes \text{id}_{R \otimes O}) \mathbin{\text{;}} (\text{id}_{M \otimes Y \otimes N} \otimes j_1 \otimes \text{id}_O) \mathbin{\text{;}} h_1, \end{aligned}$$

*Proof.* The left hand side is isomorphic to the following set,

$$\begin{aligned} & \int_{V \in \text{MC}}^U \text{MC} \left( \frac{A}{B}; \frac{X}{Y} \otimes \frac{U}{V} \right) \times \text{MC} \left( \frac{U}{V}; \frac{X'}{Y'} \otimes \frac{X''}{Y''} \right) && \stackrel{\text{def}}{=} \\ & \int_{V \in \text{MC}, M, N, O \in \mathbb{C}}^U \mathbb{C}(A; M \otimes X \otimes N \otimes U \otimes O) \times \mathbb{C}(M \otimes Y \otimes N \otimes V \otimes O; B) \times \text{MC} \left( \frac{U}{V}; \frac{X'}{Y'} \otimes \frac{X''}{Y''} \right) && \stackrel{\cong}{=} \\ & \int_{V \in \text{MC}, M, N, O, P, Q \in \mathbb{C}}^U \mathbb{C}(A; M \otimes X \otimes P) \times \mathbb{C}(P; N \otimes U \otimes O) \times \mathbb{C}(M \otimes Y \otimes Q; B) && \\ & \quad \times \mathbb{C}(N \otimes V \otimes O; Q) \times \text{MC} \left( \frac{U}{V}; \frac{X'}{Y'} \otimes \frac{X''}{Y''} \right) && \stackrel{\text{def}}{=} \end{aligned}$$



$$\begin{aligned}
& \int^{U \in \mathcal{MC}, M, M', N', O', P, Q \in \mathcal{C}} \mathbb{C}(A; M \otimes X \otimes P) \times \mathcal{MC} \left( \begin{smallmatrix} P \\ O \end{smallmatrix}; \begin{smallmatrix} U \\ V \end{smallmatrix} \right) \times \mathbb{C}(M \otimes Y \otimes Q; B) \times \mathbb{C}(U; M' \otimes X' \otimes N' \otimes X'' \otimes O') \\
& \quad \times \mathbb{C}(M' \otimes Y' \otimes N' \otimes Y'' \otimes O'; V) \quad \cong^{y_2} \\
& \int^{M, M', N', O' \in \mathcal{C}} \mathbb{C}(A; M \otimes X \otimes M' \otimes X' \otimes N' \otimes X'' \otimes O') \times \mathbb{C}(M \otimes Y \otimes M' \otimes Y' \otimes N' \otimes Y'' \otimes O'; B).
\end{aligned}$$

In the same way, the right hand side is isomorphic to the following set,

$$\begin{aligned}
& \int^{U \in \mathcal{MC}} \mathcal{MC} \left( \begin{smallmatrix} A \\ B \end{smallmatrix}; \begin{smallmatrix} U \\ V \end{smallmatrix}; \begin{smallmatrix} X'' \\ Y'' \end{smallmatrix} \right) \times \mathcal{MC} \left( \begin{smallmatrix} U \\ V \end{smallmatrix}; \begin{smallmatrix} X \\ Y \end{smallmatrix}; \begin{smallmatrix} X' \\ Y' \end{smallmatrix} \right) \quad \stackrel{\text{def}}{=} \\
& \int^{U \in \mathcal{MC}, M, N, O \in \mathcal{C}} \mathbb{C}(A; M \otimes U \otimes N \otimes X'' \otimes O) \times \mathbb{C}(M \otimes V \otimes N \otimes Y'' \otimes O; B) \times \mathcal{MC} \left( \begin{smallmatrix} U \\ V \end{smallmatrix}; \begin{smallmatrix} X \\ Y \end{smallmatrix}; \begin{smallmatrix} X' \\ Y' \end{smallmatrix} \right) \quad \cong^{y_1} \\
& \int^{U \in \mathcal{MC}, M, N, O, P, Q \in \mathcal{C}} \mathbb{C}(P; M \otimes U \otimes N) \times \mathbb{C}(A; P \otimes X'' \otimes O) \times \mathbb{C}(M \otimes V \otimes N; Q) \quad \stackrel{\text{def}}{=} \\
& \quad \times \mathbb{C}(Q \otimes Y'' \otimes O; B) \times \mathcal{MC} \left( \begin{smallmatrix} U \\ V \end{smallmatrix}; \begin{smallmatrix} X \\ Y \end{smallmatrix}; \begin{smallmatrix} X' \\ Y' \end{smallmatrix} \right) \quad \cong^{y_1} \\
& \int^{U \in \mathcal{MC}, M', N', O', P, Q \in \mathcal{C}} \mathcal{MC} \left( \begin{smallmatrix} P \\ Q \end{smallmatrix}; \begin{smallmatrix} U \\ V \end{smallmatrix} \right) \times \mathbb{C}(A; P \otimes X'' \otimes O) \times \mathbb{C}(Q \otimes Y'' \otimes O; B) \quad \stackrel{\text{def}}{=} \\
& \quad \times \mathbb{C}(U; M' \otimes X \otimes N' \otimes X' \otimes O') \times \mathbb{C}(M' \otimes Y \otimes N' \otimes Y' \otimes O'; V) \quad \cong^{y_1} \\
& \int^{M', N', O', P, Q \in \mathcal{C}} \mathbb{C}(A; P \otimes X'' \otimes O) \times \mathbb{C}(Q \otimes Y'' \otimes O; B) \\
& \quad \times \mathbb{C}(P; M' \otimes X \otimes N' \otimes X' \otimes O') \times \mathbb{C}(M' \otimes Y \otimes N' \otimes Y' \otimes O'; Q) \quad \cong^{y_1} \\
& \int^{M', N', O' \in \mathcal{C}} \mathbb{C}(A; M' \otimes X \otimes N' \otimes X' \otimes O' \otimes X'' \otimes O) \times \mathbb{C}(M' \otimes Y \otimes N' \otimes Y' \otimes O' \otimes Y'' \otimes O; B).
\end{aligned}$$

Composing both isomorphisms, we obtain the desired associator.  $\square$

**Lemma F.9** (Monoidal contexts parallel left unitor). *We construct a natural isomorphism*

$$(\prec^\lambda) : \int^{U \in \mathcal{MC}} \mathcal{MC} \left( \begin{smallmatrix} A \\ B \end{smallmatrix}; \begin{smallmatrix} U \\ V \end{smallmatrix}; \begin{smallmatrix} X \\ Y \end{smallmatrix} \right) \times \mathcal{MC} \left( \begin{smallmatrix} U \\ V \end{smallmatrix}; N \right) \cong \mathcal{MC} \left( \begin{smallmatrix} A \\ B \end{smallmatrix}; \begin{smallmatrix} X \\ Y \end{smallmatrix} \right)$$

exclusively from Yoneda isomorphisms. This isomorphism is defined by

$$(f_0 \circ (\text{id}_M \otimes \blacksquare \otimes \text{id}_N \otimes \blacksquare \otimes \text{id}_H) \circ f_1) \prec^\lambda g = f_0 \circ (\text{id}_M \otimes g \otimes \text{id}_{N \otimes X' \otimes O}) \circ (\text{id}_{M \otimes Y \otimes N} \otimes \blacksquare \otimes \text{id}_O) \circ f_1.$$

*Proof.*

$$\begin{aligned}
& \int^{U \in \mathcal{MC}} \mathcal{MC} \left( \begin{smallmatrix} A \\ B \end{smallmatrix}; \begin{smallmatrix} U \\ V \end{smallmatrix}; \begin{smallmatrix} X \\ Y \end{smallmatrix} \right) \times \mathcal{MC} \left( \begin{smallmatrix} U \\ V \end{smallmatrix}; N \right) \quad \stackrel{\text{def}}{=} \\
& \int^{U \in \mathcal{MC}, P, Q, R \in \mathcal{C}} \mathbb{C}(A; P \otimes U \otimes Q \otimes X \otimes R) \times \mathbb{C}(P \otimes V \otimes Q \otimes Y \otimes R; B) \times \mathbb{C}(U; V) \quad \cong^{y_1} \\
& \int^{U \in \mathcal{MC}, P, Q, R, S, T \in \mathcal{C}} \mathbb{C}(A; S \otimes X \otimes R) \times \mathbb{C}(S; P \otimes U \otimes Q) \times \mathbb{C}(P \otimes V \otimes Q; T) \\
& \quad \times \mathbb{C}(T \otimes Y \otimes R; B) \times \mathbb{C}(U; V) \quad \stackrel{\text{def}}{=} \\
& \int^{U \in \mathcal{MC}, R, S, T \in \mathcal{C}} \mathbb{C}(A; S \otimes X \otimes R) \times \mathcal{MC} \left( \begin{smallmatrix} S \\ T \end{smallmatrix}; \begin{smallmatrix} U \\ V \end{smallmatrix} \right) \times \mathbb{C}(T \otimes Y \otimes R; B) \times \mathbb{C}(U; V) \quad \cong^{y_1} \\
& \int^{S, R \in \mathcal{C}} \mathbb{C}(A; S \otimes X \otimes R) \times \mathbb{C}(S \otimes Y \otimes R; B) \quad \stackrel{\text{def}}{=} \\
& \mathcal{MC} \left( \begin{smallmatrix} A \\ B \end{smallmatrix}; \begin{smallmatrix} X \\ Y \end{smallmatrix} \right).
\end{aligned}$$

□

**Lemma F.10** (Monoidal contexts parallel right unitor). *We construct a natural isomorphism*

$$\langle \cdot \rangle^\rho : \int_{V \in \mathcal{MC}}^U \mathcal{MC} \left( \frac{A}{B}; \frac{X}{Y} \otimes \frac{U}{V} \right) \times \mathcal{MC} \left( \frac{U}{V}; N \right) \cong \mathcal{MC} \left( \frac{A}{B}; \frac{X}{Y} \right)$$

*exclusively from Yoneda isomorphisms. This isomorphism is defined by*

$$(f_0 \circ (\text{id}_M \otimes \blacksquare \otimes \text{id}_N \otimes \blacksquare \otimes \text{id}_H) \circ f_1) \langle \cdot \rangle^\rho g = f_0 \circ (\text{id}_M \otimes \blacksquare \otimes \text{id}_{N \otimes Y' \otimes O}) \circ (\text{id}_{M \otimes X \otimes N} \otimes g \otimes \text{id}_O) \circ f_1.$$

*Proof.* We construct the isomorphism by the following coend derivation,

$$\begin{aligned} & \int_{V \in \mathcal{MC}}^U \mathcal{MC} \left( \frac{A}{B}; \frac{X}{Y} \otimes \frac{U}{V} \right) \times \mathcal{MC} \left( \frac{U}{V}; N \right) && \stackrel{\text{def}}{=} \\ & \int_{V \in \mathcal{MC}, P, Q, R \in \mathbb{C}}^U \mathbb{C}(A; P \otimes X \otimes Q \otimes U \otimes R) \times \mathbb{C}(P \otimes Y \otimes Q \otimes V \otimes R; B) \times \mathbb{C}(U; V) && \stackrel{y_1}{\cong} \\ & \int_{V \in \mathcal{MC}, P, Q, R, S, T \in \mathbb{C}}^U \mathbb{C}(A; P \otimes X \otimes S) \times \mathbb{C}(S; Q \otimes U \otimes R) \times \mathbb{C}(Q \otimes V \otimes R; T) && \\ & \quad \times \mathbb{C}(P \otimes Y \otimes T; B) \times \mathbb{C}(U; V) && \stackrel{\text{def}}{=} \\ & \int_{V \in \mathcal{MC}, P, S, T \in \mathbb{C}}^U \mathbb{C}(A; P \otimes X \otimes S) \times \mathcal{MC} \left( \frac{S}{T}; \frac{U}{V} \right) \times \mathbb{C}(P \otimes Y \otimes T; B) \times \mathbb{C}(U; V) && \stackrel{y_1}{\cong} \\ & \int_{P, T \in \mathbb{C}}^{P, T \in \mathbb{C}} \mathbb{C}(A; P \otimes X \otimes T) \times \mathbb{C}(P \otimes Y \otimes T; B) && \stackrel{\text{def}}{=} \\ & \mathcal{MC} \left( \frac{A}{B}; \frac{X}{Y} \right). \end{aligned}$$

This concludes the proof. □

**Lemma F.11** (Monoidal contexts laxators). *We construct the following morphisms*

$$\begin{aligned} \psi_2 & : \mathcal{MC} \left( \frac{A}{B}; \left( \frac{X}{Y} \triangleleft \frac{X'}{Y'} \right) \otimes \left( \frac{U}{V} \triangleleft \frac{U'}{V'} \right) \right) \rightarrow \mathcal{MC} \left( \frac{A}{B}; \left( \frac{X}{Y} \otimes \frac{U}{V} \right) \triangleleft \left( \frac{X'}{Y'} \otimes \frac{U'}{V'} \right) \right) \\ \psi_0 & : \mathcal{MC} \left( \frac{A}{B}; I \right) \rightarrow \mathcal{MC} \left( \frac{A}{B}; I \triangleleft I \right) \\ \varphi_2 & : \mathcal{MC} \left( \frac{A}{B}; N \otimes N \right) \rightarrow \mathcal{MC} \left( \frac{A}{B}; N \right) \\ \varphi_0 & : \mathcal{MC} \left( \frac{A}{B}; I \right) \rightarrow \mathcal{MC} \left( \frac{A}{B}; N \right). \end{aligned}$$

*exclusively from composition in  $\mathbb{C}$  and Yoneda isomorphisms. The laxator  $\psi_2$  is defined by stating that the following equation holds*

$$\begin{aligned} & (f_0 \circ (\text{id} \otimes \blacksquare \otimes \text{id} \otimes \blacksquare \otimes \text{id}) \circ f_1) \\ & \quad \langle \cdot \rangle_1^\psi (g_0 \circ (\text{id} \otimes \blacksquare \otimes \text{id}) \circ g_1 \circ (\text{id} \otimes \blacksquare \otimes \text{id}) \circ g_2) \\ & \quad \langle \cdot \rangle_2^\psi (h_0 \circ (\text{id} \otimes \blacksquare \otimes \text{id}) \circ h_1 \circ (\text{id} \otimes \blacksquare \otimes \text{id}) \circ h_2) = \\ & (j_0 \circ (\text{id} \otimes \blacksquare \otimes \text{id}) \circ j_1 \circ (\text{id} \otimes \blacksquare \otimes \text{id}) \circ j_2) \mid \\ & (k_0 \circ (\text{id} \otimes \blacksquare \otimes \text{id} \otimes \blacksquare \otimes \text{id}) \circ k_1) \mid \\ & (l_0 \circ (\text{id} \otimes \blacksquare \otimes \text{id} \otimes \blacksquare \otimes \text{id}) \circ l_1) \end{aligned}$$

*if and only if*

$$\begin{aligned} & f_0 \circ (\text{id} \otimes g_0 \otimes \text{id} \otimes h_0 \otimes \text{id}) \circ (\text{id} \otimes \blacksquare \otimes \text{id} \otimes \blacksquare \otimes \text{id}) \circ (\text{id} \otimes g_1 \otimes \text{id} \otimes h_1 \otimes \text{id}) \circ \\ & \quad (\text{id} \otimes \blacksquare \otimes \text{id} \otimes \blacksquare \otimes \text{id}) \circ (\text{id} \otimes g_2 \otimes \text{id} \otimes h_2 \otimes \text{id}) \circ f_1 = \\ & j_0 \circ (\text{id} \otimes k_0 \otimes \text{id}) \circ (\text{id} \otimes \blacksquare \otimes \text{id} \otimes \blacksquare \otimes \text{id}) \circ (\text{id} \otimes k_1 \otimes \text{id}) \circ j_1 \circ (\text{id} \otimes l_0 \otimes \text{id}) \circ \\ & \quad (\text{id} \otimes \blacksquare \otimes \text{id} \otimes \blacksquare \otimes \text{id}) \circ (\text{id} \otimes l_1 \otimes \text{id}) \circ j_2. \end{aligned}$$

*Furthermore, since  $\mathcal{MC}$  is normal,  $\psi_0, \varphi_2$ , and  $\varphi_0$  are isomorphisms.*

*Proof.* Consider the right hand side of  $\psi_2$ . It is isomorphic to the following

$$\begin{aligned}
& \int_{\substack{P \\ Q, Q' \in \text{MC}}} \text{MC} \left( \begin{array}{c} A \\ B \end{array}; \begin{array}{c} P \\ Q \end{array} \triangleleft \begin{array}{c} P' \\ Q' \end{array} \right) \times \text{MC} \left( \begin{array}{c} P \\ Q \end{array}; \begin{array}{c} X \\ Y \end{array} \otimes \begin{array}{c} U \\ V \end{array} \right) \times \text{MC} \left( \begin{array}{c} P' \\ Q' \end{array}; \begin{array}{c} X' \\ Y' \end{array} \otimes \begin{array}{c} U' \\ V' \end{array} \right) & \stackrel{\text{def}}{=} \\
& \int_{\substack{P \\ Q, Q' \in \text{MC}, M, N, O \in \mathbb{C}}} \mathbb{C}(A; M \otimes P \otimes N) \times \mathbb{C}(M \otimes Q \otimes N; M' \otimes P' \otimes N') \times \mathbb{C}(M' \otimes Q' \otimes N'; B) \\
& \quad \times \text{MC} \left( \begin{array}{c} P \\ Q \end{array}; \begin{array}{c} X \\ Y \end{array} \otimes \begin{array}{c} U \\ V \end{array} \right) \times \text{MC} \left( \begin{array}{c} P' \\ Q' \end{array}; \begin{array}{c} X' \\ Y' \end{array} \otimes \begin{array}{c} U' \\ V' \end{array} \right) & \stackrel{\text{def}}{=} \\
& \int_{\substack{P \\ Q, Q' \in \text{MC}, M, N, O \in \mathbb{C}}} \mathbb{C}(A; M \otimes P \otimes N) \times \text{MC} \left( \begin{array}{c} M \otimes Q \otimes N \\ B \end{array}; P' \right) \times \text{MC} \left( \begin{array}{c} P \\ Q \end{array}; \begin{array}{c} X \\ Y \end{array} \otimes \begin{array}{c} U \\ V \end{array} \right) \times \text{MC} \left( \begin{array}{c} P' \\ Q' \end{array}; \begin{array}{c} X' \\ Y' \end{array} \otimes \begin{array}{c} U' \\ V' \end{array} \right) & \stackrel{y_1}{=} \\
& \int_{\substack{P \\ Q \in \text{MC}, M, N, O, C, D, E, F, G, H \in \mathbb{C}}} \mathbb{C}(A; M \otimes P \otimes N) \times \mathbb{C}(P; C \otimes X \otimes D \otimes U \otimes E) \times \mathbb{C}(C \otimes Y \otimes D \otimes V \otimes E; Q) \times \\
& \quad \mathbb{C}(M \otimes Q \otimes N; F \otimes X' \otimes G \otimes U' \otimes H) \times \mathbb{C}(F \otimes Y' \otimes G \otimes V' \otimes H; B) & \stackrel{\text{def}}{=} \\
& \int_{\substack{P \\ Q \in \text{MC}, C, D, E, F, G, H \in \mathbb{C}}} \text{MC} \left( \begin{array}{c} F \otimes X' \otimes G \otimes U' \otimes H \\ A \end{array}; P \right) \times \mathbb{C}(P; C \otimes X \otimes D \otimes U \otimes E) \\
& \quad \times \mathbb{C}(C \otimes Y \otimes D \otimes V \otimes E; Q) \times \mathbb{C}(F \otimes Y' \otimes G \otimes V' \otimes H; B) & \stackrel{y_1}{=} \\
& \int_{\substack{C, D, E, F, G, H \in \mathbb{C}}} \mathbb{C}(A; C \otimes X \otimes D \otimes U \otimes E) \times \mathbb{C}(C \otimes Y \otimes D \otimes V \otimes E; F \otimes X' \otimes G \otimes U' \otimes H) \\
& \quad \times \mathbb{C}(F \otimes Y' \otimes G \otimes V' \otimes H; B).
\end{aligned}$$

This isomorphism sends an element  $(j_0 \circ (\text{id} \otimes \blacksquare \otimes \text{id}) \circ j_1 \circ (\text{id} \otimes \blacksquare \otimes \text{id}) \circ j_2 \mid k_0 \circ (\text{id} \otimes \blacksquare \otimes \text{id} \otimes \blacksquare \otimes \text{id}) \circ k_1 \mid l_0 \circ (\text{id} \otimes \blacksquare \otimes \text{id} \otimes \blacksquare \otimes \text{id}) \circ l_1)$  to  $(j_0 \circ (\text{id} \otimes k_0 \otimes \text{id}) \circ (\text{id} \otimes \blacksquare \otimes \text{id} \otimes \blacksquare \otimes \text{id}) \circ (\text{id} \otimes k_1 \otimes \text{id}) \circ j_1 \circ (\text{id} \otimes l_0 \otimes \text{id}) \circ (\text{id} \otimes \blacksquare \otimes \text{id} \otimes \blacksquare \otimes \text{id}) \circ (\text{id} \otimes l_1 \otimes \text{id}) \circ j_2)$ . Define a map from the left hand side of  $\psi_2$  to this set, sending a triple

$$\begin{aligned}
& (f_0 \circ (\text{id} \otimes \blacksquare \otimes \text{id} \otimes \blacksquare \otimes \text{id}) \circ f_1 \mid \\
& g_0 \circ (\text{id} \otimes \blacksquare \otimes \text{id}) \circ g_1 \circ (\text{id} \otimes \blacksquare \otimes \text{id}) \circ g_2 \mid \\
& h_0 \circ (\text{id} \otimes \blacksquare \otimes \text{id}) \circ h_1 \circ (\text{id} \otimes \blacksquare \otimes \text{id}) \circ h_2) \\
& \mapsto \\
& (f_0 \circ (\text{id} \otimes g_0 \otimes \text{id} \otimes h_0 \otimes \text{id}) \circ (\text{id} \otimes \blacksquare \otimes \text{id} \otimes \blacksquare \otimes \text{id}) \circ (\text{id} \otimes g_1 \otimes \text{id} \otimes h_1 \otimes \text{id}) \circ \\
& (\text{id} \otimes \blacksquare \otimes \text{id} \otimes \blacksquare \otimes \text{id}) \circ (\text{id} \otimes g_2 \otimes \text{id} \otimes h_2 \otimes \text{id}) \circ f_1.
\end{aligned}$$

Now composing this map with the isomorphism yields the desired morphism  $\psi_2$ . The remaining laxators  $\psi_0$ ,  $\varphi_2$ , and  $\varphi_0$  are isomorphisms that arise from applications of unitality or just as identities.  $\square$

**Theorem F.12** (From Theorem 6.6). *Monoidal contexts are the free normalization of the cofree produoidal category over a category.*

*Proof.* We already know that the normalization procedure yields the free normalization over a produoidal category. It is only left to note that this is exactly the category we have explicitly constructed in this section.

This amounts to proving that the produoidal category of monoidal contexts is precisely the normalization of the produoidal category of spliced arrows. We do so for morphisms, the rest of the proof is similar.

$$\begin{aligned}
& \text{NSC} \left( \begin{array}{c} A \\ B \end{array}; \begin{array}{c} X \\ Y \end{array} \right) & \stackrel{\text{def}}{=} \\
& \text{SC} \left( \begin{array}{c} A \\ B \end{array}; N \otimes \begin{array}{c} X \\ Y \end{array} \otimes N \right) & \stackrel{\text{def}}{=} \\
& \int_{\substack{U \\ V, V' \in \text{SC}}} \text{SC} \left( \begin{array}{c} A \\ B \end{array}; \begin{array}{c} U \\ V \end{array} \otimes \begin{array}{c} X \\ Y \end{array} \otimes \begin{array}{c} U' \\ V' \end{array} \right) \times \text{SC} \left( \begin{array}{c} U \\ V \end{array}; N \right) \times \text{SC} \left( \begin{array}{c} U' \\ V' \end{array}; N \right) & \stackrel{\text{def}}{=} \\
& \int_{\substack{U \\ V, V' \in \text{SC}}} \mathbb{C}(A; U \otimes X \otimes U') \times \mathbb{C}(V \otimes Y \otimes V'; B) \times \mathbb{C}(U; V) \times \mathbb{C}(U'; V') & \stackrel{\text{def}}{=}
\end{aligned}$$

$$\begin{aligned}
& \int^{U, V, U', V' \in \mathcal{C}} \mathbb{C}(A; U \otimes X \otimes U') \times \mathbb{C}(V \otimes Y \otimes V'; B) \times \mathbb{C}(U; V) \times \mathbb{C}(U'; V') && \stackrel{y_1}{=} \\
& \int^{U, U' \in \mathcal{C}} \mathbb{C}(A; U \otimes X \otimes U') \times \mathbb{C}(U \otimes Y \otimes U'; B) && \stackrel{\text{def}}{=} \\
& \mathcal{MC} \left( \begin{array}{c} A: X \\ B: Y \end{array} \right)
\end{aligned}$$

The rest of the profunctors follow a similar reasoning.

□

APPENDIX G  
MONOIDAL LENSES

**Proposition G.1** (From Proposition 7.2). *Monoidal lenses form a normal symmetric produoidal category with the following morphisms, units, sequential and parallel splits.*

$$\begin{aligned}\mathcal{LC}\left(\frac{A}{B}; \frac{X}{Y}\right) &= \mathbb{C}(A; \bullet \otimes X) \diamond \mathbb{C}(\bullet \otimes Y; B); \\ \mathcal{LC}\left(\frac{A}{B}; N\right) &= \mathbb{C}(A; B); \\ \mathcal{LC}\left(\frac{A}{B}; \frac{X}{Y} \triangleleft \frac{X'}{Y'}\right) &= \mathbb{C}(A; \bullet^1 \otimes X) \diamond \mathbb{C}(\bullet^1 \otimes Y; \bullet^2 \otimes X') \diamond \mathbb{C}(\bullet^2 \otimes Y'; B); \\ \mathcal{LC}\left(\frac{A}{B}; \frac{X}{Y} \otimes \frac{X'}{Y'}\right) &= \mathbb{C}(A; \bullet^1 \otimes X \otimes X') \diamond \mathbb{C}(\bullet^1 \otimes Y \otimes Y'; B).\end{aligned}$$

*Proof.* Lemmas G.2 and G.3 construct the associators, and Lemmas G.4 and G.5 define the unitors. Lemma G.6 constructs the symmetry. As they are all constructed with Yoneda isomorphisms and symmetries, they must satisfy the coherence equations. Finally, the laxators are constructed in much the same way as in Lemma F.11.  $\square$

**Lemma G.2** (Monoidal lenses sequential associator). *We construct a natural isomorphism*

$$\langle \triangleleft_2^\alpha \rangle : \int_{V \in \mathcal{LC}}^U \mathcal{LC}\left(\frac{A}{B}; \frac{X}{Y} \triangleleft \frac{U}{V}\right) \times \mathcal{LC}\left(\frac{U}{V}; \frac{X'}{Y'} \triangleleft \frac{X''}{Y''}\right) \cong \int_{V \in \mathcal{MC}}^U \mathcal{LC}\left(\frac{A}{B}; \frac{U}{V} \triangleleft \frac{X''}{Y''}\right) \times \mathcal{LC}\left(\frac{U}{V}; \frac{X'}{Y'} \triangleleft \frac{X''}{Y''}\right) : \langle \triangleleft_1^\alpha \rangle$$

*exclusively from Yoneda isomorphisms.*

*Proof.* Out of Yoneda reductions, we construct an isomorphism between the left hand side and a set of quadruples of morphisms.

$$\begin{aligned}& \int_{V \in \mathcal{LC}}^U \mathcal{LC}\left(\frac{A}{B}; \frac{X}{Y} \triangleleft \frac{U}{V}\right) \times \mathcal{LC}\left(\frac{U}{V}; \frac{X'}{Y'} \triangleleft \frac{X''}{Y''}\right) && \stackrel{\text{def}}{=} \\ & \int_{V \in \mathcal{LC}, P, Q \in \mathbb{C}}^U \mathbb{C}(A; P \otimes X) \times \mathbb{C}(P \otimes Y; Q \otimes U) \times \mathbb{C}(Q \otimes V; B) \times \mathcal{LC}\left(\frac{U}{V}; \frac{X'}{Y'} \triangleleft \frac{X''}{Y''}\right) && \stackrel{\text{def}}{=} \\ & \int_{V \in \mathcal{LC}, P, Q, R \in \mathbb{C}}^U \mathbb{C}(A; P \otimes X) \times \mathcal{LC}\left(\frac{P \otimes Y}{B}; \frac{U}{V}\right) \times \mathbb{C}(U; Q \otimes X') \times \mathbb{C}(Q \otimes Y'; R \otimes X'') \times \mathbb{C}(R \otimes Y''; V) && \stackrel{y_2}{\cong} \\ & \int_{P, Q, R \in \mathbb{C}}^U \mathbb{C}(A; P \otimes X) \times \mathbb{C}(P \otimes Y; Q \otimes X') \times \mathbb{C}(Q \otimes Y'; R \otimes X'') \times \mathbb{C}(R \otimes Y''; B).\end{aligned}$$

Out of Yoneda reductions, we construct an isomorphism between the right hand side and the same set of quadruples of morphisms.

$$\begin{aligned}& \int_{V \in \mathcal{LC}}^U \mathcal{LC}\left(\frac{A}{B}; \frac{U}{V} \triangleleft \frac{X''}{Y''}\right) \times \mathcal{LC}\left(\frac{U}{V}; \frac{X'}{Y'} \triangleleft \frac{X''}{Y''}\right) && \stackrel{\text{def}}{=} \\ & \int_{V \in \mathcal{LC}, P, Q \in \mathbb{C}}^U \mathbb{C}(A; Q \otimes U) \times \mathbb{C}(Q \otimes V; P \otimes X'') \times \mathbb{C}(P \otimes Y''; B) \times \mathcal{LC}\left(\frac{U}{V}; \frac{X'}{Y'} \triangleleft \frac{X''}{Y''}\right) && \stackrel{\text{def}}{=} \\ & \int_{V \in \mathcal{LC}, P, Q, R \in \mathbb{C}}^U \mathcal{LC}\left(\frac{A}{P \otimes X''}; \frac{U}{V}\right) \times \mathbb{C}(P \otimes Y''; B) \times \mathbb{C}(U; Q \otimes X) \times \mathbb{C}(Q \otimes Y; R \otimes X') \times \mathbb{C}(R \otimes Y'; V) && \stackrel{y_2}{\cong} \\ & \int_{P, Q, R \in \mathbb{C}}^U \mathbb{C}(A; Q \otimes X) \times \mathbb{C}(Q \otimes Y; R \otimes X') \times \mathbb{C}(R \otimes Y'; P \otimes X'') \times \mathbb{C}(P \otimes Y''; B).\end{aligned}$$

Composing both isomorphisms, we obtain the desired associator. It gets defined by the following operations,

$$\begin{aligned}(f_0 \circledast (\text{id}_M \otimes \blacksquare) \circledast f_1 \circledast (\text{id}_N \otimes \blacksquare) \circledast f_2) \triangleleft_1^\alpha (g_0 \circledast (\text{id}_P \otimes \blacksquare) \circledast g_1 \circledast (\text{id}_Q \otimes \blacksquare) \circledast g_2) &= \\ f_0 \circledast (\text{id}_M \otimes g_0) \circledast (\text{id}_{M \otimes P} \otimes \blacksquare) \circledast (\text{id}_M \otimes g_1) \circledast (\text{id}_{M \otimes Q} \otimes \blacksquare) \circledast (\text{id}_M \otimes g_2) \circledast f_1 \circledast (\text{id}_N \otimes \blacksquare) \circledast f_2. & \\ (f_0 \circledast (\text{id}_M \otimes \blacksquare) \circledast f_1 \circledast (\text{id}_N \otimes \blacksquare) \circledast f_2) \triangleleft_2^\alpha (h_0 \circledast (\text{id}_P \otimes \blacksquare) \circledast h_1 \circledast (\text{id}_Q \otimes \blacksquare) \circledast h_2) &= \\ f_0 \circledast (\text{id}_M \otimes \blacksquare) \circledast f_1 \circledast (\text{id}_N \otimes h_0) \circledast (\text{id}_{N \otimes P} \otimes \blacksquare) \circledast (\text{id}_N \otimes h_1) \circledast (\text{id}_{N \otimes Q} \otimes \blacksquare) \circledast (\text{id}_N \otimes h_2) \circledast f_2. &\end{aligned}$$

□

**Lemma G.3** (Monoidal lenses parallel associator). *We construct a natural isomorphism*

$$\langle \_2^\alpha \rangle : \int_{V \in \text{MC}}^U \mathcal{LC}(A; X \otimes U; V) \times \mathcal{LC}(U; X' \otimes X''; Y'') \cong \int_{V \in \text{MC}}^U \mathcal{LC}(A; U \otimes X''; V) \times \mathcal{LC}(U; X \otimes X'; Y') : \langle \_1^\alpha \rangle$$

exclusively from Yoneda isomorphisms.

*Proof.* The left hand side is isomorphic to:

$$\begin{aligned} & \int_{V \in \mathcal{LC}}^U \mathcal{LC}(A; X \otimes U; V) \times \mathcal{LC}(U; X' \otimes X''; Y'') && = \text{(by representability)} \\ & \int_{V \in \mathcal{LC}}^U \mathcal{LC}(A; X \otimes U; V) \times \mathcal{LC}(U; X' \otimes X''; Y'') && \cong \text{(by Yoneda reduction)} \\ & \mathcal{LC}(A; X \otimes X' \otimes X''; Y' \otimes Y'') && \cong \text{(by representability)} \\ & \mathcal{LC}(A; X \otimes X' \otimes X''; Y \otimes Y' \otimes Y''), \end{aligned}$$

and the right hand side is isomorphic to the same:

$$\begin{aligned} & \int_{V \in \mathcal{LC}}^U \mathcal{LC}(A; U \otimes X''; V) \times \mathcal{LC}(U; X \otimes X'; Y') && = \text{(by representability)} \\ & \int_{V \in \mathcal{LC}}^U \mathcal{LC}(A; U \otimes X''; V) \times \mathcal{LC}(U; X \otimes X'; Y') && \cong \text{(by Yoneda reduction)} \\ & \mathcal{LC}(A; X \otimes X' \otimes X''; Y' \otimes Y'') && \cong \text{(by representability)} \\ & \mathcal{LC}(A; X \otimes X' \otimes X''; Y \otimes Y' \otimes Y''). \end{aligned}$$

Composing both isomorphisms, we obtain the desired associator,

$$\begin{aligned} & (f_0 \circledast (\text{id}_M \otimes \blacksquare \otimes \blacksquare) \circledast f_1) \langle \_1^\alpha \rangle (g_0 \circledast (\text{id}_P \otimes \blacksquare \otimes \blacksquare) \circledast g_1) && = \\ & f_0 \circledast (\text{id}_M \otimes g_0 \otimes \text{id}_{X''}) \circledast (\text{id}_{M \otimes P} \otimes \blacksquare \otimes \blacksquare \otimes \blacksquare) \circledast (\text{id}_M \otimes g_1 \otimes \text{id}_{Y''}) \circledast f_1. \\ & (f_0 \circledast (\text{id}_M \otimes \blacksquare \otimes \blacksquare) \circledast f_1) \langle \_2^\alpha \rangle (h_0 \circledast (\text{id}_Q \otimes \blacksquare \otimes \blacksquare) \circledast h_1) && = \\ & f_0 \circledast \sigma \circledast (\text{id}_M \otimes h_0 \otimes \text{id}_X) \circledast \sigma \circledast (\text{id}_{M \otimes P} \otimes \blacksquare \otimes \blacksquare \otimes \blacksquare) \circledast \sigma \circledast (\text{id}_M \otimes h_1 \otimes \text{id}_Y) \circledast \sigma \circledast f_1. \end{aligned}$$

This concludes the proof. □

**Lemma G.4** (Monoidal lenses sequential right unitor). *We construct a natural isomorphism*

$$\langle \_1^\rho \rangle : \int_{Y' \in \mathcal{LC}}^{X'} \mathcal{LC}(A; X \triangleleft X'; Y') \times \mathcal{LC}(X'; N) \cong \mathcal{LC}(A; X; Y')$$

exclusively from Yoneda isomorphisms.

*Proof.* We construct the isomorphism with the following coend calculus derivation.

$$\begin{aligned} & \int_{Y' \in \mathcal{LC}}^{X'} \mathcal{LC}(A; X \triangleleft X'; Y') \times \mathcal{LC}(X'; N) && \stackrel{\text{def}}{=} \\ & \int_{Y' \in \mathcal{LC}, P, Q \in \mathcal{C}}^{X'} \mathbb{C}(A; P \otimes X) \times \mathbb{C}(P \otimes Y; Q \otimes X') \times \mathbb{C}(Q \otimes Y'; B) \times \mathbb{C}(X'; Y') && \stackrel{\text{def}}{=} \\ & \int_{Y' \in \mathcal{LC}, P \in \mathcal{C}}^{X'} \mathbb{C}(A; P \otimes X) \times \mathcal{LC}(P \otimes Y; X') \times \mathbb{C}(X'; Y') && \stackrel{y_2}{\cong} \\ & \int_{P \in \mathcal{C}} \mathbb{C}(A; P \otimes X) \times \mathbb{C}(P \otimes Y; B). \end{aligned}$$

We obtain the following right unitor.

$$\begin{aligned} (f_0 \circledast (\text{id}_M \otimes \blacksquare) \circledast f_1 \circledast (\text{id}_N \otimes \blacksquare) \circledast f_2) \prec^p g &= \\ f_0 \circledast (\text{id}_M \otimes \blacksquare) \circledast f_1 \circledast (\text{id}_N \otimes g) \circledast f_2. & \end{aligned}$$

The left unitor is defined similarly.  $\square$

**Lemma G.5** (Monoidal lenses parallel right unitor). *We construct a natural isomorphism*

$$(\prec^p) : \int^{X', Y' \in \mathcal{LC}} \mathcal{LC} \left( \frac{A}{B}; \frac{X}{Y} \otimes \frac{X'}{Y'} \right) \times \mathcal{LC} \left( \frac{X'}{Y'}; N \right) \cong \mathcal{LC} \left( \frac{A}{B}; \frac{X}{Y} \right)$$

exclusively from Yoneda isomorphisms and symmetry of  $\mathbb{C}$ .

*Proof.* We construct the isomorphism with the following coend calculus derivations.

$$\begin{aligned} & \int^{X', Y' \in \mathcal{LC}} \mathcal{LC} \left( \frac{A}{B}; \frac{X}{Y} \otimes \frac{X'}{Y'} \right) \times \mathcal{LC} \left( \frac{X'}{Y'}; N \right) \\ &= \quad (\text{by definition}) \\ & \int^{X', Y' \in \mathcal{LC}, P \in \mathbb{C}} \mathbb{C}(A; P \otimes X \otimes X') \times \mathbb{C}(P \otimes Y \otimes Y'; B) \times \mathbb{C}(X'; Y') \\ &\cong \quad (\text{by symmetry of } \mathbb{C}) \\ & \int^{X', Y' \in \mathcal{LC}, P \in \mathbb{C}} \mathbb{C}(A; P \otimes X' \otimes X) \times \mathbb{C}(P \otimes Y' \otimes Y; B) \times \mathbb{C}(X'; Y') \\ &\cong \quad (\text{by Yoneda reduction}) \\ & \int^{X', Y' \in \mathcal{LC}, P, Q, R \in \mathbb{C}} \mathbb{C}(A; Q \otimes X) \times \mathbb{C}(Q; P \otimes X') \times \mathbb{C}(P \otimes Y'; R) \times \mathbb{C}(R \otimes Y; B) \times \mathbb{C}(X'; Y') \\ &= \quad (\text{by definition}) \\ & \int^{X', Y' \in \mathcal{LC}, P, Q, R \in \mathbb{C}} \mathbb{C}(A; Q \otimes X) \times \mathcal{LC} \left( \frac{Q}{R}; \frac{X'}{Y'} \right) \times \mathbb{C}(R \otimes Y; B) \times \mathbb{C}(X'; Y') \\ &\cong \quad (\text{by Yoneda reduction}) \\ & \int^{Q \in \mathbb{C}} \mathbb{C}(A; Q \otimes X) \times \mathbb{C}(Q \otimes Y; B). \end{aligned}$$

We obtain the following right unitor.

$$\begin{aligned} (f_0 \circledast (\text{id}_M \otimes \blacksquare \otimes \blacksquare) \circledast f_1) \prec^p g &= \\ f_0 \circledast (\text{id}_M \otimes \blacksquare \otimes \blacksquare) \circledast (\text{id}_M \otimes (\sigma \circledast (g \otimes \text{id}_X) \circledast \sigma)) \circledast f_1 &= \\ f_0 \circledast (\text{id}_M \otimes (\sigma \circledast (g \otimes \text{id}_X) \circledast \sigma)) \circledast (\text{id}_M \otimes \blacksquare \otimes \blacksquare) \circledast f_1. & \end{aligned}$$

The left unitor is defined similarly.  $\square$

**Lemma G.6** (Monoidal lenses symmetry). *We construct the symmetries  $\mathcal{LC} \left( \frac{A}{B}; \frac{X}{Y} \otimes \frac{X'}{Y'} \right) \cong \mathcal{LC} \left( \frac{A}{B}; \frac{X'}{Y'} \otimes \frac{X}{Y} \right)$ .*

*Proof.* These follow from the symmetries of  $\mathbb{C}$  and representability of  $\otimes$  for monoidal lenses.

$$\mathcal{LC} \left( \frac{A}{B}; \frac{X}{Y} \otimes \frac{X'}{Y'} \right) \cong \mathcal{LC} \left( \frac{A}{B}; \frac{X \otimes X'}{Y \otimes Y'} \right) \cong \mathcal{LC} \left( \frac{A}{B}; \frac{X' \otimes X}{Y' \otimes Y} \right) \cong \mathcal{LC} \left( \frac{A}{B}; \frac{X'}{Y'} \otimes \frac{X}{Y} \right).$$

This concludes the proof.  $\square$

**Proposition G.7** (From Proposition 7.6). *Let  $(\mathbb{C}, \otimes, I)$  be a symmetric monoidal category. There exist monoidal functors  $(!): \mathbb{C} \rightarrow \mathcal{LC}$  and  $(?): \mathbb{C}^{op} \rightarrow \mathcal{LC}$ .*

*Proof.* This proof appears with a different language in the work of Riley [Ril18, Proposition 2.0.14]. In fact, there, the combined identity-on-objects functor  $(! \times ?): \mathbb{C} \times \mathbb{C}^{op} \rightarrow \mathcal{LC}$  is shown to be monoidal. In our case, we can define  $!f = (f \circledast \blacksquare \circledast \text{id}_I)$  and  $?g = (\text{id}_I \circledast \blacksquare \circledast g)$ , and then check that compositions and tensoring

of morphisms are compatible with composition and tensoring of monoidal lenses, this is straightforward. Moreover, as we comment in the text, we can see that, by definition,  $!(A \otimes B) = (A \otimes_B^I) = (A^I) \otimes (B^I) = !A \otimes !B$  and  $?(A \otimes B) = (A \otimes_B^I) = (A^I) \otimes (B^I) = ?A \otimes ?B$ .  $\square$

**Proposition G.8** (From Proposition 7.8). *Let  $(\mathbb{C}, \times, 1)$  be a cartesian monoidal category. Its produoidal category of lenses is given by the following profunctors.*

$$\begin{aligned} \mathbf{Lens} \left( \begin{smallmatrix} A \\ B \\ \hline X \\ Y \end{smallmatrix} \right) &= \mathbb{C}(A; X) \times \mathbb{C}(A \times Y; B). \\ \mathbf{Lens} \left( \begin{smallmatrix} A \\ B \\ \hline X \\ Y \\ \hline X' \\ Y' \end{smallmatrix} \right) &= \mathbb{C}(A; X) \times \mathbb{C}(A \times Y; X') \times \mathbb{C}(A \times Y \times Y'; B). \\ \mathbf{Lens} \left( \begin{smallmatrix} A \\ B \\ \hline X \\ Y \\ \hline X' \\ Y' \end{smallmatrix} \right) &= \mathbb{C}(A; X \times X') \times \mathbb{C}(A \times Y \times Y'; B). \\ \mathbf{Lens} \left( \begin{smallmatrix} A \\ B \end{smallmatrix} \right) &= \mathbb{C}(A; B). \end{aligned}$$

*Proof.* We employ coend calculus. The derivation of the morphisms of cartesian lenses is very well-known [Ril18], [CEG<sup>+</sup>20]; we derive the sequential and parallel splits. Indeed, the sequential split reduces as

$$\begin{aligned} & \int^{M, N} \mathbb{C}(A; M \times X) \times \mathbb{C}(M \times Y; N \times X') \times \mathbb{C}(N \times Y'; B) \\ & \cong \text{(Universal property of the product)} \\ & \int^{M, N} \mathbb{C}(A; M) \times \mathbb{C}(A; X) \times \mathbb{C}(M \times Y; N) \times \mathbb{C}(M \times Y; X') \times \mathbb{C}(N \times Y'; B) \\ & \cong \text{(by Yoneda reduction)} \\ & \mathbb{C}(A; X) \times \mathbb{C}(A \times Y; X') \times \mathbb{C}(A \times Y \times Y'; B). \end{aligned}$$

And the parallel split reduces as

$$\begin{aligned} & \int^M \mathbb{C}(A; M \times X \times X') \times \mathbb{C}(M \times Y \times Y'; B) \\ & \cong \text{(Universal property of the product)} \\ & \int^M \mathbb{C}(A; M) \times \mathbb{C}(A; X \times X') \times \mathbb{C}(M \times Y \times Y'; B) \\ & \cong \text{(by Yoneda reduction)} \\ & \mathbb{C}(A; X \times X') \times \mathbb{C}(A \times Y \times Y'; B). \end{aligned}$$

The unit is just the same as in the general monoidal case.  $\square$

**Theorem G.9** (From Theorem 7.3). *Monoidal lenses are the free symmetric normalization of the cofree symmetric produoidal category over a monoidal category.*

*Proof.* We have already proven that the symmetric normalization procedure yields the free symmetric normalization over a symmetric produoidal category (Theorem 5.7).

The rest of the proof amounts to show that the normal symmetric produoidal category of monoidal lenses is precisely the symmetric normalization of the produoidal category of spliced arrows. We do so for morphisms, the rest of the proof is similar.

$$\begin{aligned} \mathcal{N}_{\sigma} \mathbf{SC} \left( \begin{smallmatrix} A \\ B \\ \hline X \\ Y \end{smallmatrix} \right) & \stackrel{\text{def}}{=} \\ \mathbf{SC} \left( \begin{smallmatrix} A \\ B \\ \hline N \otimes X \\ Y \end{smallmatrix} \right) & \stackrel{\text{def}}{=} \\ \int^{U \in \mathbf{SC}} \mathbf{SC} \left( \begin{smallmatrix} A \\ B \\ \hline U \otimes X \\ Y \end{smallmatrix} \right) \times \mathbf{SC} \left( \begin{smallmatrix} U \\ V \\ \hline N \end{smallmatrix} \right) & \stackrel{\text{def}}{=} \\ \int^{U, V \in \mathbb{C}} \mathbb{C}(A; U \otimes X) \times \mathbb{C}(U \otimes Y; B) \times \mathbb{C}(U; V) & \stackrel{y_1}{\cong} \\ \int^{U \in \mathbb{C}} \mathbb{C}(A; U \otimes X) \times \mathbb{C}(U \otimes Y; B) & \stackrel{\text{def}}{=} \end{aligned}$$



$$\mathcal{LC} \left( \frac{A}{B}, \frac{X}{Y} \right)$$

The rest of the profunctors follow a similar reasoning.

□

APPENDIX H  
FURTHER WORK

**Theorem H.1** (From Proposition 8.1). *Let  $\mathbb{V}$  be a normal and  $\otimes$ -symmetric produoidal category with coends over  $\mathbb{V}$  commuting with finite connected limits. Then,  $[\mathbb{V}^{\text{op}}, \mathbf{Set}]$  is a dependence category in the sense of Shapiro and Spivak [SS22].*

*Proof.* Whenever  $\mathbb{V}$  is produoidal,  $[\mathbb{V}^{\text{op}}, \mathbf{Set}]$ , its category of presheaves is duoidal, with the structure given by convolution (Theorem I.6).

At the same time,  $[\mathbb{V}^{\text{op}}, \mathbf{Set}]$  is a locally cartesian closed category with all limits because it is a presheaf category. Whenever finite connected limits are preserved by  $\otimes, \triangleleft$ , we obtain a dependence category [SS22, Theorem 4.8]. This means we only need the following isomorphism,

$$\begin{aligned}
 & \int^{U,V} \mathbb{V}(X; U \otimes V) \times \lim_i P_i(U) \times \lim_j Q_j(V) \\
 \cong & \quad (\text{Commutation of limits}) \\
 & \int^{U,V} \lim_{i,j} \mathbb{V}(X; U \otimes V) \times P_i(U) \times Q_j(V) \\
 \cong & \quad (\text{Coends commute with finite connected limits}) \\
 & \lim_{i,j} \int^{U,V} \mathbb{V}(X; U \otimes V) \times P_i(U) \times Q_j(V)
 \end{aligned}$$

Where we use our hypothesis on the last step. We conjecture this can be extended to an arbitrary  $\mathbb{V}$  with minor constraints. □

APPENDIX I  
DUOIDAL AND PRODUOIDAL CATEGORIES

By the Eckmann-Hilton argument, each time we have two monoids  $(*, \circ)$  such that one is a monoid homomorphism over the other,  $(a \circ b) * (c \circ d) = (a * c) \circ (b * d)$ , we know that both monoids coincide into a single commutative monoid.

However, an extra dimension helps us side-step the Eckmann-Hilton argument. If, instead of equalities or isomorphisms, we use directed morphisms, both monoids (which now may become 2-monoids) do not necessarily coincide, and the resulting structure is that of a duoidal category.

**Definition I.1** (Duoidal category). A *duoidal category* [AM10] is a category  $\mathbb{C}$  with two monoidal structures,  $(\mathbb{C}, \otimes, I, \alpha, \lambda, \rho)$  and  $(\mathbb{C}, \triangleleft, N, \beta, \kappa, \nu)$  such that the latter distribute over the former. In other words, it is endowed with a duoidal tensor,  $(\triangleleft): \mathbb{C} \times \mathbb{C} \rightarrow \mathbb{C}$ , together with natural distributors

$$\psi_2: (X \triangleleft Z) \otimes (Y \triangleleft W) \rightarrow (X \otimes Y) \triangleleft (Z \otimes W), \quad \psi_0: I \rightarrow I \triangleleft I, \quad \varphi_2: N \otimes N \rightarrow N, \quad \text{and} \quad \varphi_0: I \rightarrow N,$$

satisfying the following coherence equations (Figures 32 to 36).

*Remark I.2.* In other words, the duoidal tensor and unit are lax monoidal functors for the first monoidal structure, which means that the laxators must satisfy the following equations.

- 1)  $(\psi_2 \otimes id) \circ \psi_2 \circ (\alpha \triangleleft \alpha) = \alpha \circ (id \otimes \psi_2) \circ \psi_2$ , for the associator;
- 2)  $(\psi_0 \otimes id) \circ \psi_2 \circ (\lambda \triangleleft \lambda) = \lambda$ , for the left unitor; and
- 3)  $(id \otimes \psi_0) \circ \psi_2 \circ (\rho \triangleleft \rho) = \rho$ , for the right unitor;
- 4)  $\alpha \circ (id \otimes \varphi_2) \circ \varphi_2 = (\varphi_2 \otimes id) \circ \varphi_2$ , for the associator;
- 5)  $(\varphi_0 \otimes id) \circ \varphi_2 = \lambda$ , for the left unitor; and
- 6)  $(id \otimes \varphi_0) \circ \varphi_2 = \rho$ , for the right unitor.

**Theorem I.3** (Coherence, [AM10]). *Any two parallel morphisms constructed out of the coherence isomorphisms and laxators of a duoidal category coincide.*

$$\begin{array}{ccc}
((A \triangleleft B) \otimes (C \triangleleft D)) \otimes (E \triangleleft F) & \xrightarrow{\alpha} & (A \triangleleft B) \otimes ((C \triangleleft D) \otimes (E \triangleleft F)) \\
\psi_2 \otimes id \downarrow & & \downarrow id \otimes \psi_2 \\
((A \otimes C) \triangleleft (B \otimes D)) \otimes (E \triangleleft F) & & (A \triangleleft B) \otimes ((C \otimes E) \triangleleft (D \otimes F)) \\
\psi_2 \downarrow & & \downarrow \psi_2 \\
((A \otimes C) \otimes E) \triangleleft ((B \otimes D) \otimes F) & \xrightarrow{\alpha \triangleleft \alpha} & (A \otimes (C \otimes E)) \triangleleft (B \otimes (D \otimes F)) \\
((A \triangleleft B) \triangleleft C) \otimes ((D \triangleleft E) \triangleleft F) & \xrightarrow{\beta \otimes \beta} & (A \triangleleft (B \triangleleft C)) \otimes (D \triangleleft (E \triangleleft F)) \\
\psi_2 \downarrow & & \downarrow \psi_2 \\
((A \triangleleft B) \otimes (D \triangleleft E)) \triangleleft (C \otimes F) & & (A \otimes D) \triangleleft ((B \triangleleft C) \otimes (E \triangleleft F)) \\
\psi_2 \otimes id \downarrow & & \downarrow id \otimes \psi_2 \\
((A \otimes D) \triangleleft (B \otimes E)) \triangleleft (C \otimes F) & \xrightarrow{\beta} & (A \otimes D) \triangleleft ((B \otimes E) \triangleleft (C \otimes F))
\end{array}$$

Fig. 32: Coherence diagrams for associativity of a duoidal category.

$$\begin{array}{ccc}
I \otimes (A \triangleleft B) & \xrightarrow{\psi_0 \otimes id} & (I \triangleleft I) \otimes (A \triangleleft B) & (A \triangleleft B) \otimes I & \xrightarrow{\psi_0 \otimes id} & (A \triangleleft B) \otimes (I \triangleleft I) \\
\lambda \downarrow & & \downarrow \psi_2 & \rho \downarrow & & \downarrow \psi_2 \\
A \triangleleft B & \xleftarrow{\lambda \triangleleft \lambda} & (I \otimes A) \triangleleft (I \otimes B) & A \triangleleft B & \xleftarrow{\rho \triangleleft \rho} & (A \otimes I) \triangleleft (B \otimes I)
\end{array}$$

Fig. 33: Coherence diagrams for  $\otimes$ -unitality of a duoidal category.

$$\begin{array}{ccc}
N \triangleleft (A \otimes B) & \xleftarrow{\varphi_2 \triangleleft id} & (N \otimes N) \triangleleft (A \otimes B) & (A \otimes B) \triangleleft N & \xleftarrow{id \triangleleft \varphi_2} & (A \otimes B) \triangleleft (N \otimes N) \\
\kappa \downarrow & & \downarrow \psi_2 & \nu \downarrow & & \downarrow \psi_2 \\
A \otimes B & \xleftarrow{\kappa \otimes \kappa} & (N \triangleleft A) \otimes (N \triangleleft B) & A \otimes B & \xleftarrow{\nu \otimes \nu} & (A \triangleleft N) \otimes (B \triangleleft N)
\end{array}$$

Fig. 34: Coherence diagrams for  $\triangleleft$ -unitality of a duoidal category.

$$\begin{array}{ccc}
(N \otimes N) \otimes N & \xrightarrow{\alpha} & N \otimes (N \otimes N) & I \triangleleft I & \xleftarrow{\psi_0} & I & \xrightarrow{\psi_0} & I \triangleleft I \\
\varphi_2 \otimes id \downarrow & & \downarrow id \otimes \varphi_2 & \psi_0 \otimes id \downarrow & & & & \downarrow id \otimes \psi_0 \\
N \otimes N & \xrightarrow{\varphi_2} & N & \xleftarrow{\varphi_2} & N \otimes N & (I \triangleleft I) \triangleleft I & \xrightarrow{\beta} & I \triangleleft (I \triangleleft I)
\end{array}$$

Fig. 35: Associativity and coassociativity for  $N$  and  $I$  in a duoidal category.

$$\begin{array}{cccc}
N \otimes I & \xrightarrow{\rho} & N & I \otimes N & \xrightarrow{\lambda} & N & I \triangleleft N & \xrightarrow{id \otimes \varphi_0} & I \triangleleft I & N \triangleleft I & \xrightarrow{id \otimes \varphi_0} & I \triangleleft I \\
id \otimes \varphi_0 \downarrow & \nearrow \varphi_2 & & \varphi_0 \otimes id \downarrow & \nearrow \varphi_2 & & \nu \downarrow & \nearrow \psi_0 & & \kappa \downarrow & \nearrow \psi_0 & \\
N \otimes N & & & N \otimes N & & & I & & & I & & 
\end{array}$$

Fig. 36: Unitality and counitality for  $N$  and  $I$  in a duoidal category.

### 1.1 Normalization of duoidal categories

Garner and López Franco [GF16] introduce a procedure for normalizing a sufficiently well-behaved duoidal category, based in the construction of a new duoidal category of *bimodules*. In this text, we introduce a normalization procedure for an arbitrary produoidal category. For completeness, let us recall first the original procedure [GF16].

Let  $M$  be a bimonoid in the duoidal category  $(\mathbb{V}, \otimes, I, \triangleleft, N)$ , with maps  $e: I \rightarrow M$  and  $m: M \otimes M \rightarrow M$ ; and with maps  $u: M \rightarrow N$  and  $d: M \rightarrow M \triangleleft M$ . Consider now the category of  $M^\otimes$ -bimodules. This category has a monoidal structure lifted from  $(\mathbb{V}, \triangleleft, N)$ :

- 1) the unit,  $N$ , has a bimodule structure with

$$M \otimes N \otimes M \xrightarrow{u \otimes \text{id} \otimes u} N \otimes N \otimes N \rightarrow N;$$

- 2) the sequencing of two  $M^\otimes$ -bimodules is a  $M^\otimes$ -bimodule with

$$\begin{aligned} M \otimes (A \triangleleft B) \otimes M & \\ \rightarrow (M \triangleleft M) \otimes (A \triangleleft B) \otimes (M \triangleleft M) & \\ \rightarrow (M \otimes A \otimes M) \triangleleft (M \otimes B \otimes M) \rightarrow A \triangleleft B. & \end{aligned}$$

Moreover, whenever  $\mathbb{V}$  admits reflexive coequalizers preserved by  $(\otimes)$ , the category of  $M^\otimes$ -bimodules is monoidal with the tensor of bimodules: the coequalizer

$$A \otimes M \otimes B \rightrightarrows A \otimes B \rightrightarrows A \otimes_M B.$$

In this case  $(\mathbf{Bimod}_M^\otimes, \otimes_M, M, \triangleleft, N)$  is a duoidal category.

**Theorem I.4** (Normalization of a duoidal category). *Let  $(\mathbb{V}, \otimes, I, \triangleleft, N)$  be a duoidal category with reflexive coequalizers preserved by  $(\otimes)$ . The category of  $N$ -bimodules is then a normal duoidal category,*

$$\mathcal{N}(\mathbb{V}) = (\mathbf{Bimod}_N^\otimes, \otimes_N, N, \triangleleft, N).$$

We call this category the normalization [GF16] of the duoidal category  $\mathbb{V}$ .

### 1.2 Produoidal Categories

**Definition I.5** (Produoidal category, from Definition 4.2). A *produoidal category* is a category  $\mathbb{V}$  endowed with two promonoidal structures,

$$\begin{aligned} \mathbb{V}(\bullet; \bullet \otimes \bullet): \mathbb{V} \times \mathbb{V} \bullet \multimap \mathbb{V}, \text{ and } \mathbb{V}(\bullet; I): 1 \bullet \multimap \mathbb{V}, \\ \mathbb{V}(\bullet; \bullet \triangleleft \bullet): \mathbb{V} \times \mathbb{V} \bullet \multimap \mathbb{V}, \text{ and } \mathbb{V}(\bullet; N): 1 \bullet \multimap \mathbb{V}, \end{aligned}$$

such that one laxly distributes over the other. This is to say that it is endowed with the following natural laxators,

$$\begin{aligned} \psi_2: \mathbb{V}(\bullet; (X \triangleleft Y) \otimes (Z \triangleleft W)) &\rightarrow \mathbb{V}(\bullet; (X \otimes Z) \triangleleft (Y \otimes W)), \\ \psi_0: \mathbb{V}(\bullet; I) &\rightarrow \mathbb{V}(\bullet; I \triangleleft I), \\ \varphi_2: \mathbb{V}(\bullet; N \otimes N) &\rightarrow \mathbb{V}(\bullet; N), \\ \varphi_0: \mathbb{V}(\bullet; I) &\rightarrow \mathbb{V}(\bullet; N). \end{aligned}$$

Laxators, together with unitors and associators must satisfy the coherence conditions in the following diagrams (Figures 37 to 41).

$$\begin{array}{ccc}
\mathbb{V}(\bullet, ((A \triangleleft B) \otimes (C \triangleleft D)) \otimes (E \triangleleft F)) & \xrightarrow{\alpha} & \mathbb{V}(\bullet, (A \triangleleft B) \otimes ((C \triangleleft D) \otimes (E \triangleleft F))) \\
\psi_2 \otimes id \downarrow & & \downarrow id \otimes \psi_2 \\
\mathbb{V}(\bullet, ((A \otimes C) \triangleleft (B \otimes D)) \otimes (E \triangleleft F)) & & \mathbb{V}(\bullet, (A \triangleleft B) \otimes ((C \otimes E) \triangleleft (D \otimes F))) \\
\psi_2 \downarrow & & \downarrow \psi_2 \\
\mathbb{V}(\bullet, ((A \otimes C) \otimes E) \triangleleft ((B \otimes D) \otimes F)) & \xrightarrow{\alpha \triangleleft \alpha} & \mathbb{V}(\bullet, (A \otimes (C \otimes E)) \triangleleft (B \otimes (D \otimes F))) \\
\mathbb{V}(\bullet, ((A \triangleleft B) \triangleleft C) \otimes ((D \triangleleft E) \triangleleft F)) & \xrightarrow{\beta \otimes \beta} & \mathbb{V}(\bullet, (A \triangleleft (B \triangleleft C)) \otimes (D \triangleleft (E \triangleleft F))) \\
\psi_2 \downarrow & & \downarrow \psi_2 \\
\mathbb{V}(\bullet, ((A \triangleleft B) \otimes (D \triangleleft E)) \triangleleft (C \otimes F)) & & \mathbb{V}(\bullet, (A \otimes D) \triangleleft ((B \triangleleft C) \otimes (E \triangleleft F))) \\
\psi_2 \otimes id \downarrow & & \downarrow id \otimes \psi_2 \\
\mathbb{V}(\bullet, ((A \otimes D) \triangleleft (B \otimes E)) \triangleleft (C \otimes F)) & \xrightarrow{\beta} & \mathbb{V}(\bullet, (A \otimes D) \triangleleft ((B \otimes E) \triangleleft (C \otimes F)))
\end{array}$$

Fig. 37: Coherence diagrams for associativity of a produoidal category.

$$\begin{array}{ccc}
\mathbb{V}(\bullet, I \otimes (A \triangleleft B)) & \xrightarrow{\psi_0 \otimes id} & \mathbb{V}(\bullet, (I \triangleleft I) \otimes (A \triangleleft B)) & \mathbb{V}(\bullet, (A \triangleleft B) \otimes I) & \xrightarrow{\psi_0 \otimes id} & \mathbb{V}(\bullet, (A \triangleleft B) \otimes (I \triangleleft I)) \\
\lambda \downarrow & & \downarrow \psi_2 & \rho \downarrow & & \downarrow \psi_2 \\
\mathbb{V}(\bullet, A \triangleleft B) & \xleftarrow{\lambda \triangleleft \lambda} & \mathbb{V}(\bullet, (I \otimes A) \triangleleft (I \otimes B)) & \mathbb{V}(\bullet, A \triangleleft B) & \xleftarrow{\rho \triangleleft \rho} & \mathbb{V}(\bullet, (A \otimes I) \triangleleft (B \otimes I))
\end{array}$$

Fig. 38: Coherence diagrams for  $\otimes$ -unitality of a produoidal category.

$$\begin{array}{ccc}
\mathbb{V}(\bullet, N \triangleleft (A \otimes B)) & \xleftarrow{\varphi_2 \triangleleft id} & \mathbb{V}(\bullet, (N \otimes N) \triangleleft (A \otimes B)) \\
\kappa \downarrow & & \downarrow \psi_2 \\
\mathbb{V}(\bullet, A \otimes B) & \xleftarrow{\kappa \otimes \kappa} & \mathbb{V}(\bullet, (N \triangleleft A) \otimes (N \triangleleft B)) \\
\mathbb{V}(\bullet, (A \otimes B) \triangleleft N) & \xleftarrow{id \triangleleft \varphi_2} & \mathbb{V}(\bullet, (A \otimes B) \triangleleft (N \otimes N)) \\
\nu \downarrow & & \downarrow \psi_2 \\
\mathbb{V}(\bullet, A \otimes B) & \xleftarrow{\nu \otimes \nu} & \mathbb{V}(\bullet, (A \triangleleft N) \otimes (B \triangleleft N))
\end{array}$$

Fig. 39: Coherence diagrams for  $\triangleleft$ -unitality of a produoidal category.

$$\begin{array}{ccc}
\mathbb{V}(\bullet, (N \otimes N) \otimes N) & \xrightarrow{\alpha} & \mathbb{V}(\bullet, N \otimes (N \otimes N)) \\
\varphi_2 \otimes id \downarrow & & \downarrow id \otimes \varphi_2 \\
\mathbb{V}(\bullet, N \otimes N) & \xrightarrow{\varphi_2} & \mathbb{V}(\bullet, N) & \xleftarrow{\varphi_2} & \mathbb{V}(\bullet, N \otimes N) \\
\mathbb{V}(\bullet, I \triangleleft I) & \xleftarrow{\psi_0} & \mathbb{V}(\bullet, I) & \xrightarrow{\psi_0} & \mathbb{V}(\bullet, I \triangleleft I) \\
\psi_0 \otimes id \downarrow & & \downarrow id \otimes \psi_0 \\
\mathbb{V}(\bullet, (I \triangleleft I) \triangleleft I) & \xrightarrow{\beta} & \mathbb{V}(\bullet, I \triangleleft (I \triangleleft I))
\end{array}$$

Fig. 40: Associativity and coassociativity for  $N$  and  $I$  in a produoidal category.

$$\begin{array}{ccccc}
\mathbb{V}(\bullet, N \otimes I) & \xrightarrow{\rho} & \mathbb{V}(\bullet, N) & \mathbb{V}(\bullet, I \otimes N) & \xrightarrow{\lambda} & \mathbb{V}(\bullet, N) & \mathbb{V}(\bullet, I \triangleleft N) & \xrightarrow{id \otimes \varphi_0} & \mathbb{V}(\bullet, I \triangleleft I) \\
id \otimes \varphi_0 \downarrow & \nearrow \varphi_2 & & \varphi_0 \otimes id \downarrow & \nearrow \varphi_2 & & \nu \downarrow & \nearrow \psi_0 & \\
\mathbb{V}(\bullet, N \otimes N) & & & \mathbb{V}(\bullet, N \otimes N) & & & \mathbb{V}(\bullet, I) & & \\
\mathbb{V}(\bullet, N \triangleleft I) & \xrightarrow{id \otimes \varphi_0} & \mathbb{V}(\bullet, I \triangleleft I) & & & & & & \\
\kappa \downarrow & \nearrow \psi_0 & & & & & & & \\
\mathbb{V}(\bullet, I) & & & & & & & &
\end{array}$$

Fig. 41: Unitality and counitality for  $N$  and  $I$  in a produoidal category.

### 1.3 Produoidal induce duoidal

**Theorem I.6.** *Let  $\mathbb{V}$  be a produoidal category, then its category of presheaves,  $[\mathbb{V}^{\text{op}}, \mathbf{Set}]$ , is duoidal with the structure given by convolution [BS13].*

*Proof.* Let  $P$  and  $Q$  be presheaves in  $\mathbb{V}$ . We define the following tensor products on presheaves by convolution of the tensor products in  $\mathbb{V}$ .

$$(P \otimes Q)(A) = \int^{U,V} \text{hom}(A, U \otimes V) \times P(U) \times Q(V),$$

$$(P \triangleleft Q)(A) = \int^{U,V} \text{hom}(A, U \triangleleft V) \times P(U) \times Q(V).$$

These tensor products can be shown in a straightforward way to form a duoidal category, inheriting the laxators from those of  $\mathbb{V}$ .  $\square$

## APPENDIX J

### TAMBARA MODULES

**Definition J.1** (Tambara module, [PS07]). Let  $(\mathbb{A}, \otimes, I)$  be a strict monoidal category. A *Tambara module* is a profunctor  $T: \mathbb{A}^{\text{op}} \times \mathbb{A} \rightarrow \mathbf{Set}$  endowed with natural transformations

$$t_l^M: T(X; Y) \rightarrow T(M \otimes X, M \otimes Y),$$

$$t_r^M: T(X; Y) \rightarrow T(X \otimes M, Y \otimes M),$$

that are natural in both  $X$  and  $Y$ , but also dinatural on  $M$ . These must moreover satisfy the following axioms:

- $t_l^I = id$  and  $t_r^I = id$ , unitality;
- $t_l^M \circ t_l^N = t_l^{N \otimes M}$  and  $t_r^M \circ t_r^N = t_r^{M \otimes N}$ , multiplicativity;
- $t_l^M \circ t_r^N = t_r^N \circ t_l^M$ , and compatibility.

Tambara modules are the algebras of a monad. We start by noting that the hom profunctor is a monoid with respect to Day convolution. This makes the following functor a monad on endoprofunctors, the so-called Pasto-Street monad [PS07],

$$\Phi(P) = \text{hom} \otimes P \otimes \text{hom};$$

where  $\Phi: [\mathbb{C}^{\text{op}} \times \mathbb{C}, \mathbf{Set}] \rightarrow [\mathbb{C}^{\text{op}} \times \mathbb{C}, \mathbf{Set}]$ .

**Theorem J.2.** *The algebras of the Pasto-Street monad, the  $\Phi$ -algebras, are precisely Tambara modules [PS07]. As a consequence, the free Tambara module over a profunctor  $H: \mathbb{C}^{\text{op}} \times \mathbb{C} \rightarrow \mathbf{Set}$  is  $\Phi(H)$ .*

*Example J.3.* Consider the profunctor  $\varkappa(A; B): \mathbb{A}^{\text{op}} \times \mathbb{A} \rightarrow \mathbf{Set}$  that produces a hole of types  $A$  and  $B$ . That is, let  $\varkappa(A; B) = \text{hom}(\bullet, A) \times \text{hom}(B, \bullet)$ . The free Tambara module over it is the monoidal context with a hole of type  $A$  and  $B$ ,

$$\Phi(\varkappa_B^A) = \int^{M,N} \text{hom}(\bullet, M \otimes A \otimes N) \times \text{hom}(M \otimes B \otimes N, \bullet).$$

#### J.1 Normalization of profunctors

Let  $(\mathbb{C}, \otimes, I)$  be a monoidal category. The category of endoprofunctors  $\mathbb{C}^{\text{op}} \times \mathbb{C} \rightarrow \mathbf{Set}$  is then duoidal with composition ( $\triangleleft$ ) and Day convolution ( $\otimes$ ).

$$(\mathbb{C}^{\text{op}} \times \mathbb{C}, \mathbf{Set}, \otimes, I, \triangleleft, \text{hom}).$$

Moreover, we can also construct its normalization: the category of endoprofunctors,  $[\mathbb{C}^{\text{op}} \times \mathbb{C}, \mathbf{Set}]$ , has reflexive coequalisers; thus, we are in the conditions of Theorem I.4. The normal duoidal category of  $\text{hom}^{\otimes}$ -bimodules has been traditionally called the category of *Tambara modules*.

$$\mathcal{N}(\mathbb{C}^{\text{op}} \times \mathbb{C}, \mathbf{Set}, \otimes, I, \triangleleft, \text{hom}) = (\mathbf{Tamb}, \otimes_{\text{hom}}, \text{hom}, \triangleleft, \text{hom}).$$

**Theorem J.4.** *The category of Tambara modules is a normal duoidal category and, in fact, it is the normalization of the duoidal category of endoprofunctors.*

APPENDIX K  
MONOIDAL CATEGORIES

*K.1 Monoidal categories.*

Endowed with the notion of isomorphism, we can now relax our definition of theory of processes by substituting strict equalities by isomorphism.

**Definition K.1.** A {symmetric} monoidal category [Mac78]  $(\mathbb{C}, \otimes, I)$  is a tuple

$$(\mathbb{C}_{\text{obj}}, \mathbb{C}_{\text{mor}}, (\circ), \text{id}, (\otimes)_{\text{obj}}, (\otimes)_{\text{mor}}, I, \alpha, \lambda, \rho, \{\sigma\}),$$

specifying a set of objects, or resource types,  $\mathbb{C}_{\text{obj}}$ ; a set of morphisms, or processes,  $\mathbb{C}_{\text{mor}}$ ; a composition operation; a family of identity morphisms; a tensor operation on objects and morphisms; a unit object and families of associator, left unitor, right unitor {and swapping morphisms}.

The families of associator, left unitor and right unitor morphisms have the following types.

$$\begin{aligned} \alpha_{A,B,C} &: (A \otimes B) \otimes C \rightarrow A \otimes (B \otimes C), \\ \lambda_A &: I \otimes A \rightarrow A, \\ \rho_A &: A \otimes I \rightarrow A. \end{aligned}$$

They must satisfy the following non-strict versions of the axioms.

$$\begin{aligned} A \otimes (B \otimes C) &\cong (A \otimes B) \otimes C, & (1) \\ A \otimes I &\cong A \cong I \otimes A, & (2) \\ (f \circ g) \circ h &= f \circ (g \circ h), & (3) \\ \text{id}_B \circ f &= f = f \circ \text{id}_B, & (4) \\ (f \otimes (g \otimes h)) \circ \alpha &= \alpha \circ ((f \otimes g) \otimes h), & (5) \\ (f \otimes \text{id}_I) \circ \rho &= \rho \circ f, & (6) \\ (f \otimes g) \circ (h \otimes k) &= (f \circ h) \otimes (g \circ k), & (7) \\ \sigma_{A,B \otimes C} \circ \alpha &= \alpha \circ (\sigma_{A,B} \circ \text{id}_C) \circ (\text{id}_B \otimes \sigma_{A,C}), & (8) \\ \sigma_{A,B \otimes C} \circ \alpha &= \alpha \circ (\sigma_{A,B} \circ \text{id}_C) \circ (\text{id}_B \otimes \sigma_{A,C}), & (9) \\ \sigma_{A,A'} \circ (g \otimes f) &= (f \otimes g) \circ \sigma_{B,B'}, & (10) \\ \sigma_{A,B} \circ \sigma_{B,A} &= \text{id}_{A \otimes B}. & (11) \end{aligned}$$

{Additionally}, they must satisfy the following axioms, whenever they are formally well-typed.

$$\alpha \circ \alpha = (\alpha \otimes \text{id}) \circ \alpha \circ (\text{id} \otimes \alpha), \quad (12)$$

$$\rho = \alpha \circ (\text{id} \otimes \lambda), \quad (13)$$

$$\alpha \circ \sigma \circ \alpha = (\sigma \otimes \text{id}) \circ \alpha \circ (\text{id} \otimes \sigma). \quad (14)$$

String diagrams [JS91] are a sound and complete syntax for monoidal categories.

**Construction K.2.** Let  $\mathbb{C}$  be a monoidal category. Its strictification,  $\mathbf{Strict}(\mathbb{C})$ , is a monoidal category where

- *objects are cliques:* for each list of objects of  $\mathbb{C}$ , say,  $[A_0, \dots, A_n] \in \mathbf{List}(\mathbb{C})$ , we form the clique containing all possible parenthesizations and coherence isomorphisms between them;
- *morphisms are clique morphisms:* a morphism between any two components of the clique, which determines a morphism between all of them.

The tensor product is concatenation, which makes it a strict monoidal category.

*Remark K.3.* There is a strong monoidal functor  $\mathbb{C} \rightarrow \mathbf{Strict}(\mathbb{C})$ , this makes an object  $A$  into an object  $[A]$ ; this is fully-faithful but, moreover, it is essentially surjective, giving a monoidal equivalence.

**Theorem K.4.** Every monoidal category is monoidally equivalent to its strictification.